

Birla Central Library

PILANI (Rajasthan)

Class No. 546.16

Book No. B70B

Accession No. 37197

**Boron Trifluoride
and Its Derivatives**

Boron Trifluoride and Its Derivatives

Harold Simmons Booth

HURLBUT PROFESSOR OF CHEMISTRY
WESTERN RESERVE UNIVERSITY

and

Donald Ray Martin

ASSISTANT PROFESSOR OF CHEMISTRY
UNIVERSITY OF ILLINOIS

NEW YORK · JOHN WILEY & SONS, INC.
LONDON · CHAPMAN & HALL, LTD. · 1949

COPYRIGHT, 1949
BY
JOHN WILEY AND SONS, INC.

All Rights Reserved

*This book or any part thereof must not
be reproduced in any form without
the written permission of the publisher.*

PRINTED IN THE UNITED STATES OF AMERICA

This monograph is affectionately dedicated to Albert F. O. Germann who, as an inspiring teacher and research director, first interested the senior author in 1915 in the chemistry of fluorides, and who, by his published works, has ever been a source of experimental guidance to both of us.

H. S. B.

D. R. M.

Preface

With the commercial production of boron trifluoride and boron trifluoride-ethyl etherate in 1936 by the Harshaw Chemical Company there began a tremendous upward surge in research on applications of boron trifluoride and its complexes. This 12-year period has shown such a rapid expansion of knowledge in this field that there has developed a real need for an organized presentation of this subject.

This monograph endeavors to present a complete picture to January 1, 1948, of our knowledge of boron trifluoride and its derivatives. It is the hope of the authors that this monograph will greatly facilitate investigations in this field. In compiling the bibliography we met with unusual difficulties inasmuch as articles containing information on boron trifluoride have rarely been indexed whenever the boron trifluoride had been used as a reagent. In order to obtain as complete as possible a bibliography we found it necessary to scan *Chemical Abstracts* page by page from its beginning.

As a further check on patents on boron trifluoride the following companies have kindly given us lists of their patents in this field:

Aluminum Company of America	Phillips Petroleum Company
American Cyanamid Company	The Resinous Products and Chemical Company
Atlantic Refining Company	Shell Development Company
The Dow Chemical Company	Socony-Vacuum Oil Company
E. I. du Pont de Nemours and Company	Standard Oil Company (Indiana)
Eastman Kodak Company	The Standard Oil Company (Ohio)
The Goodyear Tire and Rubber Company	Standard Oil Development Company
The Harshaw Chemical Company	The Texas Company
Hercules Powder Company	Universal Oil Products Company

We gratefully acknowledge their helpfulness in making our bibliography more complete. It is not unlikely despite our efforts to prepare a complete and accurate bibliography that some references

have been overlooked. The authors will consider it a favor if readers will call their attention to omissions and errors which may be then corrected in a subsequent edition.

The authors gratefully acknowledge help from Professor H. P. Lankelma, Western Reserve University, in the chapter on Catalysis; suggestions by Dr. G. C. Finger, Illinois State Geological Survey, on diazonium compounds; suggestions by Dr. Carl Francis Swinehart, The Harshaw Chemical Research Laboratory, on the chapter on "Practical Handling of Boron Trifluoride"; for information on commercial production of boron trifluoride and its complexes from Mr. Arthur Michalske, plant manager of the Elyria plant of The Harshaw Chemical Company, and the assistance of Mr. Harry Flisik, head of the research analytical laboratory, The Harshaw Chemical Company, on the chapter on "Analysis of Boron Trifluoride and Its Derivatives."

Finally we acknowledge the deep debt we owe to The Harshaw Chemical Company, and particularly to Dr. William J. Harshaw, President, for putting at our disposal all their experience and records in this field, and for never-failing encouragement.

H. S. B.
D. R. M.

Contents

CHAPTER	
1	History and Preparation of Boron Trifluoride 1
2	Physical Properties. 16
3	Chemical Properties of Boron Trifluoride 31
4	The Coordinating Power of Boron Trifluoride 39
5	Fluoboric Acids and Their Salts 87
6	Boron Trifluoride and Its Derivatives as Catalysts . . . 166
7	Analysis of Boron Trifluoride and Its Derivatives . . . 228
8	Practical Handling of Boron Trifluoride 249
	References 256
	Author Index 291
	Subject Index 295
	Formula Index 309

1

History and Preparation of Boron Trifluoride

Sir Humphry Davy's discovery of the electrolytic preparation of the alkali and alkaline-earth metals led to a feverish investigation of the properties of these metals. In France, Gay-Lussac and Thénard, not to be outdone by the English, started along the same line and isolated potassium by reduction by iron.

Among the elements not isolated at that time were fluorine and boron. Davy ⁽¹⁹⁶⁾ electrolytically isolated a dark-colored combustible matter from boric acid and published this information in January 1808. Later in that year ⁽¹⁹⁷⁾ he found that the same product was obtained along with potassium borate by heating boric oxide with potassium. This he decided was the element boron. Gay-Lussac and Thénard tried this reaction slightly later than Davy.

In the Bakerian lecture given December 15, 1808, Sir Humphry Davy reported ⁽¹⁹⁸⁾ the action of potassium on "fluoric" acid but concluded that the violence of the reaction was due to the presence of water. "I endeavored to decompose fluoric acid gas in a perfectly dry state and which contained no siliceous earth; and for this purpose I made a mixture of 100 grains of dry boracic acid, and 200 grains of fluorspar and placed them in the bottom of an iron tube, having a stopcock and a tube of safety attached to it."

"The tube was inserted horizontally in a forge, and 20 grains of potassium, in a proper iron tray, introduced into that part of it where the heat was only suffered to rise to dull redness. The bottom of the tube was heated to whiteness, and the *acid* acted upon by the heated potassium, as it was generated. After the process was finished, the result in the tray was examined." . . . "It was in some parts black and in others of a dark brown." . . . "When burnt in oxygen gas," it "afforded boracic, and fluoric acid." . . . "I have not as yet examined any of the other properties of

this substance; but I am inclined to consider it as a compound of the olive colored oxide of boracium, and an oxide of the fluoric basis." . . . "On examining the dry fluoric acid gas procured in a process similar to that which has been just described, it gave very evident marks of the presence of boracic acid." Davy recognized the gas from the reaction of "boracic" acid and fluorspar as a new gas containing boron and fluorine.

Gay-Lussac and Thénard^(292, 293, 887) turned from the reduction of boric acid by potassium to "try the same method of decomposing the fluoric and muriatic acids, the constituent principles of which were not yet known." They heated "fluates" of lime and glacial "boracic" acid in a red-hot iron tube and found that the vapors leaving the tube fumed in air, as they said, "like muriatic acid gas." The solution of this gas in water, much to their surprise, although strongly acid, did not etch glass, and this led them to discover that it "held in solution a pretty large quantity of boracic acid" as "impurity." They therefore tried to prepare pure "fluoric" acid by other means. They confused this gas (boron trifluoride) with hydrogen fluoride and apparently were unaware that they had prepared a new gas containing boron and fluorine.

From the original literature it is difficult to establish whether Davy or Gay-Lussac and Thénard first made boron trifluoride, but there seems to be little question but that Davy first analyzed it and identified boron and fluorine. However, in a report to the Royal Society of London, July 8, 1813,⁽¹⁹⁵⁾ Humphry Davy speaks of the "fluoboric acid gas discovered by Gay-Lussac and Thénard." In spite of this acknowledgment, their actual dated laboratory notebooks not being available, the literature would seem to indicate Davy's precedence over Gay-Lussac and Thénard.

In 1811 Gay-Lussac and Thénard published their famous *Recherches physicochimiques*,⁽²⁹³⁾ describing in Volume II, page 38, the preparation of fluoboric acid gas by heating fluorspar and fused boric acid to dull red heat. They describe many of its properties with surprising accuracy.

Deville and Caron⁽²⁰⁹⁾ found that, in place of fluorspar in the mixture of fluorspar and boric oxides, other metal fluorides such as aluminum fluoride, beryllium fluoride, ferric fluoride, zirconium fluoride, uranyl fluoride, titanium tetrafluoride, and stannic fluoride would react with boric oxide at elevated temperatures to

yield boron trifluoride. Recently (1939) E. L. Baldeschwieler⁽²⁸⁾ patented the heating of a mixture of boric oxide and fluorspar having a ratio of $B_2O_3:CaF_2$ between the approximate limits of 0.8 to 3.0, to about 900–1200° to evolve boron trifluoride. He found that a yield of 68% of the theoretical boron trifluoride,

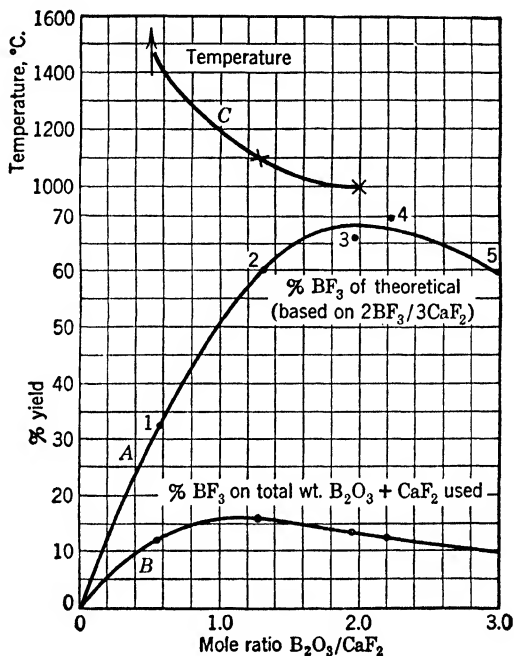
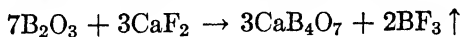

FIG. 1-1. Showing lowering of the reaction temperature and increase in yield of boron trifluoride by use of mole ratio of $3B_2O_3$ to one CaF_2 (Courtesy E. L. Baldeschwieler and Standard Oil Development Co.)

based on $2BF_3/3CaF_2$, was obtained when 3 moles of B_2O_3 were used to 1 mole of CaF_2 at 1000°C., whereas, when the amounts given by Gay-Lussac ($0.57B_2O_3$ to $1CaF_2$) were used, a temperature of at least 1100°C. was needed, and a maximum yield of only 16% boron trifluoride was obtained (see Figure 1-1).

Glenn H. McIntyre⁽⁵⁶⁶⁾ showed that the reaction of fluorspar and boric oxide goes according to the equation,



Although borax and calcium fluoride give off no gas, borax, silica,

4 HISTORY AND PREPARATION OF BORON TRIFLUORIDE

and calcium fluoride yield a mixture of boron trifluoride and silicon tetrafluoride. However, Jannasch and Weber⁽⁴³⁹⁾ many years before claimed that there was no loss of silica when a silicate containing fluorine was fused with boric oxide over an oxygen blast lamp, but the whole of the fluorine was expelled as boron trifluoride and none as silicon tetrafluoride. They used the procedure in mineral analysis.

John Davy,⁽¹⁹⁹⁾ brother of Sir Humphry, in a report on "fluoboric acid gas" states, "MM. Gay-Lussac and Thénard, who first discovered this gas, obtained it by heating strongly in an iron tube a mixture of fluor spar and fused boracic acid." . . . "I have found that it may be more easily procured, in greater abundance, and at less expense, by gently heating, in a common glass retort, a mixture of finely pounded boracic acid" (1 part) "and fluor spar" (2 parts) "with (12 parts of) sulphuric acid." During the later part of the generation, more heat must be applied, but the generation should be stopped when "a viscid fluid, which is a compound of sulphuric acid and fluoroboracic acid gas" distils over to prevent generation of silicon tetrafluoride. Desfosses⁽²⁰⁷⁾ improved Davy's procedure by replacing the boric acid with boric oxide.

Rumold and others since Davy's time^(761, 92, 299, 726, 282) found that the best conditions for using Davy's method are: A shallow layer of boric acid is placed in a flat-bottomed iron dish, which is then heated in a muffle at about 950°C. When the frothing subsides, additional thin layers of boric acid are scattered over the surface until the dish is approximately three fourths full of fused boric oxide. By decanting this slowly into a pan some distance below while the fused boric oxide is being heated by a burner, thin easily powdered ribbons of boric oxide are formed.

Seventy-five grams of the powdered boric oxide is slowly added to 250 g. of hot concentrated sulfuric acid while it is being well stirred. When the boric oxide is completely dissolved, the viscous mass is transferred to a dry flask to stand several days. The flask holding the $B_2O_3-H_2SO_4$ mixture then is inverted in a ring over a large porcelain mortar. A few brushes of the flame over the walls of the flask permit the contents to drain into the mortar. Two hundred grams of powdered precipitated calcium fluoride is added a little at a time and ground into the mixture. Some silicon tetrafluoride will be evolved, and, if the temperature rises too much,

some boron trifluoride will be also. After most of the silicon tetrafluoride has been evolved, the mixture is transferred to a dry generating flask fitted with a conical joint and temporarily fitted with a two-holed rubber stopper bearing a funnel with a long wide stem and a bent tube to the water-suction pump. The slurry of boric oxide, sulfuric acid, and fluorspar is carried into the generator by suction. This also removes much of the rest of the silicon tetrafluoride. The generator is then clamped in place, the heavy asbestos sheet is placed around the neck of the generator flask to protect the conical joint, and the entire apparatus is repeatedly evacuated. Upon warming the generator, boron trifluoride is evolved; it is scrubbed to remove hydrogen fluoride by being passed through a washing bottle containing boric oxide in small amounts dissolved in concentrated sulfuric acid; finally the gas is condensed in ampules⁽⁹⁹⁾ for further purification.

The yields by this method, however, are low, and it is difficult to remove the residue from the flask. It sets up as calcium sulfate to a hard mass and by expansion may destroy the generator. On account of its initial extremely pasty condition, it is difficult to accomplish thorough heat transfer, with the result that there is likely to be overheating at the contact with the glass and a generation of altogether too much silicon tetrafluoride. Moissan^(625, 629) prepared boron trifluoride free from silicon tetrafluoride by heating boric oxide and calcium fluoride, silica-free, with sulfuric acid in a platinum apparatus, and passed the gas through two copper tubes filled with sodium fluoride to remove hydrogen fluoride, and then through two tubes held at -80°C . He removed permanent gases by evacuating the solidified boron trifluoride.

Stolba^(867, 868) and later Ruff⁽⁷³⁹⁾ substituted silica-free cryolite for fluorspar in an attempt to obtain boron trifluoride initially free from silicon tetrafluoride:

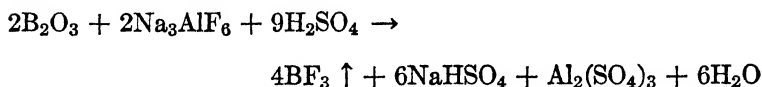

By replacing the sulfuric acid with perchloric acid, Schrenk and Ode⁽⁷⁷⁸⁾ have reported that boric acid, fluorspar, and perchloric acid reacted without an appreciable evolution of silicon tetrafluoride.

In order to avoid dehydrating the boric acid which is not a simple matter industrially, a process has been patented⁽⁴⁰⁷⁾ in

6 HISTORY AND PREPARATION OF BORON TRIFLUORIDE

which fluorosulfonic acid, or fluorosulfonic acid and sulfuric acid ⁽⁹⁶⁴⁾ are heated with boric acid or borates:

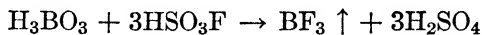

The further step to avoid water has been taken in a patented process ⁽⁴¹⁷⁾ in which sulfur trioxide, boric oxide, and calcium fluoride (or cryolite) are heated under pressure in an autoclave when the following reaction is said to take place:

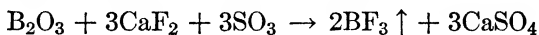

The following example is given: A mixture of 280 parts boric oxide, 1040 parts calcium fluoride, and 1300 parts sulfur trioxide is heated slowly to 250°C. in a rotating autoclave containing iron balls to effect stirring. If the pressure rises to 36 atmospheres, the pressure is released and the reactants are heated again when the pressure may rise to 20 atmospheres. A yield of 530 parts by weight of boron trifluoride has been claimed.

In another attempt ⁽³³⁵⁾ to avoid dehydrating boric acid, equimolecular proportions of boric acid and fluorspar are heated in concentrated sulfuric acid, containing about 20% SO_3 at a temperature of 150–200°C.

The calcium sulfate reaction residue is difficult to remove from the generator, and this problem has been solved in several ways. G. Gore ⁽³¹⁶⁾ found that boric oxide, fused borax, and ammonium borate all reacted with anhydrous hydrogen fluoride to give boron trifluoride.

By holding the temperature to below 10°C., McAlevy ⁽⁵⁶³⁾ claimed to obtain $\text{BF}_3 \cdot 2\text{H}_2\text{O}$, or $\text{BF}_3 \cdot 3\text{H}_2\text{O}$, from the proper proportions of hydrogen fluoride and boric acid, boric anhydride, or a borate. Loder ^(543, 547) claimed to obtain pure boron trifluoride from similar reactants by separating boron trifluoride from the complex by two distillations under at least two different pressures. The first step of the distillation is carried out on the product obtained by the reaction of 1 mole of orthoboric acid and 3 moles of hydrofluoric acid, which contains 3 moles of water per mole of boron trifluoride. This distillation is initiated at subatmospheric pressure, say about 30 to 100 mm. pressure and is carried on under this pressure until approximately 23% of the water is boiled off, leaving a constant-boiling mixture of about 2.3 moles of water per mole of boron trifluoride. The pressure is then increased to atmos-

pheric pressure, and boron trifluoride distils off until the ratio of water to boron trifluoride reaches 2.5. Repetition of the cycle gives the separation desired.

By the addition to the system of a soluble aliphatic acid, the separation is facilitated as shown in Table 1. By warming equal

TABLE 1

LOG OF DISTILLATION SEPARATION OF BF_3 AND H_2O

Mix	Cycle between 30 mm. and 760 mm.	Mole % BF_3 Removed	Mole % HAc Removed	% Acid in Water	Molal Ratio HAc/ H_2O / BF_3
$(\text{HAc})_2 \cdot (\text{H}_2\text{O})_{1.5} \cdot \text{BF}_3$	1	8.5	64.7	93.9	0.71 1.22 1
	2	7.35	7.83	97.8	0.60 1.32 1
	3	5.9	7.62	97.6	0.47 1.42 1
	4	5.9	6.67	98.4	0.34 1.52 1
	5	4.90	98.4	0.23 1.63 1

volumes of dihydroxyfluoboric acid and concentrated sulfuric acid, boron trifluoride is evolved: ^(826, 666)



The formation of an insoluble residue of calcium sulfate ^(467, 771, 866, 885) has also been avoided by heating a mixture of potassium fluoborate with 15 to 20% fused pulverized boric oxide and concentrated sulfuric acid:

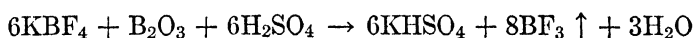

Kraus and Brown ⁽⁴⁶⁴⁾ substituted ammonium fluoborate for the potassium salt.

Booth and Willson ^(64, 99) found the commercially available sodium fluoborate more convenient and proceeded as follows: 300 g. sodium fluoborate was mixed with 50 g. of boric anhydride, and the mixture poured into about 100 ml. of sulfuric acid contained in a liter round-bottom flask equipped with a standard conical joint. After the mixture was homogenized by being shaken thoroughly, the flask was attached to the system by the conical joint, evacuated to about $\frac{1}{4}$ atmosphere, and then warmed. The first gases evolved were pumped off and discarded, thus removing air which could not be pumped off completely without removing boron trifluoride absorbed in the sulfuric acid wash bottle. At first, care must be taken to heat the flask in small areas, rather

than entirely, to prevent frothing. The gases may be conveniently collected by condensation in ampules cooled by means of liquid air following the usual practice in handling gases which react with moisture.^(91, 94)

Fused borax⁽⁸⁶⁾ may be used in place of boric oxide, but a correspondingly greater amount of sulfuric acid is required. It is interesting to note that Étard⁽²⁴⁹⁾ found that among other products boron trifluoride was produced by the action of hydrofluoric acid on barium perborate.

In order to decrease the amount of water which must be removed by sulfuric acid, C. F. Swinehart^(882, 883) carries out the production of boron trifluoride in two steps with the formation in the first step of a compound of the formula $M_2O \cdot 4BF_3$:

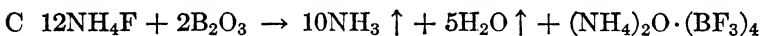
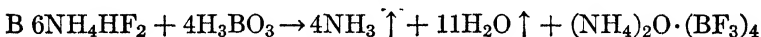
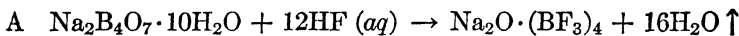

The product of reaction A, "sodium fluoborax" slowly crystallizes from water in rhombic crystals; and from analysis and on other evidence the inventor concludes that the product should be represented by the following structural formula:

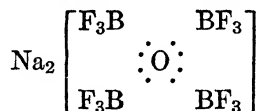

One mole of the dry product from reaction A, B, or C is reacted with 3 moles of sulfuric acid yielding 4 moles of boron trifluoride,



whereas, in the reaction of borax, calcium fluoride, and sulfuric acid, 25 moles of sulfuric acid are actually required to produce 4 moles of boron trifluoride. This process is now in operation for the commercial production of boron trifluoride.*

PREPARATION BY DECOMPOSITION OF FLUOBORATES

That fluoborates may be thermally decomposed into fluorides and boron trifluoride was first noted by Berzelius.⁽⁶⁶⁾ Years later

* Boron trifluoride made by this process, compressed in cylinders, can be obtained from The Harshaw Chemical Company, Cleveland 6, Ohio.

Stolba ⁽⁸⁶⁶⁾ thus prepared boron trifluoride by heating potassium fluoborate:



DeBoer and van Liempt ⁽⁸⁶⁾ studied the thermal dissociation of potassium, rubidium, and cesium fluoborates and found there was only slight decomposition of these compounds below their melting points: 530, 590, and 550°C., respectively. By maintaining a vacuum in the generator, boron trifluoride could be prepared successfully from these fluoborates at temperatures approximating 600–700°C. Max Buchner ⁽¹⁴⁰⁾ claimed that for the preparation of boron trifluoride it is advantageous to heat fluoborates at a pressure less than atmospheric pressure and under conditions such that no sintering takes place.

L. Ouvard ⁽⁶⁸⁸⁾ heated potassium hydrogen fluoride, cadmium oxide, and boric oxide together and so prepared cadmium borate and potassium fluoborate which decomposed as soon as formed to yield potassium fluoride and boron trifluoride. Hellriegel ⁽³⁵²⁾ found that potassium fluoborate reacted vigorously with boric oxide at 518°C. to give boron trifluoride. H. S. Booth ⁽⁹⁰⁾ found that fluoborates could be conveniently decomposed to give boron trifluoride by heating them in an inert molten salt. Bryant ⁽¹³⁹⁾ found that a mixture of sodium fluoborate and silica when heated gave off a mixture of boron trifluoride and silicon tetrafluoride, although Jannasch and Weber ⁽⁴³⁹⁾ found no loss of silica when a silicate containing fluorine was fused with boric oxide over an oxygen blast lamp. They stated that the fluorine was expelled as boron trifluoride and none as silicon tetrafluoride.

Loder ⁽⁵⁴³⁾ made use of the thermal decomposition of calcium fluoborate to recover boron trifluoride from a spent catalyst mixture: Calcium fluoride was treated with a water–boron trifluoride complex, the resulting product was heated below 150°C. to remove water, and the residue of calcium fluoborate was then heated to 300–500°C. to liberate the boron trifluoride. Calcium fluoborate ($\text{CaF}_2 \cdot \text{BF}_3$), ^(27b, 971b) made by reaction of boron trifluoride etherate and calcium fluoride, has been used in generation of boron trifluoride by heating to 250°C., for use in slow-neutron counters.

Diazonium fluoborates ^(33, 769, 770) decompose smoothly, yielding the aryl fluoride, nitrogen, and boron trifluoride at relatively low temperatures without side reactions:

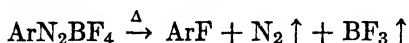

10 HISTORY AND PREPARATION OF BORON TRIFLUORIDE

This reaction has been used as a method of preparing pure boron trifluoride free from silicon tetrafluoride for determining physical constants. (496, 948, 968)

PREPARATION FROM ELEMENTARY BORON

Moissan (628, 629, 631) found that elementary boron took fire in fluorine and formed boron trifluoride, and he prepared it pure for determination of its physical constants in this way. He also found that, when boron was heated with phosphorus trifluoride, phosphorus and boron trifluoride were formed. (627, 633) At red heat, boron (741) ignites in nitrogen trifluoride gas and burns explosively with a bright light:

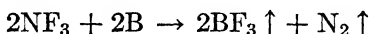

Likewise, the halogen fluorides (742, 745, 746, 747, 748) react with boron (and even with boric oxide), usually inflaming and producing products which probably contain boron trifluoride.

According to Moissan (624) argentous fluoride (AgF) reacts with boron in the cold by simple contact in a mortar with incandescence, giving boron trifluoride and elementary silver. Likewise, he found that zinc fluoride is reduced by amorphous boron at dull-red heat to yield boron trifluoride and zinc. Plumbous fluoride is still more easily reduced by boron at dull-red heat, producing a lively incandescence. If the amount of boron is large, the mixture deflagrates.

Giebelhausen (302) observed that boron reacts with molten cadmium fluoride at 1000–1200°C., forming boron trifluoride and cadmium metal.

PREPARATION FROM BORON HALIDES

The boron halides (623, 632) can be converted into boron trifluoride by the action of fluorine. Silver fluoride reacts with boron trichloride, (626, 740) boron tribromide, (740) and boron triiodide, (628, 740) to give boron trifluoride and the appropriate silver halide. Pohland and Harlos (720) prepared pure boron trifluoride free from silicon tetrafluoride for vapor-pressure studies by reacting boron trichloride in excess with argentous fluoride in a copper tube and separating the excess boron trichloride by distillation.

Booth and Frary (93) found that boron trifluoride was the sole product of the reaction of boron trichloride with sublimed anti-

mony trifluoride in the presence of 5% antimony pentachloride, even at temperatures as low as -80°C . They likewise found that boron trichloride reacted with dry calcium fluoride at $160\text{--}200^{\circ}\text{C}$. to give only boron trifluoride and calcium chloride. Boron trichloride ⁽⁶⁴⁹⁾ reacts vigorously with anhydrous liquid hydrogen fluoride, giving boron trifluoride and hydrogen chloride.

MISCELLANEOUS SYNTHESSES

Sulfuric acid reacts with a mixture of boron nitride and sodium fluoride ⁽⁶²²⁾ to give boron trifluoride:

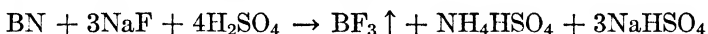

This is essentially solvolysis of boron nitride by anhydrous hydrogen fluoride. Moissan ⁽⁶²³⁾ found that boron nitride is attacked in the cold by gaseous fluorine, giving a pretty, blue incandescence and abundant fumes of boron trifluoride. He also observed that fluorine reacted with the borides of calcium, strontium, barium, and iron ⁽⁶³⁴⁾ to give the metal fluoride and boron trifluoride. Moissan ⁽⁶²³⁾ likewise found that boric oxide reacts with fluorine at ordinary temperatures with a lively incandescence with evolution of boron trifluoride.

In studying reactions initiated by primers, Berger ⁽⁵⁹⁾ claimed that boron trifluoride was readily obtained by igniting the mixture $\text{B}_2\text{O}_3 + 2\text{Al} + 3\text{PbF}_4$:

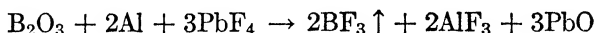

When silicon tetrafluoride is bubbled through molten boric oxide, ⁽⁷⁴³⁾ a part of the silicon tetrafluoride is converted into boron trifluoride. The fumes from smelting vitreous enamels contain boron trifluoride which can be absorbed by powdered slaked lime. ⁽⁵⁶⁷⁾ Baldeschwieler ⁽²⁹⁾ has patented the recovery of boron trifluoride from the gases from the manufacture of borosilicate glasses by absorption in a preferential solvent such as sulfuric acid at 21° to 38°C . and at 25 to 200 psi., followed by heating to free the boron trifluoride.

PURIFICATION OF BORON TRIFLUORIDE

Hydrogen fluoride may be removed by bubbling the gas through small amounts of concentrated sulfuric acid containing dissolved boric oxide. On account of the great solubility of boron trifluoride

12 HISTORY AND PREPARATION OF BORON TRIFLUORIDE

in sulfuric acid, as little as possible of the scrubbing solution should be used, spread over a large surface such as glass beads. Since silicon tetrafluoride has a vapor pressure of 760 mm. at -95°C . and boron trifluoride a vapor pressure of 760 mm. at -100°C ., it is not easy to separate the two by simple ampule-to-ampule distillation.

Berzelius⁽⁶⁶⁾ thought to remove silicon tetrafluoride by scrubbing boron trifluoride for 24 hours with crystallized boric acid without, however, much success. Ruff and coworkers⁽⁷⁴³⁾ found that boron trifluoride made from fluorspar, boric oxide, and concentrated sulfuric acid contained as much as 15% silicon tetrafluoride. They passed the boron trifluoride repeatedly through molten boric oxide maintained at 800°C . in a platinum tube and thus claimed to reduce the silicon tetrafluoride content to 1.7%.

Rumold⁽⁷⁶¹⁾ plotted the density of boron trifluoride against distillations from ampule to ampule and found the density dropped to a constant value after 30 such distillations controverting Ruff's statement that boron trifluoride cannot be purified by fractional distillation. Booth and Willson⁽¹⁰⁰⁾ have found that the separation from silicon tetrafluoride can be greatly accelerated by distillation at low pressures (5–10 cm.) and by boiling rapidly, with a cloth saturated with liquid air tied around the upper part of the ampule which thus continually recondenses a great deal of the boron trifluoride and traps silicon tetrafluoride sprayed into the gaseous space from the bursting bubbles and recondenses it. Booth and Willson^(95,100) showed that in a properly designed fractionating column^(91,94) purification can be accomplished in one distillation.

Boron trifluoride should not be passed through phosphorus pentoxide when the latter contains moisture, since the boron trifluoride is absorbed, forming a rocklike substance.^(817, 566)

Moissan⁽⁶²⁹⁾ avoided the formation of silicon tetrafluoride and the necessity of eliminating it by using silica-free reagents and generating the gas in a platinum apparatus and removing hydrogen fluoride by passing the gas immediately through two copper tubes filled with sodium fluoride and thereafter using absolutely dry glass apparatus.

The presence of silicon tetrafluoride or other inert gases in boron trifluoride may be determined by adding anhydrous hydrogen cyanide gas which forms the molecular compound $\text{BF}_3 \cdot \text{HCN}$

which has no appreciable vapor pressure at -120°C .⁽⁷²⁰⁾ A vapor pressure at this temperature indicates the presence of impurities. The presence of a nonreactive gas in the boron trifluoride may also be established by reaction of the latter with acetyl fluoride forming acetyl fluoborate. The authors claim that as little as 0.2% silicon tetrafluoride can be determined in this way.^(617, 788) For further details see Chapter 7.

The recovery of boron trifluoride from spent catalysts is discussed in Chapter 6.

COMMERCIAL PRODUCTION OF BORON TRIFLUORIDE

Although Butlerow and Gorainow⁽¹⁶⁸⁾ reported early in 1873 that boron trifluoride polymerized propylene and isobutylene at room temperatures, no systematic study of boron trifluoride as a catalyst was undertaken until 1927 when Hoffmann and Otto published the first of a short series of papers on polymerization of olefins.⁽³⁷⁴⁾ In 1930 J. A. Nieuwland and coworkers announced the preparation of acetals, using boron trifluoride and mercuric oxide as catalysts.⁽⁶⁷⁰⁾ This was followed rapidly by numerous articles on the catalysis of other reactions using boron trifluoride and its derivatives. These articles incited great interest in boron trifluoride as a catalyst, but its use was handicapped by the fact that it was not available commercially.

In the late summer of 1932 William J. Harshaw, now president of The Harshaw Chemical Company, believing in a future commercial demand for boron trifluoride, gave instruction that research be started on methods of commercial production of boron trifluoride complexes and boron trifluoride.

It was soon discovered that production of boron trifluoride by the classic method from fluorspar, boric acid, and sulfuric acid⁽¹⁹⁹⁾ gave such a low yield (not over 30%) as to be impractical. Finally, Dr. Carl F. Swinehart developed an efficient and novel process^(882, 883) which both decreases to a practical degree the amount of sulfuric acid needed and gives a high yield of boron trifluoride.

Under the supervision of A. Michalske the unusually difficult problems of large-scale manufacture were solved, and this process was put into production in January 1936 at the Cleveland plant of The Harshaw Chemical Company. In the summer of the same

14 HISTORY AND PREPARATION OF BORON TRIFLUORIDE

year commercial production of boron trifluoride-ethyl etherate began. Rarely is it afforded to three men by their own efforts to give such a tremendous stimulus to research: Following the commercial production of boron trifluoride and its complexes there have appeared up to January 1948 nearly six hundred patents describing its applications and several hundred articles covering its properties.

This process (see page 8) is carried out in two steps: In the first step a complex of the formula $M_2^I O(BF_3)_4$ is formed, which in the second step is treated with sulfuric acid to liberate the boron trifluoride. In the production of boron trifluoride from fluorspar, borax, and sulfuric acid, 25 moles of sulfuric acid are actually required to yield 4 moles of boron trifluoride, whereas in the Swinehart process 3 moles of sulfuric acid liberate 4 moles of boron trifluoride.

In the actual plant operation the complex $M_2^I O \cdot (BF_3)_4$ is made in one of several ways. Where M^I is Na, the calculated amount of borax is slowly added to hydrofluoric acid in amounts according to the equation:

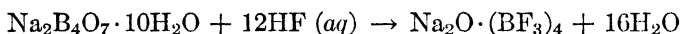

When addition is complete, the temperature is raised to remove the water. When boric acid is used, the boric acid is added to ammonium bifluoride, in amounts according to the equation:

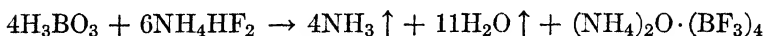

The mixture liquefies at room temperature and then is boiled to dryness in iron equipment; the ammonia gas and water vapor are evolved readily on heating and the white residue of $(NH_4)_2O \cdot (BF_3)_4$ is ready for the second step.

The charge of "fluoborax" made by either of the foregoing procedures is transferred into a large generator, the manhole clamped shut, and the calculated amount of cold fuming sulfuric acid (20% SO_3) added. At room temperature practically no boron trifluoride is evolved. The reaction mass is heated slowly, and the rate of generation of boron trifluoride can be controlled easily by controlling the temperature. The first gas evolved contains air and is vented until a sample is found to be free from air. Spray is removed by passing the gas through cooling towers, and then it is pumped to gasholders from which it flows as needed to the

compressors. From the compressor it is introduced directly into steel cylinders to 2000 psi. pressure.

Complexes, such as boron trifluoride-ethyl etherate, are made by contacting the boron trifluoride gas with organic donor molecules under conditions such that the heat of reaction can be removed as fast as evolved. This requires adequate cooling of the reaction vessel.

2

Physical Properties

Boron trifluoride is a colorless gas which does not support combustion ⁽²⁹³⁾ and which hydrolyzes in ordinary air, producing a copious white smoke. The hydrolytic products have a sharp acidic odor.

Melting Point. Many investigators have reported that solid boron trifluoride melts at -127°C . ^(11, 108, 515, 625, 629) Pohland and Harlos ⁽⁷²⁰⁾ reported that, because of a transition point, boron trifluoride sinters at -130°C . and melts at -128°C . Eucken and Schröder, ⁽²⁵⁰⁾ investigating boron trifluoride, which as the authors said might have contained impurities up to 0.7%, found a melting point of -128.70°C . and a transition temperature of -131.01°C . The writers' experience indicates that the freezing point is close to -127.1°C . ^(95, 98, 100)

Vapor Pressure and Boiling Point. Faraday ^(254, 255, 256) first liquefied boron trifluoride by condensing it to a colorless mobile

TABLE 2

VAPOR PRESSURE OF BORON TRIFLUORIDE ABOVE 1 ATMOSPHERE

$t^{\circ}\text{C}$.	P atm.	Reference
-73.3	4.61	Faraday ⁽²⁵⁶⁾
-63.3	7.5	
-57.8	9.23	
-54.4	10.00	
-52.2	11.54	
-49.25	13.8	Booth and Carter ⁽⁹²⁾
-39.20	20.5	
-29.96	27.9	
-19.95	38.6	
-14.60	45.5	
-12.25	49.0	

liquid under a pressure of 10 atmospheres and at a temperature of -54.4°C ., using carbon dioxide snow as the refrigerant. Booth and Carter ⁽⁹²⁾ determined the vapor pressure of boron trifluoride, purified by repeated ampule-to-ampule distillations, between 10

and 50 atmospheres, and found it to correspond to the equation:

$$\log_{10} P = 5.1009 - \left(\frac{889.6}{T} \right)$$

in which P is the pressure expressed in atmospheres and T is the absolute temperature. (See Table 2.)

TABLE 3

VAPOR PRESSURE OF BORON TRIFLUORIDE BELOW 1 ATMOSPHERE

References		720	496	743	938	
		Pressure in mm.				
$t^{\circ}\text{C.}$						
Solid	-145.4	5.0				
	-144.1	6.2				
	-141.8	9.2				
	-139.2	13.9				
	-134.3	29.0				
	-132.7	36.5				
	-130.9	47.0				
	-129.8	54.7				
	Liquid	-127.3	69.8			
		-125.2	87.2			
-125.0					73.0	
-122.1		119.6				
-120.5		139.9				
-118.7		166.0				
-117.8		180.6				
-117.1		192.6				
-114.0		254.0				
-112.4		291.4				
-111.6			300	309		
-111.5			305	312		
-110.0		355.7				
-109.5			350	372		
-107.5			420	444		
-106.7		462.2				
-106.5			455	484		
-105.3		514.3				
-105.1			515	545		
-105.0			525	550		
-104.0			565	594		
-103.6			585	611		
-102.9	614.5					
-102.0		660	697			
-101.7		675	713			
-100.4		760	791			
-100.3		760	796			

Ruff, Braidà, Bretschneider, Menzel, and Plaut,⁽⁷⁴⁸⁾ and Le Boucher, Fischer, and Biltz,⁽⁴⁹⁶⁾ using some boron trifluoride which admittedly contained traces of impurities, found the vapor pressures shown in Table 3. In the same table may be found the vapor pressures as determined by Pohland and Harlos⁽⁷²⁰⁾ for boron trifluoride which was free from silicon tetrafluoride.

The vapor pressure of boron trifluoride has been expressed in equations by two of these experimenters as follows:

$$\log p (s) = -\frac{1176.6}{T} + 1.75 \log T - 0.0032084T + 6.6293 \quad (720)$$

$$\log p (l) = -\frac{1174.4}{T} + 1.75 \log T - 0.013350T + 8.0536 \quad (720)$$

$$\log p (l) = -\frac{1023.5}{T} + 8.828 \quad (743)$$

in which p is the pressure expressed in millimeters and T is the absolute temperature.

Boiling Point. From the vapor-pressure data given in Table 3 the boiling point (at 760 mm.) of boron trifluoride has been calculated to be -99.9 ,⁽⁷²⁰⁾ -100.4 ,⁽⁴⁹⁶⁾ and -101°C .⁽⁷⁴³⁾ The last value has been reported also by Moissan^(625, 629) and is the value generally quoted in the literature.⁽⁶⁰⁹⁾ A value of -102°C . also has been reported.⁽⁷⁴⁴⁾

Density and Molecular Volume of Solid Boron Trifluoride. The density of solid boron trifluoride at -130°C . has been reported as 1.87 .^(743, 744) At -188°C . the solid density has been found to be 1.98 , corresponding to a molecular volume of 34.3 , whereas at -273°C . these values have been calculated to be 2.04 and 33.3 , respectively.⁽⁴⁹⁶⁾ By using these data, the molar volume of crystallized boron trifluoride at -130°C . has been calculated as 34.7 ⁽⁴⁹⁶⁾ and 35.3 .^(743, 744) A molar volume of 26.8 was calculated by Stephenson⁽⁸⁶¹⁾ from the molar volumes of potassium fluoborate and potassium fluoride. This molecular volume corresponds to a density of 2.56 for the solid.

Density and Molecular Volume of Liquid Boron Trifluoride. The density of liquid boron trifluoride at its boiling point is reported to be 1.60 ,^(743, 744) 1.58 ,⁽⁴⁹⁶⁾ and 1.57 .⁽²⁶⁷⁾ At its melting

point the values have been reported as 1.769⁽⁷⁴³⁾ and 1.68.^(267, 496) The molecular volume of the liquid at its freezing point has been reported to be 38.3⁽⁷⁴³⁾ and 39.7.⁽⁴⁹⁶⁾ In both cases it was suspected that the liquid contained traces of impurities.

Several investigators have derived an equation to express the density of boron trifluoride at any given temperature within the range of the liquid state. Ruff and coworkers⁽⁷⁴³⁾ have expressed the density in terms of absolute temperature T , thus:

$$d = 2.6999 - 0.00642T$$

Wiberg and Mäthing⁽⁹⁴⁸⁾ have derived the following expression which is good for temperatures between -124.3° and -102.4°C . ($t = ^\circ\text{C}$):

$$d = 1.699 - 0.00445(t + 125)$$

A closely similar equation, suggested by Fischer and Weidemann,⁽²⁶⁷⁾ reads

$$d = 1.68[1 - 0.0023(t + 128)]$$

more simply expressed as

$$d = 1.68 - 0.003864(t + 128)$$

Coefficient of Thermal Expansion. LeBoucher, Fischer, and Biltz⁽⁴⁹⁶⁾ from the density of solid boron trifluoride have estimated its coefficient of thermal expansion to be $3.5 \cdot 10^{-4}$. The coefficient of thermal expansion for liquid boron trifluoride has been calculated from liquid density measurements to be $21 \cdot 10^{-4}$,⁽⁴⁹⁶⁾ $23 \cdot 10^{-4}$,⁽²⁶⁷⁾ and $34 \cdot 10^{-4}$.⁽⁷⁴³⁾

Surface Tension and Parachor. Wiberg and Mäthing⁽⁹⁴⁸⁾ reported the surface tension of boron trifluoride to be best expressed by the equation:

$$\gamma = 20.92 - 0.22(t + 117.0)$$

for the temperature range of -116.4 to -92.6°C . The parachor of boron trifluoride, calculated from the afore-mentioned surface-tension data has a value of 87.3. Using this value, Laubengayer, Ferguson, and Newkirk⁽⁴⁹³⁾ calculated the atomic parachor of boron to be 8.1.

Density of Gaseous Boron Trifluoride. The discovery of boron trifluoride was followed immediately by reports of the determination of its gas density by John Davy, Thomson, Dumas, and Berzelius, as shown in Table 4. Included in Table 4 is the ac-

TABLE 4
GAS DENSITY OF BORON TRIFLUORIDE

Date of Determination	Investigator	D_{air}	L_N , g./l.	V_{mole} , ml.
	Theoretical		3.026	22,412
1812	Davy ⁽¹⁸⁹⁾	2.3709	3.0651	22,127
1813	Thomson ⁽⁸⁹³⁾	2.3694	3.0632	22,140
1826	Dumas ^(217, 218)	2.3124	2.9895	22,686
1843	Berzelius ⁽⁶⁷⁾	2.3153	2.9932	22,658
1931	Rumold ⁽⁷⁶¹⁾		3.07666	22,044
1932	LeBoucher, Fischer, and Biltz ⁽⁴⁹⁶⁾		3.07	22,091
1933	Fischer and Weidemann ⁽²⁶⁷⁾		3.065	22,127

cepted value as determined by Rumold along with more recent determinations. In the column marked D_{air} are given the observed values of the density referred to air = 1. In the column L_N are the values recalculated in terms of $L_{N_{\text{air}}} = 1.2928$ g. The molar volume V was calculated, using L_N and the 1942 molecular weight of boron trifluoride which is 67.82.

Rumold, ⁽⁷⁶¹⁾ using the Guye technic, found that it required 30 ampule-to-ampule distillations to purify boron trifluoride to constant density. Then as a result of 48 separate determinations on boron trifluoride which was prepared from Asia Minor boric oxide, the weight of the normal liter was found to be 3.07666 ± 0.00018 g./l. As a result of 16 determinations, made similarly at $\frac{2}{3}$ atmospheric pressure, its density calculated to atmospheric pressure was found to be 3.05958 ± 0.00080 g./l. Similarly, as the result of 16 determinations at $\frac{1}{3}$ atmospheric pressure, its density calculated to atmospheric pressure was found to be 3.04340 ± 0.00047 g./l. Calculated by the method of least squares, the limiting density becomes 3.02662 ± 0.00069 .

Fischer *et al.* ^(267, 496) made density measurements at 20°C. and at 200 to 760 mm. pressure and at -75°C. and at 405 mm. pressure on boron trifluoride. At 20°C. and at 760 mm. pressure the density of boron trifluoride was found to be 3.065 ± 0.009 g./l.

Rumold ⁽⁷⁶¹⁾ made one measurement of the density of boron trifluoride at -88°C . and 760 mm. and found the density to be 4.613 g./l. When this value is corrected to 0°C ., it becomes 3.1256, compared with the value 3.07666 actually found at 0°C .

The density of gaseous boron trifluoride will vary with the source of the boron compounds used in its preparation. Mass spectra of boron trifluoride show in all specimens a mixture of the isotopes of atomic masses 10 and 11.⁽¹⁷⁾ The atomic weight of boron from Asia Minor minerals is 10.819 ± 0.004 ,⁽¹¹²⁾ whereas that of boron from American minerals is 10.840 ± 0.003 .

Coefficient of Compressibility. Rumold ⁽⁷⁶¹⁾ has calculated, by the method of Guye,⁽³²⁸⁾ the average deviation exhibited by gaseous boron trifluoride from Avogadro's Law between pressures of 1 atmosphere and zero to be:

As a function of p	1.01637
As a function of $1/v$	1.01625
As a grand average, $1 + \lambda$	1.01631

Professor Gregory Paul Baxter (personal communication) has expressed a preference for using the equation,

$$PV = 1 + \lambda + aP + aP^2$$

in calculating the deviation of gases of as high a deviation as shown by boron trifluoride. With this method the data give $1 + \lambda$ a value of 1.01602.

From Rumold's data ⁽⁷⁶¹⁾ the coefficient of compressibility λ for the pressure range from 0 to 1 atmosphere at 0°C . is 0.01631. Other values to be found in the literature are 0.014 ⁽⁴⁵⁷⁾ and 0.0060.⁽⁹³⁹⁾

Critical Constants. As a result of seven determinations, Booth and Carter ⁽⁹²⁾ found the critical temperature of boron trifluoride to be $-12.25 \pm 0.03^{\circ}\text{C}$. and the critical pressure to be 49.2 (I.C.T. normal) ± 0.1 atmospheres.

Booth and Willson ⁽¹⁰¹⁾ studied the critical phenomena of the system argon-boron trifluoride. The system exhibited the usual retrograde condensation and a new phenomenon, best described as retrograde immiscibility, in the low-temperature high-pressure range. The curve showing the maximum temperature of liquefaction and corresponding pressure is given in Figure 2-1.

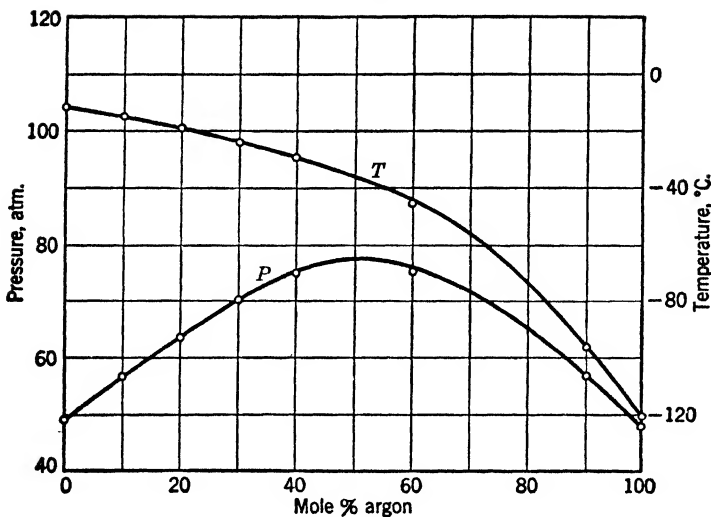

FIG. 2-1. Maximum temperature of liquefaction and corresponding pressures of argon-boron trifluoride mixtures
(Courtesy *Journal of the American Chemical Society*)

Heat of Formation. Berthelot⁽⁶³⁾ determined the heat of formation of boron trifluoride (*g*) to be 234.9 kcal. per mole. Wilsdon⁽⁹⁵⁴⁾ calculated the heat of dissociation of boron trifluoride to be 278 kcal. per mole. Roth and Borger⁽⁷³⁷⁾ gave as the probable heat of formation of boron trifluoride, prepared from the elements in their standard states, a value of 297 kcal. per mole. Von Wartenberg⁽⁹³⁶⁾ recalculated the heat of formation of boron trifluoride from its elements in their standard states, based on his new determinations of the heat of formation of hydrogen fluoride, to be 258.1 kcal. per mole. Bichowsky and Rossini⁽⁷⁶⁾ report the value to be 256.9 kcal. per mole. Bauer, Finlay, and Laubengayer⁽⁶⁰⁾ calculated the heat of formation of boron trifluoride from its gaseous atoms to be between 467 and 507 kcal. per mole. From a determination of the heat of formation of glassy boric oxide, Roth^(736a) calculated the heat of formation of boron trifluoride (*g*) to be 273.5 kcal. per mole.

Heat of Fusion. Eucken and Schröder⁽²⁵⁰⁾ in their determination of the entropy of boron trifluoride found that boron trifluoride undergoes a transition in the solid state at -131.01°C . The heat of transition was difficult to measure, but it is reported by them to

be approximately 18 cal. per mole. These experimenters found the heat of fusion to be 1013.8 cal. per mole at -128.70°C .

Heat of Vaporization. Booth and Carter⁽⁹²⁾ have calculated the heat of vaporization by the approximate Clapeyron equation from vapor-pressure measurements between 10 and 50 atmospheres pressure to be 4.057 kcal. per mole. Ruff and coworkers⁽⁷⁴³⁾ have calculated the value to be 4.680 kcal. per mole from vapor-pressure data obtained below atmospheric pressure. Eucken and Schröder⁽²⁵⁰⁾ reported a value of 4.440 kcal. per mole, which they calculated for a boiling point of -118.7°C . when the vapor pressure was 0.2185 atmosphere.

TABLE 5
HEAT CAPACITY OF BORON TRIFLUORIDE

	$T^{\circ}\text{K.}$	C_p cal./deg.-mole		Reference
		Observed	Calculated	
Solid	12	1.28	1.10	250
	15	1.87	1.79	
	20	2.90	2.94	
	25	3.95	4.04	
	30	5.04	5.03	
	35	6.07	6.06	
	40	7.00	6.93	
	45	7.83	7.72	
	50	8.52	8.44	
	55	9.13	9.08	
	60	9.67	9.64	
	70	10.53	10.57	
	80	11.28	11.38	
	90	12.03	12.14	
Liquid	100	12.76	12.87	
	110	13.53	13.62	
	120	14.44	14.42	
	130	15.58	15.49	
	140	16.76	16.68	
	145	24.53		
	150	24.64		
Gas	160	24.84		
	170	25.05		
	173	25.10		
	189	10.05	10.00	609
	189	9.97		
	190	9.96		
	278	11.60		
278	11.72	11.70		
278	11.78			
278	11.78			

Heat Capacity. Eucken and Schröder ⁽²⁵⁰⁾ have determined the heat capacity of boron trifluoride at constant pressure in the solid and liquid states, and Millar ⁽⁶⁰⁹⁾ has obtained the values for the gaseous state. Their data are given in Table 5.

Entropy. Eucken and Schröder ⁽²⁵⁰⁾ calculated the entropy of boron trifluoride at 1 atmosphere and at 298.2°K. from thermal and spectroscopic data. The results expressed in calories per degree-mole are 61.17 and 61.11, respectively. There is no evidence for zero-point entropy.

Molecular Structure. The boron trifluoride molecule is planar ^(108, 312, 506, 744) with the boron atom in the center of an equilateral triangle and the fluorine atoms at the apices. Raman- ^(11, 26, 963) and infrared- ^(27, 279) spectral data are consistent with the planar configuration.

The B-F distance has been reported by Levy and Brockway ⁽⁵⁰⁶⁾ and Laubengayer, Ferguson, and Newkirk ⁽⁴⁹³⁾ from electron-diffraction measurements to be 1.30 Å. Similarly, Braune and Pinnow ⁽¹⁰⁸⁾ have established the distance as 1.31 Å. From a study of the infrared-absorption spectrum, Gage and Barker ⁽²⁷⁹⁾ have found the B-F distance to be 1.29 Å. Bailey, Hale, and Thompson ⁽²⁷⁾ from Raman-spectral data, calculated the B-F distance to be 1.33 Å. The F-F distance, as established by electron-diffraction work, has been found to be 2.25 Å. with the F-B-F angle being 120° (to within 3°). ⁽⁵⁰⁶⁾

Bailey, Hale, and Thompson ⁽²⁷⁾ from Raman-spectral data have calculated the single-bond radius of the monovalent boron atom to be 0.69 Å. From electron-diffraction studies of boron compounds, including the halides, the single-bond radius of the boron atom when associated with 6 electrons, which are occupying the hybridized sp^2 orbitals, is 0.79 Å. When the boron atom of a boron compound becomes an acceptor as in the formation of coordination compounds, the single-bond radius of the boron atom thus associated with 8 electrons in the sp^3 orbitals becomes 0.89 Å. ⁽⁵⁰⁶⁾ This value for the tetrahedral radius also satisfactorily explains bond distances and molecular configurations for BCl_3 and BBr_3 .

The probable structure of a boron trihalide molecule would involve resonance among the three possible structures of the type,

tion of boron trifluoride molecules in the liquid state at the temperatures and pressures employed.

Refractive Index and Dispersion. Watson and Ramaswamy⁽⁹³⁹⁾ have determined the refractive indices, $(n - 1) \cdot 10^6$, of boron trifluoride at 25°C. and 760 mm. pressure and have corrected their values for deviations of the gas from the perfect-gas law as shown in Table 6.

TABLE 6

REFRACTIVE INDEX OF BORON TRIFLUORIDE

Wave length λ in Å.	6440.24	5462.25	5087.23	4801.25	4359.56
$(n - 1) \cdot 10^6$ (25°C., 760 mm.)	377.10	378.72	379.59	380.36	381.90

Recalculated to 0°C. for a wave length of 5462 Å., Watson and Ramaswamy's value becomes 413.4, compared to 407.9 obtained by Klemm and Henkel.⁽⁴⁵⁷⁾

From the foregoing data, Watson and Ramaswamy have calculated the electronic polarization P_E to be 6.09 and the atomic polarization P_A to be 2.81. Klemm and Henkel⁽⁴⁵⁷⁾ found the molecular refraction (equivalent to the electronic polarization) to be 6.00 for a wave length of light of 5876 Å. The dispersion for $(n_{546.1} - n_{587.6}) \cdot 10^6$ was found to be 0.7.⁽⁴⁵⁷⁾

Dielectric Constant and Dipole Moment. The dielectric constant was measured between 19.5° and 199.1°C. under pressures of mercury between 136 mm. and 656 mm. by Linke and Rohrmann.⁽⁵¹⁵⁾ Their average value referred to 0°C. and 760 mm. is 1.119 esu., and the resulting polarization is 8.36. Watson, Kane, and Ramaswamy, using boron trifluoride of questionable purity, determined the dielectric constant at 25° and -80°C. and on reduction to 25°C. and 760 mm. pressure obtained an average value of 1.092 which may be high. From their data the polarization is calculated to be 8.90.⁽⁹³⁸⁾ Boron trifluoride is electrically neutral and has no dipole moment.^(515, 938)

Infrared-Absorption Spectra. The infrared-absorption spectra of boron trifluoride have been studied under high resolution from 400 cm.^{-1} to 3000 cm.^{-1} . The active fundamental frequencies ν_2 , ν_3 , and ν_4 for B^{10}F_3 and B^{11}F_3 are listed in Table 7.

TABLE 7

INFRARED-ABSORPTION SPECTRA DATA
 Fundamental Frequencies Expressed as cm.^{-1}

ν_1	B^{10}F_3	888				
	B^{11}F_3	888	888 <i>R</i>	886 <i>R</i>	886; 783	886 <i>R</i>
ν_2	B^{10}F_3	719.8	722			722
	B^{11}F_3	691.5	694	722		694
ν_3	B^{10}F_3	1497	1501	1501		1503
	B^{11}F_3	1446	1448	1448	1038; 1105	1448
ν_4	B^{10}F_3	482.1				441 <i>R</i>
	B^{11}F_3	480.5	439-513 <i>R</i>	440 <i>R</i>	440	440
Reference		279	963	26	11	27

R refers to appearance in Raman spectra.

The force constant for B-F expressed as $K \cdot 10^{-6}$ dyne cm.^{-1} has been reported to be 0.669.^(26, 27) The moment of inertia *A* has been determined as $79 \cdot 10^{-40}$ g.-cm.²⁽²⁷⁹⁾

Band Spectrum. In 1932 Tawde and Johnson⁽⁸⁸⁵⁾ reported that the spectrum of boron trifluoride consisted of a number of double-headed doublet bands of wave lengths between 5600 and 3500 Å. Dull⁽²¹⁶⁾ later found band heads of wave lengths of 5993.8 to 5664.0 Å. and 5470.8 to 4443.5 Å. In the ultraviolet he found three bands of wave lengths 3552.2 to 3545.4 Å., 3399.40 to 3392.85 Å., and 3256.61 to 3250.94 Å.

Knauss *et al.*^(692, 876) have found 16 bands in the region between 3712 to 2580 Å. in the ultraviolet.

Linnett⁽⁸²⁰⁾ has studied the relationship of potential energy and interatomic distance for the diatom BF from observed values of the vibration frequency.

Low-Pressure Phenomena. The measurement of the critical potentials for gaseous boron trifluoride at pressures around 1.5 mm. of mercury have given 684.2 volts as the potential of the *K* band of fluorine.⁽⁸⁹¹⁾

In the longitudinal extraction of ions from a low-pressure constricted arc discharge it was found that the lower-pressure limit for a 2.5-cm. arc made up from a current of 150 milliamperes and 70 volts was $2 \cdot 10^{-2}$ mm. of mercury.⁽⁵⁶¹⁾

At pressures ranging from $5 \cdot 10^{-4}$ mm. to $3 \cdot 10^{-3}$ mm. of mercury a study was made of the scattering of slow electrons in boron trifluoride. The electron beam was used at varying voltages. On the basis of the radius of the boron atom being 0.89 Å., the apparent electron affinity of boron trifluoride was calculated to be 6.1 electron volts.⁽⁷⁹³⁾ It was suggested that there might be a correlation between the electron affinity and the bands in the spectrum as observed by Dull⁽²¹⁶⁾ (see band spectra above).

Boron trifluoride counters have been used to measure slow-neutron intensities. The boron trifluoride was under pressures between 2 and 20 cm. of mercury and was mixed with argon under a pressure of 1 cm. of mercury. The counters produced larger pulses over a greater voltage range than were obtained from the usual argon- or air-filled counters.^(463, 789)

Aston⁽¹⁷⁾ used boron trifluoride for a positive-ray analysis and observed that it is doubly charged.

Under a spark from an induction coil, boron trifluoride showed no new properties. The volume remained constant, and the walls of the glass vessel were not attacked.^(62, 630)

Solubility. Only one quantitative study on solubilities of boron trifluoride in solvents without reaction has been reported, and very little qualitative information is available on normal solubilities. At 0°C. 1.19 g. of water absorbs 3.832 g. of boron trifluoride under a pressure of 762 mm.; or, expressed in terms of volume, 1 ml. of water absorbs 1057 ml. of boron trifluoride under a pressure of 762 mm.^(45, 199) The reactions that take place when boron trifluoride is absorbed in water are discussed in the chapters dealing with chemical properties and catalysis.

The heat of solution of boron trifluoride in water has been found to be 24.5 kcal. per mole.⁽⁷⁶⁾ Gay-Lussac and Thénard⁽²⁹³⁾ reported that one fifth of the boron trifluoride in a saturated aqueous solution can be recovered.

One volume of concentrated sulfuric acid of specific gravity of 1.85 absorbs 50 volumes of boron trifluoride according to Davy.⁽¹⁹⁹⁾ The gas also dissolves in large quantities in concentrated nitric acid, which solution on dilution evolves white fumes.⁽⁴⁷⁶⁾

Straight-chain unsaturated aliphatic hydrocarbons are reported to dissolve boron trifluoride. Kerosene, high-boiling naphtha,⁽⁵¹⁰⁾ benzene,⁽⁶⁰⁸⁾ pentane,⁽²⁰⁸⁾ propane and ethane,⁽⁸³⁶⁾ nitrobenzene, carbon disulfide, dichlorobenzene, carbon tetrachloride, chloro-

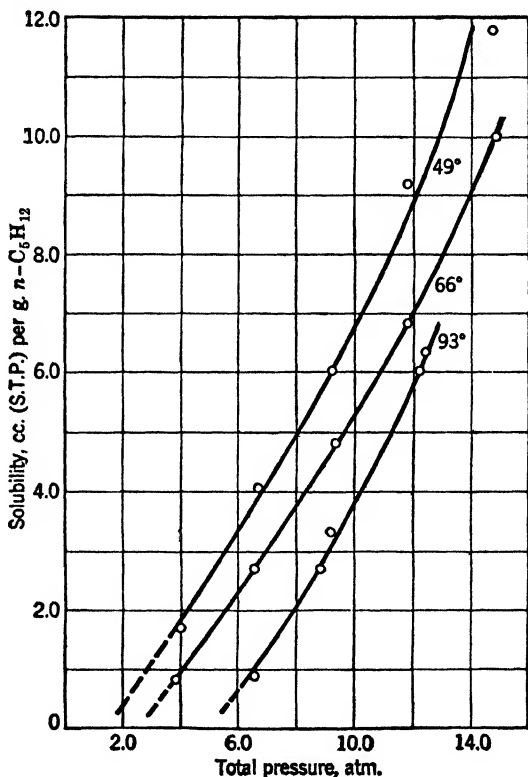

FIG. 2-2. Solubility of boron trifluoride in *n*-pentane at constant temperature (Courtesy Phillips Petroleum Co. and *Journal of the American Chemical Society*)

form,⁽⁵¹⁰⁾ and tetrachloroethane^(212, 510) have been listed as inert solvents used in catalytic processes involving boron trifluoride as the catalyst.

Terebene is said to dissolve boron trifluoride without reaction,⁽⁶¹⁾ whereas turpentine undergoes reaction.

Recently,⁽¹⁶⁹⁾ Cade, Dunn, and Hepp have determined the solubility of boron trifluoride in *n*-pentane at 49, 66, and 93°C.

and at total absolute pressures ranging from 3.8 to 14.8 atmospheres with an accuracy of $\pm 5\%$. Solubilities were found to be of the order of 1 to 12 cc. (S.T.P.) of boron trifluoride per gram of normal pentane, as shown in Figures 2-2 and 2-3.

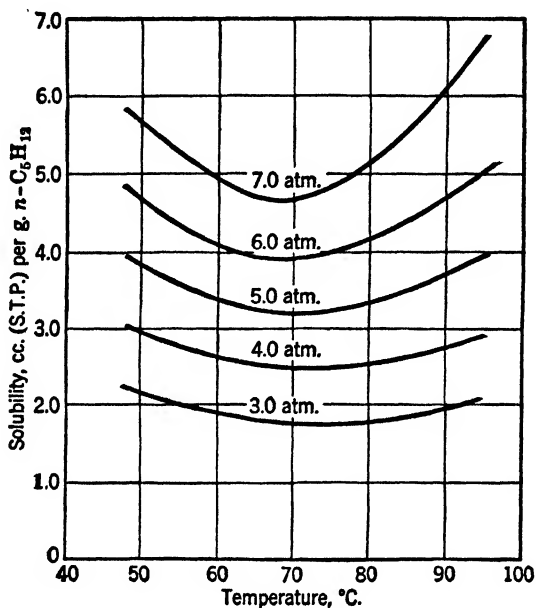

FIG. 2-3. Solubility of boron trifluoride in *n*-pentane at constant partial pressure of boron trifluoride

(Courtesy Phillips Petroleum Co. and *Journal of the American Chemical Society*)

3

Chemical Properties of Boron Trifluoride *

Boron trifluoride is a colorless fuming gas of a pungent suffocating odor. It is noncombustible and a nonsupportor of combustion. It is thermally stable and is not changed by the passage of a spark through it.^(43, 44) Moissan⁽⁶³⁰⁾ found that the volume remained constant and the walls of the glass vessel were not attacked as a result of the sparking. At room temperatures boron trifluoride is monomeric.⁽²⁶⁶⁾

Action on Elements. Alkali and alkaline-earth metals when heated in boron trifluoride react with incandescence to give boron and the metal fluoride. Davy^(196, 197, 198) identified boron trifluoride by passing the boron trifluoride over red-hot potassium in a gun barrel, thus reducing the boron fluoride to boron and potassium fluoride. Gay-Lussac and Thénard⁽²⁹⁰⁾ and Rawson⁽⁷²⁶⁾ reported that when metallic sodium or potassium are heated in boron trifluoride they react with production of fire to give boron and sodium or potassium fluoride.

Dry boron trifluoride, as either a gas or a liquid, does not react at room temperature or below with mercury or chromium plate even at high pressure and over considerable time.⁽⁹²⁾ Boron trifluoride is said to be without action on red-hot iron.⁽¹⁹⁸⁾

Readily oxidizable metals such as magnesium and its alloys^(729, 877) are protected from oxidation while in molten condition by being maintained in contact with boron trifluoride.

Delavault^(202, 203) has found that combustion of magnesium and its alloys can be inhibited with boron trifluoride in small quantities if not diluted with too much air and if humidity is avoided. Combustion of magnesium is inhibited by 1 to 0.2% boron trifluoride.

* Reactions of boron trifluoride in which coordination compounds are formed are discussed in Chapter 4. Reactions of boron fluoride with water and the various fluoborates are discussed in Chapter 4 and Chapter 5.

The gas lowers the flame of burning magnesium and condenses metallic magnesium some distance from the combustion space. At 700°C. in 2% boron trifluoride it is possible to separate the liquid metal with an iron wire without combustion. Boron trifluoride has been patented (406a) as a flux for use in soldering magnesium.

A copper alloy made by occluding boron trifluoride in copper at temperatures of 1400°C. and upward and cooling while the fluoride is occluded therein has been patented.⁽³⁰⁷⁾ Whether or not reaction has taken place is not clear.

Seguin ⁽⁷⁹⁰⁾ found that continued sparking of a mixture of boron trifluoride and hydrogen decomposes it, giving droplets of an unknown liquid and a light-brown deposit on the walls of the glass tube. Reduction of boron trifluoride by hydrogen in a tungsten arc yielded only small quantities of crystalline boron.⁽¹⁸⁹⁾

Action of Boron Trifluoride on Halogen Compounds. Booth and Frary ⁽⁹³⁾ found that a mixture of boron trifluoride and boron trichloride suffered no reaction either when heated to 500°C. or when a spark was passed through it.

Gamble, Gilmont, and Stiff ⁽²⁸⁰⁾ utilized the low volatility of aluminum fluoride (m. pt. 1040°C.) for the preparation of boron trichloride and tribromide by the action of boron trifluoride or potassium fluoborate on aluminum chloride or bromide. No boron chlorofluorides nor bromofluorides were formed, but the aluminum fluoride residue always contained chloride or bromide. The use of boron trifluoride is particularly recommended for the preparation of boron tribromide. The reaction vessel consisted of two flasks, a 1-l. flask with a ½-l. distilling flask above it, connected by a 25-cm. length of 30-mm.-diameter tubing. A 10-mm. tube inserted from the top down through the 30-mm. tubing to the bottom of the 1-l. flask served to introduce the boron trifluoride. The smaller upper flask served to condense volatilized aluminum halides. Boron trifluoride was passed through to sweep out air, and then aluminum chloride in the lower flask was heated gently with a free flame, causing a gradual rising of the temperature. The yield of boron trichloride is 80%, and under the same conditions if aluminum bromide is used the yield of boron tribromide is 70%. Potassium fluoborate was less efficient.

Reaction of Boron Trifluoride on Oxides. Gasselin ⁽²⁸²⁾ found that carbon monoxide and boron trifluoride do not react either cold, hot, or in sunlight.

Baudrimont ⁽⁴⁷⁾ passed boron trifluoride over red lead heated to

redness and obtained a gas which he thought was fluorine but which was probably oxygen.

Alkalies react with boron trifluoride when warmed.⁽⁶³⁵⁾ With water-slaked lime, $\text{Ca}(\text{OH})_2$, boron trifluoride reacts with a great evolution of heat to form a mixture of calcium borate and fluoborate. McIntyre⁽⁶⁶⁷⁾ has patented the removal of boron trifluoride from the waste gases from vitreous-enamel smelting by use of powdered calcium hydroxide.

Ruff and coworkers⁽⁷⁴³⁾ found that boron trifluoride could be freed from silicon tetrafluoride to a great extent by passing the gases over molten boric oxide. They speculated on the possibility of the formation of coordination compounds between boric oxide and boron trifluoride.

With a view to checking up on this possibility Baumgarten and Bruns⁽⁶¹⁾ studied the reaction of a current of boron trifluoride on boric oxide at 450° . They concluded that the volatile sublimate that collected beyond the heated part of the tube consisted of an oxyfluoride of boron and not a coordination compound. They postulated the reaction to be $\text{B}_2\text{O}_3 + \text{BF}_3 \rightarrow (\text{BOF})_3$, and the oxyfluoride to be a cyclic trimer,

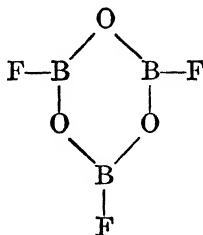

The same oxyfluoride is claimed to be the product of the reaction of boron trifluoride on a number of inorganic oxygen-containing compounds, which proceed, according to the authors, as follows:

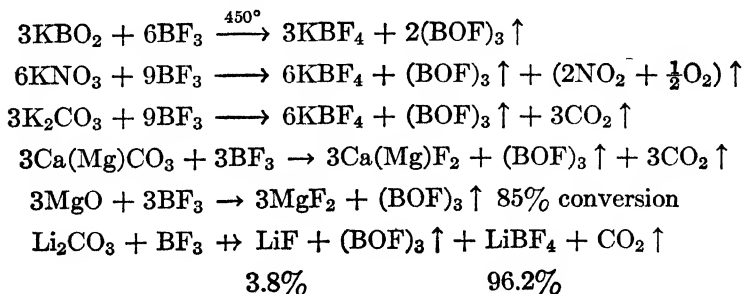

The reaction with calcium oxide was much slower and gave only 17% conversion.

According to a later publication ⁽⁶²⁾ boron trifluoride reacts at 450°C. with alumina:

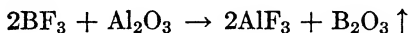

At this temperature the B_2O_3 volatilizes, presumably as the oxyfluoride. At higher temperatures the reaction reverses. Boron trifluoride begins to react with silica at 350°C., and the reaction is relatively rapid at 450°C.



Titania volatilizes like silica but much more slowly. Boron trifluoride reacts quantitatively with enstatite, MgSiO_3 and walstonite, CaSiO_3 ,

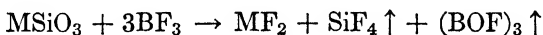

Glass is similarly attacked at 450°C. Ignited kaolin reacted at 500° according to

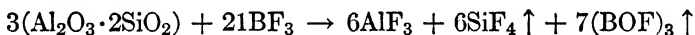

Potash feldspar, KAlSi_3O_8 , and oligoclase, $x\text{NaAlSi}_3\text{O}_8 \cdot y\text{CaAl}_2\text{Si}_3\text{O}_8$, react similarly to yield the metal fluorides, volatile silicon tetrafluoride, and boron oxyfluoride. This reaction is proposed ⁽⁶²⁾ as a method of recovering alumina from clay.

Reaction of Boron Trifluoride with Organic Compounds. Gasselin ⁽²⁸²⁾ reported that boron trifluoride did not react with methane nor with benzene. Reactions with organic oxy- and nitrogen compounds in which coordination takes place are discussed in Chapter 4.

Morgan and Tunstall ⁽⁶⁴¹⁾ found that boron trifluoride reacts energetically with β -diketones in benzene solution, splitting out H from OH and F from BF_3 , giving HF and

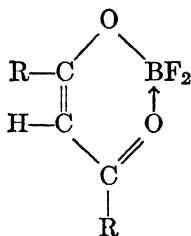

They isolated **boron acetylaceton difluoride** in the form of large colorless plates crystallizing from chloroform-ligroin solution (m. pt. 43°C.). It is very soluble in benzene, decomposed by alcohol, and almost insoluble in light petroleum. By the reaction of boron trifluoride on a concentrated solution of benzoylacetone in dry benzene containing a little light petroleum, boron benzoylacetone difluoride, crystallizing from chloroform in rhombohedra having a melting point of 155°C., was obtained.

When the same procedure is applied to dibenzoylmethane at 0°C., boron dibenzoylmethane difluoride is obtained as yellow crystalline needles from hot chloroform (m. pt. 191°C.).

Morgan and Taylor⁽⁶³⁹⁾ found that boron trifluoride and methyl salicylate reacted with evolution of hydrogen fluoride. The pale yellow crystalline product sublimed under 20 mm. pressure to yield colorless crystals melting at 128°C. This compound was analyzed and found to be $C_8H_8O_3BF_2$ which indicates union of the boron atom to oxygen and coordination of the boron atom with the ester group.

Reaction of Boron Trifluoride with Organometallic Compounds. The reaction of boron trifluoride with organometallic compounds provides a simple means of synthesizing considerable quantities of organoboron compounds at a relatively low cost.⁽⁴⁶⁷⁾ Of the boron halides the trifluoride is the best to use.

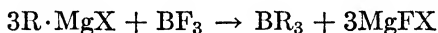

In some cases by the use of an excess of boron trifluoride mono- and difluoro compounds may be synthesized. Johnson, Snyder, and Van Campen, Jr.⁽⁴⁴⁰⁾ claim that much better yields (about 80%) of tributylborane can be obtained by the Grignard reaction by using the $BF_3 \cdot Et_2O$ complex instead of gaseous boron trifluoride.

Krause and Nitsche⁽⁴⁶⁷⁾ simply bubbled pure dry boron trifluoride into the alkyl Grignard reagent and distilled off the products in a nitrogen atmosphere directly from the reaction vessel. The boron alkyls are colorless mobile liquids of characteristic odor which are spontaneously combustible in air with increasing difficulty with increasing length of the alkyl chain.

By the reaction of boron trifluoride on alkylmagnesium chlorides, Krause and Nitsche⁽⁴⁶⁷⁾ made the following trialkylboranes: isoamyl (b. pt._{14 mm.} 119°C.); isobutyl (b. pt._{20 mm.} 86°C.; b. pt._{760 mm.} 188°); and propyl (b. pt._{20 mm.} 60°C.; b. pt._{760 mm.} 156°C.).

Ruthruff⁽⁷⁶⁴⁾ patented a method for preparing trialkylborines which consists of reacting an alkyl halide with aluminum (which may be activated) and then reacting the resulting alkylaluminum halide with boron trifluoride gas or its etherate.

Burg⁽¹⁴³⁾ reported that boron trifluoride reacts quantitatively with zinc methyl to yield boron trimethyl and zinc fluoride.

Kraus and Brown⁽⁴⁶⁵⁾ found that boron trifluoride reacted with lithium metal in liquid ethylamine to give lithium fluoride, hydrogen, and boron triethylimine:

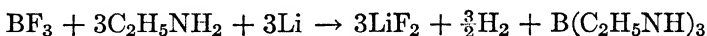

Whenever attempts have been made to obtain methyl boron fluorides by the Grignard reaction and boron trifluoride, the only product is the trimethylborine. However, Burg⁽¹⁴³⁾ found when he attempted to make coordination compounds with methyl boric anhydride and boron trifluoride that he obtained instead a reaction (idealized):

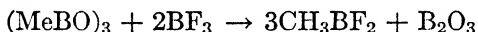

By the reaction of dimethylboric anhydride with boron trifluoride, dimethyl boron fluoride was obtained:



The experimental details of the preparation of the methyl boron fluorides are given in Table 8. The physical properties of these interesting gases are given in Table 9. The methyl boron fluorides were found to react quantitatively with zinc methyl:

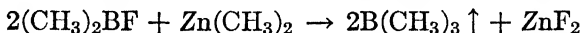
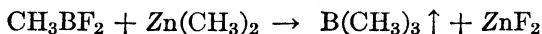

This reaction was used for the quantitative analysis of the methyl boron fluorides.

Bauer and Hastings⁽⁵⁰⁾ by electron-diffraction methods found that the molecules comprising the series $\text{B}(\text{CH}_3)_3$, $\text{B}(\text{CH}_3)_2\text{F}$, BCH_3F_2 , and BF_3 have the same configuration (planar) and approximately the same interatomic distances as shown in Table 10.

Boron trifluoride is even more useful as a synthetic agent in preparing *aryl-boron compounds*. Krause and Nitsche⁽⁴⁶⁸⁾ found that boron triphenyl is easily obtained in 50% yields by saturating one part of the Grignard reagent, phenyl magnesium bromide, at

TABLE 8

PREPARATION OF THE METHYL BORON FLUORIDES

		Experiment				
		1	2	3	4	5
Reactants	(CH ₃ BO) ₃	9.75	30	16.8
	BF ₃	9.75	28.7	20.5	12.2	45.2
	[(CH ₃) ₂ B] ₂ O	18.2	65.5
Temperature, °C.		25 *	25	100	25	25
Time allowed, hr.		12	240	4	1	27
Reactants regained, cc.	(CH ₃ BO) ₃	2.4	13	5.1
	BF ₃	0	0	1.1†	0.6	0
Products, cc.	CH ₃ BF ₂	13.6	42.2	27.5
	(CH ₃) ₂ BF	21.6	110
Yields, %	Based on F	93	98	95	62	81
	Based on C	62	83	78	59	84

* The reaction was almost completed during 2 hours at -45°.

† Here the anhydride was regained by disproportionation of the nonvolatile residue.

TABLE 9

PHYSICAL PROPERTIES OF THE METHYL BORON FLUORIDES

	CH ₃ BF ₂	(CH ₃) ₂ BF
Molecular weight, obsd.	64.1	60.1
Molecular weight, calc'd	63.85	59.87
Melting points	-130.5°C.	-147.4°C.
Boiling points (760 mm.)	-62.3°C.	-42.2°C.
Vapor press., log p mm.	- (1204.0/T) + 1.75 log T - 0.00684T + 5.9680	7.7370 - (1121.4/T)
Heat vapor'n., cal.	4750	5126
Trouton constant	22.6	22.2

TABLE 10

COMPARISON OF INTERATOMIC DISTANCES IN BORON COMPOUNDS

Compound	B-C Distance, Å.	B-F Distance, Å.
H ₃ BCO	1.57 ± 0.03	
(CH ₃ BO) ₃	1.57 ± 0.03	
B(CH ₃) ₃	1.56 ± 0.02	
B(CH ₃) ₂ F	1.55 ± 0.02	1.29 ± 0.02
BCH ₃ F ₂	1.60 ± 0.03	1.30 ± 0.02
BF ₃		1.30 ± 0.02
(CH ₃) ₂ O:BF ₃		1.41 ± 0.02
Alkali fluoborates		1.43
Expected, for bonds of unit order: S and S	1.57	1.39

0°C. with boron trifluoride and then adding three parts more of the phenylmagnesium bromide cautiously followed by refluxing for several hours. By distillation, at 13 to 15 mm. pressure under nitrogen at 245–250°C., boron triphenyl condenses as a thick oil (b. pt._{15 mm.} 203°C. in CO₂) and solidifies to long thick six-sided prisms (m. pt. 136°C.). It quickly oxidizes in the air, fumes, and liquefies, but never ignites. If, in its preparation, no excess of phenylmagnesium bromide is used it is obtained as a mixture with PhBF₂ and Ph₂BF which were not isolated.

According to a German patent ⁽⁴⁶⁶⁾ Krause later isolated phenyl boron difluoride as an oily liquid (b. pt. 70–75°C.). By the action of boron trifluoride on *p*-tolylmagnesium bromide he obtained boron *p*-tolyl difluoride, an oily liquid (b. pt. 95–97°C.).

Krause and Nobbe ⁽⁴⁶⁹⁾ saturated 0.5 mole of the Grignard reagent, benzylmagnesium chloride, in 300 ml. of ether with boron trifluoride, added another 0.5 mole of the Grignard reagent, and refluxed the mixture. On distillation at low pressure, they obtained boron tribenzyl which condensed as an oily liquid, slowly crystallizing in prismatic crystals, m. pt. 47°C. (corr.). By the same procedure they made boron tri- α -naphthyl [m. pt. 203° (corr.)] and boron tri-*p*-xylyl [m. pt. 146–147°C. (corr.) and b. pt._{12 mm.} 221°C. (uncorr.)].

The same workers, ⁽⁴⁷⁰⁾ by the same general procedure, using boron trifluoride, obtained boron tri-*p*-anisyl [m. pt. 128° (vacuum corr.)], boron tritertiary butyl, a mobile liquid (b. pt._{12 mm.} 71°C.), traces of what appeared to be boron tertiary butyl, and boron tri-*sec*-propyl (b. pt._{760 mm.} 148–154°C.; b. pt._{12 mm.} 33–35°C.). Efforts to use this method to obtain boron diethyl phenyl gave mixtures of boron triethyl and boron triphenyl.

4

The Coordinating Power of Boron Trifluoride

Although boron trifluoride was discovered over one hundred and thirty years ago,⁽²⁹³⁾ knowledge of the many addition compounds which it is capable of forming is comparatively recent. On the basis of the electronic structure of boron trifluoride, the boron atom should be a good acceptor of electrons, and boron trifluoride should form many coordination compounds by the mechanism of the following example:

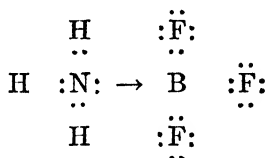

Actually the number of such compounds is astonishingly great, whereas the number of different atoms which have been found to donate electron pairs to the boron atom is surprisingly small. Recently a review of coordination compounds of boron trifluoride has been published by Nikitina.^(672a)

Coordination compounds will be discussed according to the groups in the Periodic Table of which the donor atom is a member. As would be expected from the fact that they are polar, none of the members of Group I, II, or III has been found to donate to the boron atom of boron trifluoride.

GROUP O

In Group O, argon has been found by Booth and Willson,⁽¹⁰⁰⁾ by means of thermal analysis,⁽⁹⁶⁾ to form six addition compounds with boron trifluoride at low temperatures and under pressure

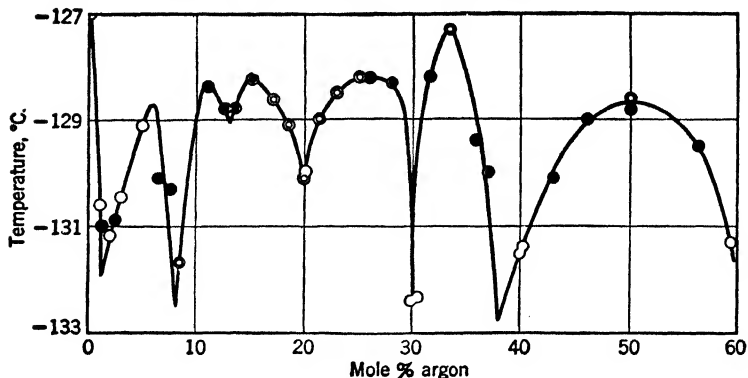

FIG. 4-1. Freezing points of the stabilized system argon-boron trifluoride
(Courtesy *Journal of the American Chemical Society*)

(Figure 4-1). These compounds were $A \cdot BF_3$, $A \cdot 2BF_3$, $A \cdot 3BF_3$, $A \cdot 6BF_3$, $A \cdot 8BF_3$, and $A \cdot 16BF_3$. See Table 11 for physical constants.

TABLE 11

FREEZING POINTS OF ARGON-BORON TRIFLUORIDE COMPOUNDS

Compound	Freezing Point, °C.	Reference
$A \cdot BF_3$	-128.6	100
$A \cdot 2BF_3$	-127.3	
$A \cdot 3BF_3$	-128.3	
$A \cdot 6BF_3$	-128.3	
$A \cdot 8BF_3$	-128.4	
$A \cdot 16BF_3$	-129.0	

Of these compounds, as might be expected, the symmetrical $F_3B \leftarrow A \rightarrow BF_3$ is the most stable. The structure of the three compounds with 6, 8, and 16 molecules of boron trifluoride is explained as due to coordination of the argon atom with polymerized molecules of boron trifluoride (Figure 4-2). In the pressure region in which they occur boron trifluoride has been shown to be polymerized⁽⁹²⁾ to a viscous liquid. In order to form the compound $A \cdot 16BF_3$ the BF_3 must exist under these conditions as tetramers. This explanation is analogous to that given by Sidgwick for excessive hydration by polymerized water molecules.

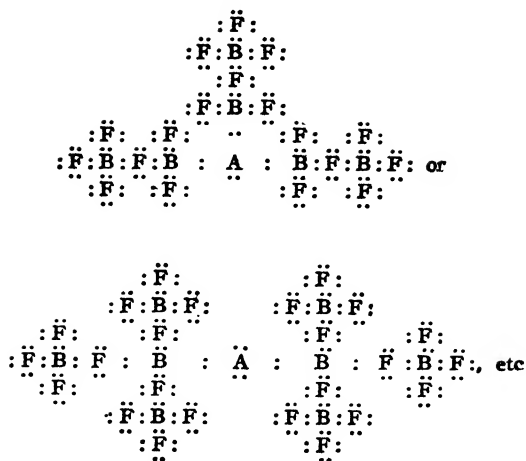

FIG. 4-2. Suggested coordination of argon with polymerized molecules of boron trifluoride

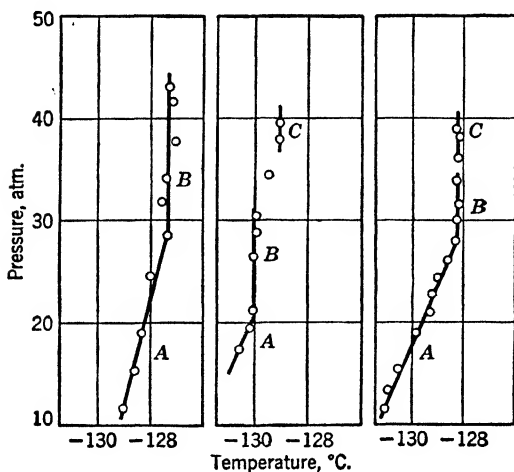

FIG. 4-3. Evidence for existence of compounds of argon and boron trifluoride above the freezing point. Dissociation products of the argon-boron trifluoride compounds lower the freezing point of the solution
(Courtesy *Journal of the American Chemical Society*)

The investigation also demonstrated the existence of these compounds in the liquid phase above their freezing point (see Figure 4-3). In certain pressure regions and in some compositions a new phenomenon occurred which the authors call retrograde immiscibility.

GROUP IV

Although no addition compounds have been isolated in which the donor atom was a member of Group IV, it has been postulated that the carbon atom, in olefin compounds, is the donor to the boron atom of boron trifluoride in condensation and polymerization reactions in which boron trifluoride is the catalyst. (See Chapter 6.)

A reaction between ethylene and boron trifluoride was reported by Landolph^(480, 482, 486, 487) in which $C_2H_3BF_2$ and ethylene fluoroboric acid, $C_2H_4 \cdot HF \cdot BO_2$, were reported to be formed. Acetylene, propylene, amylenes, and other unsaturated compounds were thought to react likewise.

In the light of later studies with unsaturated hydrocarbons, it appears that the carbon atom of the unsaturated hydrocarbons donates to the boron atom of boron trifluoride. Price and Ciskowski⁽⁷²²⁾ suggested that the catalytic effect of boron trifluoride in causing olefins to condense with aromatic compounds, or to polymerize, involves activation of the carbon-carbon double bond by association with the catalyst. "A consequence of such association should be establishment of equilibrium between *cis-trans* isomers. This has now been confirmed experimentally for the case of isomeric stilbene."⁽⁷²⁴⁾

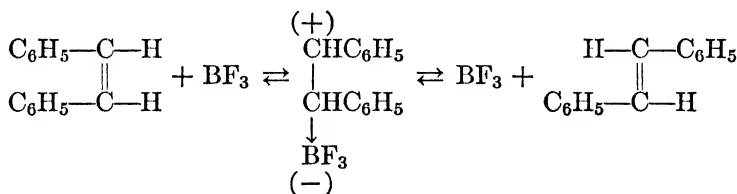

Gasselin,⁽²⁸²⁾ on the contrary, obtained no reaction between ethylene and boron trifluoride and suggested that Landolph's compound might have been between the boron trifluoride and some diethyl ether which might have been in the ethylene. In an effort to run the system ethylene-boron trifluoride, Booth⁽⁸⁸⁾ condensed liquid boron trifluoride and liquid ethylene, at $-110^\circ C.$; polymerization immediately set in, giving a tarry mass so that a study of the system was impossible. He found that propylene behaved likewise.

Gerhart and coworkers^(295,296,298) have recently stated that boron trifluoride forms a hydrocarbon complex with the butenes and most easily with isobutene below 93°C.

Gasselín⁽²⁸²⁾ reported that amylene was polymerized to di- and triamylene by boron trifluoride. Also he reported that he obtained no reaction between methane and boron trifluoride. However, a reaction was more recently reported between a saturated hydrocarbon and boron trifluoride by Krause and Nobbe.⁽⁴⁷⁰⁾ They suggested that one of their products in making boron alkyls was tertiary butyl boron fluoride. They offered no formula for this compound, but, judging from the type of reaction in which it is formed, it is probably a compound such as Me_3CBF_2 .

Gasselín⁽²⁸²⁾ reported that closed-chain compounds such as benzene resisted the action of boron trifluoride.

Carbon monoxide does not react with boron trifluoride.⁽²⁸²⁾

GROUP V

Only two elements in Group V are reported to furnish atoms in compounds, which donate to the boron atom of boron trifluoride. These are nitrogen and phosphorus. Arsine has been reported⁽⁸⁶²⁾ to form a 1:1 compound with BCl_3 and, although it is reasonable to expect that arsine would give a similar compound with BF_3 , almost complete immiscibility was found.^(578a) It is possible that appropriate alkyl compounds of arsenic, antimony, and even bismuth would coordinate with boron trifluoride.

NITROGEN

Ammonia was found by Gay-Lussac^(289,291) to react with boron trifluoride. The two gases reacted volume for volume, and also two volumes of ammonia reacted with one volume of boron trifluoride. Davy⁽¹⁹⁹⁾ confirmed Gay-Lussac's work and reported in addition a compound of 1 mole of boron trifluoride with 3 moles of ammonia. Mixer⁽⁶²¹⁾ was the first to assign a formula to any of the afore-mentioned compounds, and in 1880 he reported $\text{BF}_3 \cdot \text{NH}_3$. This compound has been prepared by thermal decomposition of metal fluoborate ammoniates.⁽³⁴⁾ The heat of reaction of $\text{NH}_3 \rightarrow \text{BF}_3$ (s) from gaseous ammonia and gaseous boron trifluoride is 42 kcal.⁽⁴⁸⁾ Condike and Laubengayer⁽¹⁸²⁾ recently found 41.3 kcal. for the heat of formation from the gases

at 0°C. The compound $\text{NH}_3 \rightarrow \text{BF}_3$ undergoes irreversible thermal decomposition above 125°C.^(492a) as expressed by the equation $4\text{H}_3\text{N}:\text{BF}_3 \rightarrow 3\text{NH}_4\text{BF}_4 + \text{BN}$. Balz and Zinser⁽³⁴⁾ have found the density of $\text{BF}_3 \cdot \text{NH}_3$ at 25°C. to be 1.831 from which the molar volume is calculated to be 46.3 cc. The solid is quite soluble in water and may be recrystallized from it without hydrolysis. Cryoscopic measurements on aqueous solutions show that it exists in such solutions as the monomeric molecule and is not appreciably dissociated.⁽¹⁸²⁾ Its melting point is $163 \pm 1^\circ\text{C}$.^(492a) Optical studies have been made on the crystals, and the powder X-ray diffraction pattern has been established. Rideal⁽⁷³⁰⁾ later reported the compounds $\text{BF}_3 \cdot 2\text{NH}_3$ and $\text{BF}_3 \cdot 3\text{NH}_3$, but Condikey and Laubengayer^(182, 492a) could not confirm them. The formation of these compounds has been reported to be used industrially for the recovery of boron trifluoride from reactions in which it has served as a catalyst.^(304, 827, 829, 838, 851)

Most of the other coordination compounds in which the nitrogen atom is the donor may be looked on as derivatives of ammonia. Trimethylamine has been found to form a one-to-one compound with boron trifluoride, $(\text{CH}_3)_3\text{N} \cdot \text{BF}_3$,^(111, 145, 586) having an electric dipole moment of 5.76 ± 0.02 debyes.⁽⁷¹⁴⁾ With trimethylamine-boron trifluoride, ethylene oxide⁽⁵⁸⁶⁾ gives the betaine, $(\text{CH}_3)_3\text{N}^+ \cdot (\text{CH}_2)_2 \cdot \text{O} \cdot \text{BF}_3^-$.

Kraus and Brown⁽⁴⁶⁴⁾ studied the compounds between the ethylamines and boron trifluoride and found $\text{BF}_3 \cdot \text{NH}_2(\text{C}_2\text{H}_5)$, $\text{BF}_3 \cdot \text{NH}(\text{C}_2\text{H}_5)_2$, and $\text{BF}_3 \cdot \text{N}(\text{C}_2\text{H}_5)_3$. Meerwein and Pannwitz⁽⁵⁸⁹⁾ list the compound $\text{BF}_3 \cdot 2\text{N}(\text{C}_2\text{H}_5)_3$. Bright and Fernelius⁽¹¹¹⁾ suggest that the molecular-weight data for the compounds with trimethylamine, triethylamine, and ethylamine indicate association in the liquid state. This is to be expected from the dipole character of such coordination compounds. Trimethylamine-boron trifluoride has been reported to be associated in the vapor state also.⁽¹⁴⁵⁾ Ethylaminoboron trifluoride is "aminolyzed" in ethylamine, and this solution when treated with lithium gave lithium fluoride and hydrogen quantitatively.⁽⁴⁶⁵⁾

Amino alcohols such as ethanolamine form coordination compounds with boron trifluoride. The donor in this case might be the oxygen atom.⁽⁶¹⁰⁾ The coordination compound of boron trifluoride and ethanolamine has been patented as a component of a flux suitable for use in soft-soldering aluminum.⁽⁶¹⁰⁾

Aliphatic polyamines like ethylenedi- or triamine are reported to coordinate with boron trifluoride.⁽⁶¹¹⁾ These compounds also have been patented as components suitable for fluxes for use in soft-soldering aluminum and its alloys.⁽⁶¹¹⁾

A compound between hexamethylenetetramine and boron trifluoride, $(\text{CH}_2)_6\text{N}_4 \cdot 4\text{BF}_3$, has been reported.⁽¹⁴⁶⁾

Landolph⁽⁴⁸¹⁾ found that amides combined with boron trifluoride. He found that one equivalent of brucine combined with two equivalents of boron trifluoride, that is, 1 molecule of boron trifluoride to each nitrogen atom.

Acetamide was found by Bowlus and Nieuwland⁽¹⁰⁷⁾ to absorb 1 mole of boron trifluoride to form a viscous liquid.

Aniline was found to give a needle-like crystalline compound with boron trifluoride.^(481, 730) Although the investigators did not give a formula for this compound, it probably is $\text{BF}_3 \cdot \text{NH}_2\text{C}_6\text{H}_5$. Sugden and Waloff⁽⁸⁷⁹⁾ verified this reaction with aniline. They extended their work with aniline to include methylaniline, dimethylaniline and *p*-toluidine. With all these compounds, boron trifluoride gave solid products which did not lend themselves to purification. More recently, Bright and Fernelius⁽¹¹¹⁾ have prepared dimethylaniline-boron trifluoride. From cryoscopic molecular-weight determinations they have concluded that the compound is associated.

R. E. Burk has patented⁽¹⁵³⁾ the recovery of boron trifluoride by passing the hydrocarbon containing the boron trifluoride through liquid dimethylaniline followed by heating to liberate the boron trifluoride.

Sugden and Waloff⁽⁸⁷⁹⁾ isolated and identified acetanilide-boron trifluoride, $(\text{C}_6\text{H}_5)(\text{CH}_3\text{CO})\text{HN} \cdot \text{BF}_3$, and methylacetanilide-boron trifluoride, $(\text{C}_6\text{H}_5)(\text{CH}_3\text{CO})\text{CH}_3\text{N} \cdot \text{BF}_3$. These compounds have the following properties:

Acetanilide-boron trifluoride, $\text{C}_8\text{H}_9\text{ON} \cdot \text{BF}_3$, is insoluble in benzene, ligroin, ether, and isopropyl ether and very soluble in acetone and alcohol. Unlike the methyl derivative, it is not hygroscopic. It melts at 133°C. It decomposes just above the melting point.

Methylacetanilide-boron trifluoride, $\text{C}_9\text{H}_{11}\text{ON} \cdot \text{BF}_3$, was prepared by pouring a solution of 10 g. of methylacetanilide in dry ether into an ethereal solution of boron trifluoride. The product is insoluble in benzene, toluene, ether, and isopropyl ether but

very soluble in acetone and alcohol. The compound is purified by dissolving it in the minimum amount of dry acetone and precipitating it by the addition of two volumes of dry isopropyl ether. It melts at 114° . The densities determined were $D_4^{114^{\circ}}$ 1.193, $D_4^{120.5^{\circ}}$ 1.189, $D_4^{128^{\circ}}$ 1.182, $D_4^{135.5^{\circ}}$ 1.176, $D_4^{150.5^{\circ}}$ 1.164, whence $D_4^{t^{\circ}} = 1.205 - 0.00083(t - 100)$.

Temperature	118.5°	128.5°	139°	150°
Surface tension, γ	38.06	37.10	36.03	34.90
D	1.190	1.181	1.173	1.164
Parachor (P)	452.9	453.6	453.2	453.1
			Mean	453.2

Meerwein and Vossen confirmed the compound reported by Sugden and Waloff with dimethylaniline. They reported a one-to-one compound with boron trifluoride, $\text{BF}_3 \cdot \text{N}(\text{CH}_3)_2\text{C}_6\text{H}_5$.⁽⁵⁹⁰⁾

Monopotassium aniline was reported by Meerwein⁽⁵⁸⁵⁾ to form the compound $\text{BF}_3 \cdot \text{NKHC}_6\text{H}_5$. A similar sodium compound was formed also.

Benzalaniline-boron trifluoride was reported by Snyder, Kornberg, and Romig⁽⁸¹⁶⁾ as a catalyst in organic reactions:

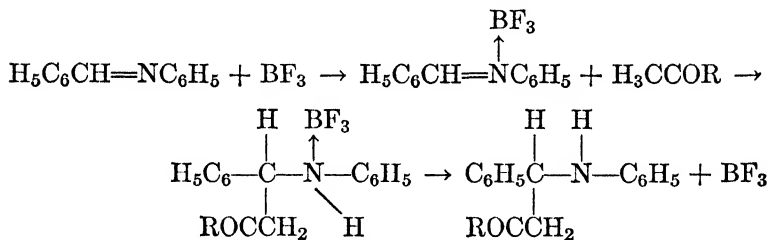

In this reaction, H_3CCOR may be acetone, ethyl methyl ketone, isobutyl methyl ketone, normal amyl methyl ketone, 4-methyl-2-hexanone, benzylacetone, pinacolone, cyclopentanone, acetophenone, or malonic ester.

Sowa and Nieuwland⁽⁸²⁸⁾ suggested that in the preparation of esters of such aromatic acids as *p*-aminobenzoic acid and methyl anthranilate, the catalytic action of boron trifluoride is probably due to the formation of a complex intermediate compound such as $p\text{-(C}_6\text{H}_4\text{)(COOH)-H}_2\text{N} \cdot \text{BF}_3$.

Grummitt⁽⁸²⁶⁾ prepared the solid acetophenone oxime-boron trifluoride, $\text{C}_6\text{H}_5(\text{CNOH})\text{CH}_3 \cdot \text{BF}_3$, in which either the nitrogen or oxygen atom could be the donor. Likewise, *p*-tolyl phenyl

ketoxime-boron trifluoride, $p\text{-CH}_3\text{C}_6\text{H}_4\cdot\text{C}\cdot\text{C}_6\text{H}_5\cdot\text{NOH}\cdot\text{BF}_3$, was prepared.

A boron trifluoride compound of diazotized 4-amino-1-monoethylamino-2-toluene was patented in 1927.⁽⁴⁴⁶⁾

Bowlus and Nieuwland⁽¹⁰⁷⁾ found that pyridine absorbed 2 moles of boron trifluoride to give a crystalline compound. Later the compound with 1 mole of boron trifluoride, $\text{C}_5\text{H}_5\text{N}\cdot\text{BF}_3$, was reported.⁽⁵⁹⁹⁾ This pyridine compound has been reported to be less stable than the trimethylamine-boron trifluoride compound.⁽¹¹⁶⁾

Van der Meulen and Heller⁽⁵⁹⁹⁾ studied the dissociation of pyridine-boron trifluoride and reported the data shown in Table 12.

TABLE 12

DISSOCIATION OF PYRIDINE-BORON TRIFLUORIDE BY HEAT

Temperature, °C.	Apparent	Degree of
	Molecular Wt.	Dissociation, %
356	89.9	63.3
333	108.2	35.7
313	124.1	18.2

From these data they calculated the heat of dissociation, ΔH , to be -50.6 kcal. for all components in the gaseous state. They found it to be soluble in benzene, pyridine, and hot absolute alcohol. In 95% alcohol it undergoes hydrolysis. It is slightly soluble in boiling chloroform and practically insoluble in petroleum ether.

A pyridine derivative, α,α' -lutidine, forms a coordination compound with boron trifluoride which is a stronger base toward HCl than the pyridine compound with boron trifluoride.⁽¹¹⁶⁾ Bowlus and Nieuwland also found that similar compounds, such as quinuoline and piperidine, absorbed only 1 mole of boron trifluoride.⁽¹⁰⁷⁾

The nitrogen atom in the cyanide radical has been found to donate to boron trifluoride. Patein⁽⁶⁹¹⁾ reported the compound $\text{HCN}\cdot\text{BF}_3$, and also compounds with derivatives of hydrogen cyanide, such as acetonitrile-boron trifluoride, $\text{CH}_3\text{CN}\cdot\text{BF}_3$; benzonitrile-boron trifluoride, $\text{C}_6\text{H}_5\text{CN}\cdot\text{BF}_3$; and phenylacetonitrile-boron trifluoride, $\text{H}_3\text{CC}_6\text{H}_4\text{CN}\cdot\text{BF}_3$. More recently Bowlus and Nieuwland⁽¹⁰⁷⁾ and Laubengayer and Sears⁽⁴⁹⁵⁾ have established some of the physical properties of acetonitrile-boron tri-

fluoride (see Table 13). The compound $\text{CH}_3\text{CN}\cdot\text{BF}_3$ crystallizes in colorless highly birefringent orthorhombic crystals having a density of 1.59 ± 0.05 at 20°C . The crystals hydrolyze in moist air. Their vapor pressure was determined between 50 and 160°C . and is expressed by the equation $\log p_{\text{mm.}} = (-2896/T) + 10.5794$. Vapor-density measurements of $\text{CH}_3\text{CN}\cdot\text{BF}_3$ lead to

TABLE 13

PROPERTIES OF COORDINATION COMPOUNDS OF BORON TRIFLUORIDE AND NITROGEN COMPOUNDS

Compound	Melting Point, $^\circ\text{C}$.	Boiling Point, $^\circ\text{C}$.	Reference
$\text{NH}_3\cdot\text{BF}_3$	180	464
$(\text{CH}_3)_3\text{N}\cdot\text{BF}_3$	138; 150	233	111, 145
$\text{C}_2\text{H}_5\text{NH}_2\cdot\text{BF}_3$	89	464
$(\text{C}_2\text{H}_5)_2\text{NH}\cdot\text{BF}_3$	160	464
$(\text{C}_2\text{H}_5)_3\text{N}\cdot\text{BF}_3$	29.5	80_3 mm.	464
$\text{C}_6\text{H}_5(\text{CH}_3)_2\text{N}\cdot\text{BF}_3$	90-92	111, 590
$(\text{C}_6\text{H}_5)(\text{CH}_3\text{CO})\text{HN}\cdot\text{BF}_3$	133	879
$(\text{C}_6\text{H}_5)(\text{CH}_3\text{CO})\text{CH}_3\text{N}\cdot\text{BF}_3$	114	879
$\text{C}_6\text{H}_5\text{CH}:\text{NC}_6\text{H}_5\cdot\text{BF}_3$	135-145	816
$\text{C}_6\text{H}_5(\text{CNOH})\text{CH}_3\cdot\text{BF}_3$	107-113	326
$\text{C}_6\text{H}_5\text{N}\cdot\text{BF}_3$	45 ± 1	300 ± 5	599
$\text{HCN}\cdot\text{BF}_3$	40	720
$\text{CH}_3\text{CN}\cdot\text{BF}_3$	$\left\{ \begin{array}{l} 87 \\ 120 \\ 135.5 \end{array} \right.$	101 ₇₅₂	107
		691
		495

the conclusion that the dissociation of this compound in the vapor state is virtually complete. Therefore, it is possible to calculate the heat of dissociation of this compound. This value was calculated to be $\Delta H = -26.5$ kcal. The heat of formation from CH_3CN (*g*) and BF_3 (*g*) was found to be 26.5 ± 0.3 kcal. The heat of solution in water at 0°C . was found to be 4.5 ± 0.3 kcal. Molecular-weight determinations in benzene indicate that the molecule $\text{CH}_3\text{CN}\cdot\text{BF}_3$ exists and is not appreciably dissociated in dilute solutions. The dipole moment of $\text{CH}_3\text{CN}\cdot\text{BF}_3$ in benzene at 25°C . was found to be approximately 5.8 debyes.⁽⁴⁹⁵⁾ Boron trifluoride reacts with cyanogen chloride to form a nonvolatile product whose composition has not been established.^(893a)

It has been found that pyridine-boron trifluoride with ethylene oxide or epichlorohydrin⁽⁵⁸⁶⁾ at 0°C . gives the compounds $\text{C}_5\text{H}_5\text{N}\cdot$

$(\text{CH}_2)_2 \cdot \text{O} \cdot \text{BF}_3^-$ and $\text{C}_5\text{H}_5\text{N}^+ \cdot \text{CH}_2 \cdot \text{CH}(\text{CH}_2\text{Cl}) \cdot \text{O} \cdot \text{BF}_3^-$, respectively.

Miller ⁽⁶¹⁵⁾ has patented the use of boron trifluoride complexes with organic amides and aliphatic, aromatic, and heterocyclic

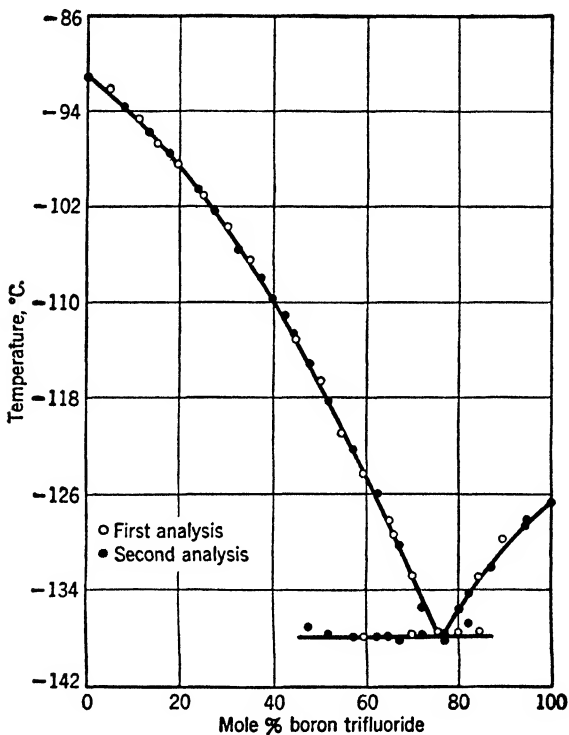

FIG. 4-4. The system nitrous oxide-boron trifluoride
(Courtesy *Journal of the American Chemical Society*)

monoamines as soldering fluxes, claiming that they do not leave a corrosive substance on a copper surface.

Reimers ⁽⁷²⁸⁾ incorporates these complexes in molding material to be used for molds in which magnesium and its alloys are to be poured, to prevent oxidation of the metal.

Kuhlmann ⁽⁴⁷⁶⁾ found that nitrous oxide formed no compound with boron trifluoride. Booth and Martin ⁽⁹⁵⁾ confirmed this study at low temperatures by thermal analyses (see Figure 4-4). Reaction with other oxides of nitrogen are discussed under Oxygen.

Table 13 lists the physical constants of the afore-mentioned compounds where reported.

PHOSPHORUS

Much less research has been carried out with compounds containing the phosphorus atom as the donor. One would expect the compounds in the phosphorus family analogous to ammonia to

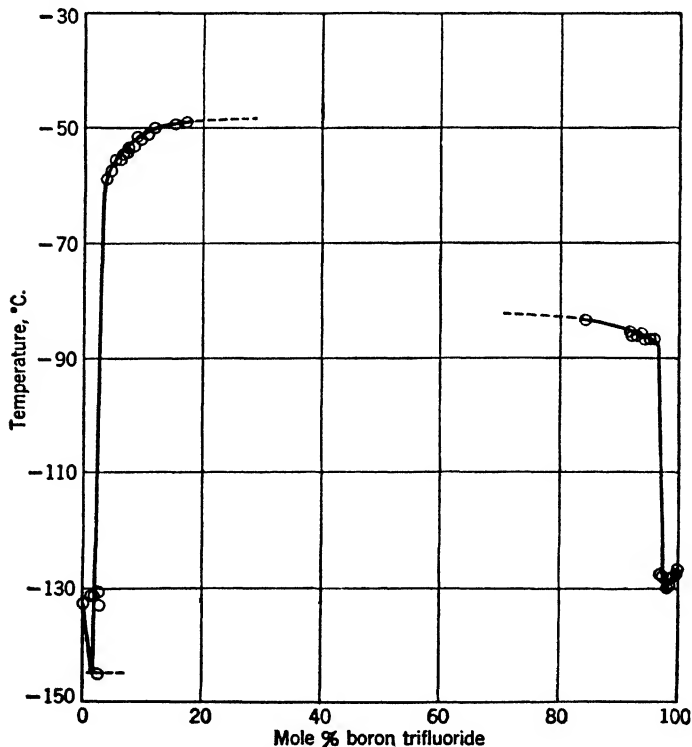

FIG. 4-5. The system phosphine-boron trifluoride

form addition compounds with boron trifluoride. Phosphine, PH_3 , and boron trifluoride were reported by Besson ⁽⁷¹⁾ to form a compound of the formula $\text{PH}_3 \cdot 2\text{BF}_3$. This compound has been questioned by later experimenters who reported the compound $\text{PH}_3 \cdot \text{BF}_3$ and who think the compound reported by Besson should have the formula $\text{PH}_3(\text{BF}_2)\text{BF}_4$. ⁽⁹⁵⁹⁾ These compounds have been checked recently by thermal analysis ^(578a) (see Fig-

ure 4-5). From the thermal-analysis diagram and from molecular-weight determinations of the gases from the thermal-analysis cell, Martin and Dial^(578a) conclude that boron trifluoride forms two compounds with phosphine, $\text{PH}_3 \cdot \text{BF}_3$, freezing point approximately -48°C ., and $\text{PH}_3 \cdot 2\text{BF}_3$, freezing point about -83°C .

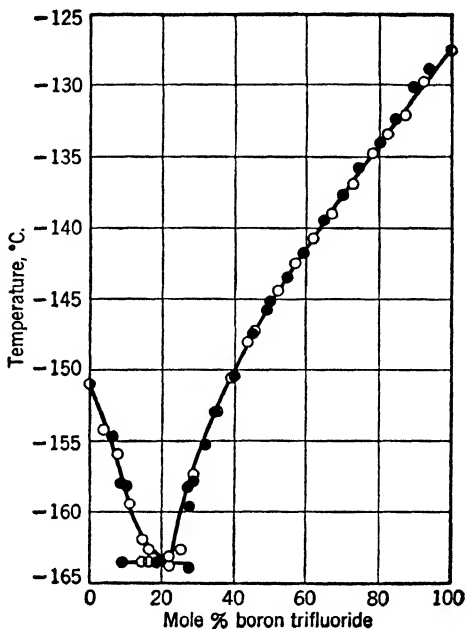

FIG. 4-6. The system phosphorus trifluoride-boron trifluoride
(Courtesy *Journal of the American Chemical Society*)

Two eutectics are definitely known to exist, one at 2 mole % boron trifluoride at -145°C ., the other at 98 mole % at -130°C .. Another eutectic is thought to exist between 50 and 67 mole %.

Ammonia has been reported to coordinate to form three addition compounds with boron trifluoride whereas phosphine forms only two. However, although the phosphorus atom in phosphorus trifluoride has an unshared electron pair, thermal analysis of the system $\text{BF}_3\text{-PF}_3$ showed no compound formation⁽⁹⁸⁾ (see Figure 4-6).

Arsenic. The temperature-composition diagram for the system arsine-boron trifluoride is shown in Figure 4-7. In this system the liquids arsine and boron trifluoride were immiscible in the region of the diagram between 1.3 and 96.3 mole % boron trifluoride.

In the right-hand region of Figure 4-7, the curve was not drawn, because of the random distribution of the points. This erratic

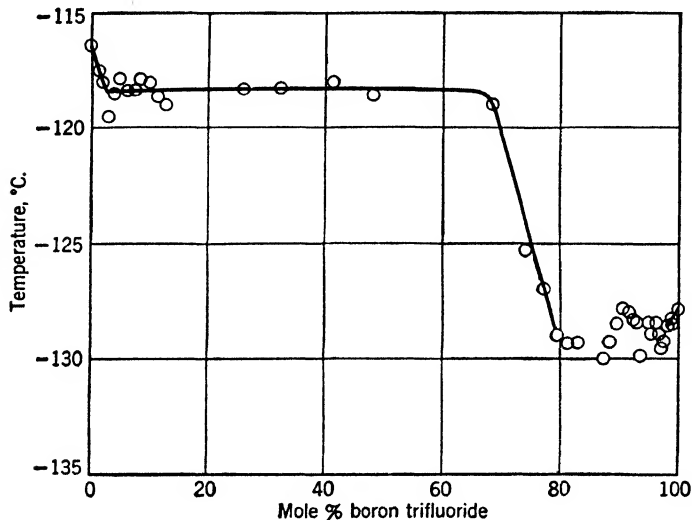

FIG. 4-7. The system arsine-boron trifluoride

spacing of points is undoubtedly due to the immiscibility observed in the cell. Probably a simple eutectic point could be assumed for this portion of the curve, but the exact placing of the curve would be difficult. The curve was therefore discontinued between 79 and 96.3 mole % boron trifluoride. No evidence for a compound between arsine and boron trifluoride was found.

GROUP VI

In Group VI (as in Group V), oxygen, the type element, has been found to form many more coordination compounds than sulfur. This may be due to the fact that more studies have been made with the oxygen compounds than with the sulfur compounds.

First, the inorganic compounds in which the oxygen atom is the donor are discussed, and then the inorganic compounds in which sulfur is the donor, the organic compounds in which oxygen atom is the donor, and the organic compounds in which sulfur is the donor.

INORGANIC OXYGEN COMPOUNDS

Shortly after boron trifluoride was discovered, among the first reactions which were tried with the new gas was its reaction with water (see also Chapter 5). According to Gasselin,⁽²⁸²⁾ Gay-Lussac

and Thénard⁽²⁹³⁾ attributed the formula $\text{B} \begin{array}{l} \diagup \text{O} \\ \diagdown \text{OH} \end{array} \cdot 3\text{HF}$ to the com-

pound they obtained by the action of boron trifluoride on water. Berzelius⁽⁶⁷⁾ and Basarow⁽⁴²⁾ reported the same compound many years later; however, Basarow doubted its existence as a chemical individual.^(44, 45)

Landolph⁽⁴⁸²⁾ attributed a different formula to the same compound, $\text{H}_2\text{B}_2\text{O}_4 \cdot 6\text{HF}$, which it may be noted is merely a multiple of that already proposed.

It was not until 1933 that the afore-mentioned compounds were rewritten to indicate that they are a dihydrate of boron trifluoride, $\text{BF}_3 \cdot 2\text{H}_2\text{O}$.^(584, 589) Since the volume of the hydroxyl ion is so near that of the fluoride ion and is isoelectronic with it, and in view of the close resemblance of its X-ray diagram to that of NH_4ClO_4 with which it is isomorphous (see Figure 5-5, Chapter 5), Klinkenberg and Ketelaar⁽⁴⁶⁰⁾ conclude that $\text{BF}_3 \cdot 2\text{H}_2\text{O}$ is really hydronium monohydroxyfluoborate, and it has been proposed⁽⁴⁶⁰⁾ that the chemical structure should be represented $[\text{OH}_3]^+ \cdot [\text{BF}_3\text{OH}]^-$. From cryoscopic evidence, also, it has recently been reported that $\text{BF}_3 \cdot 2\text{H}_2\text{O}$ is ionized in a dioxane solution⁽⁵⁶⁵⁾ "into an equilibrium mixture of hydroxyfluoboric acids."

The dihydrate also may be formed⁽⁵⁸⁹⁾ by heating to 75°C. the compound $\text{BF}_3 \cdot 2\text{HCOOH}$, made by the reaction of boron trifluoride on formic acid:

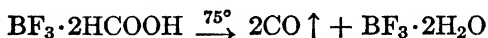

The dihydrate has been used as a catalyst⁽²³⁾ to alkylate aromatic compounds with *n*-1,3-diolefins at 26–49°C. at low pressures.

The monohydrate of boron trifluoride, $\text{BF}_3 \cdot \text{H}_2\text{O}$, is made by bubbling boron trifluoride into the liquid dihydrate in the cold.⁽⁵⁸⁴⁾ The monohydrate is the first product formed by the removal of water during organic sulfonation and nitration reactions,⁽⁸⁸⁸⁾ in which boron trifluoride is the promoter. Water is added then to produce the dihydrate which then is separated from the other reaction products by a vacuum distillation.

Boron trifluoride-trihydrate, $\text{BF}_3 \cdot 3\text{H}_2\text{O}$, made by saturation of liquid anhydrous hydrogen fluoride with boric acid, anhydride, or a borate in a closed vessel at a temperature below 10°C ., has been reported also.⁽⁵⁶³⁾

Closely related to the dihydrate is dihydroxyfluoboric acid,

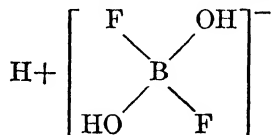

One of the hydrogen atoms of one of the water molecules is considered to have combined with one of the fluorine atoms of boron trifluoride evolving hydrogen fluoride. "Dihydroxyfluoboric acid will combine with only one mole of boron trifluoride, probably through coordination with the second hydroxyl group. However, the possibility of the hydrogen ion coordinating with one of the fluorine atoms must also be admitted."⁽⁴⁷¹⁾ The probable structure of this latter compound has been suggested to be $\text{H}_2\text{O} \cdot \text{BF}_2 \cdot \text{OH}$.^(229, 666)



It is of interest to note that Casselin in 1892 claimed to have isolated "fluoxyboric acid" from the reaction of boron trifluoride on methyl alcohol.⁽²⁸⁴⁾ He considered it as a mixed acid containing HF, HBF_4 , and H_3BO_3 .⁽²⁸²⁾

Klinkenberg⁽⁴⁵⁸⁾ has determined the specific conductance of $\text{BF}_3 \cdot \text{H}_2\text{O}$ to be 42.0×10^{-3} mho.

The monohydrate forms compounds with cineol, $\text{BF}_3 \cdot \text{H}_2\text{O} \cdot 2\text{C}_{10}\text{H}_{18}\text{O}$, and with dioxane, $\text{BF}_3 \cdot \text{H}_2\text{O} \cdot \text{C}_4\text{H}_8\text{O}_2$. The same investigators also reported analogous compounds with the dihydrate, $\text{BF}_3 \cdot 2\text{H}_2\text{O} \cdot 2\text{C}_{10}\text{H}_{18}\text{O}$ and $\text{BF}_3 \cdot 2\text{H}_2\text{O} \cdot \text{C}_4\text{H}_8\text{O}_2$.^(584, 589)

These hydrates of boron trifluoride are acidic (*vide supra*). This is attributed to the following structure, $\text{H}^+(\text{HO} \cdot \text{BF}_3)^-$, by

Meerwein and Pannwitz. They treated the monohydrate with sodium and potassium hydroxides and have obtained the corresponding sodium and potassium salts. Thus, they have been able to make $\text{BF}_3 \cdot \text{NaOH}$ and $\text{BF}_3 \cdot \text{KOH}$.⁽⁵⁸⁹⁾ They then went one step further and replaced the other hydrogen with a methyl group and have reported the compounds $\text{BF}_3 \cdot \text{NaOCH}_3$ and $\text{BF}_3 \cdot \text{KOCH}_3$. Actually, these latter compounds were made by treating methyl alcohol with boron trifluoride and then neutralizing the acidic compound thus formed with the alkali-metal hydroxide. They are crystalline powders, which dissolve in water to give an alkaline solution.

Dr. Terrell Hill * has suggested that the afore-mentioned compounds would all seem to conform to the structure,



where M^{I} may be H, H_3O , H_5O_2 , a monovalent metal, or monovalent radical of metallic character, and where Q may be OH, F or (O—R). That this interpretation is the correct one is substantiated by the X-ray study of the dihydrate,⁽⁴⁶⁰⁾ the strong electrolytic character of the compounds of boron trifluoride with alcoholates of the alkali metals, and the recent isolation of KBF_3OH .^(767a, 935a)

Crystalline compounds between oxides and boron trifluoride "of the general formula $\text{M}_2\text{O}(\text{BF}_3)_4$ in which M is selected from the group comprised of alkali metals and the NH_4 radical" have been reported by Swinehart.^(832, 833) This may have the structure:

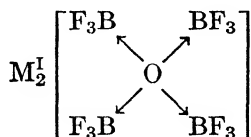

If so, it is the first known case in which oxygen has acted as the central atom in a heteropolyanionic coordination complex.

An alkaline-earth oxide, CaO , has been reported to have coordinated with boron trifluoride.⁽²²⁷⁾ McIntyre⁽⁵⁶⁷⁾ has patented the absorption of BF_3 by $\text{Ca}(\text{OH})_2$.

It has been shown previously that water and bases will form compounds with boron trifluoride. It is now of interest to observe

* University of Rochester, Rochester, N. Y.

that acidic compounds also will form compounds with boron trifluoride, which is a stronger acid. Boric oxide, a weak acid anhydride, has been reported to form the compound $B_2O_3 \cdot BF_3$.⁽⁷⁴⁸⁾ Baumgarten and Bruns⁽⁵¹⁾ later postulated that this compound did not exist as an addition compound, but rather as a trimer of BOF. They have offered the following ring structure:

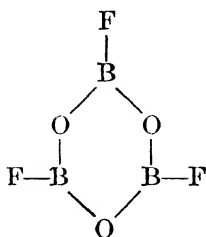

Davy⁽¹⁹⁹⁾ observed in the generation of boron trifluoride from fluorspar, calcined boric oxide, and sulfuric acid, that "when the gas ceases to come over, if the temperature is raised, more will be evolved, and there will be distilled over at the same time a viscid fluid, which is a compound of sulphuric and fluoboracic acid gas." He observed that 1 volume of sulfuric acid dissolved 50 volumes of boron trifluoride gas, becoming quite viscous, which approximates 1 molecule of H_2SO_4 to 1 molecule of BF_3 .

Salts of sulfuric acid have been found to form compounds with boron trifluoride, such as $Na_2SO_4 \cdot BF_3$, $K_2SO_4 \cdot BF_3$, $Cs_2SO_4 \cdot 2BF_3$, and $Tl_2SO_4 \cdot BF_3$.^(53, 54) Burg and Rose⁽¹⁴⁷⁾ report that a compound of somewhat similar molecular structure, sulfuryl chloride, does not react with boron trifluoride at $-45.7^\circ C$.

Nitric acid has been reported to dissolve large quantities of boron trifluoride, but compound formation has not been established.⁽⁴⁷⁶⁾ Although nitrous oxide forms no compound with boron trifluoride^(95, 476) (see Figure 4-4), Kuhlmann⁽⁴⁷⁶⁾ reported that boron trifluoride reacts with nitrogen dioxide to give a relatively stable compound though no analysis is given. Germann and Booth⁽²⁹⁹⁾ found that nitric oxide impurity in pyrosulfuric acid used in preparation of boron trifluoride gave a gas which on condensation by means of liquid air was of a red color, which was thought to be due to a compound of the nitric oxide and the boron fluoride.

Recently Finlay⁽²⁶³⁾ has found that the compound, $NO \cdot BF_3$, a bright orange-colored solid melting to a dark-purple-red liquid at

$-130^{\circ}\text{C}.$, which evaporates (decomposes) at -111° to form a colorless mixture, can be made by cooling an equimolecular mixture of NO and BF_3 in a sealed tube. Further studies should be made on the action of boron trifluoride on the other oxides of nitrogen.

Compounds of boron trifluoride with phosphoric acids (H_3PO_4 and $\text{H}_4\text{P}_2\text{O}_7$) have been reported also.^(262, 409, 783) Recently the

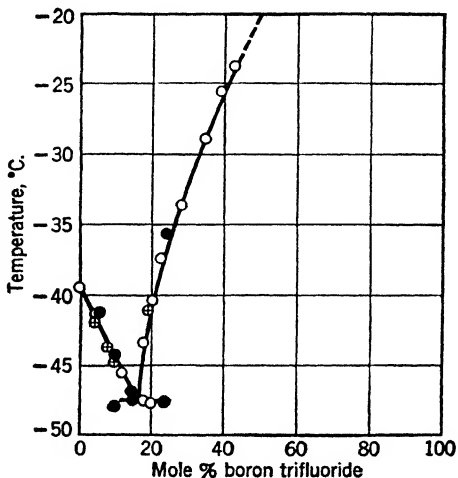

FIG. 4-8. The system phosphoryl fluoride-boron trifluoride
(Courtesy *Journal of the American Chemical Society*)

compound, $\text{H}_3\text{PO}_4 \cdot \text{BF}_3$, sp. gr. 1.932, molecular weight 165.8, freezing point $105^{\circ}\text{C}.$, viscosity 0.467 poise at $20^{\circ}\text{C}.$, has been isolated.^(894a) Similarly $\text{H}_4\text{P}_2\text{O}_7 \cdot 2\text{BF}_3$ (sp. gr. 1.950, mol. wt. 313.7, f. pt. $82^{\circ}\text{C}.$, viscosity 1.23 poises at $20^{\circ}\text{C}.$) has been established.^(894a)

Germann and Booth⁽²⁹⁹⁾ thought a reaction occurred between boron trifluoride and the anhydride of these phosphoric acids, P_2O_5 . This reaction was studied and 1 mole of phosphorus pentoxide was found to absorb almost 2 moles of boron trifluoride. It was later found that crystalline phosphorus pentoxide, free from metaphosphoric acid, would not absorb boron trifluoride.⁽³¹⁷⁾

The salts of these phosphoric acids, like the salts of sulfuric acid, form compounds with boron trifluoride. Thus $\text{Na}_3\text{PO}_4 \cdot 3\text{BF}_3$, $\text{K}_3\text{PO}_4 \cdot 3\text{BF}_3$, $\text{Na}_4\text{P}_2\text{O}_7 \cdot 4\text{BF}_3$, and $\text{K}_4\text{P}_2\text{O}_7 \cdot 4\text{BF}_3$ have been reported.⁽⁵³⁾

A compound related to these acids, phosphoryl fluoride, POF_3 , was found by Booth and Walkup^(98, 984) to coordinate with BF_3 to form the compound $\text{POF}_3 \cdot \text{BF}_3$ (see Figure 4-8). A saturated solution of phosphoryl chloride in light petroleum ether, on the contrary, has been reported by Burg and Ross to be unreactive with boron trifluoride at -80°C .⁽¹⁴⁷⁾

The physical constants of these compounds so far as published are given in Table 14.

TABLE 14

PROPERTIES OF COORDINATION COMPOUNDS OF BORON TRIFLUORIDE AND OXYGEN COMPOUNDS

Compound	Melting Point, $^\circ\text{C}$.	Boiling Point, $^\circ\text{C}$.	Reference
Oxygen			
$\text{H}_2\text{O} \cdot \text{BF}_3$	5.4-6	584, 589
	4.5	62 ₂ mm.	460
$2\text{H}_2\text{O} \cdot \text{BF}_3$	4.6-5.0	58.5-60 _{1,2}	584, 589
	46 _{4,6-5}	584, 589
	5.9-6.1	565
$\text{C}_4\text{H}_8\text{O}_2 \cdot \text{H}_2\text{O} \cdot \text{BF}_3$	128-130 (decomp.)	589
$\text{C}_4\text{H}_8\text{O}_2 \cdot 2\text{H}_2\text{O} \cdot \text{BF}_3$	142	584, 589
$2\text{C}_{10}\text{H}_{18}\text{O} \cdot \text{H}_2\text{O} \cdot \text{BF}_3$	71.3	589
$2\text{C}_{10}\text{H}_{18}\text{O} \cdot 2\text{H}_2\text{O} \cdot \text{BF}_3$	59.5-61	589, 594
$\text{POF}_3 \cdot \text{BF}_3$	-20 (cir.)	98, 934
Sulfur			
$\text{H}_2\text{S} \cdot \text{BF}_3$	-137.0	299
$\text{SO}_2 \cdot \text{BF}_3$	-96.0	95
$\text{SOF}_2 \cdot \text{BF}_3$	-140.8	98, 934

INORGANIC SULFUR COMPOUNDS

Germann and Booth⁽²⁹⁹⁾ studied the system $\text{H}_2\text{S}-\text{BF}_3$ and found the compound $\text{H}_2\text{S} \cdot \text{BF}_3$. See Figure 4-9.

Booth and Martin⁽⁹⁵⁾ reported the compound formed by sulfur dioxide and boron trifluoride, $\text{SO}_2 \cdot \text{BF}_3$, which freezes at -96°C . From the shape of the maximum obtained, it was concluded that the compound is somewhat dissociated above the melting point (see Figure 4-10). While it is possible that one of the oxygen atoms is the donor, when the atomic structure of sulfur dioxide is compared with nitrous oxide, it is apparent that the oxygen atoms in both compounds are similarly attached and, therefore, might behave somewhat similarly. However, nitrous oxide does not coordinate; therefore, the difference may lie in the central atom,

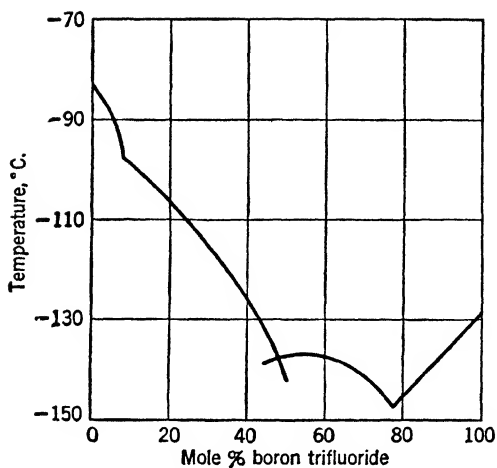

FIG. 4-9. The system hydrogen sulfide-boron trifluoride
(Courtesy *Journal of Physical Chemistry*)

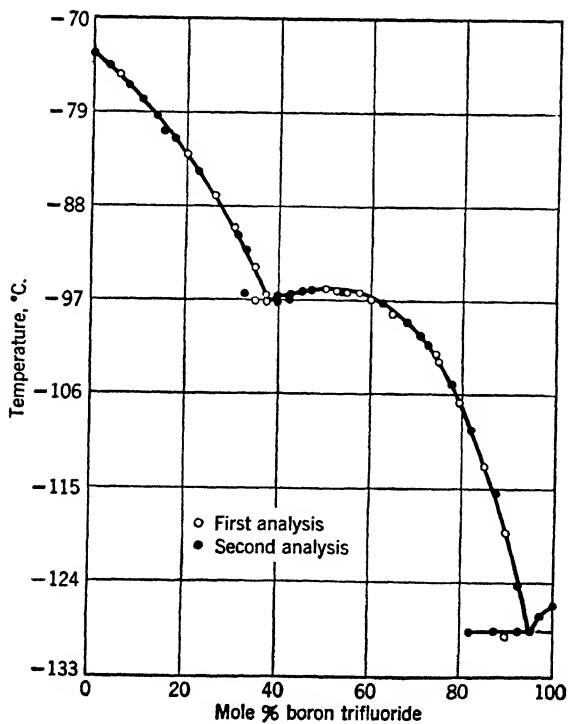

FIG. 4-10. The system sulfur dioxide-boron trifluoride
(Courtesy *Journal of the American Chemical Society*)

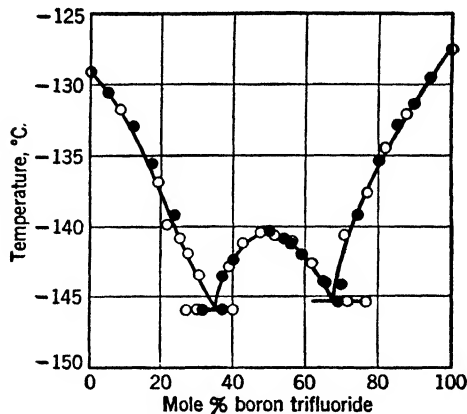

FIG. 4-11. The system thionyl fluoride-boron trifluoride
(Courtesy *Journal of the American Chemical Society*)

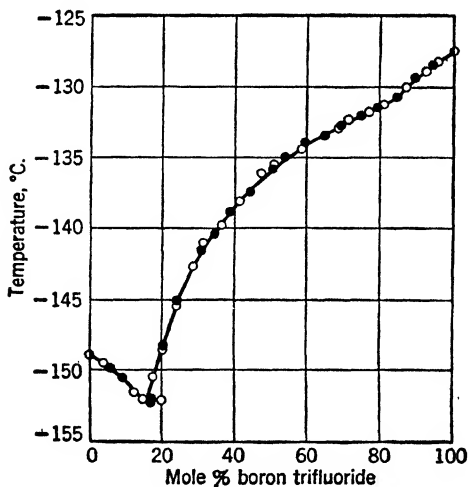

FIG. 4-12. The system thiophosphoryl fluoride-boron trifluoride
(Courtesy *Journal of the American Chemical Society*)

where N has no unshared electrons, while S has a pair of unshared electrons.

Replacement of an oxygen atom of sulfur dioxide by two fluorine atoms to form a compound SOF_2 does not affect the coordinating power of the sulfur atom to any great extent, as the compound

$\text{SOF}_2 \cdot \text{BF}_3$, freezing at -140.8°C ., has been established^(98, 934) (see Figure 4-11). According to Burg and Ross⁽¹⁴⁷⁾ thionyl chloride and boron trifluoride do not react at -80°C .

Booth and Walkup made a thermal analysis of the system $\text{PSF}_3\text{-BF}_3$ and found no indication of compound formation^(98, 934) (see Figure 4-12). POF_3 coordinates with BF_3 , and, therefore, in the light of the similar electronic configurations, it seems strange that PSF_3 does not.

ORGANIC OXYGEN COMPOUNDS

Addition compounds between boron trifluoride and organic oxy compounds are well known. Landolph^(487, 488) in 1878 announced the rule that boron trifluoride combines in definite proportions, equivalent for equivalent, with aldehydes, ketones, and carbonyls. As may be seen presently, this rule could now be broadened to include a much larger group of organic compounds. Gasselin⁽²⁸²⁾ in 1894 stated that the presence of oxygen in an organic molecule (even saturated compounds) is a favorable condition for the formation of coordination compounds with boron trifluoride. In the following, the oxygen atom in the compound is probably the donor.

It will be most convenient to discuss the reaction products of boron trifluoride with organic compounds under the following headings: alcohols, aldehydes, ketones, and acids; and finally, the mixed types, ethers, acid anhydrides, and esters.

Alcohols. A number of chemists have mentioned the reaction between alcohol and boron trifluoride, but it was Gasselin⁽²⁸²⁾ who first made an effort to isolate the reaction products. He thought he obtained H_3COBF_2 and $(\text{CH}_3\text{O})_2\text{BF}$ with methyl alcohol⁽²⁸³⁾ and $\text{H}_5\text{C}_2\text{OBF}_2$ and " $[\text{BF}_3 + (\text{C}_2\text{H}_5)_2\text{O}]$ " with ethyl alcohol.⁽²⁸⁶⁾ For Gasselin to obtain these compounds, hydrogen fluoride would have had to have been liberated, but the alcohol compounds were found not to attack glass. Earlier it had been claimed that boron trifluoride reacted with alcohol to produce ethers.^(477, 511)

All alcohols were found by Bowlus and Nieuwland⁽¹⁰⁷⁾ to absorb slightly more than 1 mole of boron trifluoride.

$\text{CH}_3\text{OH} \cdot \text{BF}_3$ was reported by that laboratory, and a mercuric derivative of this compound, mercuric methoxyfluoborate, with the suggested structure $\text{Hg}(\text{CH}_3\text{OBF}_3)_2$, was isolated.⁽⁶⁷⁸⁾ It was postulated that the acidic substance formed when boron trifluoride

is passed into methyl alcohol is a coordination compound in which the oxygen of the alcohol shares a pair of electrons with the boron of boron trifluoride, thus rendering the oxygen atom more positive and weakening the O—H bond, causing ionization.⁽⁹¹⁵⁾ $C_2H_5OH \cdot BF_3$ was reported by them from a thermal analysis made on that system, and analogous compounds were postulated for methyl and normal butyl alcohols.⁽¹⁰⁷⁾

Meerwein has formed the corresponding dialcoholates, $BF_3 \cdot 2CH_3OH$ and $BF_3 \cdot 2C_2H_5OH$. He has claimed that two alcohol hydroxyl groups are required for each mole of boron trifluoride, as indicated by $BF_3 \cdot 2-n-C_3H_7OH$ and $BF_3 \cdot 2-n-C_4H_9OH$.^(584, 589) The addition of boron trifluoride dihydrate to propylene gives boron trifluoride-diisopropylate.⁽⁵⁸⁹⁾

Isobutyl and higher alcohols have been reported to form addition compounds with boron trifluoride.^(227, 723)

The substitution of chlorine for the hydrogens of the alkyl group affects the stability of the resulting addition compound. $BF_3 \cdot 2CH_2ClCH_2OH$ is more stable than $BF_3 \cdot 2CCl_3CH_2OH$.⁽⁵⁸⁹⁾

One mole of glycol reacts with 1 mole of boron trifluoride, forming $BF_3 \cdot HOH_2CCH_2OH$.⁽⁵⁸⁹⁾ Gasselin⁽¹⁷⁰⁾ also studied the reaction of boron trifluoride on glycol and glycerine but could not isolate the products of the reaction.

An alcoholic group on a chain, such as cetyl alcohol, was found to react with boron trifluoride, but the reaction products could not be isolated.⁽²⁸²⁾

Meerwein also claimed that secondary propyl alcohol reacts with boron trifluoride to form the compound $BF_3 \cdot 2CH_3 \cdot CHOH \cdot CH_3$, which readily decomposes on distillation, yielding an olefin and boron trifluoride dihydrate.⁽⁵⁸⁹⁾

Aromatic alcohols, like the aliphatic alcohols, form dialcoholates with boron trifluoride. Cannizzaro⁽¹⁷¹⁾ tried the reaction between boron trifluoride and benzyl alcohol as early as 1854 and thought he obtained stilbene as a product. Benzyl alcohol-boron trifluoride $BF_3 \cdot 2C_6H_5 \cdot CH_2 \cdot OH$ has been reported by Meerwein and Pannwitz.⁽⁵⁸⁹⁾ However, they stated this addition compound decomposed after a short time into boron trifluoride-monohydrate and a hydrocarbon of higher molecular weight, perhaps the same product obtained earlier by Cannizzaro.

Since we are interested in the oxygen in the hydroxyl group, phenol will be considered at this point. Gasselin⁽²⁸²⁾ reported that

monoatomic phenols because of their structure were not attacked by boron trifluoride but thought 2 moles of phenol dissolved 1 mole of boron trifluoride; however, Sowa, Hinton, and Nieuwland⁽⁸²⁵⁾ found that 1 mole of phenol would dissolve 1 mole of boron trifluoride. Later Meerwein and Pannwitz⁽⁵⁸⁹⁾ reported the compound $\text{BF}_3 \cdot 2\text{C}_6\text{H}_5\text{OH}$ which is a confirmation of the work of Gasselin.

Gasselin found that thymol and resorcinol dissolved boron trifluoride, the latter being polymerized and dehydrated as a result of the two hydroxyl groups in the molecule.⁽²⁸²⁾

Meerwein and Pannwitz⁽⁵⁸⁹⁾ have made the observation that the stability of boron trifluoride-alcohol complexes is decreased if a polar or easily polarizable group, such as CH_2Cl , CCl_3 , or C_6H_5 , is in the immediate proximity of the hydroxyl group.

A reaction product of boron trifluoride with an alcohol, alcohol ether, or cyclic ether has been patented for use alone or in various mixtures as a solder flux.^(612, 616)

The available physical constants of the afore-mentioned alcohol coordination compounds are listed in Table 15.

TABLE 15

PHYSICAL CONSTANTS OF ALCOHOL— BF_3 COORDINATION COMPOUNDS

Compound	Melting Point, °C.	Boiling Point, °C.	d_4^{20}	$n_{\text{He}}^{(t^\circ)}$	Mol. Refraction MR_{He}	Reference
$\text{CH}_3\text{OH} \cdot \text{BF}_3$	-19.4	678
$\text{C}_2\text{H}_5\text{OH} \cdot \text{BF}_3$	-19	107
$(\text{CH}_2\text{OH})_2 \cdot \text{BF}_3$	40-44	584, 589
Dialcoholates						
$2\text{CH}_3\text{OH} \cdot \text{BF}_3$	58.94 mm.	1.3115	1.30702 (18°)	19.22	584, 589
$2\text{C}_2\text{H}_5\text{OH} \cdot \text{BF}_3$	60 ₄ ; 51-52 ₁₅ mm.	1.1638	1.33444 (19.7°)	28.17	584, 589
$2\text{C}_3\text{H}_7\text{OH} \cdot \text{BF}_3$	56 ₂	1.1059	1.36150 (20°)	37.65	584, 589
$2\text{C}_4\text{H}_9\text{OH} \cdot \text{BF}_3$	64.5-70 ₃ mm.	1.0442	1.37317 (20.2°)	47.11	584, 589
$2\text{CH}_2\text{ClCH}_2\text{OH} \cdot \text{BF}_3$	592-592.5	1.4009	1.40841	584, 589
$2\text{CCl}_3\text{CH}_2\text{OH} \cdot \text{BF}_3$	40-42	Decomposes	589

Aldehydes. Acetaldehyde and valeric aldehyde were found to react equivalent for equivalent with boron trifluoride.⁽⁴⁸⁷⁾ The compound with acetaldehyde, $\text{CH}_3\text{CHO} \cdot \text{BF}_3$, has been confirmed

by Brown, Schlesinger, and Burg.⁽¹¹⁵⁾ These investigators also studied the effect of the substitution of methyl groups and chlorine for the hydrogens on the methyl group of acetaldehyde and reported trimethylacetaldehyde-boron trifluoride, $(\text{CH}_3)_3\text{CCHO}\cdot\text{BF}_3$, and chloral-boron trifluoride, $\text{Cl}_3\text{CCHO}\cdot\text{BF}_3$. Landolph⁽⁴⁸⁰⁾ thought he obtained metachloral from chloral and boron trifluoride.

Substitution of a benzyl group in place of the methyl group seemingly does not affect the donating power of the oxygen to any great extent, since benzyl aldehyde combines equivalent for equivalent with boron trifluoride, according to Landolph.^(480, 486, 487)

Ketones. Most of the studies with ketones have been carried out with acetone. In support of his rule, Landolph found that chemically pure acetone combined equivalent for equivalent with boron trifluoride.^(481, 487) However, the products which he listed were not addition compounds with boron trifluoride, one of them being "ethylene fluoborate, $\text{C}_2\text{H}_5\text{BFO}_2$."⁽⁴⁸¹⁾ Gasselín^(282, 288) also studied this reaction and reported $(\text{CH}_3)_2\text{CO}\cdot\text{BF}_3$ (b. pt. 35°C .), which on decomposition gave ketones and hydrocarbons. He suggested that Landolph's compounds owed their origin to the presence of methyl alcohol and ethyl ether in the acetone.^(287, 288)

Brown, Schlesinger, and Burg have reported that "boron trifluoride adds to the carbonyl groups of acetone, acetaldehyde, trimethylacetaldehyde, chloral, and acetyl chloride to form complex compounds whose relative stabilities measure the electron donor properties of the carbonyl group in these substances."⁽¹¹⁵⁾

Landolph reported that methyl nonyl ketone and camphor also supported his rule^(480, 484, 487) but offered no formula for his products.

Morgan and Tunstall⁽⁶⁴¹⁾ tried reactions between β -diketones and boron trifluoride and reported that hydrogen fluoride was evolved and that a ketone difluoride was formed, such as boron benzoylacetone difluoride. On the contrary, Meerwein and Vossen⁽⁵⁹⁰⁾ reported that benzoylacetone and boron trifluoride gave a one-to-one compound.

Acids. Beginning with the aliphatic compounds, we find there have been reported two series of addition compounds with boron trifluoride. These are $\text{BF}_3\cdot\text{RCOOH}$ and $\text{BF}_3\cdot 2\text{RCOOH}$. The analogy to the mono- and dihydrates and the mono- and dialcohols is apparent. In all of these compounds, the donor molecule is associated to form a dimer in which one of the oxygen atoms

probably acts as a donor to boron trifluoride. Formic acid and boron trifluoride form compounds in both series, $\text{BF}_3 \cdot \text{HCOOH}$ and $\text{BF}_3 \cdot 2\text{HCOOH}$.⁽⁵⁸⁹⁾ The latter compound rapidly decomposes at 75°C . to give $2\text{H}_2\text{O} \cdot \text{BF}_3$ and CO .

Landolph⁽⁴⁸⁰⁾ stated that boron trifluoride exercised a dehydrating effect on acetic acid and that some acetic anhydride was formed. Meerwein found that boron trifluoride acted on acetic acid to produce a compound $(\text{BF}_3\text{OCOCH}_3)_3\text{H}$.⁽⁵⁸³⁾ If one may judge from the data given, this undoubtedly is a misprint and should read $(\text{BF}_3\text{OCOCH}_3)\text{H}$. Later he reported a compound $\text{BF}_3 \cdot \text{CH}_3\text{COOH}$.^(584, 589) The acetic acid compound in the second series, $\text{BF}_3 \cdot 2\text{CH}_3\text{COOH}$, has also been isolated.^(107, 371, 584, 589, 820)

The coordination compounds between the chloroacetic acids and boron trifluoride have been studied.^(107, 584, 589) It is of interest that $\text{BF}_3 \cdot 2\text{CH}_2\text{ClCOOH}$ is stable at room temperature, whereas the dichloroacetic acid compound decomposes at room temperature, and trichloroacetic acid will only absorb boron trifluoride at low temperatures.

Another chlorine derivative of acetic acid, formed by the replacement of the hydroxyl radical of the carboxyl group by chlorine, acetyl chloride, forms an addition compound with boron trifluoride. Meerwein and Maier-Hüser⁽⁵⁸⁸⁾ reported it in 1932 and postulated that the formula for this compound should be $\text{CH}_3\text{COCl} \cdot \text{BF}_3$, with the chlorine atom donating to the boron atom. However, Brown, Schlesinger, and Burg⁽¹¹⁵⁾ later made a study of the compounds formed between compounds containing carbonyl groups and boron trifluoride and arrived at the conclusion that the carbonyl oxygen of acetyl chloride was donating to the boron in acetyl chloride-boron trifluoride, $\text{CH}_3\text{CClO} \cdot \text{BF}_3$. In view of the certainty that in CH_3COBF_4 it is the F atom of the acetyl fluoride which is the donor,⁽⁶¹⁷⁾ it is probably the Cl atom in acetyl chloride which is the donor.

Propionic acid was found by Bowlus and Nieuwland⁽¹⁰⁷⁾ to absorb 1 mole of boron trifluoride. Later Meerwein and Pannwitz reported $\text{BF}_3 \cdot \text{C}_2\text{H}_5\text{COOH}$ and $\text{BF}_3 \cdot 2\text{C}_2\text{H}_5\text{COOH}$.⁽⁵⁸⁹⁾

Normal butyric acid adds either 1 or 2 moles to boron trifluoride to form the compounds $\text{BF}_3 \cdot n\text{-C}_3\text{H}_7\text{COOH}$ and $\text{BF}_3 \cdot 2n\text{-C}_3\text{H}_7\text{COOH}$.⁽⁵⁸⁹⁾ Two moles of isobutyric acid add to 1 mole of boron trifluoride to give the compound $\text{BF}_3 \cdot 2\text{-}i\text{-C}_3\text{H}_7\text{COOH}$.⁽⁵⁹⁰⁾

An unsaturated aliphatic acid, crotonic acid, has been found to form addition compounds in both of these series. These are $\text{BF}_3 \cdot \text{H}_3\text{CCH}=\text{CHCOOH}$ and $\text{BF}_3 \cdot 2\text{H}_3\text{CCH}=\text{CHCOOH}$.⁽⁵⁸⁹⁾

Reactions of boron trifluoride with polycarboxylic acids have been studied also. Oxalic acid-boron trifluoride, $\text{BF}_3 \cdot (\text{COOH})_2$, maleic acid-boron trifluoride, $\text{BF}_3 \cdot (\text{HCCOOH})_2$, and succinic acid-boron trifluoride, $\text{BF}_3 \cdot (\text{H}_2\text{CCOOH})_2$, are known.⁽⁵⁸⁹⁾

A German patent⁽³³⁶⁾ in describing "acidatofluoboric acids" and their salts stated that boron trifluoride was caused to react with glacial acetic acid, which on cooling gave acetofluoboric acid (b. pt.₁₄ 62°C.). This must be the same compound which Meerwein⁽⁵⁸³⁾ described, $(\text{BF}_3\text{OCOCH}_3)\text{H}$, which boiled at 59°C. under 13 mm. pressure. The patent went on to state that salts were formed by this acid on neutralization with KOH, NaOH, MgO, NH_4OH , etc. Other examples in the patent described the preparation of chloracetofluoboric acid, lactatofluoboric acid, oleatofluoboric acid, and benzoatofluoboric acid. By analogy, one would expect these acids to be one-to-one addition compounds between the respective acids and boron trifluoride.

In the aromatic series of acids, benzoic acid has been found to give only one compound. Bowlus and Nieuwland⁽¹⁰⁷⁾ reported that benzoic acid absorbed 1 mole of boron trifluoride, and Meerwein and Pannwitz⁽⁵⁸⁹⁾ later isolated $\text{BF}_3 \cdot \text{C}_6\text{H}_5\text{COOH}$ as a crystalline solid. The latter investigators also isolated phenylacetic acid-boron trifluoride, $\text{BF}_3 \cdot \text{C}_6\text{H}_5\text{CH}_2\text{COOH}$.

Salicylic acid absorbs boron trifluoride and probably similarly forms a coordination covalent compound with the hydroxyl oxygen of the carboxyl group, this coordination making condensation possible by causing the hydrogen of the carboxyl group to become more labile. There is "a greater tendency for boron trifluoride to coordinate with the carboxy or carbalkoxy than with the phenolic group."⁽¹⁸⁶⁾

Meerwein and Pannwitz have observed that the stability of the boron trifluoride-acid complexes is decreased if a polar or easily polarizable group is in the neighborhood of the carboxyl group.⁽⁵⁸⁹⁾

Miller⁽⁶¹⁴⁾ has patented the use of boron trifluoride-organic acid complexes as noncorrosive solder fluxes.

The known melting and boiling points of these compounds are given in Table 16.

TABLE 16
 KNOWN PHYSICAL CONSTANTS OF COORDINATION COMPOUNDS OF BF_3 WITH ORGANIC ACIDS

Compounds	Melting Point, °C.	Boiling Point, °C.	Long needles Rhombic Fine needles Needles Lancet-shaped plates	d_4^{20}	$n_{\text{He}}(^{\circ})$	Reference
$\text{HCOOH} \cdot \text{BF}_3$	-20-21	589
$\text{CH}_3\text{COOH} \cdot \text{BF}_3$	+23-24 *	59 ₁₃ ; 62 ₁₁	583, 589, 590
$\text{C}_2\text{H}_5\text{COOH} \cdot \text{BF}_3$	+28-29	589
$n\text{-C}_4\text{H}_9\text{COOH} \cdot \text{BF}_3$	+29-30	589
$\text{CH}_3\text{CH}:\text{CHCOOH} \cdot \text{BF}_3$	+35-36	589
$\text{C}_6\text{H}_5\text{COOH} \cdot \text{BF}_3$	+90-91.5 (decomp.)	589, 107
$\text{C}_6\text{H}_5\text{CH}_2\text{COOH} \cdot \text{BF}_3$	+56-59 (decomp.)	589
$2\text{HCOOH} \cdot \text{BF}_3$	43-44 ₁₁	(Mol. Refraction - M_{RHe})	1.5145	1.35720 (21.1°)	589
$2\text{CH}_3\text{COOH} \cdot \text{BF}_3$	53-54 ₁₆ ; 140 ₇₄₆ ; 142	28.15	1.3421	1.36915 (21.1°)	107, 589, 820
$2\text{C}_2\text{H}_5\text{COOH} \cdot \text{BF}_3$	60-60.5 ₁₃ ; 62-63 ₁₇	31.62	1.2383	1.38070 (21.6°)	107, 589
$2n\text{-C}_3\text{H}_7\text{COOH} \cdot \text{BF}_3$	64 ₁₁	40.83	1.1506	1.38840 (21.8°)	589
$2i\text{-C}_3\text{H}_7\text{COOH} \cdot \text{BF}_3$	68-70 ₁₅	50.14	590
$2\text{CH}_3\text{CH}:\text{CHCOOH} \cdot \text{BF}_3$	81-82 _{13,4}} (with decomp.)	589
$(\text{COOH})_2 \cdot \text{BF}_3$	57-58 (decomp.)	589
$(\text{CHCOOH})_2 \cdot \text{BF}_3$	75-82	589
$(\text{CH}_2\text{COOH})_2 \cdot \text{BF}_3$	82-84 (decomp.)	589

* Dr. C. F. Swinehart (private communication) reports this compound melts at 38-39°C.

Ethers. Dimethyl ether and boron trifluoride were found by Gasselin^(282, 283) to form a compound, $\text{BF}_3 \cdot \text{O}(\text{CH}_3)_2$. This compound was later indentified also by thermal analysis by Germann and Cleaveland^(179, 300) (see Figure 4-13). Recently the molecular structure of this compound has been established.^(48, 49) Many of its physical properties have been reported^(114, 494) (see Table 17). The dietherate, $\text{BF}_3 \cdot 2 \text{O}(\text{CH}_3)_2$ has also been reported.

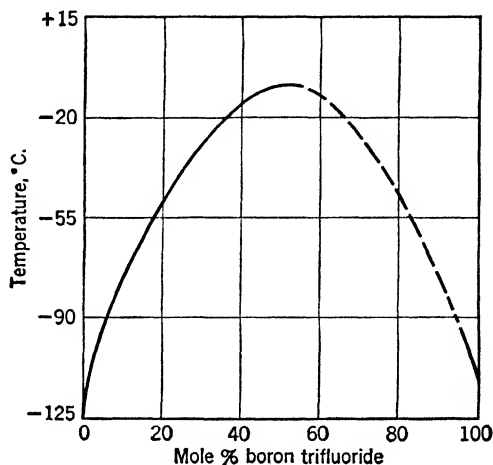

FIG. 4-13. The system dimethyl ether-boron trifluoride

Raman and ultraviolet spectra of $(\text{CH}_3)_2\text{O} \cdot \text{BF}_3$ were determined by Dunderman and Bauer⁽²¹⁹⁾ in order to measure the effect of coordination on vibrational frequencies of the parent molecules and the ease of excitation of the electrons associated with the C—O bond. The Raman lines obtained were 328, 496, 666, 804, 918, 1014, 1085, 1216, 1267, 1309, 1454, 2977, and 3035 cm^{-1} . None of the strongest Raman lines appears in the parent substances. In the ultraviolet absorption a faint band begins at a wave length longer than in ether, and the intensity of absorption by the complex is much lower in the region $\lambda 2300$, where ethers begin to absorb strongly.

Diethyl ether-boron trifluoride was reported also by Gasselin.^(282, 284) More recent workers have studied many of its physical properties^(113, 494, 670, 879, 948) (see Table 17).

TABLE 17⁽⁴⁹⁴⁾PHYSICAL PROPERTIES OF COMPOUNDS OF BF_3 WITH ETHERS

	$\text{Me}_2\text{O}\cdot\text{BF}_3$	$\text{MeEtO}\cdot\text{BF}_3$	$\text{Et}_2\text{O}\cdot\text{BF}_3$
M. pt., °C.	-14	-98	-60.4
B. pt., °C.	126.6	127	125.7
d_{25}^{25}	1.239 *	1.176	1.125
n_D^{20}	1.302	1.327	1.348
Obs. molar vol.	102.1	120.7	139.9
Obs. parachor	220.6	256.2	294.6
Obs. molar refraction	17.60	22.04	26.63
V. p. log p mm. =	$\frac{-2650}{T} + 9.58$	$\frac{-2860}{T} + 10.05$	$\frac{-2845}{T} + 10.02$
Ht. of vap., cal.	12,200	13,200	13,100
Trouton const.	30.5	33.0	32.8
Ht. of dissoc., cal.	13,000-13,300 †
	$\text{BF}_3 (g)$	$\text{Me}_2\text{O}\cdot\text{BF}_3 (l)$	$\text{MeEtO}\cdot\text{BF}_3 (l)$
Hts. of soln., cal. at 0°C. in H_2O	21,900 ± 200	7500
Hts. of soln., cal. at 0°C. in Et_2O	17,300 ± 400	2700 ± 500
Hts. of vap., cal.	8800	8800
Hts. of form., cal.	13,900 ± 700	12,500 ± 1000
Dipole moments in C_6H_6 at 25°C.	4.35 ± 0.12	5.07 ± 0.08	4.92 ± 0.38

* Sugden and Waloff⁽⁸⁷⁹⁾ established the equation for the density to be $D_4^{20} = 1.264 - 0.00116t$ from densities determined at various temperatures between 20° and 49°C. They found the surface tension to be 33.03 at 20.5°, 32.10 at 27.5°, 31.38 at 34.5°, 30.91 at 41°, and 28.84 at 59°.

† Reference 114.

The compound comprised of 2 moles of diethyl ether to 1 mole of boron trifluoride, $\text{BF}_3 \cdot 2 \text{O}(\text{C}_2\text{H}_5)_2$, is listed by Meerwein and Pannwitz.⁽⁵⁸⁹⁾

Methyl ethyl ether-boron trifluoride, $\text{BF}_3 \cdot \text{O}(\text{CH}_3)(\text{C}_2\text{H}_5)$, was reported by Meerwein and his coworkers in 1937.⁽⁵⁸⁷⁾ Many of its physical properties have been reported⁽⁴⁹⁴⁾ (see Table 17).

Methyl amyl ether-boron trifluoride, $\text{BF}_3 \cdot \text{O}(\text{CH}_3)(\text{C}_5\text{H}_{11})$, has also been reported.⁽⁵⁸⁸⁾

Ascending the aliphatic series, we find that normal propyl ether and boron trifluoride form the compounds $\text{BF}_3 \cdot (n\text{-C}_3\text{H}_7)_2\text{O}$ ⁽⁵⁸⁶⁾ and $\text{BF}_3 \cdot 2(n\text{-C}_3\text{H}_7)_2\text{O}$.⁽⁵⁸⁹⁾

Isopropyl ether and boron trifluoride form the solid $(i\text{-C}_3\text{H}_7)_2\text{O} \cdot \text{BF}_3$.⁽¹¹³⁾ Isopropyl methyl ether-boron trifluoride also has been listed, $(\text{CH}_3)_2\text{CH} \cdot \text{CH}_3 \cdot \text{O} \cdot \text{BF}_3$.⁽⁵⁸⁹⁾

Bruson^(128, 129) reports the use of n -dibutyl ether-boron trifluoride, $(\text{C}_4\text{H}_9)_2\text{O} \cdot \text{BF}_3$, as a catalyst in the synthesis of complex ethers.

Tetrahydrofuran forms the liquid $C_4H_8O \cdot BF_3$. It has been observed that the basic strengths of the ether $\rightarrow BF_3$ complexes decrease in the order of tetrahydrofuran, methyl, ethyl, and isopropyl.⁽¹¹³⁾

Some interesting compounds have been isolated from reactions of boron trifluoride complexes with olefin ethers, such as ethylene oxide and epichlorohydrin. Methyl ether-boron trifluoride and ethyl ether-boron trifluoride with epichlorohydrin at $-80^\circ C$. produce the compounds, $(CH_3)_2O^+ \cdot CH_2 \cdot CH(CH_2Cl) \cdot O \cdot \bar{B}F_3$ and $(C_2H_5)_2O^+ \cdot CH_2 \cdot CH(CH_2Cl) \cdot O \cdot \bar{B}F_3$, respectively, the latter one being very unstable. The very unstable compounds $B[O(CH_2)_2Cl]_3 \cdot 2BF_3$ and $B(OC_6H_5)_3 \cdot 2BF_3$ are produced when the β -chloroethyl ester of boric acid and the phenyl ester of boric acid, respectively, react with boron trifluoride.⁽⁵⁸⁶⁾

O'Connor and Sowa⁽⁶⁷⁷⁾ have studied the alkylation of benzene with ethers in the presence of boron trifluoride. They believed that the ethers formed coordination compounds with boron trifluoride, such as normal amyl ether-boron trifluoride, $BF_3 \cdot O(n-C_5H_{11})_2$, as an intermediate step. They studied this reaction with diisopropyl, isopropyl phenyl, dibenzyl, benzyl ethyl, isoamyl, normal amyl, and diethyl ethers.

The monomethyl ether of glycol acetate absorbed 2 moles of boron trifluoride, whereas anisole and phenetole absorbed only 1 mole of boron trifluoride in some studies carried out by Bowlus and Nieuwland.⁽¹⁰⁷⁾ Later Meerwein and Maier-Hüser isolated $BF_3 \cdot CH_3OC_6H_5$ and $BF_3 \cdot C_2H_5OC_6H_5$.⁽⁵⁸⁸⁾

Another compound, similar to anisole and phenetole in that the ether is made up of an alkyl group and an aryl group, anethole, was found by Landolph^(480, 482, 485) to absorb large quantities of boron trifluoride. At room temperature anethole was instantly polymerized by boron trifluoride, while at its boiling temperature the reaction gave anisole, C_7H_8O , and another substance, $C_{11}H_{16}O$ (b. pt. $225-228^\circ$), having an odor similar to that of camphor.

It is interesting to note that attempts to form coordination compounds with aromatic ethers and boron trifluoride have failed. Bowlus and Nieuwland⁽¹⁰⁷⁾ and Meerwein and Maier-Hüser⁽⁵⁸⁸⁾ have tried diphenyl ether with boron trifluoride with no success. This probably is due to steric hindrance.

In the formation of acetals, the following reaction has been assumed by Bowlus and Nieuwland⁽¹⁰⁷⁾ in which the complex compound with boron trifluoride is an ether:

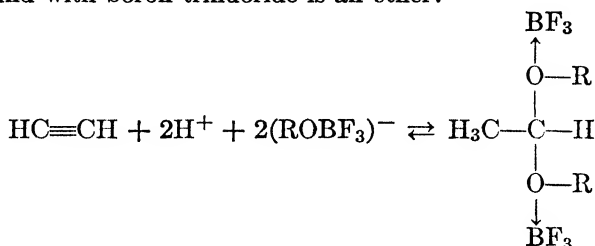

This complex then breaks up to give the acetal and boron trifluoride.

Table 18 lists the physical properties of the known boron trifluoride-ether compounds.

TABLE 18

PHYSICAL PROPERTIES OF BORON TRIFLUORIDE-ETHER COMPOUNDS

Compound	Melting Point	Boiling Point	d_4^{25}	Reference
$(\text{CH}_3)_2\text{O}\cdot\text{BF}_3$	-10 to -14	126-128	1.264 - 0.00116 l	113, 179, 284, 287, 462, 494, 879
$(\text{CH}_3)(\text{C}_2\text{H}_5)\text{O}\cdot\text{BF}_3$	-98	127	494
$(\text{C}_2\text{H}_5)_2\text{O}\cdot\text{BF}_3$	-50 to -52; -60.4	123-125.7	1.150 - 0.00108 l	113, 440, 494, 670, 879
$(i\text{-C}_3\text{H}_7)_2\text{O}\cdot\text{BF}_3$	68	113
$(\text{CH}_3)(\text{C}_2\text{H}_5)\text{O}\cdot\text{BF}_3$	-98	127	494
$(\text{CH}_3)(\text{C}_6\text{H}_{11})\cdot\text{O}\cdot\text{BF}_3$	-41	54.8-55 $_{10}$ mm.	588
$(\text{CH}_3)(\text{C}_6\text{H}_5)\text{O}\cdot\text{BF}_3$	-12 to -13	588

Acid Anhydrides. Acetic anhydride-boron trifluoride was reported by two independent workers at approximately the same time. Bowlus and Nieuwland, in the October 1931 issue of the *Journal of the American Chemical Society*, reported $\text{BF}_3\cdot\text{O}(\text{CH}_3\text{CO})_2$. Morgan and Taylor reported the same compound in the same month in the *Journal of the Society of Chemical Industry*. However, Morgan and Taylor⁽⁶⁴⁰⁾ acknowledged that the American chemists, Bowlus and Nieuwland⁽¹⁰⁷⁾ published their paper first. Two years later, Meerwein⁽⁵⁸⁴⁾ stated that the compound reported by Bowlus and Nieuwland was not $\text{BF}_3\cdot\text{O}(\text{CH}_3\text{CO})_2$ but was actually $[(\text{CH}_3\text{CO})_2\text{CHCO}]_2\text{O}\cdot 3\text{BF}_3$. He also reported that compounds of the type $(\text{RCOCHRCO})_2\text{O}\cdot 3\text{BF}_3$

were obtained with propionic, normal butyric, and isobutyric anhydrides. Later, working with Vossen⁽⁵⁹⁰⁾ with isobutyric anhydride, he reported the compound $[i\text{-C}_3\text{H}_7\text{CO}\cdot\text{C}(\text{CH}_3)_2\cdot\text{CO}]_2\text{O}\cdot 3\text{BF}_3$ and, with diacetic acid anhydride, the compound $[(\text{CH}_3\text{CO})_2\text{CHCO}]_2\text{O}\cdot 3\text{BF}_3$.

Chloroacetic and phenylacetic anhydride, formed by the substitution of chlorine or a phenyl group for a hydrogen in the methyl group of acetic anhydride, also yielded molecular compounds with boron trifluoride.⁽⁵⁹⁰⁾

With succinic, benzoic, and phthalic anhydrides, Bowlus and Nieuwland⁽¹⁰⁷⁾ obtained no reaction, but Meerwein and Maier-Hüser⁽⁵⁸⁸⁾ later reported succinic anhydride-boron trifluoride, $\text{BF}_3\cdot\text{O}(\text{H}_2\text{CCO})_2$.

Esters. Esters have been found to form stable coordinate compounds with boron trifluoride. Morgan and Taylor⁽⁶⁴⁰⁾ were able to isolate methyl formate-boron trifluoride, $\text{BF}_3\cdot\text{HCO}_2\text{CH}_3$. The next ester in the series, methyl acetate, was found by Bowlus and Nieuwland,⁽¹⁰⁷⁾ and almost simultaneously by Morgan and Taylor,⁽⁶⁴⁰⁾ to form the compound $\text{BF}_3\cdot\text{CH}_3\text{CO}_2\text{CH}_3$. Ascending the series, methyl glycollate-boron trifluoride, $\text{BF}_3\cdot\text{CH}_2\text{OHCH}_2\text{CO}_2\text{CH}_3$ was found as was also methyl benzoate-boron trifluoride, $\text{BF}_3\cdot\text{C}_6\text{H}_5\text{CO}_2\text{CH}_3$.⁽⁶³⁹⁾

In the ethyl series we find formate and acetate complexes with boron trifluoride analogous to those of the methyl series, namely ethyl formate-boron trifluoride, $\text{BF}_3\cdot\text{HCO}_2\text{C}_2\text{H}_5$, and ethyl acetate-boron trifluoride, $\text{BF}_3\cdot\text{CH}_3\text{CO}_2\text{C}_2\text{H}_5$.^(107, 640) Bowlus and Nieuwland⁽¹⁰⁷⁾ also reported ethyl propionate-boron trifluoride, $\text{BF}_3\cdot\text{C}_2\text{H}_5\text{CO}_2\text{C}_2\text{H}_5$. They studied the chloroderivatives of ethyl acetate and found the ethyl chloroacetate and ethyl trichloroacetate absorbed 1 mole of boron trifluoride to form viscous liquids. With diethyl oxalate and diethyl malonate, they obtained crystalline compounds after 1 mole of boron trifluoride had been absorbed.

McKenna and Sowa⁽⁵⁶⁹⁾ studied the mechanism of the alkylation of benzene with esters, using boron trifluoride as a catalyst, and decided that an intermediate compound was formed between the ester and boron trifluoride. As an example, they suggested that normal propyl formate would form normal propyl formate-boron trifluoride, $\text{BF}_3\cdot\text{HCO}_2\text{C}_3\text{H}_7$. The following esters were thought to react similarly, secondary butyl formate, isobutyl

formate, isopropyl acetate, secondary butyl acetate, cyclohexyl acetate, isopropyl trichloroacetate, ethyl formate, normal butyl formate, normal butyl phosphate, normal butyl sulfate, and isopropyl sulfate, but they were not isolated. Propyl acetate-boron trifluoride, $\text{BF}_3 \cdot \text{CH}_3\text{CO}_2\text{C}_3\text{H}_7$, had previously been isolated in the same laboratory.⁽¹⁰⁷⁾ Diglycol acetate was found to absorb 1 mole of boron trifluoride to yield a crystalline compound.⁽¹⁰⁷⁾

Esters with aromatic groups, such as phenyl acetate and ethyl benzoate, were also found to absorb 1 mole of boron trifluoride to give a viscous liquid.⁽¹⁰⁷⁾ Other esters of the same type, such as the alkyl esters of salicylic acid, have been studied in detail by Croxall, Sowa, and Nieuwland.⁽¹⁸⁸⁾ They postulated, "Since *n*-propyl, *n*-butyl, and isobutyl esters rearranged to isopropyl-, secondary butyl-, and tertiary butyl-substituted acids, respectively, the migration might be considered as taking place through the intermediate olefin stage with subsequent condensation of the activated olefin into an activated position in the aromatic nucleus."

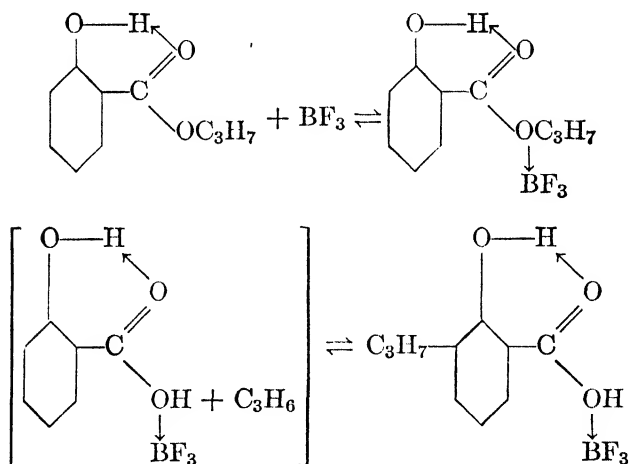

Isopropyl, normal propyl, isobutyl, and normal butyl salicylates were studied.

Grummitt⁽³²⁶⁾ reported the compound *p*-tolyl acetate-boron trifluoride, $\text{CH}_3 \cdot \text{C}_6\text{H}_4 \cdot \text{OOCCH}_3 \cdot \text{BF}_3$.

Miller⁽⁶¹⁴⁾ has patented the use of boron trifluoride-ester complexes as noncorrosive soldering fluxes.

The physical properties of the known coordination compounds between esters and boron trifluoride are listed in Table 19.

TABLE 19

PHYSICAL PROPERTIES OF COMPOUNDS OF BORON TRIFLUORIDE WITH ESTERS

Compound	Melting Point, °C.	Boiling Point, °C.	d_4^{20}	Reference
$\text{CH}_3\text{O}_2\text{CH} \cdot \text{BF}_3$	23.5	92.5	1.450-0.00128 <i>t</i>	879
$\text{C}_2\text{H}_5\text{O}_2\text{CH} \cdot \text{BF}_3$	3	102 ₇₄₈ mm.	1.346-0.00122 <i>t</i>	107, 879
$\text{CH}_3\text{O}_2\text{CCH}_3 \cdot \text{BF}_3$	61.5	110 ₇₃₉ mm.	1.324-0.00117 <i>t</i>	107, 879
$\text{CH}_3\text{O}_2\text{CCH}_2\text{OH} \cdot \text{BF}_3$	60 ₃ mm.	639
$\text{C}_2\text{H}_5\text{O}_2\text{CCH}_2\text{OH} \cdot \text{BF}_3$	31	119 ₇₃₉ mm.	1.276-0.00123 <i>t</i>	107, 879
$\text{C}_3\text{H}_7\text{O}_2\text{CCH}_3 \cdot \text{BF}_3$	126 ₇₄₃ mm.	107
$\text{C}_6\text{H}_5\text{O}_2\text{CCH}_3 \cdot \text{BF}_3$	40-55	639
<i>p</i> - $\text{CH}_3 \cdot \text{C}_6\text{H}_4\text{O}_2\text{CCH}_3 \cdot \text{BF}_3$	146-150	326
$\text{C}_2\text{H}_5\text{O}_2\text{CC}_2\text{H}_5 \cdot \text{BF}_3$	33	116 ₇₄₇ mm.	107

Trimethylamine oxide reacts in chloroform with boron trifluoride to give $\text{Me}_3\text{NO} \cdot \text{BF}_3$ (m. pt. 89°). It begins to decompose at 100° and chars at 227°. It is quite stable in air, and its aqueous solution is not hydrolyzed on evaporation to dryness.⁽¹⁴⁴⁾

ORGANIC SULFUR COMPOUNDS

Axe⁽²¹⁾ reported that equimolecular quantities of boron trifluoride and of an alkyl sulfide or of a mercaptan readily formed a complex at a temperature between 4.4° and 37.8°C. No other coordination compounds between organic sulfur compounds and boron trifluoride have been reported.

Thus, in Group VI it has been seen that the oxygen atom and the sulfur atom in inorganic compounds are capable of donating to the boron atom of boron trifluoride. With the organic compounds, it was rather evident that the oxygen of the hydroxyl group would donate more readily than a doubly bound oxygen in a carbonyl group. This was especially noticeable in acids, acid anhydrides, and esters in which it was the oxygen on the hydroxyl of the carboxyl group which was coordinating with the boron trifluoride. A singly bound oxygen atom apparently donates more easily than a doubly bound oxygen atom. It was pointed out also that there is a greater tendency for boron trifluoride to coordinate with the carboxy or carbalkoxy group than with the phenolic

group. Another factor which decreases the stability of these complexes is the presence of a polar group or easily polarizable group in the vicinity of the oxygen atom which is coordinating with the boron trifluoride.

GROUP VII

Only two elements in Group VII have been reported as furnishing atoms in compounds which donate to the boron atom of boron trifluoride. These are fluorine and chlorine.

FLUORINE

In an investigation of the vapor pressure of boron trifluoride at various pressures, Booth and Carter ⁽⁹²⁾ showed that, at a pressure of about 10 atmospheres, liquid boron trifluoride became so viscous that the magnetic stirrer would scarcely operate. This increased viscosity undoubtedly signified association which must come about through the donation of electron pairs from a fluorine atom of 1 molecule of boron trifluoride to the boron atom of another molecule. That the associated molecule may be a tetramer is suggested by the compound $A \cdot 16BF_3$ formed under pressure of 14 atmospheres. ^(92,100)

In 1824 Berzelius ⁽⁶⁶⁾ reported that he passed boron trifluoride into water until the solution was strongly acid. On cooling, metaboric acid settled out, and fluoboric acid remained in the solution. Fluoboric acid is a coordination compound between hydrogen fluoride and boron trifluoride, thus $HF \rightarrow BF_3$, or more correctly, between the fluoride ion and boron trifluoride.

It is interesting to observe that, just as water formed three different hydrates with boron trifluoride, another solvent, hydrogen fluoride, also is reported to form three solvates. Landolph ⁽⁴⁸⁵⁾ in 1878 reported "hydroboric fluoride" which could be written $BF_3 \cdot 3HF$. The disolvate, $BF_3 \cdot 2HF$, was the most recently found. ⁽³⁸²⁾ The second and third molecules of HF are probably combined through hydrogen bridges.

Derivatives of fluoboric acid, the fluoborates, can likewise be considered as coordination compounds with boron trifluoride. However, only a few examples of the formation of these fluoborates by direct addition of boron trifluoride are reported. The fluorides of the alkali metals lithium, sodium, potassium, rubidium, and

cesium were found to form one-to-one complex compounds with boron trifluoride.⁽⁸⁶⁾ Germann and Torrey⁽³⁰¹⁾ found that calcium fluoride, if heated for some length of time in the presence of boron trifluoride, would form the compound $2\text{CaF}_2 \cdot \text{BF}_3$. The compound $\text{CaF}_2 \cdot \text{BF}_3$ has been reported as made by heating a mixture of boron trifluoride etherate and calcium fluoride and distilling off the ether.^(27b, 971b)

The stable compounds, $\text{FeF}_2 \cdot \text{BF}_3$, $\text{CoF}_2 \cdot \text{BF}_3$, and $\text{NiF}_2 \cdot \text{BF}_3$, were later found by Long.⁽⁵⁵⁵⁾ He also found $\text{FeF}_2 \cdot 2\text{BF}_3$, $\text{CoF}_2 \cdot 2\text{BF}_3$, and $\text{NiF}_2 \cdot 2\text{BF}_3$, but these compounds exhibited a vapor pressure of boron trifluoride. It was found later that extremely dry NiF_2 and BF_3 would not react.

Balz and Mailänder⁽³²⁾ found that nitrosyl fluoride reacted with boron trifluoride to form NOBF_4 ^(943, 952) which might be considered as $\text{NOF} \cdot \text{BF}_3$.

Acetyl fluoride and boron trifluoride when condensed together or mixed in an inert solvent such as carbon tetrachloride, chloroform, or liquid sulfur dioxide reacted to form the colorless solid carboxonium salt, $\text{CH}_3\text{CO}^+ \text{BF}_4^-$, in which the fluorine atom of the acetyl fluoride was the donor^(617, 788) (for properties see Chapter 5).

In certain fluoborates comprised of an alkyl fluoride, boron trifluoride, and some other organic compound, the fluorine atom of the alkyl fluoride has been reported as coordinating with boron trifluoride to form the fluoborate radical. The types of compounds prepared were trimethyloxonium fluoborate, $(\text{CH}_3)_3\text{OBF}_4$; triethyloxonium fluoborate, $(\text{C}_2\text{H}_5)_3\text{OBF}_4$; dimethylethyloxonium fluoborate, $(\text{CH}_3)_2\text{C}_2\text{H}_5\text{OBF}_4$; triethylsulfonium fluoborate, $(\text{C}_2\text{H}_5)_3\text{SBF}_4$; the pyridine derivative, $\text{C}_5\text{H}_5\text{NC}_2\text{H}_5\text{BF}_4$; the camphor derivative, $\text{C}_{10}\text{H}_{16}\text{OC}_2\text{H}_5\text{BF}_4$; and derivatives of dimethylpyrone, coumarin, dianisalacetone, and α, β -unsaturated ketones.⁽⁶⁸⁷⁾

A rough estimate of the strength of the B-F bond in BF_4^- calculated from heats of reactions with all components in the gaseous state is given by Bauer, Finlay, and Laubengayer⁽⁴⁸⁾ as about 150 kcal.

By thermal analysis Booth and Walkup^(98, 934) studied systems of the chlorofluorides of methane and boron trifluoride. They found they had such limited miscibility that compound formation could not be established (see Figures 4-14 and 4-15).

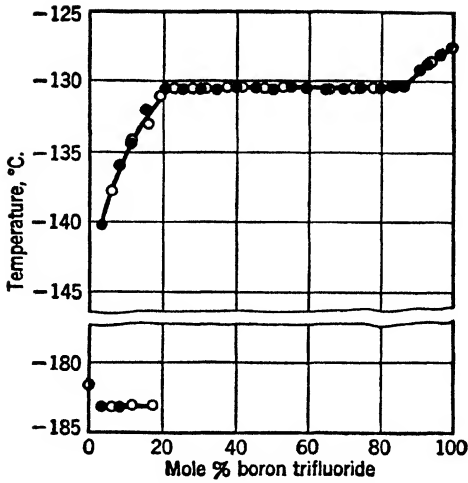

FIG. 4-14. The system monochlorotrifluoromethane-boron trifluoride
(Courtesy *Journal of the American Chemical Society*)

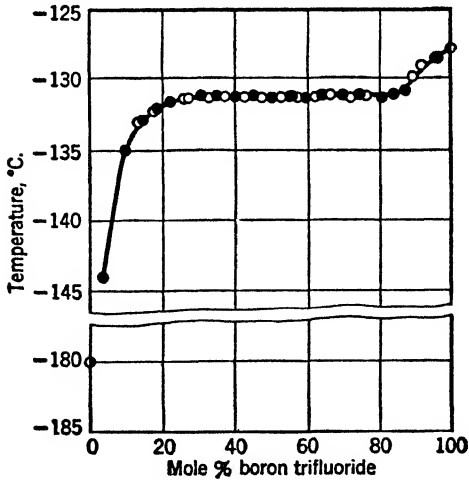

FIG. 4-15. The system tetrafluoromethane-boron trifluoride
(Courtesy *Journal of the American Chemical Society*)

CHLORINE

Whereas hydrogen fluoride is reported to form three coordination compounds with boron trifluoride, Booth and Martin^(95, 96) found no compound between hydrogen chloride and boron trifluoride, thus refuting the reported compound $\text{BF}_3 \cdot 3\text{HCl}$.⁽⁹⁴⁹⁾ (See Figure 4-16).

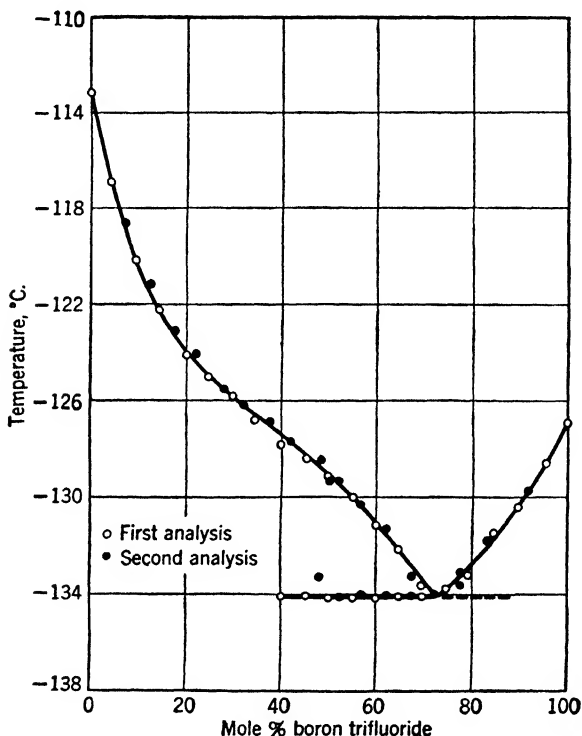

FIG. 4-16. The system hydrogen chloride-boron trifluoride
(Courtesy *Journal of the American Chemical Society*)

Replacement of the hydrogen atom by a methyl group seemingly had little effect on the donating properties of the chlorine atom, as no compound between methyl chloride and boron trifluoride was found^(95, 96) (see Figure 4-17). Some earlier work on this latter system indicated a compound, but the authors concluded that it was due to methyl ether present as an impurity in the methyl chloride.^(179, 300)

Chlorine-containing compounds have been reported as coordinating with boron trifluoride; organic compounds are freed from their coordination compounds with boron trifluoride by the addition of a metallic halide of aluminum, copper, iron, lead, sodium, tin, or zinc, the added metallic halide forming a coordination

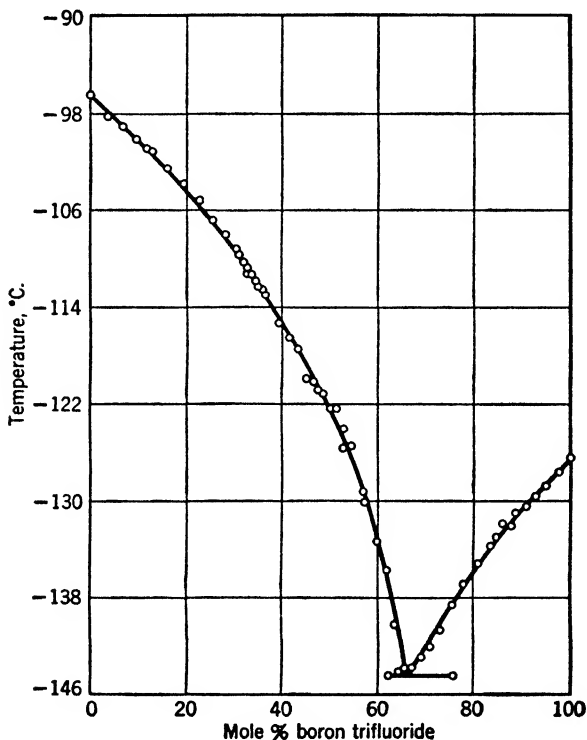

FIG. 4-17. The system methyl chloride-boron trifluoride
(Courtesy *Journal of the American Chemical Society*)

compound with boron trifluoride. An example cited sodium chloride, in which case the chlorine ion is probably the donor.⁽²²⁷⁾

The foregoing studies indicate that only the chloride ion is capable of donating to the boron atom of boron trifluoride. Most of the evidence for fluorine indicated that it is probably the fluoride ion which is the donor.

BROMINE.

The temperature-composition diagram for the system hydrogen bromide-boron trifluoride ^(678a) is shown in Figure 4-18.

Immiscibility was encountered between 10 and 80 mole % of boron trifluoride. These values give the limit of solubilities of each component in the other: 2 moles of hydrogen bromide in

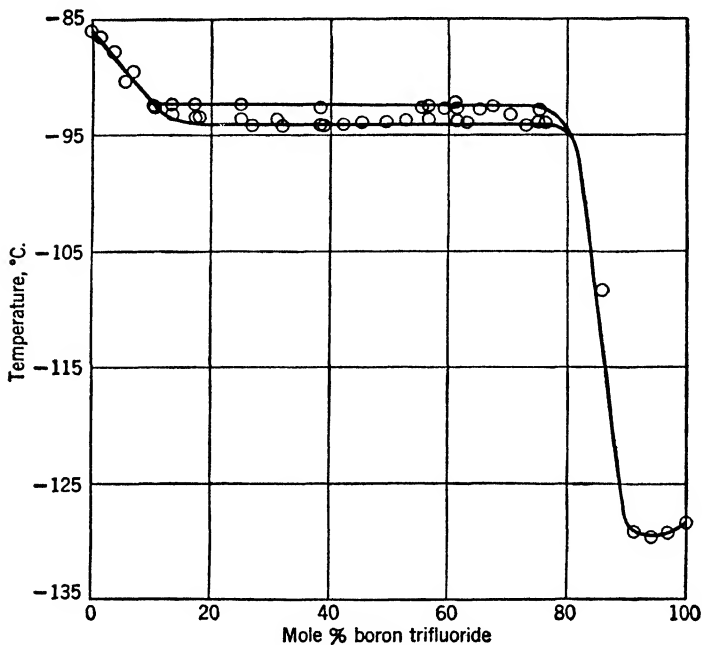

FIG. 4-18. The system hydrogen bromide-boron trifluoride

8 moles of boron trifluoride and 1 mole of boron trifluoride in 9 moles of hydrogen bromide.

The double line was drawn in the center of the diagram, because two series of freezing points were obtained in that region of the diagram. These two sets of points are due to the fact that two liquid layers were present. The upper line denotes the freezing point of the saturated solution of hydrogen bromide in boron trifluoride, while the lower represents boron trifluoride in hydrogen bromide.

No compound was formed between hydrogen bromide and boron trifluoride. A eutectic point was found at -129.3°C. and 94.2 mole % boron trifluoride.

GENERALIZATIONS ON BORON TRIFLUORIDE
COORDINATION PHENOMENA

Boron trifluoride is the most powerful acceptor molecule known. Since the boron atom in boron trifluoride has only 6 electrons in its outer shell, it has a strong tendency to combine with atoms having unshared electron pairs to achieve a stable electronic grouping of 8 electrons and thus form a coordinate covalent (semi-polar) bond.

The bonds formed by boron trifluoride in this type of coordination are comparable in strength to those of normal covalent bonds between the corresponding atoms,⁽⁴⁸⁾ which suggests that the bond formed in the association process should be regarded as being due to an electron pair rather than to a dipole-dipole interaction, as has been sometimes suggested.

Laubengayer and Finlay⁽⁴⁹⁴⁾ have nicely summarized the possible consequence of donor-acceptor bond formation as follows:

1. The coordination numbers of both the donor atom and the acceptor atom are increased by one unit. In general, an increase in coordination number demands a change in bond angles. This should be more serious for the acceptor than for the donor molecule. The donor atom, prior to addition, already has a pair of unshared electrons in the coordination position, and so no great change in its electronic environment will be produced by the formation of the bond, and no great changes of bond angles are to be expected. On the other hand, the acceptor atom acquires a share of a pair of electrons and its electronic environment is greatly changed, which should cause a considerable change in its configuration. Thus a change in the coordination number of an acceptor atom from three to four would probably involve a change of configuration from planar to tetrahedral.

2. If an asymmetrical atom is produced, the increase in coordination number may give rise to optical isomers.

3. The bonds of the original molecules should be weakened, and probably the bond distances should become greater.

4. The donor-acceptor bond distance should approximate that of the normal covalent bond for the same coordination numbers, allowance being made for the effect of separation of charge.

5. The donor-acceptor bond energy should approximate that of the normal covalent bond for the same coordination number. The heat of formation observed for the addition compound should be the algebraic sum of the energy required to bend and stretch the bonds of the system in accord with the increased coordination number and the energy of the donor-acceptor bond itself.

6. Since two independent molecules combine to form one, the system loses three degrees of freedom of translation and three of rotation and gains five of vibration and one of internal rotation.

7. The donor may be considered as losing some interest in a pair of electrons and so acquires a positive charge, while the acceptor acquires a negative charge. This separation of charge should give the bond a dipole moment which would be very large if the electrons were equally shared. The dipole moment for the addition complex will depend upon not only the moment for the donor-acceptor bond but also on the moments of the other bonds in the donor and acceptor molecules. These latter should be quite different from those in the molecules prior to addition, and their directions should be changed, due to the changes which have occurred in the configurations of the donor and acceptor molecules.

Since in boron trifluoride the boron atom is in the center of a plane made by an equilateral triangle, the apices of which are the fluorine atoms,^(27, 108, 312, 506, 744) and since in coordination complexes the boron atom is moved into the center of a tetrahedron^(48, 49, 494) whose apices are the three fluorine atoms with the donor atom the fourth apex of the tetrahedron, considerable energy is involved in the distortion of the boron trifluoride molecule to permit coordination. For example, the heat of formation of methyl ether-boron trifluoride complex from methyl ether and from boron trifluoride is 13,900 cal.⁽⁴⁹⁴⁾

Coordination of boron trifluoride and dimethyl ether also involves the lengthening of the boron-fluorine bond distance from 1.30 Å. to 1.43 Å. \pm 0.03⁽⁴⁹⁾ and an increase in the single-bond radius.⁽⁵⁰⁶⁾ The B-O bond produced has a length of 1.50 Å. \pm 0.06.⁽⁴⁹⁾ Wiberg and Mäthing⁽⁹⁴⁸⁾ found that the increase in outer electrons of B from six in BF₃ to eight in Et₂O·BF₃ makes no determinable change in the atomic parachor for boron.

The asymmetry of the molecule produced by this coordination is revealed in the change from a dipole moment of zero in boron trifluoride to 4.35 \pm 0.12 debyes for methyl ether-boron trifluoride complex^(494, 515, 938) in benzene at 25°C.

Frequently, coordination with boron trifluoride results in the formation of clearly electrovalent compounds. The coordination of NOF with BF₃ yields nitrosyl fluoborate, for example.^(934, 952) Likewise, acetyl fluoride and boron trifluoride react to form the solid, carboxonium salt, CH₃CO⁺BF₄⁻, in which the fluorine atom of the acetyl fluoride is the donor.⁽⁷⁸⁸⁾ Coordination with the hydroxyl ion, even from water, yields a moderately strong

acid, monohydroxyfluoboric.^(460, 584, 589) Apparently the presence of only extremely small concentrations of the donor ion is necessary. Coordination of boron trifluoride with alcohols produces acids which, however, appear to be much weaker⁽⁵⁸⁹⁾ than those produced with water, as their sodium salts dissolve in water to give an alkaline reaction.

POLAR CHARACTER OF DONOR ATOM

A perusal of the many examples of coordination and also of failure of coordination in this chapter will show clearly that it is not possible to predict, because an electron pair seems available in a possible donor atom, that coordination will take place. An excellent example of this is shown in the case of phosphine and phosphorus trifluoride. PH_3 readily coordinates with BF_3 to yield the compound $\text{H}_3\text{P} \rightarrow \text{BF}_3$,^(71, 947) but thermal analysis of the system $\text{BF}_3\text{-PF}_3$ ⁽⁹⁸⁾ reveals only a simple eutectic although the phosphorus atom in both PH_3 and PF_3 has an available electron pair. A convenient explanation⁽⁹³⁴⁾ given for this is that the large positive charge on the nucleus of the fluorine atoms compared with their bond distances to the phosphorus atom has so great an attractive force on the electron pair that it cannot become available for sharing. In all cases so far studied, covalently bonded fluorine, where no fluoride ions are present, refuses to coordinate with boron trifluoride, whereas, in all cases of fluoride ions, coordination takes place. As an example, carbon tetrafluoride⁽⁹⁸⁾ (bond distance 1.41 Å.) fails to coordinate with boron trifluoride, whereas sodium fluoride, even in the solid state (distance between Na^+ and $\text{F}^- = 2.307$ Å.) reacts to give the BF_4^- ion. Apparently the ionic character of the donor atom favors coordination with boron trifluoride.^(98, 788)

STERIC HINDRANCE

Whereas phenol, phenyl methyl ether, and phenyl ethyl ether coordinate readily with boron trifluoride, diphenyl oxide refuses to coordinate. This is thought to be due to steric hindrance. It would be interesting to see if ditertiary butyl ether or phenyl tertiary butyl ether would coordinate with boron trifluoride.

Brown and Adams⁽¹¹³⁾ studied the properties of compounds of boron trifluoride with Me_2O , Et_2O , $i\text{-Pr}_2\text{O}$ and tetrahydrofuran and found that the basic strengths of the ethers (Lewis theory)

decreases in the order: tetrahydrofuran, dimethyl, diethyl, diisopropyl. They state that this order is inexplicable on the basis of the factors generally believed to control base strength. The anomalies may be accounted for by taking into consideration the probable steric strains resulting from spatial limitations with the respective molecules.

STABILITY OF BORON TRIFLUORIDE COMPLEXES

The boron trifluoride-methyl ether complex is considerably dissociated below its boiling point as seems to be the case in many other coordination compounds with boron trifluoride.⁽⁴⁹⁴⁾ Evidence is clear, however, suggesting that coordination always exists above the melting point of the compound formed, even in those compounds formed from argon⁽¹⁰⁰⁾ under pressure and at low temperature. Meerwein and Pannwitz⁽⁵⁸⁹⁾ have observed that the stability of boron trifluoride-alcohol complexes is decreased if a polar or easily polarizable group, such as CH_2Cl , CCl_3 , or C_6H_5 , is in the immediate proximity of the hydroxyl group. Brown, Schlesinger, and Burg⁽¹¹⁵⁾ have observed the same phenomenon in connection with the carbonyl group: The coordination compounds between the chloroacetic acids and boron trifluoride show to a striking degree this decrease in stability with increase in chlorine content; $\text{BF}_3 \cdot 2\text{CH}_2\text{ClCOOH}$ is stable at room temperature, whereas the compound with dichloroacetic acid decomposes at room temperature, and trichloroacetic acid will absorb boron trifluoride only at low temperatures.

Increase in the number of chlorine atoms increases the negative character of the substituted methyl group with a resultant increase in the positive character of the hydroxy oxygen, making it a poorer donor.

KNOWN DONOR ATOMS

The number of different atoms which have been found to donate to the boron atom is surprisingly small. A survey of the addition compounds with boron trifluoride reported in the literature shows that only 8 different elements have been found, in certain of their compounds, to be capable of donating electrons to the boron atom of boron trifluoride.

None of these elements are found in Groups I, II, or III of the Periodic Table. In *Group O*, argon has been found to coordinate with boron trifluoride.

Although no addition compounds have been isolated in which the donor atom was a member of Group IV, it has been postulated that the *carbon* atom, in olefin compounds, is the donor to the boron atom of boron trifluoride in condensation and polymerization reactions.

Nitrogen and *phosphorus* in *Group V* furnish atoms, in certain compounds, which have been found to donate to the boron atom of boron trifluoride.

In *Group VI* the *oxygen* and *sulfur* atoms in both *inorganic* and *organic* compounds were found donating to the boron atom of boron trifluoride. It is evident that the oxygen of the hydroxyl group donates more readily than a doubly bound oxygen in a carbonyl group. This is noticeable in acids, acid anhydrides, and esters in which the oxygen on the hydroxyl group of the carboxyl group coordinates with boron trifluoride. Also, it has been found that there is a greater tendency for boron trifluoride to coordinate with the carboxy or carbalkoxy group than with the phenolic group.

In *Group VII*, *fluorine* and *chlorine* have been reported as donating to the boron atom of boron trifluoride. There is evidence that fluorine in the ionic form, as in fluorides, coordinates more readily with boron trifluoride.

Inspection of the Periodic Table of the position of the donor elements shows that they are all in a small area in the second and the third periods in the upper right-hand corner of the Periodic Table,

C N O F

P S Cl A

It is probable that this limited number of atoms which have been shown to act as donors is partly fortuitous.

ELECTRONIC CHARACTER OF DONOR ATOMS

From the point of view of electron arrangement in donor atoms, it is evident that the donor elements exhibit no other than sp^3 bonds when coordinating with boron trifluoride. In the elements of *Group V*, one of these orbitals is already filled by the electrons of the atom before any covalence is involved (that is, the nitrogen atom has 5 electrons, 2 paired, 3 unpaired, which are paired by covalent union with other atoms).

Group VI atoms have 6 electrons, 2 unpaired which are paired by covalent union with other atoms, as in hydrogen sulfide, and two of the sp^3 orbitals are filled and ready to coordinate with boron trifluoride.

In doubly bonded oxygen atoms these sp^3 orbitals are not available. Hence boron trifluoride would not be expected to coordinate with truly double-bonded oxygen atoms, such as the CO group in esters. Coordination with ketones may be with their enol form.

In Group VII, the tendency of boron trifluoride to coordinate strongly with F^- (ion) can probably be ascribed to the good possibilities for resonance in the ion

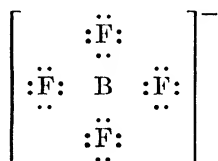

where each F is identical. On the other hand, an F atom, covalently bound to another atom as in carbon tetrafluoride could not resonate with the others of the boron trifluoride molecule. This likewise explains the coordination of BF_3 with CH_3COF ⁽⁷⁸⁸⁾ and NOF to give the ionic compounds $CH_3CO^+BF_4^-$ and $NO^+BF_4^-$.

This line of reasoning may explain why Cl^- ion is reluctant to coordinate with BF_3 , since there is no resonating structure analogous to the symmetrical

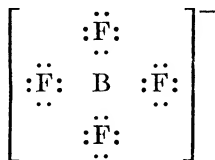

possible.

In Group IV it is obvious that none of the sp^3 is already filled in the atom before it combines covalently with four other atoms; hence, no completed orbital is available to invite coordination with boron trifluoride.

5

Fluoboric Acids and Their Salts

FLUOBORIC ACID, HBF_4

Fluoboric acid was discovered in 1809 by Gay-Lussac and Thénard.^(292, 293, 887) They obtained the acid as a water-white liquid of sirupy consistency, which fumes in air, by passing an excess of boron trifluoride into cold water. The technic which they recommend for this absorption is to pass the boron trifluoride through a tube dipping under mercury which is covered with water. The gas cannot be added directly to water because the absorption is so rapid that the water would be siphoned into the boron trifluoride generator or cylinder.

Berzelius^(66, 67, 68, 69, 70) obtained fluoboric acid by similarly passing boron trifluoride into water, the absorption being carried out until the solution was strongly acidic. The reaction may be expressed as $4\text{BF}_3 + 3\text{H}_2\text{O} \rightarrow 3\text{HBF}_4 + \text{H}_3\text{BO}_3$. Metaboric acid crystallized upon cooling the solution. The solution contained hydrofluoric and orthoboric acids in the ratio of three to one, which would correspond also to the trihydrate of boron trifluoride, $\text{BF}_3 \cdot 3\text{H}_2\text{O}$.

Davy⁽¹⁹⁹⁾ observed that one volume of water at 10°C . will absorb 700 volumes of boron trifluoride under a pressure of 762 mm. of mercury. Basarow^(45, 46) studied the absorption of boron trifluoride by water at 0°C . and found that one volume of water absorbed 1057 volumes of boron trifluoride under a pressure of 762 mm. of mercury. In this latter experiment, a precipitate of boric acid was formed.⁽⁴⁶⁾

The solution as prepared by Davy⁽¹⁹⁹⁾ has a specific gravity of 1.770. Such a saturated solution of boron trifluoride in water was found by Gay-Lussac and Thénard^(290, 292, 293) to evolve about one fifth of its dissolved gas, leaving a solution resembling concen-

trated sulfuric acid in its physical properties. The boiling point of such a solution is above 100°C.

Berzelius ^(66, 68, 69, 70) prepared fluoboric acid by dissolving boric acid in cold concentrated hydrofluoric acid. The solution was concentrated over a water bath until white fumes were evolved and then allowed to concentrate over concentrated sulfuric acid. The liquid product thus obtained had a specific gravity of 1.586, which is less than the liquid prepared by Davy.

Fischer and Thiele ⁽²⁶⁴⁾ have prepared fluoboric acid by allowing boric acid to react with a 40 to 50% solution of hydrofluoric acid at 0°C. The fluoboric acid was purified by adding, in turn, lead carbonate and hydrogen sulfide. At 15°C. the purified fluoboric acid solution had a specific gravity of 1.302 (*vide supra*).

An alcoholic solution of purified fluoboric acid was prepared in a similar manner by Mathers, Stewart, Housemann, and Lee. ⁽⁵⁷⁹⁾ These chemists used a 48% solution of hydrofluoric acid and added the boric acid until a test portion gave no precipitate with lead nitrate upon cooling. The cold solution was mixed with an equal volume of alcohol. The alcoholic solution of the acid may be stored in wax, rubber, lead, or paraffin bottles.

A solution of pure aqueous fluoboric acid may be prepared by allowing 1 mole of pure crystallized boric acid to dissolve in a sufficient volume of a 40% solution of hydrofluoric acid to furnish 4 moles of hydrogen fluoride. The solution should be kept cool during the addition. A paraffin-coated beaker may be used as a reactor. ^(277, 794, 818) Workers in this field have noticed that the acid first formed by this reaction has a higher alkali titration value than it does after standing.

Wamser ^(935a) has recently shown that this reaction goes in at least two steps—the first one rapidly (see Figure 5-1):



and the second one very slowly:

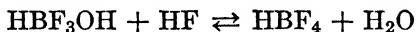

The second reaction is slow enough at concentrations of the order of 0.1 *M* at 25° to permit an investigation of the kinetics of the reaction. Advantage was taken of the discovery that, although the fluoborate ion gives a precipitate of analytical insolubility with nitron acetate, the monohydroxy fluoborate ion does not.

The average value of K_1 in the equation for the kinetics of the reaction, $K_1 = \frac{1}{t} \frac{x}{a(a-x)}$, in which t = time in minutes, a = initial concentration of HBF_3OH (and of HF) in moles per liter = 0.1105, and x = concentration of HBF_3OH (and of HF) reacting in time t , was found in the earlier part of the reaction to be 0.392 liter mole⁻¹ min.⁻¹ at 25°C.

Berzelius⁽⁶⁶⁾ found that although silicon tetrafluoride is not absorbed by boric oxide it is absorbed by crystalline boric acid to

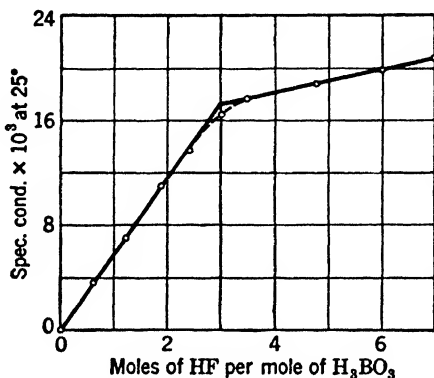
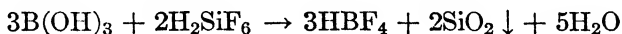

FIG. 5-1. Conductance of H_3BO_3 - HF mixtures immediately after mixing (Courtesy *Journal of the American Chemical Society*)

yield a white powder which does not fume in air. When this product is treated with water part dissolves, forming a solution of fluoboric acid.

Later Stolba⁽⁸⁶⁹⁾ found that the addition of boric acid to fluosilicic acid precipitates gelatinous silica and forms fluoboric acid in solution, presumably according to the equation:



In view of the recent work of Wamser (*supra*) it is possible the monohydroxyfluoboric acid is first formed. This reaction should be investigated.

Heiser^(344, 345, 348, 349) has prepared fluoboric acid by treating a fluoride of an alkaline-earth metal, such as fluorspar, with sulfuric and boric acids. A borate may be substituted for the boric acid. The reaction proceeds most effectively at a temperature between

70 and 100°C. and takes between 1 and 3 hours. This is essentially the reaction of a fluoborate with sulfuric acid, which had been predicted by Gay-Lussac and Thénard ^(290,292) as a probable method for the preparation of fluoboric acid.

Meyerhofer ⁽⁶⁰²⁾ has prepared fluoboric acid by allowing boron trifluoride to react with a solution of calcium fluoride in sulfuric acid. Hydrofluoric acid may be substituted for the solution of calcium fluoride in sulfuric acid. ⁽²⁴⁶⁾

Travers and Malaprade ⁽⁹⁰²⁾ prepared fluoboric acid by allowing sulfuric acid to react with barium fluoborate.

Recently ⁽⁹⁶⁾ fluoboric acid has been prepared by heating ammonium fluoborate to 250°C. to vaporize it and then heating the vapor to at least 600°C. whereupon nitrogen, hydrogen, and fluoboric acid are produced. The latter is absorbed in water to yield solutions in concentrations as high as 80–85%. The vapor may be absorbed in alcohol or liquid amines.

So far no one has reported the preparation of anhydrous fluoboric acid, HBF_4 , although mixtures of hydrogen fluoride and boron trifluoride approximating HBF_4 in composition have been used as catalysts ^(56, 57, 149, 154, 155, 156, 158, 159, 161, 325, 512, 513, 752) in the absence of water.

PHYSICAL AND CHEMICAL PROPERTIES OF FLUOBORIC ACID

De Boer ⁽⁸⁵⁾ has determined the refractive index, n_D of a 20% solution of fluoboric acid to be 1.3284, compared to a value of 1.3332 for water at 20°C. Thomsen ^(891, 892) measured the heat

TABLE 20

HEAT OF REACTION OF BORIC ACID AND HYDROFLUORIC ACID

$n\text{HF}$ moles	Q kcal.	Reference
2	9.132	891, 892
4	18.600	
6	27.468	
8	29.479	
12	29.136	

evolved when boric acid is allowed to mix with varying amounts of hydrofluoric acid. The values in Table 20 are for the reaction:



Obviously some kind of exothermal reaction occurs between the fluoboric acid formed and the excess of hydrofluoric acid present.

Mulert⁽⁶⁵³⁾ has studied the thermal effects of this same reaction and has noted that the heat evolved upon first mixing of the reactants is very slight. However, the temperature suddenly rises, and then, instead of assuming a maximum value and remaining constant, it continues to rise. This again is probably evidence for the reaction between monohydroxyfluoboric and hydrofluoric acid as mentioned previously.^(935a) The heat of solution of 1 mole of glassy boric acid in a solution of 3.65% hydrofluoric acid is 29.64 kcal.

Hammerl⁽³³⁰⁾ found the heat of the reaction, $4\text{BF}_3 + 3\text{H}_2\text{O} \rightarrow 3\text{HBF}_4 + \text{H}_3\text{BO}_3$ to be 24.51 kcal. per mole of boron trifluoride when the reaction is carried out in an excess of water. Laubengayer and Sears⁽⁴⁹⁵⁾ have determined the heat of solution of boron trifluoride in water at 0°C. to be 21.9 ± 0.2 kcal. per mole.

The heat of formation of fluoboric acid has been ascertained by von Wartenberg.⁽⁹³⁶⁾ For the reaction,

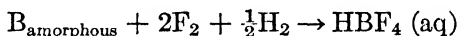

he obtained a value of 359.2 kcal. per mole. Berthelot⁽⁶³⁾ about 30 years earlier had estimated the heat of formation to be 307.6 kcal. per mole. Roth recently^(736a) has calculated it to be 388.5 kcal.

De Boer and van Liempt⁽⁸⁶⁾ have calculated the heat of formation of the gaseous fluoborate ion to be 70,000 cal. for the reaction $\text{F}^- + \text{BF}_3 (g) \rightarrow \text{BF}_4^- (g)$.

Wilke-Dörfurt⁽⁹⁵⁰⁾ pointed out the similarity of the fluoborate ion and the perchlorate ion with regard to their volume, structure, and chemical behavior. Fluoborates and permanganates form mixed crystals.^(952a)

Fluoboric acid ionizes to yield hydrated H^+ and BF_4^- ; the latter ion possibly dissociates to a very limited extent to yield BF_3 and F^- . The boron trifluoride thus formed is somewhat hydrolyzed by the water to produce boric and hydrofluoric acids. The effect of anion size, charge, and similar electrostatic effects on the strength of the acid has been discussed by van Arkel and Carrière.^(12a)

Recently, Wamser^(935c) has studied the hydrolysis of fluoboric acid in aqueous solution and has found that aqueous fluoboric acid is hydrolyzed to give chiefly monohydroxyfluoboric acid:

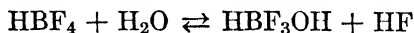

He surmises that the latter is somewhat hydrolyzed further to

TABLE 21

HYDROLYSIS OF AQUEOUS FLUOBORIC ACID AT 25°C.

Concentration, moles/liter	% Hydrolyzed (Avg.)	$\frac{[\text{HBF}_3\text{OH}][\text{HF}]}{[\text{HBF}_4]}$
0.001018	77.7	2.75×10^{-3}
0.00509	46.3	2.04×10^{-3}
0.02036	26.5	1.93×10^{-3}
0.0504	18.7	2.17×10^{-3}
0.1105	13.75	2.40×10^{-3}
0.2850	10.05	3.19×10^{-3}
0.557	7.98	3.85×10^{-3}
5.41	5.50	17.6×10^{-3}

$\text{HBF}_2(\text{OH})_2$, to $\text{HBF}(\text{OH})_3$, and finally to H_3BO_3 . The percentage hydrolyzed is shown in Table 21 (see Figures 5-2, 5-3, 5-4).

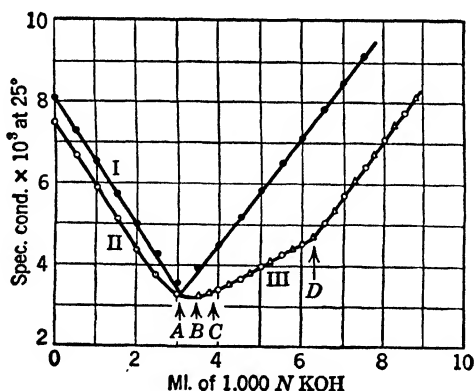

FIG. 5-2. Conductimetric titrations of aqueous fluoboric acid solutions
 I, ●, unhydrolyzed HBF_4 solution.
 II, ○, hydrolyzed HBF_4 solution.
 III, △, solution of $\text{KBF}_4 + \text{KBF}_3\text{OH} + \text{KHF}_2$.
 (Courtesy *Journal of the American Chemical Society*)

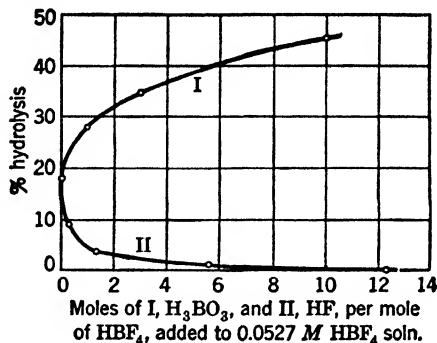

FIG. 5-3. Influence of added excess H_3BO_3 and HF on the degree of hydrolysis of HBF_4 (at equilibrium) at 25°C .

(Courtesy *Journal of the American Chemical Society*)

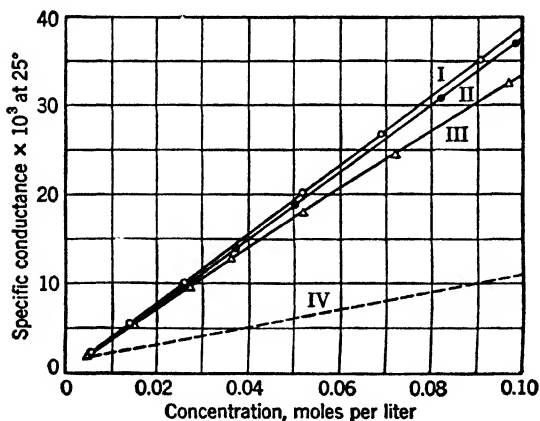

FIG. 5-4. Conductance of aqueous fluoboric acid solutions:

- I, O, no hydrolysis.
- II, ●, equilibrium hydrolysis.
- III, Δ, complete hydrolysis.
- IV, —, 4HF .

(Courtesy *Journal of the American Chemical Society*)

The existence of the acid HBF_3OH had been previously established by X-ray studies when Klinkenberg and Ketelaar⁽⁴⁶⁰⁾ reported that boron trifluoride dihydrate was really hydronium monohydroxyfluoboric acid, $[\text{H}_3\text{O}]^+[\text{BF}_3\text{OH}]^-$. For further discussion of monohydroxyfluoboric acid see page 158.

Heiser ^(346,347) has prepared fluorides such as cryolite from fluoboric acid, an alkali-metal aluminate, and an alkali-metal fluoride.

Harris ⁽³³⁸⁾ has observed that quartz particles below 5 microns in diameter are about as soluble in fluoboric acid as they are in fluosilicic.

Fluoboric acid is poisonous. Homeyer ⁽³⁹²⁾ observed that a 0.1 to 0.5% solution of the acid, or of one of its salts, retards fermentation.

USES OF FLUOBORIC ACID

A mixture of hydrogen fluoride and boron trifluoride in the proportion to form anhydrous fluoboric acid is used in conjunction with mercuric oxide as a catalyst for the preparation of acetals by the reaction of acetylene with glycerol, phenol, aniline, or ethyl lactate. ⁽⁶⁶⁴⁾

The esterification of cellulose, especially α -cellulose, is effected in the presence of a catalyst prepared by allowing 4 moles of hydrofluoric acid and 1 mole of boric acid to react (HBF_4). ⁽⁸¹⁸⁾ In many organic reactions better control of the reaction is possible when using fluoboric acid as a catalyst than when using boron trifluoride (compare Chapter 6 on Catalysts).

Aqueous solutions of boric and hydrofluoric acids, or of boric and oxalic acids in which barium fluoride has been dissolved, containing 0.1% of Nacconal NR as a wetting agent are used as cleaners to prepare Alclad 24 *S-T* sheet metal for spot welding. ⁽³⁶⁶⁾

Fluoborate preservative compositions are prepared from dry boric acid and a dry acid fluoride. ⁽¹⁷⁴⁾

Fluoboric acid is used sometimes in electrolytes in electroplating of metals. It is now feasible to electrodeposit lead; ⁽⁵⁰³⁾ indium; ⁽⁶⁵⁴⁾ tin, cadmium, zinc; ⁽¹⁷²⁾ copper; ^(503, 878) iron, nickel; ^(521, 556, 560) and chromium and silver ⁽⁵⁰³⁾ from fluoborate solutions. According to Narcus ⁽⁶⁵⁵⁾ this has been made possible by the commercial availability of "solution concentrates," which contain between 40 and 50% of the metal fluoborate in a water solution. The concentrate requires only dilution with water and adjustment to prepare the proper operating plating solution. The resulting electrolyte contains the proper amount of metal, free fluoboric acid, and boric acid. The fluoborate baths are reported to show increased electrode efficiencies, simplicity of operation at room temperature, less fluctuation in bath composition, better fine-grain deposits, and a

relatively high throwing power compared to other commonly used plating solutions.⁽⁶⁵⁶⁾ Plating solutions^(912a) containing fluoborates are considered toxic.

Mathers, Stewart, Housemann, and Lee⁽⁵⁷⁹⁾ have devised a procedure for identifying sodium ion in the presence of potassium and magnesium ions by the use of a sodium-free alcoholic solution of fluoboric acid prepared as previously described.

Fluoboric acid is used in the preparation of diazonium fluoborates; 50% HBF_4 has been used to prepare tetrazonium fluoborates.⁽⁷⁴⁹⁾ Fluoboric acid has been used to treat magnesium and its alloys to preserve the surface.^(204, 557) In casting readily oxidizable metals such as magnesium and its alloys, the molding composition is mixed with fluoboric acid before forming the mold to yield sound castings.⁽²⁸¹⁾

FLUOBORATES

Although J. J. Berzelius^(64, 65) usually is given the credit for the discovery of fluoboric acid and the fluoborates in the year 1824, actually J. L. Gay-Lussac and L. J. Thénard^(290, 292, 293) in 1809 prepared fluoboric acid and stated that there probably exist the fluoborates of barium, strontium, calcium, potassium, sodium, magnesium, beryllium, aluminum, yttrium, and zirconium. Also they predicted that sulfuric acid would react with a fluoborate to produce fluoboric acid.

Berzelius^(64, 65) did the major portion of the early work on the fluoborates. He prepared them by (a) the reaction of boron trifluoride with a fluoride of a metal, (b) the reaction of fluoboric acid with a fluoride, oxide, hydroxide, or carbonate of a metal, (c) the reaction of hydrofluoric and boric acids with a fluoride of a metal, and (d) the reaction of an acid fluoride of a metal with boric acid. Zeise in 1821⁽⁹⁷²⁾ drew attention to the fact that method *d* involved a reaction in which two acidic compounds interacted to produce an alkaline solution. Thus,



Fluoborates can be prepared also⁽⁸⁸⁾ by addition of a coordination complex of boron trifluoride to a metallic fluoride provided the bond strength in the complex is less than that in the desired metallic fluoborate. When finely divided calcium fluoride is

stirred into an ether-boron fluoride complex, the calcium fluoride reacts with the boron trifluoride to give a calcium fluoborate, and ether is liberated. The methyl ether is evolved as a gas.^(27b, 971b)

The fluoborates are normally crystalline compounds which are somewhat water-soluble; the heavy metal fluoborates are very soluble in water. They decompose readily to give boron trifluoride when calcined or when treated with sulfuric acid. De Boer and van Liempt⁽⁸⁶⁾ have calculated the heat of formation of the gaseous fluoborate ion to be 70,000 cal. for the reaction $F^- + BF_3(g) \rightarrow BF_4^-(g)$.

Thompson and Kraus^(89a) found that for solutions in $(CH_2Cl)_2$ at 25°C. the ion conductance of BF_4^- ion is 42.7.

Calculations of equilibrium constants were used by Ryss⁽⁷⁶⁷⁾ to determine the extent of hydrolysis of the fluoborate ion. Solutions of $NaBF_4$ and KBF_4 were added to an excess of alkali, and the excess was titrated with 0.1 *N* HCl. Equilibrium constants calculated on the assumption that the hydrolysis reaction was

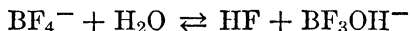

gave calculated *pH* values in accord with measured values. In very dilute solutions further hydrolysis of the BF_3OH^- ion was observed. The following equilibrium constants were calculated:

20°C.	2.4×10^{-3}
25°C.	2.8×10^{-3}
80°C.	5.5×10^{-3}
90°C.	6.5×10^{-3}
100°C.	7.3×10^{-3}

The hydrolysis of BF_4^- ion is slower than that of its decomposition products and determines the over-all speed of the hydrolysis of KBF_4 and $NaBF_4$.^(767c) The alkalinity of solutions of KBF_4 in NaOH gradually decreases. The concentration *x* of unchanged BF_4^- calculated from this alkalinity varies with time *t* according to equation $\log(x/x_0) = kt$, x_0 being the original concentration and *k* a constant. Because potassium fluoborate reacts with glass and suffers hydrolysis even before being mixed with sodium hydroxide, x_0 was smaller than calculated from the amount of solid potassium fluoborate taken. This discrepancy disappeared when solid potassium fluoborate was directly dissolved in aqueous sodium hydroxide. At 99.9° *k* was 0.00426 min.⁻¹ and was independent of

the concentration of sodium hydroxide (0.029–0.058 *N*): x_0 was varied between 0.003 and 0.016 *M*. At 90, 80, 70, 50, and 20° $k \times 10^6$ was 1080, 380, 170, 38, and 2.3 min.⁻¹ For sodium fluoborate in *N* NaOH $k \times 10^6$ was 300, 58, 11, and 1.5 min.⁻¹ at 80, 60, 40, and 20°. The constant is lower in this series, presumably because of the salt effect of the more concentrated sodium hydroxide. The salt effect is shown by $k \times 10^6$ for sodium fluoborate, being about 390 at 80° in 0.03–0.04 *N* NaOH and 337 in this solution plus *N* NaNO₃. The hydrolysis of potassium fluoborate in water starts at the same rate as in dilute sodium hydroxide; this shows that OH⁻ does not take part in the reaction; but the fact that it then accelerates, shows the effect of H⁺. In the presence of *M* CaCl₂ + 0.1 *N* NaOH, k is five to six times that in 0.1 *N* NaOH alone. Hydrolysis of BF₄⁻ ion is a source of contamination when potassium fluoborate solutions are evaporated.

The alkali-metal fluoborates, NaBF₄, KBF₄, RbBF₄, and CsBF₄, are sublimed from the tungsten filament of electric lamps to the walls of the lamp during evacuation. As would be expected, as the size of the alkali ion increases, the fluoborate ion becomes more stable, and dissociation into the metallic fluoride and boron trifluoride becomes more difficult.⁽⁸⁴⁾

Fluoborates, particularly the heavy metal fluoborates,^(406a, 613) form one of the ingredients of soldering fluxes.

FLUOBORATES OF THE ALKALI METALS

Siemens⁽⁸⁰²⁾ prepared the alkali fluoborates by allowing boric acid to mix with an alkali chloride in the presence of water and then adding hydrofluoric acid.

Lithium Fluoborate, LiBF₄. Berzelius^(66, 68, 69, 70) slowly evaporated at 40°C. the clear solution, which resulted from allowing barium fluoborate to react with lithium sulfate, to obtain crystals of lithium fluoborate. De Boer⁽⁸⁵⁾ prepared this salt by allowing lithium chloride to react with fluoboric acid. Baumgarten and Bruns⁽⁶¹⁾ passed boron trifluoride over lithium carbonate which was heated to a temperature of 300°C. They have expressed the reaction as follows:



Upon heating to glowing lithium fluoborate decomposes to yield boron trifluoride and lithium fluoride.

The relation between the dissociation pressure and temperature has been found by Klinkenberg ^(458a) to be expressed by

$$\log p_{\text{mm.}} = -\frac{833}{T} + 4.28$$

whence the heat of dissociation was calculated to be 3810 cal. The dissociation pressure of lithium fluoborate is 760 mm. at 324°C.

The crystals deliquesce and fume in air, are very soluble in water, and according to Berzelius ^(66, 68, 69, 70) have a bitter acidic taste. At 20°C., the refractive index values, n_D , of aqueous solutions of lithium fluoborate, are: for a 6% solution, 1.3318; for a 12% solution, 1.3303; and for a 50% solution, 1.3221. ^(85, 86)

Sodium Fluoborate, NaBF₄. Sodium fluoborate may be prepared from the reaction of fluoboric acid with the chloride, fluoride, carbonate, hydroxide, nitrate, or sulfate of sodium. ^(66, 68, 69, 70, 85, 453, 603, 607, 952) The salt also has been prepared by allowing sodium chloride to react with boron trifluoride in the presence of hydrofluoric acid (or calcium fluoride and an acid). Elevated reaction temperatures and pressures expedite the reaction. ^(604, 606)

Between 240 and 241°C., the β -form (rhombic) crystalline state changes to the α -form (isotropic). ^(259, 930) Sodium fluoborate crystals are isomorphous with sodium perchlorate crystals as shown by their axial ratios. These are for $a:b:c$, 0.922:1:1.007 and 0.919:1:1.005, respectively ^(458, 459) (see Table 22). Wilke-Dörfurt ⁽⁹⁵⁰⁾ earlier had pointed out the similarity of the fluoborate ion and the perchlorate ion with regard to their volume, structure and chemical behavior.

Klinkenberg ^(458, 458a, 459) found that the X-ray diagram for the sodium salt of monohydroxyfluoboric acid, NaOH·BF₃, was practically identical with that for sodium fluoborate, NaBF₄.

The dissociation pressures of these two salts were measured between 400 and 700°C. and are best expressed by the equations:

$$\log p_{\text{mm.}} = -\frac{3650}{T} + 6.63 \text{ for NaBF}_4$$

and

$$\log p_{\text{mm.}} = -\frac{4024}{T} + 6.99 \text{ for NaOH} \cdot \text{BF}_3$$

from which the heats of dissociation are calculated to be 16,690 and 18,380 cal. for NaBF_4 and $\text{NaOH}\cdot\text{BF}_3$, respectively.* The difference between these two values is attributed to the greater lattice energy in sodium hydroxide and to the fact that the fluoride ion is less polarizable than the hydroxyl ion.^(458, 459) Berzelius^(66, 68, 69, 70) and Buchner⁽¹⁴⁰⁾ report that NaBF_4 dissociates slowly and will melt below red heat. Booth⁽⁹⁰⁾ has prepared boron trifluoride by the dissociation of sodium fluoborate in an inert molten solvent such as fused sodium or potassium chloride.

Crystals of sodium fluoborate were found to have no ultraviolet fluorescence after a 5-hour exposure to X rays.⁽⁶⁹⁴⁾

Motylewsky⁽⁶⁴⁹⁾ determined the drop weight of molten sodium fluoborate and found the value to be 119 mg. compared to 100 mg. for water at 0°C .

Sodium fluoborate is more soluble in water than sodium acid fluoride. Its solution has a bitter acid taste and is acidic to litmus.^(66, 68, 69, 70) De Boer *et al.*^(85, 86) have determined the refractive indices, for the sodium D line, for aqueous solutions of sodium fluoborate. A 6% solution has a refractive index of 1.3321 while a 12% solution has a value of 1.3312.

The salt is only sparingly soluble in alcohol.^(66, 68, 69, 70) Mathers and coworkers⁽⁵⁷⁹⁾ used an alcoholic solution of fluoboric acid to precipitate sodium fluoborate in the presence of potassium and magnesium compounds.

Finger and Reed^(260, 261) have used sodium fluoborate to synthesize aryldiazonium fluoborates (*vide infra*).

Boehm^(81, 82) studied the action of a solution of sodium fluoborate on the skeletal muscles of a frog and found that it produces a marked contracting action.

Potassium Fluoborate, KBF_4 . Potassium fluoborate, KBF_4 , is produced as a gelatinous-appearing precipitate by mixing fluoboric acid with a solution of a potassium salt such as the carbonate, hydroxide, nitrate, chloride, or sulfate.^(66, 68, 69, 70, 603, 756, 757, 794) When washed and dried it forms a gritty white powder. Berzelius made the salt also by dissolving a mole of potassium bicarbonate and a mole of boric acid in an excess of hydrofluoric acid and evaporating the resulting solution to promote crystallization.

* There are three uncorrected typographical errors in these data as recorded in reference 459. These are: $3.650/T$ should read $3650/T$; $4.025/T$ should read $4024/T$; and 16.96 kcal. should read 16.69 kcal.

Montemartini,⁽⁶³⁷⁾ Stromeyer,⁽⁸⁷⁵⁾ and Gamble, Gilmont, and Stiff⁽²⁸⁰⁾ used a somewhat similar method with potassium carbonate.

Thaddeff⁽⁸⁸⁶⁾ prepared potassium fluoborate by heating a borate with alcohol and sulfuric acid. The distillate was collected in an 80% potassium hydroxide solution. An excess of hydrofluoric acid was added, and the solution evaporated until hydrogen fluoride was no longer evolved. Potassium fluoborate precipitates on treatment of the solution with a solution of potassium acetate (sp. gr. 1.14) and methanol (sp. gr. 0.805). The success of the method depends on the fact that a special mixture of potassium acetate and alcohol is capable of retaining the potassium acid fluoride in solution.

Travers and Malaprade^(902, 903) titrated fluoboric acid with potassium hydroxide. When the resulting compound is heated to 580°C., a soluble salt is formed whose composition is indicated by the empirical formula, $\text{BF}_3 \cdot 2\text{KF}$, which reacts with additional potassium hydroxide. Boric acid and potassium fluoride react in a cold concentrated aqueous solution producing crystals containing boron and potassium in a one-to-one ratio and fluorine and boron in a three-to-one ratio.⁽⁹⁰⁵⁾

According to van der Meulen and van Mater,⁽⁶⁰⁰⁾ salts of fluoboric acid are nearly always contaminated by fluoride due to hydrolysis, especially if heated during drying. They conclude that potassium fluoborate is least affected in this way.

They prepare potassium fluoborate of theoretical composition from fluoboric acid and potassium hydroxide: 100 ml. of pure 47% hydrofluoric acid is placed in a platinum dish in an ice bath; 36.3 g. of pure boric acid is added in very small portions at intervals of several minutes to avoid loss of hydrogen fluoride by volatilization; after standing at room temperature 6 hours to complete the reaction as far as possible, the dish containing the fluoboric acid is placed again on an ice bath, and 5 *N* potassium hydroxide solution is added slowly, while it is stirred, until an externally tested sample is alkaline to methyl orange; upon thorough chilling, potassium fluoborate crystals separate; the crystalline precipitate is separated from the mother liquor by decantation and thorough draining, is washed by decantation three times with small portions of cold distilled water, then with 95% ethanol, and finally with ether, giving yields of 80 to 90%.

When a warm concentrated solution of boric acid is treated with potassium fluoride and hydrofluoric acid, the solution becomes alkaline to methyl orange:

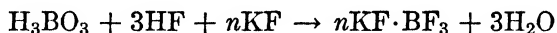

No immediate precipitate of potassium fluoborate is observable. If the solution is strongly acidified, the potassium fluoborate precipitates immediately. The reaction is reversible and is decreased by dilution. The treatment of potassium fluoborate with acids yields fluoboric acid in which the fluorine cannot be determined as potassium fluosilicate. An alkali fusion is required of the fluoborate in order to determine the fluorine as fluosilicate. The fact that potassium fluosilicate can be precipitated from an acidified solution of hydrofluoric and boric acids proves that the fluorine does not exist in the form of a stable fluoborate ion but rather as some other fluoborate less stable and soluble in water.^(767, 767a, 767c, 904, 935a) Normal fluoboric acid and its salts show limited decomposition in water, yielding fluoboric complexes decomposable by alkali. Hydrofluoric and boric acids in water instantly form a fluoboric acid different from HBF_4 , which on alkali decomposition yields HBF_4 at the expense of the former until an equilibrium is finally reached^(935a) When potassium fluoride reacts with fluoboric acid, HBF_4 , a potassium fluoborate is formed; however, it is not KBF_4 but instead is stated to be $(\text{K}_2\text{B}_2\text{F}_6)_2 \cdot 3\text{H}_2\text{O}$. By a dry process, K_2BF_5 is said to be formed.⁽⁹⁰²⁾

Potassium fluoborate, KBF_4 , has been prepared directly from boron trifluoride and potassium salts by a dry process involving the passage of the gas over the heated salts. Baumgarten and Bruns⁽⁶¹⁾ have prepared KBF_4 by the following reactions:

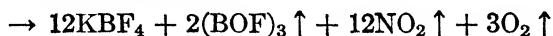
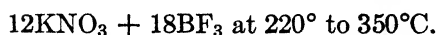
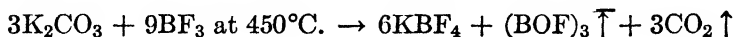
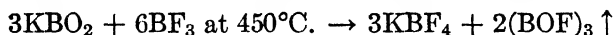

Stolba heated boric acid with potassium fluosilicate and then added potassium carbonate to the mixture.⁽⁸⁶⁶⁾ Potassium fluoborate may be prepared also by refluxing a mixture of fluorspar, boric acid, and sulfuric^(865, 867, 868) or hydrochloric⁽⁸⁶⁶⁾ acids for

2 to 3 hours, diluting with water, and then adding a warm saturated solution of potassium chloride or nitrate. The crystalline precipitate may be washed then with water, pressed, and recrystallized from a hot solution of ammonium hydroxide.⁽⁸⁶⁵⁾

Potassium fluoborate also has been prepared by allowing potassium chloride to react with boron trifluoride in the presence of hydrofluoric acid (or calcium fluoride and an acid to produce hydrofluoric acid). Heat and pressure expedite the reaction.⁽⁶⁰⁴⁾ Similarly, potassium fluoride or potassium chloride when heated under increased pressure with boric oxide or a borate along with calcium fluoride and hydrochloric acid produce potassium fluoborate.^(247, 248)

De Boer *et al.*^(85, 86) prepared potassium fluoborate by adding potassium chloride to a solution of fluoboric acid. When potassium carbonate, chloride, nitrate, sulfate, or hydroxide is added to an aqueous solution of boron trifluoride, potassium fluoborate precipitates.^(756, 757)

According to Berzelius,^(66, 68, 69, 70) the salt has a feeble somewhat bitter nonacidic taste and is not at all acid to litmus. It crystallizes from its aqueous solution in prismatic crystals containing no water of hydration. According to Montemartini,⁽⁶³⁷⁾ the salt is dimorphous, for the gritty powder indicated above contains octahedra and dodecahedra belonging to the cubic system, while the crystals obtained by evaporating an aqueous solution of the salt belong to the rhombic system. Pesce⁽⁶⁹⁵⁾ was unable to verify the results of Montemartini. He found the so-called cubic form reported by Montemartini to be identical with the rhombic form. For pertinent crystallographic data consult Table 22.

According to Zambonini,⁽⁹⁶⁶⁾ Klinkenberg,⁽⁴⁵⁸⁾ and Barker,⁽³⁹⁾ potassium fluoborate and potassium perchlorate are isomorphous. Zambonini⁽⁹⁶⁶⁾ found that potassium permanganate was miscible in solid solution up to 0.4% with potassium fluoborate. Pesce⁽⁶⁹⁵⁾ reports that potassium fluoborate is isomorphous with calcium sulfate, strontium sulfate, barium sulfate, lead sulfate, and potassium permanganate in addition to the perchlorate. Finback and Hassel⁽²⁵⁹⁾ and Vorländer, Hollatz, and Fischer⁽⁹⁸⁰⁾ have found that there is a transition at a temperature between 275 and 279°C. at which the rhombic changes to the cubic crystal lattice, in which the anion rotates in a manner similar to that found in the perchlorates. Grim, Köstermann, and Beyersdorfer⁽³²⁰⁾ confirmed the

TABLE 22

CRYSTALLINE STRUCTURE OF THE FLUOBORATES OF THE ALKALI METALS

Salt	Axis Lengths in Å.			Axial Ratios	Reference
	<i>a</i>	<i>b</i>	<i>c</i>		
NaBF_4	6.25 ± 0.02	6.77 ± 0.02	6.82 ± 0.01	0.922 :1:1.007	459
$\text{NaOH} \cdot \text{BF}_3$	6.24 ± 0.02	6.82 ± 0.01	6.85 ± 0.01	0.915 :1:1.004	459
KBF_4	7.84	5.68	7.37	2.7898:1:1.2830 1.382 :1:1.297	39, 637 695
RbBF_4	9.07	5.60	7.23	0.8067:1:1.2948 1.620 :1:1.291	967 372
CsBF_4	9.43 ± 0.10	5.83 ± 0.07	7.65 ± 0.02	1.617 :1:1.310	459
NH_4BF_4	8.89 ± 0.05 9.06	5.68 ± 0.05 5.64	7.21 ± 0.03 7.23	1.58 :1:1.27 1.606 :1:1.282	460 372

earlier report by Zambonini⁽⁹⁶⁶⁾ that potassium fluoborate and potassium permanganate are isomorphous by preparing mixed crystals of the two salts. Similarly, they showed that potassium fluoborate and barium sulfate are isomorphous.

Stolba⁽⁸⁶⁶⁾ reported the specific gravity of potassium fluoborate at 20°C. to be between 2.498 and 2.524. De Boer and van Liempt⁽⁸⁶⁾ reported the density to be 2.5 while Pesce⁽⁶⁹⁵⁾ determined the density to be between 2.554 and 2.559 at 20°C. and 2.555 at 100°C.

Motylewsky⁽⁶⁴⁹⁾ found the drop weight of molten potassium fluoborate to be 103 compared to 100 mg. for water at 0°C.

According to Berzelius,^(66, 68, 69, 70) the undried crystals decrepitate when heated, evolving water and forming some fluoboric acid. Stolba^(866, 868) observed that the wet crystals impart a green color to a flame, which gradually changes to a greenish-violet color and finally becomes violet. Berzelius,^(66, 68, 69, 70) Stolba,^(866, 868) and Stromeyer⁽⁸⁷⁵⁾ found that the dry salt decomposed into boron trifluoride and potassium fluoride when heated. The decomposition temperature is around 593°C.⁽¹⁹⁰⁾ When heated rapidly, potassium fluoborate melts at 530°C.^(68, 122)

De Boer and van Liempt⁽⁸⁶⁾ have found that the heat of dissociation is 28,900 cal. per mole for the reaction:



The vapor pressure of the fused potassium fluoborate is expressed best by the equation:

$$\log p_{\text{mm.}} = -\frac{6317}{T} + 8.15$$

The heat of formation of potassium fluoborate from a potassium ion and a fluoborate ion has been reported to be 148,000 cal.⁽⁸⁶⁾

Booth⁽⁹⁰⁾ prepared boron trifluoride by adding potassium fluoborate to fused sodium or potassium chloride. Hellriegel⁽³⁵²⁾ heated a mixture of boric oxide and potassium fluoborate at 518°C. to produce boron trifluoride along with $\text{KF} \cdot \text{B}_4\text{O}_6$. The latter compound is similar to glassy $\text{K}_2\text{B}_4\text{O}_7$ in water solubility. When fused with boric oxide, $\text{KF} \cdot \text{B}_4\text{O}_6$ produces higher fluopolyborates. Rummelsburg^(756, 757) has prepared boron trifluoride by heating dry potassium fluoborate with sulfuric acid and boric oxide. Borax may be substituted for the boric oxide.⁽⁸⁶⁾

The index of refraction of potassium fluoborate is lower than that of water. A saturated solution of potassium fluoborate in water (0.6%) on heating gives color effects if some excess of solid potassium fluoborate crystals are present. With a 10% aqueous solution, a transparent blue color appears at 100°C., turning green at 90°C., and yellow at 60°C. In a concentrated fluoboric acid solution, these phenomena occur at room temperature.^(83, 85) (See the discussion of solutions of cesium fluoborate following.)

The aqueous solution of potassium fluoborate is at first neutral to litmus, but upon standing, dilution, or heating it becomes acidic without attacking the glassware.^(66, 68, 69, 70) According to Stolba the aqueous solution is decomposed into potassium fluoride, fluoboric acid, and hydroxyfluoboric acid. Upon evaporation these compounds combine to form potassium fluoborate. Berzelius^(66, 68, 69, 70) found that the salt is not decomposed by a solution of ammonium hydroxide nor by solution of sodium or potassium hydroxides or carbonates. Potassium fluoborate is no more soluble in the afore-mentioned solutions than it is in water.

Ray and Mitra⁽⁷²⁷⁾ have studied the system $\text{KClO}_4\text{-KBF}_4\text{-H}_2\text{O}$ at 25°C. and have found that $\text{KClO}_4 \cdot 2\text{KBF}_4$ and $\text{KClO}_4 \cdot 8\text{KBF}_4$ exist. These compounds are stable only in an excess of potassium perchlorate and in water decompose with the separation of potassium fluoborate.

Rose⁽⁷³⁸⁾ found potassium fluoborate to be more soluble in a solution of ammonium chloride than it is in water. Stromeyer⁽⁸⁷⁵⁾

reported that it is not soluble in a 20% solution of potassium acetate. Thaddeeff ⁽⁸⁸⁶⁾ made numerous solubility tests on potassium fluoborate. He found that 100 ml. of potassium acetate (sp. gr. 1.14) will dissolve 0.0324 g. of potassium fluoborate and that 100 ml. of acetic acid (63%, sp. gr. 1.07) will dissolve 0.127 g. of potassium fluoborate at temperatures between 18 and 24°C. For data dealing with the water solubility of the salt, see Table 23.

TABLE 23

SOLUBILITIES OF THE FLUOBORATES OF THE ALKALI METALS

Grams of Salt per 100 g. of Water

Salt	3°	16°	17°	20°	23°	25°	33°	40°	100°C.	Reference
KBF_4	0.5214	886
	0.3	..	0.6	0.448	6.27	866
	1.0	1.4	ca. 8.5	86
	0.55	190
RbBF_4	0.25	..	0.6	1.5	ca. 10	86
	0.55	1.00	310
CsBF_4	0.9	..	1.6	ca. 4	ca. 30	86
	0.92	0.04	310
NH_4BF_4	25	95-98	865
	20.3	190

Rose ⁽⁷³³⁾ observed that the salt is not soluble in cold alcohol, but Berzelius ^(66, 68, 69, 70) reported it to be slightly soluble in hot alcohol, with crystals being deposited upon cooling the solution. Stromeier ⁽⁸⁷⁵⁾ and de Marignac ⁽⁶⁷⁷⁾ found that potassium fluoborate reacts with alkali carbonates when fused to form the alkali fluoride and borate. Stolba based a volumetric determination of soda on this reaction.

Boron trichloride or boron tribromide is produced along with potassium fluoride and aluminum fluoride when potassium fluoborate is heated to a temperature between 150 and 175°C. with aluminum chloride or aluminum bromide, respectively. ⁽²⁸⁰⁾

Sulfuric acid reacts with potassium fluoborate in the following manner: ^(66, 68, 69, 70)



Schiff ⁽⁷⁷¹⁾ reported the use of this salt to prepare boron trifluoride, thus:

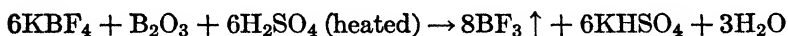

Stolba found that potassium fluoborate was decomposed by fluosilicic acid and by a mixture of silicic and hydrochloric acids.

A saturated solution of potassium fluoborate and boric acid was used to study the hydrolysis of the fluoborate ion by Ruiss and Bakina.⁽⁷⁵⁰⁾ They determined the *pH* of solutions of potassium fluoride in the above solution up to a concentration of 0.9690 *M* potassium fluoride. The equilibrium constant at 18°C. for the reaction,

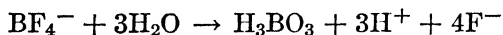

was found to be $2.51 \cdot 10^{-19}$. The *pH* of a 0.0328 *M* (saturated) solution of potassium fluoborate was found to be 2.50, and for a 0.00328 *M* solution the *pH* was 2.98 (see above under "Fluoboric Acid").

Boehm^(81, 82) discovered that an aqueous solution of potassium fluoborate produces contracture reactions on the skeletal muscles of a frog.

Stolba⁽⁸⁶⁸⁾ suggested the use of potassium fluoborate as a soldering flux but added that the resulting evolution of boron trifluoride was objectionable. A flux containing potassium fluoborate and tetraborate has been patented⁽⁵⁹⁶⁾ for brazing with silver solder. Curtis⁽¹⁹⁰⁾ has suggested the use of potassium fluoborate to inhibit baked magnesium sand molds.

Rubidium Fluoborate, RbBF_4 . Godeffroy⁽³¹⁰⁾ prepared rubidium fluoborate in a manner similar to that used for potassium fluoborate by Stolba.^(865, 866, 867) Zambonini⁽⁹⁶⁷⁾ made the rubidium salt by adding rubidium carbonate to a solution of boric acid in a 35% hydrofluoric acid solution. De Boer *et al.*^(85, 86) prepared rubidium fluoborate by the addition of rubidium chloride to an aqueous solution of a fluoborate or by the addition of rubidium chloride to an aqueous solution of fluoboric acid.

Sheintsis⁽⁷⁹⁴⁾ prepared rubidium fluoborate by treating a 2 *N* solution of fluoboric acid with rubidium salts. Rubidium fluoborate was prepared by Rummelsburg^(756, 757) by adding rubidium carbonate, chloride, nitrate, sulfate, or hydroxide to an aqueous solution of boron trifluoride.

Rubidium fluoborate does not give the color effects with the mother liquor as observed with cesium fluoborate (*vide infra*), but it does so with water. A saturated solution of rubidium fluoborate (0.6 g. per 100 g. of water) has a refractive index, n_D , of 1.3332 at

20°C., equivalent to that of water.⁽⁸⁵⁾ An excess of solid rubidium fluoborate in this solution produces a yellow color. (See discussion of this phenomenon with cesium fluoborate in the following.)

In aqueous solutions the salt forms as a gelatinous-appearing mass, which, when washed and dried, forms a crystalline powder. Good crystals are obtained by the slow evaporation of the mother liquor filtered from the gelatinous mass. Crystalline rubidium fluoborate melts at 590°C.⁽⁸⁶⁾ The vapor pressure of fused rubidium fluoborate may be expressed as

$$\log p_{\text{mm.}} = -\frac{5900}{T} + 7.45$$

The heat of dissociation has been calculated from the vapor-pressure data to be 26,960 cal. per mole for the reaction:



Zambonini⁽⁹⁶⁷⁾ found that the rubidium salt is isomorphous with the rhombic form of the potassium salt, which in turn is isomorphous with potassium perchlorate, potassium periodate, potassium permanganate, and rubidium permanganate. Klinkenberg⁽⁴⁵⁸⁾ reported the salt to be isomorphous with rubidium perchlorate. (For pertinent crystallographic data see Table 22.)

The specific gravity of solid rubidium fluoborate has been reported to be 2.820^(86, 967) at 20°C. For the solubility of this salt in water, see Table 23.

When rubidium fluoborate is heated with sulfuric acid and boric oxide, boron trifluoride is evolved.^(756, 757)

Cesium Fluoborate, CsBF₄. Rummelsburg^(756, 757) precipitated cesium fluoborate from an aqueous solution of boron trifluoride by the addition of chloride, nitrate, sulfate, hydroxide, or carbonate of cesium.

De Boer *et al.*^(83, 85, 86) observed that precipitates of cesium fluoborate which were formed by the addition of cesium chloride to fluoboric acid are jelly-like, are transparent in their mother liquor, and show interesting color effects. This is explained as being due to the fact that the mean refractive index of the cesium fluoborate is almost equal to that of the solution while the dispersion is different. All the spectral colors can be produced by suitably heating or diluting the solution. The refractive index, n_D , was found to be between 1.3563 and 1.3502. This low value is in agreement

with calculations based on the ionic refraction value which is between 2.5 and 1.9, giving a refraction of around 7.65 for the fluoborate ion. This value when added to the value of cesium refraction (6.24) gives a value of 1.33 on the assumption that neither ion is strongly deformed.⁽⁸⁵⁾ Sheintsis⁽⁷⁹⁴⁾ prepared cesium fluoborate by adding cesium salts to a 2 *N* solution of fluoboric acid. For the solubility of cesium fluoborate in water see Table 23.

The crystals of cesium fluoborate have a density of 3.2⁽⁶⁸⁾ and are isomorphous with cesium perchlorate⁽³¹⁷⁾ as shown by their axial ratios (see Table 22). Klinkenberg and Ketelaar⁽⁴⁶⁰⁾ have suggested that cesium fluoborate is not isomorphous with cesium perchlorate. It is probably dimorphous having one rhombic modification isomorphous with the perchlorate, while the other modification is tetragonal (pseudocubic) and is not isomorphous with the high-temperature cubic modification of cesium perchlorate.

The crystals melt at 550°C.⁽⁸⁶⁾ According to de Boer and van Liempt,⁽⁸⁶⁾ the vapor pressure of fused cesium fluoborate may be expressed best by the equation,

$$\log p_{\text{mm.}} = -\frac{5880}{T} + 7.35$$

From these data the heat of dissociation was calculated to be 26.88 kcal. per mole for the reaction,



The dry salt when heated in the presence of sulfuric acid and boric acid produces boron trifluoride.^(756, 757)

Ammonium Fluoborate, NH_4BF_4 . In 1809 Gay-Lussac and Thénard prepared ammonium fluoborate by the reaction of fluoboric acid with ammonia and observed that it could be sublimed.^(290, 292, 293)

Berzelius^(66, 68, 69, 70) later prepared ammonium fluoborate by allowing boric oxide to react with ammonium fluoride. The oxide is instantly dissolved, and ammonia is evolved as shown by the equation:



The product may be rewritten as $2\text{NH}_4\text{BF}_4 \cdot 3\text{H}_2\text{O}$. If no excess of boric acid is used, ammonium fluoborate is obtained upon

evaporation of the solution. The dry salt may be sublimed to free it from boric oxide. Recent work shows that ammonium fluoborate exists only as the anhydrous salt.⁽⁹⁶²⁾

Booth and Rehmar⁽⁹⁷⁾ prepared pure ammonium tetrafluoroborate in a simple one-step procedure by reacting boric acid with ammonium bifluoride according to the equation:



For preparing small amounts they recommend carrying out the reaction in the presence of water: 33 g. of ammonium hydrogen fluoride and 13 g. of boric acid are heated with 100 ml. of water in a platinum dish; when solution is complete and after some evaporation, the solution is cooled, whereupon long needle-like crystals separate. Impurities in the ammonium bifluoride such as lead fluosilicate and sulfates do not contaminate the crystals.

For larger amounts the reaction is carried out by fusion in a deep steel skillet: 120 g. of boric acid and 280 g. of ammonium bifluoride are mixed and slowly heated until quiet fusion is attained and evolution of gases is complete; the fused melt is poured out on a steel or nickel plate to solidify; the solid is dissolved in 300 ml. of boiling water and cooled slowly to crystallization. Several crops of crystals may be obtained. The yield may be nearly quantitative.

Boron nitride is slowly solvolyzed by aqueous hydrofluoric acid to yield a solution of ammonium fluoborate:

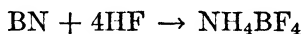

Stolba⁽⁸⁶⁵⁾ obtained the salt by subliming the product obtained when boric acid was allowed to react with ammonium fluosilicate. He also prepared it by adding ammonium hydroxide to a saturated solution of boric acid in hydrofluoric acid until the solution was alkaline. The crystals appeared after the solution was boiled, filtered, and allowed to cool. Purification of the crystals was carried out by fractional crystallization from the aqueous solutions. The salt cannot be prepared by the reaction of ammonia with boron trifluoride.^(66, 68, 69, 70)

When prepared by sublimation, the product is a white powder except for that formed in the hotter parts of the reactor, which is fused and transparent. According to Stolba, the salt volatilizes from a platinum dish without leaving any residue.^(865, 870) Curtis⁽¹⁹⁰⁾

reports that it sublimates at 230°C., but this value, it will be noticed, is below the transition temperature for the two solid crystalline states (*vide infra*). When the vapor is heated to 600°C. it decomposes, yielding nitrogen, hydrogen, and fluoboric acid.⁽⁹⁴⁵⁾

The pressure-temperature equation for ammonium fluoborate is $\log p_{\text{mm.}} = -2469/T + 6.82$, and its molar heat of sublimation is 11.3 kcal.^(492a)

The crystals obtained from an aqueous solution form "small six-sided prisms with dihedral summits."^(66, 68, 69, 70) Recrystallization from ammonium hydroxide does not affect the crystalline structure. Finbak and Hassel⁽²⁵⁹⁾ have studied the high-temperature transition from the rhombic to the cubic crystal lattice. Vörländer, Hollatz, and Fischer⁽⁹³⁰⁾ have found this transition temperature to be around 236°C. The crystalline structure of ammonium fluoborate is similar to that of ammonium perchlorate^(458, 460) (see Table 22 for crystallographic data).

Stolba⁽⁸⁶⁵⁾ found the specific gravity of ammonium fluoborate to be 1.851 at 17.5°C. At 25°C. Balz and Zinser⁽⁸⁴⁾ found the value to be 1.854 corresponding to a molar volume of 56.5 ml. Klinkenberg and Ketelaar⁽⁴⁶⁰⁾ calculate a value of 1.98.

The salt tastes like ammonium chloride and imparts a green color to a flame.^(865, 870) An alcoholic solution of ammonium fluoborate burns with a flame which is not green. Berzelius^(66, 68, 69, 70) found that the salt dissolves freely in alcohol and in water.

For solubility data in water see Table 23. The aqueous solution is acidic to litmus. Turmeric paper on being treated with a solution of ammonium fluoborate followed by hydrochloric acid produces a boron stain on drying.⁽⁸⁷⁰⁾ The aqueous solution does not attack glass and resembles a solution of the potassium salt.

Ammonium fluoborate may be used satisfactorily in the preparation of aryldiazonium fluoborates by the Schiemann reaction. (See discussion of fluoborates used in organic chemistry in the following pages.) Stolba⁽⁸⁶⁵⁾ observed that ammonium fluoborate exhibited feeble antiseptic properties.

Ammonium fluoborate is used in electroplating baths in the plating of cadmium, zinc, and indium.^(172, 655)

Ammonium fluoborate from 0.5 to 10% is mixed with molding compositions to prevent oxidation of molten magnesium when poured into the mold.⁽²⁸¹⁾ Readily oxidizable metals, such as magnesium and its alloys, are protected from oxidation while molten

by ammonium fluoborate⁽⁷²⁹⁾ being maintained in contact with the surface of the metal.

FLUOBORATES OF THE ALKALINE-EARTH METALS

Sheintsis⁽⁷⁹⁴⁾ was unable to obtain a precipitate upon addition of beryllium salts to a 2 *N* solution of fluoboric acid.

Hexaquomagnesium Fluoborate $[\text{Mg}(\text{H}_2\text{O})_6](\text{BF}_4)_2$. Berzelius^(66, 68, 69, 70) first reported the existence of magnesium fluoborate. Funk and Binder⁽²⁷⁷⁾ have prepared what they considered to be the heptahydrate by allowing a 30% solution of fluoboric acid to react with magnesium metal, magnesium oxide, or magnesium carbonate. Wilke-Dörfurt and Balz⁽⁹⁵²⁾ used a somewhat similar procedure in which they reacted a 40% solution of fluoboric acid with the carbonate. The magnesium fluoride which formed at first was filtered off and the resulting filtrate placed in a vacuum desiccator over sulfuric acid. When the boric acid crystals appeared, they were filtered off and the remaining filtrate placed in a vacuum desiccator over phosphorus pentoxide. Later, when the vacuum was no longer needed, the magnesium fluoborate crystals were dried over sulfuric acid. The crystals lost their water of hydration when dried for 3 weeks with phosphorus pentoxide.⁽²⁷⁷⁾

Magnesium fluoborate crystallizes in large prismatic crystals which are very hygroscopic and which are extremely soluble in water. A 95% solution of ethanol dissolves the crystals.⁽²⁷⁷⁾ At 50°C. the crystals begin to decompose.⁽²⁷⁷⁾ Berzelius^(66, 68, 69, 70) observed that the crystals had a bitter taste similar to that possessed by other salts of magnesium.

Hexaquomagnesium Bis(hexamethylenetetramine) Difluoborate Dihydrate, $[\text{Mg}(\text{H}_2\text{O})_6][\text{BF}_4 \cdot \text{C}_6\text{H}_{12}\text{N}_4 \cdot \text{H}_2\text{O}]_2$. Wilke-Dörfurt and Balz⁽⁶⁴⁸⁾ prepared hexaquomagnesium bis(hexamethylenetetramine)difluoborate dihydrate, $[\text{Mg}(\text{H}_2\text{O})_6][\text{BF}_4 \cdot \text{C}_6\text{H}_{12}\text{N}_4 \cdot \text{H}_2\text{O}]_2$, by mixing a saturated solution containing magnesium sulfate and ammonium fluoborate with a saturated solution of hexamethylenetetramine at -10°C. The product forms as a precipitate which is filtered off and washed with a small quantity of the cooled hexamethylenetetramine solution and then with alcohol, after which it is air-dried.

The crystals are silky glasslike colorless flakes. In polarized light the crystals appear as oblique double-refracting prisms and

plates exhibiting oblique extinction. The crystals are readily soluble in water but insoluble in alcohol.

Diaquocalcium Fluoborate, $[\text{Ca}(\text{H}_2\text{O})_2](\text{BF}_4)_2$. Calcium fluoborate was first prepared by Berzelius^(66, 68, 69, 70) by allowing calcium fluoride to dissolve in fluoboric acid. He also prepared it by the addition of calcium carbonate to the acid, a method which was later improved by Funk and Binder⁽²⁷⁷⁾ and by Wilke-Dörfurt and Balz.^(950, 952) Funk and Binder found metallic calcium to be soluble in fluoboric acid.⁽²⁷⁷⁾ Wilke-Dörfurt and Balz⁽⁹⁵²⁾ used the same procedure as described previously for the preparation of magnesium fluoborate. The gelatinous precipitate which Berzelius claimed to have obtained is not pure, according to Wilke-Dörfurt and Balz, and Funk and Binder. Instead they observed that calcium fluoborate crystallizes as colorless double-refractive platelike crystals which are very hygroscopic. The work of Berzelius^(66, 68, 69, 70) supports the research of Wilke-Dörfurt and Balz. Berzelius reported that water, especially if hot, dissolved the acidic component of calcium fluoborate and left a residue of a basic salt containing an excess of calcium fluoride. Evidently, the calcium fluoborate dissolved and left the impurities behind.

Wilke-Dörfurt and Balz⁽⁹⁵²⁾ obtained evidence under different experimental conditions for the existence of the dihydrate and not the pentahydrate.⁽²⁷⁷⁾

Calcium fluoride, when added to solutions of $\text{BF}_3 \cdot \text{H}_2\text{O}$, $\text{BF}_3 \cdot 2\text{H}_2\text{O}$, $\text{BF}_3 \cdot 3\text{H}_2\text{O}$, or $\text{BF}_3 \cdot 2\text{CH}_3\text{COOH}$ and heated to 250°C ., forms calcium fluoborate.^(235, 888)

The salt tastes acidic and is acidic to litmus.^(66, 68, 69, 70) It is very soluble in water or in a 95% solution of ethanol.^(277, 952)

If calcium fluoborate is stored for a long time over phosphorus pentoxide it will lose its water of hydration.⁽²⁷⁷⁾ Upon heating to temperatures between 40 and 50°C . the water of crystallization is lost, and at temperatures between 300 and 500°C . calcium fluoborate dissociates into boron trifluoride and calcium fluoride.^(235, 888, 952) The reaction is irreversible,⁽⁸⁶⁾ the calculated heat of reaction being negative.

Diaquostrontium Fluoborate, $[\text{Sr}(\text{H}_2\text{O})_2](\text{BF}_4)_2$. Strontium carbonate dissolves in a 30%⁽²⁷⁷⁾ or a 40%⁽⁹⁵²⁾ solution of fluoboric acid. Upon evaporation crystals of tetraquostrontium fluoborate were obtained by Funk and Binder.⁽²⁷⁷⁾ However, using the fractional crystallization methods described previously for

magnesium fluoborate, Wilke-Dörfurt and Balz^(950, 952) obtained the dihydrate as platelike colorless doubly refracting crystals. The crystals of strontium fluoborate are less hygroscopic and less soluble in ethanol than the calcium salt.⁽²⁷⁷⁾ Strontium fluoborate is very soluble in water.⁽²⁷⁷⁾

On long standing over phosphorus pentoxide or on heating to 60°C., the water of hydration is lost.⁽²⁷⁷⁾

Diaquobarium Fluoborate, $[\text{Ba}(\text{H}_2\text{O})_2](\text{BF}_4)_2$. Barium fluoborate dihydrate is normally prepared by allowing barium carbonate to react with a 30% solution of fluoboric acid.^(66, 68, 69, 70, 277) If too much barium carbonate is added, barium fluoride and boric acid are formed. Upon evaporation boric acid is removed first by fractional crystallization (compare method of Wilke-Dörfurt and Balz for fluoborates of alkaline-earth metals).^(66, 68, 69, 70) Sheintsis⁽⁷⁹⁴⁾ has precipitated barium fluoborate from a 2 *N* solution of fluoboric acid, using barium salts.

Berzelius characterized the crystals as "four-sided rectangular prisms."^(66, 68, 69, 70) The crystals taste like other barium salts but are not "in the least degree acidic" like the fluoborates of the other alkaline-earth metals. Upon standing for many days over phosphorus pentoxide 1 molecule of water is lost.⁽²⁷⁷⁾ Upon heating to a temperature between 40 and 50°C., the water of hydration is driven off, and the crystals effloresce. Berzelius observed that, when heated strongly, the fluoboric acid is evolved first and then boron trifluoride, leaving barium fluoride as a residue.^(66, 68, 69, 70)

Barium fluoborate is less deliquescent than strontium fluoborate and is readily soluble in water. Ethanol dissolves the acidic portion of the crystals (?) leaving a basic pulverulent residue behind (impurities, for example, barium fluoride?) (compare the solubility of calcium fluoborate in hot water).^(66, 68, 69, 70, 277)

FLUOBORATES OF METALS IN GROUP III

Aluminum Fluoborate, $[\text{Al}(\text{H}_2\text{O})_n](\text{BF}_4)_3$. Berzelius^(66, 68, 69, 70) prepared hydrated aluminum fluoborate by allowing aluminum hydroxide to react with fluoboric acid. The solution was evaporated slowly to facilitate the precipitation of the product. Hydrated aluminum fluoborate is soluble only in acidified water.

Berzelius found that a basic compound precipitates when aluminum chloride is added to a solution of sodium fluoborate. The mother liquor is acidic and thus retains a part of the product

in solution. Upon heating to red heat, the product gives off water and fluoboric acid, leaving a residue of aluminum borate ^(66, 68, 69, 70)

Yttrium Fluoborate, $[Y(H_2O)_n](BF_4)_3$. Using a mixture *then* thought to contain pure yttrium, Berzelius ^(66, 68, 69, 70) reported that he had prepared hydrated yttrium fluoborate, using the same procedure that he had used to make aluminum fluoborate. The crystalline product separated from the solution upon slow evaporation. Like the aluminum salt, yttrium fluoborate is soluble only in acidified water.

FLUOBORATES OF THE TRANSITION METALS

Hexamminechromium (III) Fluoborate, $[Cr(NH_3)_6](BF_4)_3$. Wilke-Dörfurt and Balz ⁽⁹⁵²⁾ prepared hexamminechromium (III) fluoborate by allowing an aqueous solution of hexamminechromium (III) nitrate to react with an excess of fluoboric acid. The crude product thus obtained was washed with alcohol and then dissolved in warm water from which the purified salt was precipitated upon acidification.

Hexamminechromium (III) fluoborate is a citron-yellow-colored crystalline powder, consisting of small isotropic octahedra. It is slightly soluble in water. It is resistant to the action of concentrated sulfuric acid for a long time. It is more sensitive to the hydrolytic action of hot water than the corresponding cobalt salt (*vide infra*).

Balz and Zinser, ⁽³⁴⁾ using hexamminechromium (III) fluoborate, prepared as described previously, studied its thermal decomposition. They observed that decomposition began at a temperature around 160°C. and continued up to a temperature of 290°C., above which no further decomposition was observed. The decomposition may be expressed in the equation:

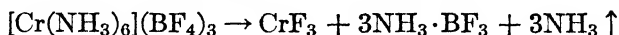

The density of hexamminechromium (III) fluoborate at 25°C. was found to be 1.863 from which the molecular volume was calculated to be 222.6 cc. ⁽³⁴⁾

A chromium electroplating bath containing chromium fluoborate ⁽⁶⁵⁵⁾ has been reported.

Hexacarbamidechromium (III) Fluoborate, $[Cr(OCN_2H_4)_6](BF_4)_3$. By adding some hexacarbamidechromium (III) chloride

to an excess of a water solution of fluoboric acid, a crystalline precipitate of hexacarbamidechromium (III) fluoborate was prepared.⁽⁹⁵²⁾ The crude product was washed with alcohol and recrystallized from a water solution by addition of an acid. The new crop of crystals was washed with dilute fluoboric acid followed by alcohol and then dried over sulfuric acid.

The product forms in splendid emerald-green oblique-sectioned needle-like crystals which are doubly refracting with parallel extinction. The crystals exhibit beautiful dichroism, being a blue color parallel to the plane of vibration of the polarized light and a green color perpendicular to the plane of vibration.

Hexacarbamidechromium (III) fluoborate is slightly soluble in water and practically insoluble in alcohol. It may be recrystallized from hot water but only part of the original material will be obtained in the product.

Hexaquomanganese (II) Fluoborate, $[\text{Mn}(\text{H}_2\text{O})_6](\text{BF}_4)_2$. Funk and Binder⁽²⁷⁸⁾ and Wilke-Dörfurt and Balz^(950, 952) prepared hexaquomanganese (II) fluoborate by allowing manganous carbonate to react with fluoboric acid. By fractional crystallization almost colorless doubly refracting needle-like crystals were obtained. The crystals may be dried over phosphorus pentoxide without losing their water of hydration. The crystals are hygroscopic and soluble in water, ethanol, and an alcohol-ether mixture.^(278, 952) The density at 25°C. is reported to be 1.994 from which the molecular volume is calculated to be 168.8.⁽³⁴⁾

Hexamminemanganese (II) Fluoborate, $[\text{Mn}(\text{NH}_3)_6](\text{BF}_4)_2$. Upon addition of a solution of purified manganous fluoborate to a hot strongly alkaline solution of ammonium fluoborate, hexamminemanganese (II) fluoborate was precipitated. This reaction was carried out in an air-tight reaction vessel, and the ammonium fluoborate solution contained a little hydroxylamine to help prevent oxidation. The crystalline precipitate was filtered in a nitrogen atmosphere and washed with an alcoholic solution of ammonia. The first washings contained hydroxylamine hydrochloride. The crystals were dried in an atmosphere of nitrogen and ammonia.⁽⁹⁵²⁾

The crystals of hexamminemanganese (II) fluoborate are glass-like, almost colorless, and very small. When observed under a microscope using polarized light, they appear as isotropic octahedra.⁽⁹⁵²⁾

The dry crystals are superficially oxidized in a short time, yielding a brown-colored product. The moist crystals are similarly

oxidized in much less time. As seen from the method of preparation, the salt is stable in ammoniacal solutions containing hydroxylamine. Hexamminemanganese (II) fluoborate remains unchanged when sealed in a glass tube with ammonium fluoborate.⁽⁹⁵²⁾

The salt is difficultly soluble in ammonium hydroxide solution.⁽⁹⁵²⁾

Hexaquo manganese (II) Bis(hexamethylenetetramine) Difluoborate Dihydrate, $[\text{Mn}(\text{H}_2\text{O})_6][\text{BF}_4 \cdot \text{C}_6\text{H}_{12}\text{N}_4 \cdot \text{H}_2\text{O}]_2$. This salt is produced by treating a saturated aqueous solution of manganous fluoborate with a solution of hexamethylenetetramine. Upon slight warming crystals appear which are purified as described previously in the discussion of the analogous magnesium salt.⁽⁹⁵²⁾ The salt forms colorless needle-like crystals which are strongly doubly refracting and exhibit oblique extinction. They are very soluble in water but insoluble in alcohol.⁽⁹⁵²⁾

Tris(ethylenediamine)manganese (II) Fluoborate, $[\text{Mn}(\text{en})_3](\text{BF}_4)_2$. Spacu and Dima⁽⁸³¹⁾ prepared this salt by the reaction of an absolute alcohol solution of manganous fluoborate with an absolute alcohol solution of ethylenediamine hydrate. It precipitates as white needle-like crystals which after filtering and washing with absolute alcohol and absolute ether are a light-brown color (probably due to slight oxidation). The complex salt is soluble in water but insoluble in alcohol and ether.

Dipyridinemanganese (II) Fluoborate, $[\text{Mn}(\text{py})_2](\text{BF}_4)_2$. This complex salt was prepared by Spacu and Dima⁽⁸³¹⁾ by allowing a solution of manganous fluoborate and pyridine in ether to stand in the absence of air for 2 days. The thus-formed crystals were filtered and washed with ether. The product is a colorless crystalline mass which easily loses pyridine and is soluble in water but not appreciably soluble in alcohol and ether.

Hexaquoiron (II) Fluoborate, $[\text{Fe}(\text{H}_2\text{O})_6](\text{BF}_4)_2$. Funk and Binder first prepared this salt by allowing iron filings to dissolve in a 30% solution of fluoboric acid upon heating.⁽²⁷⁷⁾ Wilke-Dörfurt and Balz⁽⁹⁵²⁾ have prepared this salt by dissolving ferrous carbonate in fluoboric acid. Upon evaporation in a carbon dioxide atmosphere hexaquoiron (II) fluoborate crystallized out of solution. The pale-green needle-like crystals are doubly refracting and are very hygroscopic. They are extremely soluble in water and alcohol and much less soluble in an alcohol-ether mixture.⁽⁹⁵²⁾

The water of hydration cannot be removed by drying over phosphorus pentoxide. Upon heating, both water and boron trifluoride are evolved.⁽²⁷⁷⁾ Wilke-Dörfurt and Balz^(950, 952) consider this compound to be hexaquoiron (II) fluoborate analogous to the hexammineiron (II) fluoborate.

Iron is sometimes electroplated from a ferrous fluoborate electrolyte.⁽⁶⁵⁶⁾

Hexammineiron (II) Fluoborate, $[\text{Fe}(\text{NH}_3)_6](\text{BF}_4)_2$. Using the same technic as described previously for the preparation of the corresponding manganous salt, Wilke-Dörfurt and Balz⁽⁹⁵²⁾ reacted an ammoniacal solution of ammonium fluoborate with a solution of ferrous fluoborate (free from ferric ions) in the absence of air. The precipitate contained isotropic octahedra whose solubility behavior closely resembled that which would be expected of hexammineiron (II) fluoborate. Owing to the fact that the salt is so easily oxidized, it was not possible to make an analysis of it.⁽⁹⁵²⁾

Hexaquocobalt (II) Fluoborate, $[\text{Co}(\text{H}_2\text{O})_6](\text{BF}_4)_2$. Berzelius^(66, 68, 69, 70) reported that he had prepared cobalt fluoborate as a white powder. More recently, Funk and Binder⁽²⁷⁷⁾ and Wilke-Dörfurt and Balz^(950, 952) prepared the hexahydrate by dissolving cobaltous carbonate in a 30% solution of fluoboric acid. The crystals appeared upon evaporation. They are red-colored needles, 0.5 to 1.0 cm. in length, and are doubly refracting and deliquescent. They are very soluble in water and alcohol and less soluble in an alcohol-ether mixture.^(277, 952)

Drying the crystals over phosphorus pentoxide did not remove the water of hydration. However, by heating to a temperature between 70 and 80°C. the crystals were dehydrated.⁽²⁷⁷⁾

At 25°C. the density is 2.088 corresponding to a molecular volume of 163.2.⁽³⁴⁾

Owing to the fact the hexamminecobalt (II) fluoborate is very easily prepared, Wilke-Dörfurt and Balz⁽⁹⁵²⁾ consider this compound to be hexaquocobalt (II) fluoborate, $[\text{Co}(\text{H}_2\text{O})_6](\text{BF}_4)_2$.

Hexamminecobalt (II) Fluoborate, $[\text{Co}(\text{NH}_3)_6](\text{BF}_4)_2$. Wilke-Dörfurt and Balz⁽⁹⁵²⁾ prepared this complex by adding a hot solution of cobaltous fluoborate to a hot strong ammoniacal solution of ammonium fluoborate in the absence of air. Upon cooling, the crystals precipitated. The mother liquor was decanted and the crystals washed with an ammoniacal solution of alcohol and then dried *in vacuo* over sodium hydroxide in an atmosphere of ammo-

nia. The product is a rose-colored crystalline powder consisting of regular octahedra which evolve ammonia and change to a blue-colored substance in air. This color change also takes place in a moderately dilute solution of ammonium hydroxide.

In a moist condition, the complex is easily oxidized in air. Upon heating, a tetrammine is formed as indicated by the purple color, which changes upon further heating to a blue color which is probably due to the formation of a diaquotetrammine salt. The density of the complex hexammine salt has been determined at 25°C. to be 1.544 from which the molecular volume is calculated to be 217.0.⁽³⁴⁾

Hexaquocobalt (II) Bis(hexamethylenetetramine) Difluoroborate Dihydrate, $[\text{Co}(\text{H}_2\text{O})_6][\text{BF}_4 \cdot \text{C}_6\text{H}_{12}\text{N}_4 \cdot \text{H}_2\text{O}]_2$. Wilke-Dörfurt and Balz⁽⁹⁵²⁾ prepared this salt by allowing a saturated aqueous solution of cobaltous fluoborate to mix with hexamethylenetetramine at -10°C . The details have been discussed previously in connection with the synthesis of the analogous magnesium and manganous compounds. The compound exists as pale-rose-colored needle-like crystals which exhibit strong double refraction with oblique extinction. It is quite soluble in water but insoluble in ethanol. The aqueous solution decomposes upon heating with the separation of a compound of formaldehyde. The crystals are isomorphous with the analogous manganous and nickelous salts and also with the permanganate and perchlorate derivatives.

Diaquotetrapyridinecobalt (II) Fluoborate, $[\text{Co}(\text{py})_4(\text{H}_2\text{O})_2](\text{BF}_4)_2$. Spacu and Dima⁽⁸³¹⁾ prepared this compound by dissolving hexaquocobalt (II) fluoborate in a solution of pyridine in ether. The product formed as a sticky mass which was washed once with ether and then dried in air. The crystals are a rose color and are very soluble in water but insoluble in alcohol and ether.

Tris(benzidine)cobalt (II) Fluoborate, $[\text{Co}(\text{bzd})_3](\text{BF}_4)_2$. This complex compound has been prepared by Spacu and Dima⁽⁸³⁰⁾ by allowing a hot ethanol or acetone solution of benzidine at ordinary temperature to react with a concentrated aqueous solution of a freshly prepared metallic fluoborate. This compound is structurally similar to the cadmium analog (*vide infra*).

Hexamminecobalt (III) Fluoborate, $[\text{Co}(\text{NH}_3)_6](\text{BF}_4)_3$. To a hot aqueous solution of luteocobaltic nitrate, Wilke-Dörfurt and Balz⁽⁹⁵²⁾ added an excess of an aqueous solution of fluoboric acid. Upon slowly cooling, the desired salt was precipitated. The pre-

precipitate was washed with alcohol and then recrystallized from hot water to which some fluoboric acid had been added. The crystals were washed with alcohol and dried over sulfuric acid.

Hexamminecobalt (III) fluoborate crystallizes as small light-orange to yellow-colored isotropic octahedra which are slightly soluble in water (0.016 mole per liter). It is stable in the presence of hot concentrated sulfuric acid.⁽⁹⁵²⁾ Upon heating to a temperature of 300°C. this salt decomposes, the cobaltic oxidation state undergoing autoreduction to the cobaltous state, as shown by the equation:

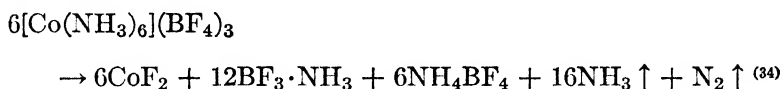

At 25°C. the complex compound has a density of 1.971 which corresponds to a molecular volume of 214.0 cc.⁽³⁴⁾

In 1896 Miolati and Rossi prepared a hexamminecobalt (III) acid fluoborate which had the composition $[\text{Co}(\text{NH}_3)_6](\text{BF}_4)_3 \cdot \text{HF}$ by adding a solution of luteocobaltic carbonate to a solution of boric acid in hydrofluoric acid. Their product was recrystallized from dilute hydrofluoric acid and was found by them to be stable at temperatures between 110 and 120°C.⁽⁶¹⁸⁾

Dichlorobis(ethylenediamine)cobalt (III) Fluoborate, $[\text{Co}(\text{en})_2\text{Cl}_2]\text{BF}_4$. Green dichlorobis(ethylenediamine)cobalt (III) chloride was dissolved in water and added to a solution of ammonium fluoborate by Spacu and Dima.⁽⁸³¹⁾ A green crystalline precipitate formed which was washed in a small amount of water and dried over calcium chloride. The resulting crystals are small green-colored prisms which are stable in air and soluble in water and alcohol. They are insoluble in ether and are decomposed by dilute acids.

Dinitrobis(ethylenediamine)cobalt (III) Fluoborate, $[\text{Co}(\text{en})_2(\text{NO}_2)_2]\text{BF}_4$. By allowing an aqueous solution of ammonium fluoborate to react with an aqueous solution of dinitrobis(ethylenediamine) cobalt (III) nitrite, Spacu and Dima⁽⁸³¹⁾ prepared this complex compound. The solution was concentrated on a water bath and then allowed to cool at which time beautiful "glasslike" crystals, which are light brown in color, precipitate. The crystals were washed with water and then with alcohol and ether and dried over calcium chloride. Dinitrobis(ethylenediamine)cobalt (III)

fluoborate is quite soluble in water but insoluble in alcohol and ether. The crystals deflagrate upon heating.

Hexaquaonickel (II) Fluoborate, $[\text{Ni}(\text{H}_2\text{O})_6](\text{BF}_4)_2$. Funk and Binder⁽²⁷⁷⁾ and Wilke-Dörfurt and Balz^(950, 952) have prepared hexaquaonickel (II) fluoborate by the reaction of nickel carbonate with fluoboric acid. Upon evaporation of the solution, doubly refracting small green, needle-like crystals appear. The crystals are deliquescent and are very soluble in water and alcohol but less soluble in an alcohol-ether mixture.^(277, 952) The crystals are not dehydrated by storage over phosphorus pentoxide. Upon heating, water and boron trifluoride are evolved.⁽²⁷⁷⁾ Inasmuch as the hexamminenickel (II) fluoborate is very easily prepared, Wilke-Dörfurt and Balz⁽⁹⁵²⁾ consider this compound to be hexaquaonickel (II) fluoborate, $[\text{Ni}(\text{H}_2\text{O})_6](\text{BF}_4)_2$.

At 25°C. the density of hexaquaonickel (II) fluoborate has been found to be 2.142 from which the molecular volume has been calculated as 158.9 cc.⁽³⁴⁾

Nickel fluoborate was first employed in a nickel-plating bath by Kern and Fabian⁽⁴⁵²⁾ in 1908 to give a thick plate (5/16 inch) with desirable properties. Hollard⁽³⁸⁹⁾ and later Blum⁽⁸⁰⁾ found that nickel fluoborate gave a hard nickel plate especially suitable for electrotypes. Others^(521, 556, 560, 655, 940, 940a) have found it fairly satisfactory for use in plating baths.

Hexamminenickel (II) Fluoborate, $[\text{Ni}(\text{NH}_3)_6](\text{BF}_4)_2$. Wilke-Dörfurt and Balz⁽⁹⁵²⁾ prepared this compound by treating an aqueous solution of nickel chloride (or other suitable nickel (II) salts) with an excess of ammonium hydroxide solution to form the hexamminenickel (II) chloride solution which then was added to a fluosilicate-free aqueous solution of ammonium fluoborate. Upon standing at room temperature the blue precipitate of hexamminenickel (II) fluoborate formed and was filtered off, washed with dilute ammonium hydroxide solution, and recrystallized from a hot dilute solution of ammonium hydroxide to which some ammonium fluoborate had been added. The purified crystals were washed with dilute and then with concentrated solutions of ammonium hydroxide and dried in a vacuum desiccator over sodium hydroxide in the presence of ammonium chloride.

The crystals are optically isotropic well-formed regular octahedra which are blue colored but which have a violet tinge under artificial light. The crystals are difficultly soluble in water and

dilute ammonium hydroxide (0.0060 mole of this compound per liter of ammonium hydroxide solution of density 0.930 at 11°C.). In ammonium hydroxide solutions containing fluoborate ions, the crystals are insoluble. The use of this reaction serves as a very sensitive test for the presence of fluoborate ions.⁽⁹⁵⁰⁾

In cold water the salt gradually decomposes. In warm water the decomposition is accelerated. In air, ammonia is slowly evolved with the result that the crystals gradually change to a green color. The salt dissolves in dilute acids, forming a solution which gives the reactions of the fluoborate ion. If the solution is treated with an excess of ammonium hydroxide, the hexammine-nickel (II) fluoborate precipitates. The salt imparts a green color to a flame. The crystals are isomorphous with the analogous perchlorate and permanganate salts.^(952a)

The density of the crystals at 25°C. is 1.557 from which the molecular volume has been calculated to be 214.8 cc.⁽³⁴⁾

Balz and Zinser⁽³⁴⁾ have studied the thermal decomposition of hexamminenickel (II) fluoborate. They observed that the decomposition begins at a temperature around 150°C. to yield nickelous fluoride, ammonia, and a sublimate, $\text{BF}_3 \cdot \text{NH}_3$. The reaction is irreversible and is best expressed by the equation:

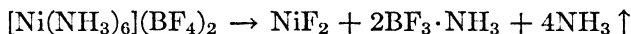

They had hoped to use this decomposition to prepare very pure nickelous fluoride, but their product always contained some ammonia.

Hexaquonickel (II) Bis(hexamethylenetetramine) Difluoborate Dihydrate, $[\text{Ni}(\text{H}_2\text{O})_6][\text{BF}_4 \cdot \text{C}_6\text{H}_{12}\text{N}_4 \cdot \text{H}_2\text{O}]_2$. This complex salt was prepared in the same manner as the analogous magnesium, manganese (II), and cobalt (II) salts (*vide supra*).⁽⁹⁵²⁾ It is obtained as blue-green-colored strongly doubly refracting needle-like crystals which exhibit oblique extinction. The crystals are very soluble in water but insoluble in alcohol.

Tris(ethylenediamine)nickel (II) Fluoborate, $[\text{Ni}(\text{en})_3](\text{BF}_4)_2$. Spacu and Dima⁽⁸³¹⁾ prepared a solution of nickelous fluoborate by the method described previously. This solution was allowed to react with an aqueous solution of ethylenediamine hydrate. As the reaction progressed, the solution changed from a green color to a violet color with the evolution of heat. The solution was then concentrated on a water bath, and, when it was

cool, beautiful rose-violet-colored crystals separated from the solution. The crystals were washed with a little water, alcohol, and ether and dried. The compound is stable in air and soluble in water, but insoluble in ethanol and ether.⁽⁸³¹⁾

Diaquotetrapyridinenickel (II) Fluoborate, $[\text{Ni}(\text{py})_4(\text{H}_2\text{O})_2](\text{BF}_4)_2$. This complex compound is prepared by mixing a freshly prepared solution of nickelous fluoborate with an excess of pyridine, concentrating the solution on a water bath and allowing crystallization to proceed as the solution cools.⁽⁸³¹⁾ The crystals may be washed with alcohol and ether to which a little pyridine has been added and then dried in a desiccator over phosphorus pentoxide. In this manner large blue-colored crystals are obtained which are very soluble in water but insoluble in alcohol and ether.⁽⁸³¹⁾

FLUOBORATES OF METALS IN GROUP Ib

Hexaquocopper (II) Fluoborate, $[\text{Cu}(\text{H}_2\text{O})_6](\text{BF}_4)_2$. Berzelius^(66, 68, 69, 70) reported that he had obtained cupric fluoborate by mixing an aqueous solution of cupric sulfate with an aqueous solution of barium fluoborate. Upon evaporation of the filtrate, he obtained light-blue acicular crystals.

More recently Funk and Binder⁽²⁷⁸⁾ and Wilke-Dörfurt and Balz⁽⁹⁵²⁾ have prepared this compound by a reaction between fluoboric acid and cupric carbonate or oxide. The crystals are deliquescent and very soluble in water and alcohol. Upon heating at temperatures as low as 40°C. the compound readily dissociates, evolving boron trifluoride and water.⁽²⁷⁸⁾ By drying over phosphorus pentoxide for a long time the water of hydration is lost step-wise.⁽²⁷⁸⁾

At 25°C. the density of this compound is 2.253 with a corresponding molecular volume of 153.3 cc.⁽³⁴⁾

Wilke-Dörfurt and Balz⁽⁹⁵²⁾ consider this compound to be hexaquocopper (II) fluoborate, $[\text{Cu}(\text{H}_2\text{O})_6](\text{BF}_4)_2$.

Leuchs⁽⁵⁰³⁾ and Narcus⁽⁶⁵⁵⁾ report the use of cupric fluoborate solutions as electrolytes for the electroplating of copper.

Struyk and Carlson⁽⁸⁷⁸⁾ found that copper fluoborate plating baths have exceptionally valuable plating characteristics: (1) Current densities higher than those used in any other copper plating bath can be used; (2) the deposits are smooth and of excellent appearance, and are soft and easily buffed to a high luster; (3) un-

der certain conditions deposits are hard and of great strength; (4) anode and cathode efficiencies are approximately 100%; (5) the anode current density is not critical; (6) the high solubility of copper fluoborate prevents crystallization on tanks and equipment. The bath is easily controlled.

Pentamminecopper (II) Fluoborate Hemihydrate, $[\text{Cu}(\text{NH}_3)_5](\text{BF}_4)_2 \cdot \frac{1}{2}\text{H}_2\text{O}$. This salt was prepared by Lange ⁽⁴⁸⁹⁾ by allowing cupric hydroxide and ammonium fluoborate to react in a warm 25% solution of ammonium hydroxide. The ice-cooled filtrate yielded crystals which were washed with cold alcohol and ether and rapidly dried at 5°C. in a stream of dry air.

The crystals are light-blue-colored plates which effloresce in air. Wilke-Dörfurt and Balz ⁽⁹⁵²⁾ claimed to obtain an ammine cupric fluoborate whose composition was between the hexa- and the tetrammine by allowing cupric fluoborate and ammonium fluoborate to react in an ammonium hydroxide solution.

Tetramminecopper (II) Fluoborate, $[\text{Cu}(\text{NH}_3)_4](\text{BF}_4)_2$. Lange ⁽⁴⁸⁹⁾ prepared this salt by storing pentamminecopper (II) fluoborate hemihydrate in a vacuum desiccator over sulfuric acid. The product is a violet-tinged blue-colored powder which is soluble in acetone. This compound melts at 188°C. (uncorr.) without decomposition.

Diaquotetramminecopper (II) Fluoborate, $[\text{Cu}(\text{NH}_3)_4(\text{H}_2\text{O})_2](\text{BF}_4)_2$. When Lange ⁽⁴⁸⁹⁾ recrystallized tetramminecopper (II) fluoborate from water at 30°C. he obtained dark-blue indistinct crystals which upon analysis corresponded to diaquotetramminecopper (II) fluoborate. Lange ⁽⁴⁸⁹⁾ found that treatment of the tetrammines with ammonia produced hexamminecopper (II) fluoborate. This latter compound loses ammonia at 12°C. and at 170°C. is transformed to the pentammine which at 195°C. is itself decomposed.

Amminebis(ethylenediamine)copper (II) Fluoborate, $[\text{Cu}(\text{en})_2\text{NH}_3](\text{BF}_4)_2$. This complex compound was prepared by allowing a solution of cupric hydroxide and ammonium fluoborate in 10% ethylenediamine to mix with alcohol in an ice bath. The crystals thus formed were washed with alcohol and ether and quickly dried. This complex compound forms light-blue-colored needle-like crystals which are partially combined in starlike formations. ⁽⁴⁸⁹⁾ The crystals are soluble in acetone. Ammonia is evolved in air, but in an atmosphere of ammonia it is stable up to 164°C. ⁽⁴⁸⁹⁾

Bis(ethylenediamine)copper (II) Fluoborate, $[\text{Cu}(\text{en})_2](\text{BF}_4)_2$. When amminebis(ethylenediamine)copper (II) fluoborate loses ammonia in air or when stored over sulfuric acid, bis(ethylenediamine)copper (II) fluoborate is obtained. When the crystals are precipitated from a concentrated aqueous solution by the addition of alcohol, oblique four-sided green-colored plates are obtained which sometimes are arranged as starlike prisms.⁽⁴⁸⁹⁾ The crystals are soluble in acetone and melt without decomposition at 243°C. (uncorr.). At room temperature this compound will add ammonia to form amminebis(ethylenediamine)copper (II) fluoborate (*vide supra*).⁽⁴⁸⁹⁾

Tetrapyridinecopper (II) Fluoborate, $[\text{Cu}(\text{py})_4](\text{BF}_4)_2$. Wilke-Dörfurt and Balz⁽⁹⁵²⁾ prepared this compound by mixing an aqueous solution of cupric chloride with pyridine and warming while hot ammonium fluoborate was added. Upon cooling, the compound crystallized out of solution and was purified by recrystallization from hot dilute pyridine containing ammonium fluoborate. The crystals were washed with pyridine and dried in a vacuum desiccator over sodium hydroxide.

Tetrapyridinecopper (II) fluoborate occurs as deep-blue-violet-colored platelike crystals of rhombic outline, which are doubly refracting. It is very slightly soluble in water and in dilute pyridine solutions and is practically insoluble in fluoborate-containing pyridine. It is not appreciably soluble in warm anhydrous pyridine. The crystals are isomorphous with the analogous perchlorate and permanganate compounds. The density at 25°C. is 1.552 from which the molecular volume is calculated to be 358.8 cc.⁽³⁴⁾

Lange⁽⁴⁸⁹⁾ has prepared this compound and also *diaquotetrapyridinecopper (II) fluoborate*, $[\text{Cu}(\text{py})_4(\text{H}_2\text{O})_2](\text{BF}_4)_2$, and *hexapyridinecopper (II) fluoborate dihydrate*, $[\text{Cu}(\text{py})_6](\text{BF}_4)_2 \cdot 2\text{H}_2\text{O}$, by methods similar to those discussed previously for the preparation of the amminecopper (II) fluoborates.

It is not possible to account for this latter compound by the usual coordination of the pyridine and H_2O molecules around the metal of the cation without exceeding the maximum permissible covalence of six for copper.

Monoaquosilver (I) Fluoborate, $[\text{Ag}(\text{H}_2\text{O})]\text{BF}_4$. Using the technic previously described for the other metallic fluoborates, Wilke-Dörfurt and Balz^(950, 952) prepared monoquosilver (I) fluo-

borate by allowing freshly prepared silver carbonate to react with fluoboric acid. The crystals could not be obtained by drying over concentrated sulfuric acid and were only obtainable by cooling the solution over phosphorus pentoxide.

The product is obtained as colorless platelike crystals which are very hygroscopic. It is very soluble in water and less soluble in alcohol or an alcohol-ether mixture. Like many silver salts, silver fluoborate is sensitive to light.

Leuchs⁽⁵⁰³⁾ and Narcus⁽⁶⁵⁵⁾ have reported the use of silver fluoborate solutions as plating baths for the electroplating of silver.

Funk and Binder⁽²⁷⁸⁾ claim to have isolated colorless crystals whose composition from analysis corresponds to $\text{Ag}(\text{BF}_4) \cdot \text{AgF} \cdot \text{HF} \cdot 5\text{H}_2\text{O}$ by adding silver carbonate to a fluoboric acid solution until the solution remains barely acidic. The solution was evaporated in a vacuum to a sirupy consistency which upon cooling in ice produced the crystalline product. The crystals were quickly pressed on a clay plate and then dried over phosphorus pentoxide.

The crystals were found to be unusually deliquescent and very soluble in water producing an acidic solution. Upon drying by warming, the salt begins to decompose. It also decomposes if kept for a prolonged period of time in a desiccator over phosphorus pentoxide.

Diamminesilver (I) Fluoborate, $[\text{Ag}(\text{NH}_3)_2]\text{BF}_4$. This complex salt has been prepared by mixing solutions of silver nitrate, ammonium fluoborate, and concentrated ammonium hydroxide. The reaction product was recrystallized, washed with cooled ammonium hydroxide solution, and dried in the absence of light in a desiccator over sodium hydroxide. The salt may also be prepared by mixing silver fluoborate and ammonium fluoborate in the presence of concentrated ammonium hydroxide solution.⁽⁹⁵²⁾ The crystals thus obtained are colorless, doubly refracting, with parallel extinction. The compound is seemingly difficultly soluble in concentrated ammonium hydroxide solution. The crystals are somewhat sensitive to light.⁽⁹⁵²⁾

Balz and Zinser⁽³⁴⁾ observed that this salt begins to decompose when heated to a temperature between 140° and 150°C . During this decomposition, the silver is reduced to metallic silver at the expense of part of the ammonia which is oxidized to gaseous nitrogen as shown by the equation:

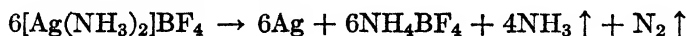

The density of diamminesilver (I) fluoborate at 25°C. has been found to be 2.443 from which the molecular volume has been calculated to be 93.6 cc.⁽³⁴⁾

Dipyridinesilver (I) Fluoborate, $[\text{Ag}(\text{py})_2]\text{BF}_4$. Wilke-Dörfurt and Balz⁽⁹⁵²⁾ prepared this compound by mixing a solution of silver nitrate with some pyridine and warming the solution slightly. Then an aqueous solution of ammonium fluoborate was added and, upon cooling, with constant stirring, a crystalline mass was obtained. This mass was recrystallized from hot pyridine and dried in a vacuum over sodium hydroxide.

The product is obtained in long colorless needle-like crystals which are strongly doubly refracting and show plain extinction. The compound melts easily to a colorless isotropic liquid if heated under pyridine. The crystals are slightly soluble in a dilute aqueous solution of pyridine and are easily soluble in pyridine.⁽⁹⁵²⁾

Tetrapyridinesilver (I) Fluoborate, $[\text{Ag}(\text{py})_4]\text{BF}_4$. This compound is prepared in the same manner as dipyridinesilver (I) fluoborate (*vide supra*) except that a correspondingly larger amount of pyridine is used. The properties and solubility relationships are very similar.⁽⁹⁵²⁾

FLUOBORATES OF THE METALS IN GROUP IIB

Hexaquo zinc Fluoborate, $[\text{Zn}(\text{H}_2\text{O})_6](\text{BF}_4)_2$. Zinc fluoborate was first described by Gay-Lussac and Thénard^(290, 292, 293) in 1809, as the reaction product obtained by dissolving zinc in fluoboric acid. Berzelius^(66, 68, 69, 70) later prepared the salt in a similar manner and observed that the solution upon evaporation produced a sirupy liquid which solidified to a white deliquescent mass. More recently, Funk and Binder⁽²⁷⁷⁾ have prepared the hexahydrate by dissolving metallic zinc, zinc carbonate, or zinc oxide in a 30% solution of fluoboric acid. The solution was concentrated by evaporation and allowed to cool, thus producing the crystalline product. Meyerhofer⁽⁶⁰⁵⁾ has prepared zinc fluoborate by allowing zinc oxide to react with boron trifluoride and aqueous fluoboric acid or with boric oxide, calcium fluoride, and an acid.

The hexahydrate is extremely hygroscopic, easily soluble in water, and soluble in ethanol. By heating to 60°C. the salt is dehydrated.⁽²⁷⁷⁾ At 25°C. its density is 2.120 from which the molecular volume is calculated to be 163.7 cc.⁽³⁴⁾

Commercially zinc fluoborate is used in the baths for high-speed zinc electroplating. Ammonium fluoborate and fluoboric acid are

used generally along with the zinc fluoborate in the plating baths. (172, 503, 655)

Hexamminezinc Fluoborate, $[\text{Zn}(\text{NH}_3)_6](\text{BF}_4)_2$. Balz and Zinser (34) prepared hexamminezinc fluoborate by condensing liquid ammonia upon tetramminezinc fluoborate (*vide infra*) in a solid carbon dioxide bath and allowing the mixture to warm to the temperature of melting ice. The excess ammonia was removed, and the increase in weight of the reaction mixture corresponded to the addition of 2 moles of ammonia. For the reaction,



the heat of formation of hexamminezinc fluoborate is calculated by the Nernst approximation equation to be 10.9 kcal. per mole at 0°C. (34)

Tetramminezinc Fluoborate, $[\text{Zn}(\text{NH}_3)_4](\text{BF}_4)_2$. Wilke-Dörfurt and Balz (952) allowed zinc fluoborate and ammonium fluoborate to react in an excess of warm ammonium hydroxide solution. The crystalline precipitate, obtained upon cooling, was washed with cold concentrated ammonium hydroxide solution and dried in a vacuum desiccator over sodium hydroxide. The crystals are long oblique sectioned prisms which are strongly doubly refracting and exhibit parallel extinction. It is very difficultly soluble in ammonium hydroxide solution containing fluoborates but is more soluble than the cadmium analog (*vide infra*). (952)

The density of tetramminezinc fluoborate at 25°C. had been found to be 1.825, corresponding to a molecular volume of 168.3 cc. (34) Balz and Zinser (34) studied the thermal decomposition of this compound and found that decomposition began around 200°C. and became more intense around 250°C. The decomposition is irreversible and is represented by the equation:

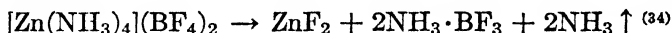

Tris(ethylenediamine)zinc Fluoborate, $[\text{Zn}(\text{en})_3](\text{BF}_4)_2$. Hexaquo zinc fluoborate which had been dried over phosphorus pentoxide was dissolved in alcohol and mixed with an alcoholic solution of ethylenediamine. A white microcrystalline precipitate of tris(ethylenediamine)zinc fluoborate formed. This compound is very soluble in water but is insoluble in alcohol and ether. (881)

Diaquodipyridinezinc Fluoborate, $[\text{Zn}(\text{py})_2(\text{H}_2\text{O})_2](\text{BF}_4)_2$. When hexaquo zinc fluoborate was added to an ether solution of pyridine, a white crystalline precipitate was obtained. The crystals are soluble in water but insoluble in alcohol and ether.⁽⁸³¹⁾

Hexaquocadmium Fluoborate, $[\text{Cd}(\text{H}_2\text{O})_6](\text{BF}_4)_2$. Funk and Binder⁽²⁷⁷⁾ and Wilke-Dörfurt and Balz^(950, 952) have prepared hexaquocadmium fluoborate by dissolving cadmium carbonate in fluoboric acid. The solution was concentrated by evaporation, and, upon cooling, needle-like crystals of hexaquocadmium fluoborate were obtained. The crystals are very deliquescent but less so than the corresponding zinc salt. The salt is very soluble in water and alcohol. It does not lose its water of crystallization when dried over phosphorus pentoxide or when heated to 60°C., but upon heating to 70°C. it begins to lose boron trifluoride.⁽²⁷⁷⁾ Wilke-Dörfurt and Balz⁽⁹⁵²⁾ consider this salt to be the hexaquocadmium fluoborate, $[\text{Cd}(\text{H}_2\text{O})_6](\text{BF}_4)_2$.

Narcus⁽⁶⁵⁵⁾ has reported the use of a cadmium fluoborate bath in the electroplating of cadmium.

Hexamminecadmium Fluoborate, $[\text{Cd}(\text{NH}_3)_6](\text{BF}_4)_2$. By cooling a hot strongly ammoniacal solution of ammonium fluoborate and cadmium fluoborate, Wilke-Dörfurt and Balz⁽⁹⁵²⁾ obtained beautiful colorless isotropic octahedral crystals of hexamminecadmium fluoborate. The crystals were purified by washing with dilute and then with concentrated ammonium hydroxide solutions. They were dried first in air and then in a vacuum desiccator over sodium hydroxide.

The crystals are seemingly difficultly soluble in ammonium hydroxide solutions.⁽⁹⁵⁰⁾ At 11°C. in ammonium hydroxide solution of a density of 0.930, hexamminecadmium fluoborate has been found to be soluble to the extent of 0.0085 mole per liter.⁽⁹⁵²⁾ In pure water the crystals decompose, leaving a basic salt. The crystals may be recrystallized from a hot solution of ammonium hydroxide containing ammonium fluoborate.

The crystals at 25°C. have a density of 1.752 and a molecular volume of 221.6 cc.⁽³⁴⁾

Hexamminecadmium fluoborate is reversibly decomposed by heat to tetramminecadmium fluoborate as shown by the equation:

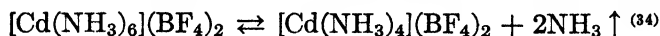

Using the Nernst approximation equation, the heat of formation

of the hexammine salt from the tetrammine salt was calculated to be 16.7 kcal. per mole at 100°C.⁽³⁴⁾

At temperatures around 270° to 300°C. the tetrammine salt of cadmium fluoborate irreversibly decomposes according to the equation:

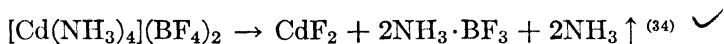

Tris(ethylenediamine)cadmium Fluoborate, $[\text{Cd}(\text{en})_3](\text{BF}_4)_2$. Spacu and Dima⁽¹⁸³⁾ added an aqueous solution of ethylenediamine to a freshly prepared aqueous solution of cadmium fluoborate. The resulting solution was evaporated on a water bath until a crust of crystals appeared. Upon addition of alcohol the desired product precipitated, and the crystals were washed with alcohol and ether. The crystals are colorless, very soluble in water, slightly soluble in alcohol, and insoluble in ether.

Tetrapyridinecadmium Fluoborate, $[\text{Cd}(\text{py})_4](\text{BF}_4)_2$. By mixing a freshly prepared aqueous solution of cadmium fluoborate with an excess of pyridine on a water bath and allowing the solution to cool, Spacu and Dima⁽⁸³¹⁾ were able to obtain crystals of tetrapyridinecadmium fluoborate. The colorless crystals were washed with alcohol and ether containing a little pyridine and dried over phosphorus pentoxide. This complex compound is very soluble in water, slightly soluble in alcohol, and insoluble in ether.

Tris(benzidine)cadmium Fluoborate, $[\text{Cd}(\text{bzd})_3](\text{BF}_4)_2$. This compound was obtained by adding an alcoholic solution of hexaquocadmium fluoborate to an alcoholic solution of benzidine. A microcrystalline white precipitate formed which was washed with alcohol and ether. This compound is insoluble in water, alcohol, and ether.⁽⁸³¹⁾

Monoaquomonohydrofluoromercury (I) Fluoborate, $[\text{Hg}(\text{HF})(\text{H}_2\text{O})]\text{BF}_4$. Funk and Binder⁽²⁷⁷⁾ added mercurous oxide to fluoboric acid on a water bath. From the concentrated solution they obtained magnificent long needle-like crystals of $[\text{Hg}(\text{HF})(\text{H}_2\text{O})]\text{BF}_4$. The crystals are seemingly hygroscopic and are very soluble in water and an 80% solution of alcohol. Upon standing a long time in a desiccator, the crystals evolve acid fumes and become turbid and opaque.⁽²⁷⁷⁾

Sheintsis⁽⁷⁹⁴⁾ obtained an amorphous white precipitate on the addition of a mercurous ion to a 2 N solution of fluoboric acid.

Mercuric Fluoborate, $\text{Hg}(\text{BF}_4)_2(?)$. Freshly prepared mercuric oxide was dissolved in fluoboric acid.^(277, 831, 950, 952) A reddish-yellow precipitate continuously formed during the concentration procedure on the water bath. Upon cooling the highly concentrated solution, colorless needle-like crystals were obtained. The crystals are very deliquescent and quite soluble in water. Their water solution gives the reactions of mercuric and fluoborate ions. On addition of alcohol to an aqueous solution of these crystals, a yellow- to red-colored precipitate is obtained which contains mercury. On concentration of the alcoholic solution, $[\text{Hg}(\text{HF})(\text{H}_2\text{O})]\text{BF}_4$ is obtained (*vide supra*).

Bis(ethylenediamine)mercury (II) Fluoborate, $[\text{Hg}(\text{en})_2](\text{BF}_4)_2$. Spacu and Dima⁽⁸³¹⁾ dissolved mercuric oxide in fluoboric acid and mixed this solution with a solution of ethylenediamine hydrate. The mixture was heated on a water bath, and, upon cooling, alcohol was added to cause precipitation of the desired product. The beautiful white crystals were washed with alcohol and ether. The crystals darken on standing in air. The salt is quite soluble in water but is insoluble in alcohol and ether.

Dipyridinemercury (II) Fluoborate, $[\text{Hg}(\text{py})_2](\text{BF}_4)_2$. Mercuric oxide was dissolved in fluoboric acid, and pyridine was added to this solution. The solution was concentrated on a water bath until crystals began to form. The crystallization was continued in a desiccator over phosphorus pentoxide and pyridine. An abundant yield of colorless crystals of dipyridine mercuric fluoborate was obtained. The crystals are very soluble in water but insoluble in alcohol and ether.⁽⁸³¹⁾

FLUOBORATES OF THE METALS IN GROUP IIIB

Indium Fluoborate, $\text{In}(\text{BF}_4)_3(?)$. To our knowledge this compound has not been isolated nor identified. Murray⁽⁶⁶⁴⁾ and Narcus⁽⁶⁵⁵⁾ report that indium has been electroplated from fluoborate baths. In the description of these baths they refer to indium as the fluoborate. A typical bath consists of 236 g. of indium fluoborate, 22.3 g. of orthoboric acid and between 40 and 50 g. of ammonium fluoborate per liter of an aqueous solution. Sufficient fluoboric acid (42%) is added to make the pH of the solution about 1.

Thalious Fluoborate, TlBF_4 . Thalious fluoborate is similar in its chemical properties to the fluoborates of the alkali metals,

and, like them, forms a fluoborate without any water of crystallization.

Wilke-Dörfurt and Balz^(950, 952) prepared this compound by allowing thallos carbonate to react with a solution of fluoboric acid. Funk and Binder⁽²⁷⁸⁾ claim to have prepared thallos fluoborate monohydrate, $TlBF_4 \cdot H_2O$, by allowing metallic thallium to react with an aqueous solution of fluoboric acid. The metal is soluble in the cold acid, but the reaction proceeds more rapidly if the solution is warmed.

Thallos fluoborate forms small platelike doubly refracting colorless crystals which are somewhat hygroscopic. When exposed to light for some time they begin to turn brown.⁽⁹⁵²⁾

According to the results of X-ray analysis the axial ratios for the crystals are $a:b:c = 1.624:1:1.274$, as calculated from the axis lengths which were found to be:

$$a = 9.47 \pm 0.03 \text{ \AA.}$$

$$b = 5.81 \pm 0.04 \text{ \AA.}$$

$$c = 7.40 \pm 0.02 \text{ \AA.}^{(459)}$$

Even though these crystallographic data are similar to those obtained for thallos perchlorate,⁽⁴⁵⁸⁾ Klinkenberg and Ketelaar⁽⁴⁶⁰⁾ believe the two compounds are not isomorphous. Thallos fluoborate is probably dimorphous, having a rhombic modification which is isomorphous with the perchlorate, and a tetragonal (pseudocubic) which is not isomorphous with the high-temperature modification of the perchlorate. The temperature of the transition from the rhombic (β -form) to the isotropic (α -form) is between 203° and 206°C. ⁽⁹³⁰⁾

FLUOBORATES OF METALS IN GROUP IVb

Fluoborate of Stannous Tin. By allowing stannous hydroxide to react with an aqueous solution of fluoboric acid, Funk and Binder⁽²⁷⁸⁾ obtained a product which they thought was $\text{Sn}(\text{BF}_4)_2 \cdot \text{SnF}_2 \cdot 5\text{H}_2\text{O}$ (perhaps $[\text{Sn}(\text{SnF}_2)(\text{H}_2\text{O})_5](\text{BF}_4)_2$). This compound was obtained as a white crystalline mass. It was not possible to obtain an analysis of the crystals since they are unusually deliquescent. Because of the similarity of tin and lead, it was thought that the composition of the tin salt would be similar to that of the lead (*vide infra*). Electrolytic baths of stannous fluo-

borate have been made by displacing copper from copper fluoborate solution with tin.^(451a)

Tin plate is being produced electrolytically from a fluoborate bath but requires an addition agent such as clove oil or 0.1% digitalin, for best results.^(451a, 578d) A tin-lead alloy plate may be produced also from a fluoborate bath. The alloy plate is hard, relatively bright, extremely fine-grained, and smoother than the plate obtained with lead or tin separately.^(80a, 317a, 321a, 655)

Hexaquolead (II) Fluoborate, $[\text{Pb}(\text{H}_2\text{O})_6](\text{BF}_4)_2$. Berzelius^(66, 68, 69, 70) prepared plumbous fluoborate by allowing plumbous carbonate to dissolve in an aqueous solution of fluoboric acid until a precipitate appeared. The filtrate, upon evaporation to a sirupy consistency, was cooled with the deposition of long needles. Slow evaporation produced "short four-sided apparently rectangular prisms."

Fischer and Thiele,⁽²⁶⁴⁾ using the same reactants and cooling to 0°C., obtained acicular crystals which could not be separated from the mother liquor. Funk and Binder⁽²⁷⁸⁾ claimed to have obtained crystals having the composition $\text{Pb}(\text{BF}_4)_2 \cdot \text{PbF}_2 \cdot 5\text{H}_2\text{O}$ (perhaps $[\text{Pb}(\text{PbF}_2)(\text{H}_2\text{O})_5](\text{BF}_4)_2$), by a similar process. They could not purify their product by recrystallization out of a water or an alcohol solution as these solvents caused their product to decompose.

However, Wilke-Dörfurt and Balz⁽⁹⁵²⁾ claim to have prepared a crystalline compound whose analysis corresponds to the hexaquolead (II) fluoborate.

Berzelius^(66, 68, 69, 70) tasted the salt and observed that it was sweet at first but later acidic.

The crystals are extremely deliquescent. The salt dissolves in water, producing a solution which is neutral to Congo red but acidic to litmus.⁽²⁶⁴⁾ Berzelius^(66, 68, 69, 70) reported that the salt hydrolyzed in water, producing a soluble acid salt and an insoluble basic salt (compare alkaline-earth fluoborates). When a solution of the salt was heated in water or in alcohol, a similar reaction occurred.⁽²⁶⁴⁾

An easily fusible basic compound has been reported to be formed by heating plumbous fluoborate with plumbous oxide.

Plumbous fluoborate solutions in water upon electrolysis deposit lead quantitatively, and its use in coulometers has been recommended.^(264, 265, 503) Betts⁽⁷²⁾ has patented a process for the

production of pure and uniformly dense lead by electrodeposition from the fluoborate. Reducing agents such as gelatin, pyrogallol, resorcin, saligenin, *o*-aminophenol, formic acid, hydroquinone, and sulfur dioxide are used in the process to keep the lead from becoming crystalline. The use of lead fluoborate plating baths makes possible high current densities without trecing.^(80a, 317a, 578c)

In the electroplating of steel, aluminum, zinc, or white metals with lead, it has been found that a fluoborate plating bath is very satisfactory. A copper strike is necessary except on steel.^(65b)

It has been suggested also that lead be refined by electrodeposition from a fluoborate bath.^(73, 503, 576) Lead dioxide may be produced also electrolytically, plumbous fluoborate being used in the electrolyte.⁽⁵⁰³⁾

MISCELLANEOUS RESEARCH ON FLUOBORATES

Sheintsis⁽⁷⁹⁴⁾ was unsuccessful in his attempt to prepare insoluble fluoborates of the following metals by allowing their ions to mix with a 2 *N* solution of fluoboric acid: Li, Be, Mg, Ca, Al, Ce, Ti, Zr, Th, VO_3^{-1} , Cr, MoO_4^{-2} , WO_4^{-2} , U, Mn, Fe, Co, Ni, Pd, Pt, Cu, Ag, Au, Zn, Cd, Hg^{+2} , Sn, Pb, AsO_3^{-3} , AsO_4^{-3} , Sb, and Bi. Evidently this is due to the fact that the solution of fluoboric acid is too dilute to furnish enough fluoborate ions to exceed the solubility product of the fluoborates. It may be observed that many of the ions in the list have been reported to form fluoborates by reactions with a 30 to 40% (concentrated) solution of fluoboric acid (*vide supra*).

Wilke-Dörfurt and Balz⁽⁹⁵²⁾ were unable to prepare fluoborates of Zr, Th, UO_2 , Cr^{+3} , Fe^{+3} , Sn, Pb^{+4} , Sb, and Bi by reactions involving compounds of these ions with fluoboric acid (35%).

Nitrosyl Fluoborate, NOBF_4 . Wilke-Dörfurt and Balz^(950, 952) prepared nitrosyl fluoborate by passing the oxides of nitrogen, N_2O_3 , produced by action of nitric acid on sodium nitrite, over phosphorus pentoxide and calcium nitrate and then into a concentrated solution of fluoboric acid. The precipitate thus obtained was thoroughly dried by suction and then further dried in a vacuum desiccator over phosphorus pentoxide and calcium oxide in an atmosphere of the oxides of nitrogen. It may be purified by sublimation in a high vacuum.^(458a) Nitrosyl fluoborate has been prepared⁽⁹³¹⁾ in 90–92% yield from fluoboric acid with NO_2 instead of N_2O_3 .

Nitrosyl fluoborate occurs as colorless doubly refracting hygroscopic flakes which do not etch glass when dry. It is isomorphous with NH_4BF_4 .^(458a) Specific gravity $D_4^{25^\circ}$ equals 2.185.⁽³²⁾ It reacts with water with the evolution of oxides of nitrogen. The characteristic reactions of the fluoborate ion are obtained in the aqueous solution remaining. With methanol, nitrosyl fluoborate reacts to produce methyl nitrite. Nitrosyl fluoborate is soluble in concentrated sulfuric acid.

Prior to the strenuous drying of the salt in the vacuum desiccator Wilke-Dörfurt and Balz suggested that the monohydrate of nitrosyl fluoborate was obtained analogous to the monohydrate of nitrosyl perchlorate. However, Hantzsch and Berger⁽³³³⁾ later pointed out that the hydrate of the perchlorate does not exist, nor does a hydrate of nitrosyl sulfate, and, therefore, it is improbable that the hydrate of the fluoborate exists.

Nitrosyl fluoborate is a valuable reagent in the preparation of diazonium fluoborates.⁽⁹³¹⁾ Phenyl diazonium fluoborate was prepared in 90% yield by an improved Schiemann method from 1 g. of aniline hydrochloride in 9.5 ml. of dilute alcohol with 1.4 g. nitrosyl fluoborate at 3–5°C.

In 1930 a thesis was written in Stuttgart on nitrosyl fluoborate by Welte.⁽⁹⁴³⁾

Hydrazinium Fluoborate, $(\text{N}_2\text{H}_5)\text{BF}_4$. Funk and Binder⁽²⁷⁸⁾ prepared this compound by mixing a solution of hydrazine hydrate with slightly more than the necessary quantity of fluoboric acid solution. The solution was concentrated on a water bath to the point of crystallization. Upon cooling beautiful needle-like crystals were obtained which were not hygroscopic but which were easily soluble in water.

FLUOBORATES IN ORGANIC CHEMISTRY

The organic fluoborates so far reported consist of six classes, of which the first five contain the organic component in the cation and the sixth contains it in both the cation and the fluoborate anion. In the latter case three of the F atoms of the BF_4^- are replaced by the C_6H_5 group. The six classes are:

1. Alkyl- and arylammonium fluoborates.
2. Diazonium fluoborates.
3. Carboxonium fluoborates.

4. Triphenylmethane fluoborates.
5. Tertiary oxonium fluoborates.
6. Tetralkylammonium triphenylfluoborates.

AMMONIA DERIVATIVES

Wilke-Dörfurt and Balz⁽⁹⁵¹⁾ have prepared tetramethylammonium fluoborate, $[(\text{CH}_3)_4\text{N}]\text{BF}_4$, and tetraethylammonium fluoborate, $[(\text{C}_2\text{H}_5)_4\text{N}]\text{BF}_4$, by the reaction of tetralkylammonium chloride with a 40% aqueous solution of fluoboric acid. The products are colorless doubly refracting tetragonal crystals which exhibit parallel extinction. The methyl derivative is difficultly water-soluble whereas the ethyl derivative is less so.

Thompson and Kraus^(950a) reported, for solutions in $(\text{CH}_2\text{Cl})_2$ at 25°, limiting conductances and ionization constants ($K \times 10^4$), are 81.0 and 1.05, respectively, for $[(\text{C}_2\text{H}_5)_4\text{N}]\text{BF}_4$.

Tetra-*n*-butylammonium Fluoborate $[(\text{C}_4\text{H}_9)_4\text{N}]\text{BF}_4$. This compound m. pt. 161.8°, was obtained by the interaction of ammonium fluoborate with tetra-*n*-butylammonium hydroxide solution.^(954a) The salt was recrystallized from water, from water-alcohol mixtures, and from ethyl acetate by cooling with Dry Ice. Determination of its conductance in nitrobenzene at 25°C. gave Λ_0 , 33.96, Λ_0^+ (11.9), Λ_0^- 22.1, $K \times 10^4 = 510$.

Neurine fluoborate, $[\text{C}_2\text{H}_3\text{N}(\text{CH}_3)_3]\text{BF}_4$, was prepared by allowing neurine and an alcoholic solution of fluoboric acid to react. The product crystallizes as thin white doubly refracting prisms which are soluble in water to about the same extent as the analogous perchlorate.⁽⁹⁵¹⁾

The coordination compound formed by pyridine and boron trifluoride, $\text{C}_5\text{H}_5\text{N} \cdot \text{BF}_3$, was found by van der Meulen and Heller⁽⁵⁹⁹⁾ to hydrolyze in a hot 95% solution of ethanol to form the pyridine salt of fluoboric acid.

Pfeiffer, Schwenzer, and Kumetat⁽⁷¹¹⁾ observed that *p*-dimethylaminostyryl methyl ketone reacts with 33% fluoboric acid solution to produce a blue salt, $\text{C}_{12}\text{H}_{15}\text{ON} \cdot \text{HBF}_4$ which has a melting point with decomposition at 152°C. The salt is soluble in warm acetic acid and ethanol to give a red-violet color and may be recrystallized from this solution. It is very stable toward water, "0.05 gram of the salt requiring 12 drops of water for hydrolysis." The dry salt is stable in air for several hours. If the blue salt is dissolved in an 85% solution of formic acid and a few drops of the

fluoboric acid solution are added along with some ether, a grayish-white isomer is formed which melts with decomposition at 150°C. and which is rapidly hydrolyzed. When pure, this isomer forms white crystals which acquire a blue tone within a few hours.

Similarly, phenyl-*p*-dimethylaminostyryl ketone reacts in a 96% ethanol solution to produce a colorless salt, $C_{17}H_{17}ON \cdot HBF_4$, which melts at 172°C. with decomposition. This salt may be recrystallized from an acetic acid solution; the resulting crystals are very sensitive to hydrolysis. A rose-violet-colored isomer results if the colorless salt is dissolved in monochloroacetic acid. The isomer is also rapidly hydrolyzed.⁽⁷¹¹⁾

A colorless salt having the composition $C_{17}H_{16}ONCl \cdot HBF_4$ is likewise obtained from an alcoholic solution of *p*-chlorophenyl-*p*-dimethylaminostyryl ketone. At a temperature between 177° and 178°C. the salt melts with decomposition. The salt is sensitive to hydrolysis also. By dissolving the salt in acetic acid a bluish-violet-colored isomer is obtained which melts at 179 to 180°C. with decomposition. It, too, readily hydrolyzes.⁽⁷¹¹⁾

Lange⁽⁴⁸⁹⁾ used nitron fluoborate, $C_{20}H_{16}N_4HBF_4$, to determine the presence of fluoborate in complex compounds. The compound is prepared by allowing a strong solution of nitron acetate to react with a concentrated solution of fluoboric acid. Independently, Wilke-Dörfurt and Balz⁽⁹⁵²⁾ prepared the compound in the same manner. The crystals are fine long light-green-colored needles which are oblique sectioned and doubly refracting and exhibit parallel extinction. After some time the crystals turn yellow in color. The uncorrected melting point of the crystals has been observed to be 224.5⁽⁴⁸⁹⁾ and 227°C.⁽⁹⁵²⁾ The crystals are soluble in water to the extent of 0.0374 g. per 100 cc. of water at 15°C. which would correspond to 1 part of nitron fluoborate to 2700 parts of water.⁽⁹⁵²⁾ Lange⁽⁴⁸⁹⁾ reported the solubility at 16°C. to be 1 part in 3000 of water.

Wilke-Dörfurt and Balz^(950, 951) have prepared some fluoborates of vegetable alkaloids. A representative of the atropine group, cocaine, was found to form a fluoborate when its hydrochloride was mixed with a solution of ammonium acetate and ammonium fluoborate. Cocaine fluoborate, $C_{17}H_{21}NO_4 \cdot HBF_4$, forms in the synthesis as a viscous liquid which produces crystals only after being vigorously stirred. The crystals will not form if any min-

eral acids are present. Cocaine fluoborate forms as fine silklike needles which are doubly refracting and show parallel extinction. It is difficultly soluble in water.⁽⁹⁵¹⁾

Strychnine and brucine, members of the cinchonine group of alkaloids, have been found to form fluoborates. By mixing strychnine acetate, ammonium acetate, and fluoboric acid solutions, long fine silklike crystals of strychnine fluoborate, $C_{21}H_{22}N_2O_2 \cdot HBF_4$, were obtained. The crystals are doubly refracting and difficultly soluble in water. The crystals will not form if any mineral acids are present. On being heated to a temperature of $280^\circ C.$, the crystals of strychnine fluoborate did not melt.^(950, 951)

Under similar conditions as those described for the synthesis of strychnine fluoborate, brucine will react to form brucine fluoborate.^(950, 951) Brucine fluoborate, $C_{23}H_{26}N_2O_4 \cdot HBF_4$, forms glistening flakes having a rhombic outline which are doubly refracting and which do not melt at a temperature of $250^\circ C.$ Brucine fluoborate is difficultly water-soluble.

Morphine, a member of the morphine group of alkaloids, similarly forms a fluoborate. However, the starting material in this synthesis is morphine hydrochloride.⁽⁹⁵¹⁾ It is essential that no other mineral acids be present; otherwise morphine fluoborate, $C_{17}H_{19}NO_3 \cdot HBF_4$, will not precipitate. The crystals are fine silklike needles which are doubly refracting and exhibit parallel extinction. The crystals are difficultly soluble in water. Wilke-Dörfurt and Balz⁽⁹⁵¹⁾ found that quinidine will not form a fluoborate under the afore-mentioned conditions.

DIAZONIUM FLUOBORATES

Considerable research has been done with the diazonium fluoborates because they afford a means of introducing fluorine into the organic molecule. The first reference to diazonium fluoborates is that of H. Bart⁽⁴⁰⁾ in 1913 who made aryldiazo compounds by reacting aromatic diazo compounds with complex acids of boron and fluorine or their salts. The mechanism of the Schiemann⁽³³⁾ reaction is to diazotize the organic compound first and then treat it with fluoboric acid or one of its salts to form the diazonium fluoborate. Starkey *et al.*⁽²²¹⁾ obtained higher yields, in general, by adding the fluoboric acid prior to diazotization. The diazonium fluoborate upon heating decomposes with the evolution of nitrogen and boron trifluoride, leaving behind the fluoride derivative

of the organic compound.⁽⁵⁹¹⁾ For an aryl fluoborate, the reaction may be represented thus:

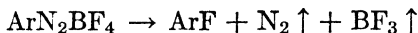

Whenever the organic fluoride produced by the decomposition of the diazonium fluoborate tends to break down owing to instability, the decomposition may be effected at a lower temperature in a vacuum.^(456a)

In an improved method nitrosyl fluoborate is used in place of fluoboric acid.⁽⁹³¹⁾ As an example, $\text{C}_6\text{H}_5\text{N}_2\text{BF}_4$ was prepared in 90% yield from 1 g. aniline hydrochloride in 9.5 ml. of dilute alcohol with 1.4 g. of nitrosyl fluoborate at 3–5°C. The product on being heated gave 100% $\text{C}_6\text{H}_5\text{F}$.

Dioxane has been used⁽³¹¹⁾ as a reaction medium for diazotization in preparation of diazonium fluoborates with improved results. Not only can the diazonium fluoborates be thermally decomposed to prepare aryl fluorides, but the process yields conveniently a pure boron trifluoride diluted only with nitrogen.^(496, 948, 963)

The diazonium fluoborates react with sodium nitrite to give aryl nitrites:⁽⁸⁵⁷⁾

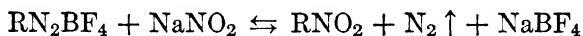

Likewise the N_2BF_4 group can be replaced with the CH_3COO group in acetic acid⁽³²⁹⁾ with a 50% yield of the aryl acetate:



The diazonium fluoborates have been used in synthesis of organometallic compounds. Whaley and Starkey⁽⁹⁴⁴⁾ made aryl-copper complexes, using the diazonium fluoborates. Similarly they made organomercurials.⁽²²¹⁾ Ruddy, Starkey, and Hartung⁽⁷³⁸⁾ used diazonium fluoborates in preparing various arsonic derivatives.

Bruson⁽¹²²⁾ has patented the use of aryldiazonium fluoborates in polymerizing unsaturated organic compounds.

Benzenediazonium Fluoborates. Wilke-Dörfurt⁽⁹⁵⁰⁾ was the first to prepare benzenediazonium fluoborate, $\text{C}_6\text{H}_5\text{N}_2\text{BF}_4$. He synthesized this compound by diazotizing aniline in a hydrochloric acid solution and then reacting the diazotized product with a 40% solution of fluoboric acid. The crystalline mass thus obtained was air-dried, washed with water and then with alcohol and ether, and finally dried over sulfuric acid. Benzenediazonium fluoborate

occurs as colorless doubly refracting glasslike needles which are difficultly soluble in water and are practically insoluble in alcohol and ether. The crystals are not hygroscopic and are nonexplosive.⁽²⁷⁸⁾ The compound is very stable at room temperature.⁽⁹⁵¹⁾

In a similar manner benzenediazonium fluoborate has been prepared by Balz and Schiemann.⁽³³⁾ Starkey *et al.*^(87, 221, 738) obtained between 90 and 97% yield of benzenediazonium fluoborate by adding the fluoboric acid prior to diazotization. Instead of fluoboric acid, ammonium or sodium fluoborate may be used in the preparation of this compound.⁽²⁶⁰⁾ Benzenediazonium fluoborate has also been prepared by the action of nitrosyl fluoborate on aniline hydrochloride in dilute alcohol solution⁽⁹³¹⁾ (*vide supra*).

Funk and Binder⁽²⁷⁸⁾ have prepared benzenediazonium fluoborate by allowing benzenediazonium chloride to react with sodium hydroxide. The product of this reaction was then treated with fluoboric acid. Kroeger, Sowa, and Nieuwland⁽⁴⁷¹⁾ prepared it by allowing the chloride to react with dihydroxyfluoboric acid.

Schiemann and Pillarsky⁽⁷⁷⁰⁾ synthesized *m*-phenylenebis(diazonium fluoborate), $m\text{-C}_6\text{H}_4(\text{N}_2\text{BF}_4)_2$, from *m*-phenylenediamine hydrochloride, using the technic of Balz and Schiemann described previously. The product is photosensitive, turning a pink color when exposed to light. It decomposes to *m*-difluorobenzene when heated to 206°C. Similarly, *p*-phenylenebis(diazonium fluoborate), $p\text{-C}_6\text{H}_4(\text{N}_2\text{BF}_4)_2$, is prepared from *p*-phenylenediamine hydrochloride. It is a brownish-yellow salt which decomposes when heated to 186°C.⁽⁷⁷⁰⁾

Using the same procedure as just discussed for preparing the *o*- and *p*-phenylenebis(diazonium fluoborates), Schiemann and Pillarsky⁽⁷⁷⁰⁾ prepared *p*-fluorophenyldiazonium fluoborate, $p\text{-F}(\text{C}_6\text{H}_4)\text{N}_2\text{BF}_4$, from *p*-fluoroaniline. The product was obtained as white crystals which decompose at 154.5°C. Dunker and Starkey⁽²²⁰⁾ have prepared the compound by a very similar method. Schiemann and Pillarsky⁽⁷⁷⁰⁾ and Dunker and Starkey⁽²²⁰⁾ have prepared also *o*-fluorophenyldiazonium fluoborate, $o\text{-F}(\text{C}_6\text{H}_4)\text{N}_2\text{BF}_4$ by the same method, starting with *o*-fluoroaniline. Orthofluorophenyldiazonium fluoborate forms rose-colored crystals which decompose at 159°C. Dunker and Starkey⁽²²⁰⁾ likewise prepared the *meta* derivative. *p*-fluorobenzoic acid has been made by the decomposition of *p*-carbethoxybenzenediazonium fluoborate.^(770a)

In the preparation of various arsonic acid derivatives, Ruddy, Starkey, and Hartung⁽⁷³⁸⁾ used the appropriate diazonium fluoborate. By treating *o*- and *p*-chloroanilines with fluoboric acid and then diazotizing, they were able to produce *o*- and *p*-chlorophenyldiazonium fluoborates in yields of over 90%.

The nitrophenyldiazonium fluoborates were prepared first by Schiemann *et al.*^(33, 770) They diazotized the appropriate nitroaniline and then treated it with fluoboric acid. The compounds all formed colorless crystals. It was found that the decomposition temperatures and densities, d_4^{25} , for these compounds are: *ortho* 135°C., 1.69; *meta* 178°C., 1.66; *para* 156°C., 1.66, respectively. Later in the preparation of other organic compounds, Starkey *et al.*^(87, 220, 738, 858) similarly prepared all three nitrophenyldiazonium fluoborates, except that they added the fluoboric acid prior to carrying out the diazotization reaction. A good detailed account of the Starkey method of synthesizing aryldiazonium fluoborates is given in *Organic Syntheses*.^(770a, 858)

In the preparation of organic mercurial compounds, Starkey *et al.*⁽²²¹⁾ prepared by the Starkey method (*see above*) *p*-sulphonyldiazonium fluoborate. Similarly, 2-hydroxy-5-sulphonyldiazonium fluoborate was prepared.⁽²²¹⁾

The aminophenols have been converted to the corresponding hydroxyphenyldiazonium fluoborates by diazotizing in an alcoholic suspension in the presence of fluoboric acid. *Ortho*-, *meta*-, and *parahydroxyphenyldiazonium* fluoborates were prepared thus, amyl nitrite, potassium nitrite, or nitrogen trioxide being used for diazotization.⁽⁷¹³⁾

In the Bart reaction, Ruddy, Starkey, and Hartung⁽⁷³⁸⁾ prepared *p*-ethoxyphenyldiazonium fluoborate in a yield of 87% from *p*-phenetidine by the Starkey synthesis.

Starkey *et al.*^(221, 738) have prepared *p*-carboxyphenyldiazonium fluoborate in a yield of 84% from *p*-aminobenzoic acid, and *o*-carboxyphenyldiazonium fluoborate in a yield of 46% from *o*-aminobenzoic acid, using the technic outlined previously. Similarly, they have prepared 3-carboxy-4-hydroxyphenyldiazonium fluoborate.⁽²²¹⁾ In a study of the Bart reaction, these workers prepared *p*-carbethoxyphenyldiazonium fluoborate and *p*-acetylphenyldiazonium fluoborate in yields of over 90% from ethyl-*p*-aminobenzoate and *p*-acetophenone, respectively.⁽⁷³⁸⁾ Dunker and

Starkey⁽²²⁰⁾ converted 4-fluoro-3-aminobenzoic acid into 2-fluoro-5-carbethoxybenzenediazonium fluoborate by this method. This product melts at 185°C. with decomposition.

Bolth, Whaley, and Starkey⁽⁸⁷⁾ have prepared, in an analogous manner, *p*-tolylphenyldiazonium fluoborate as an intermediate compound in the preparation of aryl-copper compounds.

Toluenediazonium Fluoborates. Wilke-Dörfurt⁽⁹⁵⁰⁾ first reported the preparation of *o*-tolylidiazonium fluoborate. The mode of synthesis was to diazotize *o*-toluidine and then treat it with fluoboric acid.⁽⁹⁵¹⁾ The compound is difficultly soluble in water. Finger and Reed⁽²⁶⁰⁾ modified the procedure by using either sodium or ammonium fluoborate in place of the fluoboric acid.

Balz and Schiemann,⁽³³⁾ using the previously described process, first prepared *p*-tolylidiazonium fluoborate from *p*-toluidine. The product is obtained as white crystals which have a density, d_4^{25} , of 1.48 and which decompose at 110°C., forming *p*-fluorotoluene.

Starkey *et al.*,^(220, 738) using their modification of the aforementioned synthesis, have obtained the *o*-, *m*-, and *p*-tolylidiazonium fluoborates in yields of over 90% from *o*-, *m*-, and *p*-toluidine, respectively.

Finger and Reed⁽²⁶¹⁾ prepared diazonium fluoborates by diazotizing the following compounds in a strongly acidic solution and then treating the solution with sodium fluoborate: thus a 94% yield was obtained with 2-nitro-5-aminobenzotrifluoride, an 85% yield with 2-amino-5-fluorobenzotrifluoride, an 88% yield with 3-amino-5-nitrobenzotrifluoride, and a 94% yield with 3-amino-5-fluorobenzotrifluoride.

Xylenediazonium Fluoborates. Metaxylyldiazonium fluoborate was prepared from xylydine in 1927 by Balz and Schiemann,⁽³³⁾ using their usual procedure. The compound has a density, d_4^{25} , of 1.50 and decomposes when heated to 108°C., thus forming 4-fluoro-1,3-dimethylbenzene.

Naphthalenediazonium Fluoborates. Balz and Schiemann⁽³³⁾ first prepared α -naphthyldiazonium fluoborate from α -naphthylamine by first diazotizing it and then reacting the diazotized product with fluoboric acid. Finger and Reed⁽²⁶⁰⁾ have substituted sodium and ammonium fluoborates for the fluoboric acid. Alphanaphthyldiazonium fluoborate decomposes at 113°C. and yields α -fluoronaphthalene.

In an alcoholic suspension, β -amino- α -naphthol may be diazotized by means of amyl or potassium nitrite or nitrogen trioxide and then treated with fluoboric acid to form α -hydroxy- β -naphthyldiazonium fluoborate.⁽⁷¹³⁾

Diphenyldiazonium Fluoborates. Dunker, Starkey, and Jenkins⁽²²¹⁾ prepared *p*-phenylphenyldiazonium fluoborate by the Starkey procedure (*vide supra*) as an intermediate compound in the preparation of chloromercuriderivatives of organic compounds.

Diphenylene-4-4'-bisdiazonium fluoborate was first prepared by Balz and Schiemann⁽³³⁾ from benzidine, using the method of synthesis discussed previously. This procedure has been modified by using sodium fluoborate^(260, 502) and ammonium fluoborate⁽²⁶⁰⁾ in place of the fluoboric acid solution. Diphenylene-4-4'-bisdiazonium fluoborate has a density, d_4^{25} , of 1.73, and upon heating turns pink at 130°C., decomposes at 150°C., and foams at 157°C.^(33, 502)

LeFevre and Turner⁽⁵⁰²⁾ diazotized 2-nitrobenzidine and then added sodium fluoborate to produce 2-nitrodiphenylene-4-4'-bisdiazonium fluoborate. Using dioxane as a solvent for preparation of the diazonium fluoborate 9-fluorophenanthrene has been prepared.⁽³¹¹⁾ Schiemann^(768a) has nicely summarized known diazonium fluoborates (see Tables 24-29).

TABLE 24

SIMPLE ARYL FLUORIDES FROM DIAZONIUM FLUOBORATES^(768a)

Aryl Fluoride (I)	Diazonium Fluoborate (II)	Decomp. Temp. (II)	Yield		B. Pt. or F. Pt. of (I)
			(II)	(I)	
Fluorobenzene	Phenyl-	122°	70	80	B. pt. 85°
<i>o</i> -Fluorotoluene	<i>o</i> -Tolyl	106°	82	90	B. pt. 17 19°
<i>m</i> -Fluorotoluene	<i>m</i> -Tolyl	108°	76	87	B. pt. 116°
<i>p</i> -Fluorotoluene	<i>p</i> -Tolyl	110°	67	97	B. pt. 117°
4-Fluoro-1,3-xylene	2,4-Xylyl-	108°	31	100	B. pt. 749 143°
1-Fluoronaphthalene	1-Naphthyl-	113°	91	98	B. pt. 11 80°
2-Fluoronaphthalene	2-Naphthyl-	108°	90	69	F. pt. 60°
2-Fluorodiphenyl	2-Diphenyl-	81°	85	89	F. pt. 60°
3-Fluorodiphenyl	3-Diphenyl-	91°	85	50	F. pt. 30°
4-Fluorodiphenyl	4-Diphenyl-	116°	88	85	F. pt. 75°
Bz-1-Fluorobenzanthrone	Bz-1-Benzanthronyl	150°	100	60	F. pt. 195°

TABLE 25

HALOGENO ARYL FLUORIDES FROM DIAZONIUM FLUOBORATES ^(768a)

Halogeno Aryl Fluoride (I)	Diazonium Fluoborate (II)	Decomp. Temp. (II)	Yield		B. Pt. or F. Pt. of (I)
			(II)	(I)	
<i>o</i> -Difluorobenzene	<i>o</i> -Fluorophenyl-	159°	45	30	B. pt. ₇₅₁ 91/2°
<i>p</i> -Difluorobenzene	<i>p</i> -Fluorophenyl-	155°	63	61	B. pt. 88°
1,2,4-Trifluorobenzene	2,4-Difluorophenyl-	145°	42	17	B. pt. 88°
	2,5-Difluorophenyl-	150°	29	55	
<i>o</i> -Fluorobromobenzene	<i>o</i> -Bromophenyl-	132°	40	55	B. pt. ₇₅₆ 158°
<i>m</i> -Fluorobromobenzene	<i>m</i> -Bromophenyl-	141°	86	78	B. pt. ₇₆₄ 150°
<i>p</i> -Fluorobromobenzene	<i>p</i> -Bromophenyl-	133°	64	75	B. pt. ₇₄₆ 151°
<i>o</i> -Fluoroiodobenzene	<i>o</i> -Iodophenyl-	89°	75	44	B. pt. ₁₄ 73.6°
<i>m</i> -Fluoroiodobenzene	<i>m</i> -Iodophenyl-	105°	98	68	B. pt. ₁₉ 77.6°
2,5-Difluorotoluene	4-Fluoro-2-tolyl-	115°	62	80	B. pt. ₇₇₅ 117°
4-Fluoro-3-iodotoluene	2-Iodo-4-tolyl-	110°	70	70	B. pt. ₃₀ 122/5°
2,4-Difluoro-5-chloro-3-iodotoluene	3-Fluoro-6-chloro-2-iodo-4-tolyl-	218°	65	85	B. pt. 244/6°
1-Fluoro-6-bromo-2,4-xylene	6-Bromo-2,4-xylyl-	161°	60	100	B. pt. ₁₁ 87/9°
4,6-Difluoro-5-iodo-1,3-dimethylbenzene	5-Fluoro-6-iodo-2,4-xylyl-	235°	65	75	F. pt. 42/3°
1,4-Difluoronaphthalene	4-Fluoro-1-naphthyl-	137°	47	66	F. pt. 31.5°
1-Fluoro-4-bromonaphthalene	4-Bromo-1-naphthyl-	152°	97	66	F. pt. 37°
2-Fluoro-1-bromonaphthalene	1-Bromo-2-naphthyl-	99°		23	F. pt. 49°
2,4,4'-Trifluorodiphenyl	4,4'-Difluoro-3-diphenyl-	88°	95	85	F. pt. 83/4°
2,4,4',5-Tetrafluorodiphenyl	2,4,4'-Trifluoro-5-diphenyl-	102°	83	90	F. pt. 139°
4,4',6-Trifluoro-3,3'-ditolyl	4,4'-Difluoro-3,3'-ditolyl-6-	94°	52	52	B. pt. ₁₂ 140°

TABLE 26

ARYL DIFLUORIDES FROM TETRAZONIUM FLUOBORATES ^(768a)

Aryl Difluoride (I)	Tetrazonium Fluoborate (II)	Decomp. Temp. (II)	Yield		B. Pt. or F. Pt. of (I)
			(II)	(I)	
<i>m</i> -Difluorobenzene	<i>m</i> -Phenylene-	206°	88	44	B. pt. ₇₅₂ 82/3°
<i>p</i> -Difluorobenzene	<i>p</i> -Phenylene-	186°	82	33	B. pt. 88°
1,5-Difluoronaphthalene	1,5-Naphthylene-	180°	92	54	F. pt. 70.5°
2,2'-Difluorodiphenyl	2,2'-Diphenylene-	134°	84	70	F. pt. 117.5°
3,3'-Difluorodiphenyl	3,3'-Diphenylene-	106°	98	50	B. pt. ₁₄ 130°
4,4'-Difluorodiphenyl	4,4'-Diphenylene-	138°	95	85	F. pt. 95°
4,4'-Difluoro-3,3'-ditolyl	3,3'-Ditolylene-4,4'-	127°		64-70	F. pt. 59°

TABLE 27

FLUORONITRO COMPOUNDS FROM DIAZONIUM FLUOBORATES ^(768a)

Fluoronitro Compound (I)	Diazonium Fluoborate (II)	Decomp. Temp. (II)	Yield		B. Pt. or F. Pt. of (I)
			(II)	(I)	
<i>o</i> -Fluoronitrobenzene	<i>o</i> -Nitrophenyl-	135°	74	18	B. pt. ₁₁ 87°
<i>m</i> -Fluoronitrobenzene	<i>m</i> -Nitrophenyl-	178°	79	53	B. pt. ₁₉ 86°
<i>p</i> -Fluoronitrobenzene	<i>p</i> -Nitrophenyl-	156°	96	47	B. pt. ₂₈ 97°
2-Fluoronitrotoluene	6-Nitro-2-tolyl-	143°	50	23	B. pt. ₁₂ 110/11°
1-Fluoro-2,4-dimethyl-5-nitrobenzene	2,4-Dimethyl-5-nitrophenyl-	130°	53	53	B. pt. ₃₀ 133°
4,4'-Difluoro-2-nitrodiphenyl	2-Nitro-4,4'-diphenylene-	128°	95	10	F. pt. 94.6°
4,4'-Difluoro-6-nitro-3,3'-ditolyl	6-Nitro-3,3'-ditolylene-4,4'-	98°	98	10	F. pt. 89.5°
2-Fluoro-5-chloro-4-nitrotoluene	4-Chloro-5-nitro-2-tolyl-	153°	61	50	B. pt. ₇₆₀ 247° F. pt. 19°
3,5-Dimethyl-2-fluoro-1-bromo-6-nitrobenzene	2,4-Dimethyl-6-bromo-5-nitrophenyl-	195°	67	45	F. pt. 51°
<i>p</i> -Fluoro- <i>N</i> -dimethylaniline	<i>p</i> -Dimethylamino-phenyl-	151°	56	17	F. pt. 35°
<i>p</i> -Fluoro- <i>N</i> -diethylaniline	<i>p</i> -Diethylamino-phenyl-	113°	83	20	B. pt. ₁₂ 92.5°

TABLE 28

FLUORO-OXY COMPOUNDS FROM DIAZONIUM FLUOBORATES ^(768a)

Fluoro Compound (I)	Diazonium Fluoborate (II)	Decomp. Temp. (II)	Yield		B. Pt. or F. Pt. of (I)
			(II)	(I)	
<i>o</i> -Fluoroanisole	<i>o</i> -Anisyl-	125°	52	67	B. pt. ₁₇ 64°
<i>m</i> -Fluoroanisole	<i>m</i> -Anisyl-	68°	100	69	B. pt. ₁₅ 51°
<i>p</i> -Fluoroanisole	<i>p</i> -Anisyl-	139°	85	67	B. pt. ₁₉ 57°
2-Fluoro-4-bromanisole	2-Methoxy-5-bromophenyl-	156°	92	54	F. pt. 16°
2-Fluoro-4-nitroanisole	2-Methoxy-5-nitrophenyl-	173°	85	13	F. pt. 104.6°
6-Fluoro-1,2-cresol-methyl ether	2-Methoxy-3-tolyl-	88°	68	62	B. pt. ₁₉ 59°
2-Fluoro-1,4-cresol-methyl ether	2-Methoxy-5-tolyl-	122°	82	48	B. pt. ₁₂ 72°
1-Fluoro-2,4-dimethyl-6-bromo-5-methoxybenzene	2,4-Dimethyl-6-bromo-5-methoxyphenyl-	105°	70	80	B. pt. ₁₆ 125°
3-Fluoro-4-methoxydiphenyl ether	4-Methoxy-1-phenoxy-3-phenyl-	145°	100		
<i>o</i> -Fluorophenetole	<i>o</i> -Ethoxyphenyl-	135°	69	35	B. pt. ₁₁ 64°
<i>m</i> -Fluorophenetole	<i>m</i> -Ethoxyphenyl-	70°	75	47	B. pt. ₁₅ 65°
<i>p</i> -Fluorophenetole	<i>p</i> -Ethoxyphenyl-	105°	75	50	B. pt. ₁₈ 71°
2-Fluoro-4-nitrophenetole	2-Ethoxy-5-nitrophenyl-	179°	90	6	F. pt. 77°

TABLE 29

FLUORO ESTERS FROM ESTER DIAZONIUM FLUOBORATES (768a)

Fluoro Compound (I)	Ester Diazonium Fluoborate (II)	Decomp. Temp. (II)	Yield			B. Pt. Ester	F. Pt. Acid
			(II)	Ester	Acid		
Ethyl- <i>o</i> -Fluorobenzoate	<i>o</i> -Carbethoxyphenyl-	106°	90	87	45	B. pt. ₁₂ 102°	125°
Ethyl- <i>p</i> -Fluorobenzoate	<i>p</i> -Carbethoxyphenyl-	94°	96	89	73	B. pt. ₂₅ 105°	186°
Diethyl-4-fluoro- <i>o</i> -phthalate	3,4-Dicarbethoxyphenyl-	125°	98	50	..	B. pt. ₂₅ 165 to 170°	148°

CARBOXONIUM FLUOBORATES

Acetyl fluoborate, $(\text{CH}_3\text{CO})^+(\text{BF}_4)^-$, a colorless solid, has been prepared by condensing boron trifluoride and acetyl fluoride together, or by mixing them in an indifferent solvent such as carbon tetrachloride, chloroform, or liquid sulfur dioxide.⁽⁷⁸⁸⁾ It has also been prepared by condensation of boron trifluoride with an excess of acetyl fluoride⁽⁶¹⁷⁾ only. It is solvolyzed by aqueous potassium sulfate to give acetic and sulfuric acids and potassium fluoborate: $2\text{CH}_3\text{COBF}_4 + 2\text{H}_2\text{O} + \text{K}_2\text{SO}_4 \rightarrow 2\text{CH}_3\text{COOH} + \text{H}_2\text{SO}_4 + 2\text{KBF}_4$. With sodium fluoride it yields acetyl fluoride and sodium fluoborate: $\text{NaF} + \text{CH}_3\text{COBF}_4 \rightarrow \text{CH}_3\text{COF} + \text{NaBF}_4$. In liquid sulfur dioxide, ethyl ether-boron trifluoride, or acetic anhydride as solvents, it reacts with potassium chloride (or bromide) to give acetyl chloride (or bromide) and potassium fluoborate: $\text{KCl}(\text{Br}) + \text{CH}_3\text{COBF}_4 \rightarrow \text{CH}_3\text{COCl}(\text{Br}) + \text{KBF}_4$. With sodium nitrite it forms acetyl nitrite and sodium fluoborate: $\text{CH}_3\text{COBF}_4 + \text{NaNO}_2 \rightarrow \text{CH}_3\text{CONO}_2 + \text{NaBF}_4$, and at the same time the acetyl nitrite reacts further with excess acetyl fluoborate to give nitrosyl fluoborate and acetic anhydride: $\text{CH}_3\text{COBF}_4 + \text{CH}_3\text{CONO}_2 \rightarrow \text{NOBF}_4 + (\text{CH}_3\text{CO})_2\text{O}$; likewise ethyl or isoamyl nitrite in chloroform or in hexane, reacts with acetyl fluoborate to give ethyl or isoamyl acetate and nitrosyl fluoborate: $\text{CH}_3\text{COBF}_4 + \text{Et}(\text{or isoamyl})\text{NO}_2 \rightarrow \text{NOBF}_4 + \text{AcOEt}(\text{or isoamyl})$.

The acetyl fluoborate is decomposed by acetic acid to yield acetyl fluoride and the boron trifluoride-acetic acid complex:

$\text{CH}_3\text{COBF}_4 + \text{CH}_3\text{COOH} \rightarrow \text{CH}_3\text{COF} + \text{CH}_3\text{COOH} \cdot \text{BF}_3$. Likewise it is decomposed by ether on slight warming: $\text{CH}_3\text{COBF}_4 + (\text{C}_2\text{H}_5)_2\text{O} \rightarrow \text{CH}_3\text{COF} + (\text{C}_2\text{H}_5)_2\text{O} \cdot \text{BF}_3$, but in an autoclave at 100° the reaction yields ethyl fluoride and the boron trifluoride-ethyl acetate complex: $\text{CH}_3\text{COBF}_4 + (\text{C}_2\text{H}_5)_2\text{O} \rightarrow \text{C}_2\text{H}_5\text{F} + \text{CH}_3\text{COOC}_2\text{H}_5 \cdot \text{BF}_3$; similarly with α, α' -dimethyl- γ -pyrone in chloroform the acetoxypyrylium fluoborate is formed in 65% yield. Apparently in acetyl fluoborate the bond strength of the coordinated $\text{BF}_3 \leftarrow \text{F}^-$ bond is weaker than the bond strength of singly bonded oxygen and boron trifluoride. The reverse is true with metallic fluoborates. Acetyl fluoborate converts benzene to acetophenone: $\text{CH}_3\text{COBF}_4 + \text{C}_6\text{H}_6 \rightarrow \text{C}_6\text{H}_5\text{OCCH}_3 + \text{HF} + \text{BF}_3$.

The molar conductance of acetyl fluoborate in liquid sulfur dioxide decreases with rise in temperature: $\Lambda = 12.7$ mhos at -70° and 70.8 l., and 1.1 mhos at -10° and 79.0 l. The molar conductance of acetyl fluoborate in acetyl chloride also rises with the temperature: $\Lambda = 0.37$ mho at -70° and 42.1 l., and 0.10 at 0° and 46.1 l.

In nuclear-cross-section studies⁽⁶¹⁷⁾ in which boron trifluoride was used as a reference gas, a procedure for the analysis of this gas was based on the condensation of boron trifluoride with an excess of acetyl fluoride to form acetyl fluoborate. Silicon tetrafluoride is the most likely impurity remaining in the acetyl fluoborate after two fractional distillations *in vacuo* at -160°C . Tests with synthetic mixtures indicated that 0.2% impurity can be detected.

Mayer⁽⁵⁸¹⁾ obtained a German patent in 1941 for the production of "molecular fluoborates of organic acids" by the action of organic acid anhydrides on a solution of boric oxide in hydrofluoric acid. Since further information is lacking, it is uncertain whether this refers to a method of preparation of carboxonium fluoborate or not.

Triphenylmethane Fluoborate is formed by the action of acetyl fluoborate on triphenylmethane chloride in chloroform, acetic anhydride, or liquid sulfur dioxide solution: $\text{CH}_3\text{COBF}_4 + (\text{C}_6\text{H}_5)_3\text{CCl} \rightarrow (\text{C}_6\text{H}_5)_3\text{CBF}_4 + \text{CH}_3\text{COCl}$. Triphenylcarbinol gives the same product and acetic acid. It has been prepared also by saturating a benzene solution of triphenylmethyl fluoride with boron trifluoride. The red precipitate was filtered off, washed with benzene and ether, and pumped to dryness. The salt was purified by precipitation from ethylene chloride-acetone

solution with pentane and washed with benzene, ether, and pentane.^(954a) It is a chrome-yellow very hygroscopic microcrystalline powder, melting at 195–196° according to Wischonke and Kraus.^(954a) It is photosensitive, turning brown in the light. It is precipitated by ethyl ether to give a yield of about 86%. In nitrobenzene at 25° it has a dissociation constant in the neighborhood of $K = 0.01$. The fluoborate in nitrobenzene is a fairly strong electrolyte resembling in this respect the perchlorate ion.^(954a)

TERTIARY OXONIUM FLUOBORATES

Ethyloxonium Fluoborate. Meerwein, Hinz, Hoffmann, Kroning, and Pfeil⁽⁵⁸⁷⁾ found that the reaction of $\text{Et}_2\text{O} \cdot \text{BF}_3$ and epichlorohydrin, $\text{ClCH}_2\text{CH} \cdot \text{O} \cdot \text{CH}_2$ in the presence of an excess of Et_2O at 20–25° yields a crystalline precipitate of $(\text{Et}_3\text{O})\text{BF}_4$ in 93% yield:

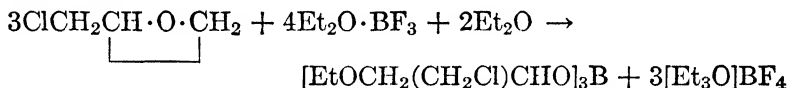

The ethyl ether solution contains 74% of the boric ester. With sodium carbonate the boric ester-ether solution yields 90% of $\text{ClCH}_2\text{CH}(\text{OH})\text{CH}_2\text{OEt}$ and 10% of $\text{C}_5\text{H}_{11}\text{O}_2\text{ClBF}$ (m. pt. 108°) its formation being due to traces of water.

In later work, Meerwein, Battenberg, Gold, Pfeil, and Willfang⁽⁵⁸⁶⁾ found that the addition of 14 g. of $\text{ClCH}_2\text{CHOCH}_2$ to

19 g. of $\text{Et}_2\text{O} \cdot \text{BF}_3$ in 50 cc. ether at a rate such that the ether constantly boils, followed by stirring for 2 hours, gives 100% of $(\text{Et}_3\text{O})\text{BF}_4$.

Triethyloxonium fluoborate melts at 92° with decomposition, is hygroscopic, and quickly liquefies in air. Dry distillation of this fluoborate yields 92% $\text{Et}_2\text{O} \cdot \text{BF}_3$ and 67.4% ethyl fluoride. This action is reversible for these two products. If they are kept in a bomb at room temperature for 5 months a yield of 73% of the $(\text{Et}_3\text{O})\text{BF}_4$ is obtained. Solution in ethyl ether speeds the reaction.⁽⁵⁸⁷⁾

Triethyloxonium fluoborate reacts with saturated aqueous sodium picrate to give an immediate precipitation of triethyloxonium picrate and sodium fluoborate. The corresponding reac-

tion with sodium iodide did not proceed. However, solid sodium iodide and triethyloxonium fluoborate in the absence of solvent give 77% of ethyl iodide.⁽⁵⁸⁷⁾

Triethyloxonium fluoborate and 2 *N* sodium carbonate give 89.2% of ethyl ether and 89% of ethanol.⁽⁵⁸⁷⁾ With 1 mole each of triethyloxonium fluoborate and $\text{ClCH}_2\text{CH}(\text{OH})\text{CH}_2\text{OEt}$ there results in 3 days 55% of the diethyl ether, $\text{ClCH}_2\text{CH}(\text{OEt})\text{CH}_2\text{OEt}$. With phenol, triethyloxonium fluoborate gives 73% anisole whereas with sodium phenolate it gives 91% of anisole.⁽⁵⁸⁷⁾ With anhydrous acetic acid, triethyloxonium fluoborate gives 46% of ethyl acetate; and with sodium benzoate it yields 71% of ethyl benzoate.⁽⁵⁸⁷⁾ An ethyl alcohol solution of $\text{CHNa}(\text{CO}_2\text{Et})_2$ or $\text{AcCHNaCO}_2\text{Et}$, with triethyloxonium fluoborate gives, respectively, 35.8 and 46.7% of the ethyl derivative.⁽⁵⁸⁷⁾

Ammonia reacts with triethyloxonium fluoborate to give a mixture of mono-, di-, and triethylamines.⁽⁵⁸⁷⁾ Pyridine reacts with triethyloxonium fluoborate to give nearly quantitative yields of ethyl ether and ethylpyridinium fluoborate (m. pt. 58.5–59.5°C); on oxidation with potassium ferricyanide this latter compound is converted to *N*-ethyl pyridone.⁽⁵⁸⁷⁾ With ethyl sulfide, triethyloxonium fluoborate yields 97% of triethylsulfonium fluoborate $(\text{Et}_3\text{S})\text{BF}_4$ (m. pt. 105.5°).⁽⁵⁸⁷⁾

Dimethylpyrone and triethyloxonium fluoborate form γ -ethoxy- α, α' -dimethylpyrilium fluoborate (m. pt. 90–91°).⁽⁵⁸⁷⁾ Coumarin and triethyloxonium fluoborate form α -ethoxybenzopyrylium fluoborate [m. pt. 106° (decomposition)].⁽⁵⁸⁷⁾ Camphor and triethyloxonium fluoborate form the compound $\text{C}_{12}\text{H}_{21}\text{OBF}_4$, [m. pt. 104.5–105.5° (decomposition)].⁽⁵⁸⁷⁾

Addition of triethyloxonium fluoborate to α, β -unsaturated ketones gives colored solutions, which may contain $(\text{RCH}:\text{CH})_2\text{C}(\text{OEt})\text{BF}_4$ or $(\text{RCH}:\text{CH})_2\text{C}:\text{O}(\text{Et})\text{BF}_4$.⁽⁵⁸⁷⁾ The compound from dianisalacetone, $\text{C}_{21}\text{H}_{23}\text{O}_3\text{BF}_4$, violet-black, decomposes on heating to give ethyl fluoride.⁽⁵⁸⁷⁾

Triethyloxonium fluoborate reacts with diethyl sulfoxide to give diethyloxyethylsulfonium fluoborate, $(\text{C}_2\text{H}_5)_2\text{SOC}_2\text{H}_5\text{BF}_4$, which decomposes quickly in air.⁽⁵⁸⁸⁾ Triethyloxonium fluoborate and $(\text{CH}_3)_3\text{NO}$ react in methylene chloride solution to give $[(\text{CH}_3)_3\text{NOC}_2\text{H}_5]\text{BF}_4$ which is very hygroscopic.⁽⁵⁸⁸⁾

When triethyloxonium fluoborate and urea are mixed in the dry state, they soon liquefy, forming $[(\text{H}_2\text{N})_2\text{COC}_2\text{H}_5]\text{BF}_4$. This

compound forms a picrate [m. pt. 184–185° (with decomposition)]. Alkali decomposes the fluoborate, giving *O*-ethylisourea.⁽⁵⁸⁶⁾ Triethyloxonium fluoborate and acetamide give the very hygroscopic compound $[\text{CH}_3\text{C}(\text{:NH})\text{OC}_2\text{H}_5]\text{BF}_4$.⁽⁵⁸⁶⁾ If the inner oxonium salt from 50 g. $(\text{C}_2\text{H}_5)_2\text{O}\cdot\text{BF}_3$ and 35 g. of $\text{ClCH}_2\text{CHOCH}_2$ is

treated with $(\text{C}_2\text{H}_5)_2\text{O}\cdot\text{BF}_3$ at Dry Ice temperatures, there results 61 g. (91%) of triethyloxonium fluoborate and 40.2 g. of $[\text{ClCH}_2\text{CH}(\text{CH}_2\text{OC}_2\text{H}_5)_2]\text{B}$.⁽⁵⁸⁶⁾

That $(\text{C}_2\text{H}_5)_3\text{OBf}_4$, $(\text{CH}_3)_3\text{OBf}_4$, and $(\text{C}_2\text{H}_5)_3\text{SBf}_4$ are salts is shown by their good electric conductivity in liquid sulfur dioxide.⁽⁵⁸⁶⁾

Trimethyloxonium Fluoborate. Dimethyl ether–boron trifluoride, $(\text{CH}_3)_2\text{O}\cdot\text{BF}_3$, and epichlorohydrin, $\text{ClCH}_2\text{CHOCH}_2$ is

dimethyl ether, yield 98.2% of trimethyloxonium fluoborate [m. pt. 124.5° (with decomposition)] and some of the fluoborate of $\text{ClCH}_2(\text{MeOCH}_2)\text{CHOH}$ and 86% of the boric ester, $[\text{CH}_2\text{Cl}(\text{MeOCH}_2)\text{CHO}]_3\text{B}$. The trimethyloxonium fluoborate is soluble only in nitromethane and liquid sulfur dioxide.⁽⁵⁸⁷⁾

When methyl fluoride and $(\text{C}_2\text{H}_5)_2\text{O}\cdot\text{BF}_3$ are allowed to stand 4 months, a 52% yield of methyldiethyloxonium fluoborate, m. pt. 99–100° (with decomposition) is obtained.⁽⁵⁸⁶⁾ When a mixture of 1 mole of ethyl fluoride and 1.7 moles of $(\text{CH}_3)_2\text{O}\cdot\text{BF}_3$ is allowed to stand for 3 months in a sealed tube, a yield of 38% of trimethyloxonium fluoborate is obtained. Made in this way its melting point is 148° (with decomposition) instead of 124.5° previously reported. On careful heating trimethyloxonium fluoborate dissociates into the two components.⁽⁵⁸⁶⁾

When $(\text{CH}_3)_2\text{O}\cdot\text{BF}_3$ and propyl fluoride are allowed to stand similarly, trimethyloxonium fluoborate is obtained with none of the propyl compound.⁽⁵⁸⁶⁾

When $(\text{CH}_3)_2\text{O}\cdot\text{BF}_3$ dissolved in dimethyl ether cooled with Dry Ice–ether mixture is treated with $\text{ClCH}_2\text{CH}\cdot\text{O}\cdot\text{CH}_2$, an

81.3% yield of the compound $[\text{ClCH}_2\text{CH}(\text{CH}_2\text{OCH}_3)]_2\text{OBf}_3$ –
[m. pt. 75–80° (with decomposition)] is obtained; it is very unstable and decomposes in 2 to 3 hours to a yellow–brown oil with liberation of boron trifluoride.⁽⁵⁸⁶⁾ $(\text{C}_2\text{H}_5)_2\text{O}\cdot\text{BF}_3$ reacts similarly, but on warming to room temperature the product reacts with the

ethyl ether adhering to it to give ethyl fluoride, ethyl ether, $(C_2H_5)_2O \cdot BF_3$, $ClCH_2CH(OC_2H_5)CH_2OC_2H_5$, $ClCH_2CH(OBF_2)CH_2OC_2H_5$ and $[ClCH_2CH(CH_2OC_2H_5)O]_3B$.⁽⁵⁸⁶⁾ Triethyloxonium fluoborate, $(C_2H_5)_3OBF_4$, and dimethyl ether on standing in dichloromethane for 5 days gave a 92% yield of trimethyloxonium fluoborate,⁽⁵⁸⁶⁾ showing the greater stability of the latter compound.

Tripropyloxonium Fluoborate. Addition of 6.4 g. $Pr_2O \cdot BF_3$ in 40 cc. dipropyl ether to 4.6 g. $ClCH_2CH(OCH_2CH_2)CH_2OC_2H_5$ gives a 30% yield of tripropyloxonium fluoborate melting at 73–74° (with decomposition).⁽⁵⁸⁶⁾

Pyridiniumoxonium Fluoborates. The pyridine–boron trifluoride complex, $C_5H_5N \cdot BF_3$, reacts with ethylene oxide in pyridine at 0° to give 100% yield of $C_5H_5N^+OCH_2CH_2OBF_3^-$ (m. pt. 131–132°); it is hydrolyzed by water; with aqueous $NaI \cdot HgI_2$ it gives yellow needles, melting at 39°, of the salt $(HOCH_2CH_2NC_5H_5)HgI_3$, and with $NaCl \cdot HgCl_2$ it gives $(HOCH_2CH_2NC_5H_5)Cl \cdot 6HgCl_2$.⁽⁵⁸⁶⁾ With $ClCH_2CH(OCH_2CH_2)CH_2OC_2H_5$, $C_5H_5N \cdot BF_3$ in pyridine gives 62.8% yield of $ClCH_2CH(OBF_3^-)CH_2NC_6H_5^+$ which after recrystallization from liquid sulfur dioxide melts at 164–165°.⁽⁵⁸⁶⁾

Trimethylamine–Boron Trifluoride. $(CH_3)_3N \cdot BF_3$ and ethylene oxide, when heated and shaken in a sealed tube at 40–45°C. for 2 hours and at 60–70°C. for 2 hours, gave 100% yield of $(CH_3)_3N^+CH_2 \cdot CH_2OBF_3^-$ melting at 296–298° after precipitation from nitromethane by nitrobenzene.⁽⁵⁸⁶⁾

Tetra-alkylammonium Triphenyl Fluoborates, $(R)_4N[BF(C_6H_5)_3]$. These interesting fluoborates in which three of the fluorine atoms of the fluoborate ion have been replaced by phenyl groups were discovered by Fowler and Kraus.^(270a) They were made by refluxing a mixture of a quaternary ammonium fluoride with triphenyl boron amine in ethyl alcohol for several hours, during which time ammonia is evolved and crystals of the triphenyl fluoborate formed. After cooling, the crystals were recrystallized from alcohol. The crystals were stable in air.

Tetramethylammonium Triphenyl Fluoborate, $(CH_3)_4N[BF(C_6H_5)_3]$. Tetramethylammonium hydroxide was prepared from the bromide by addition of freshly prepared silver oxide.^(270a)

After the silver bromide was filtered off the resulting filtrate was neutralized with hydrofluoric acid. The anhydrous tetramethylammonium fluoride separated when the solution was evaporated at 115° in a vacuum. Equivalent quantities of this tetramethylammonium fluoride and triphenyl boron ammine were refluxed in ethyl alcohol solution for several hours, during which time ammonia is evolved and crystals form. Recrystallization from alcohol gives crystals of $(\text{CH}_3)_4\text{N}[\text{BF}(\text{C}_6\text{H}_5)_3]$ melting at $175\text{--}177^\circ\text{C}$. The limiting conductance of this salt in ethylene dichloride at 25° has been reported by Fowler and Kraus^(270b) to be $\Lambda_0 = 68.5$, and the ionization constant ($K \times 10^4$) is calculated to be 0.201. The ion conductance of the $[\text{FB}(\text{C}_6\text{H}_5)_3]^-$ ion is calculated as 26.2.

Tetra-*n*-butylammonium Triphenyl Fluoborates. $(n\text{-C}_4\text{H}_9)_4\text{-}[\text{FB}(\text{C}_6\text{H}_5)_3]$ was prepared in the same manner. It was found to melt at $161\text{--}162^\circ$.^(270a) The limiting conductance of this salt in ethylene dichloride at 25°C . was reported^(270b) to be $\Lambda_0 = 52.4$ and the ionization constant ($K \times 10^4$) is calculated to be 2.03. The crystals are stable in air. The limiting conductance^(885a) of this salt in nitrobenzene at 25°C . was $\Lambda_0 = 23.4$, $\Lambda_0^+ = (11.7)$.

MISCELLANEOUS FLUOBORIC ACIDS AND THEIR DERIVATIVES

H_2BF_5 . Hantzsch⁽³²²⁾ reported that he prepared this acid by allowing gaseous boron trifluoride to react with hydrogen fluoride in a reactor kept in an ice bath. The solid, $\text{BF}_3 \cdot 2\text{HF}$ or H_2BF_5 , which results is unstable and dissociates into its gaseous components. In moist air it fumes just as do its components. The compound has a great affinity for water and may react explosively if absorbed in water. Treatment of the acid with potassium hydroxide produced potassium fluoborate as a precipitate, and the excess hydrogen fluoride remained in solution. The hydrogen fluoride was converted to calcium fluoride in the analysis. Because of the instability of the acid and the fact that it readily reacts with water, the melting point could be determined only approximately as being between 56 and 58°C .

Travers and Malaprade⁽⁹⁰²⁾ reported that they prepared the potassium salt of this acid, K_2BF_5 or $\text{BF}_3 \cdot 2\text{KF}$, by heating potassium fluoborate to 580°C .

$\text{H}_2\text{B}_2\text{F}_6$. Travers and Malaprade⁽⁹⁰²⁾ reported that by the reaction of potassium hydroxide on the reaction product of hydrofluoric

acid and boric acid a salt, $K_2B_2F_6 \cdot 1\frac{1}{2}H_2O$, is formed. Wamser^(935a) recently showed that these authors were in error and really had potassium monohydroxy fluoborate, KBF_3OH .

$H_4B_4F_{10}$. Travers and Malaprade⁽⁹⁰²⁾ also reported the potassium salt of this acid made by heating potassium fluoborate at $580^\circ C$. Its structure presumably might be

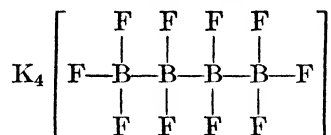

analogous to

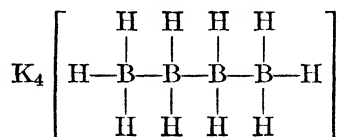

H_2BFO_2 . Schiff *et al.*^(771, 772) prepared the potassium salt of this acid by fusing a mixture of potassium carbonate and a potassium "boratofluoride," $[(KO)FB]_2O$, which may be written $B_2O_3 \cdot 2KF$.

The product was regarded as having the structure

$$\begin{array}{c} K-O \\ \quad \quad \quad \diagdown \\ \quad \quad \quad \quad B-F \\ \quad \quad \quad \diagup \\ K-O \end{array}$$

and has been called "potassium orthofluoborate." It is soluble in a limited quantity of water without decomposition, but in larger quantities of water it is decomposed.

Landolph^(482, 486, 487) allowed boron trifluoride to react with ethylene in the sunlight at a temperature between 25 and $30^\circ C$. He obtained a clear fuming liquid which had a boiling point between 124 and $125^\circ C$. He named the product ethylene oxyfluoborate and offered $(C_2H_4) \cdot HBFO_2$ as its formula. This compound might be considered as a derivative of the acid H_2BFO_2 in which an ethylene group replaces a hydrogen thus:

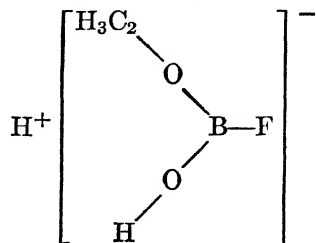

According to Landolph the liquid has a specific gravity of 1.0478 at 23°C. The substance burns with a green flame and is hydrolyzed to yield boric acid and a gas boiling between 10 and 15°C. which he thought was an ethyl fluoride. (Ethyl fluoride boils at -32°C.)

Counciler ⁽¹⁸⁵⁾ has suggested that Landolph could not have obtained this substance by the reaction of ethylene and boron trifluoride and that Landolph missed a hydrogen in the analysis of his product. Counciler postulated that the reaction progresses as shown in the equation:

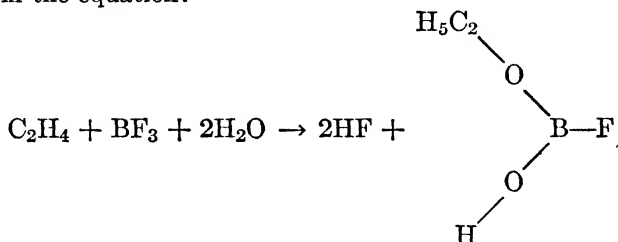

With such a product, Counciler then could account for the formation of boric acid and ethyl fluoride upon hydrolysis by the equation:

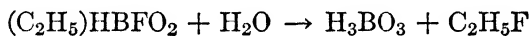

For more recent work involving the reactions of ethylene in the presence of boron trifluoride the reader is referred to the chapter on catalysis.

H₂B₂F₂O₃. According to Schiff, ^(771, 772) the potassium salt of this acid may be prepared by fusing 1 mole of boric oxide with 2 moles of potassium fluoride. The soluble impurities were removed by leaching with alcohol. The compound is known as "potassium boratofluoride" and is soluble in a minimum quantity of water without reaction. With an excess of water the salt is decomposed. Structurally, the formula for the salt may be written:

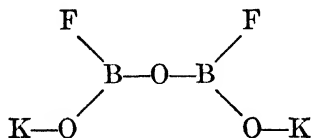

An ammonium acid salt of this acid has been prepared by Petrenko ⁽⁷⁰⁴⁾ by the reaction of hydrogen peroxide and a mixture

of ammonium metaborate and ammonium fluoperborate (*see below*). The structural formula for this compound may be written as

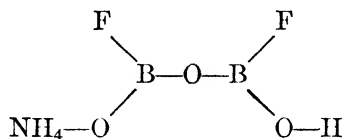

H₂B₂F₂O₆. Melikoff and Lordkipanidze^(594, 595) prepared the monohydrate of the potassium salt of this acid by adding ethanol to a hydrogen peroxide solution of potassium orthofluoborate (*see above*). The salt was prepared also by Petrenko.⁽⁷⁰⁴⁾ These investigators also prepared the trihydrate of the ammonium salt of this acid by treating a solution of boric acid and ammonium fluoride with hydrogen peroxide, ammonia, and ethanol.^(594, 595, 704)

The ammonium salt, called ammonium fluoperborate, is a white crystalline powder which is moderately stable but in an aqueous solution slowly decomposes at room temperature. Upon heating the decomposition is accelerated.⁽⁵⁹⁴⁾

According to the authors, the formulas for these two salts may be written as follows:

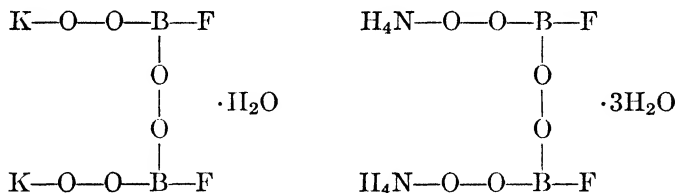

On the other hand, the H₂O₂ may be combined as H₂O₂ of crystallization.

H₂B₂F₄O₂. Kroeger, Sowa, and Nieuwland⁽⁴⁷¹⁾ prepared the nickelous salt of this acid by heating nickelous dihydroxyfluoborate, Ni(H₂BO₂F₂)₂, for 2 or 3 hours at 200°C. under a pressure of 12 mm. of mercury. The product, with analysis corresponding to Ni(BF₂O)₂, was a creamy fluffy powder.

H₃BF₂O₂ Dihydroxyfluoboric Acid. Sowa, Kroeger, and Nieuwland^(471, 826) first reported the preparation of dihydroxyfluoboric acid, H₃BF₂O₂, in 1935 in five different ways. These methods consisted essentially of the procedures involved in the prepara-

tion of boron trifluoride or of its reaction with water and may be summarized best by the five equations:

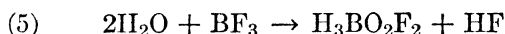
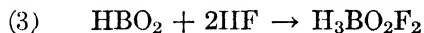
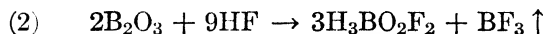
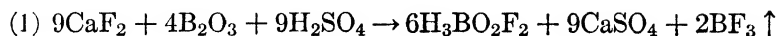

The technic usually employed is to absorb anhydrous hydrogen fluoride in a solution of boric acid in a reactor in an ice bath.

McGrath, Stack, and McCusker⁽⁶⁶⁵⁾ prepared the dihydrate of boron trifluoride and then distilled it under a pressure of 25 mm. Two fractions were obtained, one of which boiled at 85°C. while the other boiled between 93 and 95°C. The lower boiling fraction did not decompose during subsequent distillations, even at pressures as high as atmospheric. The distillate had the properties of dihydroxyfluoboric acid. The reaction is reported to proceed as indicated in the equation:

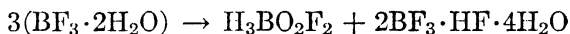

Many of the physical and chemical properties of dihydroxyfluoboric acid have been determined. It is a colorless sirupy liquid which does not attack glass but fumes in moist air. Its melting point is between 4.0 and 4.5°C.⁽⁴⁷¹⁾ Its change of boiling point with pressure is shown in Table 30.

TABLE 30

BOILING POINTS OF DIHYDROXYFLUOBORIC ACID

Pressure in mm.	B. Pt. in °C.	Reference
760	159-160	214, 471, 668, 826
745	159.1	826
141	114	826
68	101.5	826
38	89.5	826
25	93.95	471
16	84.86	471
4	69	826

The surface tension of dihydroxyfluoboric acid at 25°C. has been found to be 58.294 dynes per centimeter.⁽⁸²⁶⁾ The density at 25 and 30°C. is reported as $d_4^{25} = 1.6560$ and $d_4^{30} = 1.6539$ ⁽⁴⁷¹⁾ while its specific gravity at the two temperatures is 1.6569 and 1.6539, respectively.^(668, 826) The refractive index at 25 and 30°C. has been determined as $n_D^{25} = 1.3323$ and $n_D^{30} = 1.3414$.^(471, 826) When these values are used, the observed molecular refraction is calculated to be 10.68 compared with the theoretical value of 10.95 calculated from linkage values.⁽⁴⁷¹⁾ At 25°C. the specific conductance has been measured as 0.0195 mhos.⁽⁴⁷¹⁾

Dihydroxyfluoboric acid is soluble in the complexes composed of ether-boron trifluoride, ethanol-boron trifluoride, and acetic acid-boron trifluoride. It is insoluble in carbon tetrachloride, carbon disulfide, and benzene. With water, methanol, ethanol, or acetic acid a white solid containing fluorine precipitates which melts at 146°C. and upon further heating decomposes into metaboric acid. With dioxane, cineol, acetic anhydride, and acetyl chloride it forms solid compounds (*see below*). When heated alone or with concentrated sulfuric acid, dihydroxyfluoboric acid is decomposed to give boron trifluoride, thus:

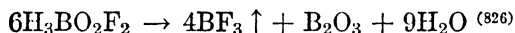

With boron trifluoride, dihydroxyfluoboric acid coordinates to form the compound, $\text{H}_3\text{BO}_2\text{F}_2 \cdot \text{BF}_3$, which is likewise decomposed by heating alone or with concentrated sulfuric acid.⁽⁶⁶⁶⁾

With iron, sodium, calcium, magnesium, or zinc, dihydroxyfluoboric acid reacts in the usual manner of a mineral acid with the evolution of hydrogen. Sometimes the gas has the odor of diborane. It reacts with sodium chloride to give hydrogen chloride. Alkali hydroxides and carbonates as well as potassium permanganate react with dihydroxyfluoboric acid.⁽⁸²⁶⁾

Cuprous oxide reacts very little with the acid whereas cupric oxide reacts as does mercuric oxide. The latter forms a yellow compound.⁽⁸²⁶⁾ The oxide and hydroxide of nickel do not react with the acid. The nickel salt of dihydroxyfluoboric acid was quite easily prepared by allowing nickelous carbonate or chloride to dissolve in the warm acid. Upon cooling, the product separated and was filtered off and pressed until dry on filter paper. The product upon analysis was found to be $\text{Ni}(\text{H}_2\text{BO}_2\text{F}_2)_2 \cdot 3\text{H}_3\text{BO}_2\text{F}_2$. This product occurs as dark-green-colored crystals which melt at 120°C.⁽⁴⁷¹⁾ These dark-green-colored crystals were heated inter-

mittently at 155 to 160°C. under a pressure of 12 mm. for 12 hours, and a light-green-colored product was obtained which upon analysis was found to be the nickel salt of dihydroxyfluoboric acid, $\text{Ni}(\text{H}_2\text{BO}_2\text{F}_2)_2$. This salt when heated for 2 or 3 hours at 200°C. under a pressure of 12 mm. decomposed to produce a creamy fluffy powder and steam. Upon analysis this product was found to be $\text{Ni}(\text{BF}_2\text{O})_2$. Further heating of this product produced a mixture of nickelous oxide and metaborate. The solubility in water of all of these compounds decreased as the heat treatment was increased.⁽⁴⁷¹⁾

Dihydroxyfluoboric acid is decomposed by low-molecular-weight acids, alcohols, esters, ketones, aldehydes, and ethers, with the exception of dioxane, as shown by the equation:

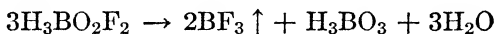

Two moles of the reactant are required per mole of dihydroxyfluoboric acid and the reactant forms a complex with the boron trifluoride liberated.⁽⁴⁷¹⁾ Dihydroxyfluoboric acid when treated with a solution of dioxane in petroleum ether forms large brittle apparently nonhygroscopic crystals which have the composition $\text{C}_4\text{H}_8\text{O}_2 \cdot \text{H}_3\text{BO}_2\text{F}_2$. The crystals have a melting point between 139.5 and 140.5°C.⁽⁴⁷¹⁾ Acetoxyboron fluoride, $(\text{CH}_3\text{COOBF}_2)$, was obtained upon the acetylation of dihydroxyfluoboric acid with acetyl chloride.⁽⁴⁷¹⁾

Dihydroxyfluoboric acid is used commercially as a catalyst and in some types of reactions has been found to be superior to boron trifluoride.^(666, 668, 826) For example, it has been found that alkylations may be carried out with better control and less polymerization when dihydroxyfluoboric acid is used than when boron trifluoride is used. With dihydroxyfluoboric acid, Nieuwland *et al.*^(214, 669) carried out the reactions indicated in Table 31. Spiegler

TABLE 31

ALKYLATIONS USING DIHYDROXYFLUOBORIC ACID AS CATALYST

Reactants	Products
Phenol and propylene	2-Isopropyl and 4-isopropylphenols
Phenol and butylene (80% iso)	Butylphenol, butyl phenyl ether and butyl phenyl butyl ether
Benzene and butylene (80% iso)	<i>s</i> -Butylbenzene and polysubstituted benzenes

and Tinker ⁽⁶³³⁾ used dihydroxyfluoboric acid as a catalyst for the preparation of *s*-hexylresorcinol from 3-hexene and resorcinol and 3-phenylhexane from 3-hexene and benzene.

Nieuwland *et al.* ^(214, 472, 669) found dihydroxyfluoboric acid or its addition compound with boron trifluoride to be an efficient esterification catalyst which can be used repeatedly without loss of activity. Thus have the methyl esters of acetic, adipic, sebacic, oxalic, succinic, malic, tartaric, anthranilic, and benzoic acids been prepared. ⁽⁴⁷²⁾ Similarly, the ethyl ester of acetic acid has been prepared. ^(472, 669) By similar reactions isopropyl, normal propyl, secondary butyl, tertiary butyl, pentyl, vinyl, α -amyl vinyl and glycol acetates have been prepared. ^(214, 472, 669)

Dorris, Sowa, and Nieuwland ⁽²¹⁴⁾ have used dihydroxyfluoboric acid to promote the rearrangement of isopropyl phenyl ether to phenol, 2-isopropyl-, 4-isopropyl-, and 2-4-diisopropyl phenols. They have used this catalyst also to prepare 2,2-dimethoxyhexane from methanol, butylacetylene, and mercuric oxide.

H₄BF₃O₂ — Hydronium Monohydroxyfluoborate, (H₃O)⁺(BOHF₃)⁻. This empirical formula may be rewritten as BF₃·2H₂O. In the older literature the acid H₂B₂O₄·6HF is discussed. This acid may be considered as (BF₃·2H₂O)₂. Berzelius ^(66, 67, 69, 70) prepared what he called "boratofluoric acid," H₂B₂O₄·6Hf, by allowing hydrofluoric acid to react with boric acid. He reported that the acid distilled without decomposition and that on neutralization he was able to prepare monohydrated salts of the acid by replacing the hydrogen with the metallic atom. In the light of the more recent work ⁽⁵⁶⁵⁾ on the preparation of dihydroxyfluoboric acid by the distillation at 25 mm. of boron trifluoride dihydrate (*vide supra*), it appears that Berzelius probably did not obtain "boratofluoric acid." The product which he did obtain was decomposed by an excess of water into an aqueous solution of fluoboric acid, HBF₄, containing a precipitate of boric acid.

In 1874 Basarow ^(42, 43, 44, 45) postulated that the "boratofluoric acid" reported by Berzelius was actually a mixture of 1 mole of metaboric acid with 3 moles of hydrofluoric acid, HBO₂·3HF, which it will be noted may be written also as boron trifluoride dihydrate. Basarow supported his postulations by the distillation of "boratofluoric acid" in which he obtained several fractions. These fractions are briefly summarized in Table 32.

TABLE 32

Boiling Range of Fraction, °C.	Specific Gravity	Nature of Components Found in Fraction
140		BF ₃ evolved.
160-170	1.777	Fumes in moist air.
175-180	1.659	Fumes to lesser degree in air.
180-185	1.657	Fumes still less in air.
185-200	1.577	Fumes very little in air.

It appears that Basarow actually prepared dihydroxyfluoboric acid. McGrath, Stack, and McCusker⁽⁵⁶⁵⁾ prepared dihydroxyfluoboric acid by distillation of boron trifluoride dihydrate at 25 mm. (*see above*). It should be noted that dihydroxyfluoboric acid boils at 159-160°C., has a density at 25°C. of 1.6560, and also is decomposed by water. Basarow noted that all of the fractions except the one with the highest boiling temperature reacted with water with the precipitation of boric acid; Basarow also discovered that the presence of an excess of boric oxide during distillation raised the specific gravity of the product. Thus the specific gravity of the 180° to 185°C. fraction rose from 1.657 to 1.717.

McGrath, Stack, and McCusker⁽⁵⁶⁵⁾ prepared boron trifluoride dihydrate, BF₃·2H₂O, by passing 1 mole of boron trifluoride into 2 moles of water cooled in an ice bath. The product was fractionally distilled at pressures ranging from 1 to 100 mm., but a satisfactory product could not be obtained. It was found that the liquid boiled at 58.5 to 60°C. under a pressure of 1.2 mm. Therefore, melting points were taken on carefully prepared undistilled samples and were found to lie between 5.9 and 6.1°C. These samples have a density at 20°C. referred to water at 4°C. of 1.6315 and 25°C. of 1.6252.⁽⁵⁶⁵⁾ The specific conductance at 25°C. is 105.0×10^{-3} mhos.⁽⁴⁵⁸⁾

Inasmuch as the samples were not distilled, the samples were purified by fractional freezing. That the melting point was a maximum was demonstrated also by adding small quantities of boron trifluoride and water to the samples and then determining the melting points of the resulting solutions.⁽⁵⁶⁵⁾

Boron trifluoride dihydrate is a nonfuming liquid which showed no attack on glass nor any change in melting point after one year

at room temperature. It is not very soluble in benzene but is soluble in donor solvents. It is extensively dissociated in a dilute dioxane solution indicating that, in the liquid state, it is dissociated into an equilibrium mixture of hydroxyfluoboric acids.⁽⁶⁶⁵⁾

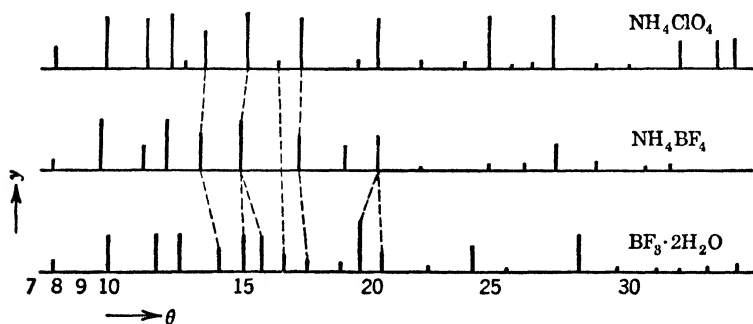

FIG. 5-5. Schematic X-ray diagrams of NH_4ClO_4 , NH_4BF_4 and $\text{BF}_3 \cdot 2\text{H}_2\text{O}$

TABLE 33

ELECTRICAL PROPERTIES OF AQUEOUS SOLUTIONS OF $\text{BF}_3 \cdot \text{H}_2\text{O}$ AT 25°C .^(468a)

% Water by Weight	Resist- ance in Ohms	Sp. Cond. $K. \times 10^3$	Sp. Gr.	Conc. $M/1$	Equiv. Cond.	\sqrt{c}	Mole %
0	5.626	41.8 ⁶	1.760	20.50	2.04	4.52	
3.85	4.104	57.3 ⁸	1.729	19.37	2.96	4.39	
6.65	3.463	68.0 ¹	1.706	18.55	3.67	4.31	
9.90	2.966	79.4 ⁹	1.678	17.62	4.51	4.19	
13.0 ³	2.620	89.8 ⁹	1.651	16.71	5.39	4.08	
15.5 ⁴	2.407	97.8 ⁴	1.627	16.01	6.11	4.00	
17.2 ⁴	2.280	103.3	1.610	15.52	6.65	3.93	
21.4 ⁷	1.973	119.4	1.567	14.34	8.32	3.78	
24.0 ³	1.793	131.3	1.542	13.65	9.61	3.69	
26.1 ⁹	1.627	144.7	1.520	13.05	11.09	3.61	
28.0 ⁹	1.492	157.8	1.500	12.57	12.56	3.54	
29.8 ⁸	1.366	172.4	1.482	12.11	14.24	3.48	33.0
31.6 ²	1.257	187.4	1.464	11.66	16.07	3.41	31.4
32.5 ³	1.173	200.8	1.455	11.44	17.56	3.38	30.4
78.7 ⁶	0.549	429.0	1.103 ²	2.72 ⁹	157.2	1.65 ³	5.4
80.31	0.571	412.4	1.095 ²	2.50 ⁴	164.7	1.59 ³	4.9
84.6 ⁷	0.653	360.6	1.074 ²	1.92	187.8	1.38 ⁵	3.7
89.9 ¹	0.892	264.0	1.049 ²	1.23 ¹	214.5	1.10 ⁰	2.3
94.9 ¹	1.616	145.7	1.024 ²	0.59 ⁷	244.1	0.73 ³	1.1

Klinkenberg and Ketelaar⁽⁴⁶⁰⁾ consider boron trifluoride dihydrate as the hydronium salt of monohydroxyfluoboric acid, $(\text{H}_3\text{O})^+(\text{BOHF}_3)^-$, owing to the fact that the volumes of a fluoride and hydroxyl ion are almost equal. They have found

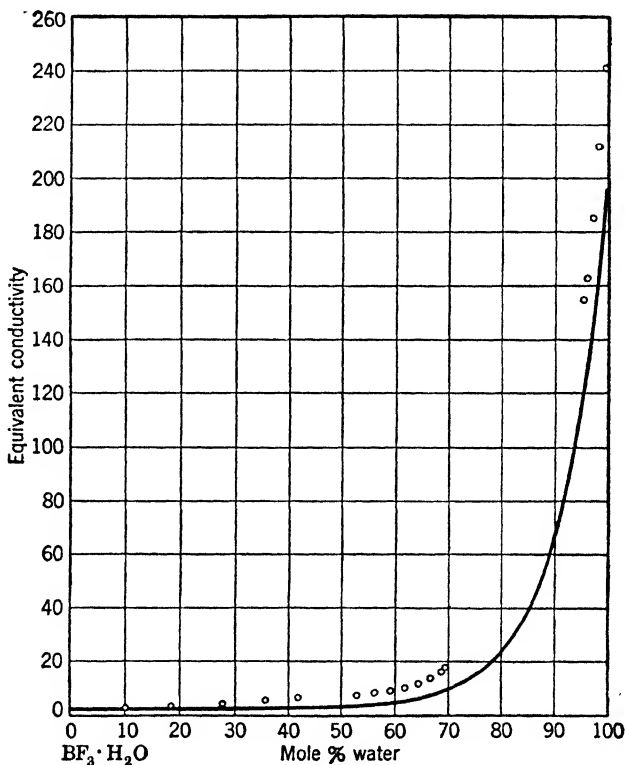

FIG. 5-6. Equivalent conductivity of aqueous solutions of $\text{BF}_3 \cdot \text{H}_2\text{O}$ (o) and sulfuric acid—solid line

the length of the crystalline axis to be: $a = 8.74 \pm 0.06$, $b = 5.64 \pm 0.03$, and $c = 7.30 \pm 0.10 \text{ \AA}$. The ratio of these axes is $a:b:c = 1.55:1:1.30$. They have reported the density to be 1.91. The crystalline structure is similar to that of ammonium fluoborate and ammonium perchlorate (see Figure 5-5).

Electrical properties of aqueous solutions of $\text{BF}_3 \cdot \text{H}_2\text{O}$, undoubtedly containing hydronium monohydroxyfluoborate in dilute solution, are shown in Table 33 and in Figure 5-6. Apparently this acid is about as strong as sulfuric acid.^(458a)

Additional evidence, indicating that Berzelius probably had some other product when he thought he had boratofluoric acid, is obtained from the salts which he claimed to have prepared by neutralization with an alkali. He regarded these salts as borato-fluorides, $M_2B_2O_4 \cdot 6MF \cdot H_2O$. However, upon recrystallization he obtained four fractions, the first of which was an alkali fluoride and the remaining three consisted of mixtures of an alkali fluoride and fluoborate. Silver nitrate solution with boratofluoric acid gave a precipitate consisting of silver metaborate and oxide.^(43, 45)

Abegg, Fox, and Herz⁽¹⁾ came to no definite conclusions in their study of the reactions which occur between boric acid and hydrofluoric acid and between boric acid and potassium fluoride. In their investigation they studied such phenomena as the partition coefficients, freezing points of various solutions, and electric conductivity.

Berzelius prepared what he called sodium boratofluoride, $(NaO)_2 \cdot BF \cdot 2NaF \cdot 4H_2O$, or $F \cdot B : (ONa)_2 \cdot 2NaF \cdot 4H_2O$, which could be considered as a tetrahydrate derivative of the acid $H_4BF_3O_2$. The substance resulted when he evaporated a boiling aqueous solution containing 1 mole of sodium metaborate and 3 moles of sodium fluoride. From a boiling solution containing 1 mole of boric acid and 3 moles of sodium fluoride he obtained a substance which he considered to be $NaO \cdot OH \cdot BF \cdot 2NaF$. In a similar manner Berzelius prepared also the potassium salts. Basarow (*see above*) rightly considered these substances as mixtures. According to McGrath, Stack, and McCusker⁽⁵⁶⁵⁾ salts of boron trifluoride dihydrate have not been prepared.

Recently, however, by dissolving 1.5–2.0 moles of potassium bifluoride and 1 mole of orthoboric acid in 250–300 g. of water and cooling and filtering, Ryss has obtained a yield of 57% of a white powder which he claims is potassium monohydroxyfluoborate.^(767a) He reports that this salt has a solubility of 11% in water at 14°C. The resulting solution is acid, and, with methyl orange as indicator, 1 mole reacts with 2.03 moles of sodium hydroxide.

Independently, Wamser^(935a) prepared the same salt, KBF_3OH , by the same reaction:



and concludes that this salt, KBF_3OH , is what Travers and Malaprade⁽⁹⁰²⁾ reported as $K_2B_2F_6 \cdot 1.5H_2O$. The acid, HBF_3OH , is

thought to be the first hydrolysis product of fluoboric acid, amounting to 5.5% in 5.41 *M* fluoboric acid and 46.3% in 0.00509 *M* fluoboric acid. The monohydroxyfluoboric acid is the chief product first formed when 1 mole of boric acid reacts with 4 moles of hydrofluoric acid; the monohydroxyfluoboric acid is then slowly converted to fluoboric acid.

The $[BF_3OH]^-$ ion gives no precipitate with nitron acetate whereas the $[BF_4]^-$ ion does. By the addition of $(C_2H_5)_2O \cdot BF_3$ in ether to a suspension of either NaOH or KOH in ether the compounds $NaBF_3OH$ and KBF_3OH have also been prepared.^(458a, 589) See Chapter 4 for further details.

Boron trifluoride dihydrate (hydronium monohydroxyfluoborate) has found use as a catalyst. As an example: Axe⁽²³⁾ found that aromatic compounds can be alkenylated with *n*-1,3-diolefins at 80–120°F. at lowest pressure needed to keep reactants liquid in 5 to 20 minutes with the aid of $BF_3 \cdot 2H_2O$ as catalyst. It has the advantage over H_2SO_4 that it does not polymerize diolefins under these conditions.

Polymers of the lubricating-oil range from gaseous olefins have been made by the use of $BF_3 \cdot 2H_2O$ as catalyst.⁽⁸⁴⁸⁾ The monohydrate and trihydrate of boron trifluoride are considered also in the chapter dealing with the coordination compounds of boron trifluoride.

$H_4BF_3O_3$. Gasselin⁽²⁸⁵⁾ reported that the alleged acid, $H_4BF_3O_3$ or $HBO_3 \cdot 3HF$, is obtained when boron trifluoride is absorbed by alcohol. The acid has a specific gravity of 1.1574 and boils at 92°C. under a pressure of 30 mm. of mercury. Gasselin^(282, 285) concluded that this so-called acid was actually a mixture of hydrofluoric, fluoboric, and boric acids which resulted from the hydrolysis of the boron trifluoride. By neutralizing this solution with sodium and potassium alkalis, he obtained the sodium and potassium salts of these three acids.

$H_4B_4F_4O_{11}$. This acid, fluoperboric acid, has not been prepared, but some complex salts of the acid, the fluoperborates, have been reported. Melikoff and Lordkipanidze^(593, 595) and Petrenko⁽⁷⁰⁴⁾ prepared these salts by treating fluoborates with solutions of hydrogen peroxide. Potassium fluoperborate monohydrate, $K_4B_4F_4O_{11} \cdot H_2O$, was prepared by Melikoff and Lordkipanidze^(593, 595) by allowing a slightly alkaline solution of hydrogen peroxide to react with an aqueous solution of the potassium salt, $(KF)_2 \cdot B_2O_3$.

A viscous mass separates from solution when alcohol is added, and upon stirring the mass becomes crystalline. Rhombic prisms are obtained upon recrystallization from water. The salt is prepared also by treating potassium orthofluoborate, $(\text{KO})_2\text{BF}$, with hydrogen peroxide. The structural formula assigned to the compound by the authors is $(\text{KO}-\text{O}-\text{BF}-\text{O})_2 \cdot (\text{KO}-\text{O}-\text{BF}-\text{O}-\text{O}-\text{BF}-\text{O}-\text{K}) \cdot (\text{H}_2\text{O})$.

In water, potassium fluoperborate monohydrate hydrolyzes to produce an alkaline solution with the evolution of oxygen. This reaction proceeds slowly at room temperature but is accelerated by heating.

Dry potassium fluoperborate monohydrate is fairly stable. When treated with dilute sulfuric acid, it is decomposed with evolution of hydrogen peroxide. Concentrated sulfuric acid liberated "ozonized" oxygen.

Silver fluoperborate is formed as a yellow precipitate upon the addition of a solution of silver nitrate to an aqueous solution of potassium fluoperborate. It is unstable and like many other silver salts is decomposed by light with the liberation of free silver and oxygen. Because of this reaction the yellow salt turns black.

$\text{H}_6\text{B}_2\text{F}_2\text{O}_9$. Landolph⁽⁴⁸¹⁾ passed boron trifluoride into anethol and obtained a liquid boiling at 130°C .; its composition he reported to be $\text{H}_4\text{B}_2\text{O}_9 \cdot 2\text{HF}$. Upon the addition of water this liquid was decomposed with the precipitation of boric acid. This work has not been confirmed, and the salts of this alleged acid are not known.⁽⁶³⁵⁾

$\text{H}_7\text{B}_2\text{F}_3\text{O}_7$. In a study of the properties of boron trifluoride, Landolph⁽⁴⁸¹⁾ absorbed boron trifluoride in liquid amylene and obtained a clear yellow liquid which boiled at 160°C . and which had a composition represented by $\text{H}_4\text{B}_2\text{O}_7 \cdot 3\text{HF}$. This liquid was decomposed by water with the precipitation of boric acid. This research has not been confirmed, and salts of this substance have not been isolated.⁽⁶³⁵⁾

$\text{H}_{14}\text{B}_4\text{F}_{12}\text{O}_7$. This acid is not known, but Berzelius prepared what might be considered the sodium salt by allowing 1 mole of borax to react with 6 moles of sodium fluoride. The composition of the salt he represented as being $\text{Na}_2\text{O} \cdot 2\text{B}_2\text{O}_3 \cdot 12\text{NaF} \cdot 22\text{H}_2\text{O}$ which might also be represented as $(\text{Na}_2\text{O})_7 \cdot (\text{BF}_3)_4 \cdot (\text{H}_2\text{O})_{22}$.

$\text{Na}_2[\text{O}(\text{BF}_3)_4]$. Swinehart^(882, 883) has postulated that the product of the reaction of borax and aqueous hydrofluoric acid after drying has the structure,

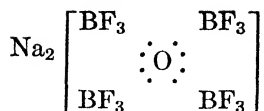

which corresponds to the analysis of the product. This is structurally possible.

SUMMARY

In Chapter 4 it was suggested that the hydrates of boron trifluoride and their derivatives all seem to conform to the structure $[\text{M}^+]^+[\text{BF}_x\text{Q}_{4-x}]^-$. It appears that all the various fluoborates containing 1 boron atom described in this chapter and in Chapter 4 may be referred to this structure.

It has been shown that $[\text{M}^+]^+$ besides being a metal may be:

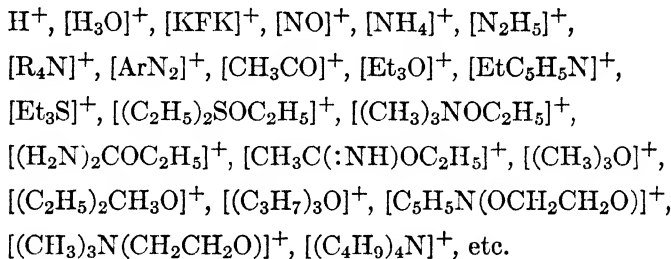

On the other hand Q of the fluoborate anion has been limited to the groups, OH, OCH_3 , OC_2H_5 , $\text{OC}_2\text{H}_4\text{OH}$, CH_3COO , HCOO , and C_6H_5 . Undoubtedly fluoborates with other substituting groups will be discovered. Theoretically the F atoms in $[\text{BF}_4]^-$ may be serially all replaced with OH or OR, etc., but difficulties of synthesis have severely limited the number of derivatives. Where OH replaces F the anions given here in solid brackets have been reported

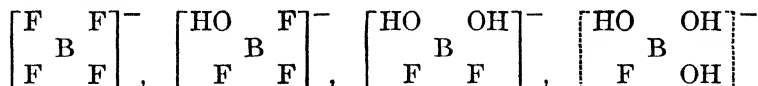

Dehydration of the last undiscovered acid $\text{H}[\text{BF}(\text{OH})_3]$ would theoretically yield the oxyfluoride $(\text{BOF})_3$.⁽⁵¹⁾ If so, reaction of the oxyfluoride with a solution of sodium or potassium hydroxide in 50% ethanol might yield an alkali metal salt of this undiscovered acid. The polyfluoboric acids need considerably more study before we may accept them unreservedly.

6

Boron Trifluoride and Its Derivatives as Catalysts

Boron trifluoride has been developed commercially because of the demand for its use as a catalyst. It has been found to be effective as a catalyst for many different types of organic reactions, most common of which are alkylation, polymerization, and isomerization. That these reactions proceed smoothly is due in all probability to the small atomic volume and strong electrophilic character of boron trifluoride which permits stable coordination compounds to form. An advantage of the use of boron trifluoride as a catalyst is the fact that tarry and undesirable by-products are usually not obtained.^(447a)

THEORETICAL CONSIDERATIONS

In general, the theories for the behavior of boron trifluoride as a catalyst are based on the electrophilic character of this molecule. As a consequence of its behavior as an acid,* it is assumed to react with an organic molecule (behaving as a base) to synthesize a coordination compound. The molecular compound is then assumed to ionize in such a manner that the acidity of the medium is increased. The organic molecule then reacts to form the desired product with the regeneration of a coordination compound of boron trifluoride. The mechanism of these reactions may be illustrated in the alkylation of benzene.

* The terms "acid" and "base" are used here as given by G. N. Lewis, in which an acid is capable of accepting a share in a lone electron pair from a donor atom acting as a base to form a coordinate covalent bond.

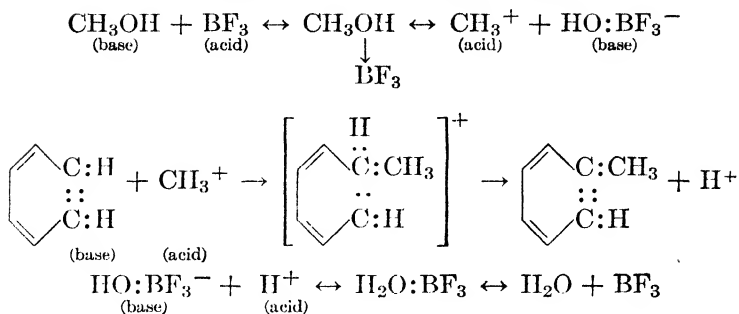

There are numerous examples in the literature in which water or hydrogen fluoride is added with the boron trifluoride to assist in the catalysis. This in all probability is due to the formation of the following compounds which in turn liberate solvated protons as shown:

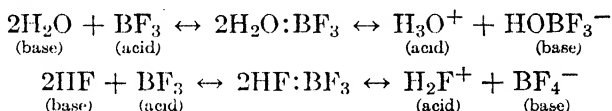

As is shown later, sulfuric acid has frequently been used with boron trifluoride to catalyze various types of organic reactions. It has been suggested^(561a) that sulfonation reactions proceed owing to the fact that the boron trifluoride removes water from sulfuric acid, giving rise to sulfur trioxide which may then behave as an acid catalyst or as a sulfonating agent. Inasmuch as sulfur trioxide is a stronger acid than boron trifluoride as indicated by the stability of their coordination compounds with water (H_2SO_4 and HBF_3OH), it does not seem likely that the boron trifluoride would be able to attract the water once it was associated with the sulfur trioxide. Perhaps a better explanation could be made on the assumption that the sulfuric acid furnishes protons which promote the organic reaction in which water is formed as a product. Boron trifluoride could then shift the equilibria toward an increased yield of the desired product by forming a coordination compound with the water thus liberated.

However, inasmuch as there is evidence to indicate that a coordination compound is formed by sulfuric acid and boron trifluoride,⁽¹²⁸⁾ it appears that the best explanation of the catalysis with boron trifluoride supported by sulfuric acid would be to assume the formation of this coordination compound which in

turn would furnish protons to the medium and thus catalyze the reaction. Thus:

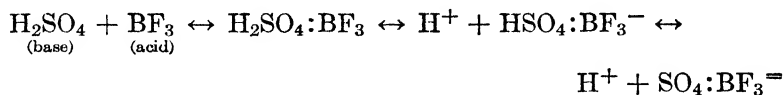

Phosphoric acids and phosphorus pentoxide have been used also with boron trifluoride as a catalyst, and inasmuch as these molecules also coordinate with boron trifluoride the same theory would be valid. Hydrogen ions would be liberated in the following manner:

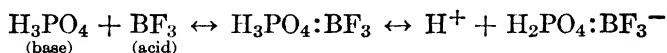

Dihydroxyfluoboric acid functions as a catalyst in many organic reactions that are catalyzed by boron trifluoride, but it is a milder catalyst. Under certain conditions, dihydroxyfluoboric acid gives rise to boron trifluoride but it is not dependent on boron trifluoride for its catalytic activity in all cases.^(137, 330) It is claimed to give better control of some reactions than can be obtained with boron trifluoride.⁽⁴⁶²⁾ The catalytic behavior of dihydroxyfluoboric acid may be explained in the same manner as was postulated for the other catalysts above, thus:

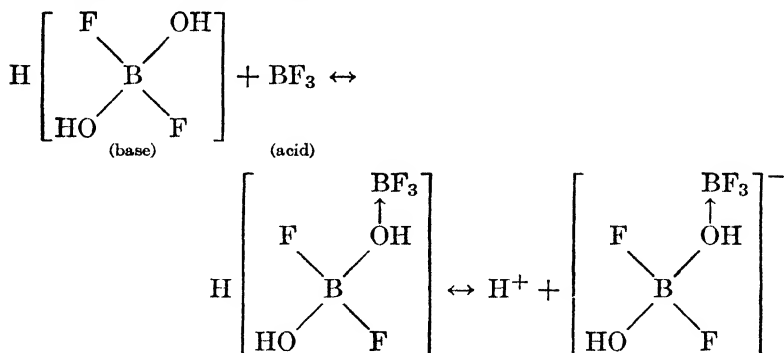

Like many of the other coordination compounds of boron trifluoride, dihydroxyfluoboric acid boron trifluoride decomposes on heating to evolve boron trifluoride.⁽⁴⁵⁹⁾

Many compounds have in common the ability to catalyze Friedel-Crafts reactions, the polymerization of olefins, the condensation of olefins with aromatic compounds, and the *cis-trans* isomerization of olefins. It has been suggested that the common

factor in all these reactions is the electron-deficient nature of the catalyst and that such a catalyst may associate with the electrons of the carbon-to-carbon double bond to give an active intermediate, common to each reaction. With boron trifluoride this would involve the formation of a coordination compound as the intermediate which would react then to form the desired product and liberate the boron trifluoride.^(491, 493) The mechanism of such a reaction may be represented as follows:

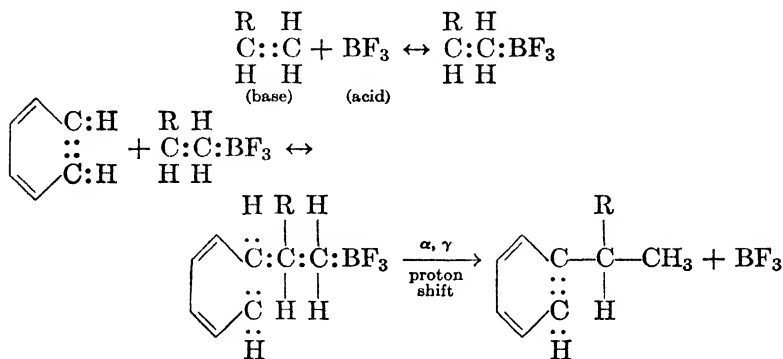

Similarly, anils are thought to coordinate with boron trifluoride, and as a result the double bond between the nitrogen and the carbon atoms must become highly polarized. Consequently, the anil complexes with boron trifluoride react in addition reactions more readily than the anils alone.⁽⁵⁵³⁾ This type of reaction may be illustrated by the addition of a methyl ketone to an anil. This reaction may be represented to take place in the following steps:

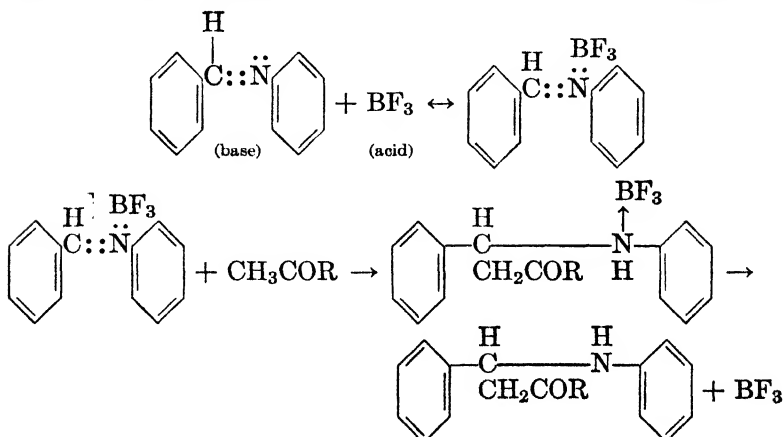

Several reviews have been written regarding the role played by boron trifluoride in organic chemistry.^(42, 203, 232, 310, 358, 447a, 561a)

PREPARATION OF BORON TRIFLUORIDE CATALYSTS

Boron trifluoride is used alone, or in a coordination compound, in catalytic reactions, depending on the type of reaction and the products desired. Only the more common coordination compound catalysts will be discussed. The preparation of the other coordination compounds may be obtained by consulting the references listed with the specific compounds in Chapter 4. Boron trifluoride is used sometimes with promoters such as metallic nickel,^(429, 436) nickel oxide,^(224, 427) or zirconium oxide,⁽¹⁹³⁾ and oxygen compounds of aluminum, silicon, titanium, vanadium, chromium, manganese, iron, cobalt, and nickel, including aluminum silicates.⁽¹⁶²⁾

Frequently boron trifluoride is used as a catalyst in the presence of water because it will not catalyze a reaction dry.^(252, 253) A liquid catalyst is prepared by saturating water with gaseous boron trifluoride at 38 to 49°C. until the molar ratio of water to boron trifluoride is one to one.⁽¹⁹⁾ Hydrated boron trifluoride is prepared by the reaction of liquid hydrogen fluoride on boric acid, anhydride, or a borate, at a temperature below 10°C., optionally in the presence of a mineral acid, such as sulfuric acid.^(222, 563) By adjusting the proportions, either the di- or trihydrate may be obtained.

Dihydroxyfluoboric acid is prepared by the reaction of boron trifluoride on boric acid or of anhydrous hydrogen fluoride on boric anhydride with subsequent heating of the reaction mixture to above the boiling point of dihydroxyfluoboric acid at the pressure used.^(666, 826) The dihydroxyfluoboric acid coordinates with 1 mole of boron trifluoride to form an excellent catalyst.⁽⁶⁶⁶⁾ With silica gel, coke, or activated carbon as supporters, dihydroxyfluoboric acid serves very well.⁽²²⁴⁾ A catalyst consisting of a mercuric salt of dihydroxyfluoboric acid is prepared by dissolving mercuric oxide in the acid or in its addition compound with boron trifluoride.⁽²²⁹⁾

A 95% yield of $(\text{CH}_3)_2\text{O}\cdot\text{BF}_3$ is obtained by passing boron trifluoride into methyl alcohol at such a rate that a slow reflux ratio is maintained.⁽⁴⁶²⁾ Other ether complexes are made similarly.

Frequently boron trifluoride is used catalytically in the presence of anhydrous hydrogen fluoride. Such a catalyst is produced by the action of anhydrous hydrogen fluoride on boric acid. A coordination compound such as H^+BF_4^- is presumed to result.^(23c) Other acids are used sometimes with boron trifluoride in catalysis, such as molecular compounds of BF_3 and H_3PO_4 or $\text{H}_4\text{P}_2\text{O}_7$ at an elevated temperature.^(24a, 262, 409, 419c, 783, 787a) Fluosulfonic acid has also been used as a promoter.^(433b)

Catalysts for some condensation reactions in the preparation of acetals and ketals are prepared by using boron trifluoride and mercuric oxide as the chief constituents. Boron trifluoride is absorbed in alcohol, and red mercuric oxide is added.^(180, 670, 916) Another characteristic preparation of such a catalyst is to heat together for a short time red mercuric oxide, $(\text{C}_2\text{H}_5)_2\text{O}\cdot\text{BF}_3$, and methyl alcohol.⁽⁴⁵⁴⁾ Sometimes a substance such as trichloroacetic acid is added.⁽³⁶⁰⁾

In the preparation of synthetic resins a useful catalyst is the reaction product of boron trifluoride on an organic acid. Such acids as acetatofluoboric, chloracetatofluoboric, lactatofluoboric, oleatofluoboric, and benzoatofluoboric are useful catalysts.⁽³³⁶⁾

TYPES OF ORGANIC REACTIONS CATALYZED BY BORON TRIFLUORIDE

SYNTHESIS

Saturated Hydrocarbons. Boron trifluoride was found not to react with methane.⁽²⁸²⁾ Boron trifluoride catalyzes the alkylation of paraffinic hydrocarbons with saturated hydrocarbons.^(177, 191, 192)

Propane is converted to isobutane at 25–200°C. and under a pressure of 50 to 550 pounds per square inch, liquid HF and BF_3 being used as the catalyst.^(152, 807)

Liquid HF and BF_3 catalyze the formation of hydrocarbons of intermediate molecular weight at 5 to 500 pounds per square inch from propane and pentane,⁽¹⁵⁵⁾ from butane,⁽¹⁵⁷⁾ and from hexanes and isopentane.⁽¹⁵⁴⁾ Paraffinic hydrocarbons of relatively high molecular weight, such as dodecane, react in similar manner with isobutane to produce a product of intermediate molecular weight, octane.⁽³²²⁾ Boron trifluoride has been used with $\text{Al}_2\text{O}_3\cdot\text{SiO}_2$ as a catalyst for the production of gasoline from gas oil.^(719a)

Boron trifluoride is a catalyst for the condensation of oils with long chain-halogenated paraffinic compounds to produce lubricating oils.⁽⁸⁵⁰⁾

Naphthalene, anthracene, phenanthrene, and similar compounds undergo condensation reactions in an environment of coordination compounds of boron trifluoride.^(415, 589)

Ring closure to produce indene derivatives can be achieved by passing boron trifluoride catalysts into 2,3, bis-(*p*-hydroxyphenyl)-butadiene.⁽⁵⁾

Olefins. Conjugated diolefins are obtained by allowing tertiary olefins, alcohols, or halides to condense with aldehydes, thioaldehydes, formals, acetals, or ketones in the presence of 25 to 125 moles of water per mole of boron trifluoride at 75 to 200°C. Sulfuric, hydrofluoric, hydrochloric, or phosphoric acids may be used as promoters. With 9 to 25 moles of water per mole of boron trifluoride at 10 to 75°C., *m*-dioxanes are obtained.⁽⁷³⁴⁾

By treatment of saturated linear polymers of unsaturated hydrocarbons, with a halogen at 0 to 80°C. in the presence of boron trifluoride, all the added halogen is eliminated as a halogen acid, leaving an unsaturated polymer.⁽⁷⁹⁶⁾

Disubstituted alkoxystilbenes of predominantly *trans* form are obtained from compounds of the general formula *p*-ROC₆H₄CHR'/CH(OH)C₆H₄OR-*p*, in which R is an alkyl, aliphatic carboxylic, acyl, or aracyl radical and R' is an alkyl radical, in the presence of BF₃ or one of its reactive complexes. The reaction is allowed to proceed in a solvent such as carbon tetrachloride at a temperature between 10 and 30°C. Typical reactants are 3,4-bis-(*p*-methoxyphenyl)-3-hexanol, *cis*-4,4'-dimethoxy- α,β -diethylstilbene, 3,4-bis-(*p*-acetoxypheyl)-3-hexanol and 3,4-bis-(*p*-benzoyloxyphenyl)-3-hexanol. Under the conditions outlined previously the following *trans* compounds have been synthesized: 4,4'-dimethoxy- α,β -diethylstilbene, 4,4'-diacetoxy- α,β -diethylstilbene, 4,4'-dibenzoyloxy- α,β -diethylstilbene, 4,4'-dimethoxy- α,β -dimethylstilbene, 4,4'-dimethoxy- α,β -dimethylstilbene, 4,4'-dimethoxy- α -ethyl- β -methylstilbene, and 4,4'-dimethoxy- α,β -dibutylstilbene.⁽⁷³²⁾

Alcohols. By varying the conditions of temperature, time, and catalyst concentration for the reactions mentioned for the preparation of olefins, 1,3-dihydric alcohols may be obtained also. The diol products boil above 200°C.⁽⁷³⁴⁾

Olefins are converted to alcohols at high temperatures and

pressures by allowing the olefin to react with water vapor.⁽⁵³⁹⁾ Boron trifluoride or the acid resulting from the reaction of HF on H_3BO_3 supported on silica gel, coke, or active carbon are suitable catalysts. Promoters such as nickel, nickel oxide, or mercuric oxide may be used.⁽²²⁴⁾

Aromatic hydrocarbons react with alkylene oxides (for example, ethylene, propylene, or butylene oxides) in the presence of boron trifluoride to form the corresponding alcohols.^(407a)

Mercaptans. Branched-chain alkyl mercaptans of high molecular weight result from the reaction of an olefin with hydrogen sulfide in the presence of boron trifluoride. Thus, diisobutylene was converted into $Me_3CCH_2C(Me)_2SH$ in 81–85% yield.⁽²³⁶⁾ Boron trifluoride complexes, with water,^(787b) and with an oxy acid of phosphorus^(787a) have been patented as improved catalysts for this general purpose.

The reaction between a mercaptan and dicyclopentadiene using $BF_3 \cdot Et_2O$ as catalyst yields a sulfide of the structure $A-S-R$ where R refers to the "dihydronordicyclopentadienyl" radical and A is an alkyl or aryl group. Tricyclopentadiene reacts similarly. In the case of certain mercaptans which possess weakly acidic properties, acidic catalysts accelerate the reaction.⁽¹³⁸⁾

Ketones. Amylacetylene reacts with acetic acid and its anhydride, thus producing amyl methyl ketone. $(C_2H_5)_2O \cdot BF_3$ with red mercuric oxide serves as a catalyst. By an analogous reaction, amylacetylene reacts with ethylene glycol to yield 1-methyl-1-amylidioxole.⁽³⁵⁸⁾ When vinylacetylene is passed into acetic acid containing 5–10% of $(C_2H_5)_2O \cdot BF_3$ with red mercuric oxide along with 5% acetic anhydride present as activator at a temperature below 14°C., tetrahydroacetoxyacetophenone is produced.⁽⁴⁵⁶⁾ Vinylacetylene and acetic acid in the presence of boron trifluoride and red mercuric oxide at temperatures slightly above room temperature react to give an 80% yield of amyl methyl ketone along with acetic anhydride.^(419a)

When 2,5-dimethyl-3-hexyne-2,5-diol is allowed to react with either methanol or acetic acid, in the presence of a catalyst consisting of boron trifluoride etherate, red mercuric oxide and trichloroacetic acid, the triple bond is hydrated and the compound cyclized to form 2,2,5,5-tetramethyltetrahydro-3-furanone.^(276a)

Acetic acid and phenol react in the presence of boron trifluoride to form *p*-hydroxyacetophenone. Ethyl acetate forms the same

TABLE 34

REACTIONS OF ALIPHATIC ACID ANHYDRIDES TO GIVE KETONES

Reactant + Acetic Anhydride	Ketone Product	Reference
Acetone	Acetylacetone	205, 590
Methyl ethyl ketone	Methylacetylacetone	3, 342
Methyl <i>n</i> -propyl ketone	Ethylacetylacetone and <i>n</i> -butyrylacetone	342
Methyl <i>i</i> -propyl ketone	Dimethylacetylacetone and <i>i</i> -butyrylacetone	342
Methyl <i>i</i> -butyl ketone	<i>i</i> -Valerylacetone and <i>i</i> -propylacetylacetone	3, 342
Methyl <i>t</i> -butyl ketone	Pivaloylacetone	3
Methyl <i>n</i> -amyl ketone	<i>n</i> -Butylacetylacetone and <i>n</i> -hexoylacetone	3, 342
Methyl <i>n</i> -hexyl ketone	<i>n</i> -Amylacetylacetone and <i>n</i> -heptylacetone	342
2-Methylcyclohexanone	2-Methyl-6-acetylcyclohexanone and 2-methyl-2-acetylcyclohexanone	342
Diethyl ketone	3-Methyl-2,4-diketohexane	590
Diisobutyl ketone	Isopropylisobutyrylacetone	3
Cyclohexene	2-Acetylcyclohexene-1	590
Cyclohexanone	2-Acetylcyclohexanone	3, 584, 590
Benzene	Acetophenone	590
Methyl benzyl ketone	3-Phenylacetylacetone	3
Toluene	<i>p</i> -Methylacetophenone	584, 590
Phenol	<i>p</i> -Hydroxyacetophenone	584
Anisole	<i>p</i> -Methoxyacetophenone	584
Acetophenone	Benzoylacetone	3, 584, 590
Benzalacetone	ω -Benzalacetylacetone	584, 590
1-Keto-1,2,3,4-tetrahydronaphthalene	2-Acetyl-1-keto-1,2,3,4-tetrahydronaphthalene	590
Reactant + Propionic Anhydride		
Acetone	Propionylacetone	3
Methyl ethyl ketone	Methylpropionylacetone	
Methyl isobutyl ketone	Propionylisovalerylmethane and isopropylpropionylacetone	
Methyl <i>n</i> -amyl ketone	<i>n</i> -Butylpropionylacetone and propionyl- <i>n</i> -hexoylmethane	
Cyclohexanone	2-Propionylcyclohexanone	
Acetophenone	ω -Propionylacetophenone	
Acetone	Butyrylacetone	
Methyl ethyl ketone	Methylbutyrylacetone	
Methyl isobutyl ketone	Butyrylisovalerylmethane and isopropylbutyrylacetone	
Methyl <i>n</i> -amyl ketone	<i>n</i> -Butylbutyrylacetone and butyryl- <i>n</i> -hexoylmethane	
Diethyl ketone	Methylpropionylbutyrylmethane	
Cyclohexanone	2-Butyrylcyclohexanone	
Acetophenone	ω -Butyrylacetophenone	
Methyl <i>n</i> -amyl ketone + isobutyric anhydride	<i>n</i> -Butylisobutyrylacetone	
Methyl ethyl ketone + <i>n</i> -caproic anhydride	Methylcaproylacetone	

product.⁽⁵⁸⁴⁾ Acid anhydrides react with boron trifluoride to form coordination compounds (Chapter 4). These coordination compounds when heated with water give the corresponding β -diketones along with some monoketone. Acetic, propionic, butyric, and isobutyric acid anhydrides react in this manner.^(584, 590)

Aliphatic acid anhydrides have been reported to react in the presence of boron trifluoride to produce ketones and β -diketones, as indicated in Table 34.

Ruzicka *et al.* and Shoppee *et al.* have studied the preparation of ketone derivatives of certain steroids using boron trifluoride etherate with mercuric oxide as the catalyst. This work is summarized in Table 35.

TABLE 35

Acetic Acid and Acetic Anhydride plus:	Product	Reference
17-Ethinyl-3- <i>trans</i> -17- α -dihydroxyandrostano-3-acetate	Diacetate of 17-ethinyl-3- <i>trans</i> -17- α -dihydroxyandrostano-3-acetate	765a, 765b
17-Ethinyl-3- <i>trans</i> -17- α -diacetoxyandrostane	Diacetate of 17-ethinyl-3- <i>trans</i> -17- α -diacetoxyandrostane	765a, 765b
3- β -Acetoxy-17- α -hydroxy-20-pregnynone	3- β -17- α -Diacetoxy-20-pregnane	797
3- β -Acetoxy-17- α -hydroxy-20-pregnynone	3- β -17- α,β -Diacetoxy-17- α -methyl-17- <i>D</i> -homoetiocholanone	797
3- β -17- α -Dihydroxy-20-pregnynone	3- β -17- α -Diacetoxy-20-pregnane	798
3- β -Acetoxy-17- α -hydroxyallo-20-pregnane	3- β -17- α,β -Diacetoxy-17- α -methyl- <i>D</i> -homo-17-androstanone	799
Δ^5 -17-Ethinyl-3- <i>trans</i> -17- α -dihydroxyandrostene	Δ^5 -3- <i>Trans</i> -17- α -diacetoxy-pregnene-20-one	765b, 765c
Δ^5 -17-Ethinyl-3- <i>trans</i> -acetoxy-17- α -hydroxyandrostene	Δ^5 -3- <i>Trans</i> -17- α -diacetoxy-pregnene-20-one	765b, 765c
Δ^5 -7-Ethinyl-3- <i>trans</i> -17- α -diacetoxyandrostene	3- β -17- α -Diacetoxypregnene-5-one-20	799
Δ^5 -17-Ethinyl-3- <i>trans</i> -17- α -dihydroxyandrostene-3-acetate-17-benzoate	Δ^5 -3- <i>Trans</i> -17- α -dihydroxy-pregnene-20-one-3-acetate-17-benzoate	765c
Δ^5 -17-Ethinylandrostenediol-3-acetate-17- α -stearate	Δ^5 -Pregnene-20-one-diol-3- β -acetate-17- α -stearate	334
3- β -Acetoxypregnadiene-5,16-ene-20	3- β -Acetoxypregnadiene-5,16-one-20	800
17-Ethinyltestosterone	17-Hydroxyprogesterone	765c
17-Ethinyltestosterone	Acetoxy diketone of 17-ethinyltestosterone	765b

Ethers. Ethers result from the hydration of olefins with water vapor at high temperatures and pressures.⁽⁵³⁹⁾ An acid resulting from the reaction of HF with H₃BO₃ supported on silica gel, coke, or active carbon, or boron trifluoride, may be used as a catalyst. Promoters such as nickel, nickel oxide, or mercuric oxide may be used.⁽²²⁴⁾

Ethers may be produced by the interaction of olefins and alcohols in the presence of boron trifluoride and hydrogen fluoride.⁽⁵¹²⁾ When ethyl ether-boron trifluoride catalyst was added to cooled mixtures of propylene and methanol, ethanol and propanol, the two possible monoethers were obtained.⁽⁷⁰⁶⁾

A tertiary olefin, C₂H(CH₃)₃, condenses with an aliphatic alcohol (methyl) in the presence of boron trifluoride, or of an organic complex thereof, with the formation of an ether.⁽⁷⁷⁶⁾

Tertiary olefins, alcohols, or halides condense with aldehydes, thioaldehydes, formals, acetals, or ketones in the presence of 9 to 25 moles of water to 1 mole of boron trifluoride at 10 to 75°C. to produce *m*-dioxanes. Sulfuric, hydrofluoric, hydrochloric, or phosphoric acids may be used as promoters. Thus:⁽⁷³⁴⁾

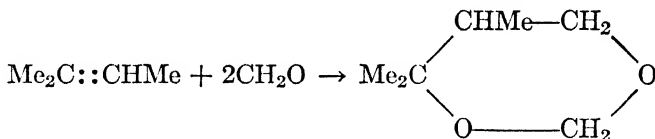

High-boiling formals are prepared by reacting a formalin solution with propylene in the presence of hydrated boron trifluoride.⁽⁵⁵²⁾

Another ethylene derivative, stilbene, reacts with mercuric acetate in methanol, in the presence of benzoyl peroxide or ascaridole to produce α -chloromercuri- β -methoxy- α,β -diphenylethane. The reaction is accelerated by the catalyst (C₂H₅)₂O·BF₃.⁽⁷⁷⁾

Cyclic oxides, such as ethylene oxide and propylene oxide, are reported to react with a fivefold excess of alcohols, for example, methyl or ethyl, in the presence of boron trifluoride to produce primary and secondary ethers.^(707a) Some polymerization of the cyclic oxide always takes place. With less alcohol, diethylene glycol-monoethyl ether forms. With aldehydes, the cyclic oxides produce dioxolanes.

Boron trifluoride catalyzes the formation of alkylene oxide addition products from the reaction of ethylene oxide or 1,2-propy-

lene oxide with themselves, the lower members of the alkylene glycol series, or the monosubstituted lower members of the alkylene glycol series which have only one free hydroxyl group in the molecule.⁽⁸⁹⁷⁾

One mole of epichlorohydrin reacts with 4 moles of various phenols dissolved in benzene at about 0°C. in the presence of boron trifluoride to produce γ -ethers having the empirical formula, $\text{ArOCH}_2\text{CH}(\text{OH})\text{CH}_2\text{Cl}$, in which Ar may be phenyl, *o*-, *m*-, or *p*-tolyl, thymyl, *o*-cyclohexylphenyl, or *p*-bromophenyl. It was observed that slightly higher yields are obtained if the quantity of phenol used is doubled. Use of boron trifluoride in excess reduced the yields, and boron trifluoride dihydrate halved the yields. Under similar conditions *o*-methoxyphenol gave only higher products and *o*-nitrophenol did not condense.^(501, 504, 864)

Epichlorohydrins condense with alcohols in the presence of an acidic boron trifluoride coordination compound to produce γ -ethers.⁽⁸⁶⁴⁾

With acetone, in the presence of $(\text{C}_2\text{H}_5)_2\text{O} \cdot \text{BF}_3$ catalyst, propylene oxide yields 2,2,4-trimethyl-1,3-dioxolane⁽⁷⁰⁷⁾; with methyl ethyl ketone, 2,4-dimethyl-2-ethyl-1,3-dioxolane is formed; and with methyl propyl ketone, 2,4-dimethyl-2-propyl-1,3-dioxolane. These dioxolanes readily hydrolyze to glycols and ketones on shaking with 5% sulfuric acid.

Below 40°C. cyclic oxides condense with ketones in the presence of boron trifluoride to produce cyclic acetals along with some polymerized products of the cyclic oxides.⁽⁷⁰⁵⁾

Isopropyl alcohol and dioxane on heating with boron trifluoride gives an 80% yield of the monoisopropyl ether of ethylene glycol.⁽⁸⁶⁰⁾

With ethyl alcohol and propylene oxide 0.1% of boron trifluoride gives 45% $\text{MeCH}(\text{OH})\text{CH}_2\text{OEt}$ and 29% $\text{MeCH}(\text{OEt})\text{CH}_2\text{OH}$. The reaction of isopropyl alcohol and propylene oxide in the presence of boron trifluoride was slow but gave 64% combined yield of ethers. With 2-ethyl hexyl alcohol and propylene oxide and the same catalyst a 70% yield of the combined ethers was obtained. It is stated that boron trifluoride is a better catalyst for these syntheses than sulfuric acid.⁽¹⁷⁵⁾

Ethylidene diacetate reacts with anisole to produce α, α -dianisylethane, using boron trifluoride as the catalyst.⁽⁵⁸⁴⁾

An ether, such as ethylene glycol propyl ether, is produced by condensing an alcohol (ethylene glycol), with an olefin such as

propylene, or a halogenated substituted olefin, at elevated temperature and pressure in contact with boron trifluoride plus metallic copper, nickel, or silver.⁽⁹²²⁾

In the presence of $2\text{H}_2\text{O}\cdot\text{BF}_3$ or $2\text{CH}_3\text{OH}\cdot\text{BF}_3$, propylene reacts to produce diisopropyl ether along with diisopropyl alcohol and methyl isopropyl ether, respectively. Ethylene is not absorbed under similar conditions.⁽⁵⁸⁹⁾

Propylene condenses with 1 mole of phenol in benzene in the presence of boron trifluoride to produce isopropyl phenyl ether. With 2 moles of propylene per mole of phenol, 2-isopropylphenyl isopropyl ether forms as the main product along with isopropyl phenyl and 2,4-diisopropylphenyl propyl ethers. In the absence of benzene, 1 mole of propylene condenses with 1 mole of phenol in the presence of boron trifluoride to yield *o*-isopropyl phenol, 2-isopropylphenyl isopropyl ether, 2,4,6-triisopropylphenyl isopropyl ether, and 2,4-diisopropylphenyl isopropyl ether.^(824, 825) Similarly, the following ethers are produced: 2-methylphenyl isopropyl; 2-methyl-4-isopropyl phenylisopropyl; 2-methyl-4,6-diisopropylphenyl isopropyl; 4-methylphenyl isopropyl; 4-methyl-2-isopropylphenyl isopropyl; 4-methyl-2,6-diisopropylphenyl isopropyl; 3-methylphenyl isopropyl; 3-methyl-6-isopropylphenyl isopropyl; 3-methyl-4,6-diisopropylphenyl isopropyl; methylphenyl; and 2-isopropylphenyl methyl.⁽⁸²⁵⁾

A mixture of 2-butene and phenol in the ratio 1.67:1 was agitated at -10°C . with 10% by weight of ethyl ether-boron trifluoride catalyst for 72 hours and gave an 81% yield of conversion products of which one third was of the alkylphenol type and two thirds was of the ether type. With 5% catalyst less alkylphenol and more of the ethers were produced.^(970b)

Amylene when mixed with phenol and $(\text{C}_2\text{H}_5)_2\text{O}\cdot\text{BF}_3$ in the cold and allowed to stand for 72 hours yields a *sec*-amyl phenyl ether with a trace of a *sec*-amyl *sec*-amylphenyl ether. The yield of this latter compound may be increased by heating the reactants to 52 to 53° for 26 hours.^(971a)

Diisobutylene reacts with acetic anhydride in the presence of boron trifluoride at $0-10^\circ\text{C}$., producing *tert*- $\text{C}_8\text{H}_{15}\text{COMe}$.⁽²³⁶⁾

Ethers of endoethylene-substituted cyclopentanol of the general formulas B or C are obtained when addition products of cyclopentadiene with monoolefinic compounds of the general formula A are allowed to react with alcohols in the presence of boron tri-

fluoride or its coordination compounds with ethers, esters, ketones, or acetic acid.^(137a) The reactions are summarized in Table 36.

TABLE 36

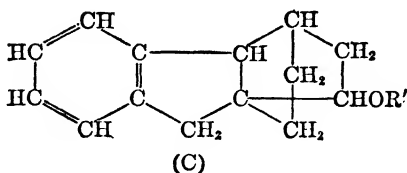
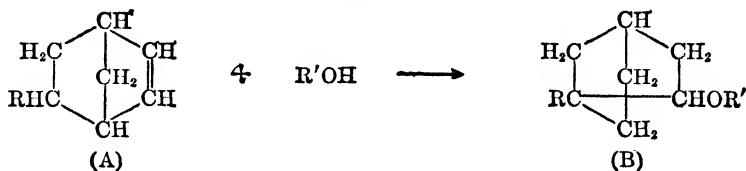

R	R'	Formula of Product	Ref.
PhOCH ₂	CH ₂ CH ₂ Cl	B	137a
Ph	Me	B	
Ph	CH ₂ CH ₂ Cl	B	
Ph	CH ₂ CH ₂ OH	B	
Ph	CH ₂ CH:CH ₂	B	
BzOCH ₂	CH ₂ CH ₂ Cl	B	
Ph	CH ₂ C(NO ₂)Me ₂	B	
Ph	CH ₂ CH ₂ OCH ₂ CH ₂ SCN	B	
<i>p</i> -Me ₃ CC ₆ H ₄ OCH ₂	CH ₂ CH ₂ Cl	B	
NCCH ₂ CH ₂ OCH ₂	CH ₂ CH ₂ Cl	B	
Ph	CHMeCO ₂ Et	B	
HOCH ₂ CH ₂ OCH ₂	CH ₂ CH ₂ Cl	B	
Ph	CH ₂ CH ₂ OCH ₂ CH ₂ Cl	B	
Ph	CH ₂ CH(OH)CH ₂ Cl	B	
Ph	CH ₂ CH ₂ OBu	B	
Ph	CH ₂ CH ₂ OCH ₂ CH ₂ OH	B	
3,4-CH ₂ O ₂ C ₆ H ₃ CH ₂	CH ₂ CH ₂ Cl	B	
AcO	CH ₂ CH ₂ Cl	B	
AcO	CH ₂ CH ₂ CN	C	
AcO	CH ₂ CH(OH)CH ₂ OH	C	
AcO	CH ₂ CH ₂ Cl	C	
AcO	CH ₂ Ph	C	
AcO	CH ₂ CH·O·CH ₂	C	
AcO	$\begin{array}{c} \quad \\ \text{CH}_2 - \text{CH}_2 \\ \quad \end{array}$	C	
2,4,5-Cl ₃ C ₆ H ₂ OCH ₂	C ₆ H ₁₁ (cyclohexyl)	C	
	CH ₂ CH ₂ Cl	B	

Dicyclopentadiene condenses with an ether alcohol in the presence of BF_3 or $\text{BF}_3 \cdot \text{Et}_2\text{O}$ in such a manner that the hydroxyl group of the alcohol adds across the double bond of the bridged endomethylene cycle of dicyclopentadiene. Simultaneously, a molecular rearrangement to the so-called "nordicyclopentadiene" ring system occurs. Thus the following dihydronordicyclopentadienyl ethers are prepared, in which R is the dihydronordicyclopentadienyl radical, $\text{C}_{10}\text{H}_{13}$: $\text{MeOCH}_2\text{CH}_2\text{OR}$, $\text{BuOCH}_2\text{CH}_2\text{OR}$, $\text{PhCH}_2\text{OCH}_2\text{CH}_2\text{OR}$, and $(\text{MeOCH}_2)_2\text{CHOR}$.^(127, 133, 134, 135, 136) Similarly, halogenated alcohols react with dicyclopentadiene to produce the dihydronordicyclopentadienyl ethers of the halogenated alcohols. Thus the following compounds were prepared, using $\text{BF}_3 \cdot \text{Et}_2\text{O}$ as catalyst: $(\text{ClCH}_2)_2\text{CHOR}$, $\text{ClCH}_2\text{CH}(\text{OR})\text{CH}_2\text{OR}$, and $2,4\text{-Cl}_2\text{C}_6\text{H}_3\text{OCH}_2\text{CH}_2\text{OR}$. With $\text{BF}_3 \cdot \text{Bu}_2\text{O}$ as the catalyst the following compounds were produced: $\text{ClCH}_2\text{CH}(\text{OH})\text{CH}_2\text{OR}$, $\text{Cl}_5\text{C}_6\text{OCH}_2\text{CH}_2\text{OR}$, $2,6,4\text{-Cl}_2(\text{Me}_3\text{CCH}_2\text{CMe}_2)\text{C}_6\text{H}_2\text{OCH}_2\text{CH}_2\text{OR}$, $\text{ClCH}_2\text{C}(\text{OH})\text{MeCH}_2\text{OR}$, $\text{CH}_2=\text{CClCH}_2\text{OR}$, $\text{ClCH}_2\text{C}(\text{Me})_2\text{OR}$, $\text{Cl}(\text{CH}_2)_3\text{OR}$, and $\text{BrCH}_2\text{CH}_2\text{OR}$.⁽¹²⁸⁾

Unsaturated ethers of hydroxydihydronordicyclopentadiene were prepared by the catalytic action of boron trifluoride on a mixture of an unsaturated alcohol and dicyclopentadiene.⁽¹³²⁾

Dicyclopentadiene also condenses with hydroxydihydronordicyclopentadiene in the presence of boron trifluoride etherate at 60 to 125°C. to yield di-(dihydronordicyclopentadienyl) ether.⁽¹²⁶⁾

Aryloxydihydronorpolycyclopentadienes have been prepared from a crystalline polycyclopentadiene and an aromatic benzenoid compound having a phenolic hydroxyl group.⁽¹³¹⁾

Many similar reactions have been carried out using 1,4-methylenetetrahydrofluorene in place of dicyclopentadiene. The following ethers in which R'' is an endoethylenecyclopentanoindanyl group, $\text{C}_{14}\text{H}_{15}$, have been prepared using the appropriate alcohol: $\text{ClCH}_2\text{CH}_2\text{OR}''$, $\text{Cl}(\text{CH}_2)_3\text{OR}''$, $\text{Br}(\text{CH}_2)_3\text{OR}''$, $\text{NCCCH}_2\text{CH}_2\text{OR}''$, $\text{R}''\text{OCH}_2\text{CH}_2\text{OR}''$, $\text{HOCH}_2\text{CH}_2\text{OCH}_2\text{CH}_2\text{OR}''$, $\text{HOCH}_2\text{CH}(\text{OH})\text{CH}_2\text{OR}''$, $\text{EtOOCCH}(\text{CH}_3)\text{OR}''$, $\text{O}_2\text{NCMe}_2\text{CH}_2\text{OR}''$, $\text{C}_6\text{H}_{11}\text{OR}''$, $\text{PhCH}_2\text{OR}''$, $\text{ClCH}_2\text{CH}_2\text{OCH}_2\text{CH}_2\text{OR}''$, $\text{BuEtCHCH}_2\text{OR}''$, $\text{CH}_3\text{-(CH}_2\text{)}_{10}\text{CH}_2\text{OR}''$, $\text{CH}_2=\text{CHCH}_2\text{OR}''$, $\text{CH}_2\text{CH}_2\text{CH}_2\text{CHOR}''$, $\text{Et-OCH}_2\text{CH}_2\text{OR}''$, $\text{PhOCH}_2\text{CH}_2\text{OR}''$, $\text{EtOOCCH}_2\text{OR}''$, $\text{NCSCH}_2\text{CH}_2\text{OCH}_2\text{CH}_2\text{OR}''$, $\text{ClCH}_2\text{C}(\text{CH}_3)_2\text{OR}''$, $\text{BuOCH}_2\text{CH}_2\text{OCH}_2\text{CH}_2\text{OR}''$, and $\text{ClCH}_2\text{CH}(\text{OH})\text{CH}_2\text{OR}''$.⁽¹²⁹⁾

Methyl chavicol reacts with boron trifluoride etherate at room temperature to produce the so-called metanethole.⁽⁹⁶⁸⁾

Almost all monohydric alcohols condense with acetylene in the presence of mercuric oxide dissolved in a solution of boron trifluoride in the alcohol, to yield acetals.^(370a)

When acetylene is passed into methanol containing $\text{CH}_3\text{OH} \cdot \text{BF}_3$, acetal catalytically forms.⁽⁹¹⁵⁾ In general, acetals are prepared by introducing acetylene into a cooled solution of the polyhydroxy alcohol which contains the catalyst consisting usually of either $\text{CH}_3\text{OH} \cdot \text{BF}_3$ or $\text{C}_2\text{H}_5\text{OH} \cdot \text{BF}_3$ with red mercuric oxide. Ethylene glycol, methyl ethyl pinacol, glycol butyl ether, glycerol methyl ether, diethyleneglycol ethyl ether, ethyl ether, phenyl ether, bis-ethylidenepentaerythritol, trimethylenechlorohydrin, glycerol mon-acetin, hydroxyacetic acid esters,⁽¹⁸⁰⁾ 1-hydroxyisobutyric acid, dimethyl tartrate, diethyl ester, ethyl malate, ethyl ester, dimethyl citrate, mandelic acid, and benzylic acid acetals are thus prepared.^(670, 914, 916)

Acetals of glycol monoethers are prepared by condensing acetylene and a glycol monoether (diethylene glycol monoether), in the presence of a mercuric salt and dihydroxyfluoboric acid or its addition compound with boron trifluoride.^(229, 668)

Various alkylacetylenes, for example, butylacetylene, condense with methanol in the presence of BF_3 or $(\text{C}_2\text{H}_5)_2\text{O} \cdot \text{BF}_3$ and red mercuric oxide to produce a series of 2,2-dimethoxyalkanes, for example, 2,2-dimethoxyhexane.^(358, 454, 665) Use has been made of this type of reaction as an empirical method for the determination of mono- and dialkylacetylenes.^(932a) Methanol adds to 2-octyne, vinylacetylene and methoxy-4-butyne-2 in the presence of $(\text{C}_2\text{H}_5)_2\text{O} \cdot \text{BF}_3$, red mercuric oxide, and trichloroacetic acid to give 3,3-dimethoxyoctane or 2,2,4-trimethoxybutane in good yields.^(361, 454a) Similarly 1-methoxy-3-butyne adds methanol to give 1,3,3-trimethoxybutane.^(676a)

Substituted allylacetylenes add 2 moles of methanol in presence of mercuric oxide, trichloroacetic acid, and boron trifluoride to produce 5,5-dimethoxy-1-alkenes.^(454b)

Boron trifluoride etherate along with red mercuric oxide and trichloroacetic acid is used as a catalyst for the preparation of 2,2,5,5-tetramethyltetrahydro-3-furanone from 2,5-dimethyl-3-hexyne-2, 5-diol and methanol or acetic acid.^(276a)

A uniform mechanism for the addition of alcohols to tertiary

vinylethynylcarbinols under influence of $(C_2H_5)_2O \cdot BF_3 + HgO$ is revealed by some experiments with $CH_2:CHC:CCR_2OH$. This compound first isomerizes to $CH_2:CHCOCH:CR_2$ which then adds 1 mole of alcohol to form $R_1OCH_2CH_2COCH:CR_2$.⁽⁶⁵⁹⁾ Thus are 1,5-dimethoxy-3-hexanone and β -methyl divinyl ketone produced from methylvinylethynylcarbinol and methanol. Similarly, propionaldehyde and the Grignard reagent from bromovinylacetylene give ethylvinylethynylcarbinol, 1,5-dimethoxy-3-heptanone and β -ethyl divinyl ketone. Propylvinylethynyl carbinol, 1,5-dimethoxy-3-octanone, 1-methoxy-4-octen-3-one and β -propyl divinyl ketone form from butyraldehyde. By rearrangement isopropylvinylethynylcarbinol, di-methoxy-6-methyl-3-heptanone, and β -isopropyl divinyl ketone form.⁽⁶⁵⁸⁾

Under similar conditions, methylethyl- or diethylethynylcarbinol in methanol gives 3-ethyl-4,4-dimethoxy-3-pentanol and 3-methyl-4,4-dimethoxy-3-pentanol.⁽⁶⁵⁷⁾

In the presence of small amounts of red mercuric oxide, ethyl ether-boron trifluoride complex, and trichloroacetic acid, methanol reacts with dimethylethynylcarbinol to yield principally 3,3-dimethoxy-2-methyl-2-butanol. A small quantity of 2,5-dimethoxy-2,3,3,5,6,6-hexamethyl-1,4-dioxane is obtained as a by-product.^(276a)

A phenol, such as hydroxybenzene, naphthol, anthranol, 1,4,2-xylenol or cresylic acid, condenses with a phenol ether having an unsaturated hydrocarbon constituent, such as the ethyl or amyl ethers of cardanol, amyl ether of cashew nut shell oil, diethyl ether of unrushiol, eugenol, anethole, or safrole, in the presence of boron trifluoride.⁽³³⁹⁾

Carbon Monoxide Addition. Gasselin⁽²⁸²⁾ in 1894 reported that carbon monoxide and boron trifluoride did not react, which is interesting in view of the fact that boron trifluoride catalyzes many addition reactions involving carbon monoxide.

Aliphatic and hydroaromatic hydrocarbons are oxygenated by reaction with carbon monoxide under pressure in the presence of boron trifluoride.⁽⁴¹⁸⁾ Alkyl halides have been reported to add CO in the presence of BF_3 with or without the addition of HIF in the presence of an appreciable amount of water.⁽²³³⁾

Olefins, such as ethylene and propylene, add CO under pressures of 400-1000 atmospheres and at temperatures between 75-300°C. in presence of boron trifluoride associated with 1 to 5 moles of

water per mole of boron trifluoride for 1 to 4 hours, to produce the corresponding acids.^(225, 455, 540, 542, 545) The presence of HF is optional.⁽²³³⁾ Under similar conditions, olefinic or hydroxy aliphatic monocarboxylic acids, or their esters, may react with CO to produce aliphatic acids.^(231a)

Ethyl α -methyl- α -methyl- α -ethyl butyrate is obtained by heating $\text{BF}_3 \cdot \text{H}_2\text{O}$ and benzoyl peroxide with ethylene and carbon monoxide for 10 to 75 hours at a temperature of 114 to 115°C. The pressure is maintained at 550 to 900 atmospheres by the carbon monoxide addition. In the absence of benzoyl peroxide the yield was much less.⁽³³¹⁾ The same compound has also been prepared from a mixture of propylene, ethylene, and carbon monoxide under pressure with $\text{BF}_3 \cdot \text{H}_2\text{O}$ catalyst.^(269b)

Saturated aliphatic monohydric alcohols or compounds which on hydrolysis give such alcohols add carbon monoxide under various conditions of temperature, pressure, and catalysts to produce the corresponding acids and esters. The reaction temperatures reported vary from 125 to 400°C. and the reaction pressures from 25 to 900 atmospheres. These conditions are dependent on the catalyst, which might be boron trifluoride alone,^(230, 536, 537, 548) an addition compound of boron trifluoride⁽⁵³⁴⁾ with 1-5 moles of water,^(538, 545, 549) boron trifluoride with water with or without the presence of hydrogen fluoride⁽¹⁵³⁾ or a boron trifluoride complex with an inorganic acid such as H_3PO_4 .^(226, 550)

Polyhydroxy alcohols when treated with CO in presence of boron trifluoride at 180-240°C. and 350-700 atmospheres pressure produce polycarboxylic acids.⁽⁵³⁶⁾

An aliphatic ketone and water add CO when heated in the liquid phase below 350°C. and under at least 10 atmospheres pressure in presence of boron trifluoride to produce an acid.⁽⁴⁹²⁾ Formaldehyde and water add CO when heated at 50-350°C. and at 5 to 1500 atmospheres to give glycollic acid.⁽⁵⁴⁴⁾

An aliphatic ether condenses with CO at elevated temperatures and pressures in presence of various boron trifluoride catalysts to produce an aliphatic acid and esters. The types of catalysts used are boron trifluoride alone,^(491, 535) boron trifluoride with active carbon,⁽⁹⁵⁸⁾ boron trifluoride with water with or without HF,⁽²³³⁾ and boron trifluoride with 1-5 moles of H_2O .⁽⁵⁴⁵⁾ CO also adds to the coordination compound $(\text{CH}_3)_2\text{O} \cdot \text{BF}_3$ in presence of water to produce acetic acid and methyl acetate.⁽²²⁵⁾

Methyl methoxy acetate and other esters are produced by the reaction between a methylene glycol diether, such as dimethyl ether, and CO at temperatures between 10 and 100°C. and under pressures of 30 to 700 atmospheres in the presence of 25 to 75 moles of boron trifluoride per 100 moles of ether.⁽⁴⁴⁴⁾ Methyl methoxy acetate has been prepared also by the addition of CO at 47.6 atmospheres to paraformaldehyde and dimethyl ether in the presence of $\text{BF}_3 \cdot \text{Me}_2\text{O}$ at 200°C.⁽⁵⁵⁴⁾

Esters are produced by the reaction of cyclic acetals, such as 1,3-dioxolane, and CO using boron trifluoride as a catalyst.⁽³¹⁸⁾

An ester has been reported also to add CO in the presence of boron trifluoride, with or without the addition of HF, in the presence of an appreciable amount of water.⁽²³³⁾

Nitrogen Compounds. Substituted amides are prepared in the presence of boron trifluoride by the reaction of an amide upon an amine. The reaction is driven to completion by splitting out a molecule of ammonia and the formation of the coordination compound $\text{NH}_3 \cdot \text{BF}_3$, thus: $\text{AcNH}_2 \cdot \text{BF}_3 + \text{BuNH}_2 \rightarrow \text{AcNHBu} + \text{NH}_3 \cdot \text{BF}_3$. The following acetamides are thus prepared: *n*-butyl, isomyl, *n*-phenyl, *n*-1-naphthyl, *n*-2-naphthyl, *n*-methyl-*n*-phenyl, *n*-ethyl-*n*-phenyl, and *n,n*-dibutyl. Benzanilide and *n*-phenylpropionamide are prepared similarly.⁽⁸²⁹⁾

Aniline and esters produce the corresponding anilides when refluxed with boron trifluoride. Thus ethyl acetate and isopropyl acetate yield acetanilide, *n*-butyl propionate forms propionanilide, and ethyl benzoate produces benzanilide.

Benzaldehyde anil condenses with ethyl malonate and ethyl acetoacetate in the presence of boron trifluoride.⁽³⁴³⁾

Nitriles are formed by a reaction similar to those above. Amides react with acids in the presence of boron trifluoride to produce nitriles. Acetonitrile results from acetamide and acetic, propionic, butyric, hydrochloric, and benzoic acids. Likewise, propionitrile forms from the reaction of propionamide on acetic and propionic acids.⁽⁸²⁹⁾

Boron trifluoride and its etherate are suitable condensing agents in the Fischer indole syntheses from phenylhydrazones due to the formation of $\text{NH}_3 \cdot \text{BF}_3$. Thus the phenylhydrazones of methyl ethyl ketone, isovaleraldehyde, acetophenone, propiophenone, ethyl pyruvate, ethyl levulinate, α -keto- γ -butyrolactone, ethyl- α -keto- γ -cyanobutyrate, cyclopentanone, cyclohexanone, and α -

methylphenylhydrazone of cyclohexanone are converted to indole derivatives.⁽⁸¹⁷⁾

Sulfur Compounds. Boron trifluoride catalyzes the addition of a sulfide of phosphorus to an olefinic hydrocarbon or polymer thereof, or to an aromatic compound.^(449, 450, 523, 525-531, 619)

Organic sulfur compounds are formed from olefins and hydrogen sulfide or mercaptans in the presence of boron trifluoride hydrates^(787b) or boron trifluoride with the oxy acids of phosphorus.^(787a)

Organic-sulfur-containing compounds, occurring in petroleum distillates, are fixed by a treatment with boron trifluoride monohydrate.⁽²⁵⁾

Chloroprene-type rubbers are vulcanized by boron trifluoride complexes in the presence of nitrogenous bases, excluding hydrazine.^(27a)

ESTERIFICATION

It has been found that boron trifluoride alone or with its oxygen-containing complexes is a good catalyst for esterification reactions. The coordination compounds with water, alcohols, or acids because of their increased acidity are preferred.

Esters may be prepared by the addition of an acid to an olefin following Markownikoff's rule. The mechanism for this reaction might be as follows:

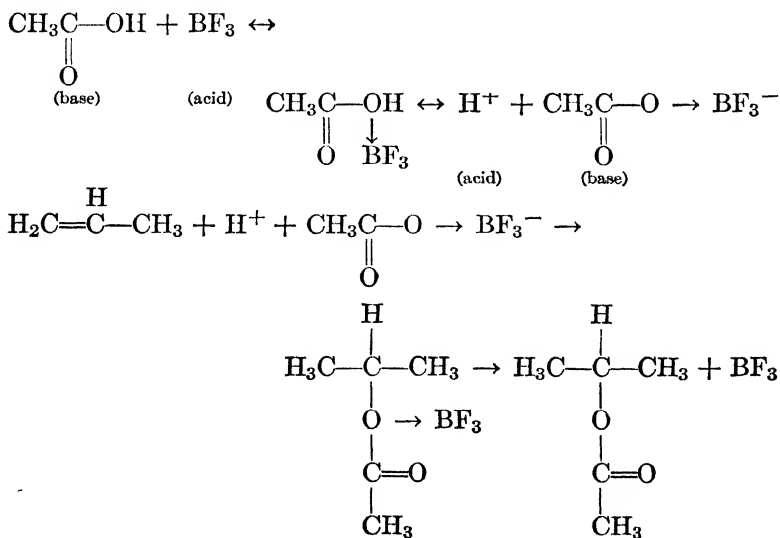

The use of this type of esterification reaction is limited, owing to the tendency for the olefins to polymerize. For olefins containing 5 or more carbon atoms, the esterification must be conducted below 100°C. to prevent extensive polymerization.

Esters may be prepared also by the condensation of an acid with an alcohol. The mechanism of this type of reaction may be represented in the following manner:

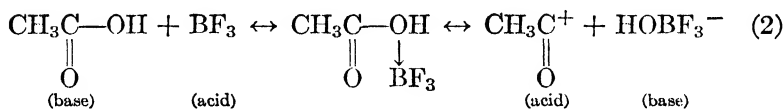
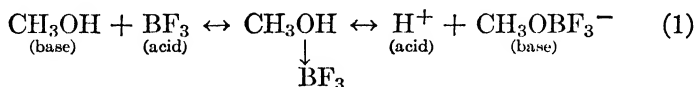

Interaction of the products of steps 1 and 2 gives:

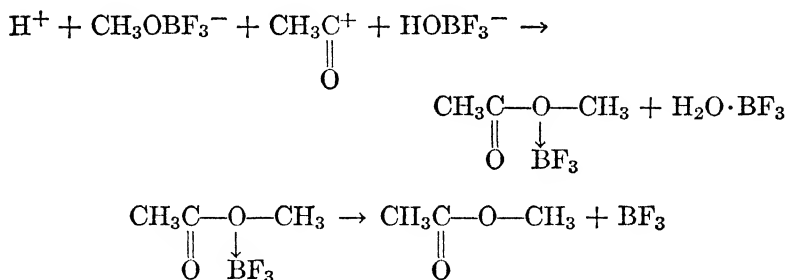

Esters also may be prepared by condensing a nitrogen derivative, such as an amide with an alcohol in the presence of boron trifluoride. The yields are usually less than 50%, which is probably due in the case of amides to the fact that part of the amide is converted to a nitrile. These reactions may be represented as follows:

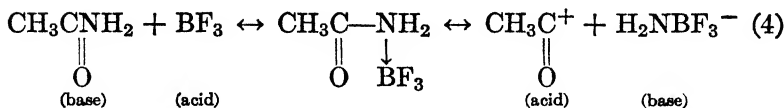
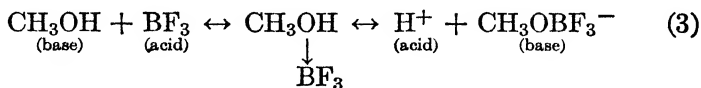

Interaction of the products of steps 3 and 4 gives:

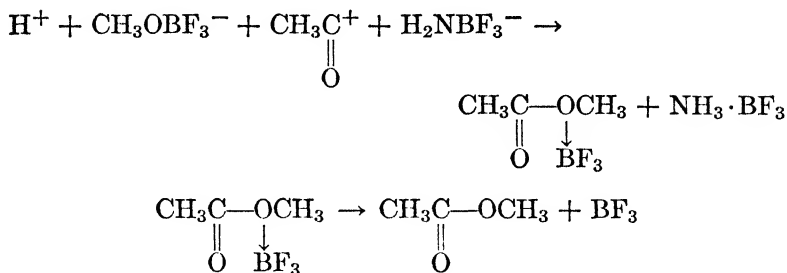

Acid-to-Olefin Condensation. An ester containing a carboethoxy group on a tertiary carbon atom, such as α, α, α -dimethyl ethyl butyrate, is obtained by heating $\text{BF}_3 \cdot \text{H}_2\text{O}$ and benzoyl peroxide with ethylene and carbon monoxide for 10 to 75 hours at a temperature of 114 to 115°C. under a pressure of 550 to 990 atmospheres.⁽³³¹⁾

Olefins react with acids to produce esters in the presence of boron trifluoride as a catalyst. Cyclohexyl acetate or cyclohexyl trichloracetate are produced from cyclohexene and acetic acid,⁽⁹⁶⁹⁾ or trichloroacetic acid,⁽⁹⁷⁰⁾ respectively. $\text{BF}_3 \cdot (\text{C}_2\text{H}_5)_2\text{O}$ has been used as the catalyst for the reaction with trichloroacetic acid.⁽⁹⁷⁰⁾ Isobornyl acetate forms from the reaction of camphene and glacial acetic acid in the presence of boron trifluoride.⁽⁴¹⁹⁾ Using $\text{BF}_3 \cdot 2\text{H}_2\text{O}$ as a catalyst, ethylene and acetic acid react to produce ethyl acetate.⁽⁵⁵¹⁾ $\text{BF}_3\text{-HF}$ mixtures also catalyze this reaction.^(56, 57) Dihydroxyfluoboric acid serves better than boron trifluoride as a catalyst for the esterification of acetic acid with propylene, butylene, amylene, or vinyl chloride, and for the esterification of phenol with propylene.⁽⁶⁶⁹⁾ Esterification using acetic acid-boron trifluoride catalyst has been used to remove olefins from hydrocarbon mixtures.⁽³⁹³⁾

Organic acids yield with dimethylethynylcarbinol, in the presence of $(\text{C}_2\text{H}_5)_2\text{O} \cdot \text{BF}_3$ and red mercuric oxide, the ester $\text{Me}_2\text{C}(\text{OCOR})\text{OAc}$ and probably isomerization products of the primarily formed ester $\text{Me}_2\text{C}(\text{OH})\text{C}(\text{OCOR})\text{:CH}_2$. With acetic acid and the carbinol the following compounds form: 3-ethyl-3-formoxy-4-pentanone, 1-acetyl-1-formoxycyclohexane, 3-ethyl-3-acetoxy-4-pentanone, and 1-acetylcyclohexyl acetate. With propionic acid, propionic anhydride, and the carbinol, the following products form:

diethylacetyl carbinyl propionate, 1-acetyl cyclohexyl propionate, and diethylethynyl carbinyl acetate.⁽⁶⁵⁷⁾

Propylene condenses with acetic acid,⁽⁶⁷⁾ its chloro derivatives, or phenol in the presence of boron trifluoride and at elevated temperature and pressure to produce the corresponding isopropyl esters.⁽²¹³⁾

Salicylic acids and olefins are esterified above 38°C. with 0.05 to 0.5 mole of boron trifluoride.⁽⁶⁸⁰⁾ With propylene, salicylic acid condenses to form isopropyl salicylate, which rearranges with the entry of the isopropyl group into the ring, leaving a substituted acid which condenses with more propylene to form an ester which also rearranges.⁽¹⁸⁸⁾ If the reaction goes to completion, a theoretical yield of 2-hydroxy-3,5-diisopropylbenzoic acid forms.⁽¹⁸⁶⁾ In a similar manner propylene condenses with meta- and parahydroxybenzoic acid⁽¹⁸⁷⁾ with boron trifluoride as the catalyst.

Boron trifluoride-diethyl etherate catalyzes the addition of carboxylic acids to olefins. The presence of red mercuric oxide increases the polymerization of the olefins and interferes with the addition. Esters are thus prepared from 2-butene and acetic, chlor- and trichloroacetic, propionic, butyric, isobutyric, oxalic, succinic, *d*-tartaric, benzoic, and phthalic acids. Acetic acid also adds to 2-methyl-1-propene and to 2-pentene, respectively.⁽⁹⁷¹⁾ Olefins and cyclopropane also condense with paraffinic acids in a solvent such as tetrachloroethane containing boron trifluoride under pressure.⁽²¹²⁾

Esters of hydroxypolyarylmethanes are prepared by reacting in the presence of an acidic catalyst such as boron trifluoride a compound of the formula $R(\text{CH}_2\text{O-acyl})_n$, in which R is a carboxylic acid esterified hydroxy aromatic nucleus, acyl represents a monocarboxylic acyl group, and *n* is a small whole number, with reacting proportions of a compound having a reactive nuclear hydrogen atom.⁽¹²⁴⁾

Carboxylic esters of hydroxydihydronorpolycyclopentadiene having an acyl group attached through oxygen to one terminal cycle and having a double bond in the opposite terminal cycle are prepared by addition and rearrangement of an organic carboxylic acid and a crystalline polycyclopentadiene having two double bonds and one to four endomethylene cycles per molecule, at a temperature below the depolymerization temperature of said polycyclopentadiene in presence of a nonoxidizing acidic catalyst such as boron trifluoride.⁽¹³⁷⁾

Organic carboxylic acids react with 1,4-endomethylenetetrahydrofluorene at 95°C. in the presence of boron trifluoride, or one of its etherates, to form isomeric esters of endoethylenehydroxycyclopentanoindane by an addition reaction in which a simultaneous rearrangement occurs. With formic acid, for example, the reaction may be expressed in the following equation:

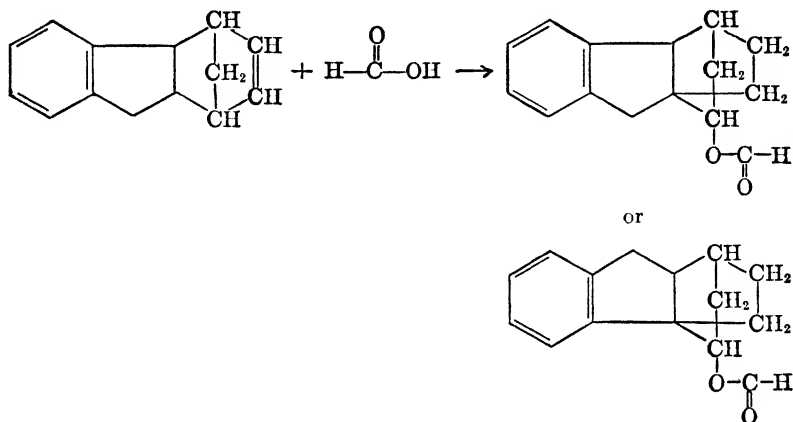

Similarly the esters of acetic, benzoic, glycollic, lactic, crotonic, and monochloroacetic acids have been prepared. With the dibasic acids a reaction with 2 moles of 1,4-endomethylenetetrahydrofluorene may occur.⁽¹³⁰⁾

Acid-to-Acetylene Condensation. In the presence of $(C_2H_5)_2O \cdot BF_3$, 1 mole of a monobasic organic acid reacts with 1 mole of a monoalkyl acetylene. The acyloxy group attaches to the non-terminal acetylenic carbon atom.^(357a)

Acetylene and acetic acid react in the presence of dihydroxyfluoric acid to produce an ester.⁽⁶⁶⁹⁾

An acetylene γ -glycol $[(HO \cdot C : (CH_3)_2 \cdot C :)]_2$ reacts with a carboxylic acid, such as acetic, in the presence of boron trifluoride and mercuric acetate to produce products such as 2,2,5,5-tetramethyltetrahydro-3-ketofuran and 2,2,5,5-tetramethyl-2,5-dihydro-3-hydroxyfuran acetate.⁽⁹⁶⁵⁾

Condensation of an Acid with an Alcohol. Aliphatic alcohols react with aliphatic acids in the presence of boron trifluoride or $(C_2H_5)_2O \cdot BF_3$ to produce the corresponding esters.^(309, 448, 669, 894) With absolute methyl alcohol the corresponding esters form from the following acetic acids: glacial, mono-, di-, and trichloroacetic,

and phenylacetic. A methyl ester of propionic acid also forms in this manner.⁽⁸⁹⁴⁾ It has been reported that dihydroxyfluoboric acid gives better control of this type of reaction than does boron trifluoride.⁽⁶⁶⁹⁾

Dimethylethynylcarbinol reacts with glacial acetic acid in the presence of red mercuric oxide, boron trifluoride etherate, and trichloroacetic acid to produce 2-acetoxy-2-methyl-3-butanone.^(276a)

Esters of the above type also are produced with a series of aliphatic alcohols by the reaction of the alcohol with the acid coordination compound with boron trifluoride, such as $2\text{CH}_3\text{COOH}\cdot\text{BF}_3$ or $\text{C}_2\text{H}_5\text{COOH}\cdot\text{BF}_3$.⁽³⁷¹⁾

Esterification of cellulose is effected by the use of a mixture containing an aliphatic acid having less than 5 carbon atoms in the molecule and a lesser amount of an aliphatic anhydride than theoretically required to react with all of the hydroxyl groups of the cellulose. The catalyst consists of a boron trifluoride coordination compound with an aliphatic acid, alkyl ester of that acid, or water.⁽¹⁷⁷⁾ Cellulose derivatives also are prepared by the reaction of cotton with an acetylating bath using boron trifluoride as the catalyst.⁽²¹⁰⁾

Similarly, aliphatic alcohols undergo esterification reactions with aromatic acids. By passing boron trifluoride into a solution of the acid in the alcohol, or by the use of $(\text{C}_2\text{H}_5)_2\text{O}\cdot\text{BF}_3$, and refluxing, the following benzoates are prepared: methyl, isopropyl, normal, secondary, tertiary, and isobutyl, methyl-*p*-nitro-, methyl-*p*-amino-, methyl-*o*-amino-, methyl-*o*-chloro-, methyl-*o*-hydroxy-, and isobutyl-*o*-hydroxy-.^(828, 894)

Condensation of a Nitrile or an Amide with an Alcohol.

Analogous to the acids in the oxygen-containing organic compounds, nitriles in the nitrogen derivatives have been reported to react with alcohols to produce the corresponding esters when boron trifluoride is present. Thus propyl acetate, butyl acetate, and normal propyl benzoate are prepared.⁽⁵⁷⁰⁾

Esterification of amides by alcohols and phenols in the presence of boron trifluoride has been reported. With absolute methyl alcohol, methyl esters of the following amides are produced: formamide, acetamide, mono-, di-, and trichloroacetamides, phenylacetamide, propionamide, and benzamide.^(667, 894) By using the coordination compound between acetamide and boron trifluoride, the esterification of alcohols and phenols to acetates is effected. Methyl, ethyl, isopropyl, butyl, tertiary butyl, and phenyl acetates form in this manner.⁽⁸²⁷⁾

Aldol Condensation. Benzaldehyde condenses with acetophenone ethyl malonate, and acetic anhydride, using boron trifluoride as the catalyst, to produce benzalacetophenone, ethyl benzalmalonate which undergoes a Michael type of condensation with the addition of ethyl malonate to produce ethyl benzaldimalonate and cinnamic acid, respectively. Ethyl malonate condenses with ethyl benzalmalonate and benzalacetophenone in the presence of boron trifluoride to yield ethyl benzaldimalonate as the principal product.⁽¹⁰⁹⁾

✓ **Miscellaneous Esterifications.** Acetylenic alcohols condense with methanol to produce a number of substituted dioxanes and with ethylene glycol to form various dioxolanes, using $(C_2H_5)_2O \cdot BF_3 + HgO$ + a few crystals of trichloroacetic acid, as the catalyst. Acyloin acetates form by similar reactions with acetic acid.⁽³⁶⁰⁾ With the same catalyst in methanol, polyhydric alcohols and α -hydroxy acids are converted by butyl- or monovinylacetylene to dioxolanes and dioxolones.^(454c)

Glycerides react with alcohols having 1 to 6 carbon atoms in the presence of boron trifluoride at a temperature above the boiling point of the alcohol and under a pressure sufficiently great to maintain the alcohol in a liquid state, thus producing high yields of esters.^(6, 309, 448)

Esters result from the acidolysis of esters by acetic acid and $2CH_3COOH \cdot BF_3$. Thus *n*-propyl acetate results from *n*-propyl-propionate, -benzoate, and -salicylate; *n*-butyl acetate from *n*-butyl-formate, -propionate, -benzoate, and -salicylate; tertiary and isobutyl acetates from isobutyl-propionate, -benzoate, and -salicylate; and ethyl acetate from ethyl-malonate, -formate, -benzoate, -chloroacetate, and phenyl acetate.⁽⁸²⁰⁾

Aliphatic ethers and organic acids have been reported to react at high temperatures in the presence of boron trifluoride to produce esters. By such a reaction ethyl acetate, ethyl propionate, ethyl cinnamate, phenetole, *n*-propyl acetate, *n*-butyl acetate, isoamyl propionate, and isoamyl benzoate are prepared.⁽³⁵⁷⁾ Normal propyl acetate forms from benzyl-*n*-propyl ether and acetic acid. A polymer also forms which upon pyrolysis gives anthracene.⁽⁶³⁶⁾

Methyl methoxy acetate and other esters are produced by the reaction of a methylene glycol diether, such as dimethyl ether, with CO at a temperature between 10 and 100°C. and under a pressure of 30 to 700 atmospheres in the presence of 25 to 75 moles of boron trifluoride per 100 moles of ether.⁽⁴⁴⁴⁾

Diethyl ether has been reported to react in presence of boron trifluoride with acetyl chloride and with benzoyl chloride to produce the respective esters. With the latter compound only a trace of ester is obtained.⁽⁵⁸⁸⁾

An α -hydroxy aliphatic acid, or one of its esters or anhydrides, has been reported to produce an ether ester of the acid when reacted with ethers in the presence of boron trifluoride. For example, glycollic acid and methyl ether give methyl methoxy acetate.⁽²³¹⁾

Similarly, dimethyl ether reacts with methyl hydroxy acetate, or its anhydride, in the presence of boron trifluoride or $\text{BF}_3 \cdot 2\text{H}_2\text{O}$ at a temperature between 100 and 300°C.^(553, 554) A higher yield (45%) of the ether ester is obtained using the dihydrate as a catalyst.

Two moles of chloromethyl ether, $(\text{ClCH}_2)_2\text{O}$, react with 1 mole of ethyl acetoacetate, $\text{CH}_3\text{COCH}_2\text{CO}_2\text{C}_2\text{H}_5$, in the presence of boron trifluoride at 0°C. to give a 33% yield of methylene diacetoacetic ester, $\text{CH}_2(\text{CHCH}_3\text{COCO}_2\text{C}_2\text{H}_5)_2$.⁽⁵⁰⁵⁾

Phenols, or their derivatives, such as cresol, condense with unsaturated fatty acids or their derivatives, such as olive oil, in the presence of boron trifluoride and nitrogen at room temperature to yield a thick oil.^(419c)

Acid anhydrides are esterified by ethers in the presence of boron trifluoride or by the boron trifluoride etherate.^(585, 588, 636) When phenol or resorcinol are refluxed with phthalic anhydride and boron trifluoride, phenolphthalein and fluorescein, respectively, result.⁽⁵⁷⁰⁾

Normal condensation products result from the reaction of cyclic oxides, for example, ethylene oxide, with acids in the presence of boron trifluoride.⁽⁷⁰⁵⁾ Esters are produced by the reaction of cyclic acetals, for example, 1,3-dioxolane, with CO, using boron trifluoride as a catalyst.⁽³¹⁸⁾

The ester, $\text{HCOOC}_2\text{H}_5 \cdot \text{BF}_3$, is produced by the reaction of ethyl orthoformate with BF_3 . The other product which forms is $(\text{C}_2\text{H}_5)_2\text{O} \cdot \text{BF}_3$.⁽⁵⁷⁰⁾

An ester, such as propyl glycolate, forms by treating an alkyl formate, such as methyl formate, with formaldehyde in the presence of boron trifluoride.⁽²⁶⁸⁾ Paraformaldehyde reacts with dimethyl ether and carbon monoxide (under a pressure of 700 pounds) in the presence of $(\text{CH}_3)_2\text{O} \cdot \text{BF}_3$ at a temperature of 200°C., thus forming methyl methoxy acetate.⁽⁵⁵⁴⁾

The ethyl esters of *N-p*-methoxyphenylglutaramic acid and of *N-p*-ethoxyphenylglutaramic acid result from the Beckmann rearrangement of the appropriate oximes upon boiling in a boron trifluoride etherate complex. Similarly, diphenyl ketoxime is converted to benzanilide.⁽⁹⁶⁸⁾

Some of the steroids have been esterified with acetic acid and acetic anhydride using boron trifluoride etherate with mercuric oxide as the catalyst. These reactions are summarized in Table 37.

TABLE 37

Reactant	Ester	Reference
17-Ethinyl-3- <i>trans</i> -17- α -dihydroxyandrostane-3-acetate	Two diacetates of reactant	765a
17-Ethinyl-3- <i>trans</i> -17- α -diacetoxyandrostane	Diacetate of reactant	765a, 765b
3- β -17- α -Dihydroxy-20-pregnynone	3- β -17- α -Diacetoxy-20-pregnaneone	798
3- β -Acetoxy-17- α -hydroxy-20-pregnynone	3- β -17- α -20-Pregnanone and 3- β -17- α,β -diacetoxy-17- α -methyl-17- <i>D</i> -homoetiocholanone	797
3- β -Acetoxy-17- α -hydroxyallo-20-pregnanone	3- β -17- α,β -Diacetoxy-17- α -methyl- <i>D</i> -homo-17-androstanone	799
3- β -Acetoxy-17- α,β -hydroxy-17- α -methyl-17- <i>D</i> -homoctiocholanone	3- β -17- α,β -Diacetoxy-17- α -methyl-17- <i>D</i> -homoetiocholanone	797, 799, 801
17-Ethinyl-3- <i>trans</i> -17-dihydroxy-5-androstene	20-Acetoxy-3- <i>trans</i> -17-dihydroxy-5,20-pregnadiene and 3- <i>trans</i> -17- α -diacetoxy-5-pregnene-20-one	765a, 765b, 765c, 765d
17-Ethinyl-3- <i>trans</i> -acetoxy-17-hydroxy-5-androstene	3- <i>trans</i> -20-Diacetoxy-17-hydroxy-5,20-pregnadiene and 3- <i>trans</i> -17- α -diacetoxy-5-pregnene-20-one	765b, 765c, 765d
17-Ethinyltestosterone	20-Acetoxy derivatives of 17-ethinyl-testosterone	765b
3- β -17- α -Dihydroxy-5-pregnene-20-one	3- β -17- α,β -Diacetoxy-17- α -methyl- <i>D</i> -homo-5-androstene-17-one	799
3- β -17- α,β -Dihydroxy-17- α -methyl- <i>D</i> -homo-5-androstene-17-one	3- β -17- α,β -Diacetoxy-17- α -methyl- <i>D</i> -homo-5-androstene-17-one	799

Esters of boric acid result from the reaction of epichlorohydrin with $(\text{CH}_3)_2\text{O}\cdot\text{BF}_3$ and $(\text{C}_2\text{H}_5)_2\text{O}\cdot\text{BF}_3$. The boric esters are of

the general type $[\text{ROCH}_2(\text{CH}_2\text{Cl})\text{CHO}]_3\text{B}$, where R is a methyl or ethyl group.⁽⁵⁸⁷⁾

Resins are produced by the condensation of phenols and cresols with natural resins (for example, colophony), or their corresponding acids, or esters, at high or low temperatures in the presence of boron trifluoride. An organic solvent, such as carbon tetrachloride, is used.^(76a, 407d, 407e, 418c, 419b, 419d)

DECOMPOSITIONS

In cracking processes, boron trifluoride or one of its addition products may be used to split hydrocarbon oils.^(385, 512b, 918) When a naphtha, boiling from 150 to 250°C., is mixed with an equal molecular proportion of a butane fraction, consisting largely of isobutane, and the mixture is brought into contact at 500°C. with 5% by weight of COCl_2 , 5% HF, and 1% BF_3 at 2 atmospheres pressure, an 80% yield of a gasoline having an octane number of 77 is obtained.⁽⁵¹⁷⁾

Isobutane has been produced from saturated petroleum naphthas, boiling above 125°C., by heating them between 35 and 205°C., using boron trifluoride as the catalyst.^(76b) Increased yields of isobutane have been obtained by carrying the process out with hydrogen fluoride along with the boron trifluoride in the presence of hydrogen.⁽²⁷⁶⁾

Alkylbenzenes containing at least 3 carbon atoms in the alkyl group have been converted to ethylbenzene at elevated temperatures and pressures in the presence of hydrogen fluoride and boron trifluoride.

HYDRATION

When dimethylethynylcarbinol reacts with glacial acetic acid in the presence of a catalyst comprised of red mercuric oxide, trichloroacetic acid and boron trifluoride etherate, the unsaturated linkage is hydrated to give 2-acetoxy-2-methyl-3-butanone.^(276a) Using the same catalyst, the triple bond of 2,5-dimethyl-3-hexyne-2,5-diol is hydrated by either methanol or acetic acid to yield the cyclized product tetramethyltetrahydro-3-furanone.^(276a)

By the Nieuwland method, for example, by the use of red mercuric oxide, boron trifluoride etherate, acetic acid, and acetic anhydride, the steroids shown in Table 38 have been hydrated.

TABLE 38

Reactant	Product	Reference
3- β -17- α -Dihydroxy-20-pregnynone	3- β -17- α -Diacetoxy-20-pregnane	798
3- β -Acetoxy-17- α -hydroxy-20-pregnynone	3- β -17- α -Diacetoxy-20-pregnane and 3- β -17- α,β -diacetoxy-17- α -methyl-17- <i>D</i> -homotiocholanone	797
Δ^5 -17-Ethynyl-3- α -17- α -dihydroxyandrostene	Δ^5 -3- α -17- α -Diacetoxypregnene-20-one	765c
Δ^5 -17-Ethynyl-3- α -acetoxy-17- α -hydroxyandrostene	Δ^5 -3- α -17- α -Diacetoxypregnene-20-one	765c
Δ^5 -17-Ethynyl-3- α -17- α -diacetoxyandrostene	Δ^5 -3- α -17- α -Diacetoxypregnene-20-one	799
Δ^5 -17-Ethynyl-3- α -17- α -dihydroxyandrostene-3-acetate-17-benzoate	Δ^5 -3- α -17- α -Diacetoxypregnene-20-one-17-benzoate	765c
Δ^5 -17-Ethynyl-3- β -17- α -dihydroxyandrostene-3-acetate-17-stearate	Δ^5 -3- β -17- α -Diacetoxypregnene-20-one-17-stearate	334
3- β -Acetoxy-5,16-pregnadiene-20-yne	3- β -Acetoxy-5,16-pregnadiene-20-one	800
17-ethynyltestosterone	17-Oxyprogesterone	765c

DEHYDRATION

In 1877 Landolph proposed the use of boron trifluoride as an organic dehydrating agent.⁽⁴⁸⁰⁾

Alcohols. Many early workers reported that boron trifluoride dehydrated methyl and ethyl alcohols to produce ethers.^(207, 282, 477, 511) Cannizzaro reported that he obtained an isomer of stilbene from the reaction of boron trifluoride on benzyl alcohol.⁽¹⁷¹⁾ Gas-selin found that resorcinol was dehydrated by boron trifluoride.⁽²⁸²⁾ More recently, hydrocarbon oils were produced when boron trifluoride was passed into alcohols other than methyl or ethyl.⁽¹⁰⁷⁾ Hydrocarbons were produced when a mixture of tertiary butyl alcohol and acetic acid was heated with a hydrate of boron trifluoride.⁽³⁹⁴⁾

Acids. Acetic anhydride was obtained from acetic acid and boron trifluoride by Landolph.⁽⁴⁸⁰⁾

Ketones. Meerwein and Vossen reported that 1 mole of water splits out of 2 moles of desoxybenzoin to form α -benzoyl- α,β,γ -triphenyl- Δ - α -propene in the presence of boron trifluoride.⁽⁵⁹⁰⁾

HYDROGENATION

A crude mineral oil boiling above 300°C., in the presence of boron trifluoride and hydrogen at 150 atmospheres and 380°C. gives 75% yield of an oil boiling below 250°C. and 15% yield of a highly viscous lubricating oil. With $(C_2H_5)_2O \cdot BF_3$ as catalyst, 60% yield of the light oil is obtained.⁽³⁸⁴⁾

By subjection of a hydrocarbon charging stock to the action of hydrogen in the presence of boron trifluoride and hydrogen chloride under pressure and at an elevated temperature, such as to cause destructive hydrogenation, isobutane and motor fuel are formed.⁽⁷⁷⁴⁾

NITRATION

Although the mechanism of nitration of organic compounds using boron trifluoride as a catalyst is not known, it may be postulated⁽⁷²¹⁾ as proceeding in the following steps:

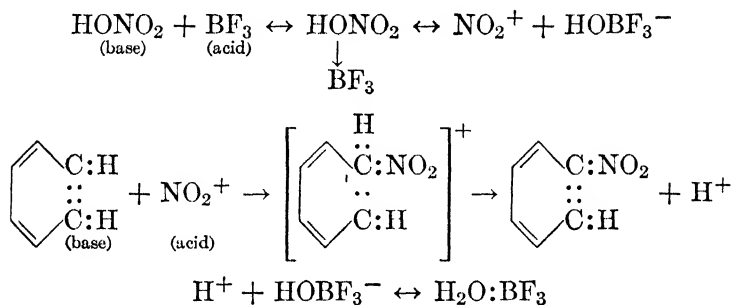

Proof of the existence of $\text{HNO}_3 \cdot \text{BF}_3$ is lacking, but it has been observed that a large volume of boron trifluoride is soluble in nitric acid.⁽³³³⁾

It may be that the affinity of boron trifluoride for water is the driving force in nitration reactions in which water is split out. In practice the monohydrate thus formed is converted to the dihydrate which is easily removed by several methods. By such reactions nitrobenzene, benzoic acid, *p*-toluene sulfonic acid, methyl benzoate and phthalic anhydride are nitrated.^(353, 888) Nitration reactions in which boron trifluoride is used as the catalyst are reported to proceed more rapidly at lower average temperatures (40–100°C.) and to yield a higher percentage of a purer product. Boron trifluoride is especially good as a catalyst for the nitration

of compounds containing such negative groups as Cl, NO₂ and COOH.^(447a)

OXIDATION

When benzaldehyde is heated with boron trifluoride for 24 hours at 250°C. in a sealed tube, a 20% yield of benzoic acid is obtained.⁽⁴⁸⁶⁾

REDUCTION

It has been found that the ArCH(OH) group is easily reduced catalytically by hydrogen to ArCH₂ in acetic acid or in propionic acid in the presence of CH₃COOH·BF₃. Thus C₆H₅CH(OH)CH-(C₂H₅)NH₂ is reduced to C₆H₅CH₂CH(C₂H₅)NH₂.⁽⁷³⁶⁾

SULFONATION

As in the case of nitration discussed previously, the role of the boron trifluoride in sulfonation reactions may be to use the water formed in the reaction to produce boron trifluoride monohydrate and thus shift the equilibrium to promote the sulfonation. Luder and Zuffanti^(561a) suggest that the boron trifluoride reacts with sulfuric acid to liberate sulfur trioxide which in turn sulfonates the organic molecule, thus:

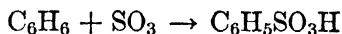
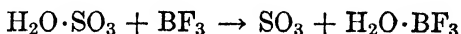

The monohydrate of boron trifluoride is converted to the dihydrate and then removed in various ways. Benzene, toluene, phenol, naphthalene, β -naphthol, the naphthylamines, and heterocyclic compounds are sulfonated in this manner. Carbazole and diphenyl are similarly disulfonated.^(354, 363, 888)

It is claimed that sulfonation reactions may be carried out at lower average temperatures (40–100°C.) to give higher yields of purer products in less time. However, some aromatic compounds such as chlorobenzene, nitrobenzene, and benzoic acid are not sulfonated any faster by the use of boron trifluoride.^(447a)

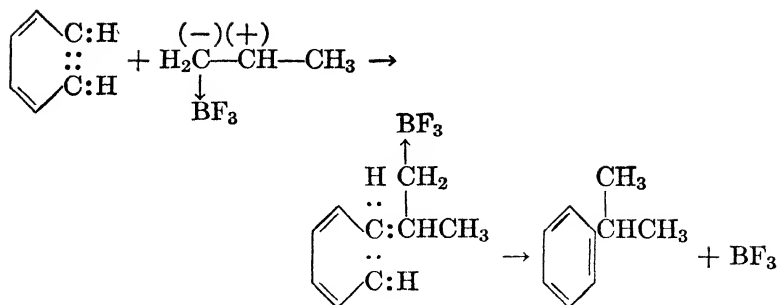

2. *Alcohols.* With alcohols as alkylating agents, a coordination compound is assumed to form which subsequently readily ionizes according to the scheme:

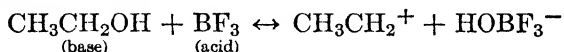

The positively charged organic radical then is assumed to react with the benzene and regenerate the boron trifluoride in the following steps:

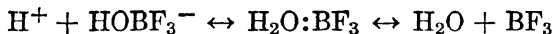
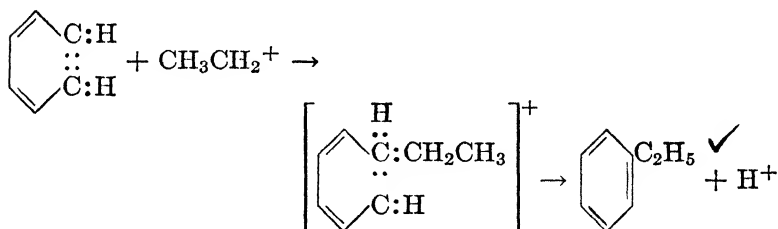

3. *Ethers.* The mechanism by which ethers alkylate organic compounds is assumed to be analogous to that assumed for alcohols. It may be represented as follows:

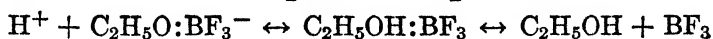
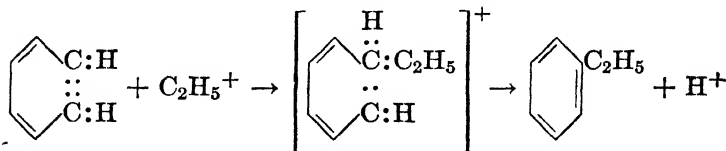
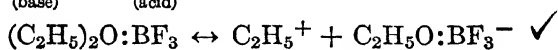
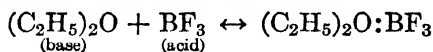

4. *Esters.* Esters are assumed to alkylate benzene in a manner similar to that proposed for alcohols and ethers except that isomerization is assumed to occur with the positive ion as shown in equation *d*.

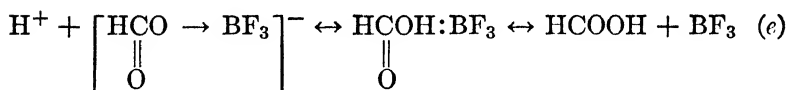
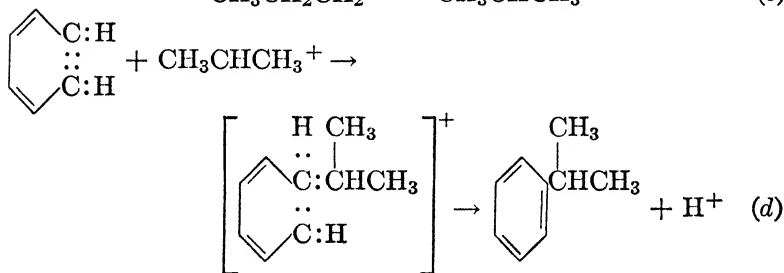
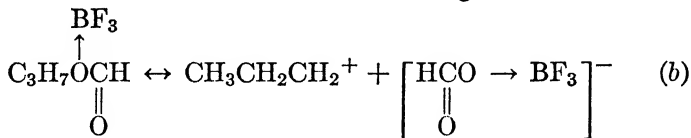
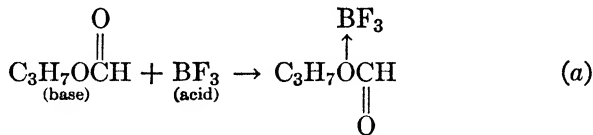

Paraffinic Hydrocarbons. Hydrocarbons containing a tertiary carbon atom, for example, isobutane^(239, 871) or isopentane, are alkylated by gaseous olefins, for example, ethylene, propylene, 1-*n*-butylene or 2-*n*-butylene, under the conditions^(846a) depicted in Table 39. It was found that optimum results were obtained when binary olefinic mixtures of the above were used.

Isobutane has been alkylated with ethylene using boron trifluoride as a catalyst while simultaneously isomerizing in the reaction zone a normal paraffin having at least 5 carbon atoms.⁽²⁰⁰⁾

Polymers of propylene have been alkylated with isobutane using boron trifluoride as catalyst to yield isoparaffins boiling in the gasoline range.⁽³²⁴⁾ Similarly, viscous polymers of normal olefinic hydrocarbons have been alkylated with isobutane to produce a viscous alkylate of low residual saturation.⁽⁶⁸⁹⁾

TABLE 39

CONDITIONS FOR ALKYLATION OF A TERTIARY CARBON ATOM BY
GASEOUS OLEFINS

Catalyst	°C.	Pressure in Atmos- pheres	Reference
BF ₃	841
BF ₃ ·H ₂ O	20	Ca. 10	117, 118, 894a
Satd. aq. soln. of BF ₃	1.7 to 26.7	3.4 to 6.8	592, 844
BF ₃ + H ₂ O + HF	735, 811, 846
BF ₃ + H ₂ O + Ni	20 to 25	48.4	424, 425, 427
BF ₃ + HF + Ni	429, 911
BF ₃ + HF	-50 to +50	325, 810, 912
BF ₃ + Cl ₂ or Br ₂	885b
BF ₃ + alkyl halide or acid-treated clays	841
BF ₃ + H ₂ SO ₄	-40 to 20	Ca. 10	478, 894a
BF ₃ + HSO ₃ F	10 to 50	10 to 100	433
BF ₃ ·H ₃ PO ₄	20 to 60	6.8 to 10	75, 479, 782, 841, 894a
BF ₃ + KHF ₂ or NaHF ₂	516
BF ₃ ·(C ₂ H ₅) ₂ O	20	Ca. 10	894a
BF ₃ ·C ₂ H ₅ OOCCH ₃	894a
BF ₃ ·CH ₃ COOH	894a
BF ₃ ·C ₅ H ₅ N	894a
BF ₃ ·H ₄ P ₂ O ₇	894a

Amylene will also alkylate isobutane. The catalyst is boron trifluoride and hydrogen fluoride.⁽⁶⁶⁰⁾ Higher isoparaffins may be alkylated similarly with higher hydrocarbons.^(314, 340, 433, 661, 702, 768, 872, 874)

The reaction of isobutane with unsaturated hydrocarbons resulting from cracking stills has been used to refine the liquid cracking products⁽³¹³⁾; nitrohydrocarbons have been used in such cases as solvents.⁽⁶⁹⁶⁾

In the alkylation of a low-boiling isoparaffin with a low-boiling olefin, deterioration of the catalyst has been minimized by introducing some hydrogen.⁽⁸⁷³⁾

Isopentane may be alkylated by ethylene at 150°C. and at a pressure not exceeding 50 atmospheres with a catalyst of BF₃ + HF + Ni.^(425, 427)

Methylcyclopentane and methylcyclohexane are alkylated by ethylene using boron trifluoride as the catalyst.⁽⁴³²⁾ A cycloparaffin of less than 5 C atoms can likewise be alkylated.⁽⁴³⁰⁾

Alkylated cyclohexane hydrocarbons result from the reaction of methylcyclopentane with propylene at a temperature between -20° and $+200^{\circ}\text{C}.$, using a catalyst comprised of boron trifluoride and hydrogen fluoride at a pressure usually not more than 35 atmospheres.^(718, 719)

Liquid paraffins boiling between 50 and $300^{\circ}\text{C}.$, diluted with an equal weight of CCl_4 , condense with the same weight of olefin in the presence of boron trifluoride.⁽⁴¹²⁾ By a similar process, liquid or gaseous olefins condense in the absence of CCl_4 .⁽⁴⁴²⁾

Alkanoic acids have been made by reacting an isoparaffin hydrocarbon with an unsaturated aliphatic carboxylic acid in the presence of boron trifluoride.⁽⁷⁷⁵⁾

Alkyl fluorides have been alkylated with an isoparaffin in the presence of hydrogen fluoride and boron trifluoride.⁽²³⁸⁾

No alkylated product could be isolated when nitromethane was mixed with *i*-propyl ether or *t*-butyl alcohol in the presence of boron trifluoride.⁽²⁾

Foster⁽²⁷⁰⁾ has recently made a study of the catalysts, including boron trifluoride, which are employed in hydrocarbon alkylation reactions.

Alkyl Esters. β -keto esters are alkylated by alcohols and ethers in the presence of boron trifluoride. Ethylacetoacetate is alkylated by *i*-propyl, *t*-butyl, and cyclohexyl alcohols in this manner. No alkylated product could be isolated when *n*-butyl, *i*-butyl, or *s*-butyl alcohols were used. Ethylacetoacetate is also alkylated by *i*-propyl, ethyl-*t*-butyl and dibenzyl ethers. No product was isolated when ethyl or *n*-propyl ethers were used. By a similar reaction ethyl- α -methylacetoacetate is alkylated by *i*-propyl ether. No alkylated product could be isolated when ethyl benzoylacetate was mixed with *i*-propyl alcohol or ethyl or *i*-propyl ethers; when ethyl- α ,*i*-propylacetoacetate was permitted to react with *i*-propyl ether; nor when ethyl malonate was mixed with *i*-propyl ether or *t*-butyl alcohol.^(2, 341, 343)

Ethylacetoacetate is alkylated by benzyl chloride to ethyl- α -benzylacetoacetate with boron trifluoride as catalyst.⁽¹⁰⁹⁾

If the above ester is chilled with isopropyl acetate and the mixture saturated with boron trifluoride, upon hydrolysis ethyl- α -isopropylacetoacetate forms.⁽¹¹⁰⁾

Aromatic Hydrocarbons. Aromatic compounds and olefins react in the presence of boron trifluoride at temperatures between 149 and 260°C. (721, 773) under normal or increased pressure. (160) Hydrogen fluoride, (161) an acid fluoride, (518) and fluosulfonic acid (433b) have been found to be assistants in this reaction. With hydrogen fluoride and boron trifluoride, 1,4-butylene glycols, their dehydration products or their 1,4-halogen analogs react with aromatic compounds to yield alkylation products. (123)

$\text{BF}_3 \cdot (\text{H}_2\text{O})_{1.1-2}$ is an effective catalyst for alkylation of aromatic compounds with alcohols or with olefins and diolefins. (22, 23) Sulfuric acids and benzene sulfonic acid have been used as assistants in this reaction. (364)

In the presence of boron trifluoride as a catalyst, a mixture of polymerized olefins is alkylated with acids of the general formula AXRCOOH , in which A is a mono- or polynuclear aromatic residue, X is hydrogen, oxygen, or sulfur, and R is a hydrocarbon or aliphatic radical, the carbon chain of which is at least once interrupted by oxygen, to yield nuclear alkylated aromatic compounds such as tetradecylphenoxyacetic acid. (31, 406)

Dihydroxyfluoboric acid or its coordination compound with boron trifluoride may be used in the alkylation of aromatic hydrocarbons. (666)

1. *Benzene.* Benzene resists the action of boron trifluoride. (282, 359) This is of interest since boron trifluoride promotes many alkylation reactions with benzene. A catalyst consisting of sulfuric acid and boron trifluoride may be used for the condensation of ethylene with benzene to produce mono- and diethyl benzene. (960) Ethylene also alkylates benzene in the presence of boron trifluoride and a trace of water at 20–25°C. in a nickel autoclave. (428)

Under a pressure sufficiently great to keep ethylene in the liquid state, benzene is alkylated in the presence of boron trifluoride and water of the approximate composition of $\text{BF}_3 \cdot \text{H}_2\text{O}$. Propylene reacts in an analogous manner. (119)

Mono-, di-, tri-, and tetraisopropyl derivatives of benzene are prepared by the condensation of propylene with benzene. Boron trifluoride promotes the formation of *p*-diisopropyl benzene. Boron trifluoride does not catalyze the alkylation unless an acid, such as sulfuric acid, is present. (795, 809, 960) Attempts to add propylene to 1,2,4,5-tetraisopropylbenzene in presence of boron trifluoride and anhydrous hydrogen chloride at 160°C. and 90 atmospheres pressure result in the formation of carbon. (461)

High yields of monoalkylated benzene are obtained by allowing benzene to react with propene, 2-butene, isobutene, 2-pentene, or butadiene in the presence of an addition compound of boron trifluoride and orthophosphoric acid.^(24a)

Orthodichlorobenzene is catalytically isopropylated with isopropyl alcohol by means of boron trifluoride with phosphorus pentoxide as a promoter; under the same conditions benzene yields 50% cumene.⁽⁹²¹⁾

3-Hexene condenses with benzene to produce 3-phenylhexane. The catalyst for this condensation is dihydroxyfluoboric acid.⁽⁸³³⁾

Cyclohexene condenses with asymmetrical diphenylethane in the presence of boron trifluoride to give products which are mixtures of the derivatives of *uns*-diphenylethane in which one or both of its phenyl nuclei are substituted by one or more cyclohexyl groups.⁽⁸¹²⁾

Benzene may be alkylated with alcohols, or with ethylene chloride⁽¹⁷⁸⁾ in the presence of boron trifluoride, but it is not effective as a catalyst in causing CH_3Cl to react with benzene.⁽⁹⁵⁵⁾

Pure toluene may be prepared from a petroleum-oil fraction, boiling between 78 and 84°C., and methanol, using boron trifluoride as the catalyst.⁽⁸²¹⁾ Propyl, *i*-propyl, butyl, *s*-butyl, *i*-butyl, *t*-butyl, allyl, cyclohexyl and benzyl alcohols, react with benzene in the presence of boron trifluoride, yielding mainly the *para*, with lesser quantities of the *ortho*, diderivatives.^(568, 795)

Using phosphorus pentoxide, sulfuric acid, and benzene sulfonic acid as "assistants" for boron trifluoride, benzene and alkylbenzenes are alkylated by normal and secondary alcohols to give secondary alkylbenzenes and by iso- and tertiary alcohols to give tertiary alkylbenzenes. The dialkyl compounds are *para*. Attempts to methylate and ethylate these compounds were unsuccessful. Propyl, isopropyl, butyl, isobutyl, secondary butyl, tertiary butyl, amyl, octyl, and dodecyl alcohols react in this manner.^(356, 896, 942) With *d*-*sec*-butyl alcohol and benzene in the presence of boron trifluoride *l*-*sec*-butylbenzene is produced.⁽⁷²³⁾

Halogenated derivatives of abietic or related acids may be condensed with benzene, xylene, naphthalene, diphenyl ether, anthracene, phenanthrene, chrysene, or fluorene at or above room temperature in a solvent such as kerosene, high-boiling naphtha, nitrobenzene, carbon disulfide, tetrachloroethane, dichlorobenzene, carbon tetrachloride, or chloroform.⁽⁵¹⁰⁾

Substituted benzenes or naphthalenes whose substituent is an alkyl, aryl, aralkyl, hydroxy, alkoxy, hydroxyalkoxy, aryloxy, keto, or acid amide, containing between 8 and 15 carbon atoms, are alkylated by an olefin sulfonic acid or sulfonate, such as sodium propylene sulfonate, sodium isobutylene sulfonate, propylene sulfonic acid or isobutylene sulfonic acid, using boron trifluoride as the catalyst.^(724a, 881)

Various ethers, in the presence of boron trifluoride, alkylate benzene. The normal ethers produce secondary alkylbenzenes whereas isoethers give tertiary alkylbenzenes. The dialkylated products are the *para* derivatives. Thus the following alkylbenzenes are prepared: ethyl-, diethyl-, isopropyl-, diisopropyl-, benzyl-*n*-propyl-, secondary amyl-, secondary diamyl-, tertiary amyl-, tertiary diamyl-, benzyl-, and dibenzylbenzenes.^(636, 677)

Benzene may be alkylated by esters, using boron trifluoride as the catalyst. Normal and secondary butyl acetates, formates, and phosphates produce secondary butylbenzene. Isobutyl formate gives tertiary butylbenzene. Propyl and isopropyl acetates, formates, sulfates, and trichloroacetates form isopropylbenzene. The yield of alkylated benzene is directly proportional to the quantity of boron trifluoride used and to the time of heating.^(669, 795)

It has been found that boron trifluoride is unnecessary for the alkylation of benzene if sulfuric acid is present.⁽⁴²⁶⁾ Monoalkylbenzenes, such as *sec*-butylbenzene, are alkylated by olefins, such as the butylenes, in the presence of a catalyst made up of boron trifluoride and orthophosphoric acid at a temperature of 32.2 to 37.8°C. under a pressure sufficiently great to keep the hydrocarbons in the liquid state, thus producing polyalkylbenzenes.⁽⁷⁸³⁾ It is interesting that boron trifluoride does not promote the migration of the alkyl groups. Also, in reactions such as the production of mono- and dibutylbenzenes from benzene and butylene, better control of the desired reaction is obtained with dihydroxyfluoboric acid than with boron trifluoride.⁽⁶⁶⁹⁾

Boron trifluoride, or one of its coordination compounds, has been used as a catalyst for the alkylation of hydrocarbons, for example, benzene or toluene or their derivatives, with secondary, tertiary, or allyl-type halides in the Friedel-Crafts synthesis.^(359, 385)

Shen and Wood have written a review of the principal methods of alkylating benzene including the use of boron trifluoride.⁽⁷⁹⁵⁾ Luder and Zuffanti^(561a) have summarized the theories proposed

for the catalysis of benzene alkylations with boron trifluoride from the acid-base viewpoint.

2. *Toluene*. Toluene is alkylated by cyclohexyl fluoride using boron trifluoride as a catalyst.⁽¹⁶⁵⁾

3. *Xylenes*. Orthoxylene forms 1,2-dimethyl-4-*t*-butylbenzene in the presence of boron trifluoride and *t*-butyl alcohol. Paraxylene under the same conditions formed a product which could not be isolated.⁽⁶⁷¹⁾ Metaxylene in the presence of boron trifluoride reacts with *t*-butyl and *t*-amyl alcohols to form abnormally oriented products, such as 1,3-dimethyl-5-*t*-butylbenzene. With *s*-butyl alcohol, *m*-xylene forms 1,3-dimethyl-4-*s*-butylbenzene.⁽⁶⁷²⁾

4. *Phenol*. Gasselin found that "monoatomic" phenols were not attacked by boron trifluoride but that resorcinol was polymerized and dehydrated.⁽²⁸²⁾

The alkylation of phenols or cresols by gaseous or liquid olefins at high temperatures and pressures may be promoted by boron trifluoride.^(386, 387, 848b)

Phenol is alkylated by methyl, ethyl, propyl, isopropyl, isobutyl, and *t*-butyl alcohols in the presence of boron trifluoride.^(570, 822) Similarly, benzyl-*n*-propyl ether alkylates phenol.⁽⁶³⁶⁾

Diisobutylene condenses with phenols in the presence of boron trifluoride to produce $\alpha,\alpha,\gamma,\gamma$ -tetramethylbutylphenols.⁽⁶⁶²⁾

The use of boron trifluoride is an improvement over that of aluminum chloride in the direct alkylation of phenol by cyclohexene and leads to the following products: *p*-cyclohexylphenol and *o*-cyclohexylphenol.⁽⁴⁹⁷⁾ Di- and tricyclohexylphenol also are products of this reaction.⁽⁴⁹⁸⁾ At low temperatures (0° for 40 minutes in the presence of benzene) phenoxycyclohexane was first obtained which later rearranged to cyclohexylphenols.⁽⁴⁹⁹⁾

Phenol is alkylated with tertiary butyl mercaptan, using boron trifluoride as catalyst yielding *p*-tertiary butylphenol. Primary and secondary mercaptans do not react.⁽⁵⁸²⁾

3-Hexene condenses with resorcinol to produce *s*-hexylresorcinol.⁽⁸³³⁾ Dihydroxyfluoboric acid is used as the catalyst.

Monomeric or polymerized acyclic terpenes, such as alloocimene, ocimene, or myrcene, condense with a phenol, such as phenol, cresol, 1-naphthol or chlorophenol, in the presence of 0.5 to 2% of boron trifluoride with or without an inert solvent, to produce a resinous product having a hydroxyl content between 2 and 4%.⁽⁵¹⁹⁾

5. *Halobenzenes*. Boron trifluoride with phosphorus pentoxide

as an adjunct is an effective catalyst in the condensation of alcohols with chloro-, bromo-, and iodobenzenes. Satisfactory yields are obtained of the following *p-s*-alkylhalobenzenes: (2-*p*-chlorophenyl)-propane, -butane, -pentane, -octane; (2-*p*-bromophenyl)-propane, -butane, -pentane; (2-*p*-iodophenyl)-butane, pentane; *p*-chlorophenylcyclohexane; 3-*p*-chlorophenylpentane.⁽³⁶²⁾

6. *Alkyl Phenyl Ketones*. Acylation of *o*-, *m*-, and *p*-nitroacetophenones was accomplished with yields of 66 to 95% of the corresponding $O_2NC_6H_4COCH_2Ac$ by saturating their solution in acetic anhydride at 0°C. with boron trifluoride, followed by addition of a 13% solution of sodium acetate and refluxing for 20 minutes.⁽⁹³³⁾

7. *Aryl Hydroxy Fatty Acids*. Such acids may be alkylated with olefins of the general formula C_nH_{2n} of at least 4 carbon atoms per molecule at temperatures below 100°C. and at ordinary pressures using boron trifluoride or its coordination compounds as catalysts.⁽⁴²²⁾

8. *Naphthalene*. Monoolefins, for example, ethylene and propylene, condense with aromatic compounds, for example, naphthalene, in the presence of boron trifluoride⁽³⁸⁸⁾ or of one of its coordination compounds with water, alcohols, acetates, or orthophosphoric acid.⁽⁴¹⁰⁾

The alkylation of naphthalene by alcohols in the presence of boron trifluoride produces β -alkyl derivatives. Phenol, however, gives an α -alkyl derivative.^(24a, 722) Naphthalene also is alkylated by benzyl-*n*-propyl ether in the presence of boron trifluoride.⁽⁶³⁶⁾

9. *Steroids*. Steroids such as those which are constituents of the adrenal cortex, such as the 17-hydroxy-20-keto steroids, have been acetylated using acetic acid, acetic anhydride, red mercuric oxide, and boron trifluoride-etherate^(797, 798, 799, 800, 801). See Table 39 which summarizes these acetylations.

POLYMERIZATION

Ethylene. In 1873 Butlerow and Gorainow reported that ethylene was not polymerized by boron trifluoride when heated up to and exceeding 175°C.^(188, 315) Six years later Landolph reported that ethylene fluoboric acid, $C_2H_4 \cdot HF \cdot BO_2$, was produced by ethylene and boron trifluoride at 25 to 30°C. in the sunlight. The acid on hydrolysis gave a volatile compound which Landolph thought might be ethyl fluoride.^(482, 486, 487)

Counciler called attention to the fact that $C_2H_4 \cdot HF \cdot BO_2$, reported by Landolph, could not be obtained from the reaction of ethylene and boron trifluoride. He suggested that Landolph might have missed a hydrogen atom and that the compound

should be $\begin{array}{c} \text{F} \\ | \\ \text{B}-\text{OH} \\ | \\ \text{OC}_2\text{H}_5 \end{array}$ due to the action of water on ethylene and boron trifluoride.

Thus:

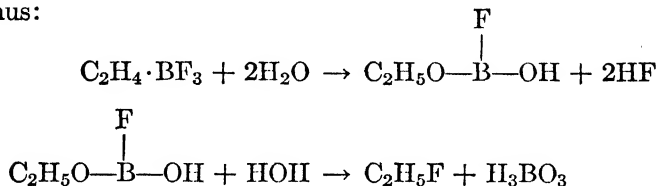

This mechanism explained the formation of the ethyl fluoride reported by Landolph.⁽¹⁸⁵⁾

Gasselin in 1893 reported that boron trifluoride did not react with pure ethylene. He explained Landolph's compound $C_2H_4 \cdot HF \cdot BO_2$ as being due to the compound $(C_2H_5)_2O \cdot BF_3$ which resulted from $(C_2H_5)_2O$ present in the ethylene.^(282, 288)

A compound between ethylene and boron trifluoride has never been isolated. However, such a coordination compound is postulated as an intermediate compound formed in certain reactions catalyzed by boron trifluoride.^(298, 561a, 721, 724) However, Booth⁽⁸⁸⁾ found that ethylene and boron trifluoride at -110°C . polymerize to form a tarry mass.

In general, ethylene polymerizes under increased pressure by the use of boron trifluoride alone, if the ethylene is dry, or by boron trifluoride and hydrogen fluoride if it is wet.^(656, 681, 956) Other catalysts which are used consist of $BF_3 \cdot H_2O$ and $BF_3 \cdot 2H_2O$,^(414, 564, 848) the dialcoholate or diacetylate,⁽⁴¹⁴⁾ boron trifluoride and hydrogen iodide,⁽⁶⁵⁶⁾ boron trifluoride and nickel powder,^(413a, 423, 427, 681) boron trifluoride and nickel powder on Kieselguhr,⁽⁴⁶¹⁾ boron trifluoride and fluosulfonic acid,^(433a) and boron trifluoride and an acid fluoride of a metal.⁽⁶¹⁹⁾

Butylene results from the careful polymerization of ethylene for a sufficiently short time so that the polymerization does not carry beyond butylene. The conditions for this polymerization

are 8 to 15°C., 50 to 60 atmospheres pressure and a catalyst of boron trifluoride and nickel powder; the latter may or may not require a carrier.^(413a, 441, 683, 684) If the time is not sufficiently short, isobutylene or higher polymers result.⁽³⁷³⁾

When the polymerization of ethylene is permitted to proceed for a longer time interval at pressures of 70 to 130 atmospheres, and at room temperature, with boron trifluoride as a catalyst, oily products are obtained.^(168, 315, 375, 379, 385, 682)

Ethylene has been freed from propylene⁽⁹⁸²⁾ by selectively polymerizing the latter by bringing the gaseous hydrocarbon mixture into contact with a solution of 5–50% boron trifluoride in 40–85% sulfuric acid at 50 pounds per square inch at 15 to 49°C.

Propylene. In 1877 Butlerow reported that propylene in the presence of boron trifluoride did not give the dimer or trimer but that products of a higher order were produced.^(166, 168, 315) Egloff⁽²³⁷⁾ reported that boron trifluoride at room temperature favored the polymerization of propylene into trimers and higher polymers.^(298, 620, 324) Nickel powder sometimes is used with boron trifluoride for the polymerization of propylene.⁽⁶⁸¹⁾ The polymers of higher order which result from propylene are of an oily nature.^(401, 682) $\text{BF}_3 \cdot \text{H}_2\text{O}$ and $\text{BF}_3 \cdot 2\text{H}_2\text{O}$ serve satisfactorily for the polymerization of propylene at a temperature between -20 and 40°C . and under a pressure of 1 to 50 atmospheres.^(37, 414, 564) Boron trifluoride dialcoholate and diacetylolate⁽⁴¹⁴⁾ and boron trifluoride with an acid fluoride of a metal⁽⁵¹⁹⁾ also have been used.

When propylene and boron trifluoride are condensed together at -110°C ., immediate polymerization to a tar results.⁽⁸⁸⁾

In the reaction between propylene and $2\text{CH}_3\text{OH} \cdot \text{BF}_3$ polymerization products of propylene form along with the desired product, methyl isopropyl ether.⁽⁵⁸⁹⁾

Using boron trifluoride with or without hydrogen fluoride as catalysts, propylene is copolymerized with alkapolyenes in which one or more hydrogen atoms are replaced by such polar groups as NH_2 , Cl, Br, S, COOH , NO_2 , OH, and so forth (for example, geraniol and chloroprene).⁽⁶⁷⁶⁾

A monoolefinic halide, for example, allyl chloride or β -methylallyl chloride, containing an olefinic linkage between 2 carbon atoms, one of which is linked directly to a saturated carbon atom having in turn the halogen linked directly to it, and containing not more than 15 carbon atoms, polymerizes in the liquid phase in

the presence of boron trifluoride under substantially anhydrous conditions at -80° to -50°C . in the presence of comminuted metallic copper, platinum, palladium, iron, cobalt, or nickel.⁽⁴⁾

Tetraallylsilane may be polymerized by heating between 50 and 200°C ., using boron trifluoride as the catalyst. The polymerization may be carried out in an organic solvent such as toluene.⁽⁴⁷³⁾

Butylene. Butylene is polymerized, in presence of boron trifluoride, to produce unsaturated compounds of higher molecular weight.^(620, 675) Similarly, liquid hydrocarbons are produced.⁽²⁹⁸⁾ Boron trifluoride dihydrate, dialcoholate, and diacetylate are also good catalysts for this reaction.⁽⁴¹⁴⁾

Butylene is copolymerized also with alkapolyenes in which one or more hydrogen atoms are replaced by polar groups such as NH_2 , Cl , Br , S , COOH , NO_2 , OH , and so forth, using boron trifluoride with or without hydrogen fluoride as a catalyst.⁽⁶⁷⁶⁾

Isobutylene. Polymerization of isobutylene using boron trifluoride as a catalyst may be carried out at temperatures ranging from below -10 to $+100^{\circ}\text{C}$.^(298, 651, 686, 719c, 835, 941) With dry isobutylene, the polymerization in the presence of boron trifluoride is most efficient at 30°C ., whereas with wet isobutylene a temperature of 100°C . is required.⁽⁷⁹¹⁾ Tertiary butyl alcohol^(252a) has a marked accelerating action on the reaction.

Although it has been claimed that the presence of a third component, probably water, is necessary for the polymerization of isobutene and diisobutene by boron trifluoride,^(252, 253) it has been found recently that, even when extreme care was used to maintain anhydrous conditions, isobutene was polymerized at -80° , the polymerization beginning in the gas phase. When ethylene was used as a solvent at -102° the polymerization took place in the liquid phase.^(395a) A possible theory of the mechanism of the reaction is that the π electron pair of the olefin is fixed by the catalyst at one of the 2 C atoms of the double bond, through which a dipole is formed, which attracts other monomeric molecules resulting in the formation of products with high molecular weights.^(395a)

Selective polymerization is reported for the polymerization of isobutylene in a mixture of other polymerizable gases. Boron trifluoride is used as a catalyst at temperatures between -10° to

+100°C. Contact between the catalyst and the gaseous mixture is sufficiently long to polymerize only the isobutylene.^(650, 662)

By precooling isobutylene to -80°C. before the introduction of boron trifluoride, the polymerization may be controlled so that polybutenes are obtained as products.⁽⁸⁸⁹⁾

To obtain a product containing a considerable quantity of triisobutylene, a hydrocarbon reactant containing a large amount of isobutylene is allowed to react with boron trifluoride for less than 1 second.^(848a) The reactant and the catalyst are both in the gaseous state at a temperature between 100 and 150°C. The reaction product is brought into contact with a substance which instantly inactivates the catalyst.⁽³⁸⁾

Trimethylcarbinol results from the polymerization of isobutylene at ordinary temperatures with boron trifluoride as the catalyst; a fraction whose vapor density corresponds to $C_{12}H_{24}$ is also obtained.^(168, 315) By carrying out the reaction at above 5000 pounds per square inch under the same conditions, a high-molecular-weight resin is obtained.⁽⁴⁷⁴⁾ A high-viscosity polymer has been produced by carrying out the reaction at 300 pounds per square inch.⁽¹⁵¹⁾

Oily products are obtained when isobutylene is polymerized at its boiling point by boron trifluoride.^(682, 889) In the presence of hydrogen chloride, diisobutylene is obtained.⁽⁵⁷¹⁾ At ordinary temperature, oils are produced when the catalyst is either boron trifluoride alone, or boron trifluoride with nickel metal.⁽⁶⁸¹⁾ $BF_3 \cdot H_2O$ and $BF_3 \cdot 2H_2O$ also polymerize isobutylene at increased pressures.^(414, 564)

High-molecular-weight polymers are produced by treating isobutylene with boron trifluoride at temperatures between -80 and -10°C.^(574, 852, 973) A catalyst comprised of boron trifluoride and hydrogen fluoride may be used.⁽⁴⁰⁸⁾ To control the temperature, the reaction may be carried out in a diluent which boils at the desired polymerization temperature, preferably below -6°C.⁽³⁶⁾ Ethylene or propylene,^(248a, 685) olefins of 3 to 5 C atoms,⁽⁶⁸⁷⁾ propane,⁽⁵⁷³⁾ butanes and normal butylenes,⁽¹³⁾ and chloroform^(847a) have been proposed as such solvents. An accurate temperature gradient has been maintained by film polymerization: A fine spray of liquid monomer is directed against a refrigerated rotating drum surrounded by a countercurrent of vaporous catalyst,⁽⁹²⁸⁾ or sprayed in a mist into an atmosphere of vaporous catalyst.⁽⁸⁰³⁾

The degree of polymerization of the isobutylene has been controlled by the use of organo-oxy compounds as solvents for the monomer which are not solvents for the specific polymer desired. Examples are alcohols, ketones, ethers, esters, monocarboxy acids, and phenols.⁽⁸⁰⁵⁾ Purification of such resinous polymers has been accomplished⁽⁹²³⁾ by dissolving the resin in a liquefied normally gaseous hydrocarbon and heating to the region of its critical point to precipitate the resin.

A substance, such as a chlorinated isobutylene monomer, when saturated with boron trifluoride and polymerized for 9 days at about -62°C ., produces a chlorinated polymer of rubber-like character.⁽⁹²⁹⁾

A plastic hydrocarbon resin with a molecular weight above 800 is produced from liquid isobutylene and boron trifluoride at a low temperature.⁽¹⁴⁾ An elastic solid polybutene having a molecular weight above 60,000 is obtained at temperatures between -100° and -40°C .⁽⁹¹³⁾

In order to assist in maintaining a low temperature for the polymerization of isobutylene to viscous resins or rubber-like solids, a boron trifluoride complex with acetyl chloride, chloral, phosphine, or succinic anhydride is used. In such a complex the concentration of boron trifluoride is very low. It is suggested that the complex acts to reduce the number of active isobutylene molecules in the reaction mass and thus control the reaction. Diluents such as ethane, propane, or butanes are used, and the reaction proceeds at temperatures between -90 and -50°C .⁽⁷⁶⁵⁾

High-molecular-weight polymers are obtained by the reaction between isobutylene and boron trifluoride in inert noncomplex-forming diluents at temperatures between -45 and -10°C . Diluents used are ethane, ethylene, propane, butane, and their mixtures, ethylene, ethyl chloride, methyl chloride, carbon tetrachloride, carbon disulfide, and naphtha.^(16, 35, 647, 762, 808, 834, 836, 847) Dimers and trimers are obtained by such a reaction along with the high-molecular-weight products.⁽³⁵⁾ The foregoing reaction may be carried out at temperatures as low as -150°C .⁽⁸³⁶⁾ A catalyst comprised of boron trifluoride and hydrogen fluoride may be used with a diluent such as pentane.⁽⁴⁰⁸⁾

Isobutylene is polymerized below -10°C . with the aid of a catalyst such as boron trifluoride in the presence of not over 0.5%

of monohydric alcohols.⁽⁴²¹⁾ Boron trifluoride dialcoholate and diacetylate are effective catalysts also.⁽⁴¹⁴⁾

It has been found that the polymerization of isobutylene at the temperatures of solid carbon dioxide yields products having a molecular weight of 20 to 30% higher if about 0.1% of an aliphatic ether is added.⁽³⁹⁰⁾ In the presence of boron trifluoride-ether complex, isobutylene is easily polymerized in the liquid or gaseous phase to give a 90 to 95% conversion to a polymer comprised of 26% dimer, 65% trimer, and a small amount of residue boiling above 180°C.^(248a, 395)

A polymer precipitated upon, and mixed with, sulfur particles is obtained by the polymerization of one or more olefins, such as isobutylene, in the presence of finely divided elemental sulfur. The sulfur must be free from acidic, metallic, or organic compounds (especially oxygenated organic compounds), and from substances which form complex salts with the catalyst, boron trifluoride. The reaction temperature is below -40°C.⁽⁸⁴⁵⁾

Lubricating oils are produced by the polymerization of isobutylene in the presence of an appreciable quantity of a liquid capable of acting as an active poison to the polymerization, for example, polymers of isobutylene of low molecular weight. The operating temperature is between -10°C. and room temperature, with boron trifluoride as the catalyst.⁽⁸⁵³⁾

Polyisobutylene is made by the reaction of boron trifluoride upon isobutylene at -100°C. in the presence of an aromatic organic compound containing -XH attached to its ring, where X = O, S, Se, or Te. Substituted tertiary amyl phenols serve very well.⁽⁸³⁷⁾

Products resembling polyisobutylene, of low molecular weight are prepared from isobutylene, alkylacetylenes, petroleum ether, and boron trifluoride at -82°C.⁽³⁹⁷⁾

A mixture of 25% monovinylacetylene and 75% isobutylene copolymerizes at -78°C. in the presence of 1% of gaseous boron trifluoride producing a vulcanizable isobutylene-movinylacetylene synthetic rubber.⁽²⁰⁶⁾

Copolymerization of isobutylene with alkpolyenes in which one or more of the hydrogen atoms are replaced by polar groups such as NH₂, Cl, Br, S, COOH, NO₂, and OH occurs with boron trifluoride with or without hydrogen fluoride as catalysts.⁽⁶⁷⁶⁾ Copolymers of molecular weights above 800 result from isobutyl-

ene and a hydrocarbon having a conjugated system of alternate single and double bonds, such as butadiene, isoprene, styrene, below 0°C., using boron trifluoride as the catalyst.^(814, 840) With butadiene at -150 to -50°C., isobutylene in the presence of boron trifluoride in a solvent such as methyl or ethyl chloride⁽⁵⁸⁾ forms a copolymer.

Applications of Polyisobutylenes. The products of the polymerization of isobutylene by boron trifluoride, have found their chief uses as additives for lubricating oils to raise their viscosity index.^(522, 524, 804, 863, 925)

They have been used to coat rubber-pneumatic equipment to reduce the rate of diffusion of gases through the rubber,⁽⁹²⁷⁾ to moisture-proof sheets of regenerated cellulose,^(65, 926) to line metal food containers,⁽⁹²⁴⁾ to cold-bond waxy surfaces,⁽¹⁴¹⁾ and as a bodying agent in printing inks.⁽³⁷⁰⁾

Chlorinated isobutylene polymers have flame-resisting properties as waterproof coatings.^(15, 404)

Other Olefins. In general, olefins are polymerized by boron trifluoride, at temperatures ranging from -128 to 370°C. and under pressures varying from 1 to 34 atmospheres.^(166, 167, 173, 296-298, 374-376, 395, 737a, 849) An excess of catalyst may be used,⁽⁴⁷⁵⁾ and step-wise polymerization has been achieved.⁽⁶⁴⁸⁾

The heat of polymerization of some olefinic compounds, in which boron trifluoride has been employed as a catalyst, has been used to melt obstructing deposits in oil wells.⁽⁸⁰⁶⁾

Polymers with molecular weights in excess of 800 and up to 200,000 are prepared from isoolefins at temperatures below 38°C. Boron trifluoride is the catalyst used.^(338a, 416a, 725, 835, 852)

At temperatures from -80 to 0°C., boron trifluoride produces copolymers, having molecular weights from 800 up to 200,000, from mixtures of aliphatic olefins of at least 2 carbon atoms, and another organic compound capable of polymerization such as butadiene, isoprene, styrene, vinyl esters and ethers, acrylates, diacetylene, aldehydes, eugenol, or saffrol.^(814, 840, 854) Chloroprene, geraniol, and acids from China wood oil also may be used with boron trifluoride with or without hydrogen fluoride as the catalyst.⁽⁶⁷⁸⁾

A diolefin or halogen-containing diolefin is polymerized by bringing it alone or with a different diolefin or halogen-containing diolefin, or a monoolefin, at a pressure of about 1 atmosphere and

at 0 to 250°C. in the presence of boron trifluoride alone or its mono- or dihydrate.^(229a, 737a)

Tough elastic products are obtained when cyclic diolefins are treated with boron trifluoride.^(420a)

High-molecular-weight polar compounds have been made by co-polymerization of olefins and polyolefinic polar compounds with boron trifluoride at 0°C.^(402, 403)

Mixtures of cracked hydrocarbons which contain olefins, iso-olefins, and diolefins in a diluent are polymerized by boron trifluoride at temperatures from -10 to 60°C. under pressure.^(376, 411, 418a) The diluent may be ethane, propane,⁽³⁸⁶⁾ pentane,⁽²⁰⁸⁾ ethylene dichloride,⁽⁴⁴⁵⁾ or benzene.⁽⁶⁰⁸⁾

Other catalysts besides boron trifluoride alone are used for the polymerization of olefins. Coordination compounds of boron trifluoride have been used successfully.⁽³⁷⁶⁾ A liquid catalyst composed of boron trifluoride and water has been reported to be efficient for olefin polymerization.^(37, 229a, 380, 382, 383, 414, 564) Polymerization of olefins has been effected also, using boron trifluoride with a promoter. The promoters used have been oxygen-containing compounds of aluminum, silicon, titanium, vanadium, chromium, manganese, iron, cobalt, and nickel, with aluminum silicates being preferred. The polymerization conditions were designated as 27°C. and 300 pounds per square inch.⁽¹⁶²⁾ Other effective olefin polymerization catalysts are boron trifluoride dialcoholate and diacetylate,⁽⁴¹⁴⁾ a mixture of boron trifluoride and a non-Friedel-Crafts catalyst,⁽⁴⁹⁰⁾ boron trifluoride with hydrogen halides,^(380-383, 571) boron trifluoride with alkyl and aryl halides,^(58, 380, 381, 383) and boron trifluoride in the presence of a finely divided metal, such as nickel.^(374, 375, 377, 423, 425, 427)

Landolph in 1879 thought he obtained a fluoboric acid, $B_2O_7H_4 \cdot 3HF$, from amylene and boron trifluoride. More recent work has shown that the di-, tri-, and tetramers of amylene or polymers of higher molecular weight, are produced by boron trifluoride.^(282, 620, 682) Using boron trifluoride dihydrate, dialcoholate, or diacetylate as catalyst, products such as pentadecylene are obtained.^(37, 414)

Isoamylene is polymerized below -10°C. by boron trifluoride, producing a polymer of a molecular weight of 1000 to 200,000.⁽⁸⁵²⁾ Using boron trifluoride etherate with isoamylenes in the liquid phase a yield of 80% of the polymer was obtained. In the gaseous

phase a 90% yield of the polymer resulted. The polymer was primarily the trimer.⁽⁸⁹⁵⁾

Cyclopentene in the presence of boron trifluoride or boron trifluoride with hydrogen fluoride, is polymerized to di-, tri-, and tetracyclohexene polymers.⁽³⁷³⁾

The boron trifluoride-ether complex catalyzes the copolymerization of methylcyclopentadiene and cyclopentadiene.⁽⁹⁰⁷⁾

Hexylene is polymerized, if necessary in the presence of boron trifluoride, to produce di-, tri-, and tetramers⁽⁶⁸²⁾ and unsaturated compounds of higher molecular weight.⁽⁶⁷⁵⁾

Cyclohexene and methylcyclohexene are polymerized by boron trifluoride dihydrate, dialcoholate, or diacetylate to yield products such as pentadecylene and octadecylene.⁽⁴¹⁴⁾

Higher-molecular-weight olefins, such as 5-butyl-4-nonene and hexadecene, are polymerized by the action of boron trifluoride.^(78, 937) With a catalyst comprised of the dihydrate, dialcoholate, or diacetylate of boron trifluoride, nonylene and dodecylene are polymerized to compounds of the nature of octadecylene.⁽⁴¹⁴⁾

Vinyl Compounds. Vinyl compounds, such as vinyl acetate, vinyl bromide, or α -methyl bromoacrylic ester, are polymerized by boron trifluoride and its complexes.^(578b)

Vinyl alkyl ethers, such as isobutyl vinyl ether, or mixtures thereof with other polymerizable substances at temperatures between -90 and 10°C ., are polymerized by boron trifluoride alone or with one of its coordination compounds with acetyl chloride, chloral, phosphine, or succinic anhydride. A diluent such as ethane, propane, or the butanes may be present.^(443, 765) Isoamyl vinyl ether is polymerized by boron trifluoride to a sticky mass.⁽⁵⁵⁸⁾

Abietinol or abietinol vinyl ether is polymerized at temperatures between 150 and 250°C . in the presence of boron trifluoride or of one of its coordination compounds with ethers, alcohols, acids, or water.⁽⁹⁵⁶⁾

Monomeric vinyl ether is polymerized by spraying it into a chamber containing gaseous boron trifluoride to give a polymer of higher molecular weight and better color than can be obtained by bulk polymerization.⁽²⁵⁸⁾

Equal volumes of thiophene and a vinyl ester (either the acetate or the propionate) copolymerize in the presence of boron trifluoride.^(331a)

Vinyl chloride copolymerizes well with 2–4% of an unsaturated ether such as $(\text{CH}_2=\text{CHCH}_2)_2\text{O}$ at 40–60°C. in the presence of a mixed catalyst containing benzoyl peroxide and boron trifluoride.⁽⁵⁵⁹⁾

Hydropolymerization of Olefins. Olefinic hydrocarbons are transformed into hydrocarbons having more carbon atoms and a more saturated character by simultaneous treatment with hydrogen, a polymerizing agent such as boron trifluoride, and a hydrogenating catalyst chosen from the metal oxides and sulfides of Groups VI and VIII of the Periodic Table. The pressure is usually 100 atmospheres or less, and the temperature may vary. Temperatures of 300°C.,⁽⁹⁰⁹⁾ 275°C.,⁽⁴³¹⁾ 100°C.,⁽⁹¹⁰⁾ and room temperature⁽⁵⁶²⁾ have been used successfully. At 300°C., sulfuric acid may be used with boron trifluoride in place of the metal oxides or sulfides.

Dienes. Conjugated diolefins are polymerized in the presence of a boron trifluoride complex of an aliphatic monohydric alcohol. The polymerization is carried out in a large volume of an inert diluent at a temperature between –1 and +50°C.⁽⁷⁸⁴⁾

Diolefins and tertiary olefins may be copolymerized in the presence of boron trifluoride,⁽⁷⁷⁷⁾ as well as conjugated dienes and olefins.⁽⁶⁹³⁾ Under control, a mixture of isobutylene and diolefins has been separated by polymerization of the diolefins only.⁽⁸⁾

Butadiene, or similar compounds, are polymerized as a result of the presence of boron trifluoride alone,^(54a, 675, 682) of boron trifluoride and 1.25 mole of water,⁽³³⁷⁾ or of a boron trifluoride alcoholate or fatty acid complex, in which the acid contains 1 to 5 carbon atoms.^(784, 785) For the last polymerization catalyst, an inert diluent is used.

No polycyclopentadienes were obtained after passing boron trifluoride through cyclopentadiene for 15 minutes.⁽⁸⁵⁹⁾ However, cyclopentadiene or 1,3-cyclohexadiene are reported to react with a terpene, in a suitable solvent and in the presence of boron trifluoride and its complexes with ethers or acids, to form viscous liquids or solids.⁽⁶⁷⁹⁾ Gaseous boron trifluoride also catalyzes the polymerization of cyclopentadiene and its alkyl-substitution products at temperatures between –50 and +100°C. to produce benzene-soluble polymers. The concentration of the unsaturated compound is not permitted to be greater than 11% by weight, and

the proportion of the catalyst to the unsaturated compound is not allowed to exceed 10%.⁽⁹⁰⁶⁾

Terpenes. Higher-molecular-weight polymers are obtained by the action of boron trifluoride on terpenes.^(61, 682)

A terpene and cyclopentadiene or 1,3-cyclohexadiene, when dissolved in a suitable solvent, will polymerize, if boron trifluoride and its complexes with ethers or acids are present, to produce viscous liquids or solids.⁽⁶⁷⁹⁾

A solid copolymer of a terpene and isobutene is formed at -70 to 200°C . by the use of boron trifluoride as catalyst.⁽⁶⁸⁰⁾ Boron trifluoride catalyzes the copolymerization to a resinous product of a terpene with a compound of the general structure $\text{R}_1\text{R}_2\text{C}:\text{CR}_3\text{R}_4$.⁽⁷⁵³⁾ Likewise an acyclic terpene having 3 double bonds per molecule and a material having the general formula $\text{HR}_1\text{C}=\underset{\text{R}_2}{\text{C}}-\underset{\text{R}_3}{\text{C}}=\underset{\text{R}_4}{\text{CH}}$ are copolymerized with boron trifluoride at

from -60 to $+80^{\circ}\text{C}$. to yield an alkali-resistant resin.⁽⁷⁵⁹⁾

Light isoprene fractions are polymerized, with or without benzene, toluene, or xylene, in the presence of boron trifluoride at a temperature between -30 and $+70^{\circ}\text{C}$. The quantity of catalyst used is 0.1 to 5.0% by weight of the isoprene present.⁽⁸¹⁹⁾

Landolph in 1880 reported that boron trifluoride decomposed boiling anethol to produce anisol and anethol dihydride.⁽⁴⁸³⁾ Earlier he had reported that anethol was instantly polymerized by boron trifluoride at room temperature.^(480, 485) At higher temperatures he reported the formation of a complex fluoboric acid.⁽⁴⁸²⁾

Oil of citron was found by Berthelot in 1853 to absorb and to react with boron trifluoride.⁽⁶¹⁾

Turpentine is transformed by boron trifluoride to a viscous liquid which boils at 300°C .⁽⁶¹⁾ Terebene also absorbs boron trifluoride and does so without heating appreciably.⁽⁶¹⁾

Turpentine derivatives of a stable nonvolatile-oil type having a viscosity between 100 and 5000 cps. and a halogen content up to 12% are produced from a monohydric halide of a monocyclic terpene hydrocarbon between -50 and 200°C . for 1 to 60 hours in the presence of boron trifluoride.⁽¹⁰⁵⁾

Acyclic terpenes such as alloocimene, ocimene, or myricene are polymerized in the presence of boron trifluoride and an inert volatile solvent to produce liquid and solid polymers, the latter

having 70% of the polymeric constituents in a state higher than the dimer.⁽⁷⁵⁵⁾ Dipentene, α -pinene, β -pinene, limonene, terpinene, terpinoline, and alloocimene are polymerized by boron trifluoride to products which have a drop melting point up to 80°C.⁽⁶⁸⁸⁾ The acyclic terpenes are also copolymerized with a rosin, a rosin acid, a rosin ester, or a rosin acid ester at -40 to 150°C. by boron trifluoride or its complexes.⁽⁷⁵⁴⁾

Viscous nondrying oils are produced from the polymerization of saturated terpenes, such as pinane, thujane, and carane, using boron trifluoride as the catalyst.⁽⁷⁶⁰⁾

Camphor, when warmed, absorbs a large quantity of boron trifluoride and produces a crystalline product with a melting point below that of camphor. Upon heating, this latter compound yields camphor and boron trifluoride unless heated for 24 hours at 250°C. in which case cymene is produced.⁽⁴⁸⁰⁾

Rosin may be polymerized with boron trifluoride, or with its addition compounds, without decreasing the acidity of the rosin by treatment at not over 30°C. for 5 minutes to 2 hours.⁽⁷⁵¹⁾ Refining and polymerization can be accomplished by catalyzing the reaction with boron trifluoride in an inert solvent and in an inert atmosphere.^(102, 103, 104)

Natural resins (for example, colophony, copal, or damar), or their corresponding resin acids or esters when dissolved in an organic solvent, such as carbon tetrachloride, are polymerized by boron trifluoride to yield resins possessing higher molecular weights, lower iodine numbers, and higher softening points.^(407c, 418b)

Cyclic Oxides. Cyclic oxides, such as ethylene oxide, are polymerized in the presence of boron trifluoride and alcohols, ketones and acid chlorides.⁽⁷⁰⁵⁾

Six-membered cyclic formals containing not more than 7 carbon atoms, such as 4-methyl-1,3-dioxane are condensed by boron trifluoride to yield resinous materials.⁽²³²⁾

1,3-dioxolane polymerizes to a tough solid in the presence of boron trifluoride at 0°C. Forty parts of the solid dissolve in 300 parts of water. This solution may be further polymerized by heating to temperatures between 75 and 90°, thus forming a water-insoluble polymer.⁽⁸¹⁹⁾ Similarly, 2-methyl-4-keto-1,3-dioxolane may be polymerized at temperatures between 20 and 100°C. using boron trifluoride as the catalyst.⁽¹⁸¹⁾

Epoxyethers dimerize in the presence of boron trifluoride etherate.⁽²⁷¹⁾

Miscellaneous. Cyanuric chloride is prepared by the polymerization of cyanogen chloride with boron trifluoride under carefully controlled conditions. For example, hydrogen chloride gas and a nonvolatile derivative of cyanogen chloride with boron trifluoride are dissolved in a precooled inert solvent, such as dioxane, isopropyl ether, butyl ether or diethyl cellosolve. An inert diluent such as dichloroethane, chloroform, carbon tetrachloride, or phenyl chloride is added, and the solution stirred at 20 to 40°C. with the slow addition of precooled cyanogen chloride. Cyanuric chloride precipitates in yields which vary from 69 to 88.6%.^(893a)

Unsaturated hydrocarbons of the acetylene or ethylene series are polymerized with halogen derivatives of saturated hydrocarbons in the presence of boron trifluoride under pressure.^(413b)

Resinous products are obtained by the reaction of petroleum cyclic hydrocarbon oils and aldehydes in the presence of boron trifluoride.⁽⁸⁹⁰⁾

A coumarone resin results when coumarone oil is treated with boron trifluoride in the presence of hydrogen fluoride.^(380a)

A resin has been produced by simultaneously reacting an aromatic hydrocarbon with an aldehyde and a compound from the group consisting of polycarboxylic acids and anhydrides of polycarboxylic acids in the presence of boron trifluoride.⁽³⁶⁵⁾

Hydrocarbons with molecular weights of 2500 to 5000 are prepared by the polymerization at a temperature below -10°C. of the normal liquid cracking products of high-boiling hydrocarbons using boron trifluoride as the catalyst.⁽⁴²⁰⁾ Dehydrogenated solid or semisolid paraffinic hydrocarbons react similarly.⁽⁷¹⁵⁾

Unsaturated fatty oils also are polymerized by boron trifluoride for use in raising the viscosity index of lubricating oils.⁽²⁴⁰⁻²⁴⁴⁾

A polymer of a semidrying fatty oil, rapeseed oil, is prepared by dilution of the oil with a halogenated gaseous hydrocarbon, ethylene chloride, in the presence of boron trifluoride at 25°C.⁽⁸⁰⁵⁾ Esters of unsaturated aliphatic acids with monohydric or dihydric aliphatic alcohols are used with boron trifluoride for the polymerization of such fatty oils. Esters, such as oleyl linolate, amyl oleate, and cetyl acrylate may be used.⁽⁶⁷³⁾

Soybean oil has been polymerized in 1 hour at a temperature of about 130°C. in the presence of about 2.8% boron trifluoride by

weight.⁽⁹⁰⁸⁾ Drying oils have been polymerized so as to avoid gelation due to high local concentrations of boron trifluoride.^(185a)

Polymers of propylene result from the treatment of isopropyl alcohol with boron trifluoride^(589, 946) or with $\text{BF}_3 \cdot 2\text{CH}_3\text{OH}$.⁽⁵⁸⁹⁾

Unsaturated alcohols, for example, oleic alcohol, isobutenol, and 1,8-octadecenediol, polymerize in the presence of boron trifluoride to produce unsaturated compounds of higher molecular weight.⁽⁶⁷⁵⁾

Chloral is converted rapidly to metachloral by boron trifluoride.⁽⁴⁸⁰⁾

Unsaturated acids, such as oleic, ricinoleic, isopropylidenepimelic, muconic, and undecylenic, polymerize to unsaturated compounds of higher molecular weight in the presence of boron trifluoride.^(170, 675)

When rubber is treated with boron trifluoride, "haloformed" rubber is produced.⁽⁵³⁹⁾ Rubber dissolved in an inert solvent has been treated with boron trifluoride to give resinous material.⁽¹²⁰⁾ Rubber in solution has been treated with boron trifluoride, or its complexes, to yield a condensation derivative of rubber.^(608, 643, 644, 645, 646, 862a) Rubber or its depolymerization products have been catalytically polymerized with boron trifluoride and its complexes to give a material which improves the viscosity index of lubricating oils.^(898, 899, 900)

In the making of asphalt from petroleum residues, after blowing with air at 149 to 260°C., the product is heated at 149°C. with a small amount of a polymerizing catalyst such as boron trifluoride.^(163, 164)

§ ISOMERIZATION

Boron trifluoride has been reported to promote the Beckmann rearrangement, the benzidine transformation, the phenyl acetate to *p*-hydroxyacetophenone transformation, and the conversion of diazoaminobenzene into aminoazobenzene.⁽⁵⁸⁴⁾ It is used also as a catalyst activator with Friedel-Crafts catalysts for the conversion of normal paraffinic hydrocarbons into isoparaffinic hydrocarbons.^(41, 674)

Butane is isomerized to isobutane in the presence of boron trifluoride below 200°C.,⁽⁶⁷⁴⁾ boron trifluoride and aluminum bromide,⁽³⁵⁰⁾ boron trifluoride and water, or boron trifluoride and hydrogen fluoride⁽⁴³⁴⁾ at 107° to 150°C. under pressures of 20 to 30 atmospheres,^(19, 487) and boron trifluoride and metallic nuclei or

compounds.^(485, 486, 779) Normal paraffins, such as butane, pentane, hexane, heptane, or octane, may be isomerized by heating under pressure in the presence of boron trifluoride and hydrogen fluoride (18, 156, 158, 159, 699, 700, 780, 920, 961) or of boron trifluoride and sulfur trioxide, with or without hydrogen fluoride⁽⁹⁶⁷⁾ or boron trifluoride and a halosulfonic acid.⁽⁸⁴³⁾ However, no isomerization of *n*-butane was obtained, using 10 mole % boron trifluoride and 25 mole % of water at 85°C. after 23.5 hours, nor when using 2 mole % of boron trifluoride and 1 mole % of hydrogen chloride at 85°C. after 49 hours, nor when using 6 mole % of boron trifluoride and 4 mole % of hydrogen bromide at room temperature after 291 hours.⁽³⁵¹⁾

Isobutane did not isomerize when it was subjected to boron trifluoride, water, and nickel.⁽⁴²⁷⁾ When the butyl group is attached to the benzene ring, for example, butylbenzene, boron trifluoride, and an assistant such as phosphorus pentoxide cause the isomerization of the *n*- and isobutyl groups to *s*- and *t*-butyl groups, respectively, in alkylation procedures. At temperatures up to 75°C. no isomerization of a butyl group already in the benzene ring is effected on further alkylation using boron trifluoride alone or with phosphorus pentoxide.⁽³⁵⁶⁾

Gas-oil and lubricating-oil fractions from cracked petroleum have been isomerized with boron trifluoride.⁽¹⁴⁸⁾

Catalytic isomerization of unsaturated glyceride oils results from the treatment of drying or semidrying oils with a boron-trifluoride-bodied Chinawood oil gel at temperatures between 230 and 315°C.^(719b)

Isomerization of normal alkanes dissolved in fluorocarbons, such as C_7F_{16} , $C_6F_{12}Cl_2$, $C_7F_{12}H_4$, $C_7F_{12}Cl_2H_2$, etc., by a BF_3 -HF catalyst has been patented.^(690a)

The pour-depressant efficiency of a chlorinated paraffin wax-naphthalene condensation product has been improved by retreatment with boron trifluoride.⁽⁶⁰⁹⁾

Naphthenic hydrocarbons have been isomerized in the presence of boron trifluoride catalysts to cyclohexane⁽⁷⁰¹⁾ or to hydrocarbons of greater branching.⁽⁷⁹²⁾

Tertiary vinyl ethynyl carbinol is isomerized by $(C_2H_5)_2O \cdot BF_3$ and red mercuric oxide. Thus is $H_2C:CHC:CCR_2OH$ isomerized to $H_2C:CHCOCH:CR_2$.⁽⁶⁵⁹⁾ However, an ester like ethyl maleate is not isomerized at room temperature using boron trifluoride or

$(C_2H_5)_2O \cdot BF_3$ as catalysts, even in the presence of hydrogen bromide.⁽⁷²⁴⁾

When $(C_2H_5)_2O \cdot BF_3$ is used as a catalyst with epichlorohydrin, instead of the expected product $ClCH_2CH(OC_2H_5)CH_2OC_2H_5$, the compound $ClCH_2CH(OH)CH_2OC_2H_5$ is obtained. Similarly, the methyl derivative $ClCH_2CH(OH)CH_2OCH_3$ forms from epichlorohydrin and $(CH_3)_2O \cdot BF_3$.⁽⁵⁸⁷⁾

Cis-stilbene is converted to the *trans*-isomer quite readily in the presence of boron trifluoride or $(C_2H_5)_2O \cdot BF_3$,⁽⁷²⁴⁾ but neither the *cis* nor the *trans* isomers are modified by boron trifluoride in carbon tetrachloride nor in $Et_2O \cdot BF_3$.⁽²¹⁵⁾

The Fries rearrangement of *p*-tolyl acetate is catalyzed by boron trifluoride.⁽³²⁶⁾

When boron trifluoride is allowed to react with esters of aromatic hydroxy compounds and aliphatic carboxylic acids with more than 10 carbon atoms, phenol ketones are formed. Thus, the phenyl ester of lauric acid rearranges to give undecyl-*p*-hydroxyphenyl ketone. Similarly, pentadecyl-4-hydroxy-3-methyl phenyl ketone and heptadecyl-*p*-hydroxyphenyl ketone are prepared.^(419b)

Phenyl tetraacetyl glucosides are isomerized by boron trifluoride.⁽⁴⁰⁵⁾

The mechanism of the rearrangement of phenoxy- and toloxy-cyclohexanes with boron trifluoride appear to be intermolecular rather than intramolecular; the ether first splits into a phenol and cyclohexane whereupon these compounds react to form the mono- and polycyclohexylphenols.⁽⁵⁰⁰⁾

The Beckmann rearrangement of acetophenone oxime and of *p*-tolyl phenyl ketoxime to the corresponding amides is catalyzed by boron trifluoride.⁽³²⁶⁾

It is claimed that the oximes of γ -*p*-methoxybenzoylbutyric acid and γ -*p*-ethoxybenzoylbutyric acid, upon boiling with boron trifluoride-etherate, undergo the Beckmann rearrangement, yielding the ethyl ester of *N-p*-methoxyphenylglutaramic acid and the ethyl ester of *N-p*-methoxyphenylglutaramic acid, respectively. Similarly is diphenyl ketoxime converted to benzanilide.⁽⁹⁸⁸⁾

When propylene is passed into a mixture of phenol and boron trifluoride in benzene, some *o*-isopropylphenol is obtained, owing to the rearrangement of part of the main product isopropyl phenyl ether in the presence of boron trifluoride.⁽⁸²⁴⁾ Similarly, an alkyl phenyl or cresyl ether rearranges in the presence of boron triflu-

oride to produce a phenol. The following phenols are thus prepared: 2-isopropyl-; 2,2-diisopropyl-; 2,4,6-triisopropyl-; 2-methyl-4-isopropyl-; 2-methyl-4,6-diisopropyl-; 4-methyl-2-isopropyl-; 4-methyl-2,6-diisopropyl-; and 3-methyl-4,6-diisopropyl-.^(823, 825)

Dicyclopentadiene condenses with ether alcohols in the presence of boron trifluoride, $\text{BF}_3 \cdot \text{Et}_2\text{O}$, or $\text{BF}_3 \cdot \text{Bu}_2\text{O}$, whereby the hydroxyl group of the alcohol adds to the double bond of the bridged endomethylene cycle of dicyclopentadiene. Simultaneously, a molecular rearrangement to the so-called "nordicyclopentadiene" ring system occurs. With 2-methoxyethanol, for example, the reaction may be portrayed as follows:

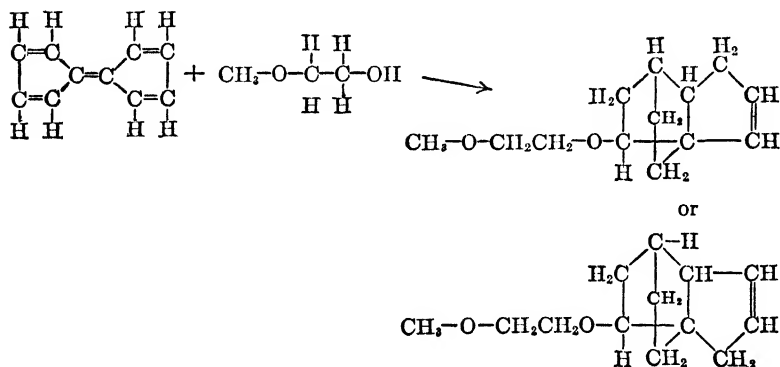

Similar halogenated ethers are obtained using halogenated alcohols. Also, 1,4-endomethylenetetrahydrofluorene may be used instead of dicyclopentadiene.^(127, 128, 129)

In the esterification of 1,4-endomethylenetetrahydrofluorene by organic carboxylic acids in the presence of boron trifluoride or one of its etherates, a similar addition with simultaneous rearrangement occurs. This rearrangement has been shown on page 189.⁽¹³⁰⁾

In the reaction between 3,4-dimethoxyphenyldiazonium fluoroborate and acetic acid, instead of the expected product 1-hydroxy-3,4-dimethoxybenzene acetate, 2-hydroxy-4,5-dimethoxyacetophenone is obtained. It has been assumed that the rearrangement is due to the boron trifluoride and hydrogen fluoride liberated during the reaction.⁽⁸¹³⁾

Boron trifluoride has been used as a catalyst in a study of the constituents of the adrenal cortex, primarily with the mechanism of the rearrangement of 17-hydroxy-20-keto steroids into polyhy-

drochrysene derivatives, or by the pinacol rearrangement to *D*-homoandrostanone derivatives. The pertinent facts of this study are summarized in Table 40.

TABLE 40
REARRANGEMENT OF STEROIDS

Reactant	Product after Rearrangement	References
3- β -Acetoxy-17- α -hydroxy-20-pregnynone	3- β -17- α,β -Diacetoxy-17-methyl-17- <i>D</i> -homoetiocolanone	797
3- β -Acetoxy-17- α -hydroxy-20-pregnynone	1(2)-Chrysenone hexadecahydro-2,8-dihydroxy-2,10a,12a-trimethyldiacetate	765a
3- β -17- α -Diacetoxy-20-pregnynone	1(2)-Chrysenone hexadecahydro-2,8-dihydroxy-2,10a,12a-trimethyldiacetate	765a, 765b
3- β -Acetoxy-17- α -hydroxy-allo-20-pregnanone	3- β -17- α,β -Diacetoxy-17- α -methyl- <i>D</i> -homo-17-androstanone	799
17-Ethinyl-3,17-dihydroxy-5-androstene	1(2)-Chrysenone-3,4,4a,4b,5,7,8,9,10,10a,10b,11,12,12a-tetradecahydro-2,8-dihydroxy-2,10a,12a-trimethyldiacetate	765a, 765b
17-Ethinyl-3- α -acetoxy-17- α -hydroxy-5-androstene	1(2)-Chrysenone-3,4,4a,4b,5,7,8,9,-10,10a,10b,11,12,12a-tetradecahydro-2,8-dihydroxy-2,10a,12a-trimethyldiacetate	765b
17-Ethinyltestosterone	1,8-Chrysenedione-3,4,4a,4b,5,6,9,-10,10a,10b,11,12,12a-tridecahydro-2-hydroxy-2,10a,12a-trimethyl-2-acetate	765b
3- β -17- α -Dihydroxy-5-pregnene-20-one	3- β -17- α,β -Diacetoxy-17-methyl- <i>D</i> -homo-5-androstene-17-one	799

RECOVERY OF BORON TRIFLUORIDE CATALYSTS

There are numerous ways of recovering a boron trifluoride catalyst.⁽⁸⁴²⁾ Only the more important methods are discussed here.

DISTILLATION

When boron trifluoride forms a coordination compound with the product of olefin polymerization reactions, it is recovered by distillation.^(327, 378, 693, 849) Frequently, it is necessary to distil several times at different pressures in order to effect a separation.^(224, 228, 234, 546)

The catalyst $\text{BF}_3 \cdot \text{H}_2\text{O}$ is separated from organic compounds by heating it sufficiently to begin to volatilize the boron trifluoride in order to effect a separation of a catalyst layer and a hydrocarbon layer. The hydrocarbon layer then is drawn off and boron trifluoride added to the catalyst layer to restore it to its original concentration.⁽⁷⁴⁾ The hydrated boron trifluoride catalyst is recovered also by steam distillation.⁽⁵⁴⁵⁾

CHEMICAL ADDITION

Boron trifluoride is recovered from reaction liquids containing it, dissolved or as a coordination compound, by the addition of a trivalent nitrogen compound, such as ammonia or an amine, to form an insoluble complex with boron trifluoride. The reaction liquid then is drawn off,⁽³⁰⁴⁾ and sulfuric acid is added to the complex to release the boron trifluoride.^(827, 829, 838, 851) Dimethylaniline has been used also in this manner.⁽¹⁵³⁾

Boron trifluoride has been recovered also by the method of preferential solubility.^(29, 30) Such solvents usually form coordination compounds. Diaryl ketones have been used thus to recover boron trifluoride.⁽³⁹⁸⁾ Also, organic ethers of the type X-O-Y, in which X is an alkyl radical or substituted alkyl radical and Y is an alkyl or an aryl radical, which may or may not be substituted, have been used as solvents. The substituents other than hydrogen may be halogen, alkoxy radicals, or esterified carboxy radicals, giving rise to ethers such as anisole, phenetole, and 2,2'-dichlorodiethyl ether. The boron trifluoride complex is decomposed by heating to 177°C., thus liberating the boron trifluoride.⁽²⁰⁾ Alkyl sulfides and mercaptans have been used similarly except that lower temperatures between 65 and 105°C. are required to release the boron trifluoride.⁽²¹⁾

Absorption of boron trifluoride in a preferential solvent such as sulfuric acid at temperatures between 21 and 38°C. and pressures of 25 to 200 pounds per square inch represents another recovery practice. The gas is liberated by heating the solution.⁽²⁹⁾

The residue from a gas-oil conversion which contains a catalyst composed of boron trifluoride and hydrogen fluoride may be treated with hydrogen at 300°C. and under an initial pressure of 100 atmospheres for 8 hours to form low-boiling hydrocarbons and to liberate the boron trifluoride and hydrogen fluoride.⁽⁷⁹⁾

CHEMICAL ADDITION FOLLOWED BY DISTILLATION

$\text{BF}_3 \cdot \text{H}_2\text{O}$ is recovered by the addition of a sufficient amount of water to form $\text{BF}_3 \cdot 2\text{H}_2\text{O}$ which then is removed by vacuum distillation.⁽⁸⁸⁸⁾ In another process, boron trifluoride is claimed to be separated from the organic products by addition of water in such a quantity that the mixture all during the distillation contains a quantity of water above the point where boron trifluoride decomposes.^(225, 540)

Another scheme frequently used is to add an anhydrous organic addition agent to the mixture containing an organic complex of boron trifluoride. By so doing, the original complex is decomposed and the organic compound displaced with the result that a new complex is formed comprising the addition agent added and boron trifluoride. Subsequent distillation separates the two components.^(223, 541)

$\text{BF}_3 \cdot \text{H}_2\text{O}$ is decomposed by the addition of calcium fluoride to form calcium fluoborate. Subsequent heating of the latter compound releases the boron trifluoride.⁽⁸⁸⁸⁾

Boron trifluoride may be recovered also from an aqueous medium by adding potassium, rubidium, or cesium carbonates, chlorides, nitrates, sulfates, or hydroxides; calcium carbonate⁽⁶⁴²⁾ has also been used. The insoluble fluoborates are separated, dried, and treated with sulfuric acid and boric oxide to produce boron trifluoride.^(756, 757) Similarly, boron trifluoride is separated from acetic acid by the addition of a halide of aluminum, copper, iron, lead, sodium, tin, or zinc, or calcium oxide and subsequent heating to 100 to 175°C. to remove the water. Finally, after heating to temperatures between 175 to 230°C., it is claimed that boron trifluoride distills off.^(227, 235, 543, 751)

Boron trifluoride has been recovered also from the hydrocarbon effluent of catalytic processes by selective absorption in anhydrous liquid hydrogen fluoride.⁽⁷⁸⁷⁾ The basic steps include flashing or distillation of low-boiling gases, including boron trifluoride, from liquid products, treatment of the evolved vapors with liquid hydrogen fluoride at 4 to 38°C. and 50–500 psi. to absorb boron trifluoride, stripping the boron trifluoride from the hydrogen fluoride at 21 to 49°C. and at atmospheric, or slightly higher, pressure, and recycling the boron trifluoride to the reaction.^(149, 150)

7

Analysis of Boron Trifluoride and Its Derivatives

No simple direct conclusive qualitative-analytical method for the identification of boron trifluoride exists. Davy ⁽¹⁹⁸⁾ passed boron trifluoride gas over potassium metal heated in a gun barrel to a red heat, by which procedure the boron trifluoride was reduced to elemental boron with the formation of potassium fluoride. These products then were detected by the usual methods.

The formation of typical coordination compounds has been used also for the identification of boron trifluoride. Gaseous ammonia and boron trifluoride react to form a white solid $\text{NH}_3 \cdot \text{BF}_3$ ^(289, 291) which sublimes without apparent decomposition. A white solid, however, would be produced also with ammonia by hydrogen halides, including hydrogen fluoride and other volatile acids.

Recently Miller ⁽⁶¹⁷⁾ has found that acetyl fluoride reacts quantitatively with boron trifluoride to yield acetyl fluoborate, a white solid. Silicon tetrafluoride does not react with acetyl fluoride and so is left as a residual gas. The authors claim to be able to detect 0.2% silicon tetrafluoride as an impurity in boron trifluoride.

DETECTION OF BORON TRIFLUORIDE AS FLUOBORATES. DETECTION OF FLUOBORATES

By absorption of boron trifluoride in an aqueous solution of sodium fluoride, sodium fluoborate is formed which then can be detected by any of the tests for fluoborates.

By reaction of a solution of a fluoborate with a small amount of potassium permanganate on a microscopic slide mixed-colored crystals of $\text{KBF}_4\text{—KMnO}_4$ crystallizing in the orthorhombic system separate.⁽³²²⁾ Since potassium perchlorate and barium sulfate likewise form mixed-colored crystals with potassium perman-

ganate, absence of perchlorates and barium sulfate must be assured.

Another method of some utility is based on the decomposition of the fluoborate solution by lime water to give calcium fluoride and boric acid.⁽⁴²⁾ A 200-g. sample of a solution of the fluoborate is made alkaline with lime water and evaporated to dryness and ignited. The ash is extracted with water, acidulated with acetic acid to decompose carbonates, and then filtered. The residue should be reignited and again extracted with water acidulated with acetic acid. The boric acid in the filtrate may be identified with turmeric paper. The presence of fluorides in the residue may be established by mixing a little silica with the residue in a platinum crucible, adding concentrated sulfuric acid, placing a watch glass with a drop of water on the underneath side over the crucible, and warming the crucible. Gelatinous silica forms in the drop as a result of hydrolysis of silicon tetrafluoride.

According to another procedure,^(767b) when an aqueous solution of potassium fluoborate is boiled for at least an hour with an excess of calcium chloride solution, the following reaction,

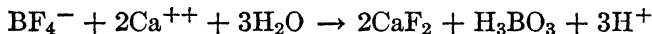

takes place completely with the formation of a filterable precipitate of calcium fluoride, provided the acidity is slowly neutralized by the addition of suitable quantities of potassium chlorate and potassium iodide together with a little potassium metavanadate as a catalyst. Sodium acetate also will serve to buffer the solution.

Willy Lange⁽⁴⁸⁹⁾ discovered what appears to be the best test for the fluoborate ion. He found that nitron acetate ($\text{C}_{20}\text{H}_{16}\text{N}_4 \cdot \text{HCH}_3\text{CO}_2$) precipitates light-green needles of nitron fluoborate, $\text{C}_{20}\text{H}_{16}\text{N}_4 \cdot \text{HBF}_4$ (m. pt. 224.5°C., uncorr.). At 16°C. one part of the salt dissolves in 3000 parts of water, and the solubility may be further reduced by using an ice-cold solution of an excess of nitron acetate. Nitrates, fluophosphates, perchlorates, perrhenates, and tungstates also give precipitates with nitron acetate, and their absence must be assured. Hexamminenickel fluoborate, $[\text{Ni}(\text{NH}_3)_6](\text{BF}_4)_2$, is reported as insoluble in ammonium hydroxide solutions. This has been suggested as a sensitive test for fluoborate ions.⁽⁹⁵⁰⁾ Perchlorates would interfere with this test.

Stolba⁽⁸⁷⁰⁾ reports that turmeric paper, on being treated with a solution of ammonium fluoborate followed by aqueous hydro-

chloric acid, produces a brown stain on drying because of the presence of boron.

QUANTITATIVE ANALYSIS OF FLUOBORIC ACID

Since several of the methods for the determination of boron trifluoride are based on the titration of fluoboric acid, the quantitative analysis of the latter is discussed first.

Fluoboric acid is a strong acid ionizing primarily to hydronium and fluoborate ions: $\text{H}_2\text{O} + \text{HBF}_4 \rightleftharpoons \text{H}_3\text{O}^+ + \text{BF}_4^-$. It has been suggested that the fluoborate ion dissociates to a limited extent to BF_3 and F^- ; ⁽⁴⁵⁸⁾ presumably this dissociation would be greater the higher the concentration, inasmuch as it is reported that boron trifluoride is insoluble in anhydrous hydrogen fluoride. Furthermore fluoboric acid is hydrolyzed somewhat by water (see Table 21, Chapter 5).

The first step in the titration of fluoboric acid is

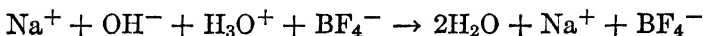

Since mono- and dihydroxyfluoboric acids exist, it is probable that the fluoborate ion is converted then successively upon addition of more base into $(\text{BF}_3\text{OH})^-$, then into $[\text{BF}_2(\text{OH})_2]^-$, and finally, since $[\text{BF}(\text{OH})_3]^-$ has not been found, directly to BO_2^- .

Kern and Jones ⁽⁴⁵⁸⁾ report a titration curve (see Figure 7-1), in which the first stage of the titration corresponding to the neutralization of the hydronium ion without reaction with the BF_4^- ion, occurs at a pH of 5.0. Sodium fluoborate appears to have a buffer action between a pH of 5.0 and 8. The second break in the curve does not quite correspond to the formation of the $(\text{BF}_3\text{OH})^-$ ion. These end points vary with the concentration of the acid, amount of NaF present, and age of the solution being titrated. The results of the titration of fluoboric acid with 2.11 N NaOH shown in Table 41 were used in constructing Figure 7-1. The authors claim that by titrating at room temperature, using either thymol blue or methyl orange, an *approximate* determination can be made. Ruiss and Bakina ⁽⁷⁵⁰⁾ consider thymol blue a suitable indicator for the titration of fluoboric acid but state that titration cannot be carried out in dilute solutions, especially if not saturated with potassium fluoborate.

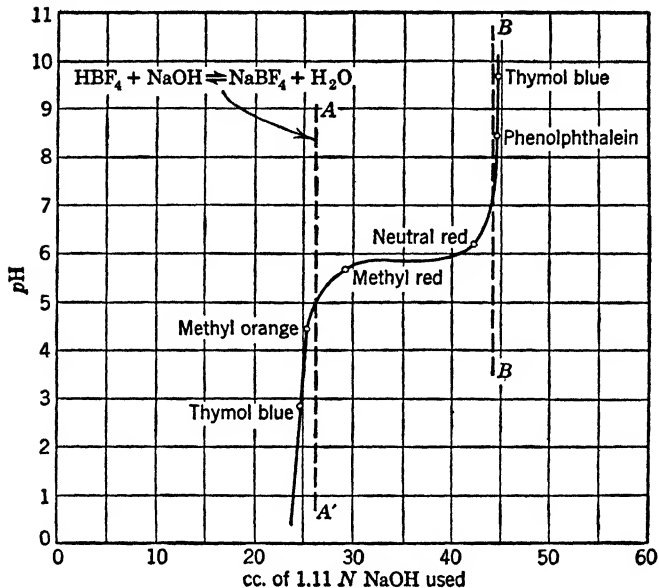

FIG. 7-1. Titration of fluoboric acid using indicators
(Courtesy *Electrochemical Society*)

TABLE 41

RESULTS OF TITRATION OF FLUOBORIC ACID SOLUTION ⁽⁴⁵⁸⁾

HBF ₄ Solution, cc.	Indicator	pH Value	Cubic Centimeters of 1.11 N NaOH at Which Color Changed				
			Initial	To	To	To	To
10.0	Methyl orange	4.4-4.6	Red	Orange 24.6	Yellow 25.0		
10.0	Methyl red	4.8-5.9	Purple red	Scarlet 25.2	Purple red 26.5	Orange red 29.4	
10.0	Thymol blue	2.0-2.8 and 8.0-9.6	Purple	Rose 21.8	Orange 22.7	Yellow 24.6	Bottle green 44.6
10.0	Rosalic acid	6.4-7.8	Yellow	Clear 24.3	Pink 41.4		
10.0	Neutral red	5.4-6.6	Red	Pinkish orange 40.6	Orange 42.0		
10.0	Phenolphthalein	7.8-8.5	Clear	Pink 44.8			

Travers and Malaprade⁽⁹⁰³⁾ reported that the amount of potassium hydroxide solution required to titrate fluoboric acid differs with the age of the latter. The neutralization curve shows that boric acid reacts instantly with hydrofluoric acid to form a new fluoboric acid, the salt of which is easily decomposed by alkali. On standing, the first-formed fluoboric acid gradually changes into tetrafluoboric acid, HBF_4 , until the equilibrium between the two fluoboric acids is established. The time required and the

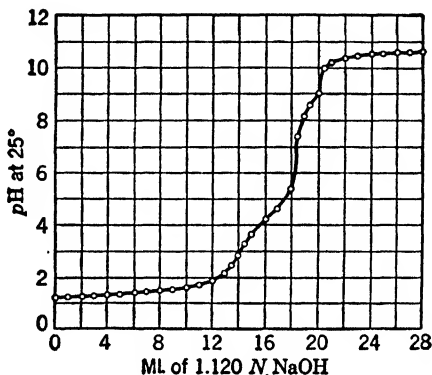

FIG. 7-2. pH titration of (0.1512 M) fluoboric acid at equilibrium
(Courtesy *Journal of the American Chemical Society*)

amount of tetrafluoboric acid formed at the equilibrium point increase with the concentration of the reactants and the initial acidity of the mixture.^(935a)

Wamser^(935a) has recently shown that the first reaction of hydrofluoric acid with boric acid to give monohydroxyfluoboric acid is rapid but that the reaction of the latter with hydrofluoric acid is very slow. This explains the observation of Travers and Malaprade. Wamser's titration curve of fluoboric acid is shown in Figure 7-2.

ANALYSIS OF COMMERCIAL FLUOBORIC ACID

Commercial fluoboric acid may contain as impurities sulfuric acid, fluosilicic acid, free boric, hydrofluoric, mono- and di-hydroxyfluoboric acid, and nonvolatile solids.

The following complete analytical procedure for determination of these substances, developed by Harry Flisik, C. F. Swinehart,

and A. R. Bumblis in the research laboratories of the Harshaw Chemical Company, has withstood the test of hundreds of analyses and is presented here in detail through their kindness because of the present importance of this acid. We have found in the literature no other presentation of detailed instructions for the complete analysis of fluoboric acid.

Sulfuric Acid. Weigh on a torsion balance 10.0 g. of the sample into a platinum dish. Evaporate on a water bath until white fumes are no longer given off. The evaporation is slow and usually takes about 2 hours to reach this point. Add 10 ml. of water, and evaporate again on a water bath. As evaporation progresses, test occasionally to detect the pungent odor of fluoboric acid. Repeat the addition of water and the evaporation as often as this odor is detected during the previous evaporation. If the residue is solid, proceed as described under "Total Solids." Otherwise add 25 ml. of water, and titrate with standard 0.5 *N* alkali, using phenolphthalein as the indicator. Calculate to percent H_2SO_4 . If free hydrofluoric acid or free boric acid is to be determined, calculate also the milliliter standard 0.5 *N* alkali to the basis of a 1-g. sample for use in the final calculations.

1 ml. *N* alkali \approx 0.04902 g. H_2SO_4

Total Solids at 105°C. If the residue remaining after evaporating fluoboric acid as described under "Sulfuric Acid" is solid, dry at 105°C. for $\frac{1}{2}$ hour. Calculate to percent "Total Solids." Solid material (sodium salts, etc.) is usually present when the acid has been stored in a glass container (see footnote under calculations).

Fluosilicic Acid. This method tends to give slightly high results, and the method given for fluosilicic acid under the analysis of boron trifluoride is superior. Weigh 2 g. of the sample into a platinum weighing tube half filled with water, and wash into a 150-ml. beaker with 25 ml. of water. If free hydrofluoric acid is present, the sample must be washed into a waxed or plastic beaker. Add 1 g. of potassium nitrate, stir to dissolve the salt, and then add 30 ml. of isopropyl or ethyl alcohol. Stir thoroughly, cover the beaker, and let stand 1 hour for the complete precipitation of potassium fluoborate and potassium fluosilicate. Filter through paper or a Gooch crucible, and wash free from acid with neutral 50% isopropyl or 50% ethyl alcohol containing 2% potassium nitrate. Prepare this washing solution by dissolving 4 g. of potassium nitrate in 100 ml. of water, diluting with 100 ml. of isopropyl or ethyl alcohol and titrating with dilute alkali to a faint pink color, using phenolphthalein as indicator. Test the filtrate for acidity by titrating 25 ml. with 0.1 *N* alkali, adding more phenolphthalein if necessary. Regard the filtrate acid-free when a drop of 0.1 *N* alkali is sufficient to produce a pink color. Put the filter paper or Gooch crucible into the original beaker, and add 100 ml. of water. Heat to 40°C., and digest at this temperature until the potassium

fluoborate and fluosilicate dissolve. Titrate with standard 0.5 *N* or weaker alkali, using about $\frac{1}{2}$ ml. of phenolphthalein solution as indicator and taking a faint pink color, remaining 15 seconds, as the end point.

The titration is equivalent to 4 of the 6 fluoride atoms in fluosilicic acid. Multiply by $\frac{3}{2}$ to obtain the total alkali for H_2SiF_6 , and calculate to percent H_2SiF_6 . If free hydrofluoric acid or free boric acid is to be determined, calculate also the milliliters of standard 0.5 *N* alkali for H_2SiF_6 to the basis of a 1-g. sample for use in the final calculation. 1 ml. *N* alkali \approx 0.02400 g. H_2SiF_6 .

Note. If a waxed or plastic beaker which cannot be safely heated to 40°C. must be used for precipitation of potassium fluoborate and fluosilicate, place the washed paper or Gooch crucible in a glass beaker, and dissolve any washed precipitate remaining in the original receptacle with 100 ml. of water, adding this to the beaker containing the paper or Gooch crucible. The solution should at no time be heated above 50°C., because then some hydrolysis product of potassium fluoborate may be counted as fluosilicic acid.

Total Acidity. Weigh 1 g. of the sample of fluoboric acid into a platinum weighing tube half filled with water, and wash into a 300-ml. Erlenmeyer flask. Dilute to 100 ml., and add 5 g. of neutral calcium chloride and 2 drops of methyl orange. Titrate with standard 0.5 *N* alkali until just alkaline. Record this titration and all succeeding titrations. Heat the solution just to boiling, and digest (at 90°C.) for 10 minutes. Titrate the hot solution to an approximate end point. Heat again just to boiling, and digest (90°C.) for 10 minutes. Titrate again to an approximate end point. Continue this heating and titration until only 1 or 2 ml. alkali are required to reach an end point. Boil the solution gently $\frac{1}{2}$ hour, cool to at least room temperature, and titrate to an exact end point. Repeat this boiling and cooling until no more acidity develops. At this point the hydrolysis of tetrafluoboric acid to 4 moles of hydrofluoric and 1 mole of orthoboric acid is considered complete. The total amount of alkali used is equivalent to the sulfuric acid, the fluosilicic acid, the free hydrofluoric acid if present, and fluoboric acid. If free hydrofluoric acid is known to be absent, deduct the amount of alkali required for sulfuric and fluosilicic acids from the total alkali used, and calculate the difference as percent fluoboric acid. Otherwise, or if free boric acid is to be determined, calculate the total amount of alkali to the basis of a 1-g. sample for use in the final computations. Designate this number of milliliters of standard 0.5 *N* alkali as A (page 236), for use in the calculation of free boric acid or for free hydrofluoric acid:

1 ml. *N* alkali \approx 0.02194 g. HBF_4

Free Boric Acid or Hydrofluoric Acid. Weigh 1 g. of the sample into a platinum weighing tube half filled with water, and wash into a 150-ml. beaker with 25 ml. of water. Add 10 ml. of neutral 15% calcium chloride solution and a drop of methyl orange indicator. Stir somewhat, and titrate the cool solution with standard 0.5 *N* alkali

until just alkaline. Calculate this titration to the basis of a 1-g. sample, and designate as B (page 236). Add 20 ml. of neutral glycerine or invert sugar, and titrate to a pink color, using phenolphthalein as indicator. Calculate this titration to the basis of a 1-g. sample, and designate as C (page 236).

Reactions Involved in the Above Titrations. In order to make the following calculations clear the equations for the various titrations are given:

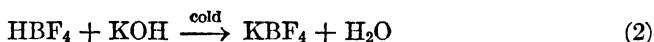
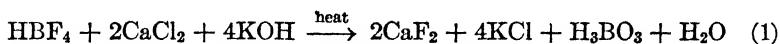

and in the presence of calcium chloride it has been found empirically that partial hydrolysis of potassium fluoborate occurs and reaches an intermediate equilibrium sufficiently stable to give fairly accurate B and C titrations. The boric acid set free by this partial hydrolysis of potassium fluoborate can be titrated according to equation 6 and contributes part of the C titration when excess boric acid is present or constitutes all of the C titration when excess hydrofluoric acid is present. The ratio of potassium hydroxide to boric acid in the partial hydrolysis of potassium fluoborate can be represented by equation 2a:



It is quite probable that an intermediate hydroxyfluoborate is formed, but if so it titrates in presence of glycerine in the same ratio as equation 2a. Obviously the alkali used according to equations 2 and 2a minus $\frac{1}{4}$ the alkali used according to equation 1 is equal to the alkali used through partial hydrolysis of potassium fluoborate. This difference must be divided by 3 in order to relate it to the boric acid set free according to equation 2a in order that this value can be deducted from the C titration to obtain the alkali equivalent to the free boric acid if present.

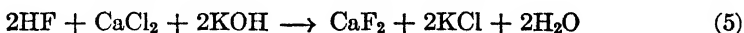
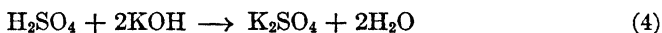

When excess hydrofluoric acid is present, it will appear in the calculations as a negative amount of alkali for excess boric acid. This is made positive and multiplied by 4 to obtain the alkali equivalent to the excess hydrofluoric acid. In this case it is necessary to subtract the amount of alkali from the total acidity along with that for sulfuric acid and fluosilicic acid before calculating to tetrafluoboric acid.



This equation involves the boric acid set free by partial hydrolysis of potassium fluoborate according to equation 2a and excess boric acid when present.

Calculations. It should be remembered that the values of titrations A, B, C, H_2SO_4 , and H_2SiF_6 are in terms of milliliters of standard 0.5 N alkali calculated to a 1-g. basis. Then:

A = ml. 0.5 N alkali for total acidity

$A_1 = A - \text{ml. 0.5 N alkali for } \text{H}_2\text{SO}_4 - \text{ml. 0.5 N alkali for } \text{H}_2\text{SiF}_6$

$B_1 = B - \text{ml. 0.5 N alkali for } \text{H}_2\text{SO}_4 - \text{ml. 0.5 N alkali for } \text{H}_2\text{SiF}_6$

$$C - \frac{\left(B_1 - \frac{A_1}{4}\right)}{3} = \text{ml. 0.5 N alkali for excess } \text{H}_3\text{BO}_3 \text{ if } \frac{\left(B_1 - \frac{A_1}{4}\right)}{3} \text{ is less than } C$$

$$4 \left[\frac{\left(B_1 - \frac{A_1}{4}\right)}{3} - C \right] = \text{ml. 0.5 N alkali for excess HF if}$$

$$\frac{\left(B_1 - \frac{A_1}{4}\right)}{3} \text{ is larger than } C$$

$A_1 - \text{ml. 0.5 N alkali for excess HF} = \text{ml. 0.5 N alkali for } \text{HBF}_4$

Example When Excess H_3BO_3 is Found

Titration A = 40.5 ml. 0.5 N alkali

Titration B = 15.5 ml. 0.5 N alkali

Titration C = 2.37 ml. 0.5 N alkali

H_2SO_4 titration = 0.20 ml. 0.5 N alkali

H_2SiF_6 titration = 0.30 ml. 0.5 N alkali

$$A_1 = 40.5 - 0.20 - 0.30 = 40.0$$

$$B_1 = 15.5 - 0.20 - 0.30 = 15.0$$

$$\frac{B_1 - \frac{A_1}{4}}{3} = 1.67 \text{ which is less than } C$$

Hence: $2.37 - 1.67 = 0.70$ for excess H_3BO_3

Ml. of 0.5 N alkali for $\text{HBF}_4 = A - \text{H}_2\text{SO}_4$ titration -

$$\text{H}_2\text{SiF}_6 \text{ titration} = 40.5 - 0.20 - 0.30 = 40.0$$

$$\% \text{H}_2\text{SO}_4 = 0.20 \times 0.0490 \times N \text{ of alkali} \times 100$$

$$\% \text{H}_2\text{SiF}_6 = 0.30 \times 0.0240 \times N \text{ of alkali} \times 100$$

$$\% \text{Excess } \text{H}_3\text{BO}_3 = 0.70 \times 0.0518 \times N \text{ of alkali} \times 100$$

$$\% \text{HBF}_4 = 40.0 \times 0.02194 \times N \text{ of alkali} \times 100$$

Example When Excess HF is Found

Titration A = 41.3 ml. 0.5 N alkali

Titration B = 16.3 ml. 0.5 N alkali

Titration C = 1.67 ml. 0.5 N alkali

H_2SO_4 titration = 0.20 ml. 0.5 N alkali

H_2SiF_6 titration = 0.30 ml. 0.5 N alkali

$$A_1 = 41.3 - 0.20 - 0.30 = 40.8$$

$$B_1 = 16.3 - 0.20 - 0.30 = 15.8$$

$$\frac{B_1 - \frac{A_1}{4}}{3} = 1.87 \text{ which is greater than C}$$

Hence: $4(1.87 - 1.67) = 0.80$ for excess HF

Ml. 0.5 N alkali for $\text{HBF}_4 = A - \text{H}_2\text{SO}_4$ titration - H_2SiF_6 titra-

tion - ml. 0.5 N alkali for HF = $41.3 - 0.20 - 0.30 - 0.80 = 40.0$

$$\% \text{H}_2\text{SO}_4 = 0.20 \times 0.0490 \times N \text{ of alkali} \times 100$$

$$\% \text{H}_2\text{SiF}_6 = 0.30 \times 0.0240 \times N \text{ of alkali} \times 100$$

$$\% \text{Excess HF} = 0.80 \times 0.0200 \times N \text{ of alkali} \times 100$$

$$\% \text{HBF}_4 = 40.0 \times 0.02194 \times N \text{ of alkali} \times 100$$

Note. If solid matter is found when a sample is evaporated for a sulfuric acid determination, a special case presents itself in which the foregoing calculations are not strictly valid. The solid matter may contain orthoboric acid, sodium fluosilicate, sodium fluoborate, sodium

acid fluoride and/or sodium sulfate, presenting an extremely complex mixture for which no exact procedure and calculation has been found. However, if the amount of solid matter is small (0.25%), no serious error for fluoboric acid will be made by following the previous calculation without making a correction for sulfuric acid on the assumption that sulfates are present as neutral salts.

QUANTITATIVE DETERMINATION OF FLUOBORATES

When an aqueous solution of potassium fluoborate is boiled with an excess of calcium chloride solution, the reaction,

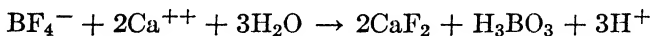

will take place completely with a filterable precipitate of calcium fluoride, provided the liberated H^+ ion is slowly neutralized by the addition of suitable quantities of potassium chlorate and iodide together with a little potassium metavanadate as a catalyst.^(766, 767b) For 0.2 g. of potassium fluoborate there should be added 0.25 g. potassium chlorate, 2 g. potassium iodide, 50 ml. of *M* calcium chloride solution and 0.15 ml. of 0.1 *M* potassium metavanadate. Boil for at least an hour, filter, wash, dry, and weigh the precipitate of calcium fluoride. The neutralization can be accomplished also by adding sodium acetate to the boiling solution.

It is reported that the $(\text{BF}_3\text{OH})^-$ ion can be titrated cold with methyl orange as indicator in the presence of BF_4^- ion, and in this way BF_4^- can be distinguished from its hydrolysis products.⁽⁷⁶⁶⁾ This should be checked further.

Willy Lange⁽⁴⁸⁹⁾ has found that nitron acetate, in the absence of interfering anions, such as nitrates, fluophosphates, perchlorates, perrhenates, and tungstates, gives a quantitative precipitation (see above) of nitron fluoborate, $\text{C}_{20}\text{H}_{16}\text{N}_4\text{HBF}_4$, and Wamser^(835a) reports that monohydroxyfluoborates give no precipitate with nitron acetate.

The *triphenylfluoborates* have been analyzed quantitatively^(270a) by an ingenious method: The sample was warmed with a few milliliters of concentrated sulfuric acid in a distilling flask. Then approximately 50 ml. of carefully dried methyl alcohol was added, and the mixture was warmed for a few minutes to permit the reaction between the alcohol and the boric acid to take place. Thereafter, successive fractions of about 10 ml. of the methyl

alcohol and methyl borate were distilled off through a fractionating column into a suitable receiver until no further boron was carried over. Two or three fractions were usually sufficient. After hydrolysis of the methyl borate, the boric acid was titrated with sodium hydroxide in the presence of mannitol.

The fluorine content was determined by the method of Allen and Furman ⁽⁶⁶⁾ in which the precipitant is triphenyl tin chloride. The sample was dissolved in sodium hydroxide and neutralized with hydrochloric acid, the precipitate removed by filtration, and the filtrate treated with triphenyl tin chloride yielding quantitatively a precipitate of triphenyl tin fluoride.

QUANTITATIVE ANALYSIS OF BORON TRIFLUORIDE

Bouchetal ⁽¹⁰⁶⁾ has reported that spectrographic analyses of mixtures of silicon and boron fluorides and chlorine with dry air are in close agreement with the results obtained by chemical methods. He reports a sensitivity of 1 part in 1000.

McIntyre ⁽⁵⁶⁶⁾ analyzed mixtures of boron trifluoride and silicon tetrafluoride by absorption in nickel fluoride with which the latter gas did not react.

Miller ⁽⁶¹⁷⁾ analyzed a similar gas mixture by condensing out the boron trifluoride with acetyl fluoride to give acetyl fluoborate. He found that silicon tetrafluoride does not react and so can detect 0.2% silicon tetrafluoride as impurity.

SAMPLING AND COMPLETE ANALYSIS OF BORON TRIFLUORIDE

Swinehart, Bumblis, and Flisik ⁽⁸⁸⁴⁾ have developed a method of sampling and of complete analysis of commercial boron trifluoride which gives excellent results.

The total probable impurities in commercial boron trifluoride usually now run less than 1% and consist of silicon tetrafluoride (from the silica in the crude fluorspar) sulfur dioxide (from reduction of sulfuric acid by galena, etc., in the fluorspar) and air. Any hydrogen produced by reaction of acids on metals will be included in the air. Traces of sulfur trioxide, water, and hydrogen fluoride may be in the gas.

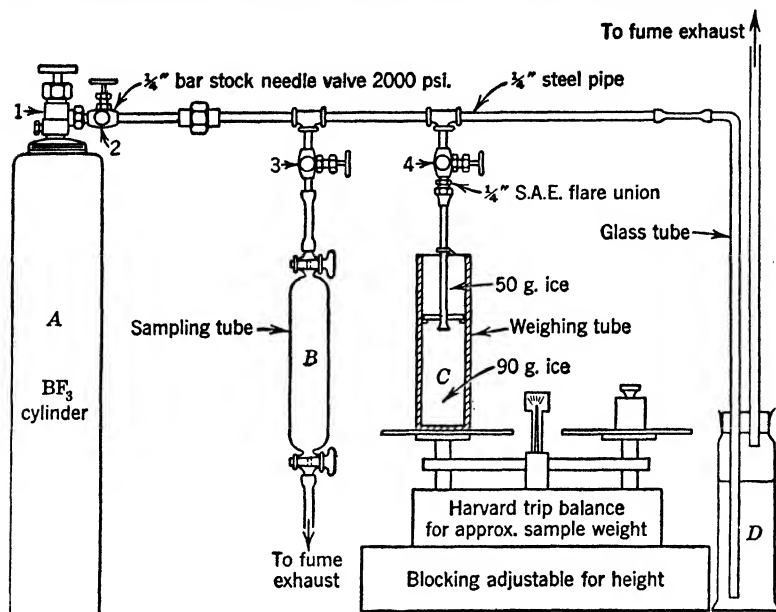

FIG. 7-3. Apparatus for sampling boron trifluoride
(Courtesy Industrial and Engineering Chemistry)

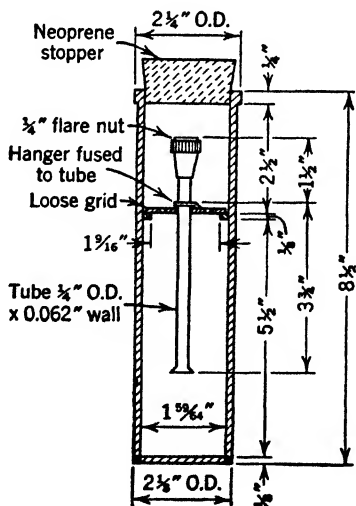

FIG. 7-4. Sample-weighing tube
(Courtesy Industrial and Engineering Chemistry)

Sampling. *A* (in Figure 7-3) is the cylinder containing the boron trifluoride to be analyzed. Since its critical temperature is $-12.25^{\circ}\text{C}.$, there is no liquid phase in the cylinder and hence no segregation.

B is a 250-ml. Pyrex sampling tube to receive the sample for determination of water-insoluble gases, such as air.

C is the Saran weighing tube (see Figure 7-4 for detail) in which the sample for the determination of water-soluble gases is collected and weighed.

D is a safety trap (containing carbon tetrachloride) for limiting the pressure in the manifold.

Procedure. First, flush the entire manifold system for at least 5 minutes with the boron trifluoride from *A*; then, just before attaching *B* and the Saran delivery tube of *C*, open valves 3 and 4, and flush them also for 15 seconds.

Water-Insoluble Gases. Determine the capacity of the glass sampling tube, *B*; clean, and dry by sweeping with dry air or by filling with dry air and evacuating ten times. Leave filled with dry air with stopcocks closed.

After the manifold has been flushed with boron trifluoride as previously described, open valve 3 for a few seconds, and then quickly attach sampling tube by means of the rubber connecting tubing, open the stopcocks, and pass the gas through the tube *B* for 15 minutes. Close the upper stopcock, the lower stopcock, and then valve 3, and proceed with the analysis as described below in detail by the authors.

Water-Soluble Gases.* Before taking this sample, set up the Harvard trip balance with *C* as shown in Figure 7-3. Add enough weights to hold *C* at its highest position on the balance. Loosely couple the Saran delivery-tube assembly of *C* to valve 4 adapter; then raise or lower the balance so that the hanger on the delivery tube is in line with the top of the weighing tube.

Caution. This adjustment is necessary to prevent suck-back of liquid into valve 4 when the ice melts. Disconnect the Saran delivery-tube assembly, and dry it by blowing with dry air or by a combination of warming in an oven at $105^{\circ}\text{C}.$ for a few minutes and blowing with dry air. Dry the neoprene stopper by blotting with a clean cloth. The weighing tube is most conveniently dried by rinsing in alcohol and blowing with dry air until the odor of alcohol is gone.

* Quoted, by permission, from the Analytical Edition, *Industrial & Engineering Chemistry*.

Weigh the entire dried weighing tube (Saran delivery-tube assembly and stopper) on a torsion balance having a sensitivity of 15 mg. and capacity of 500 grams, using rough weights or an approximate tare weight, and balance exactly. Test the accuracy of this torsion balance for such factors as equality of arms and positioning of weights, and make suitable corrections if the errors are in excess of 20 mg. After thus establishing the weight of the entire weighing tube, do not disturb the tare weights, for succeeding weighings must be made by adding only analytical quality weights. From this point on complete the sampling as quickly as possible.

Place about 90 grams of chopped ice in the bottom part of the weighing tube. Properly insert the Saran delivery tube, so that the perforated disk rests flat on the narrow ledge, and the hanger rests over the rim of the weighing tube. Add about 50 grams more of chopped ice to the top part of the weighing tube above the perforated disk. Wipe off any droplets of water on the outside of the weighing tube or on the coupling of the delivery tube. Weigh exactly on the torsion balance, adding only analytical weights. Check this weight immediately after wiping off water condensed on the outside of the weighing tube. Record the weight of ice.

The 90 grams of ice in the bottom serve to absorb the heat of reaction of boron trifluoride, and the 50 grams in the top section serve to trap any cloud formed by boron trifluoride contacting water vapor. The ice must not greatly exceed 140 grams. This amount, when melted with 20 grams of sample, will not bring the liquid level above the outlet of the Saran delivery tube. If the setup is exactly as described above, ample clearance is assured.

Absorbing and Weighing Sample. Immediately after flushing the manifold and valve 4 as described, couple the Saran delivery tube to the adapter on valve 4, and tighten it with pliers. Balance with rough weights, make certain that the delivery tube does not hinder the balance swing, then add a 20-gram weight to overbalance the tube. Carefully open valve 4, and adjust the flow of boron trifluoride, so that no cloud appears over the top of the ice in the weighing tube. During the flow, watch the top of the weighing tube for the appearance of a cloud in the ice, and as soon as noticed reduce the flow. Keep testing the balance to make certain that its swing is not hindered by shifting ice. After the 20-gram weight is slightly overbalanced, close valve 4, disconnect the Saran delivery tube, and carefully drop it into the weighing tube before removing from balance. Tightly stopper the weighing tube without delay.

Weigh on the torsion balance, adding more analytical weights. Record the additional weight over the ice weight as the water-soluble sample weight. Mix thoroughly by careful inversion until all of the ice melts, being certain to keep the tube tightly stoppered, so that none of the liquid is lost before the solution becomes homogeneous. Remove the Saran delivery tube and restopper immediately to avoid loss of sulfur dioxide. The diluted acid clinging to the Saran delivery tube

is of no consequence, since aliquot weights of the solution are taken for analysis. Proceed with the determination of water-soluble gases as described below.

ANALYSIS

Air. Connect one end of the sampling tube *B* to a 500-ml. leveling bulb containing 400 ml. of sodium chloride solution (300 grams dissolved in 1.0 liter of water) and the other end to a gas buret also filled with the sodium chloride solution. Take care to have no air bubbles in these connections. A trace of a wetting agent such as Ultrawet (Atlantic Refining Co.) in the salt solution assists in freeing small air bubbles from the walls of connecting tubes. Clamp *B* in a vertical position, and allow the solution in the leveling bulb to run up into *B*, rapidly at first but slowly at the end, lest the impact of the solution break the glass. After absorption is complete, draw the insoluble gas into the buret, and record the volume of air and the buret temperature.

Sulfur Dioxide. This must be the first water-soluble constituent determined, because opening the weighing tube for other aliquot samples may result in loss of sulfur dioxide.

In a 250-ml. beaker place 50 ml. of water and exactly 10 ml. of standard 0.1 *N* iodide-iodate solution, and weigh on a torsion balance. Place a 50-gram weight on the balance pan, then add the sample to the beaker until slightly overbalanced. Weigh to the nearest 0.5 gram. Immediately back-titrate the excess liberated iodine with standard 0.1 *N* thiosulfate, using starch solution as indicator.

Standardize the iodide-iodate solution against the standard thiosulfate under like conditions, substituting 50 ml. of water for the sample and making acid with 5 ml. of 1-to-1 sulfuric acid.

Calculate the equivalent thiosulfate for the aliquot to grams of sulfur dioxide in the entire water-soluble weight absorbed in *C*, by the following equation, which also applies to the other water-soluble gases.

$$\frac{\left\{ \begin{array}{l} \text{(Ml. of standard solution)} \times \\ \text{(factor } X) \times \text{(grams of ice + grams of sample)} \end{array} \right\}}{\text{Grams of aliquot}} = \text{grams of } X$$

Factor *X* = (normality of standard solution) \times (milliequivalent weight of *X*)

1 ml. of *N* thiosulfate \approx 0.032 gram of SO_2

The above procedure is satisfactory for the determination of sulfur dioxide in commercial boron trifluoride. It is accurate when the sulfur dioxide content is below 0.2%. Above this amount some may be lost when opening the sampling tube to remove the delivery assembly and weighing the aliquot.

When the sulfur dioxide content is much above 0.2%, a more accurate procedure is to take a separate sample from the cylinder and with the ice add a measured excess of iodide-iodate solution and 5 grams

of potassium iodide, then back-titrate the excess liberated iodine as above. By this more accurate procedure an increase of 0.05% over the recommended procedure may be expected when the content is around 0.75%.

Silicon Tetrafluoride. Weigh into a 75-ml. platinum dish 1 gram of reagent sodium fluoride and 5.0 grams of the sample. Add 5 ml. of 0.5 *N* hydrochloric acid and 5 ml. of water. Place the dish on a steam bath, and stir with a plastic or platinum rod until the sodium fluoride dissolves. Evaporate to dryness, remove the dish from the steam bath, and add 20 ml. of ethyl alcohol and 10 ml. of carbon dioxide-free water.

The products formed when boron trifluoride is absorbed in ice are complex in behavior and not clearly understood. Gasselin writes the equation as follows to account for the alkali consumed before and after the addition of glycerol or mannitol:

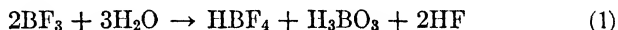

This reaction is an oversimplification, since the fluoride ions of hydrofluoric acid are not found in this solution. It acts as if something like an easily hydrolyzed form of fluoboric acid were present. In any case, hydrolysis and the buffered behavior seriously interfere with a direct titration of silicon tetrafluoride, the solution of which in water may be represented as follows:

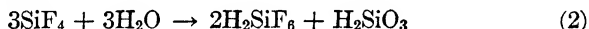

Evaporation of the solution with sodium fluoride containing some hydrochloric acid forms a mixture of salts consisting of sodium fluoborate, sodium fluosilicate, sodium acid fluoride, sodium fluoride, and sodium chloride. Assuming Equation 1 for the solution of boron trifluoride, the conversion upon evaporation would be as follows:

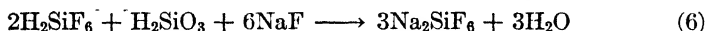
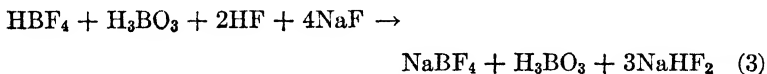

An excess of sodium fluoride is desirable to allow for variations in the original boron trifluoride sample weights. The 1 gram called for in the method is a 33% excess for the 5-gram aliquot of a 20-gram sample in 140 grams of ice. The addition of hydrochloric acid is a convenient way of forming sodium acid fluoride (Equation 5), which aids the completion of the reaction shown in Equation 4. Alcohol is added to prevent partial hydrolysis of sodium fluoborate; sodium fluosilicate does not dissolve in 50% or stronger alcohol. Ethyl alcohol was used in this work. Methyl or isopropyl alcohols are fair substitutes.

Stir and break up the lumps until the salts become disintegrated. Add 5 drops of phenolphthalein indicator, and titrate with 0.5 *N* sodium hydroxide to a pink color that remains permanent during 30 seconds of continuous stirring. (Sodium hydroxide should always be used for this titration; if potassium hydroxide is used, potassium fluoborate precipitates and occludes some sodium acid fluoride which cannot be conveniently leached out. The sodium hydroxide should be silica-free. It should be stored in a wax-lined bottle or steel drum and not allowed to stand in a glass buret longer than necessary.) Disregard this titration (3.5 to 4.5 ml.) because the acidity is due to acid fluoride with which we have no concern except to neutralize it exactly. Pour the contents of the dish into a 250-ml. beaker. Nearly fill the dish with carbon dioxide free water (at 25°C.), stir somewhat to aid solution of the insoluble residue, and pour into the beaker. Rinse the dish twice in this manner to dissolve and completely transfer contents to beaker. To the beaker add 10 more drops of phenolphthalein indicator, and without delay titrate with standard 0.1 *N* alkali to a faint pink color remaining permanent 15 seconds. (Sodium fluoborate hydrolyzes in aqueous solution to a small extent. No serious error results if a 15-second end point is accepted.) This titration is equivalent to the four fluorine atoms in silicon tetrafluoride plus the reagent blank. Run the blank according to this procedure, substituting 5 ml. of water for the sample.

Calculate to grams of silicon tetrafluoride in the entire water-soluble sample weight absorbed in C, using the general equation given above under sulfur dioxide,

$$1 \text{ ml. of } N \text{ alkali} \approx 0.02600 \text{ gram of SiF}_4$$

Sulfur Trioxide. Sulfur trioxide is not likely to be present. If present, it will be very little and may be disregarded in the final calculation.

On a torsion balance weigh 50 grams of the sample into a 400-ml. beaker, and dilute to about 100 ml. Add a drop of methyl orange indicator, and make slightly ammoniacal. Digest hot, several minutes to hydrolyze fluosilicate, filter, and wash moderately with water. To the filtrate add 4 ml. of 1-to-1 hydrochloric acid, precipitate with barium chloride, and determine the sulfate in the usual manner.

Boron Trifluoride. Weigh a glass or platinum weighing bottle half-filled with water on the analytical balance. Add as quickly as possible 50 to 60 drops (3 to 4 grams) of the solution of the sample by means of a dropping pipet, cover the bottle promptly, and reweigh. Carefully wash the sample into a 300-ml. Erlenmeyer flask containing 5 grams of neutral calcium chloride dissolved in 25 ml. of water, add one drop of methyl orange indicator, and titrate with standard 0.5 *N* alkali to a yellow color. Record this titration and all succeeding titrations. Heat to a gentle boil, and digest at about 90°C. for 10 minutes.

Titrate the hot solution to an approximate end point. If the sulfur dioxide content is above 0.2%, the methyl orange indicator may be

destroyed. In such cases the solution should be cooled somewhat and another drop of indicator added before titration.

Repeat the boiling and digestion, until only 1 ml. or less of alkali is required to reach an approximate end point. Boil and digest at 90°C. for 30 minutes. Cool to room temperature, and titrate to an exact end point. Repeat the boiling, 30-minute digestion, and cooling until no more acidity develops. The total amount of alkali required is equivalent to sulfur dioxide, silicon tetrafluoride, and boron trifluoride. Calculate to grams of boron trifluoride in the total water sample weight, using the general equation given under sulfur dioxide, and from this value deduct the sum of: grams of sulfur dioxide \times 0.706, and grams of silicon tetrafluoride \times 0.869, to obtain grams of boron trifluoride,

$$1 \text{ ml. of } N \text{ alkali} \approx 0.02260 \text{ g. BF}_3$$

Calculations. The above determinations on the water-soluble gas give the grams of each constituent in the sample. In order to calculate weight percentage of each, a calculated weight of the air (the insoluble gas) must be added to obtain the true sample weight.

The insoluble gas is assumed to be air, and the volume measured (over salt solution) is corrected for moisture and temperature in order to have it under the same conditions as the gas in sample tube *B*.

$$\text{Milliliters of air in } B = \text{ml. measured} \left[\frac{P - p}{P} \times \frac{273 + t'}{273 + t''} \right]$$

t' = temperature of *B* when sample tube is filled

t'' = temperature of buret when air is measured

p = vapor pressure of 23 weight % sodium chloride solution at t''

P = barometric pressure

The barometric pressure has little effect when the percentage is small.

Table 42 gives approximate values for the factor $\left[\frac{P - p}{P} \times \frac{273 + t'}{273 + t''} \right]$,

which are applicable at barometric pressures from 720 to 760 mm.

TABLE 42
CORRECTION FACTORS FOR AIR VOLUME

Temperature, t' of <i>B</i> When Filled, °C.	Temperature t'' of Buret			
	10°C.	20°C.	30°C.	40°C.
10	0.99	0.95	0.92	0.85
20	1.02	0.98	0.94	0.88
30	1.06	1.01	0.97	0.91
40	1.10	1.05	1.00	0.94

The ratio of the corrected volume of air in B to the volume of water-soluble gas in B , $\left[\frac{\text{ml. of air in } B}{(\text{volume of } B \text{ in ml.}) - (\text{ml. of air in } B)} \right]$, permits the calculation of a weight of air corresponding to the water-soluble sample in C as follows:

$$\text{Grams of air} = L_N(\text{air}) \times \left[\frac{\text{ml. of air in } B}{(\text{volume of } B \text{ in ml.}) - (\text{ml. of air in } B)} \right] \times \left[\frac{\text{grams of } \text{BF}_3}{L_N(\text{BF}_3)} \times \frac{\text{grams of } \text{SO}_2}{L_N(\text{SO}_2)} \times \frac{\text{grams of } \text{SiF}_4}{L_N(\text{SiF}_4)} \right]$$

$L_N(\quad)$ is the density of the respective gases at 0°C . and 760 mm. Substituting these values, the equation becomes

$$\begin{aligned} \text{Grams of air} = 1.29 \times \left[\frac{\text{ml. of air in } B}{(\text{ml. of } B) - (\text{ml. of air in } B)} \right] \times \\ [(\text{grams of } \text{BF}_3 \times 0.325) + (\text{grams of } \text{SO}_2 \times 0.34) \\ + (\text{grams of } \text{SiF}_4 \times 0.21)] \end{aligned}$$

True sample weight = water-soluble sample weight + grams of air.

$$\% \text{BF}_3 = \frac{\text{grams of } \text{BF}_3 \times 100}{\text{true sample weight}}$$

$$\% \text{SO}_2 = \frac{\text{grams of } \text{SO}_2 \times 100}{\text{true sample weight}}$$

$$\% \text{SiF}_4 = \frac{\text{grams of } \text{SiF}_4 \times 100}{\text{true sample weight}}$$

$$\% \text{Air} = \frac{\text{grams of air} \times 100}{\text{true sample weight}}$$

Total acidity corrected for sulfur dioxide is essentially a determination of total fluorine which after correction for silicon tetrafluoride is calculated to boron trifluoride. This is permissible, since no appreciable amounts of other acidic gases are to be expected in commercial boron trifluoride. The correction for sulfur dioxide may be uncertain, because of small losses in steps subsequent to the absorption of the sample in ice, especially when the sulfur dioxide content is in excess of 0.2%. A total boron determination is not usually required for commercial boron trifluoride. However, experiments have shown that, if the heating periods in the presence of calcium chloride solution for total acidity are carried out under a reflux condenser, the total boron as boric acid can be titrated as a second step after adding glycerol, invert sugar, or mannitol.

DETERMINATION OF BORON TRIFLUORIDE IN ORGANIC COORDINATION COMPOUNDS

A rapid method for the analysis of boron trifluoride coordination compounds was evolved by Walters and Miller: ⁽⁹³⁵⁾ 5 g. of anhydrous sodium fluoride is weighed in a stoppered flask, and a 2-g. sample of the boron trifluoride-ether complex is added in a weighing bottle in a "dry-air box." After refluxing for 30 minutes, the reflux condenser is removed, and the volatile organic matter is distilled off, and flask, residue, and tared weighing bottle are all weighed. The sodium fluoride combines with the boron trifluoride in the complex to form the fluoborate which remains in the residue. The accuracy is said to be within 0.5%, with results usually high. One requirement is that the organic component of the complex should have a boiling point below 200°C. Nonvolatile impurities would give high results in this procedure; hence, it may not be adequate for commercial organic coordination compounds.

Pflaum and Wenzke ⁽⁷¹²⁾ described a more precise procedure: The boron trifluoride-organo complex is weighed in a small gelatine capsule and placed in the cup of a Parr sulfur bomb along with a mixture of 10 g. sodium peroxide, 1 g. potassium chlorate, and 0.5 g. sugar. The mixture is ignited with the aid of a pure iron wire. The fusion product is dissolved in water, and the resulting solution is boiled with 15 g. of ammonium chloride to reduce the alkalinity.

To the hot solution 2 *N* calcium nitrate solution is added dropwise and also a filter accelerator; sometimes it is necessary to add a little ammonium hydroxide here to complete the precipitation. The suspension is cooled (to decrease solubility of calcium fluoride), filtered, and ignited to give a residue of calcium fluoride.

The boron is determined in the filtrate. Sufficient sodium hydroxide solution is added to the filtrate to precipitate some calcium carbonate, and then the solution is boiled until the steam is free from ammonia. Cool, make an aliquot part neutral to methyl orange, and titrate with sodium hydroxide in the presence of mannitol and phenolphthalein.

8

Practical Handling of Boron Trifluoride

Boron trifluoride is available commercially and is shipped, as a gas under high pressure, in two sizes of steel cylinders, one containing 60 pounds net in a cylinder of 2640 cubic inches capacity at pressures between 1500 and 1800 pounds per square inch, and another smaller size containing only 6 pounds.⁽⁸⁸⁴⁾ At temperatures above -12.25°C . no liquid phase is present in the cylinders.

Commercially boron trifluoride is compressed with oil as lubricant; therefore, it should not be used with oxygen under pressure, nor should oxygen be introduced into lines, valves, gages, etc., that have contained boron trifluoride, for fear of an explosion.

Since boron trifluoride is reactive with water, alcohol, ether, esters, and so on (see Chapter 4), introduction of the gas below the surface of such a liquid is hazardous owing to the possibility of the liquid siphoning into the cylinder. This should be guarded against by vacuum breaks or other safety devices. An excellent procedure is to bubble the gas up through a layer of mercury above which is the liquid to be saturated.

At high concentrations boron trifluoride will cause burns on the skin similar to but not so penetrating as hydrogen fluoride. First-aid treatment is to wash the surface with large amounts of cold water followed by application of a wet dressing of a paste of magnesium oxide, magnesium sulfate, and glycerine. Subsequent treatment by a physician should follow the procedure prescribed for anhydrous hydrogen fluoride burns. The gas itself is very irritating to the respiratory tract. In any case the patient should be placed in the care of a physician as soon as possible. Although the toxicity of the gas to humans is unknown, no medical evidence of chronic effects have been found among workmen who have frequently been exposed to small amounts for periods up to 7 years. The pungent white fumes of the gas are difficult to breathe which is sufficient warning.

Recently Marcovitch ⁽⁶⁷⁵⁾ in studies on insect control has found that boron trifluoride has high toxicity for a variety of insects, including grain weevils, bean weevils, bedbugs, and cockroaches.

MATERIALS OF CONSTRUCTION

All fittings, valves, and piping must be strong enough to withstand the maximum pressure that may be encountered, and the assembled equipment should be properly tested before use. Hydraulic testing may be used, provided the system is adequately dried by heating while rinsing at least ten times with *dry air* before admitting boron trifluoride. Boron trifluoride would react instantly with any moisture left in a system. Testing for leaks may be done with dry air and then with boron trifluoride.

For *dry gas*, steel tubing or pipe, forged steel fittings, steel-to-steel ground unions, and bar-stock valves give the best service. For low-pressure low-temperature lines, malleable-iron fittings may be used. Copper tubing and brass fittings are also satisfactory. Glass, preferably Pyrex, may be used for low pressures. Although heavy-walled rubber tubing can be used for temporary connections at low pressures, in time it becomes hard and brittle and unreliable as a result of the action of the boron trifluoride. Neoprene is more resistant than natural rubber.

For *moist gas* and dilute solutions, copper, Saran tubing, hard rubber, paraffin wax, and Pyrex glass are fairly resistant. Iron is not seriously attacked at room temperature when only small amounts of water are present.

Pipe threads should be cleanly cut and tightly fitted with care. Litharge and oil make a good pipe dope. A soft Vistanex * No. 6, dissolved in carbon tetrachloride, with or without the incorporation of graphite, also makes a good pipe dope. All have the advantage that the pipes are easily disconnected afterwards.

Packing Materials. Bar-stock valves are usually packed satisfactorily as supplied. Packings made of asbestos, graphite, and oil, such as Garlock No. 115, are suitable. Packings containing rubber, fiber, polymerizable materials, or materials containing hydroxyl groups must be avoided as they are attacked by boron trifluoride. Gaskets of Saran, Kel-F, or of Teflon are satisfactory.

* Produced by Standard Oil Co. of New Jersey by polymerizing isobutylene by means of boron trifluoride. ^(298, 661, 686, 836, 941, etc.)

Confining Liquids. For low-pressure gasholders, vacuum breaks, manometers, and the like, mercury, white mineral oil, petroleum spirits (mineral spirits, ASTM—D-235-39), and carbon tetrachloride are typical liquids in which boron trifluoride has low solubility. Unsaturated compounds should be avoided since boron trifluoride catalyzes their polymerization.

Flow Control and Measurement. No standard pressure-reducing regulator for boron trifluoride has as yet been developed. A hand-operated bar-stock needle valve should be attached to the cylinder or manifold for this purpose. The cylinder valves *must never be used to regulate flow* since they have flat-surface valve stems and are designed only for open or shut service. Owing to the construction of the valve, when it is slightly opened a small quantity of gas may be released, but when opened further, it permits an enormous amount of gas to escape. By opening the cylinder valve full with the outer needle valve closed, delicate control may be obtained with the needle valve. The manufacturer's instructions should be closely followed in handling valves and attaching manifolds.

Cylinders containing boron trifluoride are equipped with special cylinder valves, which are emptying valves and not intended to be used as control valves. The important feature of this valve is that *in the closed position* the entire stem and packing assembly may be removed and replaced while the cylinder is under pressure. This is accomplished by having the plug entirely separated from the stem.

To open valve (refer to Figure 8-1). Before *removing wire*, loosen packing nut slightly, to be sure it is free, and then tighten snugly. While doing this, be sure that the handwheel does not turn. Remove the wire, and check carefully for end play in stem.

Accidental loosening of the packing nut or shrinkage of the packing in transit may allow the stem to assume the position shown in Figure 8-2 when the wire is removed. This will be evidenced by the handwheel turning freely, as though the valve had a broken stem. By pressing down on the handwheel and turning it slowly in the tightening direction, the key on the stem may be entered into the slot on the plug. This brings the stem to the position shown in Figure 8-1. The packing nut should then be tightened snugly while the handwheel is held firmly.

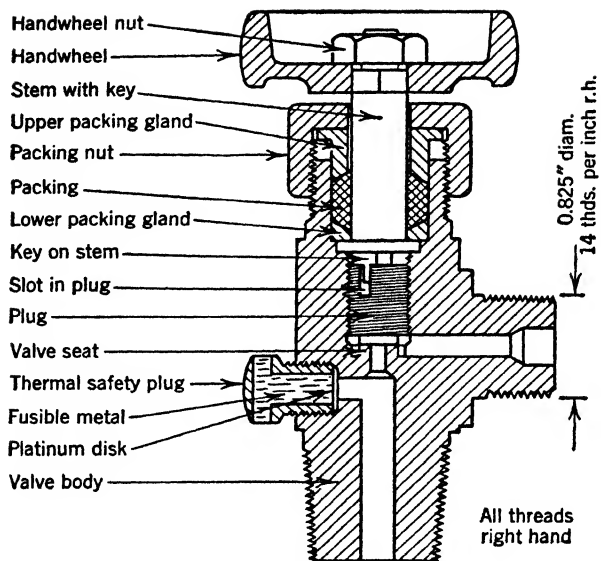

FIG. 8-1. Valve—stem seated
 (Courtesy The Harshaw Chemical Co.)

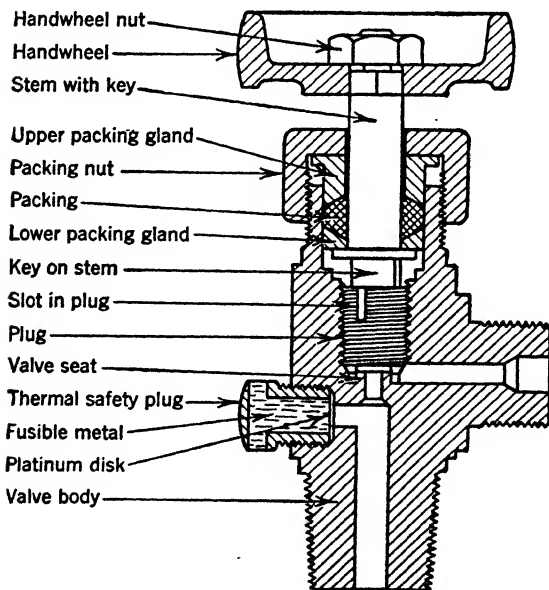

FIG. 8-2. Valve—stem not seated
 (Courtesy The Harshaw Chemical Co.)

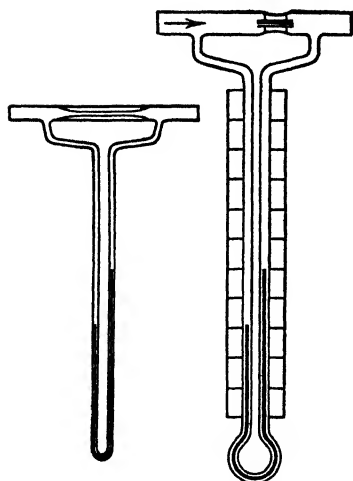

FIG. 8-3. Capillary flowmeter

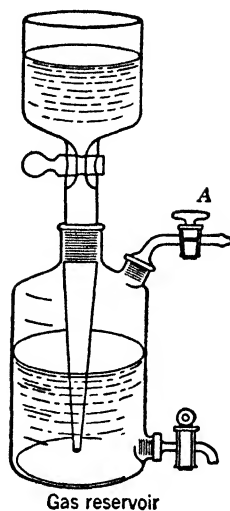

FIG. 8-4. Gas reservoir

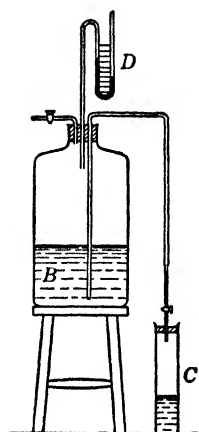

FIG. 8-5. Volume-displacement bottle

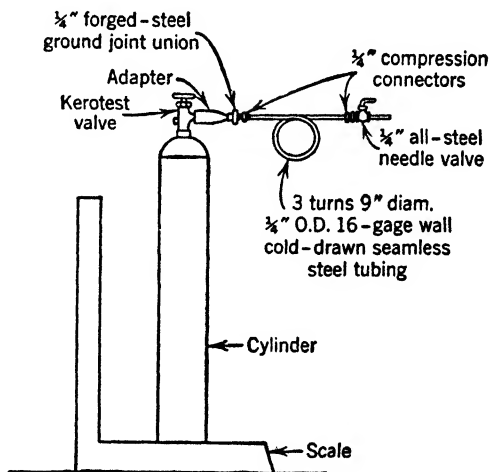

FIG. 8-6. Measuring boron trifluoride from cylinder by weight

(Courtesy The Harshaw Chemical Co.)

It will be found advisable, when opening a valve which has been closed for any length of time, to hold the packing nut with a wrench while the valve is opened.

The previously mentioned confining liquids may be used in low-pressure flowmeters⁽⁸⁹⁾ as in Figure 8-3. An excellent method of measurement of a few liters of the gas is to use calibrated small volume displacement bottles or gasholders (such as shown in Figures 8-4 and 8-5) filled with one of the above confining liquids.

For measuring larger amounts of boron trifluoride a convenient method is to mount the cylinder of boron trifluoride on a platform scale and connect through a reducing needle valve and a 6-foot length of flexible $\frac{1}{4}$ -inch outside diameter 16-gage wall cold-drawn seamless steel tubing to the apparatus receiving the boron trifluoride (Figure 8-6). The change in weight of the cylinder gives a continuous picture of the consumption of the gas.

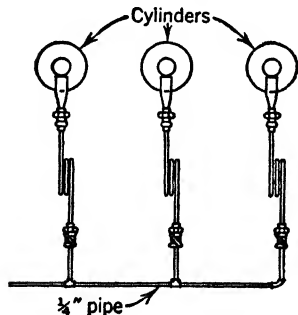

FIG. 8-7. Cylinders connected by means of copper refrigeration fittings (Courtesy The Harshaw Chemical Co.)

Laboratory-Scale Handling of Boron Trifluoride. For laboratory-scale permanent apparatus small copper tubing connected by means of refrigeration fittings (or silver-soldered) may be used but becomes quite bothersome if the design is complicated (Figures 8-6 and 8-7).

In the writers opinion the best way to handle boron trifluoride for research in the laboratory is in an all-glass apparatus with fused connections of either Pyrex or soft glass. Although conical joints may be used to connect parts of the apparatus, there is always the problem of their lubrication to prevent leaks.

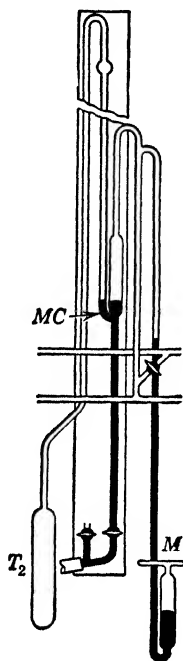

FIG. 8-8. Storage of solidified boron trifluoride in ampule with mercury cutoff (Courtesy *Journal of the American Chemical Society*)

Ordinary rubber-Vaseline (Ramsay) stopcock grease stands up against boron trifluoride only a short time before it hardens and crumbles. We have found that saturation of such greases when warm with boron trifluoride with subsequent thorough evacuation of the melted grease, held at a temperature of 135°C ., yields a fairly satisfactory grease.⁽¹⁰⁰⁾ A soft grade of Vistanex melted with white Vaseline makes a good lubricant; saturation with boron trifluoride with subsequent melting and evacuation improves it. The residue left after vacuum distillation of dark petrolatum below 300°C . also serves as a good grease for use with boron trifluoride.⁽¹⁴²⁾ The stopcock grease with the trade name of Lubriseal also resists boron trifluoride.

Commercially, where equipment which is not resistant to boron trifluoride must be used and where dilution of the boron trifluoride is permissible, a practical solution of the problem is to bleed into a long tube connected to the instrument a slow stream of a gas inert to boron trifluoride. Nitrogen, dry air, and carbon dioxide are examples of gases inert to boron trifluoride.

For a few days on a laboratory scale boron trifluoride may be conveniently stored, solidified by means of liquid air, in a glass ampule with a mercury manometer cutoff⁽⁹⁵⁾ shown in Figure 8-8 to prevent contamination by the vapors of stopcock grease. Because of the low vapor pressure of solid boron trifluoride, after a few days a dark-gray deposit appears in the ampule over the solid BF_3 . This is merely mercury vapor condensed in a finely divided state which remains as a residue when the boron trifluoride is boiled off.

REFERENCES

- 1 ABEGG, R., C. J. J. FOX, and W. HERZ, *Z. anorg. allgem. Chem.*, **35**, 129-47 (1903).
- 2 ADAMS, J. T., B. ABRAMOVITCH, and C. R. HAUSER, *J. Am. Chem. Soc.*, **65**, 552-4 (1943).
- 3 ——— and C. R. HAUSER, *ibid.*, **67**, 284-6 (1945).
- 4 ADELSON, D. E., and H. DANNENBERG (to Shell Development Co.), U. S. Patent 2,331,869 (Oct. 12, 1943).
- 5 ADLER, E., and B. HÄGGLUND, *Arkiv. Kemi, Mineral. Geol.*, **19A**, No. 23 (1945).
- 6 ALLEN, H. D., and W. A. KLINE (to Colgate-Palmolive-Peet Co.), U. S. Patent 2,383,579 (Aug. 28, 1945).
- 6a ALLEN, N., and N. H. FURMAN, *J. Am. Chem. Soc.*, **54**, 4625 (1932).
- 7 ANDERSON, J. A. (to Standard Oil Co. of Ind.), U. S. Patent 2,133,412 (Oct. 18, 1938).
- 8 ——— (to Standard Oil Co. of Ind.), U. S. Patent 2,182,512 (Dec. 5, 1939).
- 9 ——— (to Standard Oil Co. of Ind.), U. S. Patent 2,316,089 (Apr. 6, 1943).
- 10 ——— (to Standard Oil Co. of Ind.), U. S. Patent 2,381,481 (Aug. 7, 1945).
- 11 ANDERSON, T. F., E. N. LASSETTRE, and D. M. YOST, *J. Chem. Phys.*, **4**, 703-7 (1936).
- 12 ANON., *J. Assoc. Official Agr. Chemists*, **2**, II, 149-150 (1916).
- 12a ARKEL, VAN A. E., and G. CARRIÈRE, *Chem. Weekblad*, **33**, 182 (1936).
- 13 ARVESON, M. H. (to Standard Oil Co. of Ind.), U. S. Patent 2,125,872 (Aug. 9, 1938).
- 14 ——— (to Standard Oil Co. of Ind.) U. S. Patent 2,213,331 (Sept. 3, 1940).
- 15 ——— (to Standard Oil Co. of Ind.), U. S. Patent 2,252,486 (Aug. 12, 1941).
- 16 ——— (to Standard Oil Co. of Ind.) U. S. Patent 2,269,421 (Jan. 13, 1942); *C. A.*, **36**, 2962 (1942).
- 17 ASTON, F. W., *Phil. Mag.*, **40**, 628-43 (1920).
- 18 ATWELL, H. V., and H. H. GROSS (to The Texas Co.), U. S. Patent 2,408,186 (Sept. 24, 1946).
- 19 AXE, W. N. (to Phillips Petroleum Co.), U. S. Patent 2,370,118 (Feb. 27, 1945).
- 20 ——— (to Phillips Petroleum Co.), U. S. Patent 2,377,396 (June 5, 1945).
- 21 ——— (to Phillips Petroleum Co.), U. S. Patent 2,378,968 (June 26, 1945).
- 22 ——— (to Phillips Petroleum Co.), U. S. Patent 2,403,963 (July 16, 1946).
- 23 ——— (to Phillips Petroleum Co.), U. S. Patent 2,404,120 (July 16, 1946).
- 24 ——— (to Phillips Petroleum Co.), U. S. Patent 2,404,897 (July 30, 1946).

- 24a AXE, W. N. (to Phillips Petroleum Co.), U. S. Patent 2,412,595 (Dec. 17, 1946).
- 25 — (to Phillips Petroleum Co.), U. S. Patent 2,416,465 (Feb. 25, 1947).
- 25a — (to Phillips Petroleum Co.), U. S. Patent 2,434,093 (Jan. 6, 1948).
- 26 BAILEY, C. R., J. B. HALE, and J. W. THOMPSON, *J. Chem. Phys.*, **5**, 274-5 (1937).
- 27 —, —, and —, *Proc. Roy. Soc. (London)*, A **161**, 107-14 (1937).
- 27a BAIRD, W., B. J. HAGOOD, D. A. HARPER, J. A. HENDRY, and Imperial Ind., Ltd., Brit. Patent 578,012 (June 12, 1946).
- 27b BAKER, C. P., and J. A. BISTLINE, Personal Communication.
- 28 BALDESCHWIELER, E. L. (to Standard Oil Development Co.), U. S. Patent 2,163,232 (June 20, 1939).
- 29 — (to Standard Oil Development Co.), U. S. Patent 2,381,027 (Aug. 7, 1945).
- 30 — and P. G. GAYLOR (to Standard Oil Development Co.), U. S. Patent 2,381,027 (Aug. 7, 1945).
- 31 BALLE, G., and H. SCHILD (to Gen. Aniline and Film Corp.), U. S. Patent 2,210,874 (Aug. 13, 1940).
- 32 BALZ, G., and N. MAILÄNDER, *Z. anorg. allgem. Chem.*, **217**, 161-9 (1934).
- 33 — and G. SCHIEMANN, *Ber.*, **60 B**, 1186-90 (1927).
- 34 — and W. ZINSER, *Z. anorg. allgem. Chem.*, **221**, 225-48 (1935).
- 35 BANNON, I. A. (to Standard Oil Development Co.), U. S. Patent 2,176,194 (Oct. 17, 1939).
- 36 — (to Jasco, Inc.), U. S. Patent 2,317,878 (Apr. 27, 1943).
- 37 — (to Standard Oil Development Co.), U. S. Patent 2,357,926 (Sept. 12, 1944).
- 38 — (to Standard Oil Development Co.), U. S. Patent 2,363,221 (Nov. 21, 1944).
- 39 BARKER, T. V., *J. Chem. Soc.*, **101**, 2484-2502 (1912); *Proc.*, **28**, 253.
- 40 BART, H., Ger. Patent 281,055 (Oct. 7, 1913); *C. A.*, **9**, 1830 (1915).
- 41 BARTLETT, J. H. (to Standard Oil Development Co.), U. S. Patent 2,216,221 (Oct. 1, 1940).
- 42 BASAROW, A., *Ber.*, **7**, 823-4 (1874).
- 43 —, *ibid.*, **7**, 1121-23 (1874); *J. Chem. Soc.*, **27**, 1134-5 (1874).
- 44 —, *Bull. soc. chim.*, (2) **21**, 290 (1874).
- 45 —, *Compt. rend.*, **78**, 1698-1700 (1874); *Bull. soc. chim.*, (2) **22**, 8-11 (1874).
- 46 —, *ibid.*, **79**, 483-5 (1874).
- 47 BAUDRIMONT, A., *Compt. rend.*, **2**, 421 (1836).
- 48 BAUER, S. H., G. R. FINLAY, and A. W. LAUBENGAYER, *J. Am. Chem. Soc.*, **65**, 889-95 (1943).
- 49 —, —, and —, *J. Am. Chem. Soc.*, **67**, 339-41 (1945).
- 50 — and J. HASTINGS, *ibid.*, **64**, 2686-91 (1942).
- 51 BAUMGARTEN, P., and W. BRUNS, *Ber.*, **72 B**, 1753-62 (1939).
- 52 — and —, *ibid.*, **74 B**, 1232-6 (1941).
- 53 — and H. HENNIG, *ibid.*, **72 B**, 1743-53 (1939).

- 54 BAUMGARTEN, P., and E. MÜLLER, *ibid.*, **69 B**, 2688-90 (1936).
54a BAYER AND CO., Ger. Patent 264,925 (Apr. 16, 1912).
55 BEALE, E. B. (to Standard Oil Co. of Ind.), U. S. Patent 2,116,184 (May 3, 1938).
56 BEARSE, A. E., and R. D. MORIN (to Standard Oil Co. of Ind.), U. S. Patent 2,414,999 (Jan. 28, 1947).
57 — and — (to Standard Oil Co. of Ind.), U. S. Patent 2,415,000 (Jan. 28, 1947).
58 BEEKLEY, N. S., Jr., and W. J. SPARKS, U. S. Patent 2,332,194 (Oct. 19, 1943).
59 BERGER, E., *Compt. rend.*, **170**, 1492-4 (1920).
60 BERKMAN, S., J. C. MORRELL, and G. EGLOFF, *Catalysis*, Reinhold Pub. Corp., New York (1940).
61 BERTHELOT, M., *Ann. chim. phys.*, (3) **38**, 38-76 (1853).
62 —, *Compt. rend.*, **82**, 1360-3 (1876).
63 —, *Thermochimie*, **2**, 149 (1897); R. AEBEGG, F. AUREBACH, and I. KOPPEL, *Handbuch der anorganischen Chemie*, S. Hirzel, Leipzig, 1906, Vol. III, p. 19.
64 BERZELIUS, J. J., *Ann. Physik. Chem.*, **77**, 1-48 (1824).
65 —, *ibid.*, **77**, 169-230 (1824).
66 —, *ibid.*, **78**, 113-50 (1824); *Pogg. Ann.*, **2**, 113-50 (1824).
67 —, *Liebig's Annalen*, **46**, 48 (1843).
68 —, *Ann. Phil.*, (2) **10**, 116 (1825).
69 —, *Stockholm Acad. Handl.*, 284-350 (1823).
70 —, *ibid.*, 46-98, 278-328 (1824).
71 BESSON, A., *Compt. rend.*, **110**, 80-2 (1890).
72 BETTS, A. G., Ger. Patent 198,288 (Apr. 2, 1902); *Chem. Zentr.*, **1908**, I, 1998.
72a —, U. S. Patent 679,824 (Aug. 6, 1901).
73 —, U. S. Patents 713,277 and 713,278 (Nov. 11, 1902); reissued as Reissues 12,301 (Jan. 3, 1905) and 12,117 (June 9, 1903).
74 BEYERSTEDT, F. J. (to Standard Oil Development Co.), U. S. Patent 2,284,554 (May 26, 1942).
75 — (to Standard Oil Development Co.), U. S. Patent 2,363,222 (Nov. 21, 1944).
76 BICHOWSKY, F. R., and F. D. ROSSINI, *The Thermochemistry of the Chemical Substances*, Reinhold Pub. Corp., New York (1936), p. 105.
76a BINAFFL, JOSEPH (to I. G. Farbenindustrie A.-G.), Ger. Patent 581,956 (Aug. 8, 1933); Ger. Patents 582,846-7 (Aug. 23, 1933).
77 BIRKS, A. M., and G. F. WRIGHT, *J. Am. Chem. Soc.*, **62**, 2412-21 (1940).
78 BISSINGER, W. E., *Univ. Microfilm Pub.* **235**, Ann Arbor, Mich. (1941).
79 BLOCH, H. S. (to Universal Oil Products Co.), U. S. Patent 2,357,495 (Sept. 5, 1944).
80 BLUM, WILLIAM, *Trans. Am. Electrochem. Soc.*, **39**, 459 (1921).
80a — and H. E. HARING, *ibid.*, **40**, 287-306 (1921).
80b —, F. J. LISCOMB, Z. JENCKS, and W. E. BAILEY, *Trans. Am. Electrochem. Soc.*, **36**, 243 (1919).
81 BOEHM, G., *Arch. expl. Path. u. Pharmacol.*, **146**, 327-46 (1929).

- 82 BOEHM, G., *Biochem. Z.*, **209**, 489-91 (1929).
- 83 DE BOER, J. H., *Physica*, **7**, 99-101 (1927).
- 84 —, *Rec. trav. chim.*, **48**, 979-83 (1929).
- 85 —, *Verslag. Akad. Wetenschappen Amsterdam*, **36**, 161-5 (1927).
- 86 — and J. A. M. VAN LIEMPT, *Rec. trav. chim.*, **46**, 124-32 (1927).
- 87 BOLTH, F. A., W. M. WHALEY, and E. B. STARKEY, *J. Am. Chem. Soc.*, **65**, 1456-7 (1943).
- 88 BOOTH, H. S., Personal Communication.
- 89 —, *J. Chem. Educ.*, **7**, 1249-62 (1930).
- 90 —, U. S. Patent 2,053,174 (Sept. 1, 1936).
- 91 — and A. R. BOZARTH, *Ind. Eng. Chem.*, **29**, 470 (1937).
- 92 — and J. M. CARTER, *J. Phys. Chem.*, **36**, 1359-63 (1932).
- 93 — and S. G. FRARY, *J. Am. Chem. Soc.*, **65**, 1836-7 (1943).
- 94 — and R. McNABNEY, *Ind. Eng. Chem., Anal. Ed.*, **16**, 131 (1944).
- 95 — and D. R. MARTIN, *J. Am. Chem. Soc.*, **64**, 2198-2205 (1942).
- 96 — and —, *Chem. Revs.*, **33**, 57 (1943).
- 97 — and S. REHMAR, *Inorganic Syntheses*, McGraw-Hill Book Co., New York (1946), Vol. II, p. 23.
- 98 — and J. H. WALKUP, *J. Am. Chem. Soc.*, **65**, 2334-9 (1943).
- 99 — and K. S. WILLSON, *Inorganic Syntheses*, McGraw-Hill Book Co., New York (1939), Vol. I, p. 21.
- 100 — and —, *J. Am. Chem. Soc.*, **57**, 2273-80 (1935).
- 101 — and —, *ibid.*, **57**, 2280-4 (1935).
- 102 BORGLIN, J. N. (to the Hercules Powder Co.), U. S. Patent 2,081,890 (May 25, 1937).
- 103 — (to The Hercules Powder Co.), U. S. Patent 2,120,015 (June 7, 1938).
- 104 — (to The Hercules Powder Co.), U. S. Patent 2,327,165 (Aug. 17, 1943).
- 105 — (to The Hercules Powder Co.), U. S. Patent 2,394,359 (Feb. 5, 1946).
- 106 BOUCHETAL DE LA ROCHE, *Bull. soc. chim.*, (**4**) **47**, 1326-31 (1930).
- 107 BOWLUS, H., and J. A. NIEUWLAND, *J. Am. Chem. Soc.*, **53**, 3835-40 (1931).
- 108 BRAUNE, H., and P. PINNOW, *Z. physik. Chem.*, **B 35**, 239-55 (1937).
- 109 BRESLOW, D. S., and C. R. HAUSER, *J. Am. Chem. Soc.*, **62**, 2385-8 (1940).
- 110 — and —, *ibid.*, **62**, 2611-2 (1940).
- 111 BRIGHT, J. R., and W. C. FERNELIUS, *ibid.*, **65**, 735-6 (1943).
- 112 BRISCOE, H. V. A., and P. L. ROBINSON, *J. Chem. Soc.*, **127**, 696-720 (1925).
- 113 BROWN, H. C., and R. M. ADAMS, *J. Am. Chem. Soc.*, **64**, 2557-63 (1942).
- 114 — and —, *ibid.*, **65**, 2253-4 (1943).
- 115 —, H. I. SCHLESINGER, and A. B. BURG, *ibid.*, **61**, 673-80 (1939).
- 116 —, —, and S. Z. CARDON, *ibid.*, **64**, 325-9 (1942).
- 117 BRUNER, F. H. (to The Texas Co.), U. S. Patent 2,363,116 (Nov. 21, 1944).

- 118 BRUNER, F. H., L. A. CLARKE, and R. L. SAWYER (to The Texas Co.), U. S. Patent 2,345,095 (Mar. 28, 1944).
- 119 —, —, and — (to The Texas Co.), U. S. Patent 2,376,119 (May 15, 1945).
- 120 BRUSON, H. A. (to The Goodyear Tire and Rubber Co.), U. S. Patent 1,846,247 (Feb. 23, 1932).
- 121 — (to The Goodyear Tire and Rubber Co.), U. S. Patent 1,853,334 (Apr. 12, 1932).
- 122 — (to The Resinous Products and Chemical Co.), U. S. Patent 1,892,-101 (Dec. 27, 1932).
- 123 — (to The Röhm and Haas Co.), U. S. Patent 2,198,374 (Apr. 23, 1940).
- 124 — (to The Resinous Products and Chemical Co.), U. S. Patent 2,309,-335 (Jan. 26, 1943).
- 125 — (to The Röhm and Haas Co.), U. S. Patent 2,313,621 (Mar. 9, 1943).
- 126 — (to The Resinous Products and Chemical Co.), U. S. Patent 2,358,-314 (Sept. 19, 1944).
- 127 — (to The Resinous Products and Chemical Co.), U. S. Patent 2,375,767 (May 15, 1945).
- 128 — (to The Resinous Products and Chemical Co.), U. S. Patent 2,375,768 (May 15, 1945).
- 129 — (to The Resinous Products and Chemical Co.), U. S. Patent 2,376,865 (May 29, 1945).
- 130 — (to The Resinous Products and Chemical Co.) U. S. Patent 2,381,433 (Aug. 7, 1945).
- 131 — (to The Resinous Products and Chemical Co.), U. S. Patent 2,385,787 (Oct. 2, 1945).
- 132 — (to The Resinous Products and Chemical Co.), U. S. Patent 2,393,608 (Jan. 29, 1946).
- 133 — (to The Resinous Products and Chemical Co.), U. S. Patent 2,393,609 (Jan. 29, 1946).
- 134 — (to The Resinous Products and Chemical Co.), U. S. Patent 2,393,610 (Jan. 29, 1946).
- 135 — (to The Resinous Products and Chemical Co.), U. S. Patent 2,393,611 (Jan. 29, 1946).
- 136 — (to The Resinous Products and Chemical Co.), U. S. Patent 2,394,582 (Feb. 12, 1946).
- 137 — (to The Resinous Products and Chemical Co.), U. S. Patent 2,395,452 (Feb. 26, 1946).
- 137a — (to The Resinous Products and Chemical Co.), U. S. Patent 2,411,516 (Nov. 26, 1946).
- 138 — and T. W. RIENER (to The Resinous Products and Chemical Co.), U. S. Patent 2,376,340 (May 22, 1945).
- 139 BRYANT, R. C., M. A. Thesis, Western Reserve Univ., Cleveland, Ohio (1929).
- 140 BUCHNER, M., U. S. Patent 1,730,915 (Oct. 8, 1929).
- 141 BUCKERIDGE, W. I. (to Standard Oil Co. of Ind.), U. S. Patent 2,182,513 (Dec. 5, 1939).

- 142 BURCH, C. R., *Nature*, **122**, 729 (1928); *Proc. Roy. Soc. (London)*, **123**, 271 (1929).
- 143 BURG, A. B., *J. Am. Chem. Soc.*, **62**, 2228-34 (1940).
- 144 — and J. H. BICKETON, *ibid.*, **67**, 2261 (1945).
- 145 — and SISTER A. A. GREEN, *ibid.*, **65**, 1838-41 (1943).
- 146 — and L. L. MARTIN, *ibid.*, **65**, 1635-7 (1943).
- 147 — and M. K. ROSS, *ibid.*, **65**, 1637-8 (1943).
- 148 BURK, R. E. (to The Standard Oil Co. of Ohio), U. S. Patent 2,232,435 (Feb. 18, 1941).
- 149 — (to The Standard Oil Co. of Ohio), U. S. Patent 2,343,744 (Mar. 7, 1944).
- 150 — (to The Standard Oil Co. of Ohio), U. S. Patent 2,343,841 (Mar. 7, 1944).
- 151 — (to The Standard Oil Co. of Ohio), U. S. Patent 2,345,574 (Apr. 4, 1944).
- 152 — (to The Standard Oil Co. of Ohio), U. S. Patent 2,385,344 (Sept. 25, 1945).
- 153 — (to The Standard Oil Co. of Ohio), U. S. Patent 2,400,874 (May 28, 1946).
- 154 — (to The Standard Oil Co. of Ohio), U. S. Patent 2,405,993 (Aug. 20, 1946).
- 155 — (to The Standard Oil Co. of Ohio), U. S. Patent 2,405,994 (Aug. 20, 1946).
- 156 — (to The Standard Oil Co. of Ohio), U. S. Patent 2,405,995 (Aug. 20, 1946).
- 157 — (to The Standard Oil Co. of Ohio), U. S. Patent 2,405,996 (Aug. 20, 1946).
- 158 — (to The Standard Oil Co. of Ohio), U. S. Patent 2,405,997 (Aug. 20, 1946).
- 159 — (to The Standard Oil Co. of Ohio), U. S. Patent 2,408,752 (Oct. 8, 1946).
- 160 — (to The Standard Oil Co. of Ohio), U. S. Patent 2,408,753 (Oct. 8, 1946).
- 161 — and E. C. HUGHES (to The Standard Oil Co. of Ohio), U. S. Patent 2,399,662 (May 7, 1946).
- 162 — and — (to The Standard Oil Co. of Ohio), U. S. Patent 2,404,788 (July 30, 1946).
- 163 — and C. H. WHITACKER (to The Standard Oil Co. of Ohio), U. S. Patent 2,179,208 (Nov. 7, 1939).
- 164 — and — (to The Standard Oil Co. of Ohio), U. S. Patent 2,272,866 (Feb. 10, 1942).
- 165 BURWELL, R. L., and S. ARCHER, *J. Am. Chem. Soc.*, **64**, 1032-3 (1942).
- 166 BUTLEROW, A., *Ann.*, **189**, 44-83 (1877).
- 167 —, *Ber.*, **9**, 1605 (1876).
- 168 — and W. GORAINOW, *ibid.*, **6**, 561 (1873).
- 169 CADE, GEO. N., R. E. DUNN, and H. J. HEPP, *J. Am. Chem. Soc.*, **68**, 2454 (1946).
- 170 CANN, J. R., and E. D. AMSTUTZ, *ibid.*, **66**, 839-40 (1944).
- 171 CANNIZZARO, S., *Liebig's Ann.*, **92**, 113-7 (1854).

- 172 CARLSON, A. E., and M. J. KRANE, *Monthly Rev. Am. Electroplaters Soc.*, **32**, 1022-6 (1945).
- 173 CARPENTER, M. S., and C. F. FEUCHTER (to Standard Oil Co. of Ind.), U. S. Patent 2,374,272 (Apr. 24, 1945).
- 174 *Chemische Fabrik Grünau Landshoff und Meyer Akt.-Ges.*, Ger. Patent 627,118 (Mar. 9, 1936).
- 175 CHITWOOD, H. C., and B. T. FREURE, *J. Am. Chem. Soc.*, **68**, 680-2 (1946).
- 176 CLARE, I. C. (to Hercules Powder Co.), U. S. Patent 2,375,752 (May 15, 1945).
- 177 CLARKE, L. A. (to The Texas Co.), U. S. Patent 2,407,136 (Sept. 3, 1946; Brit. Patent 577,292 (Aug. 15, 1946); Can. Patent 427,893 (May 29, 1945).
- 178 — and C. C. TOWNE (to The Texas Co.), U. S. Patent 2,141,593 (Dec. 27, 1938).
- 179 CLEAVELAND, M., Laboratory Notes, Western Reserve Univ., Cleveland, Ohio (1921).
- 180 COFFMAN, D. D. (to E. I. du Pont de Nemours and Co.), U. S. Patent 2,387,495 (Oct. 23, 1945).
- 181 CONAWAY, R. F. (to E. I. du Pont de Nemours and Co.), U. S. Patent 2,370,779 (Mar. 6, 1945).
- 182 CONDIKE, G. F., and A. W. LAUBENGAYER, Abstracts, Atlantic City Meeting, American Chemical Society, Spring 1947.
- 183 CONNOLLY, G. C. (to Standard Oil Development Co.), U. S. Patent 2,398,773 (Apr. 23, 1946).
- 184 COOK, L. W., and C. C. TOWNE (to The Texas Co.), U. S. Patent 2,147,573 (Feb. 14, 1939); Can. Patent 385,648 (Dec. 12, 1939).
- 185 COUNCLER, C., *Ber.*, **12**, 1967 (1879).
- 185a CRANDALL, G. S., and C. H. SCHLESMAN (to Socony-Vacuum Oil Co.), U. S. Patent 2,425,671 (Aug. 12, 1947).
- 186 CROXALL, W. J., F. J. SOWA, and J. A. NIEUWLAND, *J. Am. Chem. Soc.*, **56**, 2054-6 (1934).
- 187 —, —, and —, *ibid.*, **57**, 1549-51 (1935).
- 188 —, —, and —, *J. Org. Chem.* **2**, 253-9 (1937).
- 189 CUEILLERON, JEAN, *Ann. Chim.*, **19**, 459-86 (1944).
- 190 CURTIS, G. H., *Iron Age*, **155**, 54-61 (1945).
- 191 DANFORTH, J. D. (to Universal Oil Products Co.), U. S. Patent 2,342,123 (Feb. 22, 1944).
- 192 — (to Universal Oil Products Co.), U. S. Patent 2,342,124 (Feb. 22, 1944).
- 193 — (to Universal Oil Products Co.), U. S. Patent 2,346,012 (Apr. 4, 1944).
- 194 — (to Universal Oil Products Co.), U. S. Patent 2,346,294 (Apr. 11, 1944).
- 195 DAVY, H., *Ann. chim.*, **88**, 271 (1813).
- 196 —, *Phil. Trans.*, **1808 I**, 1-44; *Nicholson's J.*, **20**, 290-314 (1808); *Nicholson's J. Supp.*, **20**, 321-32 (1808).
- 197 —, *Phil. Trans.*, **1808 II**, 333-70; *Nicholson's J.*, **21**, 366-83 (1808); **22**, 54-68 (1809).

- 198 DAVY, H., *Phil. Trans.*, **1809 I**, 39–104; *Nicholson's J.*, **23**, 241–57 (1809); *Nicholson's J. Supp.* **23**, 321–34 (1809); **24**, 12–24 (1809); **24**, 95–105 (1809).
- 199 DAVY, J., *Phil. Trans.*, **102**, 352–69 (1812); *Ann. chim.*, **86**, 178–203 (1813).
- 200 DAY, R. B. (to Universal Oil Products Co.), U. S. Patent 2,403,342 (July 2, 1946).
- 201 DEANESLEY, R. M., and A. WACHTER (to Shell Development Co.), U. S. Patent 2,181,640 (November 28, 1939).
- 202 DELAVALT, R., *Chimie et Ind.*, **56**, 120 (1946).
- 203 —, *Compt. rend.*, **221**, 498–500 (1945).
- 204 DE LONG, H. K. (to Dow Chemical Co.), U. S. Patent 2,288,995 (July 7, 1942).
- 205 DENOON, C. E., JR., *Org. Syntheses*, **20**, 6–7 (1940).
- 206 — (to E. I. du Pont de Nemours and Co.), U. S. Patent 2,384,731 (Sept. 11, 1945).
- 207 DESFOSES, *Ann. chim. phys.*, **16**, 72–7 (1821).
- 208 DESIMO, M., and F. B. HILMER (to Shell Development Co.), U. S. Patent 2,085,524 (June 29, 1937).
- 209 DEVILLE, H. S. C., and H. CARON, *Compt. rend.*, **46**, 764–8 (1858).
- 210 DICKEY, J. B. (to Eastman Kodak Co.), U. S. Patent 2,113,293 (Apr. 5, 1938).
- 211 — and J. G. McNALLY (to Eastman Kodak Co.), U. S. Patent 2,391,139 (Dec. 18, 1945).
- 212 DORRIS, T. B., and F. J. SOWA, *J. Am. Chem. Soc.*, **60**, 358–9 (1938).
- 213 —, F. J. SOWA, and J. A. NIEUWLAND, *ibid.*, **56**, 2689–90 (1934).
- 214 —, —, and —, *ibid.*, **60**, 656–7 (1938).
- 215 DOWNING, D. C., and G. F. WRIGHT, *ibid.*, **68**, 141–2 (1946).
- 216 DULL, R. B., *Phys. Rev.*, **47**, 458–60 (1935).
- 217 DUMAS, J. B., *Ann. chim. phys.*, (2) **33**, 337–91 (1826).
- 218 —, *Traite de chimie appliquee aux arts Paris*, **1**, 382 (1828); J. W. MELLOR, *A Comprehensive Treatise on Inorganic and Theoretical Chemistry*, Longmans, Green and Co., New York (1924), Vol. 5, p. 122.
- 219 DUNDERMAN, F. V., and S. H. BAUER, *J. Phys. Chem.*, **50**, 32–9 (1946).
- 220 DUNKER, M. F. W., and E. B. STARKEY, *J. Am. Chem. Soc.*, **61**, 3005–7 (1939).
- 221 —, —, and G. L. JENKINS, *ibid.*, **58**, 2308–9 (1936).
- 222 E. I. DU PONT DE NEMOURS AND Co., Brit. Patent 478,085 (Jan. 12, 1938).
- 223 —, Brit. Patent 486,563 (June 7, 1938).
- 224 —, Brit. Patent 486,783 (June 9, 1938).
- 225 —, Brit. Patent 486,877 (June 10, 1938).
- 226 —, Brit. Patent 486,886 (June 13, 1938).
- 227 —, Brit. Patent 486,887 (June 13, 1938).
- 228 —, Brit. Patent 502,680 (Mar. 21, 1939).
- 229 —, Brit. Patent 514,056 (Oct. 30, 1939).
- 229a —, Brit. Patent 516,931 (Jan. 16, 1940).
- 230 —, Brit. Patent 536,422 (May 15, 1941).

- 231 E. I. DU PONT DE NEMOURS AND Co., Brit. Patent 543,029 (Feb. 6, 1942).
231a —, Brit. Patent 566,868 (Jan. 17, 1945).
232 —, Brit. Patent 583,225 (Dec. 12, 1946).
233 —, Fr. Patent 809,175 (Feb. 25, 1937).
234 —, Fr. Patent 814,838 (June 30, 1937).
235 —, Fr. Patent 814,839 (June 30, 1937); Ital. Patent 346,835 (Dec. 14, 1936).
236 EBY, L. T. (to Standard Oil Development Co.), U. S. Patent 2,382,700 (Aug. 14, 1945).
237 EGLOFF, G., *The Reactions of Pure Hydrocarbons*, Reinhold Pub. Corp., New York (1937), p. 322.
238 — (to The Universal Oil Products Co.), U. S. Patent 2,307,773 (Jan. 12, 1943).
239 — (to The Universal Oil Products Co.), U. S. Patent 2,318,765 (May 11, 1943).
240 EICHWALD, E. (to Shell Development Co.), U. S. Patent 2,114,525 (Apr. 19, 1938).
241 — (to Shell Development Co.), U. S. Patent 2,127,811 (Aug. 23, 1938).
242 — (to Shell Development Co.), U. S. Patent 2,152,683 (Apr. 4, 1939).
243 — (to Shell Development Co.), U. S. Patent 2,160,572 (May 30, 1939).
244 — (to Shell Development Co.), U. S. Patent 2,196,670 (Apr. 9, 1940).
245 EISTERT, B., *Z. physik. Chem.*, **B 52**, 202-8 (1942).
246 ELEKTROCHEM. Fab. G. m. b. H., Ger. Patents 580,137 (July 6, 1933); 580,280 (July 8, 1933); 580,365 (July 10, 1933); 580,436 (July 10, 1933); 553,376 (July 31, 1932).
247 —, Ger. Patent 613,620 (May 17, 1935).
248 —, Ger. Patent 614,784 (June 18, 1935).
248a ELMORE, N. M. (to Standard Oil Development Co.), U. S. Patent 2,423,760 (July 8, 1947).
249 ÉTARD, A., *Compt. rend.*, **91**, 931-3 (1880).
250 EUCKEN, A., and E. SCHRÖDER, *Z. physik. Chem.*, **B 41**, 307-19 (1938).
251 EVANS, A. G., D. HOLDEN, P. PLESCH, M. POLANYI, H. A. SKINNER, and M. A. WEINBERGER, *Nature*, **157**, 102 (1946).
252 —, G. W. MEADOWS, and M. POLANYI, *Nature*, **158**, 94-5 (1946).
252a — and M. POLANYI, *J. Chem. Soc.*, **1947**, 252-7.
253 — and M. A. WEINBERGER, *Nature*, **159**, 437-8 (1947).
254 FARADAY, M., *Ann. chim. phys.*, (3) **15**, 257-82 (1945).
255 —, *Liebig's Ann.*, **56**, 155 (1845).
256 —, *Phil. Trans.*, **135**, 155-77 (1845).
257 FERRARI, G., *J. Pharmacy*, (2) **19**, 48 (1833); J. W. MELLOR, *A Comprehensive Treatise on Inorganic and Theoretical Chemistry*, Longmans, Green and Co., New York (1924), Vol. 5, p. 121.
258 FIKENTSCHER, GAETH, and SCHWAB, *Modern Plastics*, **24**, no. 6, 162 (1947).
259 FINBAK, C., and O. HASSEL, *Z. physik. Chem.*, **B 32**, 433-8 (1936).
260 FINGER, G. C., and F. H. REED, *Trans. Ill. State Acad. Sci.*, **33**, 108, 189 (1940).

- 261 FINGER, G. C., and F. H. REED, *J. Am. Chem. Soc.*, **66**, 1972-4 (1944).
- 262 FINKELSTEIN, H., and R. MICHEL (to I. G. Farbenindustrie A.-G.),
Ger. Patent 632,223 (July 4, 1936).
- 263 FINLAY, G. R., *J. Chem. Ed.*, **24**, 149 (1947).
- 264 FISCHER, F., and K. THIELE, *Z. anorg. allgem. Chem.*, **67**, 302-16 (1910).
- 265 —, —, and E. B. MAXTED, *ibid.*, **67**, 339-56 (1910).
- 266 FISCHER, W., *ibid.*, **213**, 97-105 (1933).
- 267 — and W. WEIDEMANN, *ibid.*, **213**, 106-14 (1933).
- 268 FLAHERTY, F. T. (to E. I. du Pont de Nemours and Co.), U. S. Patent
2,211,693 (Aug. 13, 1940).
- 269 — and A. MCALEVY (to E. I. du Pont de Nemours and Co.), U. S.
Patent 2,300,213 (Oct. 27, 1942).
- 269a FLISIK, H., C. F. SWINEHART, and A. BUMBLIS, Private Communica-
tion from the Harshaw Chemical Co. Research Laboratories.
- 269b FORD, T. A. (to E. I. du Pont de Nemours and Co.), U. S. Patent
2,424,653 (July 29, 1947).
- 270 FOSTER, A. L., *Oil Gas J.*, **44**, 89-93 (1945).
- 270a FOWLER, D. L., and C. A. KRAUS, *J. Am. Chem. Soc.*, **62**, 1143 (1940).
- 270b — and —, *ibid.*, **62**, 2237 (1940).
- 271 FRENCH, F. A., and L. N. WHITEHILL (to Shell Development Co.), U. S.
Patent 2,418,297 (Apr. 1, 1947).
- 272 FREY, F. E. (to Phillips Petroleum Co.), U. S. Patent 2,347,945 (May
2, 1944).
- 273 — (to Phillips Petroleum Co.), U. S. Patent 2,391,148 (Dec. 18, 1945).
- 274 — (to Phillips Petroleum Co.), U. S. Patent 2,391,149 (Dec. 18, 1945).
- 275 — (to Phillips Petroleum Co.), U. S. Patent 2,393,857 (Jan. 29, 1946).
- 276 — (to Phillips Petroleum Co.), U. S. Patent 2,418,023 (Mar. 25,
1947); *C. A.*, **41**, 4305 (1947).
- 276a FRONING, J. F., and G. F. HENNION, *J. Am. Chem. Soc.*, **62**, 653 (1940).
- 277 FUNK, H., and F. BINDER, *Z. anorg. allgem. Chem.*, **155**, 327-32 (1926).
- 278 — and —, *ibid.*, **159**, 121-4 (1926).
- 279 GAGE, D. M., and E. F. BARKER, *J. Chem. Phys.*, **7**, 455-9 (1939).
- 280 GAMBLE, E. L., P. GILMONT, and J. F. STIFF, *J. Am. Chem. Soc.*, **62**,
1257-8 (1940).
- 281 GANN, J. A. (to Dow Chemical Co.), U. S. Patent 1,917,759 (July 11,
1933); Brit. Patents 396,645 (Aug. 10, 1933); 352,498 (Aug. 20,
1935).
- 282 GASSELIN, V., *Ann. chim. phys.*, (7) **3**, 5-83 (1894).
- 283 —, *Bull. soc. chim.*, (3) **7**, 17-8 (1892).
- 284 —, *ibid.*, (3) **7**, 209 (1892).
- 285 —, *ibid.*, (3) **7**, 754-5 (1892).
- 286 —, *ibid.*, (3) **9**, 401 (1893).
- 287 —, *ibid.*, (3) **9**, 483-4 (1893).
- 288 —, *ibid.*, (3) **9**, 611 (1893).
- 289 GAY-LUSSAC, J. L., *Gilbert Ann. der Physik*, **36**, 6-36 (1810).
- 290 — and J. L. THÉNARD, *ibid.*, **32**, 1-15 (1809).
- 291 — and —, *Mem. de phys. et de chim. de la soc. d'arcueil*, **2**, 210
(1809); *Gmelin's Handbuch der anorganischen Chemie*, Verlag Chemie,
Berlin, 8th ed., 1926, Vol. 13, Bor, p. 114.

- 292 GAY-LUSSAC, J. L., and J. L. THÉNARD, *Nicholson's J.*, **24**, 29-37 (1809).
293 — and —, *Recherches physicochimiques*, **2**, 38 (1811); *Ann. chim. phys.*, **69**, 204-20 (1809).
294 GAYLOR, P. J., and E. J. MAHLER (to Standard Oil Development Co.), U. S. Patent 2,324,073 (July 13, 1943).
295 GERHART, H. L., and M. H. ARVESON (to Standard Oil Co. of Ind.), Can. Patent 384,809 (Oct. 24, 1939).
296 — and — (to Standard Oil Co. of Ind.), Fr. Patent 823,270 (Jan. 18, 1938); U. S. Patent 2,148,116 (Feb. 21, 1939).
297 — and C. M. Hull (to Standard Oil Co. of Ind.), Can. Patent 384,808 (Oct. 24, 1939).
298 — and — (to Standard Oil Co. of Ind.), Fr. Patent 823,270 (Jan. 18, 1938); U. S. Patent 2,148,115 (Feb. 21, 1939).
299 GERMANN, A. F. O., and H. S. BOOTH, *J. Phys. Chem.*, **30**, 369-77 (1926).
300 — and M. CLEAVELAND, *Science*, **53**, 582 (1921).
301 — and G. G. TORREY, *ibid.*, **54**, 16 (1921).
302 GIEBELHAUSEN, H., *Z. anorg. allgem. Chem.*, **91**, 251-62 (1915).
303 GIUNTI, M. H., *Rev. centro stud. farm. bioquim.*, **31**, 136-54 (1941).
303a GIVEN, P. H., and D. L. HAMMICK, *J. Chem. Soc.*, **1947**, 9
304 GLEASON, A. H. (to Standard Oil Development Co.), U. S. Patent 2,167,358 (July 25, 1939).
305 — and R. ROSEN (to Standard Oil Development Co.), U. S. Patent 2,184,957 (Dec. 26, 1939).
306 GLEASON, E. D., Ger. Patent 277,294 (Apr. 18, 1913).
307 — (to New-Metals and Process Co.), U. S. Patent 1,136,909 (Apr. 20, 1915).
308 — (to New-Metals and Process Co.), U. S. Patent 1,169,536 (Jan. 25, 1916).
309 GLOSSOP, G. A. (to Colgate-Palmolive-Peet Co.), U. S. Patent 2,383,599 (Aug. 28, 1945).
310 GODEFFROY, R., *Ber.*, **9**, 1365-7 (1876).
311 GOLDBERG, M. A., E. P. ORDAS, and G. CARSCH, *J. Am. Chem. Soc.*, **69**, 260 (1947).
312 GOLDFINGER, P., *Naturwiss.*, **17**, 387 (1929).
313 GOLDSBY, A. R., and K. KORPI (to Texaco Development Co.) Arg. Patent 54,021 (Sept. 11, 1942); Brit. Patent 515,531 (Feb. 29, 1940); Can. Patent 427,883 (May 29, 1945); Fr. Patent 839,297 (Dec. 26, 1938); Hol. Patent 48,883 (Jan. 16, 1940); Iran Patent 475 (July 28, 1938); Ital. Patent 363,131 (Sept. 19, 1938); Jap. Patent 138,465 (Sept. 10, 1940); Roum. Patent 27,866 (Oct. 7, 1938).
314 — and J. C. VANGUNDY (to Texaco Development Co.), U. S. Patent 2,256,880 (Sept. 23, 1941); U. S. Reissue 22,146 (July 4, 1944).
315 GORAINOW, W., and A. BUTLEROW, *Ann.*, **169**, 146-9 (1873).
316 GORE, G., *J. Chem. Soc.*, **22**, 368-406 (1869).
317 GORING, H. W., M.A. Thesis, Western Reserve Univ., Cleveland, Ohio, 1927.
317a GRAY, A. G., and W. BLUM, *Trans. Am. Electrochem. Soc.*, **80**, 645-57 (1941).

- 318 GRESHAM, W. F. (to E. I. du Pont de Nemours and Co.), U. S. Patent 2,364,438 (Dec. 5, 1944).
- 319 — (to E. I. du Pont de Nemours and Co.), U. S. Patent 2,376,354 (May 22, 1945).
- 320 GRIMM, H. G., E. KÖSTERMANN, G. WAGNER, and P. BEYERSDORFER, *Z. Elektrochem.*, **30**, 467-73 (1924).
- 321 — and G. WAGNER, *Z. physik. Chem.*, **132**, 131-48 (1932).
- 321a GROFF, J. S., U. S. Patent 1,364,051 (Dec. 28, 1920).
- 322 GROSSE, A. V. (to Universal Oil Products Co.), U. S. Patent 2,216,274 (Oct. 1, 1940).
- 323 — and C. B. Linn (to Universal Oil Products Co.), U. S. Patent 2,333,648 (Nov. 9, 1943).
- 324 — and — (to Universal Oil Products Co.), U. S. Patent 2,391,415 (Dec. 25, 1945).
- 325 — and — (to Universal Oil Products Co.), U. S. Patent 2,411,992 (Dec. 3, 1946).
- 326 GRUMMITT, O. J., M. A. Thesis, Western Reserve Univ., Cleveland, Ohio, 1934.
- 327 GUNNESS, R. C. (to Standard Oil Co. of Ind.), U. S. Patent 2,377,935 (June 12, 1945).
- 328 GUYE, P. A., *J. chim. phys.*, **17**, 141-70 (1919).
- 329 HALLER, H. L., and P. S. SCHAFFER, *J. Am. Chem. Soc.*, **55**, 4954 (1933).
- 330 HAMMÉRL, H., *Compt. rend.*, **90**, 312-3 (1880).
- 331 HANFORD, W. E., and J. R. ROLAND (to E. I. du Pont de Nemours and Co.), U. S. Patent 2,378,009 (June 12, 1945).
- 331a HANSFORD, R. C. (to Socony-Vacuum Oil Co.), U. S. Patent 2,424,691 (July 29, 1947).
- 332 HANTZSCH, A., *Ber.*, **63 B**, 1789-96 (1930).
- 333 — and K. BERGER, *Z. anorg. allgem. Chem.*, **190**, 321-36 (1930).
- 334 HARDEGGER, E., and C. SCHOLZ, *Helv. Chim. Acta*, **28**, 1355-60 (1945).
- 335 HARDTMANN, M., W. SCHEPSS, and E. TIETZE (to I. G. Farbenindustrie A.-G.), U. S. Patent 1,898,532 (Feb. 21, 1933).
- 336 —, E. TIETZE, and W. SCHEPSS (to I. G. Farbenindustrie A.-G.), Ger. Patent 551,513 (Oct. 18, 1927).
- 337 HARMON, J. (to E. I. du Pont de Nemours and Co.), U. S. Patent 2,151,382 (Mar. 21, 1939).
- 338 HARRIS, W. B., *J. Ind. Hyg. Toxicol.*, **19**, 463-4 (1937).
- 338a HARTVIGSEN, HERMAN (to Jasco, Inc.), U. S. Patent 2,407,494 (Sept. 10, 1946).
- 339 HARVEY, M. T. (to Harvel Research Corp.), U. S. Patent 2,364,712 (Dec. 12, 1944).
- 340 HATCH, G. B., E. F. PEVERE, L. A. CLARK, and F. H. BRUNER (to The Texas Co.), U. S. Patent 2,267,097 (Dec. 23, 1941).
- 341 HAUSER, C. R., and J. T. ADAMS, *J. Am. Chem. Soc.*, **64**, 728 (1942).
- 342 — and —, *ibid.*, **66**, 345-9 (1944).
- 343 — and D. S. BRESLOW, *ibid.*, **62**, 2389-92 (1940).
- 344 HEISER, H. W., Brit. Patent 512,005 (Aug. 28, 1939).
- 345 —, Fr. Patent 838,350 (Mar. 2, 1939).
- 346 —, Fr. Patent 838,351 (Mar. 3, 1939).

- 347 HEISER, H. W. (to The Aluminum Co. of America), U. S. Patent 2,182,509 (Dec. 5, 1939).
- 348 — (to The Aluminum Co. of America), U. S. Patent 2,182,510 (Dec. 5, 1939).
- 349 — (to The Aluminum Co. of America), U. S. Patent 2,182,511 (Dec. 5, 1939).
- 350 HELDMAN, J. D., *J. Am. Chem. Soc.*, **66**, 1786–8 (1944).
- 351 —, *ibid.*, **66**, 1789–91 (1944).
- 352 HELLRIEGEL, W., *Ber.*, **70 B**, 689–90 (1937).
- 352a HENNE, A. L., and R. C. ARNOLD, *J. Am. Chem. Soc.*, **70**, 758–60 (1948).
- 353 HENNION, G. F. (to E. I. du Pont de Nemours and Co.), U. S. Patent 2,314,212 (Mar. 16, 1943).
- 354 — (to E. I. du Pont de Nemours and Co.), U. S. Patent 2,365,638 (Dec. 19, 1944).
- 355 — (to E. I. du Pont de Nemours and Co.), U. S. Patent 2,390,835 (Dec. 11, 1945).
- 356 — and L. A. AUSPOS, *J. Am. Chem. Soc.*, **65**, 1603–6 (1943).
- 357 —, H. D. HINTON, and J. A. NIEUWLAND, *ibid.*, **55**, 2857–60 (1933).
- 357a — and —, *ibid.*, **56**, 1802 (1934).
- 358 —, D. B. KILLIAN, T. H. VAUGHN, and J. A. NIEUWLAND, *ibid.*, **56**, 1130–2 (1934).
- 359 — and R. A. KURTZ, *ibid.*, **65**, 1001–3 (1943).
- 360 — and W. S. MURRAY, *ibid.*, **64**, 1220–2 (1942).
- 361 — and J. A. NIEUWLAND, *ibid.*, **57**, 2006–7 (1935).
- 362 — and V. R. PIERONEK, *ibid.*, **64**, 2751–2 (1942).
- 363 — and C. J. SCHMIDLE, *ibid.*, **65**, 2468–9 (1943).
- 364 — and N. F. TOUSSAINT (to E. I. du Pont de Nemours and Co.), U. S. Patent 2,390,836 (Dec. 11, 1945).
- 365 HERSBERGER, A. B. (to the Atlantic Refining Co.), U. S. Patent 2,395,739 (Feb. 26, 1946).
- 366 HESS, W. F., R. A. WYANT, and B. L. AVERBACH, *Welding J. (N. Y.)*, **23**, 417s–535s (1944).
- 367 HEWITT, P. C. (to Cooper Hewitt Elec. Co.), U. S. Patent 1,286,316 (Dec. 3, 1918).
- 368 HEWLETT, A. P. (to Standard Oil Development Co.), U. S. Patent 2,133,452 (Oct. 18, 1938).
- 369 HICKINBOTTOM, W. J., *Nature*, **157**, 520 (1946).
- 370 HILLMAN, E. H. (to Standard Oil Co. of Ind.), U. S. Patent 2,154,089 (Apr. 11, 1939).
- 370a HINTON, H. D., and J. A. NIEUWLAND, *J. Am. Chem. Soc.*, **52**, 2892 (1930).
- 371 — and —, *ibid.*, **54**, 2017–8 (1932).
- 372 HOARD, J. L., and V. BLAIR, *ibid.*, **57**, 1985–8 (1935).
- 373 HOFMANN, F., *Chem. Ztg.*, **57**, 5–6 (1933).
- 374 — and M. OTTO, Brit. Patent 293,487 (Apr. 8, 1927).
- 375 — and —, Fr. Patent 632,768 (Apr. 14, 1927).
- 376 — and —, Ger. Patent 505,265 (Apr. 24, 1926).
- 377 — and —, Ger. Patent 512,959 (Feb. 5, 1927).

- 378 HOFMANN, F., and M. OTTO, Ger. Patent 513,862 (May 29, 1927).
379 — and — (to I. G. Farbenindustrie A.-G.), U. S. Patent 1,811,130 (June 23, 1931).
380 — and W. Stegemann, Brit. Patent 313,067 (May 3, 1928).
380a — and —, Ger. Patent 492,345 (May 23, 1948).
381 —, —, and M. OTTO, Ger. Patent 504,730 (Mar. 24, 1933).
382 —, —, and —, Ger. Patent 507,919 (Apr. 28, 1933).
383 —, —, and —, U. S. Patent 1,885,060 (Oct. 25, 1932).
384 — and C. WULFF, Brit. Patent 301,395 (Nov. 27, 1928); Ger. Patent 489,960 (Nov. 30, 1927).
385 — and —, Brit. Patent 307,802 (Mar. 13, 1928); Ger. Patent 513,414 (Nov. 27, 1933).
386 — and —, Ger. Patent 604,867 (Oct. 30, 1934).
387 — and —, U. S. Patent 1,898,627 (Feb. 21, 1933).
388 — and — (to I. G. Farbenindustrie A.-G.), U. S. Patent 1,933,434 (Oct. 31, 1933).
389 HOLLARD, A., *Brass World*, **8**, 391 (1912); *Bull. soc. d'encour.*, **24** (1912).
390 HOLMES, R. L. (to Jasco., Inc.), U. S. Patent 2,384,916 (Sept. 18, 1945).
391 HOLWECK, F., *Compt. rend.*, **183**, 48-51 (1926).
392 HOMEYER, I., *Pharm. Ztg.*, **34**, 761 (1889).
393 HORECZY, J. T. (to Standard Oil Development Co.), U. S. Patent 2,415,171 (Feb. 4, 1947).
394 — (to Standard Oil Development Co.), U. S. Patent 2,415,172 (Feb. 4, 1947).
395 HORTON, L., Brit. Patent 482,276 (Mar. 21, 1938).
395a HOUTMAN, J. P. W., *J. Soc. Chem. Ind.*, **66**, 102-3 (1947).
396 HUEBNER, D. W., and J. E. FEAREY (to Imperial Chemical Industries, Ltd.), U. S. Patent 2,391,162 (Dec. 18, 1945).
397 — and — (to Imperial Chemical Industries, Ltd.), U. S. Patent 2,410,605 (Nov. 5, 1946).
398 HUGHES, E. C. (to Standard Oil Co. of Ohio), U. S. Patent 2,386,798 (Oct. 16, 1945).
399 — (to Standard Oil Co. of Ohio), U. S. Patent 2,390,100 (Dec. 4, 1945).
400 — and J. D. BARTLESON (to Standard Oil Co. of Ohio), U. S. Patent 2,400,875 (May 28, 1946).
401 — and W. E. Scovill (to Standard Oil Co. of Ohio), U. S. Patent 2,381,907 (Aug. 14, 1945).
402 HUIJJEER, H. W., and C. N. J. DE NOOLJER (to Shell Development Co.), U. S. Patent 2,142,980 (Jan. 3, 1939).
403 — and — (to Shell Development Co.), U. S. Patent 2,259,934 (Oct. 21, 1941).
404 HULL, C. M. (to Standard Oil Co. of Ind.), U. S. Patent 2,252,485 (Aug. 12, 1941).
405 HURD, C. D., and W. A. BONNER, *J. Org. Chem.*, **11**, 50-4 (1946).
406 I. G. FARBENINDUSTRIE, A.-G., Belg. Patent 423,516 (Mar. 14, 1938); *Chem. Zentr.*, **110**, 3455 (1939).
406a —, Belg. Patent 450,730 (June, 1943).

- 407 I. G. FARBENINDUSTRIE, A.-G., Brit. Patent 324,016 (Oct. 12, 1928);
Fr. Patent 675,532 (May 22, 1929).
- 407a —, Brit. Patent 354,992 (July 25, 1930).
- 407b —, Brit. Patent 362,322 (Feb. 22, 1929).
- 407c —, Brit. Patent 399,206 (Oct. 2, 1933).
- 407d —, Brit. Patent 399,211 (Oct. 2, 1933).
- 407e —, Brit. Patent 400,627 (Oct. 27, 1933).
- 408 —, Brit. Patent 401,297 (Nov. 3, 1933).
- 409 —, Brit. Patent 451,359 (Aug. 4, 1936).
- 410 —, Brit. Patent 453,422 (Sept. 4, 1936).
- 411 —, Brit. Patent 498,526 (Jan. 10, 1939).
- 412 —, Brit. Patent 503,595 (Apr. 3, 1939).
- 413 —, Brit. Patent 655,376 (Apr. 30, 1928).
- 413a —, Fr. Patent 682,055 (Sept. 20, 1929).
- 413b —, Fr. Patent 695,125 (May 6, 1930).
- 414 —, Fr. Patent 793,226 (Jan. 20, 1936); Brit. Patent 453,854 (Sept. 18,
1936); Fr. Patent 801,883 (Aug. 20, 1936).
- 415 —, Fr. Patent 793,250 (Jan. 20, 1936); S. BERKMAN, J. C. MORRELL,
and G. EGLOFF, *Catalysis*, Reinhold Pub. Corp., New York (1940),
p. 955.
- 415a —, Fr. Patent 799,016 (May 30, 1936).
- 416 —, Fr. Patent 845,108 (Aug. 11, 1939).
- 416a —, Fr. Patent 848,411 (Oct. 30, 1939).
- 417 —, Ger. Patent 532,765 (Sept. 3, 1931).
- 418 —, Ger. Patent 535,254 (Jan. 14, 1932).
- 418a —, Ger. Patent 546,082 (July 25, 1930); Brit. Patent 354,441 (May
28, 1930).
- 418b —, Ger. Patent 564,897 (Apr. 5, 1931).
- 418c —, Ger. Patent 582,846 (Aug. 23, 1933).
- 419 —, Ger. Patent 589,779 (Dec. 14, 1933).
- 419a —, Ger. Patent 590,237 (Jan. 4, 1934).
- 419b —, Ger. Patent 605,688 (Nov. 16, 1934).
- 419c —, Ger. Patent 615,530 (July 8, 1935).
- 419d —, Ger. Patent 628,660 (Apr. 8, 1936).
- 419e —, Ger. Patent 632,223 (July 4, 1936).
- 419f —, Ger. Patent 637,808 (Nov. 4, 1936).
- 420 —, Ger. Patent 671,498 (Feb. 9, 1939).
- 420a —, Ger. Patent 695,135 (July 18, 1940).
- 421 —, Ger. Patent 704,038 (Feb. 20, 1941).
- 422 —, Ger. Patent 745,802 (Dec. 16, 1943).
- 423 IPATIEFF, V. N., *Catalytic Reactions at High Pressures and Temperatures*,
Macmillan Co., New York (1936), 650.
- 424 —, *ibid.*, 685
- 425 —, *ibid.*, 684–92.
- 426 —, B. B. CORSON, and H. PINES, *J. Am. Chem. Soc.*, **58**, 919–22
(1936).
- 427 — and A. V. GROSSE, *ibid.*, **57**, 1616–21 (1935).
- 428 — and —, *ibid.*, **58**, 2339 (1936).

- 429 IPATIEFF, V. N., and A. V. GROSSE (to Universal Oil Products Co.), U. S. Patent 2,217,019 (Oct. 8, 1940).
- 430 — and — (to Universal Oil Products Co.), U. S. Patent 2,273,320 (Feb. 17, 1942).
- 431 — and V. KOMAREWSKY (to Universal Oil Products Co.), Austral. Patent 103,401 (Mar. 31, 1938).
- 431a — and — (to Universal Oil Products Co.), U. S. Patent 2,131,806 (Oct. 4, 1938).
- 432 —, V. K. KOMAREWSKY, and A. V. GROSSE, *J. Am. Chem. Soc.*, **57**, 1722-4 (1935).
- 433 — and C. B. LINN (to Universal Oil Products Co.), U. S. Patent 2,366,731 (January 9, 1945).
- 433a — and — (to Universal Oil Products Co.), U. S. Patent 2,421,946 (June 10, 1947).
- 433b — and — (to Universal Oil Products Co.), U. S. Patent 2,428,279 (Sept. 30, 1947).
- 434 — and H. PINES (to Universal Oil Products Co.), U. S. Patent 2,283,142 (May 12, 1942).
- 435 — and — (to Universal Oil Products Co.), U. S. Patent 2,318,225 (May 4, 1943).
- 436 — and — (to Universal Oil Products Co.), U. S. Patent 2,318,226 (May 4, 1943).
- 437 — and — U. S. Patent 2,325,122 (July 27, 1943).
- 438 IVERSON, JOHN O. (to Universal Oil Products Co.), U. S. Patent 2,388,919 (Nov. 13, 1945).
- 439 JANNASCH, P., and H. WEBER, *Ber.*, **32**, 1670-5 (1899).
- 440 JOHNSON, J. R., H. R. SNYDER, and M. G. VAN CAMPEN, JR., *J. Am. Chem. Soc.*, **60**, 115-21 (1938).
- 441 JOHNSON, J. Y. (to I. G. Farbenindustrie A.-G.), Brit. Patent 326,322 (Feb. 22, 1929).
- 442 — (to I. G. Farbenindustrie A.-G.), Brit. Patent 358,495 (May 29, 1930).
- 443 — (to I. G. Farbenindustrie A.-G.), Brit. Patent 441,064 (Jan. 9, 1936).
- 444 JOHNSON, ROBERT (to E. I. du Pont de Nemours and Co.), U. S. Patent 2,273,269 (Feb. 17, 1942).
- 445 JOHNSON, W. W. (to I. G. Farbenindustrie A.-G.), Brit. Patent 503,755 (Apr. 6, 1939).
- 446 KALLE AND CO., A.-G., (M. P. Schmidt and W. Krieger), Ger. Patent 535,913 (Dec. 21, 1927).
- 447 KÄSTNER, D., *Angew. Chem.*, **54**, 273-81 (1941).
- 447a —, *Newer Methods of Preparative Organic Chemistry*, Interscience Publishers, (New York (1948), 249.
- 448 KEIM, G. I. (to Colgate-Palmolive-Peet Co.), U. S. Patent 2,383,601 (Aug. 28, 1945).
- 449 KELSO, C. D., and L. W. MIXON (to Standard Oil Co. of Ind.), U. S. Patent 2,316,085 (Apr. 6, 1943).

- 450 KELSO, C. D., and L. W. MIXON (to Standard Oil Co. of Ind.), U. S. Patent 2,316,090 (April 6, 1943).
- 451 KENNER, J., *Nature*, **156**, 369-70 (1945).
- 451a KERN, EDWARD F., *Trans. Am. Electrochem. Soc.*, **38**, 143-66 (1920).
- 452 — and F. G. FABIAN, *Trans. Am. Electrochem. Soc.*, **15**, 464 (1907).
- 453 — and T. R. JONES, *Trans. Am. Electrochem. Soc.*, **57**, 273-8 (1938).
- 454 KILLIAN, D. B., G. F. HENNION, and J. A. NIEUWLAND, *J. Am. Chem. Soc.*, **56**, 1384-5 (1934).
- 454a —, —, and —, *ibid.*, **56**, 1786 (1934).
- 454b —, —, and —, *ibid.*, **58**, 892 (1936).
- 454c —, —, and —, *ibid.*, **58**, 1658 (1936).
- 455 KIRKPATRICK, E. C. (to E. I. du Pont de Nemours and Co.), U. S. Patent 2,372,090 (Mar. 20, 1945).
- 456 KLEBANSKI, A. L., and K. K. CHEVYCHALOVA, *J. Gen. Chem. (U.S.S.R.)*, **16**, 1101-14 (1946).
- 456a KLEIDERER, E. C., and ROGER ADAMS, *J. Am. Chem. Soc.*, **53**, 1575 (1931).
- 457 KLEMM, W., and P. HENKEL, *Z. anorg. allgem. Chem.*, **213**, 115-25 (1933).
- 458 KLINKENBERG, L. J., *Chem. Weckblad*, **34**, 23-5 (1937).
- 458a —, Doctoral Thesis, Leiden, 1937.
- 459 —, *Rec. trav. chim.*, **56**, 36-40 (1937).
- 460 — and J. A. A. KETELAAR, *ibid.*, **54**, 959-61 (1935).
- 461 KOCH, H., and H. STEINBRINK, *Brennstoff-Chemie*, **19**, 277-85 (1938).
- 462 KOLKA, A. J., and R. R. VOGT, *J. Am. Chem. Soc.*, **61**, 1463-5 (1939).
- 463 KORFF, S. A., and W. E. DANFORTH, *Phys. Rev.*, **55**, 980 (1939).
- 464 KRAUS, C. A., and E. H. BROWN, *J. Am. Chem. Soc.*, **51**, 2690-6 (1929).
- 465 — and —, *ibid.*, **52**, 4414-8 (1930).
- 466 KRAUSE, E., Ger. Patent 371,467 (Mar. 15, 1923).
- 467 — and R. NITSCHKE, *Ber.*, **54 B**, 2784-91 (1921).
- 468 — and —, *ibid.*, **55 B**, 1261-5 (1922).
- 469 — and P. NOBBE, *ibid.*, **63 B**, 936 (1930).
- 470 — and —, *ibid.*, **64 B**, 2112-6 (1931).
- 471 KROEGER, J. W., F. J. SOWA, and J. A. NIEUWLAND, *J. Am. Chem. Soc.*, **59**, 965-9 (1937).
- 472 —, —, and —, *Proc. Indiana Acad. Sci.*, **46**, 115-17 (1937).
- 473 KROPA, E. L. (to American Cyanamid Co.), U. S. Patent 2,388,161 (Oct. 30, 1945).
- 474 KUENTZEL, W. E. (to Standard Oil Co. of Ind.), U. S. Patent 2,221,000 (Nov. 12, 1940).
- 475 — (to Standard Oil Co. of Ind.), U. S. Patent 2,291,638 (Aug. 4, 1942).
- 476 KUHLMANN, F., *Ann. chim. phys.*, (3) **2**, 116-8 (1841); *Liebig's Ann.*, **39**, 319-21 (1841).
- 477 —, *Liebig's Ann.*, **33**, 97-110 (1840); **33**, 192-224 (1840).
- 478 LACOMBLE, A. F. (to Shell Development Co.), Can. Patent 423,999 (Nov. 21, 1944).
- 479 — (to Shell Development Co.), Can. Patent 424,000 (Nov. 21, 1944).

- 480 LANDOLPH, F., *Ber.*, **10**, 1312-4 (1877); *Compt. rend.*, **85**, 39-40 (1877).
481 —, *Ber.*, **12**, 1578-83 (1879); *Compt. rend.*, **89**, 173-5 (1879).
482 —, *Ber.*, **12**, 1583-6 (1879).
483 —, *Ber.*, **13**, 144-8 (1880).
484 —, *Compt. rend.*, **86**, 539-41 (1878).
485 —, *ibid.*, **86**, 601-4 (1878).
486 —, *ibid.*, **86**, 671-3 (1878).
487 —, *ibid.*, **86**, 1463-4 (1878); *J. Pharmacy*, **29**, 28-9 (1879).
488 —, *Compt. rend.*, **96**, 580-2 (1883).
489 LANGE, W., *Ber.*, **59**, 2107-13; 2432 (1926).
490 LANGEDIJK, S. L., and A. J. VAN PESKI (to Shell Development Co.), U. S. Patent 2,085,535 (June 29, 1937).
491 LARSON, A. T. (to E. I. du Pont de Nemours and Co.), U. S. Patent 2,135,450 (Nov. 1, 1938).
492 — (to E. I. du Pont de Nemours and Co.), U. S. Patent 2,273,785 (Feb. 17, 1942).
492a LAUBENGAYER, A. W., and G. F. CONDIKE, *J. Am. Chem. Soc.*, **70**, 2274 (1948).
493 —, R. P. FERGUSON, and A. E. NEWKIRK, *J. Am. Chem. Soc.*, **63**, 559-61 (1941).
494 — and G. R. FINLAY, *ibid.*, **65**, 884-9 (1943).
495 — and D. S. SEARS, *ibid.*, **67**, 164-7 (1945).
496 LÉBOUCHER, L., W. FISCHER, and W. BILTZ, *Z. anorg. allgem. Chem.*, **207**, 61-72 (1932).
497 LEFEBVRE, H., and E. LEVAS, *Compt. rend.*, **220**, 782-4 (1945).
498 — and —, *ibid.*, **220**, 826-7 (1945).
499 — and —, *ibid.*, **221**, 301-3 (1945).
500 — and —, *ibid.*, **221**, 355-7 (1945).
501 —, —, and E. LEVAS, *ibid.*, **222**, 1439-40 (1946).
502 LEFEBVRE, R. J. W., and E. E. TURNER, *J. Chem. Soc.*, **1930**, 1158-62.
503 LEUCHS, G., *Monit. Scient.*, **28**, 1390-1 (1886).
504 LEVAS, E., and H. LEFEBVRE, *Compt. rend.*, **222**, 555-7 (1946).
505 LEVINE, R., and C. R. HAUSER, *J. Am. Chem. Soc.*, **67**, 2050 (1945).
506 LEVY, H. A., and L. O. BROCKWAY, *ibid.*, **59**, 2085-92 (1937).
507 LEWIS, G. N., and G. T. SEABORG, *ibid.*, **61**, 1886-94 (1939).
508 LICHTY, J. C., and N. V. SEEGER (to Wingfoot Corp.), U. S. Patent 2,388,656 (Nov. 6, 1945).
509 LIEBER, E. (to Standard Oil Development Co.), U. S. Patent 2,410,885 (Nov. 12, 1946).
510 — and H. T. RICE (to Standard Oil Development Co.), U. S. Patent 2,364,454 (Dec. 5, 1944).
511 VON LIEBIG, J., and F. WÖHLER, *Ann. chim. phys.*, **49**, 25-31 (1832); *Pogg. Ann.*, **24**, 167-72 (1832).
512 LIEN, A. P. (to Standard Oil Co. of Ind.), U. S. Patent 2,399,126 (Apr. 23, 1946).
512a — and B. L. EVERING (to Standard Oil Co. of Ind.), U. S. Patent 2,427,865 (Sept. 23, 1947).

- 512b LIEN, A. P., B. L. EVERING, and B. H. SHOEMAKER (to Standard Oil Co. of Ind.), U. S. Patent 2,427,009 (Sept. 9, 1947).
- 513 — and B. H. SHOEMAKER (to Standard Oil Co. of Ind.), U. S. Patent 2,397,495 (Apr. 2, 1946).
- 513a — and — (to Standard Oil Co. of Ind.), U. S. Patent 2,430,516 (Nov. 11, 1947).
- 514 LIGHT, L., *Chem. Products*, **3**, 29 (1940).
- 515 LINKE, R., and W. ROHRMANN, *Z. physik. Chem.*, **B 35**, 256–60 (1937).
- 516 LINN, C. B., and V. N. IPATIEFF (to Universal Oil Products Co.), U. S. Patent 2,366,736 (Jan. 9, 1945).
- 517 — and — (to Universal Oil Products Co.), U. S. Patent 2,381,828 (Aug. 7, 1945).
- 518 — and — (to Universal Oil Products Co.), U. S. Patent 2,411,047 (Nov. 12, 1946).
- 519 — and — (to Universal Oil Products Co.), U. S. Patent 2,416,106 (Feb. 18, 1947).
- 520 LINNETT, J. W., *Trans. Faraday Soc.*, **38**, 1–9 (1942).
- 521 LISCOMB, F. J., *Brass World*, **16**, 311 (1920).
- 522 LOANE, C. M. (to Standard Oil Co. of Ind.), U. S. Patent 2,177,729 (Oct. 31, 1939).
- 523 — and J. W. GAYNOR (to Standard Oil Co. of Ind.), U. S. Patent 2,316,078 (Apr. 6, 1943).
- 524 — and — (to Standard Oil Co. of Ind.), U. S. Patent 2,316,079 (Apr. 6, 1943).
- 525 — and — (to Standard Oil Co. of Ind.), U. S. Patent 2,316,080 (Apr. 6, 1943).
- 526 — and — (to Standard Oil Co. of Ind.), U. S. Patent 2,316,081 (Apr. 6, 1943).
- 527 — and — (to Standard Oil Co. of Ind.), U. S. Patent 2,316,082 (Apr. 6, 1943).
- 528 — and — (to Standard Oil Co. of Ind.), U. S. Patent 2,316,083 (Apr. 6, 1943).
- 529 — and — (to Standard Oil Co. of Ind.), U. S. Patent 2,316,084 (Apr. 6, 1943).
- 530 — and — (to Standard Oil Co. of Ind.), U. S. Patent 2,316,087 (Apr. 6, 1943).
- 531 — and — (to Standard Oil Co. of Ind.), U. S. Patent 2,316,088 (Apr. 6, 1943).
- 532 — and — (to Standard Oil Co. of Ind.), U. S. Patent 2,330,900 (Oct. 5, 1943).
- 533 — and — (to Standard Oil Co. of Ind.), U. S. Patent 2,353,837 (July 18, 1944):
- 534 LODER, D. J. (to E. I. du Pont de Nemours and Co.), U. S. Patent 2,135,448 (Nov. 1, 1938).
- 535 — (to E. I. du Pont de Nemours and Co.), U. S. Patent 2,135,449 (Nov. 1, 1938).
- 536 — (to E. I. du Pont de Nemours and Co.), U. S. Patent 2,135,451 (Nov. 1, 1938).

- 537 LODER, D. J. (to E. I. du Pont de Nemours and Co.), U. S. Patent 2,135,452 (Nov. 1, 1938).
- 538 — (to E. I. du Pont de Nemours and Co.), U. S. Patent 2,135,453 (Nov. 1, 1938).
- 539 — (to E. I. du Pont de Nemours and Co.), U. S. Patent 2,135,455 (Nov. 1, 1938).
- 540 — (to E. I. du Pont de Nemours and Co.), U. S. Patent 2,135,456 (Nov. 1, 1938).
- 541 — (to E. I. du Pont de Nemours and Co.), U. S. Patent 2,135,457 (Nov. 1, 1938).
- 542 — (to E. I. du Pont de Nemours and Co.), U. S. Patent 2,135,459 (Nov. 1, 1938).
- 543 — (to E. I. du Pont de Nemours and Co.), U. S. Patent 2,135,460 (Nov. 1, 1938); Brit. Patent 499,770 (Jan. 27, 1939); Fr. Patent 814,839 (June 30, 1937).
- 544 — (to E. I. du Pont de Nemours and Co.), U. S. Patent 2,152,852 (Apr. 4, 1939).
- 545 — (to E. I. du Pont de Nemours and Co.), U. S. Patent 2,158,031 (May 9, 1939).
- 546 — (to E. I. du Pont de Nemours and Co.), U. S. Patent 2,160,575 (May 30, 1939).
- 547 — (to E. I. du Pont de Nemours and Co.), U. S. Patent 2,160,576 (May 30, 1939).
- 548 — (to E. I. du Pont de Nemours and Co.), U. S. Patent 2,162,459 (June 13, 1939).
- 549 — (to E. I. du Pont de Nemours and Co.), U. S. Patent 2,170,825 (Aug. 29, 1939).
- 550 — (to E. I. du Pont de Nemours and Co.), U. S. Patent 2,217,650 (Oct. 8, 1940).
- 551 — (to E. I. du Pont de Nemours and Co.), U. S. Patent 2,253,525 (Aug. 26, 1941).
- 552 — (to E. I. du Pont de Nemours and Co.), U. S. Patent 2,289,548 (July 14, 1942).
- 553 — (to E. I. du Pont de Nemours and Co.), U. S. Patent 2,302,618 (Nov. 17, 1942).
- 554 — (to E. I. du Pont de Nemours and Co.), U. S. Patent 2,373,483 (Apr. 10, 1945).
- 555 LONG, K. E., M.A. Thesis, Western Reserve Univ., Cleveland, Ohio, 1927.
- 556 LOOSE, W. S. (to Dow Chemical Co.), U. S. Patent 2,313,756 (Mar. 16, 1943).
- 557 — and H. K. DE LONG (to Dow Chemical Co.), U. S. Patent 2,322,208 (June 22, 1943).
- 558 LOSEV, I. P., O. Y. FEDOTOVA, and M. F. SHOSTAKOVSKIĀ, *J. Gen. Chem. (U.S.S.R.)*, **14**, 889-96 (1944).
- 559 — and S. M. ZHIVUKHIN, *Trudy Konferents. Vysokomolekulyar. Soedineniyam, Akad. Nauk S.S.S.R., Otdel. Khim. Nauk: Otdel. Fiz. Mat. Nauk*, **1**, 23-4 (1943).

- 560 LOVERING, E. G., *Monthly Rev. Am. Electroplaters Soc.*, Feb., 1920.
- 561 LU, H., and R. H. SCHUMAN, *Phys. Rev.*, **58**, 199 (1940).
- 561a LUDER, W. F., and S. ZUFFANTI, *Electronic Theory of Acids and Bases*, John Wiley & Sons, New York (1946).
- 562 LYMAN, A. A., and E. W. GARDINER (to Standard Oil Co. of Calif.), U. S. Patent 2,216,372 (Oct. 1, 1940).
- 563 McALEVY, A. (to E. I. du Pont de Nemours and Co.), U. S. Patent 2,135,454 (Nov. 1, 1938).
- 564 — (to E. I. du Pont de Nemours and Co.), U. S. Patent 2,183,503 (Dec. 12, 1939).
- 565 McGRATH, J. S., G. G. STACK, and P. A. McCUSKER, *J. Am. Chem. Soc.*, **66**, 1263-4 (1944).
- 566 McINTYRE, G. H., Ph. D. Thesis, Western Reserve Univ., Cleveland, Ohio, 1939.
- 567 —, U. S. Patent 1,869,019 (July 26, 1932).
- 568 McKENNA, J. F., and F. J. SOWA, *J. Am. Chem. Soc.*, **59**, 470-1 (1937).
- 569 — and —, *ibid.*, **59**, 1204-5 (1937).
- 570 — and —, *ibid.*, **60**, 124-5 (1938).
- 571 McMILLAN, W. A. (to The Texas Co.), U. S. Patent 2,181,642 (Nov. 28, 1939).
- 572 MANLEY, R. E. (to The Texas Co.), U. S. Patent 2,097,127 (Oct. 26, 1937).
- 573 MANN, M. D., JR. (to Standard Oil Development Co.), U. S. Patent 2,229,661 (Jan. 28, 1941).
- 574 — and L. B. TURNER (to Jasco, Inc.), U. S. Patent 2,360,632 (Oct. 17, 1944).
- 575 MARCOVITCH, S., *J. Econ. Entomol.*, **35**, 288-9 (1942).
- 576 MARDUS, Dissertation, Technische Hochschule, Charlottenburg, 1908.
- 577 DEMARIGNAC, J. C. B., *Z. anal. Chem.*, **1**, 404-9 (1862).
- 578 MARPLE, K. E. (to Shell Development Co.), U. S. Patent 2,388,167 (Oct. 30, 1945).
- 578a MARTIN, D. R., and R. E. DIAL, Personal Communication.
- 578b MARVEL, C. S., and E. H. RIDDLE, *J. Am. Chem. Soc.*, **62**, 2666 (1940).
- 578c MATHERS, F. C., *Trans. Am. Electrochem. Soc.*, **23**, 154 (1913).
- 578d — and B. W. COCKRUM, *ibid.*, **26**, 133 (1914).
- 579 —, C. O. STEWART, H. V. HOUSEMANN, and I. E. LEE, *J. Am. Chem. Soc.*, **37**, 1515-7 (1915).
- 580 MAY, R. L. (to Sinclair Refining Company), U. S. Patent 2,397,498 (Apr. 2, 1946).
- 581 MAYER, R. (to I. G. Farbenindustrie, A.-G.), Ger. Patent 710,756 (Aug. 14, 1941).
- 582 MEADOW, J. R. (to Socony-Vacuum Oil Co.), U. S. Patent 2,403,013 (July 2, 1946).
- 583 MEERWEIN, H., *Ann.*, **455**, 227-53 (1927).
- 584 —, *Ber.*, **66 B**, 411-4 (1933).
- 585 —, *Stitzber. Ges. Beforder ges. Naturw., Marburg*, **64**, 119-35 (1930); *Chem. Zentr.*, **101**, 1962-3 (1930).
- 586 —, E. BATTENBERG, H. GOLD, E. PFEIL, and G. WILLFANG, *J. prakt. Chem.*, **154**, 83-156 (1939).

- 587 MEERWEIN, H., G. HINZ, P. HOFMANN, E. KRONING, and E. PFEIL, *ibid.*, **147**, 257-85 (1937).
- 587a —, P. HOFMANN, and F. SCHILL, *J. prakt. Chem.*, **154**, 266-83 (1940).
- 588 — and H. MAIER-HÜSER, *ibid.*, **134**, 51-81 (1932).
- 589 — and W. PANNWITZ, *ibid.*, **141**, 123-48 (1934).
- 590 — and D. VOSSEN, *ibid.*, **141**, 149-66 (1934).
- 591 MEIGS, F. M. (to E. I. du Pont de Nemours and Co.), U. S. Patent 1,916,327 (July 4, 1933).
- 592 MEINERT, R. N. (to Standard Oil Development Co.), U. S. Patent 2,348,637 (May 9, 1944).
- 593 MELIKOFF, P. G. and S. LORDKIPANIDZE, *Ber.*, **32**, 3349-54 (1899).
- 594 — and —, *ibid.*, **32**, 3510-2 (1899).
- 595 — and —, *J. Russ. Phys. Chem. Soc.*, **32**, 77-82 (1900).
- 596 MERLUB-SOBEL, M., and J. M. BIALOSKY (to William L. Ulmer), U. S. Patent 2,357,014 (Aug. 29, 1944).
- 597 MERRILL, J. A. (to Wingfoot Corp.), U. S. Patent 2,188,284 (Jan. 23, 1940).
- 598 TER MEULEN, H., *Chem. Weekblad*, **20**, 59 (1923).
- 599 VAN DER MEULEN, P. A., and H. A. HELLER, *J. Am. Chem. Soc.*, **54**, 4404-6 (1932).
- 600 — and H. L. VAN MATER, *Inorganic Syntheses*, McGraw-Hill Book Co., New York (1939), Vol. I, 24.
- 601 MEYER, R. E. (to Socony-Vacuum Oil Co.), U. S. Patent 2,399,817 (May 7, 1946).
- 602 MEYERHOFER, A. F. (to E. de Haen A.-G.), Brit. Patent 222,836 (Oct. 1, 1923).
- 603 — (to E. de Haen A.-G.), Brit. Patent 222,838 (Oct. 1, 1923).
- 604 — (to E. de Haen A.-G.), Brit. Patent 226,490 (Dec. 20, 1923).
- 605 — (to E. de Haen A.-G.), Brit. Patent 226,491 (Dec. 20, 1923).
- 606 —, Brit. Patent 237,616 (Dec. 20, 1923).
- 607 —, Fr. Patent 579,039 (Mar. 18, 1924).
- 608 MIKESKA, L. A., and A. H. GLEASON (to Standard Oil Development Co.), U. S. Patent 2,092,889 (Sept. 14, 1937).
- 609 MILLAR, R. W., *J. Am. Chem. Soc.*, **45**, 874-81 (1923).
- 610 MILLER, M. A. (to the Aluminum Co. of America), U. S. Patent 2,238,068 (Apr. 15, 1941).
- 611 — (to the Aluminum Co. of America), U. S. Patent 2,238,069 (Apr. 15, 1941).
- 612 — (to the Aluminum Co. of America), U. S. Patent 2,266,060 (Dec. 16, 1941).
- 613 — (to the Aluminum Co. of America), U. S. Patent 2,286,298 (June 16, 1942).
- 614 — (to the Aluminum Co. of America), U. S. Patent 2,291,399 (July 28, 1942).
- 615 — (to the Aluminum Co. of America), U. S. Patent 2,291,400 (July 28, 1942).
- 616 — (to the Aluminum Co. of America), U. S. Patent 2,291,401 (July 28, 1942).
- 617 MILLER, N., *Nature*, **158**, 950-1 (1946).

- 618 MIOLATI, A., and G. ROSSI, *Atti. accad. Lincei*, (5) 5ii, 183-90; 223-7 (1896).
- 619 MIXON, L. W. (to Standard Oil Co. of Ind.), U. S. Patent 2,375,315 (May 8, 1945).
- 620 — and C. M. LOANE (to Standard Oil Co. of Ind.), U. S. Patent 2,367,468 (Jan. 16, 1945).
- 621 MIXTER, W. G., *Am. Chem. J.*, 2, 153-8 (1880).
- 622 MOESER, L., and W. EIDMANN, *Ber.*, 35, 535-9 (1902).
- 623 MOISSAN, H., *Ann. chim. phys.*, (6) 24, 224-82 (1891).
- 624 —, *ibid.*, (7) 6, 296-320 (1895).
- 625 —, *ibid.*, (8) 8, 84-90 (1906).
- 626 —, *Bull. soc. chim.*, (3) 5, 456-8 (1891).
- 627 —, *Compt. rend.*, 99, 655-7 (1884).
- 628 —, *ibid.*, 112, 717-20 (1891).
- 629 —, *ibid.*, 139, 711-4 (1904).
- 630 —, *Le fluor et ses composés*, G. Steinheil, Paris (1900), 18.
- 631 —, *ibid.*, 128.
- 632 —, *ibid.*, 138.
- 633 —, *ibid.*, 170.
- 634 —, *ibid.*, 235.
- 635 —, *Traite de chimie minerale*, Paris (1905), Vol. 2, 164-5; *Gmelin, Handbuch der anorganischen Chemie*, Verlag Chemie, Berlin, 8th ed. (1926), Vol. 13, Bor, p. 113.
- 636 MONACELLI, W. J., and G. F. HENNION, *J. Am. Chem. Soc.*, 63, 1722-4 (1941).
- 637 MONTEMARTINI, C., *Gazz. Chim. Ital.*, 24i, 478-80 (1894); *Atti. Accad. Lincei*, (5) 3i, 339 (1894); *Z. Kryst. Min.*, 26, 198 (1894).
- 638 MOORE, M. C. (to Hercules Powder Co.), U. S. Patent 2,368, 767 (Feb. 2, 1945).
- 639 MORGAN, G. T., and R. TAYLOR, *J. Chem. Soc.*, 1932, 1497.
- 640 — and —, *J. Soc. Chem. Ind.*, 50, 869 (1931).
- 641 — and R. B. TUNSTALL, *J. Chem. Soc.*, 125, 1963-7 (1924).
- 642 MORIARTY, F. C. (to Universal Oil Products Co.), U. S. Patent 2,341,567 (Feb. 15, 1944).
- 643 MORRIS, T. C. (to Wingfoot Corp.), U. S. Patent 2,064,763 (Dec. 15, 1936).
- 644 — (to Wingfoot Corp.), U. S. Patent 2,084,042 (June 15, 1937).
- 645 — (to Wingfoot Corp.), U. S. Patent 2,238,336 (Apr. 15, 1941).
- 646 — (to Wingfoot Corp.), U. S. Patent 2,311,770 (Feb. 23, 1943).
- 647 MORWAY, A. J., and F. L. MILLER (to Standard Oil Development Co.), U. S. Patent 2,243,470 (May 27, 1941).
- 648 MOSER, F. R. (to Shell Development Co.), U. S. Patent 2,143,566 (Jan. 10, 1939).
- 649 MOTYLEWSKY, S., *Z. anorg. allgem. Chem.*, 38, 410-8 (1904).
- 650 MUELLER-CUNRADI, M. and M. OTTO (to I. G. Farbenindustrie A.-G.), Can. Patent 354,410 (Nov. 26, 1935); Ger. Patent 405,795 (Jan. 28, 1933); *Chem. Zentr.*, 107, 1708 (1936).

- 651 MUELLER-CUNRADI, M., and M. OTTO (to I. G. Farbenindustrie A.-G.), Can. Patent 354,413 (Nov. 26, 1935); Ger. Patent 406,038 (Feb. 16, 1933); *Chem. Zentr.*, **107**, 1708 (1936).
- 652 — and —, U. S. Patent 2,065,474 (Dec. 22, 1936).
- 653 MULERT, O., *Z. anorg. allgem. Chem.*, **75**, 198–240 (1912).
- 654 MURRAY, W. S., *Proc. Am. Electroplaters Soc.*, June 1944, 160–71.
- 655 NARCUS, H., *Metal Finishing*, **43**, 188–90, 199, 242–4 (1945).
- 656 NASH, A. W., H. M. STANLEY, and A. R. BOWEN, *Petroleum Times*, **24**, 799–802 (1930).
- 657 NAZAROV, I. N., and T. D. NAGIBINA, *Bull. acad. sci. U.R.S.S., Classe sci. chim.*, **1941**, 303–13; *Chem. Zentr.*, **1942**, 1446.
- 658 — and O. V. OKOLSKAYA, *Bull. acad. sci. U.R.S.S., Classe sci. chim.*, **1941**, 314–20; *Chem. Zentr.*, **1942 II**, 1446–7.
- 659 — and V. M. ROMANOV, *Bull. acad. sci. U.R.S.S., Classe sci. chim.*, **1940**, 453.
- 660 NEWMAN, R. J. (to Universal Oil Products Co.), U. S. Patent 2,375,867 (May 15, 1945).
- 661 — (to Universal Oil Products Co.), U. S. Patent 2,382,899 (Aug. 14, 1945).
- 662 NIEDERL, J. B. (to Röhm and Haas Co.), U. S. Patent 2,008,032 (July 16, 1935).
- 663 NIEUWLAND, J. A. (to E. I. du Pont de Nemours and Co.), U. S. Patent 1,824,963 (Sept. 29, 1931).
- 664 — (to E. I. du Pont de Nemours and Co.), U. S. Patent 1,907,560 (May 9, 1933).
- 665 —, G. F. HENNION, and D. S. KILLIAN (to E. I. du Pont de Nemours and Co.), U. S. Patent 2,140,713 (Dec. 20, 1938).
- 666 — and F. J. SOWA (to E. I. du Pont de Nemours and Co.), Brit. Patent 463,545 (Mar. 30, 1937).
- 667 — and — (to E. I. du Pont de Nemours and Co.), U. S. Patent 2,036,353 (Apr. 7, 1936).
- 668 — and — (to E. I. du Pont de Nemours and Co.), U. S. Patent 2,109,340 (Feb. 22, 1938).
- 669 — and — (to E. I. du Pont de Nemours and Co.), U. S. Patent 2,192,015 (Feb. 27, 1940).
- 670 —, R. R. VOGT, and W. L. FOOHEY, *J. Am. Chem. Soc.*, **52**, 1018–24 (1930).
- 671 NIGHTINGALE, D., and J. R. JANES, *ibid.*, **66**, 154–5 (1944).
- 672 —, H. D. RADFORD, and O. G. SHANHOLTZER, *ibid.*, **64**, 1662–5 (1942).
- 672a NIKITINA, E. A., *Uspekhi Khim.* **15**, 707–20 (1946).
- 673 N. V. DE BATAAFSCHE PETROLEUM MAATSCHAPPIJ, Dutch Patent 43,011 (Apr. 15, 1938).
- 674 —, Dutch Patent 48,596 (June 15, 1940).
- 675 —, Fr. Patent 809,675 (Mar. 8, 1937).
- 676 —, Fr. Patent 819,619 (Oct. 22, 1937).
- 676a NORRIS, R. O., J. J. VERBANC, and G. F. HENNION, *J. Am. Chem. Soc.*, **60**, 1159 (1938).
- 677 O'CONNOR, M. J., and F. J. SOWA, *J. Am. Chem. Soc.*, **60**, 125–7 (1938).

- 678 O'LEARY, L. A., and H. H. WENSKE, *ibid.*, **55**, 2117-21 (1933).
- 679 OTT, E. (to Hercules Powder Co.), U. S. Patent 2,348,565 (May 9, 1944).
- 680 — (to Hercules Powder Co.), U. S. Patent 2,373,706 (Apr. 17, 1945).
- 681 OTTO, M., *Brennstoff-Chemie*, **8**, 213-4 (1927).
- 682 — *ibid.*, **8**, 321-3 (1927).
- 683 — and L. BUB (to I. G. Farbenindustrie A.-G.), Ger. Patent 545,397 (Oct. 12, 1928).
- 684 — and — (to I. G. Farbenindustrie A.-G.), U. S. Patent 1,989,425 (Jan. 29, 1935).
- 685 —, H. GUETERBOCK, and A. HELLEMANN (to Jasco, Inc.), U. S. Patent 2,311,567 (Feb. 16, 1943).
- 686 — and M. MUELLER-CUNRADI (to I. G. Farbenindustrie A.-G.), U. S. Patent 2,130,507 (Sept. 20, 1938).
- 687 — and H. G. SCHNEIDER (to Jasco, Inc.), U. S. Patent 2,296,399 (Sept. 22, 1942).
- 688 OUVARD, L., *Compt. rend.*, **130**, 172-5 (1900).
- 689 D'OUVILLE, E. L., and B. H. SHOEMAKER (to Standard Oil Co. of Ind.), U. S. Patent 2,398,495 (Apr. 16, 1946).
- 690 PASSINO, H. J. (to the M. W. Kellogg Co.), U. S. Patent 2,396,965 (Mar. 19, 1946).
- 690a — and J. S. REARICK (to the M. W. Kellogg Co.), U. S. Patent 2,423,045 (June 24, 1947).
- 691 PATEIN, G., *Compt. rend.*, **113**, 85-7 (1891).
- 692 PAUL, F. W., and H. P. KNAUSS, *Phys. Rev.*, **54**, 1072-7 (1938).
- 693 PENISTEN, J. R. (to Universal Oil Products Co.), U. S. Patent 2,372,338 (Mar. 27, 1945).
- 694 PERRINE, J. O., *ibid.*, (**2**) **22**, 48-57 (1923).
- 695 PESCE, B., *Gazz. chim. ital.*, **60**, 936-9 (1930).
- 696 VAN PESKI, A. J. (to Shell Development Co.), U. S. Patent 2,019,772 (Nov. 5, 1935).
- 697 — (to Shell Development Co.), U. S. Patent 2,073,080 (Mar. 9, 1937).
- 698 — (to Shell Development Co.), U. S. Patent 2,122,826 (July 5, 1938).
- 699 — (to Shell Development Co.), U. S. Patent 2,250,410 (July 22, 1941).
- 700 — (to Shell Development Co.), U. S. Patent 2,271,043 (Jan. 27, 1942).
- 701 — (to Shell Development Co.), U. S. Patent 2,299,716 (Oct. 20, 1942).
- 702 — (to Shell Development Co.), U. S. Patent 2,304,290 (Dec. 8, 1942).
- 703 — and J. F. M. CAUDRI (to Shell Development Co.), U. S. Patent 2,092,295 (Sept. 7, 1937).
- 704 PETRENKO, G. I., *J. Russ. Phys. Chem. Soc.*, **34**, 37-42 (1902); *Chem. Zentr.*, **73**, 1191-2 (1902).
- 705 PETROV, A. A., *J. Gen. Chem. (U.S.S.R.)*, **10**, 981-96 (1940).
- 706 —, *J. Gen. Chem. (U.S.S.R.)*, **14**, 1038-43 (1944).
- 707 —, *J. Gen. Chem. (U.S.S.R.)*, **16**, 61-4 (1946).
- 707a —, *ibid.*, **16**, 1206-12 (1946).

- 708 PEVERE, E. F. (to The Texas Co.), U. S. Patent 2,121,326 (June 21, 1938); Can. Patent 364,762 (Mar. 16, 1937).
- 709 — (to The Texas Co.), U. S. Patent 2,164,780 (July 4, 1939); Brit. Patent 437,779 (Jan. 30, 1936); Can. Patent 357,661 (May 5, 1936); Fr. Patent 790,440 (Sept. 9, 1935); Ital. Patent 329,728 (Sept. 19, 1936); Roum. Patent 23,688 (May 23, 1935).
- 710 —, L. A. CLARKE, and G. B. HATCH (to The Texas Co.), U. S. Patent 2,223,938 (Dec. 3, 1940); Fr. Patent 867,077 (June 30, 1941).
- 711 PFEIFFER, P., K. SCHWENZER, and K. KUMETAT, *J. prakt. Chem.*, **143**, 143-56 (1935).
- 712 PFLAUM, D. J., and H. H. WENZKE, *Ind. Eng. Chem., Anal. Ed.*, **4**, 392-3 (1932).
- 713 N. V. PHILIP'S GLOEILAMPFABRIEKEN, Fr. Patent 743,659 (Apr. 4, 1933).
- 714 PHILLIPS, G. M., J. S. HUNTER, and L. E. SUTTON, *J. Chem. Soc.*, **1945**, 146-62.
- 715 PIER, M., and F. CHRISTMANN (to I. G. Farbenindustrie A.-G.), Ger. Patent 594,167 (Mar. 13, 1934).
- 716 — and E. DONATH (to I. G. Farbenindustrie A.-G.), U. S. Patent 2,063,623 (Dec. 8, 1936).
- 717 PINES, H., and H. S. BLOCH (to Universal Oil Products Co.), U. S. Patent 2,349,516 (May 23, 1944).
- 718 — and V. N. IPATIEFF (to Universal Oil Products Co.), U. S. Patent 2,340,557 (Feb. 1, 1944).
- 719 — and — (to Universal Oil Products Co.), U. S. Patent 2,385,300 (Sept. 18, 1945).
- 719a PLANK, CHAS. J. (to Socony-Vacuum Oil Co.), U. S. Patent 2,428,741 (Oct. 7, 1947).
- 719b — (to Socony-Vacuum Oil Co.), U. S. Patent 2,435,695 (Feb. 10, 1948).
- 719c PLESCH, P. H., M. POLANYI, and H. A. SKINNER, *J. Chem. Soc.*, **1947**, 257-66.
- 720 POHLAND, E., and W. HARLOS, *Z. anorg. allgem. Chem.*, **207**, 242-5 (1932).
- 721 PRICE, C. C., *Chem. Rev.*, **29**, 37 (1941).
- 722 — and J. M. CISKOWSKI, *J. Am. Chem. Soc.*, **60**, 2499-2502 (1938).
- 723 — and M. LUND, *ibid.*, **62**, 3105-7 (1940).
- 724 — and M. MEISTER, *ibid.*, **61**, 1595-7 (1939).
- 724a PROCTER AND GAMBLE Co., Brit. Patent 568,725 (Apr. 18, 1945).
- 725 RABE, H., and M. OTTO (to I. G. Farbenindustrie A.-G.), U. S. Patent 2,097,468 (Nov. 2, 1937).
- 726 RAWSON, S. G., *Chem. News*, **58**, 283 (1888).
- 727 RAY, R. C., and H. C. MITRA, *Trans. Faraday Soc.*, **30**, 1161-3 (1934).
- 728 REIMERS, H. A. (to Dow Chemical Co.), U. S. Patent 1,960,712 (May 29, 1934).
- 729 — (to Dow Chemical Co.), U. S. Patent 1,972,317 (Sept. 4, 1934); Brit. Patent 404,518 (Jan. 18, 1934); Can. Patent 355,330 (Jan. 14, 1936).

- 730 RIDEAL, S., *Ber.*, **22**, 992-3 (1889).
- 731 ROBERTS, E. N. (to Standard Oil Co. of Ind.), U. S. Patent 2,409,799 (Oct. 22, 1946).
- 732 ROHRMANN, E. (to Eli Lilly and Co.), U. S. Patent 2,346,048 (Apr. 4, 1944).
- 733 ROSE, H., *Ann. physik. Chem.*, **156**, 262-84 (1850).
- 734 ROSEN, R., and E. ARUNDALE (to Standard Oil Development Co.), U. S. Patent 2,368,494 (Jan. 30, 1945).
- 735 — and O. C. SLOTTERBECK (to Standard Oil Development Co.), Can. Patent 424,127 (Nov. 28, 1944).
- 736 ROSENMUND, K. W., E. KARG, and F. K. MARCUS, *Ber.*, **75B**, 1850-9 (1942).
- 736a ROTH, W. A. *Naturforsch.*, **1**, 574-6 (1946).
- 737 — and E. BORGER, *Ber.*, **70B**, 48-54 (1937).
- 737a ROWLEY, D., Brit. Patent 571,398 (Aug. 23, 1945).
- 738 RUDDY, A. W., E. B. STARKEY, and W. H. HARTUNG, *J. Am. Chem. Soc.*, **64**, 828-9 (1942).
- 739 RUFF, O., *Die Chemie des Fluors*, Julius Springer, Berlin (1920), **25**.
- 740 —, *ibid.*, **38**.
- 741 —, *Z. anorg. allgem. Chem.*, **197**, 273-86 (1931).
- 742 — and E. ASCHER, *ibid.*, **176**, 258-70 (1928).
- 743 —, A. BRAIDA, O. BRETSCHNEIDER, W. MENZEL, and H. PLAUT, *ibid.*, **206**, 59-64 (1932).
- 744 —, F. EBERT, and W. MENZEL, *ibid.*, **207**, 46-60 (1932).
- 745 — and R. KEIM, *ibid.*, **193**, 176-86 (1930).
- 746 — and —, *ibid.*, **201**, 245-58 (1931).
- 747 — and H. KRUG, *ibid.*, **190**, 270-6 (1930).
- 748 — and W. MENZEL, *ibid.*, **202**, 49-61 (1931).
- 749 RUGGLI, P., and E. CASPER, *Helv. Chim. Acta*, **18**, 1414 (1935).
- 750 RUISS, I. G., and N. P. BAKINA, *Compt. rend. acad. sci. U.R.S.S.*, (N.S.) **2**, 107-110 (1936).
- 751 RUMMELSBURG, A. L. (to Hercules Powder Co.), U. S. Patent 2,124,675 (July 26, 1938).
- 752 — (to Hercules Powder Co.), U. S. Patent 2,302,576 (Nov. 17, 1942).
- 753 — (to Hercules Powder Co.), U. S. Patent 2,354,775 (Aug. 1, 1944).
- 754 — (to Hercules Powder Co.), U. S. Patent 2,354,776 (Aug. 1, 1944).
- 755 — (to Hercules Powder Co.), U. S. Patent 2,373,419 (Apr. 10, 1945).
- 756 — (to Hercules Powder Co.), U. S. Patent 2,374,957 (May 1, 1945).
- 757 — (to Hercules Powder Co.), U. S. Patent 2,374,958 (May 1, 1945).
- 758 — (to Hercules Powder Co.), U. S. Patent 2,378,436 (June 19, 1945).
- 759 — (to Hercules Powder Co.), U. S. Patent 2,384,400 (Sept. 2, 1945).
- 760 — (to Hercules Powder Co.), U. S. Patent 2,386,063 (Oct. 2, 1945).
- 761 RUMOLD, C. F., Ph. D. Thesis, Western Reserve Univ., Cleveland, Ohio, 1931.
- 762 RUSSELL, R. P. (to Standard Oil Development Co.), U. S. Patent 2,139,-038 (Dec. 6, 1938).
- 763 RUTHRUFF, R. E. (to Standard Oil Co. of Ind.), U. S. Patent 2,172,146 (Sept. 5, 1939).

- 764 RUTHRUFF, R. F. (to Chempats, Inc.), U. S. Patent 2,247,821 (July 1, 1941).
- 765 — U. S. Patent 2,379,656 (July 3, 1945).
- 765a RUZICKA, L., K. GÄTZI, and T. REICHSTEIN, *Helv. Chim. Acta*, **22**, 626 (1939).
- 765b —, M. W. GOLDBERG, and F. HUNZIKER, *ibid.*, **22**, 707-16 (1939).
- 765c —, and H. F. MELDAHL, *ibid.*, **21**, 1760 (1938).
- 765d — and —, *Nature*, **142**, 399 (1938).
- 766 RYSS, I. G., *J. Gen. Chem. (U.S.S.R.)*, **16**, 531-6 (1946).
- 767 —, *Compt. rend. acad. sci. U.R.S.S.*, **52**, 417-20 (1946).
- 767a —, *ibid.*, **54**, 325-7 (1946).
- 767b — and M. M. SLUTSKAYA, *J. Phys. Chem. (U.S.S.R.)*, **21**, 549-61 (1947).
- 767c —, *Zavodskaya Lab.*, **12**, 651-5 (1946).
- 768 SCHAAD, R. E. (to Universal Oil Products Co.), U. S. Patent 2,295,808 (Sept. 15, 1942).
- 768a SCHIEMANN, GUNTHER, *J. Prakt. Chem.*, **140**, 97 (1934).
- 769 — and E. BOLSTAD, *Ber.*, **61 B**, 1403-9 (1928).
- 770 — and R. PILLARSKY, *ibid.*, **62 B**, 3035-43 (1929).
- 770a — and W. WINKELMÜLLER, *Org. Syntheses*, **13**, 52 (1933).
- 771 SCHIFF, H., *Liebig's Ann. Supp.* **5**, 154-218 (1867).
- 772 — and R. SESTINI, *Liebig's Ann.*, **228**, 83 (1885).
- 773 SCHLESEMAN, C. H., and J. H. MCCRACKEN (to Socony-Vacuum Oil Co.), U. S. Patent 2,356,357 (Aug. 22, 1944).
- 774 SCHMERLING, L. (to Universal Oil Products Co.), U. S. Patent 2,344,789 (Mar. 21, 1944).
- 775 — (to Universal Oil Products Co.), U. S. Patent 2,370,494 (Feb. 27, 1945).
- 776 SCHNEIDER, H. G. (to Standard Oil Development Co.), U. S. Patent 2,197,023 (Apr. 16, 1940).
- 777 — and V. F. MISTRETTA (to Jasco, Inc.), U. S. Patent 2,414,770 (Jan. 21, 1947).
- 778 SCHRENK, W. T., and W. H. ODE, *Ind. Eng. Chem. Anal. Ed.*, **1**, 201-2 (1929).
- 779 SCHUIT, G. C. A. (to Shell Development Co.), U. S. Patent 2,265,548 (Dec. 9, 1941).
- 780 — (to Shell Development Co.), U. S. Patent 2,265,870 (Dec. 9, 1941).
- 781 SCHULTZ, R. F. (to E. I. du Pont de Nemours and Co.), U. S. Patent 2,135,458 (Nov. 1, 1938).
- 782 SCHULZE, W. A. (to Phillips Petroleum Co.), U. S. Patent 2,378,040 (June 12, 1945).
- 783 — (to Phillips Petroleum Co.), U. S. Patent 2,382,506 (Aug. 14, 1945).
- 784 — and W. N. AXE (to Phillips Petroleum Co.), U. S. Patent 2,371,849 (Mar. 20, 1945).
- 785 — and — (to Phillips Petroleum Co.), U. S. Patent 2,376,090 (May 15, 1945).
- 786 — and — (to Phillips Petroleum Co.), U. S. Patent 2,401,884 (June 11, 1946).

- 787 SCHULZE, W. A., and W. N. AXE (to Phillips Petroleum Co.), U. S. Patent 2,419,504 (Apr. 22, 1947).
- 787a — and W. W. CROUCH (to Phillips Petroleum Co.), U. S. Patent 2,426,647 (Sept. 2, 1945).
- 787b — and — (to Phillips Petroleum Co.), U. S. Patent 2,426,648 (Sept. 2, 1947).
- 788 SEEL, F., *Z. anorg. allgem. Chem.*, **250**, 331–51 (1943).
- 789 SEGRÈ, E., and C. WIEGAND, *Rev. Sci. Instruments*, **18**, 86–9 (1947).
- 790 SEGUIN, J. M., *Compt. rend.*, **54**, 933–5 (1862).
- 791 SELKER, M. L., Ph. D. Thesis, Western Reserve Univ., Cleveland, Ohio, 1940.
- 792 SENSEL, E. E., and A. R. GOLDSBY (to The Texas Co.), U. S. Patent 2,331,429 (Oct. 12, 1943).
- 793 SEWARD, R. P., and J. H. SIMONS, *J. Chem. Phys.*, **7**, 2–3 (1939).
- 794 SHEINTSIS, O. G., *J. Applied Chem. (U.S.S.R.)*, **13**, 1101–3 (1940).
- 795 SHEN, G., T. Y. JU, and C. E. WOOD, *J. Inst. Petroleum Tech.*, **26**, 475–87 (1940).
- 796 SHOEMAKER, B. H., and E. L. OUVILLE (to Standard Oil Co. of Ind.), U. S. Patent 2,390,621 (Dec. 11, 1945).
- 797 SHOPPEE, C. W., *Helv. Chim. Acta*, **27**, 8–23 (1944).
- 798 — and D. A. PRINS, *ibid.*, **26**, 185–200 (1943).
- 799 — and —, *ibid.*, **26**, 201–23 (1943).
- 800 — and —, *ibid.*, **26**, 1004–16 (1943).
- 801 — and —, *ibid.*, **26**, 2089–95 (1943).
- 802 GEBRÜDER SIEMENS U. CIE, Ger. Patent 279,011 (1915).
- 803 DE SIMO, M., and F. B. HILMER (to Shell Development Co.), U. S. Patent 2,085,524 (June 29, 1937); U. S. Reissue 22,210 (Oct. 27, 1942).
- 804 — and — (to Shell Development Co.), U. S. Patent 2,085,525 (June 29, 1937).
- 805 — and — (to Shell Development Co.), U. S. Patent 2,099,513 (Nov. 16, 1937).
- 806 —, H. C. LAWTON, and A. G. LOOMIS (to Shell Development Co.), U. S. Patent 2,214,363 (Sept. 10, 1940).
- 807 —, and F. M. McMILLAN (to Shell Development Co.), U. S. Patent 2,270,669 (Jan. 20, 1942).
- 808 SKOOG LUND, A. C. (to Jasco, Inc.), U. S. Patent 2,300,069 (Oct. 27, 1942).
- 809 SLANINA, S. J., F. J. SOWA, and J. A. NIEUWLAND, *J. Am. Chem. Soc.*, **57**, 1547–9 (1935).
- 810 SLOTTERBECK, O. C. (to Standard Oil Development Co.), U. S. Patent 2,296,370 (Sept. 22, 1942).
- 811 — and R. ROSEN (to Standard Oil Development Co.), U. S. Patent 2,296,371 (Sept. 22, 1942).
- 812 SMITH, F. B., and H. W. MOLL (to Dow Chemical Co.), U. S. Patent 2,246,988 (June 24, 1941).
- 813 SMITH, L. E., and H. L. HALLER, *J. Am. Chem. Soc.*, **56**, 237–9 (1934).

- 814 SMYERS, W. H. (to Standard Oil Development Co.), U. S. Patent 2,274,749 (Mar. 3, 1942).
- 815 SNOW, H. R. (to Standard Oil Co. of Ind.), U. S. Patent 1,907,402 (Aug. 14, 1934).
- 816 SNYDER, H. R., H. A. KORNBERG, and R. J. ROMIG, *J. Am. Chem. Soc.*, **61**, 3556-8 (1939).
- 817 — and C. W. SMITH, *ibid.*, **65**, 2452-4 (1943).
- 817a —, J. M. STEWART, and J. B. ZIEGLER, *ibid.*, **69**, 2675 (1947).
- 818 SOCIÉTÉ RHODIACETA, Fr. Patent 843,726 (July 10, 1939).
- 819 SODAY, F. J. (to the United Gas Improvement Co.), U. S. Patent 2,366,-219 (Jan. 2, 1945).
- 820 SOWA, D. J., *J. Am. Chem. Soc.*, **60**, 654-6 (1938).
- 821 —, U. S. Patent 2,367,535 (Jan. 16, 1945).
- 822 —, G. F. HENNION, and J. A. NIEUWLAND, *J. Am. Chem. Soc.*, **57**, 709-11 (1935).
- 823 —, H. D. HINTON, and J. A. NIEUWLAND, *ibid.*, **54**, 2019-21 (1932).
- 824 —, —, and —, *ibid.*, **54**, 3694-8 (1932).
- 825 —, —, and —, *ibid.*, **55**, 3402-7 (1933).
- 826 —, J. W. KROEGER, and J. A. NIEUWLAND, *ibid.*, **57**, 454-6 (1935).
- 827 —, and J. A. NIEUWLAND, *ibid.*, **55**, 5052-3 (1933).
- 828 — and —, *ibid.*, **58**, 271-2 (1936).
- 829 — and —, *ibid.*, **59**, 1202-3 (1937).
- 830 SPACU, G., and L. DIMA, *Bul. Soc. Stiinte Chij*, **8**, 549-55 (1937).
- 831 — and —, *Z. anorg. allgem. Chem.*, **223**, 185-91 (1935).
- 832 SPENCER, H. M., *J. Chem. Phys.*, **14**, 729-32 (1946).
- 833 SPIEGLER, L. and J. M. TINKER, *J. Am. Chem. Soc.*, **61**, 1002-4 (1939).
- 834 STAHLY, E. E. (to Jasco, Inc.), U. S. Patent 2,388,095 (Oct. 30, 1945).
- 835 STANDARD OIL DEVELOPMENT Co., Brit. Patent 432,310 (May 10, 1934).
- 836 —, Brit. Patent 483,453 (Apr. 20, 1938); Fr. Patent 826,933 (Apr. 13, 1938).
- 837 —, Brit. Patent 496,966 (Dec. 9, 1938); U. S. Patent 2,160,172 (May 30, 1939).
- 838 —, Brit. Patent 501,670 (Mar. 3, 1939).
- 839 —, Brit. Patent 504,041 (Apr. 19, 1939).
- 840 —, Brit. Patent 513,521 (Oct. 16, 1939).
- 841 —, Brit. Patent 539,480 (Sept. 12, 1941).
- 842 —, Brit. Patent 550,711 (Jan. 20, 1943).
- 843 —, Brit. Patent 551,961 (May 6, 1943).
- 844 —, Brit. Patent 558,487 (Jan. 7, 1944).
- 845 —, Brit. Patent 558,811 (Jan. 24, 1944).
- 846 —, Brit. Patent 559,067 (Feb. 2, 1944).
- 846a —, Brit. Patent 577,747 (May 30, 1946).
- 846b —, Brit. Patent 580,407 (Sept. 6, 1946).
- 847 —, Brit. Patent 580,408 (Sept. 6, 1946).
- 847a —, Brit. Patent 582,983 (Dec. 4, 1946).
- 848 —, Brit. Patent 584,426 (Jan. 15, 1947).
- 848a —, Brit. Patent 584,428 (Jan. 15, 1947).

- 848b STANDARD OIL DEVELOPMENT Co., Brit. Patent 591,283 (Aug. 13, 1947).
849 —, Fr. Patent 823,270 (Jan. 18, 1938).
850 —, Fr. Patent 827,165 (Apr. 20, 1938); S. BERKMAN, J. C. MORRELL, and G. EGLOFF, *Catalysis*, Reinhold Pub. Corp., New York (1940), 941.
851 —, Fr. Patent 827,469 (Apr. 27, 1938).
852 —, Fr. Patent 829,600 (June 30, 1938).
853 —, Fr. Patent 831,750 (Sept. 13, 1938).
854 —, Fr. Patent 834,018 (Nov. 9, 1938).
855 —, Fr. Patent 846,228 (Sept. 12, 1939); *Chem. Zentr.*, **1940**, **III**, 2689.
856 STANLEY, H. M., *J. Soc. Chem. Ind.*, **49**, 349T-54T (1930).
857 STARKEY, E. B., *J. Am. Chem. Soc.*, **59**, 1479 (1937).
858 —, *Org. Syntheses*, **19**, 40-2 (1939).
859 STAUDINGER, H., and H. A. BRUSON, *Ann.*, **447**, 110-22 (1929).
860 STEIMMIG, G., and K. BAUR (to I. G. Farbenindustrie A.-G.), Ger. Patent 578,722 (June 16, 1933).
861 STEPHENSON, H. H., *Chem. News.*, **102**, 178-80 (1910).
862 STIEBER, A., *Compt. rend.*, **195**, 610-1 (1932).
862a STEVENS, H. P., and C. J. MILLER, *Proc. Rubber Tech. Conf. London*, May, 1938.
863 STOKMAN, II., K. E. MARPLE, E. D. SHOKAL, and T. W. EVANS (to Shell Development Co.), U. S. Patent 2,199,940 (May 7, 1940).
864 —, —, —, and — (to Shell Development Co.), U. S. Patent 2,260,753 (Oct. 28, 1941).
865 STOLBA, F., *Centr. ges. chem. Grossind.*, **7**, 459-60 (1890).
866 —, *Chem. Zentr.*, **3**, 395-98 (1872).
867 —, *ibid.*, **46**, 403-4 (1875).
868 —, *ibid.*, **47**, 703 (1876).
869 —, *Z. anal. Chem.*, **3**, 312 (1864).
870 —, *Z. anal. Chem.*, **9**, 95-6 (1870).
871 STORY, L. G. (to The Texas Co.), U. S. Patent 2,261,004 (Oct. 28, 1941).
872 — (to The Texas Co.), U. S. Patent 2,355,339 (Aug. 8, 1944).
873 — (to The Texas Co.), U. S. Patent 2,373,612 (Apr. 10, 1945).
874 STRAWN, L. R. (to The Texas Co.), U. S. Patent 2,311,096 (Feb. 16, 1943).
875 STROMEYER, A., *Liebig's Ann.*, **100**, 82-99 (1856).
876 STRONG, H. M., and H. P. KNAUSS, *Phys. Rev.*, **49**, 740-4 (1936).
877 STROUP, P. T. (to The Aluminum Co. of America), U. S. Patent 2,380,202 (July 10, 1945).
878 STRUYK, C., and A. E. CARLSON, *Metal Ind.*, **69**, 348-52 (1946); *Monthly Rev. Am. Electroplaters' Soc.*, **33**, 923-34 (1946).
879 SUGDEN, S., and M. WALOFF, *J. Chem. Soc.*, **1932**, 1492-7.
880 SULLIVAN, F. W., JR., and V. VOORHEES (to Standard Oil Co. of Ind.), U. S. Patent 2,091,398 (Aug. 31, 1937).
881 SUTER, C. M. (to The Procter and Gamble Co.), U. S. Patent 2,366,133 (Dec. 26, 1944).

- 882 SWINEHART, C. F. (to Harshaw Chemical Co.), U. S. Patent 2,148,514 (Feb. 28, 1939).
- 883 — (to Harshaw Chemical Co.), U. S. Patent 2,196,907 (Apr. 9, 1940).
- 884 —, A. R. BUMBLIS, and H. F. FLISIK, *Anal. Chem.* **19**, 28-32 (1947).
- 885 TAWDE, N. R., and R. C. JOHNSON, *Phil. Mag.*, **13**, 501-4 (1932).
- 885a TAYLOR, E. G., and C. A. KRAUS, *J. Am. Chem. Soc.*, **69**, 1731-5 (1947).
- 885b THACKER, C. M. (to The Pure Oil Co.), U. S. Patent 2,435,761 (Feb. 10, 1948).
- 886 THADDEEFF, C., *Z. anal. Chem.*, **36**, 568-637 (1897).
- 887 THÉNARD, L. J., and J. L. GAY-LUSSAC, *Ann. chim.*, **69**, 204-220 (1809).
- 888 THOMAS, R. J., W. F. ANZILOTTI, and G. F. HENNION, *Ind. Eng. Chem.*, **32**, 408-10 (1940).
- 889 —, W. J. SPARKS, P. K. FROLICH, M. OTTO, and M. MUELLER-CUNRADI, *J. Am. Chem. Soc.*, **62**, 276-80 (1940).
- 890 THOMPSON, K. M. (to Atlantic Refining Co.), U. S. Patent 2,382,184 (Aug. 14, 1945).
- 890a THOMPSON, W. E., and C. A. KRAUS, *J. Am. Chem. Soc.*, **69**, 1016-20 (1947).
- 891 THOMSEN, J., *Thermochem, Untersuchungen*, Leipzig, **2**, 421-2 (1882).
- 892 —, *Thermochem, Untersuchungen*, Stuttgart, 1906, 65.
- 893 THOMSON, T., *Ann. Phil.*, **1**, 177-82 (1813).
- 893a THURSTON, J. T. (to Am. Cyanamid Co.), U. S. Patent 2,416,656 (Feb. 25, 1947).
- 894 TOOLE, S. G., and F. J. SOWA, *J. Am. Chem. Soc.*, **59**, 1971-3 (1937).
- 894a TOPCHIEV, A. V., and Y. M. PAUSHKIN, *Neftyanoe Khoz*, **25**, no. 6, 54-9, (1947).
- 895 — and B. M. TUMMERMAN, *Neftyanoe Khoz*, **24**, no. 11, 45-50 (1946).
- 896 TOUSSAINT, N. F., and G. F. HENNION, *J. Am. Chem. Soc.*, **62**, 1145-7 (1940).
- 897 TOUSSAINT, W. J. (to Carbide and Carbon Chemicals Corp.), U. S. Patent 2,293,868 (Aug. 25, 1942).
- 898 TOWNE, C. C. (to The Texas Co.), U. S. Patent 2,078,472 (Apr. 27, 1937); Arg. Patent 43,825 (Feb. 17, 1936); Brit. Patent 460,583 (Apr. 22, 1937); Can. Patent 366,290 (May 25, 1937); Fr. Patent 794,968 (Dec. 26, 1935).
- 899 — (to The Texas Co.), U. S. Patent 2,086,399 (July 6, 1937); Can. Patent 377,980 (Nov. 29, 1938).
- 900 — (to The Texas Co.), U. S. Patent 2,199,352 (Apr. 30, 1940); Brit. Patent 476,281 (Feb. 24, 1938); Can. Patent 383,457 (Aug. 15, 1939); Fr. Patent 819,339 (July 5, 1937); Hol. Patent 48,380 (Apr. 16, 1940).
- 901 — (to The Texas Co.), U. S. Patent 2,364,830 (Dec. 12, 1944).
- 902 TRAVERS, A., and L. MALAPRADE, *Bull. soc. chim.*, **47**, 788-801 (1930).
- 903 — and —, *Compt. rend.*, **187**, 765-7 (1928).
- 904 — and —, *ibid.*, **187**, 891-2 (1928).
- 905 — and —, *ibid.*, **187**, 982-4 (1928).
- 906 TREPP, S. G. (to The United Gas Improvement Co.), U. S. Patent 2,356,494 (Aug. 22, 1944).

- 907 TREPP, S. G. (to The United Gas Improvement Co.), U. S. Patent 2,387,624 (Oct. 23, 1945).
- 908 ULOTH, R., and M. MUELLER-CUNRADI, U. S. Patent 2,365,919 (Dec. 26, 1944).
- 909 UNIVERSAL OIL PRODUCTS Co., Brit. Patent 492,727 (Sept. 26, 1938).
- 910 —, Fr. Patent, 820,579 (Nov. 15, 1937).
- 911 —, Fr. Patent 823,592 (Jan. 22, 1938); Ital. Patent 351,888 (June 5, 1937); S. BERKMAN, J. C. MORRELL, and G. EGLOFF, *Catalysis*, Reinhold Pub. Corp., New York (1940), 934.
- 912 —, Fr. Patent 823,594 (Jan. 22, 1938).
- 912a VAN ARSDELL, P. M., *Metal Finishing*, **45**, no. 8, 55–60; **67**, no. 9, 79–83; no. 10, 75–81.
- 913 VAN GILDER, C. F., and H. C. EVANS (to Jasco, Inc.), U. S. Patent 2,395,086 (Feb. 19, 1946).
- 914 VAUGHN, T. H., *Proc. Indiana Acad. Sci.*, **42**, 127–30 (1933).
- 915 —, H. BOWLUS, and J. A. NIEUWLAND, *ibid.*, **40**, 203–6 (1931).
- 916 — and J. A. NIEUWLAND, *ibid.*, **42**, 131–3 (1932).
- 917 VELTMAN, P. L. (to The Texas Co.), U. S. Patent 2,286,129 (June 9, 1942); Brit. Patent 554,096 (Sept. 9, 1943); Can. Patent 413,730 (July 6, 1943).
- 918 — (to The Texas Co.), U. S. Patent 2,337,432 (Dec. 21, 1943).
- 919 — (to The Texas Co.), U. S. Patent 2,351,562 (June 13, 1944).
- 920 — (to The Texas Co.), U. S. Patent 2,406,721 (Aug. 27, 1946); Iran Patent 1036 (Aug. 2, 1945); Iraq Patent 70/400 (Oct. 14, 1945).
- 921 VERMILION, G., and M. A. HILL, *J. Am. Chem. Soc.*, **67**, 2209 (1945).
- 922 VIERLING, K. (to I. G. Farbenindustrie A.-G.), U. S. Patent 2,198,046 (Apr. 23, 1940).
- 923 VOORHEES, V. (to Standard Oil Co. of Ind.), U. S. Patent 2,073,506 (Mar. 9, 1937).
- 924 — (to Standard Oil Co. of Ind.), U. S. Patent 2,092,296 (Sept. 7, 1937).
- 925 — (to Standard Oil Co. of Ind.), U. S. Patent 2,096,218 (Oct. 19, 1937).
- 926 — (to Standard Oil Co. of Ind.), U. S. Patent 2,132,711 (Oct. 11, 1938).
- 927 — (to Standard Oil Co. of Ind.), U. S. Patent 2,194,341 (Mar. 19, 1940).
- 928 — (to Standard Oil Co. of Ind.), U. S. Patent 2,418,797 (Apr. 8, 1947).
- 929 — (to Standard Oil Co. of Ind.), U. S. Patent 2,259,671 (Oct. 21, 1941).
- 930 VORLÄNDER, D., J. HOLLATZ, and J. FISCHER, *Ber.*, **65 B**, 535–8 (1932).
- 931 VOZNESENSKII, S. A., and P. P. KURSKI, *J. Gen. Chem. (U.S.S.R.)*, **8**, 524–8 (1938).
- 932 WADLEY, E. F., and J. T. HOROCZY (to Standard Oil Development Co.), U. S. Patent 2,408,010 (Sept. 24, 1946).
- 932a WAGNER, C. D., T. GOLDSTEIN, and E. D. PETERS, *Anal. Chem.*, **19**, 103–5 (1947).
- 933 WALKER, H. G., and C. R. HAUSER, *J. Am. Chem. Soc.*, **68**, 2742 (1946).

- 934 WALKUP, J. H., Ph. D. Thesis, Western Reserve Univ., Cleveland, Ohio, 1943.
- 935 WALTERS, S. L., and R. R. MILLER, *Ind. Eng. Chem., Anal. Ed.*, **18**, 658 (1946).
- 935a WAMSER, CHRISTIAN A., *J. Am. Chem. Soc.*, **70**, 1209-15 (1948).
- 936 VON WARTENBERG, H., *Z. anorg. allgem. Chem.*, **151**, 326-30 (1926).
- 937 WATERMAN, H. I., and J. J. LEENDERTSE, *Trans. Faraday Soc.*, **32**, 251-8 (1936).
- 938 WATSON, H. E., G. P. KANE, and K. L. RAMASWAMY, *Proc. Roy. Soc. (London)*, **A 156**, 130-43 (1936).
- 939 — and K. L. RAMASWAMY, *ibid.*, **A 156**, 144-57 (1936).
- 939a WATSON, M. W., J. O. BUCHANAN, and F. K. ELDER, JR., *Phys. Rev.*, **71**, 887-90 (1947).
- 940 WATTS, O. P., *Monthly Rev., Am. Electroplaters' Soc.*, Mar. 1921.
- 940a —, *Trans. Am. Electrochem. Soc.*, **23**, 145 (1913).
- 941 WEBB, W. L. (to Standard Oil Co. of Ind.), U. S. Patent 2,099,090 (Nov. 16, 1937); S. BERKMAN, J. C. MORRELL, and G. EGLOFF, *Catalysis*, Reinhold Pub. Corp., New York (1940), 966.
- 942 WELSH, C. E., and G. F. HENNION, *J. Am. Chem. Soc.*, **63**, 2603-4 (1941).
- 943 WELTE, F., *Die Nitrosylborfluoride*, Thesis, Stuttgart, 1930; *C. A.*, **27**, 1292 (1933).
- 944 WHALEY, W. M., and E. B. STARKEY, *J. Am. Chem. Soc.*, **68**, 793-5 (1946).
- 945 WHITE, W. E. (to Aluminum Co. of America), U. S. Patent 2,403,148 (July 2, 1946).
- 946 WHITMORE, F. C., and J. F. LAUCIUS, *J. Am. Chem. Soc.*, **61**, 973-4 (1939).
- 947 WIBERG, E., and U. HEUBAUM, *Z. anorg. allgem. Chem.*, **225**, 270-2 (1935).
- 948 — and W. MÄTHING, *Ber.*, **70 B**, 690-7 (1937).
- 949 — and W. SÜTTERLIN, *Z. anorg. allgem. Chem.*, **202**, 37-48 (1931).
- 950 WILKE-DÖRFURT, E., *Z. angew. Chem.*, **37**, 712 (1924).
- 951 — and G. BALZ, *Ber.*, **60 B**, 115-18 (1927).
- 952 — and —, *Z. anorg. allgem. Chem.*, **159**, 197-225 (1927).
- 952a —, — and A. WEINHARDT, *Z. anorg. allgem. Chem.*, **185**, 417 (1930).
- 953 WILLIAMS, IRA (to E. I. du Pont de Nemours and Co.), U. S. Patent 2,158,530 (May 16, 1935).
- 954 WILSDON, B. H., *Phil. Mag.*, **49**, 336-54 (1925).
- 954a WISCHONKE, C. R., and C. A. KRAUS, *J. Am. Chem. Soc.*, **69**, 2472-81 (1947).
- 955 WOHL, A., and E. WERTYPOROCH, *Ber.*, **64**, 1360 (1931).
- 956 WOLFF, W. (to Gen. An. and Film Corp.), U. S. Patent 2,231,649 (Feb. 11, 1941).
- 957 WOOD, J. E., III, and C. S. LYNCH (to Standard Oil Development Co.), U. S. Patent 2,354,565 (July 25, 1944).
- 958 WOODHOUSE, J. C. (to E. I. du Pont de Nemours and Co.), U. S. Patent 2,135,447 (Nov. 1, 1938).

- 959 WUNDERLY, H. L., and F. J. SOWA, *J. Am. Chem. Soc.*, **59**, 1010-11 (1937).
- 960 —, F. J. SOWA, and J. A. NIEUWLAND, *ibid.*, **58**, 1007-9 (1936).
- 961 YARNALL, W. A. (to The Texas Co), U. S. Patent 2,257,896 (Oct. 7, 1941).
- 962 YATLOV, V. S., and E. N. PIMEVSKAYA, *J. Gen. Chem. (U.S.S.R.)*, **15**, 72, (1945).
- 963 YOST, D. M., D. DEVAULT, T. F. ANDERSON, and E. N. LASSETTRE, *J. Chem. Phys.*, **6**, 424-5 (1938).
- 964 YOUNG, DE W. S., and J. H. PEARSON (to General Chemical Co.), U. S. Patent 2,416,133 (Feb. 18, 1947).
- 965 ZALKIND, Y. S., and V. I. BARANOV, *J. Gen. Chem. (U.S.S.R.)*, **10**, 1432-4 (1940).
- 966 ZAMBONINI, F., *Atti accad. Lincei*, (5) **31ii**, 67-73 (1922).
- 967 —, *Z. Kryst. Min.*, **41**, 53-62 (1906).
- 968 ZANDEN, J. M. v.d., M. G. DE VRIES, and R. H. DIJKSTRA, *Rec. trav. chim.*, **61**, 280-4 (1942).
- 969 ZAVGORODNI, S. V., *J. Gen. Chem. (U.S.S.R.)*, **14**, 270-3 (1944).
- 970 —, *J. Gen. Chem. (U.S.S.R.)*, **14**, 428-34 (1944).
- 970a —, *ibid.*, **16**, 1495-1504 (1946).
- 971 —, *Trudy Voronezh. Gosudarst. Univ. (Acta Univ. Voronegiensis)*, **10**, no. 2, 41-99 (1938).
- 971a — and K. FEDOSEEVA, *J. Gen. Chem. (U.S.S.R.)*, **16**, 2006-10 (1946).
- 971b ZEDLER, R. F., and R. I. LUMAN, Circular C-6, July, 1947, Isotopes Branch, U. S. Atomic Energy Commission, Oak Ridge, Tenn.
- 972 ZEISE, W. C., *Schweigger's J.*, **32**, 306-312 (1821).
- 973 ZELINSKY, DENISENKI, EVONTOVA, and KHROMOV, *Sintet. Kauchuk (U.S.S.R.)*, **4**, 11 (1933); S. BERKMAN, J. C. MORRELL, and G. EGLOFF, *Catalysis*, Reinhold Pub. Corp., New York (1940), 965.

Author Index

- Abegg, R., 162
Adams, R. M., 83
Allen, H. D., 239
Arke, Van A. E., 91
Aston, F. W., 28
Axe, W. N., 74, 163
- Bailey, C. R., 24
Bakina, N. P., 106, 230
Baldeschieler, E. L., 3, 11
Balz, G., 44, 76, 110-111, 113-118,
120-128, 131, 133-137, 139, 141-142
Barker, E. F., 24
Barker, T. V., 102
Bart, H., 137
Basarow, A., 53, 87, 158-159
Battenberg, E., 147
Baudrimont, A., 32
Bauer, S. H., 22, 36, 68, 76
Baumgarten, P., 33, 56, 97, 101
Baxter, G. P., 21
Berger, K., 11, 134
Berthelot, M., 22, 91, 218
Berzelius, J. J., 12, 20, 53, 75, 87-89,
95, 97, 99, 102-103, 105, 108, 110-
114, 122, 126, 132, 158, 162, 164
Besson, A., 50
Betts, A. G., 132
Beyersdorfer, P., 102
Bichowsky, F. R., 22
Biltz, W., 18, 20
Binder, F., 111, 115-117, 120, 122,
125-126, 128-129, 131-132, 139
Blum, W., 120
Boehm, G., 99, 106
Bolth, F. A., 141
Booth, H. S., 7, 9-10, 12, 16, 21, 23,
25, 32, 39, 42, 49, 56-58, 61, 75-76,
78, 99, 104, 109, 208
- Borger, E., 22
Bouchetal de la Roche, 239
Bowlus, H., 45, 47, 61, 65-66, 70-72
Braida, A., 18
Braune, H., 24
Bretschneider, O., 18
Bright, J. B., 45
Brockway, L. O., 24
Brown, E. H., 7, 36, 44, 64-65, 83-84
Brunns, W., 33, 56, 97, 101
Bruson, H. S., 69
Bryant, R. C., 9
Buchner, M., 9, 99
Bumblis, A. R., 233, 239
Burg, A. B., 36, 56, 58, 61, 64-65, 84
Burk, R. E., 45
Butlerow, A., 13, 207, 209
- Cade, Geo. N., 29
Cannizzaro, S., 62, 195
Carlson, A. E., 122
Caron, H., 2
Carrière, G., 91
Carter, J., 16, 21, 23, 75
Cikowski, J. M., 42
Cleaveland, M., 68
Condike, G. F., 43-44
Councler, C., 153, 208
Croxall, W. J., 73
Curtis, G. H., 106, 109
- Davy, H., 1-2, 28, 31, 43, 88, 228
Davy, J., 4, 20, 56, 87
DeBoer, J. H., 9, 90-91, 96-97, 99,
102-103, 106-108
Delavaalt, R., 31
Desfosses, 4
Deville, H. S. C., 2
Dial, R. E., 51

- Dima, L., 116, 118-119, 121, 129-130
Dorris, T. B., 158
Dull, R. B., 27-28
Dumas, J. B., 20
Dunderman, F. V., 68
Dunker, M. F. W., 139-140, 142
Dunn, R. E., 29
- Ebert, F., 25
Egloff, G., 209
Eistert, B., 25
Étard, A., 8
Eucken, A., 16, 22-24
- Fabian, F. G., 120
Faraday, M., 16
Ferguson, R. P., 19, 24
Fernelius, W. C., 45
Finbak, C., 102, 110
Finger, G. C., 99, 141
Finlay, G. R., 22, 56, 76, 81
Fischer, F., 88, 132
Fischer, J., 102, 110
Fischer, W., 18-20, 25
Flisik, H. F., 232, 239
Foster, A. L., 202
Fowler, D. L., 150
Fox, C. J. J., 162
Frery, S. G., 10, 31
Funk, H., 111-112, 115-117, 120, 122,
125-126, 128-129, 131-132, 139
Furman, N. H., 239
- Gage, D. M., 24
Gamble, E. L., 32, 100
Gatzi, K., 32
Gay-Lussac, J. L., 1-4, 28, 31, 43, 53,
87, 90, 95, 108, 126
Gerhart, H. L., 43
Germann, A. F. O., 56-58, 68, 76
Giebelhausen, H., 10
Gilmont, P., 32, 100
Godeffroy, R., 106
Gold, H., 147
Gorainow, W., 13, 207
Gore, G., 6
Grimm, H. G., 102
Grummitt, O. J., 46, 73
- Guye, P. A., 20-21
- Hale, J. B., 24
Hammerl, H., 91
Hantzsch, A., 134, 151
Harlos, W., 10, 16, 18
Harris, W. B., 94
Harshaw Chemical Co., 8, 13, 233,
252-254
Harshaw, W. J., 13
Hartung, W. H., 138, 140
Hassel, O., 102, 110
Hastings, J., 36
Heiser, H. W., 89, 94
Heller, H. A., 47, 135
Hellriegel, W., 104
Henkel, P., 26
Hepp, H. J., 29
Herz, W., 162
Hill, Terrell, 55
Hinton, H. D., 63
Hinz, G., 147
Hofmann, F., 13
Hofmann, P., 147, 198
Hollard, A., 120
Hollatz, J., 102, 110
Homeyer, I., 94
Housemann, H. V., 88, 95
- Jannasch, P., 4, 9
Jenkins, G. L., 142
Johnson, J. R., 35
Johnson, R. C., 27
Jones, T. R., 230
- Kane, G. P., 26
Kern, Edward F., 120, 230
Ketelaar, J. A. A., 53, 93, 108, 110,
131, 161
Klemm, W., 26
Klinkenberg, L. J., 53-54, 93, 98, 102,
107-108, 110, 131, 161
Knauss, H. P., 27
Kornberg, H. A., 46
Köstermann, E., 102
Kraus, C. A., 7, 36, 44, 96, 135, 147,
150
Krause, E., 35-36, 38

- Kroeger, J. W., 139, 154
 Kroning, E., 147
 Kuhlmann, F., 49, 56
 Kumetat, K., 135

 Landolph, F., 42, 45, 53, 61, 64-65,
 70, 75, 152-153, 164, 195, 207-208,
 215, 218
 Lange, W., 123-124, 136, 229, 238
 Laubengayer, A. W., 19, 22, 24, 43-
 44, 47, 76, 81
 LeBoucher, L., 18-20
 Lee, I. E., 88, 95
 LeFevre, R. J. W., 142
 Leuchs, G., 122, 125
 Levy, H. A., 24
 Lewis, G. N., 83, 166
 Linkc, R., 26
 Linnett, J. W., 27
 Loder, D. J., 6, 9
 Long, K. E., 76
 Lordkipanidze, S., 154, 163
 Luder, W. F., 197, 205

 McAlevy, A., 6
 McCusker, P. A., 155, 159, 162
 McGrath, J. S., 155, 159, 162
 McIntyre, G. H., 3, 33, 55, 239
 McKenna, J. F., 72
 Maier-Hüser, H., 65, 70, 72
 Mailänder, N., 76
 Malaprade, L., 90, 100, 151-152, 162,
 232
 Marcovitch, S., 250
 deMarignac, J. C. B., 105
 Martin, D. R., 49, 51, 58, 78
 van Mater, H. L., 100
 Mathers, F. C., 88, 95, 99
 Mäthing, W., 19, 82
 Mayer, R., 146
 Meerwein, H., 44, 46, 55, 62-66, 69-
 70, 72, 84, 147, 195, 198
 Melikoff, P. G., 154, 163
 Menzel, W., 18, 25
 van der Meulen, P. A., 47, 100, 135
 Meyerhofer, A. F., 90, 126
 Michalske, A., 13
 Millar, R. W., 24

 Miller, M. A., 49, 66, 73
 Miller, N., 228, 239
 Miller, R. R., 248
 Miolati, A., 119
 Mitra, H. C., 104
 Mixter, W. G., 43
 Moissan, H., 10-12, 18, 31
 Montemartini, C., 100, 102
 Morgan, G. T., 34-35, 64, 71-72
 Motylewsky, S., 99, 103
 Mulert, O., 91
 Murray, W. S., 130

 Narcus, H., 94, 122, 125, 128, 130
 Newkirk, A. E., 19, 24
 Nieuwland, J. A., 13, 45-47, 61, 63,
 65-66, 70-73, 139, 154, 156, 158, 194
 Nikitina, E. A., 39
 Nitsche, R., 35-36
 Nobbe, P., 38

 O'Connor, M. J., 70
 Ode, W. H., 5
 Ouvard, L., 9

 Pannwitz, W., 44, 55, 62-63, 65-66,
 69, 84
 Patein, G., 47
 Petrenko, G. I., 153-154, 163
 Pfeiffer, D. J., 135
 Pfeil, E., 147
 Pflaum, 248
 Pillarsky, R., 139
 Pinnow, P., 24
 Plaut, H., 18
 Pohland, E., 10, 16, 18
 Price, C. C., 42

 Ramaswamy, K. L., 26
 Rawson, S. G., 31
 Ray, R. C., 104
 Reed, F. H., 99, 141
 Rehmar, S., 109
 Reimers, H. A., 49
 Rideal, S., 44
 Rohrmann, E., 26
 Romig, R. J., 46
 Rose, H., 56, 104-105

- Ross, M. K., 58, 61
 Rossi, G., 119
 Rossini, F. D., 22
 Roth, W. A., 22, 91
 Ruddy, A. W., 138, 140
 Ruff, O., 5, 12, 18-19, 23, 25, 33
 Ruiss, I. G., 106, 230
 Rummelsburg, A. L., 104, 106-107
 Rumold, C. F., 4, 12, 20-21, 25
 Ruthruff, R. E., 36
 Ruzicka, L., 175
 Ryss, I. G., 96, 162
- Schiemann, G., 110, 137, 139-142
 Schiff, H., 105, 152-153
 Schill, F., 198
 Schlesinger, H. I., 64-65, 84
 Schrenk, W. T., 5
 Schröder, E., 16, 22-24
 Schwenzler, K., 135
 Sears, D. S., 47
 Seguin, J. M., 32
 Sheintsis, O. G., 106, 108, 111, 129, 133
 Shen, G., 205
 Shoppee, C. W., 175
 Snyder, H. R., 35, 46
 Sowa, F. J., 46, 63, 70, 72-73, 139, 154, 158
 Spacu, G., 116, 118-119, 121, 129-130
 Spiegler, L., 157
 Stack, G. G., 155, 159, 162
 Starkey, E. B., 137-142
 Stephenson, H. H., 18
 Stewart, C. O., 88, 95
 Stiff, J. F., 32, 100
 Stolba, F., 5, 9, 89, 101, 103, 105-106, 109-110, 229
 Stromeyer, A., 100, 103-105
 Struyk, C., 122
 Sugden, S., 45-46
 Swinehart, C. F., 8, 13-14, 55, 164, 232, 239
- Tawde, N. R., 27
- Taylor, R., 35, 71-72
 Thaddeeff, C., 100, 105
 Thénard, J. L., 1-2, 4, 28, 31, 53, 87, 90, 95, 108, 126
 Thiele, K., 88, 132
 Thompson, J. W., 24
 Thompson, W. E., 96, 135
 Thomsen, J., 90
 Thomson, T., 20
 Tinker, J. M., 158
 Torrey, G. G., 76
 Travers, A., 90, 100, 151-152, 162, 232
 Tunstall, R. B., 34, 64
 Turner, L. B., 142
- Van Campen, M. G., 35
 van Liempt, J. A. M., 9, 91, 96, 103, 108
 Von Wartenberg, H., 22, 90
 Vorländer, D. L., 102, 110
 Vossen, D., 46, 64, 72, 195
- Walkup, J. H., 58-59, 76
 Waloff, M., 45-46
 Walters, S. L., 248
 Wamser, Christian A., 88-89, 92, 152, 162, 232, 238
 Weber, H., 4, 9
 Weidemann, W., 19-20
 Welte, F., 134
 Wenzke, H. H., 248
 Whaley, W. M., 138, 141
 Wiberg, E., 19, 82
 Wilke-Dörfurt, E., 91, 111-118, 120, 122-124, 126-128, 131-138, 141
 Willfang, G., 147
 Willson, K. S., 7, 12, 21, 25, 39
 Wilsdon, B. H., 22
 Wischonke, C. R., 147
 Wood, C. E., 205
- Zambonini, F., 102-103, 106-107
 Zeise, W. C., 95
 Zinser, W., 44, 110, 114, 121, 125, 127
 Zuffanti, S., 197, 205

Subject Index

- Acetaldehyde, trimethyl, compounds
with boron trifluoride, 64
- Acetals, mechanism of formation, 71
- Acetamide, complex with boron trifluoride, 45
- Acetanilide, compound with boron trifluoride, 45
- Acetates as catalyst promoters, 207
- Acetatofluoboric acid as catalyst, 171, 185, 197, 207-209, 213, 215-217
- Acetic acid, as promoter for boron trifluoride catalyst, 171, 185, 197, 207-209, 213, 215-217
compounds with boron trifluoride, 65, 146
- Acetic anhydride, as catalyst promoter, 207
compound with boron trifluoride, 71
- Acetonitrile, compound with boron trifluoride, 47-48
- Acetophenone oxime, compound with boron trifluoride, 46
- Acetoxyboron fluoride, 157
- Acetoxypyrylium fluoborate, 146
- Acetyl chloride, as boron trifluoride catalyst promoter, 212
compound with boron trifluoride, 65
- Acetylene, condensation with acid, 189
- Acetylenic alcohols, condensation with methanol, 191
- Acetyl fluoborate, 12, 65, 76, 82, 145-146, 239
use in analysis of boron trifluoride, 239
- Acetyl fluoride, compound with boron trifluoride, 13, 65, 76, 82, 145-146
- p*-Acetylphenyldiazonium fluoborate, 140
- Acid, condensation with alcohol, 189
dehydration with boron trifluoride, 195
formic, compound with boron trifluoride, 53
Lewis concept, 166
organic, compounds with boron trifluoride, 64
- Acid fluoride as promoter for boron trifluoride, 203, 208-209
- Acid-to-olefin condensation, 187
- Acylation, 198
- Alcohols, acetylenic, condensation with methanol, 191
aromatic, compounds with boron trifluoride, 62
butyl, compound with boron trifluoride, 62
compounds with boron trifluoride, 61
condensation, with acids, 189
with amides, 190
with nitriles, 190
dehydration by boron trifluoride, 195
ethyl, compound with boron trifluoride, 62
isopropyl, compound with boron trifluoride, 62
methyl, compound with boron trifluoride, 61
propyl, compound with boron trifluoride, 62
synthesis using boron trifluoride, 172

- Aldehydes, compounds with boron trifluoride, 61, 63
- Aldol condensation, 191
- Alkalies, reaction with boron trifluoride, 33
- Alkali metals, action on boron trifluoride, 1, 31
- Alkaline-earth metals, action of boron trifluoride, 31
- Alkaloid fluoborates, 136
- Alkylaluminum halides, action on boron trifluoride, 36
- Alkylating agents, mechanism, 198
- Alkylation, 198
- of alkyl esters, 202
 - of aromatic hydrocarbons, 203
 - of benzene with esters, 72-73
 - of paraffinic hydrocarbons, 200
 - of tertiary carbon atoms, conditions, 201
- Alkyl esters, alkylation of, 202
- Alkyl halides as promoters for boron trifluoride catalysts, 215
- Alumina, reaction with boron trifluoride, 34
- Aluminum, metal boron trifluoride complexes as fluxes for soft soldering, 44-45
- Aluminum bromide as promoter for boron trifluoride catalyst, 221
- Aluminum chloride, action on boron trifluoride, 32
- Aluminum fluoborate, 95, 113
- Aluminum fluoride from boron trifluoride, 32
- Aluminum oxide as promoter for boron trifluoride catalysis, 170, 215
- Aluminum silicate as promoter for boron trifluoride catalysis, 215
- Amides, compounds with boron trifluoride as soldering fluxes, 49
- condensation with an alcohol, 190
- Amines, complex, use in recovery of catalysts, 226
- Ammonia complexes with boron trifluoride, 43
- Ammonium fluoborate, 108-111
- preparation of boron trifluoride from, 7
- X-ray diagram, 160
- Amyl ether-boron trifluoride complex as catalyst, 70
- Analysis of boron trifluoride, and derivatives, 228-248
- spectrographic, 239
 - of triphenylfluoborate, 238
- Anhydrides, acid, compounds with boron trifluoride, 71
- Aniline, complex with boron trifluoride, 45
- dimethyl, compound with boron trifluoride, 45
 - methyl, compound with boron trifluoride, 45
 - monopotassium, compound with boron trifluoride, 46
 - monosodium, compound with boron trifluoride, 46
- Argon-boron trifluoride systems, 39
- Aromatic alcohols, compounds with boron trifluoride, 62
- Aromatic hydrocarbons, alkylation of, 203
- Arsine-boron trifluoride system, 52
- Arsenic derivatives, synthesis of, 138
- Aryl-boron compounds, preparation from boron trifluoride, 36
- Aryl-copper complexes, synthesis of, 138
- Aryldiazonium fluoborates as polymerization catalysts, 138
- Aryl halides as promoters for boron trifluoride catalysts, 215
- Association of boron trifluoride, 23, 31, 75
- Band spectrum of boron trifluoride, 46
- Barium fluoborate, 95, 97, 113
- Base, Lewis concept, 166
- Benzalaniline, as promoter for boron trifluoride catalyst, 46
- compound with boron trifluoride, 46
- Benzene, alkylation with esters by boron trifluoride, 72-73

- Benzene, nonreaction with boron trifluoride, 34
- Benzenediazonium fluoborate, 138
- Benzenesulfonic acid as promoter for boron trifluoride catalysis, 203-204
- Benzoatoffluoboric acid as catalyst, 171
- Benzoic acid, compound with boron trifluoride, 66
- Benzonitrile, compound with boron trifluoride, 47, 48
- Benzoylacetone, action of boron trifluoride, 35, 64
- Benzoyl peroxide as promoter for boron trifluoride catalyst, 217
- Benzylaldehyde, compound with boron trifluoride, 64
- Benzyl ethyl ether-boron trifluoride catalyst, 70
- Beryllium fluoborate, 95, 111
- Betaine, compound with boron trifluoride, 44
- Boiling point of boron trifluoride, 16, 18
- Bond, strength of boron trifluoride, 76
- Bond length, effect of coordination on, 82
- Boratofluoride of potassium, 153
- Boric acid, determination in fluoboric acid, 234
- Boric oxide, reaction, with boron trifluoride, 33
with silicon tetrafluoride, 33
- Boron, 1
- Boron acetylacetone difluoride, 35
- Boron alkyls, 35-38
- Boron chlorofluorides, attempts to prepare, 10
- Boron compounds, interatomic distances, 37
- Boron dibenzoylmethane difluoride, 35
- Boron-fluorine bond strength, 76
- Boron methyl salicylate difluoride, 35
- Boron oxyfluoride, 33, 56
- Boron *p*-tolyl difluoride, 38
- Boron tri-*p*-anisyl from boron trifluoride, 38
- Boron tribenzyl from boron trifluoride, 38
- Boron tribromide from potassium fluoborate, 32
- Boron trichloride, action on boron trifluoride, 32
prepared from boron trifluoride, 32
- Boron triethyl from boron trifluoride, 32
- Boron triethylimine, 36
- Boron trifluoride, as a catalyst, 166-225
as an electron acceptor, 39
commercial production, 8, 13
complexes, manufacture of, 14
counters for slow neutrons, 9, 28
detection of, 228-230
dihydrate, 6, 53, 58, 155, 158-163, 227
impurities in, 239
monohydrate, 54, 58
practical handling, 249-255
purification, 11
silica-free, 5, 10
trihydrate, 6, 54
toxicity, 249-250
- Boron trimethyl from boron trifluoride, 36
- Boron tri- α -naphthyl from boron trifluoride, 38
- Boron triphenyl from boron trifluoride, 36, 38
- Boron tritertiary butyl from boron trifluoride, 38
- Boron tri-*p*-xylyl from boron trifluoride, 38
- Brucine, complex with boron trifluoride, 45
- Brucine fluoborate, 137
- Burns, boron trifluoride, 249
- Butenes, complex with boron trifluoride, 43
- Butyl alcohol, compound with boron trifluoride, 62
- Butylene, polymerization by boron trifluoride, 210

- Butyl ether-boron trifluoride as a catalyst, 224
 in synthesis of ethers, 69
n-Butyric acid, compound with boron trifluoride, 65
n-Butyric anhydride, compound with boron trifluoride, 72
- Cadmium fluoborate, 128-129
 Calcium fluoborate, 95-112
 Calcium fluoride, compound with boron trifluoride, 76
 Calcium oxide, reaction with boron trifluoride, 34
 Camphor, compound with boron trifluoride, 64
 Carbethoxybenzenediazonium fluoborate, 139
 Carbon compounds, coordination with boron trifluoride, 42
 Carbon monoxide, action of boron trifluoride, 32, 43
 addition catalyzed by boron trifluoride, 182
 Carboxonium fluoborates, 76, 82, 145-146
 Carboxyphenyldiazonium fluoborate, 140
 Catalyst, boron trifluoride, recovery of, 225-227
 boron trifluoride-water, separation, 226
 Cesium fluoborate, 97, 107
 Cetyl alcohol, compound with boron trifluoride, 62
 Chloracetatofluoboric acid as catalyst, 171
 Chloracetic anhydride, compound with boron trifluoride, 72
 Chloral, as boron trifluoride catalyst promoter, 212
 compound with boron trifluoride, 64
 β -Chlorethyl ester of boric acid, compound with boron trifluoride, 70
 Chlorides, compounds with boron trifluoride, 78
- Chlorophenyldiazonium fluoborate, 140
 Chromium, action on boron trifluoride, 31
 Chromium fluoborate, 114
 Chromium oxide as promoter for boron trifluoride catalyst, 170
Cis-trans isomer equilibrium, 42
 Cobalt fluoborate, 117-119
 Cobalt fluoride, compounds with boron trifluoride, 76
 Cobalt oxides as promoters for boron trifluoride catalyst, 170
 Cocaine fluoborate, 136
 Coefficient, of compressibility of gaseous boron trifluoride, 21
 of thermal expansion, of liquid boron trifluoride, 19
 of solid boron trifluoride, 19
 Condensation, acid to acetylene, 189
 acid to olefin, 187
 aldol, 191
 of acetylenic alcohols with methanol, 191
 of alcohol with acid, 189
 of amide with alcohol, 190
 of nitrile with alcohol, 190
 Coordination, and resonance, 86
 base strength of ethers, 83
 compounds, dipole moment of, 82
 stability above freezing point, 41
 with boron trifluoride stability, 84
 effect, of polar group, 66
 on bond length, 82
 energy of, 82
 favored by ionic character, 83
 generalizations, 81
 power of boron trifluoride, 39
 steric hindrance, 83
 Copper, action on boron trifluoride, 32
 Copper fluoborate, 122-124
 Cracking processes, 194
 Critical constants of system argon-boron trifluoride, 21
 Critical potentials of gaseous boron trifluoride, 27

- Critical pressure of boron trifluoride, 21
- Critical temperature of boron trifluoride, 21
- Crotonic acid, compound with boron trifluoride, 66
- Cyanuric chloride, polymerization by boron trifluoride, 220
- Cyclic oxides, polymerization by boron trifluoride, 219-220
- Decompositions, 194
- Dehydration, catalyzed by boron trifluoride, 195
- of acids, 195
- of alcohols, 195
- of ketones, 195
- Density, of gaseous boron trifluoride, 20
- of liquid boron trifluoride, 18
- of solid boron trifluoride, 18
- Diacetic anhydride, compound with boron trifluoride, 72
- Diazonium fluoborates, 137
- tables, 142-145
- thermal decomposition of, 9
- Diazonium reaction, 137-138
- Dibenzoylmethane, action on boron trifluoride, 35
- Dibenzyl ether-boron trifluoride as catalyst, 70
- Dichloroacetic acid, compound with boron trifluoride, 72-74
- Diethyl oxalate, compound with boron trifluoride, 72-74
- Diethyloxyethylsulfonium fluoborate, 148
- Dihydroxyfluoboric acid, 54, 154-158
- as catalyst, 157, 168, 187, 190, 203-204, 206
- preparation of boron trifluoride from, 7
- Diisopropyl ether-boron trifluoride as catalyst, 70
- β -Diketones, reaction with boron trifluoride, 34, 64
- Dimethylaniline, complex with boron trifluoride, 45
- Dimethyl boric anhydride, action on boron trifluoride, 36
- Dimethyl boron fluoride, 36-37
- action on zinc methyl, 36
- molecular structure, 36-37
- Diphenyl boron fluoride, 38
- Diphenyldiazonium fluoborates, 142
- Dipole moment, of boron trifluoride, 26
- of coordination compounds, 82
- Discovery of boron trifluoride, 1
- Dispersion of boron trifluoride, 26
- Dolomite, reaction with boron trifluoride, 33
- Donor atoms, electronic character, 85
- known, 84
- Elements, action on boron trifluoride, 31
- Energy of coordination with boron trifluoride, 82
- Entropy of boron trifluoride, 24
- Ester-boron trifluoride complexes as soldering fluxes, 73
- Esterification catalyzed by boron trifluoride, 185
- Esters, compounds with boron trifluoride, 72-74
- from ethers, 191-192
- Ethanolamine, complexes with boron trifluoride, 44
- Ethers, compounds with boron trifluoride, 68
- synthesis catalyzed by boron trifluoride, 176-182
- α -Ethoxybenzopyrilium fluoborate, 148
- γ -Ethoxy- α, α' -dimethylpyrilium fluoborate, 148
- p -Ethoxyphenyldiazonium fluoborate, 140
- Ethyl acetate, compound with boron trifluoride, 72, 74
- Ethyl alcohol, compound with boron trifluoride, 62
- monochlor, compound with boron trifluoride, 62

- Ethyl alcohol, trichlor, compound with boron trifluoride, 62
- Ethyl alcohol-boron trifluoride complex as catalyst, 185, 208-209, 213, 215-217
- Ethyl chloroacetate, compound with boron trifluoride, 72, 74
- Ethylene, polymerization by boron trifluoride, 207-209
 reaction with boron trifluoride, 42
- Ethyl ether, compound with boron trifluoride, 69, 146
- Ethyl ether-boron trifluoride, complex as a catalyst, 70, 187-188, 196, 207, 213, 215-216, 222-224
 with HgO as promoter, 173, 176-177, 181
- Ethyl formate, compound with boron trifluoride, 72, 74
- Ethylloxonium fluoborate, 147
- Ethyl propionate, compound with boron trifluoride, 72, 74
- Ethylpyridinium fluoborate, 148
- Ethyl trichloroacetate, compound with boron trifluoride, 72, 74
- Feldspar, reaction with boron trifluoride, 34
- Ferrous fluoride, compounds with boron trifluoride, 76
- Fluoborates, 75-76, 95
 acetoxypyridium, 146
p-acetylphenyldiazonium, 140
 alkali, solubilities, 105
 alkaloid, 136
 aluminum, 95, 113
 ammonium, 108-111
 use in preparation of boron trifluoride, 7
 analysis using nitron, 238
 as soldering flux, 97
 barium, 95, 97, 113
 benzenediazonium, 138
 beryllium, 95, 111
 brucine, 137
 cadmium, 128-129
 calcium, 95, 112
- Fluoborates, *p*-carbethoxybenzenediazonium, 139
 carboxonium, 76, 82, 145-146
 carboxyphenyldiazonium, 140
 cesium, 97, 107
 thermal dissociation, 108
o- and *p*-chlorophenyldiazonium, 140
 chromium, 114
 cobalt, 117-119
 cocaine, 136
 copper, 122-124
 decomposition with lime water, 228
 diazonium, 137
 tabulated, 142-145
 thermal decomposition, 9
 diethyloxyethylsulfonium, 148
 diphenyldiazonium, 142
 α -ethoxybenzopyrilium, 148
 γ -ethoxy- α,α' -dimethylpyrilium, 148
p-ethoxyphenyldiazonium, 140
 ethylloxonium, 147
 ethylpyridinium, 148
 2-fluoro-5-carbethoxybenzenediazonium, 141
o-fluorophenyldiazonium, 139
p-fluorophenyldiazonium, 139
 hydrazinium, 134
 hydroxyphenyldiazonium, 140
 2-hydroxy-5-sulfophenyldiazonium, 140
 indium, 130
 ion, similarity to perchlorate ion, 91, 98
 iron, 116
 isomorphism, as test, 228
 lead, 132-133
 lithium, 33, 97
 thermal dissociation, 98
 magnesium, 95, 111
 manganese, 115
 mercuric methoxy-, 61
 mercury, 129-130
 monohydroxyhydronium, 53, 55
 morphine, 137
 naphthalenediazonium, 141
 neurine, 135

- Fluoborates, nickel, 120-122
 nitron, 136
 test for, 229, 238
 nitrophenyldiazonium, 140
 nitrosyl, 76, 82, 133-134, 138, 145
 organic, 134
m-phenylenebis(diazonium fluoborate), 139
 preparation, 95
 of boron trifluoride by thermal dissociation of, 104
 potassium, 95-97, 99-106
 thermal dissociation, 103, 106-107
 use in preparation of boron trifluoride, 7
 properties, 96
 pyridinium, 135
 pyridiniumoxonium, 150
 quantitative determination, 238
 recovery of boron trifluoride catalyst as, 227
 rubidium, 97
 thermal dissociation, 107
 silver, 124-126
 sodium, 95, 97-99, 145, 148
 use in preparation of boron trifluoride, 7
 stannous, 131-132
 strontium, 95, 112
 strychnine, 137
p-sulfophenyldiazonium, 140
 summary, 165
 tertiary oxonium, 147
 tetra-*n*-butylammonium, 135
 tetraethylammonium, 135
 tetramethylammonium, 135
 thallos, 130-131
 thermal decomposition, 8, 9
 toluenediazonium, 141
p-tolylphenyldiazonium, 141
 triethylsulfonium, 148
 trimethyloxonium, 149
 triphenylmethane, 146
 triphenyl, tetra-alkylammonium, 150
 tetra-*n*-butylammonium, 151
 tetramethylammonium, 152-153
- Fluoborates, tripropyloxonium, 150
 turmeric test, 229
 xylenediazonium, 141
 yttrium, 95, 114
 zinc, 126-128
 zirconium, 95
- Fluoborax, 8, 14, 164
- Fluoboric acid, 75, 87
 change in composition with age, 232
 commercial, analysis of, 232-238
 impurities in, 232
 conductimetric titration, 92
 gas, 2, 4
 heat of formation, 90, 91
 history, 87
 hydrolysis, 88, 92, 93, 230-232
 hydronium monohydroxy-, 93, 98
 pH titration, 232
 physical properties of, 90
 preparation, 88-90, 101
 quantitative analysis of, 230-232
 reaction with potassium fluoride, 101
 titration reactions, 235
 titration using indicators, 230-232
 uses, 94, 97
 in electroplating, 94, 95
- Fluoperborate, ammonium, 154
 potassium, monohydrate, 163
- Fluoperboric acid, 163
- Fluoride ion, coordination with boron trifluoride, 75
- 2-Fluoro-5-carbethoxybenzenediazonium fluoborate, 141
- Fluorophenyldiazonium fluoborate, 139
- Fluosilicic acid, determination in fluoboric acid, 233-234
- "Fluoxyboric" acid, 54
- Fluosulfonic acid as promoter for boron trifluoride catalyst, 171, 203, 208, 222
- Formic acid, compound with boron trifluoride, 53, 65
- Glass, reaction with boron trifluoride, 34

- Glycol, compound with boron trifluoride, 62
- Grignard reagent, action, on boron trifluoride, 35-38
on boron trifluoride etherate, 35
- Haloformed rubber, 221
- Halogenation, catalytic, 198
- Heat, of formation of boron trifluoride, 24
of fusion of boron trifluoride, 22
of solution of boron trifluoride, 28
of transition of boron trifluoride, 22
of vaporization of boron trifluoride, 23
- Heat capacity of boron trifluoride, 24
- Hexamethylenetetramine, complex with boron trifluoride, 45
- History of boron trifluoride, 1
- Hydration catalyzed by boron trifluoride, 194
- Hydrazinium fluoborate, 134
"Hydroboric fluoride," 75
- Hydrocarbons, saturated, synthesis of, 171
- Hydrofluoric acid, determination in fluoboric acid, 234
- Hydrogen, action on boron trifluoride, 32
- Hydrogenation, 196
- Hydrogen bromide, system with boron trifluoride, 80
- Hydrogen chloride, promoter for boron trifluoride catalyst, 172, 176, 196, 215, 220
system with boron trifluoride, 78
- Hydrogen cyanide, compound with boron trifluoride, 12, 47-48
- Hydrogen fluoride, as promoter for boron trifluoride catalyst, 167, 171, 176, 183, 187, 201, 203, 209, 211-212, 214-216, 221-222, 224
compounds with boron trifluoride, 75
- Hydrogen iodide as boron trifluoride catalyst promoter, 208
- Hydrogen sulfide-boron trifluoride system, 58
- Hydronium monohydroxyfluoboric acid, 53, 58, 93, 98, 158-163
- Hydropolymerization of olefins, 217
- Hydroxyphenyldiazonium fluoborate, 140
- 2-Hydroxy-5-sulfophenyldiazonium fluoborate, 140
- Indium fluoborate, 130
- Infrared-absorption spectra, boron trifluoride, 26
- Interatomic distances, boron compounds, 37
- Iron, action on boron trifluoride, 31
- Iron fluoborate, 116
- Iron oxides as promoters for boron trifluoride catalyst, 170
- Isoamyl borine, 35
- Isoamyl ether-boron trifluoride as catalyst, 70
- Isobutene, complex with boron trifluoride, 43
- Isobutyl borine, 35
- Isobutylene, polymerization by boron trifluoride, 210
- Isobutyric acid, compound with boron trifluoride, 65
- Isobutyric anhydride, compound with boron trifluoride, 72
- Isomerization catalyzed by boron trifluoride, 221-225
- Isopropyl alcohol, compound with boron trifluoride, 62
- Isopropyl phenyl ether-boron trifluoride as catalyst, 70
- Kaolin, reaction with boron trifluoride, 34
- Ketones, compounds with boron trifluoride, 61, 64
dehydration with boron trifluoride, 195
from aliphatic acid anhydrides, 174
synthesis catalyzed by boron trifluoride, 173

- Keto steroids from acetic anhydride, 175
- Ketoxime, *p*-tolyl phenyl, compound with boron trifluoride, 47
- Lactatofluoboric acid as catalyst, 171
- Lead fluoborate, 132-133
- Lead oxide, red, action of boron trifluoride on, 32
- Lime, action of boron trifluoride, 33-35
- Lithium carbonate, reaction with boron trifluoride, 33
- Lithium fluoborate, 33, 97
thermal dissociation, 98
- Lithium metal in ethylimine, action on boron trifluoride, 36
- Low-pressure phenomena of boron trifluoride, 27
- Lubricant, stopcock, for boron trifluoride, 255
- α, α' -Lutidine compound with boron trifluoride, 47
- Magnesium, action on boron trifluoride, 31
- Magnesium fluoborate, 95, 111
- Magnesium oxide, reaction with boron trifluoride, 33
- Maleic acid, compound with boron trifluoride, 66
- Manganese fluoborate, 115
- Manganese oxide as promoter for boron trifluoride catalyst, 170
- Melting point of boron trifluoride, 16
- Mercaptan, compounds with boron trifluoride, 74
- Mercuric acetate as promoter for boron trifluoride catalyst, 189
- Mercuric dihydroxyfluoborate as catalyst, 170
- Mercuric methoxyfluoborate, 61
- Mercuric oxide as promoter for boron trifluoride catalyst, 170, 181, 194, 207, 222
- Mercury, action on boron trifluoride, 31, 254
- Mercury fluoborate, 129-130
- Metals as promoters for boron trifluoride catalyst, 170, 201, 208-211, 215, 221
- Metaphosphoric acid, reaction with boron trifluoride, 12
- Methane, nonreaction with boron trifluoride, 34
- Methanol, condensation with acetylenic alcohols, 191
- Methylacetanilide, compound with boron trifluoride, 45
- Methyl acetate, compound with boron trifluoride, 72, 74
- Methyl alcohol, compound with boron trifluoride, 61
- Methyl alcohol-boron trifluoride complex as catalyst, 178, 181, 185
- Methylamine, complexes with boron trifluoride, 44
- Methyl amyl ether, compound with boron trifluoride, 69
- Methyl aniline, complex with boron trifluoride, 69
- Methyl anthranilate, compound with boron trifluoride, 46
- Methyl benzoate, compound with boron trifluoride, 72, 74
- Methyl boric anhydride, action on boron trifluoride, 36
- Methyl boron difluoride, 36-37
action on zinc methyl, 36
molecular structure, 36-37
- Methyl chloride, system with boron trifluoride, 78
- Methyl ether-boron trifluoride complex, 68, 170
- Methyl ethyl ether, compound with boron trifluoride, 69
- Methyl formate, compound with boron trifluoride, 72, 74
- Methyl glycolate, compound with boron trifluoride, 72, 74
- Methyl salicylate, reaction with boron trifluoride, 35
- Molecular structure of boron trifluoride, 24
- Molecular volume, of liquid boron trifluoride, 18

- Molecular volume, of solid boron trifluoride, 18
- Monoamines, compounds with boron trifluoride as soldering fluxes, 49
- Monochloroacetic acid, compound with boron trifluoride, 65
- Monochlorethyl alcohol, compound with boron trifluoride, 62
- Monochlorotrifluoromethane, system with boron trifluoride, 76-77
- Monohydroxyfluoborate, potassium, 55, 152, 162
sodium, 98
- Monohydroxyfluoboric acid, 89
compound with dioxane, 157
- Morphine fluoborate, 137
- Naphthalenediazonium fluoborates, 141
- Neurine fluoborate, 135
- Nickel fluoborate, 120-122
- Nickel fluoride, compound with boron trifluoride, 76
- Nickel oxide as promoter for boron trifluoride catalyst, 170
- Nieuwland's catalyst, 173, 176-177, 181
- Nitration using boron trifluoride as catalyst, 196
- Nitric acid, compound with boron trifluoride, 56, 196
- Nitric oxide, compound with boron trifluoride, 56
- Nitrile, condensation with an alcohol, 190
- Nitrogen compounds, synthesis catalyzed by boron trifluoride, 184
- Nitrogen dioxide, compound with boron trifluoride, 56
- Nitron test for fluoborates, 229, 238
- Nitrophenyldiazonium fluoborate, 140
- Nitrosyl fluoborate, 76, 82, 133-134, 138, 145
- Nitrous oxide-boron trifluoride system, 49
- Nonyl ketone, compound with boron trifluoride, 64
- Oil, fatty, polymerization by boron trifluoride, 220
- Oleatofluoboric acid as catalyst, 171
- Olefins, hypopolymerization of, 217
polymerization of, 214
synthesis using boron trifluoride, 172
- Olefin-to-acid condensation, 187
- Oligoclase, reaction with boron trifluoride, 34
- Organic acids, compounds with boron trifluoride, 64
- Organic compounds, reaction with boron trifluoride, 34
- Organic sulfur, compounds with boron trifluoride, 74
- Organoboron compounds from boron trifluoride, 35-38
- Organomercurials, synthesis of, 138, 140
- Organometallic compounds, action on boron trifluoride, 35-38
synthesis of, 138
- Orthofluoborate, potassium, 152
- Orthophosphoric acid, compound with boron trifluoride, 57
- Oxalic acid, compound with boron trifluoride, 66
- Oxidation using boron trifluoride as catalyst, 197
- Oxides, action on boron trifluoride, 32
of Groups VI and VII metals as boron trifluoride catalyst promoters, 217
of metals, compounds with boron trifluoride, 55
- Oxime, acetophenone, compound with boron trifluoride, 46
- Parachor of boron trifluoride, 19
- Paraffinic hydrocarbons, alkylation of, 200
- Phenol, compounds with boron trifluoride, 62
- Phenylacetic acid, compound with boron trifluoride, 66
- Phenylacetic anhydride, compound with boron trifluoride, 72

- Phenyl acetonitrile, compound with boron trifluoride, 47-48
- Phenyl boron difluoride, 38
- Phenylenebisdiazonium fluoborate, 139
- Phenyl ester of boric acid, compound with boron trifluoride, 70
- Phenyl magnesium bromide, action of boron trifluoride on, 36
- Phosphates, compounds with boron trifluoride, 57
- Phosphine as boron trifluoride catalyst promoter, 212
- Phosphine-boron trifluoride system, 50
- Phosphoric acid as promoter for boron trifluoride catalyst, 168, 204
- Phosphorus pentoxide as promoter for boron trifluoride catalyst, 204, 207, 222
- Phosphorus trifluoride-boron trifluoride system, 51
- Phosphoryl chloride, compound with boron trifluoride, 58
- Phosphoryl fluoride-boron trifluoride system, 58
- Physical properties of boron trifluoride, 16
- Piperidine, compound with boron trifluoride, 47-48
- Polar group in compound, effect on coordination with boron trifluoride, 66
- Polyisobutylenes, 210-214, 250, 255 uses, 214
- Polymerization, by aryldiazonium fluoborates as catalysts, 138
- by boron trifluoride, 207
 - of butylene by boron trifluoride, 210
 - of cyanuric chloride by boron trifluoride, 220
 - of cyclic oxides by boron trifluoride, 219-220
 - of dienes, 217
 - of ethylene by boron trifluoride, 207-209
- Polymerization, of fatty oils by boron trifluoride, 220
- of isobutylene by boron trifluoride, 210
 - of miscellaneous olefins, 214
 - of propylene by boron trifluoride, 209-210
 - of terpenes by boron trifluoride, 218-219
 - of unsaturated compounds by boron trifluoride, 220-221
 - of vinyl compounds by boron trifluoride, 216
- Positive-ray analysis of boron trifluoride, 28
- Potassium carbonate, reaction with boron trifluoride, 33
- Potassium fluoborate, 95, 97, 99-106
- action on $AlBr_3$, 32
 - isomorphism, 103
 - thermal dissociation, 103, 106, 107
 - use in preparation of boron trifluoride, 7
- Potassium hydroxide, compound with boron trifluoride, 55
- Potassium metaborate, reaction with boron trifluoride, 33
- Potassium monohydroxyfluoborate, 55
- Potassium nitrate, reaction with boron trifluoride, 33
- Potentials, critical, of gaseous boron trifluoride, 27
- Promoters for boron trifluoride catalyst, 167-171
- acetates, 207
 - acetic acid, 171, 185, 197, 207-209, 213, 215-217
 - acetic anhydride, 207
 - acid fluoride, 203, 208-209
 - acetyl chloride, 212
 - alkyl halides, 215
 - aluminum bromide, 221
 - aluminum oxide, 170, 215
 - aluminum silicate, 215
 - amyl ether, 70
 - aryl halides, 215
 - benzalaniline, 46

- Promoters for boron trifluoride catalyst, benzenesulfonic acid, 203-204
- benzoic acid, 171
 - benzoyl peroxide, 217
 - benzyl ethyl ether, 70
 - n*-butyl ether, 69, 224
 - chloroacetic acid, 171
 - chloral, 212
 - chromium oxide, 170
 - cobalt oxides, 170
 - dibenzyl ether, 70
 - diisopropyl ether, 70
 - ethyl alcohol, 185, 208-209, 213, 215-217
 - ethyl ether, 70, 187-188, 196, 207, 213, 215-216, 222-224
 - with mercuric oxide, 173, 176-177, 181
 - fluosulfonic acid, 171, 203, 208, 222
 - hydrogen chloride, 172, 176, 196, 215, 220
 - hydrogen fluoride, 167, 171, 176, 183, 187, 201, 203, 209, 211-212, 214-216, 221-222, 224
 - hydrogen iodide, 208
 - iron oxides, 170
 - isoamyl ether, 70
 - isopropyl phenyl ether, 70
 - lactic acid, 171
 - manganese oxide, 170
 - mercuric acetate, 189
 - mercuric oxide, 170, 181, 194, 207, 222
 - metals, 170, 201, 208-211, 215, 221
 - methyl alcohol, 178, 181, 185
 - nickel oxide, 170
 - oleic acid, 171
 - oxides of Group VI and VII metals, 217
 - phosphoric acid, 168, 204
 - phosphorus pentoxide, 204, 207, 222
 - pyrophosphoric acid, 171
 - silicon dioxide, 170, 215
 - succinic anhydride, 212
 - sulfides, 217
 - sulfuric acid, 167-168, 176, 203-204, 209
- Promoters for boron trifluoride catalyst, sulfur trioxide, 222
- titanium dioxide, 170, 215
 - vanadium oxide, 170, 215
 - water, 53, 167, 170, 183, 187, 197, 203, 207-208, 210-211, 215-217, 221
 - zirconium oxide, 170
- Propionic acid, compound with boron trifluoride, 65
- Propionic anhydride, compound with boron trifluoride, 72
- n*-Propyl acetate, compound with boron trifluoride, 73-74
- n*-Propyl alcohol, compound with boron trifluoride, 62
- n*-Propyl borine, 35
- Propylene, polymerization with boron trifluoride, 209-210
 - reaction with boron trifluoride, 42
- n*-Propyl ether, compound with boron trifluoride, 69
- n*-Propyl formate, compound with boron trifluoride, 72, 74
- Pyridine, compound with boron trifluoride, 47, 48
- Pyridinium fluoborate, 135
- Pyridiniumoxonium fluoborate, 150
- Pyrophosphates, compounds with boron trifluoride, 57
- Pyrophosphoric acid, as promoter for boron trifluoride catalyst, 171
 - compound with boron trifluoride, 57
- Quinoline, compound with boron trifluoride, 47-48
- Rearrangement of steroids by boron trifluoride, 225
- Recovery of boron trifluoride catalysts, 225-227
- Reduction catalyzed by boron trifluoride, 197
- Refractive index of boron trifluoride, 26
- Retrograde immiscibility of system argon-boron trifluoride, 21, 41

- Ring closure catalyzed by boron trifluoride, 172
- Rubidium fluoborate, 97
- Salicylic acid, compound with boron trifluoride, 66
- Scattering of slow neutrons in boron trifluoride, 28
- Silicon dioxide as promoter for boron trifluoride catalyst, 170, 215
- Silicon tetrafluoride, in boron trifluoride, 4
removal from boron trifluoride by fused boric acid, 33
- Silver fluoborate, 124-126
- Sodium chloride, compound with boron trifluoride, 79
- Sodium fluoborate, 95, 97-99, 145, 148
- Sodium fluoride, reaction of boron trifluoride-etherate with, 248
- Sodium hydroxide, compound with boron trifluoride, 55
- Sodium methylate, compound with boron trifluoride, 55
- Sodium monohydroxyfluoborate, 98
- Soldering flux, 44-45, 49, 66, 73
- Solders, organic acid-boron trifluoride compounds, 66
- Solubility of boron trifluoride, 28
- Spark, action on boron trifluoride, 28, 31
in presence of hydrogen, 32
- Stability, thermal, of boron trifluoride, 31
- Stannous fluoborate, 131-132
- Steroids, keto, from acetic anhydride, 175
rearrangement by boron trifluoride, 225
- Stilbene, 42
- Strontium fluoborate, 95, 112
- Strychnine fluoborate, 137
- Succinic acid, compound with boron trifluoride, 66
- Succinic anhydride, as boron trifluoride catalyst promoter, 212
compound with boron trifluoride, 72
- Sulfates, compounds with boron trifluoride, 56
- Sulfides as boron trifluoride catalyst promoters, 217
- Sulfonation catalyzed by boron trifluoride, 197
- Sulfophenyldiazonium fluoborate, 140
- Sulfur compounds, synthesis catalyzed by boron trifluoride, 185
- Sulfur dioxide-boron trifluoride system, 58
- Sulfuric acid, as promoter for boron trifluoride catalyst, 167-168, 176, 203-204, 209
compound with boron trifluoride, 56
determination in fluoboric acid, 233
- Sulfur trioxide as boron trifluoride catalyst promoter, 222
- Sulfuryl chloride, compound with boron trifluoride, 56
- Surface tension of liquid boron trifluoride, 19
- Terpenes, polymerization by boron trifluoride, 218-219
- Tertiary butyl boron fluoride, 43
- Tertiary oxonium fluoborates, 147
- Tetra-*n*-butylammonium fluoborates, 135
- Tetraethylammonium fluoborate, 135
- Tetrafluoromethane, system with boron trifluoride, 76-77
- Tetrahydrofuran, compound with boron trifluoride, 70
- Tetramethylammonium fluoborate, 135
- Thallos fluoborate, 130-131
- Thionyl fluoride-boron trifluoride system, 60
- Thiophosphoryl fluoride-boron trifluoride system, 61
- Tin fluoborate, 131-132
- Titania, reaction with boron trifluoride, 34
- Titanium dioxide as promoter for boron trifluoride catalyst, 170, 215

- Toluenediazonium fluoborates, 141
- p*-Toluidine, compound with boron trifluoride, 45
- p*-Tolyl acetate, compound with boron trifluoride, 73-74
- p*-Tolyl boron difluoride, 38
- p*-Tolyldiazonium fluoborate, 141
- p*-Tolyl phenyl ketoxime, compound with boron trifluoride, 73-74
- Toxicity, boron trifluoride, 249-250
- Tributylborine, preparation from boron trifluoride, 35
- Trichloroacetic acid, compound with boron trifluoride, 65
- Trichlorethyl alcohol, compound with boron trifluoride, 62
- Triethylamine, complexes with boron trifluoride, 44
- Triethylsulfonium fluoborate, 148
- Trimethylacetaldehyde, compounds with boron trifluoride, 64
- Trimethylamine, compound with boron trifluoride, 44, 48
- Trimethylamine oxide, compound with boron trifluoride, 74
- Triphenyl fluoborate, analysis of, 238
- tetra-alkylammonium, 152
- tetra-*n*-butylammonium, 151
- tetramethylammonium, 152-153
- Triphenylmethane fluoborate, 146
- Tripropyloxonium fluoborate, 150
- Unsaturated compounds, polymerization by boron trifluoride, 220-221
- Valves for boron trifluoride, 251-254
- Vanadium oxide as promoter for boron trifluoride catalyst, 170, 215
- Vapor pressure of boron trifluoride, 16
- Vinyl compounds, polymerization by boron trifluoride, 216
- Vistanex, 250, 255
- Water, as promoter for boron trifluoride catalyst, 53, 167, 170, 183, 187, 197, 203, 207-208, 210-211, 215-217, 221
- compounds with boron trifluoride, 53-54, 58
- X-ray diagram of ammonium fluoborate and boron trifluoride dihydrate, 160
- Xylenediazonium fluoborates, 141
- Yttrium fluoborate, 95, 114
- Zero group, compounds of boron trifluoride with, 39
- Zinc fluoborate, 126-128
- Zinc methyl, action on boron trifluoride, 36
- Zirconium fluoborate, 95
- Zirconium oxide as promoter for boron trifluoride catalyst, 170

Formula Index

The arrangement of the symbols in the formulas is alphabetical except for carbon-containing compounds. In these compounds, C is listed first, followed immediately by H, if hydrogen is present. Symbols for other elements present in carbon-containing compounds then follow in alphabetical order.

The formulas are listed in alphabetical order except that the number of atoms of any specific kind influences the order of compounds. For example, all compounds containing one boron atom, B, are listed before any compounds containing two boron atoms, B₂.

Hydrated compounds have been listed using both the hydrated and the anhydrous formulas. For example, ferrous fluoborate occurs as a hexahydrate, [Fe(H₂O)₆](BF₄)₂. This compound is indexed as B₂F₈Fe and as B₂F₈FeH₁₂O₆.

- | | |
|---|---|
| <p>ABF₃, 40
 AB₂F₆, 40
 AB₃F₉, 40
 AB₆F₁₈, 25, 40, 41
 AB₈F₂₄, 25, 40, 41
 AB₁₆F₄₈, 25, 40, 75
 Ag, 94, 125
 AgBF₄, 124, 125
 AgBF₄H₂O, 124, 125
 AgBF₄H₆N₂, 125, 126
 AgF, 10
 Ag₂BF₆H₁₁O₅, 125
 AlB₃F₁₂, 113, 114
 AlBr₃, 32
 AlCl₃, 32, 206
 AlF₃, 2, 32
 AlF₆Na₃, 5, 6, 94
 AlKO₈Si₃, 34
 Al₂O₃, 34
 AsH₃, 43, 52</p> <p>B, 10, 19, 21, 91
 BBr₃, 10, 105
 BCaF₅, 9, 76
 BCa₂F₇, 76
 BCl₃, 10, 32, 105
 BCl₃F₃H₃, 78</p> | <p>BCoF₅, 76
 BCsF₄, 9, 76, 97, 106, 107, 108, 227
 BFH₂O₂, 152
 BFH₄O₃, 92
 BFK₂O₂, 152, 164
 BF₂H₃O₂, 7, 54, 92, 139, 154-158, 159,
 170, 181, 187, 189, 190, 203, 204,
 205, 206, 230, 232
 BF₃HKO, 55, 92, 152, 162, 163
 BF₃HK₃O₂, 162
 BF₃HNO₃, 196
 BF₃HNaO, 55, 98, 99, 163
 BF₃HNa₃O₂, 162
 BF₃H₂O, 54, 83, 88, 89, 91, 92, 93,
 104, 112, 161, 162, 163, 167, 170,
 183, 185, 186, 187, 196, 197, 199,
 201, 203, 207, 208, 209, 211, 215,
 226, 227, 230, 232
 BF₃H₂O₄S, 167, 168
 BF₃H₂S, 58
 BF₃H₃N, 43, 44, 119, 121, 127, 129,
 184, 187, 228
 BF₃H₃O₄P, 57, 168, 171, 183, 201,
 204, 207
 BF₃H₃P, 50, 51, 83
 BF₃H₄O₂, 6, 53, 93, 112, 155, 158-163,
 167, 170, 178, 183, 185, 187, 192,</p> |
|---|---|

- 196, 197, 203, 207, 208, 209, 210,
 211, 215, 216, 227
 $\text{BF}_3\text{H}_4\text{O}_3$, 163
 $\text{BF}_3\text{H}_4\text{O}_7\text{P}_2$, 201
 $\text{BF}_3\text{H}_6\text{N}_2$, 43, 44
 $\text{BF}_3\text{H}_6\text{O}_3$, 6, 54, 87, 112, 170, 183, 185,
 207
 $\text{BF}_3\text{H}_8\text{K}_4\text{O}_6$, 162
 $\text{BF}_3\text{H}_8\text{Na}_4\text{O}_6$, 162
 $\text{BF}_3\text{H}_9\text{N}_3$, 43, 44, 114
 $\text{BF}_3\text{K}_2\text{O}_4\text{S}$, 56
 $\text{BF}_3\text{K}_4\text{O}_2$, 162
 BF_3NO , 56, 57
 $\text{BF}_3\text{Na}_2\text{O}_4\text{S}$, 56
 $\text{BF}_3\text{Na}_4\text{O}_2$, 162
 $\text{BF}_3\text{O}_2\text{S}$, 58
 $\text{BF}_3\text{O}_4\text{STl}_2$, 56
 BF_4H , 75, 87–95, 99–101, 158, 171,
 230–238, 244
 $\text{BF}_4\text{H}_2\text{OTl}$, 131
 $\text{BF}_4\text{H}_4\text{N}$, 7, 44, 90, 108–111, 119, 125,
 134, 160, 161, 229
 $\text{BF}_4\text{H}_5\text{N}_2$, 134
 BF_4K , 7, 9, 32, 75, 92, 96, 97, 99–106,
 107, 145, 151, 227, 229, 230, 233,
 234, 235, 238, 245
 BF_4Li , 75, 97, 98
 BF_4NO , 76, 82, 86, 133, 134, 138, 139,
 145
 BF_4Na , 7, 9, 75, 83, 96, 97, 98, 99,
 145, 147, 228, 230, 231, 237, 244,
 248
 BF_4Rb , 9, 75, 97, 227
 BF_4Tl , 130, 131
 BF_5Fe , 76
 BF_5H_2 , 75, 151, 167
 $\text{BF}_5\text{H}_3\text{HgO}$, 129, 130
 BF_5K_2 , 100, 101, 151
 BF_5Ni , 76
 BF_5OS , 61
 BF_6H_3 , 75
 BF_6OP , 58
 BFe , 11
 BH_3O_3 , 1, 2, 4, 6, 8, 13, 14, 88, 89, 91,
 92, 93, 94, 95, 98, 100, 101, 232,
 234, 235, 236, 237, 244
 $\text{BH}_{12}\text{N}_3\text{O}_3$, 6
 BI_3 , 10
 BKO_2 , 33
 BN , 11, 44
 B_2BaF_8 , 90, 97, 113
 $\text{B}_2\text{BaF}_8\text{H}_4\text{O}_2$, 113
 B_2CaF_8 , 9, 112, 113, 227
 $\text{B}_2\text{CaF}_8\text{H}_4\text{O}_2$, 112
 B_2CdF_8 , 128
 $\text{B}_2\text{CdF}_8\text{H}_{12}\text{N}_4$, 128, 129
 $\text{B}_2\text{CdF}_8\text{H}_{12}\text{O}_6$, 128
 $\text{B}_2\text{CdF}_8\text{H}_{18}\text{N}_6$, 128, 129
 $\text{B}_2\text{ClF}_8\text{K}_3\text{O}_4$, 104
 B_2CoF_8 , 76, 117
 $\text{B}_2\text{CoF}_8\text{H}_{12}\text{O}_6$, 117
 $\text{B}_2\text{CoF}_8\text{H}_{18}\text{N}_6$, 117, 118
 $\text{B}_2\text{Cs}_2\text{F}_6\text{O}_4\text{S}$, 56
 B_2CuF_8 , 122, 123
 $\text{B}_2\text{CuF}_8\text{H}_{12}\text{N}_4$, 123
 $\text{B}_2\text{CuF}_8\text{H}_{12}\text{O}_6$, 122, 123
 $\text{B}_2\text{CuF}_8\text{H}_{16}\text{N}_4\text{O}_2$, 123
 $\text{B}_2\text{F}_2\text{H}_2\text{K}_2\text{O}_7$, 154
 $\text{B}_2\text{F}_2\text{H}_2\text{O}_3$, 153
 $\text{B}_2\text{F}_2\text{H}_2\text{O}_6$, 154
 $\text{B}_2\text{F}_2\text{H}_5\text{NO}_3$, 153, 154
 $\text{B}_2\text{F}_2\text{H}_6\text{O}_9$, 164
 $\text{B}_2\text{F}_2\text{H}_8\text{N}_2\text{O}_6$, 154
 $\text{B}_2\text{F}_2\text{H}_{14}\text{N}_2\text{O}_9$, 154
 $\text{B}_2\text{F}_2\text{K}_2\text{O}_3$, 152, 153, 163
 $\text{B}_2\text{F}_2\text{K}_2\text{O}_6$, 154
 $\text{B}_2\text{F}_3\text{H}_7\text{O}_7$, 164, 215
 $\text{B}_2\text{F}_4\text{H}_2\text{O}_2$, 154
 $\text{B}_2\text{F}_4\text{H}_4\text{HgO}_4$, 170
 $\text{B}_2\text{F}_4\text{H}_4\text{NiO}_4$, 154, 157
 $\text{B}_2\text{F}_4\text{NiO}_2$, 154, 157
 $\text{B}_2\text{F}_5\text{H}_3\text{O}_2$, 54, 156, 158, 168, 170, 181,
 203
 $\text{B}_2\text{F}_6\text{H}_2$, 151, 152
 $\text{B}_2\text{F}_6\text{H}_3\text{P}$, 50, 51
 $\text{B}_2\text{F}_6\text{H}_4\text{O}_7\text{P}_2$, 57
 $\text{B}_2\text{F}_6\text{H}_8\text{O}_4$, 53, 158
 $\text{B}_2\text{F}_7\text{H}_9\text{O}_4$, 155
 $\text{B}_2\text{F}_8\text{Fe}$, 76, 116, 117
 $\text{B}_2\text{F}_8\text{FeH}_{12}\text{O}_6$, 116, 117
 $\text{B}_2\text{F}_8\text{FeH}_{18}\text{N}_6$, 117
 $\text{B}_2\text{F}_8\text{H}_4\text{O}_2\text{Sr}$, 112, 113
 $\text{B}_2\text{F}_8\text{H}_{12}\text{MgO}_6$, 111
 $\text{B}_2\text{F}_8\text{H}_{12}\text{MnO}_6$, 115
 $\text{B}_2\text{F}_8\text{H}_{12}\text{N}_4\text{Zn}$, 127
 $\text{B}_2\text{F}_8\text{H}_{12}\text{NiO}_6$, 120
 $\text{B}_2\text{F}_8\text{H}_{12}\text{O}_6\text{Pb}$, 132, 133
 $\text{B}_2\text{F}_8\text{H}_{12}\text{O}_6\text{Zn}$, 126, 127

- $B_2F_8H_{18}MnN_6$, 115, 116
 $B_2F_8H_{18}N_6Ni$, 120, 121, 229
 $B_2F_8H_{18}N_6Zn$, 127
 B_2F_8Hg , 130
 B_2F_8Mg , 111
 B_2F_8Mn , 115
 B_2F_8Ni , 76, 120
 B_2F_8Pb , 132, 133
 B_2F_8Sn , 131, 132
 B_2F_8Sr , 112, 113
 B_2F_8Zn , 126, 127
 $B_2F_{10}H_{10}O_6Pb_2$, 132, 133
 $B_2F_{10}H_{10}O_6Sn_2$, 131, 132
 B_2O_3 , 2, 3, 4, 5, 6, 7, 8, 9, 11, 33, 89, 102
 $B_3CoF_{12}H_{18}N_6$, 118, 119
 $B_3CoF_{13}H_{19}N_6$, 119
 $B_3CrF_{12}H_{18}N_6$, 114
 $B_3F_3O_3$, 33, 56, 97, 101, 165
 $B_3F_9K_3O_4P$, 57
 $B_3F_9Na_3O_4P$, 57
 $B_3F_{12}In$, 130
 $B_3F_{12}Y$, 114
 $B_4Cu_2F_{16}H_{32}N_{10}O$, 123
 B_4FKO_6 , 104
 $B_4F_4H_2K_4O_{12}$, 163, 164
 $B_4F_4H_4O_{11}$, 163, 164
 $B_4F_4K_4O_{11}$, 163, 164
 $B_4F_{10}H_4$, 152
 $B_4F_{10}K_4$, 152
 $B_4F_{12}H_6K_4O_3$, 101, 152, 162
 $B_4F_{12}H_8N_2O$, 8, 14, 55
 $B_4F_{12}H_{14}O_7$, 164
 $B_4F_{12}H_{44}Na_{14}O_{29}$, 164
 $B_4F_{12}K_4O_7P_2$, 57
 $B_4F_{12}Na_2O$, 8, 14, 55, 164, 165
 $B_4F_{12}Na_4O_7P_2$, 57
 $B_4F_{12}Na_{14}O_7$, 164
 $B_4H_{10}K_4$, 152
 $B_4K_2O_7$, 104
 $B_4Na_2O_7$, 3, 6, 8, 14
 $B_5F_{10}H_{13}NiO_{10}$, 156, 157
 B_6Ba , 11
 B_6Ca , 11
 B_6Sr , 11
 $B_8ClF_{32}K_9O_4$, 104
 BaF_2 , 94
 BaO_4S , 102, 103, 228, 229
 BeF_2 , 2
 BrH , 80
 $CCaO_3$, 33
 $CClF_3$, 77
 CCl_2N , 48
 CCl_4 , 29, 251
 CF_4 , 77, 83
 $CHBF_3N$, 12, 47
 $CHCl_3$, 29
 $CH_2BF_3O_2$, 65, 200
 CH_3BF_2 , 36, 37
 CH_3BF_2O , 61
 CH_3BF_3KO , 55
 CH_3BF_3NaO , 55
 CH_3BO , 37
 CH_3Cl , 78
 CHl_4 , 34, 43
 CH_4BF_3O , 61, 167, 181, 186
 CK_2O_3 , 33
 CLi_2O_3 , 33
 $CMgO_3$, 33
 CO , 32, 43, 182-184
 CO_2 , 255
 CS_2 , 29
 $C_2HBCl_3F_3O$, 64
 C_2HCl_3O , 64, 212, 216, 221
 $C_2HCl_3O_2$, 65
 $C_2H_2BF_3O_4$, 66
 $C_2H_2Cl_2O_2$, 65
 $C_2H_2Cl_4$, 29
 $C_2H_2O_4$, 94
 $C_2H_3BClF_3O$, 65, 212, 216
 $C_2H_3BF_2$, 42
 $C_2H_3BF_2O_2$, 157
 $C_2H_3BF_3N$, 47, 48
 $C_2H_3BF_4O$, 13, 76, 82, 86, 145, 146, 228, 239
 C_2H_3ClO , 64, 146
 $C_2H_3KO_2$, 105
 C_2H_4 , 42, 207-209
 $C_2H_4BF_3$, 208
 $C_2H_4BF_3O$, 63, 64
 $C_2H_4BF_3O_2$, 65, 66, 72, 145, 146, 185, 186, 187, 197, 201
 $C_2H_4BF_3O_4$, 53, 65
 $C_2H_4Cl_2$, 96, 135, 151
 $C_2H_4O_2$, 105, 138
 $C_2H_5BF_2O_2$, 42, 64, 152, 153, 207, 208
 $C_2H_5BF_2O$, 61
 $C_2H_5BF_3NO$, 45, 184, 186, 190

- C_2H_6 , 29
 C_2H_6BF , 36, 37
 $C_2H_6BFO_2$, 61, 153, 208
 $C_2H_6BF_3O$, 37, 62, 68, 78, 82, 83, 84,
 149, 170, 181, 183, 184, 192, 193,
 199, 223
 $C_2H_6BF_3O_2$, 62
 $C_2H_6B_2F_6HgO_2$, 61
 $C_2H_7BF_3N$, 44
 C_2H_7N , 36
 C_2H_7NO , 44
 $C_2H_8BF_3O_2$, 62, 178, 209, 221
 $C_2H_8N_2$, 45
 C_3H_6 , 42, 209, 210
 $C_3H_6BF_3$, 198, 199
 $C_3H_6BF_3O$, 64
 $C_3H_6BF_3O_2$, 65, 72, 186, 187, 190,
 192
 $C_3H_6O_2$, 73
 C_3H_8 , 29
 $C_3H_8BF_3O$, 69
 $C_3H_8O_3$, 62
 C_3H_9B , 36, 37
 $C_3H_9BF_3N$, 44, 47, 150
 $C_3H_9BF_3NO$, 74
 $C_3H_9BF_4N_2O$, 148, 149
 $C_3H_9BF_4O$, 76, 149, 150
 $C_3H_9BO_3$, 238, 239
 $C_3H_9B_3O_3$, 36, 37
 $C_4H_4BF_3O_3$, 72, 212, 216
 $C_4H_4BF_3O_4$, 66
 $C_4H_4Cl_2O_3$, 72
 $C_4H_5Cl_3O_2$, 72
 $C_4H_6BCl_2F_3O_4$, 65
 $C_4H_6BCl_6F_3O_2$, 62
 $C_4H_6BF_3O_2$, 66
 $C_4H_6BF_3O_3$, 71
 $C_4H_6BF_3O_4$, 66
 $C_4H_7ClO_2$, 72
 C_4H_8 , 43, 210–214
 $C_4H_8BF_3O$, 70, 83, 84
 $C_4H_8BF_3O_2$, 65, 72, 146, 200, 201
 $C_4H_8BF_3O_3$, 72
 $C_4H_8BF_3O_4$, 65, 112, 190, 191
 $C_4H_8O_2$, 138
 $C_4H_8BF_2$, 43
 $C_4H_9BF_4NO$, 149
 $C_4H_{10}BCl_2F_3O_2$, 62
 $C_4H_{10}BF_3O$, 14, 15, 69, 70, 82, 83, 84,
 145, 146, 147, 149, 150, 163, 171,
 173, 176, 177, 178, 180, 181, 182,
 184, 187, 188, 189, 190, 191, 192,
 193, 194, 195, 196, 199, 201, 207,
 208, 213, 215, 216, 220, 223, 224,
 248
 $C_4H_{10}BF_3O_3$, 54
 $C_4H_{10}O$, 62
 $C_4H_{11}BF_2O_4$, 157
 $C_4H_{11}BF_3N$, 44
 $C_4H_{11}BF_4O$, 76
 $C_4H_{12}BF_3O_2$, 62, 68
 $C_4H_{12}BF_3O_4$, 54
 $C_4H_{12}BF_4N$, 135
 $C_4H_{12}B_2O$, 36, 37
 $C_4H_{16}BCl_2CoF_4N_4$, 119
 $C_4H_{16}BCoF_4N_6O_4$, 119, 120
 $C_4H_{16}B_2CuF_8N_4$, 124
 $C_4H_{16}B_2F_8HgN_4$, 130
 $C_4H_{19}B_2CuF_8N_5$, 123
 $C_5H_5BF_3N$, 47, 135, 150, 201
 $C_5H_7BF_2O_2$, 35
 $C_5H_7Cl_3O_2$, 73
 C_5H_{10} , 43
 $C_5H_{10}BClF_2O$, 150
 $C_5H_{10}BF_3O$, 64
 $C_5H_{10}BF_3O_2$, 72, 73, 185
 $C_5H_{10}O$, 63, 64
 $C_5H_{10}O_2$, 72, 73
 $C_5H_{11}BClFO_2$, 147
 $C_5H_{11}BClF_3O_2$, 70
 $C_5H_{11}N$, 47
 C_5H_{12} , 29, 30
 $C_5H_{12}BF_4N$, 135
 $C_5H_{13}BF_3NO$, 44, 150
 $C_5H_{13}BF_4O$, 149
 $C_5H_{14}BF_4NO$, 148
 $C_6H_4BClF_4N_2$, 140
 $C_6H_4BF_4N_3O_2$, 140
 $C_6H_4BF_5N_2$, 139
 $C_6H_4B_2F_8N_4$, 139
 $C_6H_4Cl_2$, 29
 $C_6H_5BF_2$, 38
 $C_6H_5BF_4N_2$, 134, 138, 139
 $C_6H_5BF_4N_2O$, 140
 $C_6H_5BF_4N_2O_2S$, 140
 $C_6H_5BF_4N_2O_4S$, 140

- $C_6H_5NO_2$, 29, 135, 147, 151
 C_6H_6 , 29, 34, 43, 203-206
 $C_6H_6BF_3KN$, 46
 C_6H_6O , 206
 $C_6H_6O_2$, 63
 $C_6H_7BF_3N$, 45
 $C_6H_{10}O_4$, 72
 $C_6H_{12}BF_3O_4$, 65
 $C_6H_{12}B_3Cl_3F_6O_3$, 70
 $C_6H_{12}B_4F_{12}N_4$, 45
 $C_6H_{12}O_2$, 73
 $C_6H_{14}BF_3O$, 69, 70, 83, 84, 150
 $C_6H_{14}O_4S$, 73
 $C_6H_{15}B$, 38
 $C_6H_{15}BF_3N$, 44
 $C_6H_{15}BF_4O$, 76, 147, 148, 149, 150
 $C_6H_{15}BF_4OS$, 148
 $C_6H_{15}BF_4S$, 76, 148, 149
 $C_6H_{16}BF_3O_2$, 62
 $C_6H_{18}BN_3$, 36
 $C_6H_{18}B_2CdF_8N_6$, 129
 $C_6H_{24}B_2F_8MnN_6$, 116
 $C_6H_{24}B_2F_8N_6Ni$, 121, 122
 $C_6H_{24}B_2F_8N_6Zn$, 127
 $C_6H_{24}B_3CrF_{12}N_{12}O_6$, 114, 115
 $C_7H_5BF_3N$, 47
 $C_7H_5BF_4N_2O_2$, 139, 140
 $C_7H_5BF_4N_2O_3$, 140
 $C_7H_6BF_3O_2$, 66
 $C_7H_6O_3$, 66
 $C_7H_7BF_2$, 38
 $C_7H_7BF_3NO_2$, 46
 $C_7H_7BF_4N_2$, 141
 C_7H_8 , 206
 $C_7H_8BF_3O$, 70, 83
 C_7H_8O , 70
 $C_7H_9BF_3NO$, 48, 49
 $C_7H_9BF_3NO_2$, 150
 C_7H_9N , 47
 $C_7H_{10}BF_4N$, 76
 $C_7H_{12}O_4$, 72
 $C_7H_{15}BClF_3O_2$, 70
 $C_8H_4O_8$, 72
 $C_8H_7BF_3N$, 47
 $C_8H_7BF_4N_2O$, 140
 $C_8H_8BF_2O_3$, 35
 $C_8H_8BF_3O_2$, 66, 72
 $C_8H_8BF_6N_2O_2$, 141
 $C_8H_8O_2$, 73
 $C_8H_9BF_3NO$, 45, 46
 $C_8H_9BF_4N_2O$, 140
 C_8H_{10} , 206
 $C_8H_{10}BClF_3NO$, 49
 $C_8H_{10}BF_3O$, 70, 83
 $C_8H_{11}BF_3N$, 45, 46
 $C_8H_{11}N$, 226
 $C_8H_{12}BF_3O_4$, 66
 $C_8H_{14}O_2$, 73
 $C_8H_{16}B_2Cl_2F_3O_3$, 149
 $C_8H_{16}BF_3O_4$, 65
 $C_8H_{18}BF_3O$, 69, 180, 224
 $C_8H_{18}O_4S$, 73
 $C_8H_{20}BF_3O_2$, 62, 69
 $C_8H_{20}BF_4N$, 135
 $C_9H_6O_2$, 76
 C_9H_7N , 47
 $C_9H_9BF_4N_2O_2$, 140
 $C_9H_{10}BClF_3NO$, 150
 $C_9H_{10}BF_3O_2$, 73
 $C_9H_{10}O_2$, 73
 $C_9H_{11}BF_3NO$, 45, 46
 $C_9H_{12}BF_3$, 199
 $C_9H_{12}O$, 70
 $C_9H_{21}B$, 35, 38
 $C_9H_{21}BF_4O$, 150
 $C_{10}H_7BF_4N_2$, 141
 $C_{10}H_7BF_4N_2O$, 142
 $C_{10}H_8$, 207
 $C_{10}H_9BF_2O_2$, 35, 64
 $C_{10}H_{10}AgBF_4N_2$, 126
 $C_{10}H_{10}B_2F_8HgN_2$, 130
 $C_{10}H_{10}B_2F_8MnN_2$, 116
 $C_{10}H_{10}O_2$, 64
 $C_{10}H_{12}BF_3O_3$, 73
 $C_{10}H_{12}O$, 70
 $C_{10}H_{14}B_2F_8N_2O_2Zn$, 128
 $C_{10}H_{14}O$, 63
 $C_{10}H_{16}O$, 64
 $C_{10}H_{22}BF_3O$, 70
 $C_{11}H_{14}BF_3O_3$, 73
 $C_{11}H_{16}O$, 70
 $C_{11}H_{22}O$, 64
 $C_{12}H_7B_2F_8N_3O_2$, 142
 $C_{12}H_8B_2F_8N_4$, 142
 $C_{12}H_9BF_4N_2$, 142

- $C_{12}H_{10}BF$, 38
 $C_{12}H_{10}O$, 70, 83
 $C_{12}H_{12}BF_3O_2$, 63, 83
 $C_{12}H_{14}B_3F_9O_7$, 71, 72
 $C_{12}H_{16}BF_4NO$, 135, 136
 $C_{12}H_{21}BF_4O$, 76, 148
 $C_{12}H_{27}B$, 35, 38
 $C_{12}H_{27}O_4P$, 73
 $C_{12}H_{28}BF_3O_2$, 69
 $C_{12}H_{30}BF_3N_2$, 44
 $C_{12}H_{40}B_2CoF_8N_8O_8$, 118
 $C_{12}H_{40}B_2F_8MgN_8O_8$, 111, 112
 $C_{12}H_{40}B_2F_8MnN_8O_8$, 116
 $C_{12}H_{40}B_2F_8N_8NiO_8$, 121
 $C_{13}H_{11}BF_3N$, 46, 169
 $C_{13}H_{11}BF_4N_2$, 141
 $C_{14}H_{10}O_3$, 72
 $C_{14}H_{12}BF_3$, 42
 $C_{14}H_{13}BF_3NO$, 47
 $C_{14}H_{14}O$, 70
 $C_{14}H_{16}BF_3O_2$, 62
 $C_{15}H_{11}BF_2O_2$, 35
 $C_{15}H_{33}B$, 35
 $C_{16}H_{14}O_3$, 72
 $C_{16}H_{26}B_3F_9O_5$, 72
 $C_{16}H_{34}O$, 62
 $C_{16}H_{36}BF_4N$, 135
 $C_{17}H_{17}BClF_4NO$, 136
 $C_{17}H_{18}BF_4NO$, 136
 $C_{17}H_{20}BF_4NO_3$, 137
 $C_{17}H_{22}BF_4NO_4$, 136, 137
 $C_{18}H_{15}B$, 36, 38
 $C_{18}H_{16}B_3F_6O_3$, 70
 $C_{19}H_{15}BF_4$, 146, 147
 $C_{20}H_{17}BF_4N_4$, 136, 229, 238
 $C_{20}H_{20}AgBF_4N_4$, 126
 $C_{20}H_{20}B_2CdF_8N_4$, 129
 $C_{20}H_{20}B_2CuF_8N_4$, 124
 $C_{20}H_{24}B_2CoF_8N_4O_2$, 118
 $C_{20}H_{24}B_2CuF_8N_4O_2$, 124
 $C_{20}H_{24}B_2F_8N_4NiO_2$, 122
 $C_{20}H_{24}N_2O_2$, 137
 $C_{20}H_{38}BF_3O_3$, 54
 $C_{20}H_{40}BF_3O_4$, 54
 $C_{21}H_{21}B$, 38
 $C_{21}H_{23}BF_4N_2O_2$, 137
 $C_{21}H_{23}BF_4O_3$, 148
 $C_{22}H_{20}N_4O_2$, 229, 238
 $C_{22}H_{27}BFN$, 150, 151
 $C_{23}H_{27}BF_4N_2O_4$, 137
 $C_{23}H_{34}B_2F_6N_2O_8$, 45
 $C_{24}H_{27}B$, 38
 $C_{24}H_{27}BO_3$, 38
 $C_{30}H_{21}B$, 38
 $C_{30}H_{34}B_2CuF_8N_6O_2$, 124
 $C_{34}H_{51}BFN$, 151
 $C_{36}H_{36}B_2CdF_8N_6$, 129
 $C_{36}H_{36}B_2CoF_8N_6$, 118
 $CaCl_2$, 97, 229, 235, 238, 245
 CaF_2 , 1, 2, 3, 4, 5, 6, 8, 11, 13, 14, 89, 90, 95, 96
 CaH_2O_2 , 33, 55, 229
 CaO , 34, 55, 227
 CaO_3Si , 34
 CaO_4S , 102
 Cd , 94, 110, 128
 CdF_2 , 10
 $ClCsO_4$, 108
 ClH , 78, 106
 ClH_4N , 104, 110
 ClH_4NO_4 , 110, 160, 161
 $ClKO_4$, 102, 107, 228, 229
 $ClNO_5$, 134
 $ClNa$, 79, 244
 $ClNaO_4$, 98
 ClO_4Rb , 107
 ClO_4Tl , 131
 Cl_2OS , 61
 Cl_2O_2S , 56
 Cl_3OP , 58
 Cr , 31, 94, 114
 Cu , 32, 94, 122

 FH , 6, 8, 11, 14, 88, 89, 90, 91, 92, 93, 94, 95, 101, 198, 227, 232, 234, 235, 236, 237, 239, 244
 FHO_3S , 6
 FH_4N , 8
 FK , 102, 103
 FN_4 , 11, 244, 248
 F_2 , 10, 11, 91
 F_2HK , 92
 F_2HN_4 , 95, 99, 237, 238, 244, 245
 F_2H_5N , 8, 14
 F_2Ni , 239
 F_2O_2U , 2

- F_2Pb , 10
 F_2Zn , 10
 F_3Fe , 2
 F_3N , 10
 F_3P , 10, 51, 83
 F_3PS , 61
 F_3Sb , 10
 F_4Pb , 11
 F_4Si , 11, 12, 89, 146, 238, 244, 245, 247
 F_4Sn , 2
 F_4Ti , 2
 F_4Zr , 2
 F_6H_2Si , 89, 94, 106, 232, 233, 234, 235, 236, 237, 244
 F_6K_2Si , 101, 233, 234
 F_6Na_2Si , 237, 244
 Fe , 31, 94, 117

 HKO , 232, 235, 245
 HNO_3 , 28, 56, 196
 $HNaO$, 96, 97, 230, 231, 232, 245
 H_2 , 32, 91, 196
 H_2O , 28, 53, 54, 87, 88, 91, 92, 136, 194, 239
 H_2O_3Si , 244
 H_2O_4S , 28, 56, 87, 88, 105, 134, 161, 177, 197, 226, 232, 233, 234, 235, 236, 237
 H_3N , 226
 H_3P , 212, 216
 Hg , 31, 249, 251
 HgO , 94

 IKO_4 , 107
 In , 94, 110, 130

 K , 31, 228
 $KMnO_4$, 102, 103, 107, 228
 KNO_3 , 33

 Mg , 31, 95, 110
 MgO , 33
 MgO_3Si , 34
 MnO_4Rb , 107

 $NNaO_2$, 138
 $NNaO_3$, 97
 NO_2 , 56
 N_2 , 255
 N_2O , 49, 56
 N_2O_6S , 134
 Na , 31
 Na_2O_4S , 238
 Ni , 94, 120

 O_2 , 249
 O_2Pb , 133
 O_2S , 146, 149, 239, 242, 243, 244, 247
 O_2Si , 34
 O_2Ti , 34
 O_3S , 239, 245
 O_4PbS , 102
 O_4Pb_3 , 32
 O_4SSr , 102
 O_5P_2 , 57

 Pb , 94, 132, 133

 Sn , 94, 131, 132

 Zn , 94, 110, 126, 127

DATE OF ISSUE

This book must be returned
within 3, 7, 14 days of its issue. A
fine of ONE ANNA per day will
be charged if the book is overdue.

--

This book is issued for
7 D A Y S O N L Y