

Birla Central Library

PILANI (Jaipur State)

Class No :- 509

Book No :- W 52 E

Accession No :- 12602

Acc No _____

ISSUE LABEL

Not later the latest date stamped below.

THE ENDLESS QUEST

BLACKIE & SON LIMITED

50 Old Bailey, LONDON
17 Stanhope Street, GLASGOW

BLACKIE & SON (INDIA) LIMITED
Warwick House, Fort Street, BOMBAY

BLACKIE & SON (CANADA) LIMITED
TORONTO

THE ENDLESS QUEST

Three Thousand Years of Science

BY

F. W. WESTAWAY

Author of "Scientific Method: its Philosophic Basis and its Modes of Application"
"Science and Theology: Some Common Aims and Methods"
&c.

SECOND EDITION

BLACKIE & SON LIMITED
LONDON AND GLASGOW

First published 1934
Second edition 1935
Reprinted 1936

Printed in Great Britain by Blackie & Son, Ltd., Glasgow

To
The Scholar in the Roman Aqueduct
(Plate 5)

K. M. WESTAWAY
M.A.(Cantab.), D.Lit.(Lond.)

PREFACE TO FIRST EDITION

Although primarily a history of science, this book makes a new departure: it deals with the subject critically. It presents to the layman the main facts of science as they have come down to us through the ages, and it does this in such a way that the layman may, in some measure, judge for himself the value of the evidence by which the facts are supported. It shows the weakness of science as well as its strength, especially the present-day weakness of fabricating hypotheses on a too slender basis of definitely ascertained facts. It shows the points of contact between science, mathematics, and philosophy. It holds up in relief such great exemplars of scientific method as Galileo, Newton, Faraday, Darwin, and Pasteur. It stresses the need for a wider scientific outlook on the part of all persons in authority.

It was my former colleague, that thoughtful historian Mr. F. S. Marvin, who was one of the first to insist that the history of science is an essential part of history in the broader sense, and that to teach the latter without including the former is to present the subject devoid of one of its most vital interests. Admittedly the history of science is the history of the gradual development of some of the most fundamental ideas and conceptions of civilization. It is these ideas and conceptions, together with the historical aspects of scientific method, achievement, and progress, and the contact of science with life, which to the layman are bound to make a much stronger appeal than are the minutiae of technical detail. If, however, the layman wishes to study the history of some one branch of science, precise knowledge of the subject is essential to the under-

standing of the significance of the stages by which successive discoveries have been reached, and a few of the more noteworthy discoveries I have therefore set out at considerable length, often in the discoverer's own words and sometimes in a quite elementary way.

It must not be forgotten, however, that the history of mankind in the broader sense is a far more complex thing than the history of science alone. Living beings and their activities, their actions and their motives, their hopes and their beliefs, their waywardness and their fickleness, cannot be adequately mirrored in symbolic schemes; human history refuses to submit to any such summary treatment. The historian who does his subject full justice must, however, show how history has been swayed now by one scientific discovery and now by another, how such discoveries have come about and what manner of man it is who has made them, and how it has happened that man has more and more to be fitted for life in a civilization founded by science.

The following postulates may help the reader to adjudge more justly the work of the men of science who have made the history recorded in this book.

1. The true man of science is one who

- (i) never says "I know", but says "I believe", or "the evidence seems to show", or "it is probable", or "it is possible";
- (ii) never refuses to recognize that what he does not clearly understand he does not possess;
- (iii) never tries to make absurdity plausible;
- (iv) never makes pontifical announcements;
- (v) never indulges in melodrama.

2. Nature delights in making fools of men by encouraging them to think that any term they may invent has infallibly a counterpart in herself.

3. The highest categories of science are *laws*, which are generalizations of facts based on evidence cumulative and convincing.

4. Hypotheses, though necessary for progress, are only provisional. They rank lower than laws, for they are in some measure speculative and subjective.

5. Science is concerned exclusively with judgments of perception, and not with judgments of feeling. A judgment of feeling is necessarily individual and personal. Scientific truth is not the private truth of an individual, but is objective and universal.

It may be that some of my younger readers will be critical of the stress I have laid on the importance of laboratory and field work, and of the impatience I may have shown with the pleasanter speculative work done in the easy chair. But faith in my own old teachers—Thomas Henry Huxley, John Tyndall, John Hall Gladstone, and (the 3rd) Lord Rayleigh—is as strong as ever, all of whom, in season and out of season, insisted on laboratory and field work first and always, on *facts* and ever more facts. And I am still sure they were right. Those were not the days when men of science had brought themselves to think that the secrets of nature might be wrung from her by algebra.

For the sake of non-mathematical readers, I have reduced mathematical demonstrations to a bare minimum, and there is hardly any mathematics in the book that may not be readily understood by a boy who has included the subject in his Fifth Form course at school. Science, even biology, without mathematics of any kind is science only half alive. He who calls for “just the romance of science and none of its equations” quite obviously fails to realize all that science really signifies.

The history of science is such a vast subject that I could only pick and choose, and I therefore owe profound apologies to the many great men whose works I have despoiled. The apologies are specially due to those living writers from whose books I have quoted very briefly. Quotations torn from their context are always likely to mislead, and the reader who is interested in any particular topic is begged to refer to the original books.

The titles and the authors of the books to which I have been most indebted are given at the ends of the various chapters. All the books may be consulted at the British Museum Library, and most of them may be obtained on loan from H. K. Lewis and Co.'s Scientific and Medical Library, W.C.1. The periodical *Proceedings* of the various learned Societies have, of course, been invaluable; so has *Nature*, a faithful friend of fifty years. Needless to say, the successive editions of the *Encyclopædia Britannica* have also been of great service.

In particular thanks are due to:

Messrs. George Allen & Unwin, Ltd., for extracts from *The Scientific Outlook*, by Bertrand Russell, and *The Universe in the Light of Modern Physics*, by Max Planck; The British Institute of Philosophy for several extracts—indicated in the text—from *Philosophy*; Messrs. The Cambridge University Press for extracts from Prof. A. N. Whitehead's *Principle of Relativity*, *Principles of Natural Knowledge*, and *Concept of Nature*, Dr. Harold Jeffreys' *Scientific Inference*, Sir Arthur Eddington's *Nature of the Physical World*, Sir James Jeans's *New Background of Science*, and Dr. Barnes' *Scientific Theory and Religion*; Messrs. Chatto & Windus and Prof. J. B. S. Haldane for extracts from *The Inequality of Man*; Messrs. Kegan Paul, Trench, Trubner & Co., Ltd., for extracts from Dr. Broad's *Scientific Thought*, Prof. M. B. Cohen's *Reason and Nature*, and Prof. Burt's *Metaphysical Foundations of Modern Physical Science*; the editor of *The Mathematical Gazette* for extracts from the *Gazette*; the Open Court Publishing Co. for extracts from Prof. Mach's *Mechanics*; Messrs. The Oxford University Press for extracts from Mr. Hastings Berkeley's *Mysticism in Modern Mathematics*; Messrs. The Times Publishing Co., Ltd., Sir Robert Giles, Mr. H. W. B. Joseph, Hon. Stephen Coleridge, and Sir James Jeans for extracts from correspondence which appeared in *The Times*; Messrs. Watts & Co. for extracts from Prof. Levy's *The Universe of Science*; Messrs. Williams & Norgate, Ltd., for extracts from Prof. Dingle's *Science and Human Experience*.

Special thanks are also due to the following persons, authorities, and publishers, for permission to reproduce various illustrations:

Messrs. Baillière, Tindall & Cox (figs. 189, 190); Messrs. Bell & Sons; Mr. F. W. Bond and the Zoological Society; Sir William Bragg (figs. 117, 118, 119, 120, 121); The British Museum; Messrs. Cassell & Co., Ltd. (figs. 171, 177); The Cambridge University Press (figs. 135, 172, 175, 183, plate 41); The Clarendon Press (figs. 164, 165, 170A, 170B, 173,

PREFACE

xi

plates 39, 40); Messrs. Glyndendalk, Copenhagen (fig. 110); Dr. Knox Shaw (fig. 137); Messrs. Lippincott & Co. (fig. 174); Professor McGregor of New York; Messrs. Macmillan & Co. (figs. 25, 74, 75, 82, 124, 178); Messrs. Macmillan & Co. (New York) (fig. 168); Messrs. Methuen & Co. Ltd. (figs. 108, 109); The Mosquito Control Institute, Hants. (figs. 184, 185); The Mount Wilson Observatory; Messrs. John Murray (figs. 99, 113); The National Physical Laboratory; The National Portrait Gallery; The Hon. John Collier; The Royal Institution; Messrs. Williams & Norgate, Ltd. (figs. 179, 182); Messrs. Wright & Murray (fig. 156); Messrs. Edward Arnold & Co. (plate 19 and fig. 105).

Aspley Heath,
March, 1934.

PREFACE TO SECOND EDITION

The call for a second edition within the first year of publication affords an early opportunity of embodying suggestions made by various friends and of correcting a few errors that had been overlooked.

More than one correspondent has asked why psychology and economics were excluded from the subjects considered. Concerning psychology I have nothing to add to what I said in Chap. XLIX. As to economics I find it difficult to agree that its doctrines have yet established a claim to be regarded as a branch of science. Even the most fundamental principles of the subject are still of so highly a speculative and controversial character that economic "law" has certainly not yet the strength of scientific law. It may be granted that economics has now reached the stage of a robust adolescence, but the history of its childhood would be out of place in a book of this kind.

The "Royal Jubilee Number" of *Nature*, 4th May, 1935, contains a list of thirty articles, all by well-known men, reviewing the advances made in the principal branches of physical science during the past twenty-five years. Included are such widely different topics as The Structure of the Universe, The New Age in Physics, Constitution of the Earth, The Measurement of Geological Time, Atomic Physics, Isotopes, X-Ray Crystal Analysis, Low Temperature Research, Cosmic Rays, Weather Forecasting, Conception of Man's Ancestry, Discovery and Significance of Vitamins, Viruses and the Cause of Disease, Genetics since 1910, Special Steels, and Progress in Radio Communication. The number provides a welcome and authoritative supplement to this volume.

Of the leading books of science that have appeared during the past year, perhaps the most important is Sir Arthur Eddington's

New Pathways in Science, really a sequel to his *Nature of the Physical World*. Among the subjects treated are Indeterminacy, Probability, and The Constants of Nature, and in the chapter on " Criticisms and Controversies ", Sir Arthur replies to several of his critics. The book was reviewed in *Nature* by Professor H. Dingle, 23rd March, 1935, and the review led to interesting correspondence in subsequent numbers of that journal.

Other notable books of the year are:

2. *A History of Science, Technology, and Philosophy in the 16th and 17th Centuries*, Professor A. Wolf.
3. *The Frustration of Science*, Sir Daniel Hall and others.
4. *Atomic Physics*, Max Born.
5. *Science and the Human Temperament*, Professor Erwin Schrödinger.
6. *The Electronic Theory of Chemistry*, Professor R. F. Hunter.
7. *Relativity, Gravitation, and World Structure*, Professor E. A. Milne.
8. *Relativity, Thermodynamics and Cosmology*, Professor R. C. Tolman.
9. *A Study of History*, Professor A. S. Toynbee.
10. *The Philosophy of a Biologist*, Professor J. S. Haldane.
11. *The Search for Truth*, Professor E. T. Bell.
12. *Nature, Man, and God*, W. Temple, Archbishop of York.

The new cosmogony, with its parent relativity and its children indeterminism and the quantum theory, still holds pride of place during the leisure hours of men of science, but to the majority it still seems to be a medley of facts and fancies which require a Newton to cast out the lumber. But there is no sign of another Newton at present.

It is as significant as it is interesting to observe that the average man of science is now much less reluctant to admit that, in regard to possible penetration into the inner nature of things, the intuitions of the philosopher, the theologian (who, of course, must be distinguished from the ecclesiastic), and the poet, may often justly claim, despite the fundamentally different methods of approach, as much respect as his own.

F. W. W.

May, 1935.

CONTENTS

CHAP.	Page
I. GEOGRAPHY OF THE ANCIENT WORLD - - -	1
II. EARLY CIVILIZATIONS: HISTORICAL SUMMARY - -	8
Egypt—Babylonia—Assyria—Persia—Crete— Phœnicia—Greece—Rome—Evidence from Archæology and from History.	
III. BABYLONIAN ASTRONOMY - - - - -	23
IV. EGYPTIAN MATHEMATICS - - - - -	27
V. THE GENIUS OF THE GREEKS - - - - -	34
VI. THE GREEK "SCHOOLS" - - - - -	37
The Ionian School—The Pythagorean School— The Eleatic School—The Athenian School—The Alexandrian School.	
VII. GREEK MATHEMATICS - - - - -	46
VIII. GREEK ASTRONOMY - - - - -	58
IX. GREEK BIOLOGY - - - - -	68
X. GREEK MEDICINE - - - - -	71
XI. GREEK PHYSICAL SCIENCE - - - - -	75
XII. ROMAN SCIENCE - - - - -	81
XIII. A THOUSAND LEAN YEARS - - - - -	89
XIV. THE HINDUS AND THE ARABS - - - - -	99
XV. THE MORNING OF THE EUROPEAN RENAISSANCE -	102
The Thirteenth Century.	
XVI. THE RENAISSANCE AND THE REFORMATION - - -	110
Fourteenth, Fifteenth, and Sixteenth Centuries.	

CHAP.		Page
XXVII.	THE NEW ASTRONOMY - - - - - Relative Distances and Relative Motions.	119
XXVIII.	COPERNICUS - - - - -	127
XIX.	TYCHO BRAHÉ - - - - -	132
XX.	KEPLER - - - - -	140
XXI.	GALILEO - - - - -	150
XXII.	THE FOUNDATION OF MECHANICS - - - - -	163
XXIII.	ADVISERS ON METHODOICAL RESEARCH - - - - -	177
XXIV.	THE IMMEDIATE PREDECESSORS AND THE CONTEMPORARIES OF NEWTON - - - - -	187
XXV.	ISAAC NEWTON - - - - -	192
XXVI.	LOCKE - - - - -	221
XXVII.	THE RISE OF THE ACADEMIES, INSTITUTIONS, AND SOCIETIES - - - - -	232
XXVIII.	THE BEGINNING OF RATIONAL MEDICINE AND SURGERY - - - - -	239
XXIX.	FIRST ATTEMPTS AT A RATIONAL CHEMISTRY - - - - -	264
XXX.	ROBERT BOYLE - - - - -	277
XXXI.	FROM BLACK TO LAVOISIER - - - - -	293
XXXII.	THE ATOMIC THEORY ESTABLISHED - - - - -	311
XXXIII.	EARLY ELECTRICAL RESEARCH - - - - -	328
XXXIV.	MICHAEL FARADAY - - - - -	344
XXXV.	FARADAY'S FAMOUS EXPERIMENTS OF 1821 AND 1831 - - - - -	361
XXXVI.	THE TRANSITION FROM THE OLDER TO THE NEWER PHYSICS - - - - -	376
	1. The Physicist as a Mathematician - - - - -	379
	2. Wave Motion - - - - -	394
	3. Light: Wave and Emission Theories - - - - -	408
	4. Spectroscopy - - - - -	422
	5. Thermodynamics - - - - -	433

CONTENTS

xvii

CHAP.		Page
XXXVII.	SOME PROBLEMS OF MODERN PHYSICS - -	441
	1. Rays, Radiation, Radioactivity - -	445
	2. The Atom: Fundamental Facts and Inferences - - - -	454
	3. Modern Theories of the Atom - -	470
	4. The Modern Molecule - -	486
	5. Modern Transmutation - -	501
XXXVIII.	SOME RIDDLES OF MODERN PHYSICS - -	510
	1. The Quantum Theory - -	510
	2. Wave Mechanics - -	518
	3. Relativity - - - -	536
XXXIX.	PRACTICAL DEVELOPMENTS IN PHYSICAL SCIENCE -	569
XL.	ASTRONOMY AND COSMOGONY - - - -	605
XLI.	GEOLOGY AND GEOPHYSICS - - - -	656
XLII.	METEOROLOGY - - - - -	697
XLIII.	BIOLOGY - - - - -	731
XLIV.	CYTOLOGY AND EMBRYOLOGY - - - -	761
XLV.	EVOLUTION AND HEREDITY - - - -	780
XLVI.	ANTHROPOLOGY AND ARCHÆOLOGY - - -	824
XLVII.	ECONOMIC BIOLOGY AND AGRICULTURE - -	855
XLVIII.	HYGIENE AND MEDICINE - - - -	873
XLIX.	PHILOSOPHY AND SCIENCE - - - -	925
L.	CAUSATION AND INDETERMINACY - - -	933
LI.	HYPOTHESES - - - - -	963
LII.	MATHEMATICS AND MATHEMATICIANS - -	970
LIII.	IDEALISM AND OTHER MYSTERIES IN PHYSICS -	981
LIV.	THE NOBEL PRIZES: THE O.M. - - - -	1010
LV.	FURTHER OPINIONS AND SOME REFLECTIONS -	1012
	APPENDIX: SOME QUESTIONS FOR READERS -	1037
	NAME INDEX - - - - -	1041
	SUBJECT INDEX - - - - -	1057

LIST OF HALF-TONE PLATES

	Facing Page
1. NEWTON - - - - -	<i>Frontispiece</i>
2. LETTER FROM TUSHRATTA; HITTITE INSCRIPTION - -	8
3. ARISTOTLE; THEOPHRASTUS; ARCHIMEDES; HIPPOCRATES -	25
4. A ROMAN CRANE - - - - -	72
5. ROMAN AQUEDUCT; THE ACTUAL AQUEDUCT OVER THE ARCHES - - - - -	89
6. LEONARDO DA VINCI - " - - - - -	104
7. COPERNICUS; TYCHO BRAHÉ; KEPLER; GALILEO - -	121
8. DESCARTES; HUYGENS; NAPIER; LOCKE - - - -	160
9. LEIBNITZ; HARVEY; WREN; BOYLE - - - - -	193
10. CHEMICAL LABORATORY: AN ALCHEMIST AT WORK - -	264
11. MODERN CHEMISTS: ARRHENIUS; MADAME CURIE; DEWAR; LANGMUIR - - - - -	281
12. MICHAEL FARADAY - - - - -	320
13. FARADAY DELIVERING A LECTURE AT THE ROYAL INSTI- TUTION, CHRISTMAS, 1855 - - - - -	353
14. PAGE OF FARADAY'S DIARY - - - - -	360
15. DALTON; DAVY; MAXWELL; KELVIN - - - - -	377
16. YOUNG; MENDELÉEFF; RÖNTGEN; POINCARÉ - - -	424
17. J. J. THOMSON; RUTHERFORD; SIR WM. BRAGG; PLANCK	441

	Facing Page
18. TRACKS OF α PARTICLES. α -RAY TRACKS - - - -	448
19. PHOTOGRAPHS OF TYPICAL POSITIVE RAY PARABOLAS; THE PARABOLAS OF NEON - - - - -	468
20. MASS SPECTRA - - - - -	481
21. SOME SPECIALISTS IN QUANTUM MECHANICS: HEISENBERG; DE BROGLIE; SCHRÖDINGER; DIRAC - - - -	488
22. X-RAY SPECTROMETER; DIFFRACTION OF X-RAYS BY A CRYSTAL OF BERYL - - - - -	505
23. DIFFRACTION OF X-RAYS; ELECTRON DIFFRACTION BY TRANSMISSION THROUGH GOLD LEAF; A MODE OF THE HYDROGEN ATOM - - - - -	520
24. SUCCESSIVE STAGES OF THE FLOW ROUND A ROTATING CYLINDER - - - - -	537
25. EINSTEIN - - - - -	552
26. MILLION VOLT SPARK - - - - -	569
27. LEVI CIVITA; SOMMERFELD; EDDINGTON; JEANS - - - -	576
28. PUTNEY BRIDGE - - - - -	584
29. FOUR EXAMPLES OF PHOTOMICROGRAPHY - - - - -	601
30. PHOTOGRAPH OF AN 8-MM. BULLET MOVING WITH VELOCITY OF ABOUT 880 M./S. - - - - -	609
31. SOLAR SPECTRUM - - - - -	616
32. NEBULAR SPECTRA - - - - -	633
33. INTERIOR OF DOME, MOUNT WILSON OBSERVATORY - - - -	648
34. LARGER NETWORK NEBULA - - - - -	665
35. SPIRAL NEBULA. URSA MAJOR - - - - -	680
36. AEROPLANE VIEW OF MOUNT WILSON OBSERVATORY - - - -	697
37. SEISMOGRAM - - - - -	704
38. CHARLES R. DARWIN - - - - -	737
39. MITOSIS, IN FERTILIZED EGG OF <i>ASCARIS</i> - - - - -	744

LIST OF HALF-TONE PLATES

xxi

	Facing Page
40. EMBRYO OF A CHICK COMPARED WITH HUMAN EMBRYO	- 761
41. RADIOLARIANS - - - - -	- 800
42. GIBBON; ORANG-OUTAN - - - - -	- 816
43. GORILLA; CHIMPANZEES - - - - -	- 816
44. HUXLEY; DOROTHY GARROD; PASTEUR; KOCH - - - - -	- 833
45. PITHECANTHROPUS; EOANTHROPUS; NEANDERTHAL MAN; CRO-MAGNON MAN - - - - -	- 840
46. NEANDERTHAL SKULL - - - - -	- 857
47. LIEBIG; JENNER - - - - -	- 888
48. PUNCH CARTOON - - - - -	- 1024

COLOUR PLATES

1. SPECTRUM - - - - -	- 426
2. COLOURED TROPOSPHERE - - - - -	- 712
3. AURORA BOREALIS - - - - -	- 730

“The Riddles of the Sphinx have always a twofold condition attached to them: laceration of mind, if you fail to solve them; if you succeed, a kingdom.”

BACON (Lord Verulam), *De Sap. Vet.*

“De dissensionibus tantis summorum vivorum disseramus; de obscuritate naturæ, deque errore tot philosophorum, qui tanto opere discrepant, ut, quum plus uno verum esse non possit, iacere necesse sit tot tam nobiles disciplinae.”

CICERO, *Acad. Prior.*, II, xlviij.

THE ENDLESS QUEST: 3000 YEARS OF SCIENCE

CHAPTER I

Geography of the Ancient World

If the reader is to obtain an adequate appreciation of the beginnings of science, and to place the facts in a proper perspective, he must know something of the geography and history of the ancient world. To this end, we begin with two short introductory chapters.

The first chapter is concerned with geography. The sketch maps show the positions of the places named in the text, but the reader should also examine the corresponding maps in a good physical atlas. The inter-relations between the history and the physical geography of the countries concerned are so close that the history cannot be understood without a clear visualization of the countries physically. Mountains and rivers, deserts and fertile plains, accessible and inaccessible places, must be seen as in a picture.

The geography is concerned mainly with **N.E. Africa**, **S.W. Asia**, and **S.E. Europe**, the three regions round the eastern Mediterranean which formed the natural centre of the geography and history of the ancient world.

Observe that the Tunisian peninsula of N. Africa juts out into the sea towards Sicily. Ancient Carthage, virtually on the site of modern Tunis, was almost in sight of Sicily,

the principal town of which, Syracuse, was one of her greatest rivals. The western Mediterranean stretches out to Gibraltar, and contains the Balearic Isles, Corsica, and Sardinia. The eastern Mediterranean extends to Syria and Palestine, and the Adriatic and Ægean Seas are prominent arms to the north. The Ægean encloses a multitude of islands, and is itself more than half converted into a lake by the long island of Crete stretching across east and west (fig. 1).

Flowing into the Mediterranean at its S.E. corner is the River Nile. For many hundreds of miles before reaching the sea the Nile does not receive a single tributary. The river runs along a narrow valley with rainless and waterless deserts on either side, and this valley is, for all practical purposes, Egypt. The modern town of Cairo stands at the head of the delta. This delta is about the size of Wales; it extends along the coast for 150 miles, and it is intersected by many sluggish streams. A little to the west of the delta is Alexandria, the chief port of Egypt, and for 1000 years its capital. A few miles south of Cairo stood Memphis, the much older Egyptian capital, founded 4000 years before Alexandria; and near Memphis are the famous pyramids. The town of Assuan is at the first Nile cataract, and between Cairo and Assuan are the villages of Karnak and Luxor, where are the ruins of Thebes, the capital of Egypt in rather later times (fig. 2).

For the most part, Africa is separated from Asia by the Red Sea, but the isthmus east of the Nile delta forms a connecting land-link. From time immemorial there has been a caravan route along the coast into Palestine, and there is a second road via Suez and Akaba, towns at the extremities of the two Red Sea arms which embrace the mountainous district of Sinai. These two roads lead into Asia through Palestine and Syria, two neighbouring countries which form a narrow fertile belt between the sea and the virtually impassable Syrian desert. For thousands of years Syria and Palestine formed the highway of invading and retreating armies between Asia and Egypt. Damascus was an early capital of Syria, and Antioch a later capital. Damascus

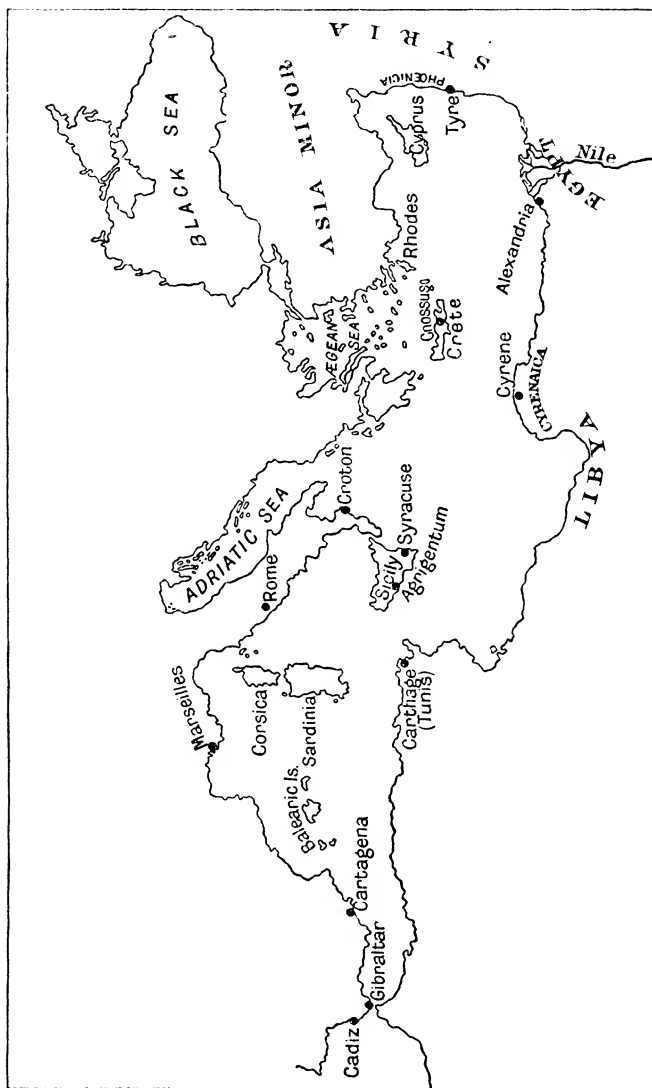

Fig. 1.—Sketch map of the Mediterranean

and Aleppo were great trading centres on the caravan routes (fig. 2).

In the ancient history of S.W. Asia, the geographical centre of interest is another great river valley, that of the Euphrates and Tigris. These two rivers rise near each other in western Armenia, diverge widely, approach at the Bagdad "waist", diverge again, eventually join, and then flow as a single stream into the Persian Gulf. Above the waist, the country "between the rivers" is known as Mesopotamia, a name which signifies the fact literally, and below the waist is Babylonia. Babylon, the former capital of Babylonia, stood on the Euphrates. But the names, Mesopotamia and Babylonia, should be regarded as geographical expressions denoting rather indeterminate and variable areas. In ancient days, empires rose and empires fell in this part of the world, and boundaries changed frequently (fig. 2).

One important thing to notice is the broad and extensive fertile plain between and about the two rivers, the natural wealth of which was the envy of neighbours for hundreds, even thousands, of years. The plain is hemmed in on the west by desert lands, and adventurers into Egypt always had to travel via the Aleppo and Antioch angle. To the east of the great river plain lies range upon range of high mountains, and the fierce Highlanders who inhabited this mountainous area often invaded their western neighbours, and empires not infrequently changed hands. Assyria (capital, Nineveh), a daughter of Babylonia, lies to the north-east, and Elam (principal city, Susa) to the east. Rather more remote is Media (capital, Ecbatana), and then Parthia. To the south-east lies ancient Persia (capital, Persepolis). It is thought that the inhabitants of all these districts came originally from the great plateau of Iran, 5000 or 6000 feet in height, lying between the Caspian and the Arabian seas (fig. 2).

Phœnicia, nominally a province of Syria, was a coastal strip between the Lebanon range and the sea, north of Palestine, about 120 miles long and 10 or 12 miles wide, a strip comparable to a strip from Dover to Portsmouth, in area

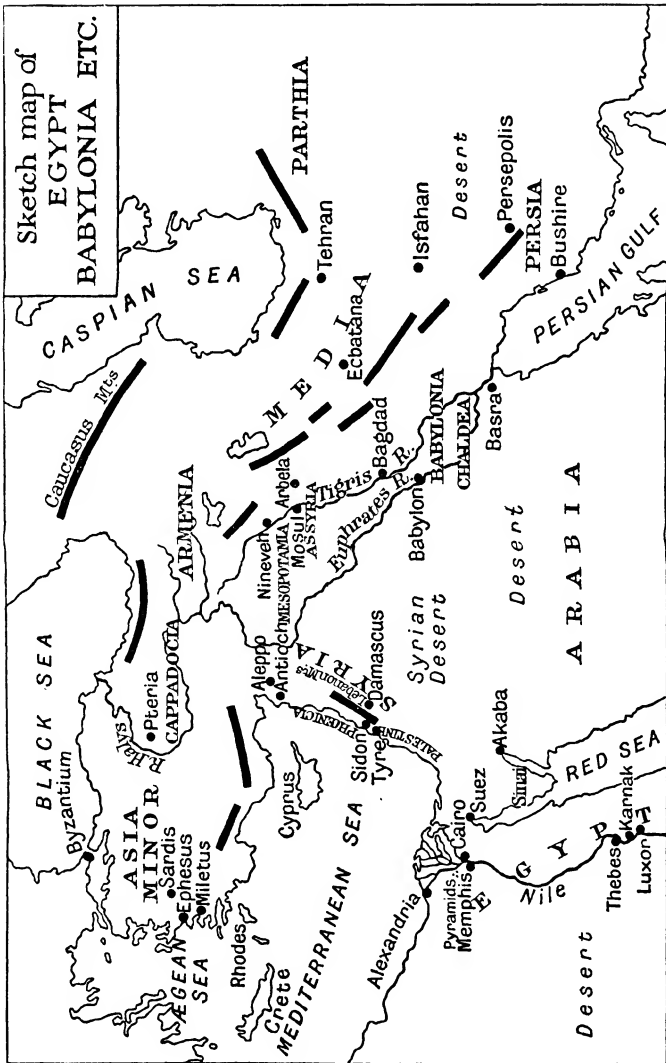

Fig. 2

equal to Kent. Tyre and Sidon were two of its ports.

Cappadocia (capital, Pteria (Boghaz Keui), east of the river Halys) was a country in the east of Asia Minor, north of Syria and west of Armenia. It was the land of the Hittites.

The normal route from Mesopotamian countries to Europe



Fig. 3.—Map of the Ægean

was through Asia Minor and across the Hellespont, which at Abydos is only one mile wide. Xerxes travelled this way with his Persian army when he invaded Greece, skirting the Thracian and Macedonian shores of the Ægean (fig. 3).

The west coast of Asia Minor is of special interest because it was colonized by the Greeks. The strip of coast and the neighbouring islands consisted of three distinct parts: Ionia in the middle, Æolis in the north, and Doris to the south.

Needless to say, these colonists did not always find very friendly the mainland peoples whose shores they had made their own. The inland town of Sardis (capital of ancient Lydia) should be noted; also the coast towns of Miletus, Ephesus, and Halicarnassus, as well as Ilium (Troy) near the mouth of the Hellespont; also the coastal islands Lesbos (and its city Mytilene), Chios, Samos, Cos, and Rhodes. Eubœa (close to the Greek coast), Thasos, and Lemnos, are other important islands in the Ægean, and Cnossus, the ancient capital of Crete is of the greatest prehistoric importance. On the mainland of Greece (which the Greeks themselves called Hellas) the historic cities of Sparta, Athens, Thebes, and Corinth, should be noted; also the prehistoric cities of Mycenæ and Tiryns (fig. 3).

The Phœnicians were bold and enterprising sailors. They founded Carthage on the African coast, Massilia (Marseilles), Gades (Cadiz) beyond Gibraltar, and 2000 miles away from their homes; and they are said to have visited Britain, probably several hundreds of years before Cæsar crossed from Gaul. The Phœnicians were very secretive, and kept their discoveries to themselves. The Greeks were less enterprising at sea, though they felt their way round the coasts; they established colonies at Cyrene on the African coast, Syracuse and other places in Sicily, and on the coasts of Italy and elsewhere.

The 15 "Early Maps" comprising Set VII of the Pictorial Postcards, published by the British Museum, will be found of special interest. The first is a map of the world drawn at Alexandria before 140 A.D. by Claudius Ptolemæus.

BOOKS FOR REFERENCE:

1. *Classical Geography*, H. F. Tozer.
2. *Historischer Handatlas*, G. Droysen.

CHAPTER II

Early Civilizations: Historical Summary

It may be a million years, it may be more, since rationality first dawned in our ancestors, and there is little doubt that for hundreds of thousands of years afterwards progress was exceedingly slow. But the time came when primitive man had learnt to make a fire, to talk, to make simple defensive weapons, to skin animals and to use their skins for coverings, and gradually he seems to have made his way into most parts of the habitable world. Columbus found him still in America in 1492, and he is with us even now in parts of Africa and Australia.

In some places, for instance in the region of the Pyrenees, Palæolithic man eventually made relatively great progress. His pictures show that, for example, his women folk wore well-cut skirts. His painted designs on the walls of rock shelters and caverns display extraordinary skill and resource. Many of these were executed on the ceilings of inner vaults and galleries where the light of day had never penetrated. Nowhere is there any trace of smoke, and good progress in the art of artificial illumination must have been made. To science this is a great puzzle: how was it done?

It may be 50,000, it may be 100,000, years since darkness closed down on the Palæolithic age, and it may be 20,000 since it rose again and the Neolithic age was revealed. What had happened during that long night? We do not know, except that the Old Stone man had gone and the New Stone man had come.

The first thing that strikes us about Neolithic man is

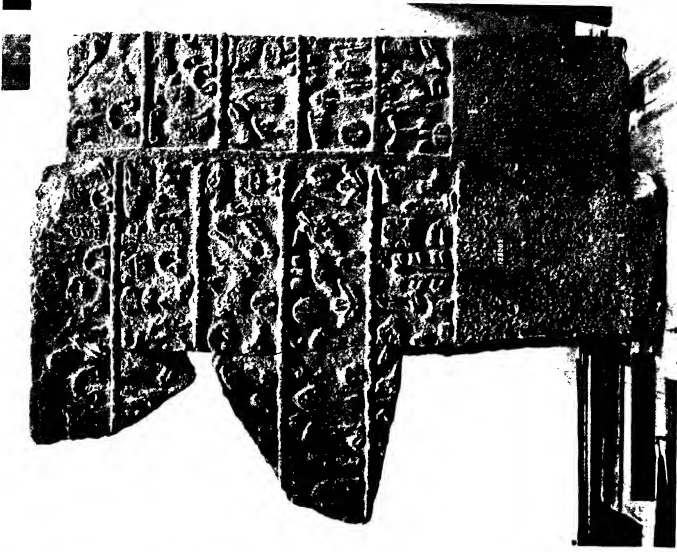

Hittite Inscription
British Museum

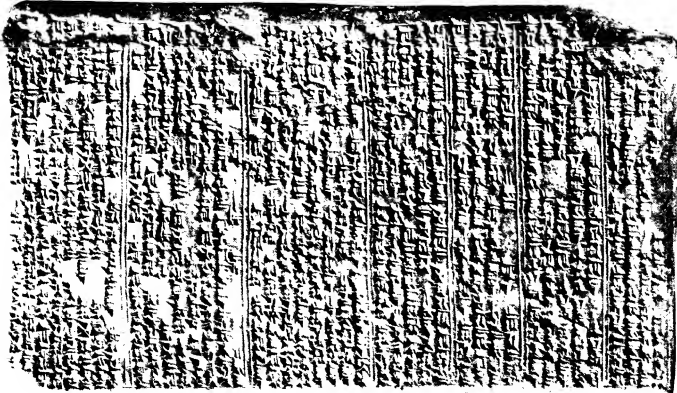

Letter from Tushratta, King of Mitanni, to
Amenophis III of Egypt about 1450 B.C.

his enormous leap forward since the Palæolithic age. He is far, far nearer to our own times than he is to his old-stone ancestors. During the long unknown period between the two ages, he had learnt to do a thousand things and to do them well. He had become a skilled agriculturist. He had tamed the domestic animals. He was versed in the fundamental arts of spinning and weaving. He was a highly skilful potter. He was a builder and an architect. He had developed inventions and arts which have gone on spreading in countless varieties ever since. He was no longer the wild huntsman of Palæolithic times; he had settled down into communities. He had established forms of government. But he had not yet discovered metals, and his best weapon of defence was the polished stone axe, keen-edged, and beautifully made, incomparably superior to the chipped thing of his ancestors. But the javelin and the battle-axe had still to come.

It is reasonably certain that Neolithic culture was already firmly established in the Nile and Euphrates valleys and in Crete 8000 or 10,000 years ago.

The Neolithic age passes insensibly into the Bronze age, perhaps at about 6000 or 5000 B.C., and that again into the Iron age, perhaps at about 1500 B.C.

Whence do we obtain evidence of the Neolithic age? History depends on written records of some kind, and writing is an art of relatively late invention. For records of the Neolithic age we depend largely on archæology, aided by geology and palæontology. For several decades archæologists have been exploring early sites, in many cases huge stratified mounds; unearthing buried buildings; opening tombs; examining relics; and thus they have been able to reconstitute the successive stages of former civilizations, the existence of which was almost unsuspected fifty years ago. Archæology has been continually checking, supplementing, illustrating, and correcting written history.

Discoveries of the Palæolithic age have been comparatively few; of the Neolithic age, many and varied; of the Bronze age, prolific indeed. Sculpture, pottery, jewellery,

furniture, metal utensils, from ancient tombs and from sites of ancient cities, have taught us much. Inscriptions and written records on rock or clay or papyrus roll have been deciphered and their data compared with evidence from other sources. See Plate 2.

Alphabetic writing emerges in recognizable form about 1000 B.C., but the simplicity was the result of many centuries, perhaps of millenia, of complicated signs and scripts. A tremendous advance was made from the practice of using a picture to represent some idea associated with the object depicted, to that of representing a sound. Ultimately, a phonetic system was introduced, in which a certain picture stands for the sound of each syllable of a name. The final analysis of sounds which reduces the multitude of syllables into some twenty-five elementary sounds was a further tremendous step, and the Egyptians made such an analysis before the dawn of history proper, though they did not give up the older method of picture writing.

The wedge-shaped writing first used by the early Babylonians was originally a picture writing, of which the pictures were made up of a number of wedge-shaped impressions on soft clay which was afterwards baked. Later the pictures became patterns, and the signs came to represent syllables but not letters. At the beginning of their historic period the Babylonians had introduced a most elaborate system of syllabics.

The interpretation of the Egyptian hieroglyphics and Babylonian cuneiform writing (Lat. *cuneus*, wedge) has added greatly to our knowledge in recent years of the ancient civilizations.

Some of the peoples of the ancient civilizations were gradually attracted towards the Mediterranean shores, and eventually we find that there were three great centres of rapid progress, namely, in the Nile and Euphrates valleys and in Crete. The rise and fall of Egypt, the rise and fall of the succession of empires in the Babylonian region, and the rise and fall of Crete, mark the first great stage of history. The second great stage—

the rise of Greece and later the rise of Rome—followed at once. Then came the third—the clash between the weakening peoples of the Mediterranean and the more vigorous peoples of central Europe, and the eventual settling down of the modern world. Time after time a ruder and less civilized people overwhelmed an older civilization, but the ruder conquerors usually assimilated something of the civilization they overwhelmed and eventually took their turn as world leaders. The successive supremacies—Babylonian, Assyrian, Persian, Greek, Roman—all left behind them valuable legacies for their successors.

✓ Egypt.

Until conquered by the Persians, Egypt was rather isolated. During the 900 years since Hastings, England has had a succession of five ruling dynasties; during the 4000 years from the establishment of the Egyptian capital of Memphis to the time when Alexander seized the country, there were thirty-one dynasties, and these form fairly well attested landmarks in Egyptian history. The 4000 years in Egypt before the Christian era was essentially a civilization of the Bronze period, though there must have been an advanced stage of Neolithic culture at least as far back as 6000 B.C. When Memphis was founded by Menes, the first king of the first dynasty, in 4400 B.C., copper workers and gold workers were already showing great skill; so were the carvers of alabaster vessels; and beautiful work in inlaid ivory and ebony was being turned out. By 3800 B.C., the great stepped pyramid and the great sphinx of Ghizeh had been built, and obviously a very high level of technical skill in building had been reached. It is an impressive fact that the time gap between the pyramid-builders and Homer (800 B.C.) is as great as between Homer and ourselves. It is the remarkable skill shown by the pyramid-builders that compels us to believe that there must have been in Egypt a long preceding period of advanced preparatory culture. At a later period Egypt fell a prey to her neighbours time after time: first to the Hyksos,

a thousand years later to the Persians, then to Alexander, then to the Romans; and, later, to Islam. Alexander drove out the Persians in 332 B.C., and at his death his general Ptolemy became the ruler and founder of a new dynasty. The Roman conquest took place in 30 B.C. Alexandria, founded by Alexander himself, was the great centre of activity during the time of the Ptolemies. It was not only a great port but for a long time the greatest educational centre of the world.

Iron seems to have been known in Egypt as far back as the first dynasty, but it was not much used. Copper was used for a long time, though for cutting purposes it was inferior to the old sharp-edged flints; it was too soft. When, where, and by whom tin was first added to copper to make bronze, we do not know. It *may* have been a lucky accident; if so, it was an accident which led to a tremendous leap forward in civilization. But it *may* have been the result of repetitional experiments, by some skilful craftsman, Egyptian or other, though, if so, it is more probable that the craftsman was working empirically rather than according to any formulated hypothesis. This important early chapter of science is unknown to us. The Egyptians also engaged seriously in astronomical observations, but in this respect they seem to have been outrivalled by the Babylonians. It is as *builders* and *measurers* that the early Egyptians claim the attention of modern science. They seem to have known little or nothing of geometry as a branch of formal mathematics, but they were great masters of practical mensuration.

Another unrevealed Egyptian secret is the first making of glass. The production of porcelain was an art which grew out of a knowledge not only of pottery but of glass and glaze, and this seems to be traceable to a date as far back as 3500 B.C. The discoveries, in 1922, in the shrine of the tomb of King Tutankhamen (1400 B.C.), included some panels of beautiful blue glaze, scarabs of rare colours, and a host of objects of the finest and daintiest craftsmanship. What a secret from science is the origin of all these things!

Babylonia.

Somewhat later than in Egypt, a remarkable civilization arose in Babylonia. It was characterized by great progress in practical, legal, and commercial matters, and at the same time it was devoted to the belief that human destiny might be read in the stars. The Babylonians' extraordinary skill in the study of celestial bodies furnished the data which in the hands of the Greeks became the foundations of astronomy. Thales' prediction of an eclipse was certainly based on Babylonian observations. The entire Babylonian law code, which was put together in 2100 B.C., has been discovered, and it is clear that Babylonian life was organized under a highly developed legal system. The earliest surviving written records go back to perhaps 3500 B.C. The city of Babylon was by far the greatest capital city of the world for a very long period.

Assyria, a Babylonian colony on the north east, gave its parent much trouble almost from the start, and eventually became master (750-606). Its own great capital, Nineveh, was the home of a famous library. The Chaldeans of Babylon came into their own again for a period (606-539)

Persia followed in building up a great empire which included Babylonia and Assyria, but it found Greece (490) much too hard a nut to crack, and it was conquered by Alexander in 334.

Crete.

The prehistoric archæology of the Ægean begins with Schliemann's attempt in 1872-4 to find Homer's Troy. In 1876 Schliemann passed over to the Greek mainland, and at Mycenæ and Tiryns in South Greece he found any amount of evidence of a very old civilization, totally un-Hellenic. The splendour of Mycenæ belonged exclusively to the later Bronze age, and in 1900 Sir Arthur Evans discovered that the birthplace and the chief home of this culture had been in Crete.

It soon became evident that there had been a widespread advanced Neolithic culture in the islands of the Ægean and on the Greek mainland, and possibly on the shores of the Mediterranean generally, a culture which, perhaps, progressed rather slowly until the discovery of bronze. This culture has been appropriately called "Minoan", after a legendary king of Crete.

According to Sir Arthur Evans, the Minoan age includes the whole of the Bronze age, and the early Minoan period was contemporary with the early dynasties of Egypt. But Cretan development was cut short. Apparently some great catastrophe took place about 1350 B.C.; the wonderful palace at the Cretan capital, Cnossus, was destroyed, and the civilization was overwhelmed. The successive invasions of Greece by hordes from the north and the east certainly overwhelmed Greece then or a little later, and afterwards the Ægean islands as well, and the invaders were probably responsible for the general destruction.

It is believed that Cretan culture was indigenous and had grown up there from immemorial times, though it is true that extraneous influences from the Nile and from Asia Minor operated from a remote period. The hill of Cnossus, with its stratified human deposits, tells a story of 10,000 or 12,000 years. But even the earliest stratum shows the culture in an advanced stage, with carefully ground and polished axes and finely burnished pottery. The beginning of Cretan Neolithic must therefore go back to still more remote antiquity.

The recently discovered achievements of this civilization are remarkable indeed. The Minoan priest-kings, by the ingenious planning of their lofty palaces, story after story, by their successful combination of the useful with the beautiful and stately, by their scientific sanitary arrangements, far outdid the similar works of Egypt and Babylonia. As builders and sanitary engineers, the Cretans showed the most amazing skill. They also developed new and original crafts, for instance, inlaid metal-work never yet surpassed. Moreover,

wonderful artistic skill was shown. Domestic arrangements were most elaborate. Women's clothing was beautifully cut and finished, the flowing drapery suggesting first-class dress-makers rivalling those of the present day. We are able to trace a complete system of writing, from its earliest pictographic shape, through the conventionalized hieroglyphic, to a linear stage of great perfection.

Did science play any part in the development of this early civilization? We do not know. But of the astonishing skill of the Cretan architects, builders, and craftsmen we have the most abundant evidence, and it is exceedingly difficult to believe that all this work was carried out by mere rule of thumb.

Phœnicia.

We seem to get a glimpse of science in the early history of Phœnicia. This small country had already had a long history, but it made its greatest strides on recovering its independence from Egypt about 1400 B.C. The fall of Cretan sea-power left the whole Mediterranean to the enterprising Phœnician sailors, who were great shipbuilders and whose maritime trade extended afar. They seized the isle of Thasos in the north Ægean and mined its gold; they obtained copper from Ceylon; they fetched tin from Britain. In short, they seem to have been efficient metallurgists. They manufactured Tyrian purple (the city of Tyre is frequently mentioned in the Bible), a famous dye bringing them much wealth because of the great demand for it in connexion with priestly and imperial ceremonial; it was obtained from a shellfish on the Mediterranean shores. Did they know something about chemistry? How did they learn the art of shipbuilding?

Greece.

The wonderful Minoan civilization in Greece, as exemplified in so marked a way in such recovered cities as Mycenæ and Tiryns, was overwhelmed about 1300-1250 by

invading hordes of Achæan "horse-tamers" from the north. They conquered Greece, Crete, and the Ægean islands, and settled down, destroying much, but nevertheless absorbing a great deal from the civilization they overwhelmed. The Trojan war (1194-84) was a war between the Achæans of Greece and the Phrygians of Asia Minor, arising from an act of piracy at Sparta. About 1100 there was another invasion of Greece, this time by Dorians, also from the north. (We are reminded of the successive invasions of Britain by the Saxons, Danes, and Normans.) For centuries the peninsula was paralysed by feuds between the two races. Refugees colonized the coasts of Asia Minor, Ionia in the centre, Æolis in the north, and Doris in the south. The outstanding fact of these centuries is that the Minoan age sank suddenly. Elaborate Minoan dress gave way to a mere blanket, fastened with safety-pins. Bronze is gradually superseded by iron.

The Greeks of history are the products of the fusion. Like ourselves they are a hybrid stock. Much was lost by the overthrow of the Minoan civilization, but the ultimate gain from the fusion of the different stocks was incomparably greater than the loss.

During the Bronze age, Greece was remarkably rich in gold, as the sensational finds at Mycenæ readily testify. Homer has many lines reminiscent of the riches of Mycenæ but he himself does not seem to have lived in times of such abundance. In the early Iron age gold was even rarer, as is seen by the astonishment of the Greeks at the royal wealth of a man like Cræsus. Macedonia also seems to have worked a little gold in early times, as is seen from gold slags found on various sites. There were also many early silver mines in the Taurus and other places. Copper was certainly found in Mycenæ, and the prehistoric copper mines of western Crete were reopened in Hellenistic times and continued until the Middle Ages.

Hellenic culture was not, as classical scholars used to think, "a wonder-child which sprang, like Athena herself,

fully panoplied from the head of Zeus". It took its birth in prehistoric Crete, from which it derived its high efficiency in almost all departments of human art and industry. The best of the traditions of Cretan culture survived, and formed the basis of future Hellenic culture.

The history of Greece is largely the history of rival city states, of jealousy, of treachery, of civil wars. The cities of Athens, Sparta, and Thebes, each had a season in the sun, and each in its turn was crushed. "The glory that was Greece" began to fade, and at this critical time a new power began to rise in the neighbouring state to the north. The Macedonians were closely akin to the Greeks, and their kings claimed Greek descent. Philip invaded Greece, and, speedily getting the upper hand, formed an alliance with the Greeks for a war with Persia. His son Alexander ("the Great"), comparable with such world figures as Cæsar, Mahommed, Charlemagne, and Napoleon, spread Greek civilization by the sword practically all over the known world. On the throne at twenty, his life was closed at thirty-three. He reflected the true genius of Greece by his incessant search for new knowledge. His successors held the ground until the Romans in their turn set up an even greater world dominion than Alexander had done.

Round about the years 450-400 B.C. Greece reached its golden age. Athens is then the great centre of a great picture. Never in the world's history has there been such a rapid succession of famous men—statesmen, writers, philosophers, builders, sculptors—prominent Greeks all certain of a place in history as long as history lasts. It was now that science really took its birth: we shall refer to this again.

Rome.

At the end of the Minoan age, say 1200 B.C., the political and economic conditions of Italy and Sicily were hardly in advance of those in the Ægean 2000 years before. The wants of the peasants were few and easily provided, and nothing was to be gained by co-operation. Everything remained

stationary. Whence and when the "Italic" speaking peoples of the lowland plains of south Italy came is a matter of conjecture. The clans were not closely associated and they lived in scattered settlements. But migrants from Asia Minor seem to have set up some sort of an empire west of the Apennines and between the Arno and Tiber rivers about 1100 B.C. The name given to this area was Etruria, and certainly the Etruscans were of far greater antiquity than the Romans. Etruria was an empire when Rome was still one of hundreds of insignificant "cities" in her dominions.

Emigrants from Greece and probably from Asia Minor seem to have settled on the shores of Italy and Sicily from the time of the Trojan war onwards, and one part of the "broad" (*latus*) flatland on the coast of Italy gave its name to Latium and to its people, the Latini; and across the northern corner of the flatland ran the yellow Tiber. Some fifteen miles up-stream was a low isolated hill, the Palatine, commanding a ford-like crossing into Etruria. Here Rome was born, tradition says, in 753 B.C. By this time, Sparta, the chief Dorian camp in Greece, had already settled down and was engaged in wars of conquest.

How Rome eventually became mistress of the world is a matter of well-known history. She reached her golden age at the beginning of the Christian era; she showed signs of decay during the second century A.D.; and eventually she was overwhelmed by the more vigorous peoples from the north and north-east.

The Romans were not, by a very long way, the intellectual equals of the Greeks, but they were far more practical. They were eminently a common-sense people, not unlike ourselves. Science owes them little, as we shall see.

Like the Greeks, the Romans were a hybrid race, though of a different ancestral fusion. They appropriated the heritage which Greece had received from Minoan civilization, but as the centuries went on, the civilization was placed on a much broader basis, by the welding together of many heterogeneous elements.

Evidence from Archæology and from History.

Until comparatively recent times, it was the custom of historians to think of history, as Freeman did, merely as past politics, or as a record with a strong bias of some kind, it might be in favour of a particular party, of a particular church, or of a particular royal personage. It rarely occurred to them to write coldly and impartially, to supply the main facts, pro and con, from which readers themselves might form a judgment. They wrote as the popular press of to-day writes; they suppressed facts unfavourable to the cause they advocated, and the facts that were favourable they attractively coloured. The present-day historian dares not pursue such a course; his critics would be many and ruthless. Nevertheless he often has great difficulty in arriving at the truth when he has to depend for his facts on his predecessors of a bygone age. Moreover, a large proportion of the facts necessary for the real understanding of the past have never been recorded and are unknown. To the student of science, nothing is of greater importance than a knowledge (i) of the conquest of material resources by means of new tools, implements, machinery, and other devices, and (ii) of the industrial, social, political, artistic, and religious consequences of such a conquest. Yet at one time historians would devote page after page to the doings of a ruffianly baronage, and not spare even a line for such far-reaching inventions as gunpowder, the mariners' compass, and printing. Even in more modern days some of them do not seem to realize that the external and internal combustion engines are as truly the great symbols of power in the present age as were the flint hatchets in the stone age. The recovery of the past is demanding a new type of historian, and happily he is forthcoming.

For the facts of ancient history we have to depend in large measure on Herodotus. That his testimony is sometimes to be questioned may be seen from his statement that, when Xerxes invaded Greece, over 5,000,000 men accom-

panied him to Thermopylæ. That this number is grossly exaggerated, the simplest arithmetic applied to the local conditions of the time shows at once, as all present-day historians readily recognize. Five millions of men and all their impedimenta on a single march through an almost roadless country and living on the small villages they passed through! Our confidence in such an historian is inevitably shaken.

Now contrast this with an entirely different type of evidence, from archæological records. A treaty between Rameses II of Egypt (1345 B.C.) and the Hittites has long been known from deciphered Egyptian records. Recently, the old capital of the Hittites, Pteria (Boghaz Keui), has been unearthed, and cuneiform records of the draft of the same treaty have been discovered. Thus we have in stone, at two places 1500 miles apart, records of the same event made in different languages by two nations. The records when interpreted are essentially identical.

During the last thirty years the work of archæologists has been wonderfully fruitful. Agreement among them is common, and inasmuch as their researches are essentially scientific—every scrap of evidence is scrupulously examined—the results may be accepted as at least of equal value with many of the records of the ancient historians.

The student of science may profitably place the main facts of the history of his subject in a true perspective setting, chronologically. When he reads a textbook of English history and finds only about one-tenth of the available space devoted to the first half of the chronological record, he is apt to forget that history was as much in the making during those first thousand years as during the second. An accurately spaced time-line is a good corrective:

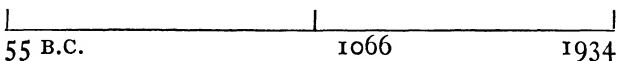

That we do not know many of the facts of the first thousand years must be admitted, but that these facts can have been

	EGYPT	BABYLONIA	MEDITERRANEAN
	Advanced Civilization: passing from Neolithic to Bronze Age		
B.C. 4500	MEMPHIS <i>f?</i>	BABYLON <i>f?</i>	CNOSSUS <i>f?</i>
" 4000	Pyramids built	Babylonia a powerful Empire.	
" 3500	THEBES <i>f?</i>		
" 3000	Great progress in arts (glass, metal, &c.).	NINEVEH <i>f?</i>	
" 2500	Hyksos invasion.	Hammurabi: a united Babylon.	GOLDEN AGE OF CRETE.
" 2000	Hyksos expelled.	Abraham (Bible).	
" 1500	Egypt very powerful. Luxor. Exodus of Hebrews.	Babylonian struggle with Assyria.	PHENICIA powerful. Mycenæ in civilization in Greece. Greece and Crete overwhelmed. Trojan War.
" 1000	Decline of Egypt.	Solomon (Bible). Assyrian conquest. Nineveh destroyed.	Homer. ROME <i>f?</i>
" 500	Persian conquest. Alexander's conquest. Roman conquest.	Persian conquest. Alexander's conquest. Roman conquest.	Persia defeated by Greece. GOLDEN AGE OF GREECE. Italy settled. Alexander the leader in Greece. Carthage destroyed.
B.C.-A.D.			GOLDEN AGE OF ROME.
A.D. 500			ROME overwhelmed.

fraught with less far-reaching consequences than those of the next thousand years must be denied.

The child gleans from his Bible that the first fixed point in history was 4004 B.C., assigned as the date of the creation. We now know that this represents about the time when the Egyptian calendar was settled, some 3000 years before the Trojan war and before the time of the Jewish King Solomon. By that time (4000 B.C.), both Egypt and Babylonia and Crete were in a comparatively advanced state of civilization. The famous capitals, Memphis, Babylon, and Cnossus, were in being, and they were capitals indeed.

A few outstanding dates of early events should be committed to memory. The main facts of history will then fall into a proper perspective. The reader might well design for himself a little chart, based on a correct time-line, something like the one on the previous page.

BOOKS FOR REFERENCE:

1. *Historians' History of the World*, Vols. I, II.
2. *Palace of Minos at Knossos*, Sir A. Evans.
3. *Mycenæ*, H. Schliemann.
4. *Ægean Archæology*, H. R. Hall.
5. *Crete, the Forerunner of Greece*, C. and H. Hawes.

CHAPTER III

Babylonian Astronomy

Even primitive man must have been familiar with the apparent revolution of the sun round the earth and with the periodical recurrence of the phases of the moon, and he must therefore have been able to measure off his time in *days* and *months*. And he must have had some idea of the length of a year, though he would have gleaned that from recurring seasons and from the succession of his crops, rather than from astronomical observations. The *week* came later, when he felt the need of allocating seven days, in turn, to ceremonial associated with the sun, moon, and the five planets he had already discovered.

Gradually his interest in the heavenly bodies would be extended. On the extensive Euphrates-Tigris plains, star-gazing by the Chaldæan shepherd nomads became almost proverbial. Babylonian records from as early as 3800 B.C. imply that even then the varying aspects of the sky had long been under expert observation. The temple towers made excellent observatories. The stars were grouped as we know them now at least as early as 2800 B.C. It was early discovered that the sun pursued amongst the stars practically the same path as the moon and planets; and this path was divided into 30° divisions among the belt of twelve constellations forming the Zodiac. The advantage of the easily factorizable number, 360, was evidently recognized.

During the hundreds, perhaps thousands, of years of observations and the careful making of records, various important astronomical cycles were discovered, for example, the time of revolution of the sun and hence the length of the

year; and the times of revolution of the five known planets. But more than this, they discovered the Saros cycle of 223 lunar months (18 years 11·3 days, or 6585 days), the period during which the sun, moon, and earth, make a complete cycle of movements with respect to one another. During this period there is thus a certain definite number of eclipses of the sun and the moon. Hence, if eclipses are recorded during one period of the cycle, they can be exactly predicted for any future period. The Chaldæans could not predict eclipses to the minute, as modern astronomers can, but they could do it to within an hour or so. And all from naked-eye observations! Think of the patient labour, systematized over centuries! Did they *expect* a periodical recurrence, and tabulate their records in such a way as to discover it? or did they hit upon it by chance?

But, more than this, the Babylonians were apparently aware of the precession of the equinoxes. If an ordinary spinning-top be watched when it begins to “die”, it is seen to “wobble”. Its axis no longer remains vertical but describes an inverted cone. So it is with the earth’s axis, which, wobbling about its mid-point, describes a pair of cones, apex to apex. The earth’s axis is not “vertical”, that is, it is not perpendicular to the plane of the ecliptic; it makes an angle of $23\frac{1}{2}$ degrees with the vertical, and it now points very nearly to the so-called Pole star. But, owing to the wobbling, instead of always pointing in the same direction, it describes among the constellations a circle, like the axis of the spinning-top. This circle has a radius of $23\frac{1}{2}$ degrees, the axial inclination of $23\frac{1}{2}$ degrees to the vertical being constant.

Both the “vertical” and the inclined axis are axes of two great circles, the ecliptic and the equator, respectively. These intersect at opposite points, like two equal hoops, one thrust half-way through the other, the angle between the planes being, of course, $23\frac{1}{2}$ degrees. The intersecting points are usefully called equinoxes. If the earth’s axis remained parallel to itself, the equinoxes would remain fixed. In point of fact they are moving backwards (hence the term pre-



ARISTOTLE



THEOPHRASTUS



ARCHIMEDES



HIPPOCRATES
From a Bust in the British Museum

cession), and the vernal equinox, once at the first point of Aries, has moved back to a point in Pisces. The cycle of the complete precession amounts to 26,000 years. But although the Chaldæans were apparently aware of the *fact* of the precession, they evidently did not understand its significance. The knowledge they had acquired implies patient, systematic, accurate, and intelligent observation extending over a long period of years. The *explanation* of the precession was given by Hipparchus, a long time afterwards.

We have no evidence that the Babylonians formulated any sort of theory of celestial motions. They seem to have made no scientific analysis of their observations. They had no hypotheses. They engaged in *observation*; they made records; they noted regularities; they framed laws. Their records made an easy jumping-off ground for the Greeks. They had no instruments, though they invented a water clock (clepsydra) and they used a sundial.

Before the reader condemns the Babylonians for not making a greater advance, let him ask himself (if he is not a trained astronomer) how, for example, he would determine the length of the solar year. How would he determine the odd quarter of a day (or rather 5 hours 48 minutes) in the $365\frac{1}{4}$ days? Let him not refer to books but think out the problem for himself. The Babylonians did it, and they had no instruments of any kind. Or a much simpler problem: how would he determine the sun's path among the stars? The sun and the stars are never seen together, except during eclipses. The Chaldæans probably did it by a systematic observation of the last conspicuous star to rise just before the sun. But let the reader face the problem for himself.

Quite intelligent people have never yet discovered how easy it is to tell the approximate time on a starlight night, merely by noting the amount of revolution of prominent stars or constellations. Leave the house, say, at eight o'clock, and note a star exactly due north. Where will the star be at, say, eleven o'clock? How familiar some of Hardy's humble Wessex folk were with such facts! Perhaps the reader sits all

day long in his library with a window facing south. From morn till eve all the year round the shadow of a vertical stile of his window travels round the room and records the position of the sun: it is a good working sun-dial. Has he ever noted the positions of the shadows for future reference? The systematic and accurate observation of the Chaldæans puts most of us to shame.

The Chaldæan priests used their knowledge for base purposes. By their occasional accurate forecasts of happenings in the sky, made from their knowledge of periodical cycles, it was an easy thing to induce the simple-minded peasantry to believe that the sun, the moon, and the planets were gods to be feared, worshipped, and conciliated by presents—a simple way of eking out the priestly incomes. The survival of their astrology, even to the present day (it may take the more modern forms of phrenology or palmistry), is a reflection both on the gullibility of not a small section of the populace and on the chicanery of individuals who know, none better than themselves, that the “art” they profess to practise is deliberately fraudulent and a sham.

BOOKS FOR REFERENCE:

1. *Babylonian Life and History*, E. A. W. Budge.
2. *The Civilization of Babylonia and Assyria*, M. Jastrow.
3. *Early Babylonian History*, H. Ruden.
4. *Fresh Light from the Ancient Monuments*, A. H. Sayce.
5. *Cuneiform Inscriptions of W. Asia*, H. C. Rawlinson.
6. *The Ancient Cities of Irak*, D. Mackay.
7. *Ancient History of the Near East*, H. R. Hall.

CHAPTER IV

Égyptian Mathematics

Our most important source of information in regard to early Egyptian mathematics is a hieratic papyrus forming part of the Rhind collection of the British Museum. It was written by a scribe named Ahmes, probably about 1600 B.C., and is itself mainly a copy of a treatise perhaps 1000 years older. "Directions for attaining knowledge of all dark things" are the opening words of the treatise. The text, which has been deciphered, consists of actual problems rather than of principles; answers are given but not as a rule the processes by which they are obtained. Fractions in arithmetic are dealt with; so are formulæ, equations, and progressions in algebra; but the greater part of the treatise is devoted to practical geometry and mensuration. Owing to the periodical Nile floods and the consequential frequent obliteration of the boundaries of estates, the art of practical surveying and measurement was highly developed in very early times. Egyptian geometry was essentially practical. Problems were not systematized; no theoretical scheme of any kind seems to have been built up. It was left to the Greeks to develop a system of deductive geometry.

A more recent discovery, however, the *Moscow Papyrus*, going back to about 2250 B.C., seems to suggest that the Egyptians may have made much greater progress in mathematics than has hitherto been supposed. This papyrus has not yet been published in full, and it is therefore still necessary to suspend judgment.

Egyptian mathematics may be suitably illustrated by

reference to the Great Pyramid of Ghizeh, and to the two problems from the Moscow Papyrus that Sir T. L. Heath has singled out for comment.

The planning of such a colossal building as the Great Pyramid, the perfect finish and the fitting together of the vast number of stones composing it, its transport and its construction, is a tremendous building and engineering achievement. The early Egyptian architects and builders may have had no knowledge of abstract mechanics or geometry, but of their great technical skill the amplest evidence still remains for all the world to see.

The present appearance of the Pyramid is that of a succession of square courses of stone masonry, diminishing from the base upwards, each course consisting of fitted rectangular blocks of uniform thickness. Though fatiguing, it is easily feasible to climb to the top, just as one would ascend a staircase; the 202 surviving steps are, however, of an average height of well over two feet. This stepped appearance does not represent the Pyramid in its original form. Originally, the angles of the steps were all filled in with beautifully fitting outer blocks of casing, and the whole polished. Most of this outer casing has long ago been taken away and used for other purposes by local builders, and even the upper courses of the core masonry have disappeared; the top is now a platform, over thirty feet square. The Pyramid was built on the solid rock, the corners being let into prepared sockets. Around the base was a limestone pavement, over forty feet in width (fig. 4).

The rectangular slabs composing the core were accurately cut to fit, the average size being 40 cubic feet and the weight $2\frac{1}{2}$ tons. But over the king's chamber in the heart of the pyramid are 56 special roofing stones, each weighing 54 tons. All the stones were quarried on the other side of the Nile, cut to exact shape and size, floated down the river, and then probably levered into position up a specially prepared inclined plane. The stones were cut by means of bronze saws eight feet long set with jewels (the bronze itself was not hard

enough); and in the preparation tubular drills and circular saws were also used. The correct cutting of the angular stones for the casing at the corners of the pyramids suggests a sound knowledge of practical geometry.

The pyramid covers $13\frac{1}{4}$ acres; the walk round takes a good quarter of an hour. The height is some 120 feet higher than St. Paul's, or more than three times the height of the Nelson column.

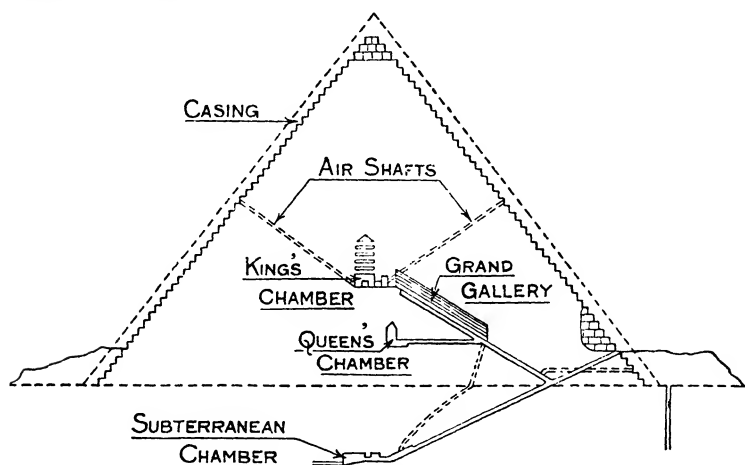

Fig. 4.—Sectional drawing of the Great Pyramid

Flinders Petrie, Piazzzi Smith, Howard Vyse, and others have measured up the pyramid with very great care, and, altogether, years of labour have been devoted to the task. Difficulties have been many, partly because of the disappearance of most of the casing stones, partly because of the worn condition of much of the masonry of the core, especially at the angles, and partly because of the vast accumulation of rubbish round the base.

Taking the mean of the various measurements made, the original length of each side of the base was approximately 9120 inches (760 feet), and the vertical height, 5804 inches (484 feet). The angle of the facial slope to the horizontal

works out to $51^{\circ} 50'$ ($\tan^{-1} \frac{5804}{9120/2} = 51^{\circ} 50'$), and this calculated slope agrees exactly with theodolite determinations of the angle obtained from the aligned edges of the successive steps of core masonry.

An examination of these measurements reveals some interesting results:

1. The *Ratio* of the base edge to the height = $9120/5804 = \frac{11}{7}$ very nearly. Hence the ratio of the semi-perimeter to the height = $\frac{22}{7} = \pi$ (approximately).

2. $9120'' = 760' = 6080'/8 = \frac{1}{8}$ of a geographical mile, or $\frac{1}{8}$ of a degree of latitude. Thus the Egyptians *may* have planned the pyramid with a perimeter of $1/2$ of a degree of latitude in length. Did they know enough about astronomy to be able to measure latitude with this close degree of approximation?

(In Egyptian cubits, the base edge and the height were 440 and 280 cubits, respectively.)

It has been suggested that the Egyptians may have set to work in this way: The theoretical polar cubit is the $1/10,000,000$ th part of the earth's semi-polar axis (7891 miles = 500,500,000 inches); hence the polar cubit = 25.025 inches. Possibly the Egyptians estimated this cubit to be approximately 25 inches. Now $25'' \times 365 = 9125''$ which is very nearly the length of the base edge of the pyramid. Did the Egyptians thus intend the dimensions of the pyramid to be based on the number of days in the year and on the polar cubit? It is very unlikely. The arithmetical approximation is probably due to mere chance. In point of fact, all sorts of "remarkable" arithmetical relations have been "discovered" from the pyramid measurements, some of them almost childish. One author gravely puts forward the view that they definitely foreshadow certain important events in the Biblical narrative, and he writes at great length to prove his thesis.

In the interior of the pyramid, there are two large recesses, the king's and the queen's chambers. The measurements in

cubits of the chambers and of the passages leading to them reveal a far-reaching scheme of proportional planning. Lengths, breadths, heights, diagonals, areas of floors, areas of walls—there is throughout an interdependent ratio simplicity that is more than a little astonishing. The mere positions of the two chambers and the angular directions of the passages leading to them are, in relation to the pyramid as a whole, of particular mathematical interest.

Not the least interesting fact about the pyramid is the correct orientation, north and south, east and west. The most skilful checking has not discovered an error of more than a minute fraction of a degree. And the base is really *square*. There is practically *no* deviation from true right angles. Has the reader himself ever tried to plan out, say, a tennis court? To make quite sure that the angles are exact right angles and the diagonals exactly equal is a really difficult problem. Yet the Egyptians solved it. They probably did not know the theorem of Pythagoras, but they undoubtedly knew the particular case that a triangle with sides in the ratio of 3, 4, and 5 must be right-angled. It was probably the business of the so-called "rope-stretchers" to take a piece of rope, say, 120 feet long, to mark it into lengths of 30', 40' and 50', then to convert it into a triangle, to stretch the sides tight, and thus to provide a huge set-square for setting off perpendiculars. This device is often used even at the present day, though, since a rope tends to stretch, a metal chain is preferable; for instance, 96 of the 100 links of a surveyor's chain, with 24, 32, and 40 links in the three sides of the triangle.

The Moscow Papyrus leads us to question the opinion, which was held until recently, that the Egyptians' knowledge of mathematics was exclusively of a practical nature.

We learn from Archimedes that it was Democritus who first discovered that the volume of a pyramid is equal to $\frac{1}{3}$ of the corresponding prism, but from the Moscow Papyrus it would seem that the discovery was made at least a thousand years earlier. Problem 14 of the papyrus is the more difficult

problem of determining the volume of a *truncated* pyramid, on a square base.

The formula used is quite familiar to the modern school-boy: $V = \frac{1}{3}h(a^2 + ab + b^2)$, where a and b represent the edges of the two square faces, and h the height. We do not expect such a complex formula to be determined empirically. On the other hand, if it had a theoretical basis, how could it have been obtained except by deduction from the formula for the volume of a complete pyramid on a square base, $V = \frac{1}{3}ha^2$? And this minor formula itself is not particularly easy to establish; it is not usually considered by boys until they reach the Sixth Form. The Egyptians *may* have established it empirically; for example, they may have compared the volumes of a prism and a pyramid on equal bases and of equal heights, by filling specially made hollow models with water, corn, or other convenient material. They could hardly have failed then to discover that $\frac{1}{3}ha^2$ represents the volume of the pyramid, at least very approximately. Even so, it is a very big jump to deduce the formula $V = \frac{1}{3}h(a^2 + ab + b^2)$, representing the volume of the frustum, h now representing the difference in the heights of the two pyramids, viz. (1) the small pyramid cut from (2), the main pyramid. This is another piece of mathematical work for capable Sixth Form boys. We are almost bound to infer that the Egyptians knew more about mathematics than has hitherto been thought.

We may now refer briefly to Problem 10 of the Moscow Papyrus, the determination of the area of the surface of a hemisphere. Let the reader forget his school mathematics and try to determine this area for himself. Nay, let him try to solve the much easier problem, to determine the value of π , the ratio of the circumference to the diameter of a circle. Let him devise a *practical* plan of some kind, say by winding thread several times round a cylinder, dividing its ascertained length by the number of turns, and dividing the result by the length of the measured diameter of the cylinder. He may feel much satisfaction if he obtains a value correct to two

decimal places ($3\cdot14$). But he probably won't. Schoolboys often have to "verify" the value of π by a practical plan of this kind, but even the best of them seldom produce a really satisfactory result. Of course the value of π has now been calculated to several hundred decimal places (it is known to be non-terminating and non-recurrent), but the calculation has been made by indirect, not direct, means. The value usually memorized is $3\cdot1416$.

Now, the Egyptians calculated the value of π to be $2^8/3^4 = 256/81 = 3\frac{13}{81} = 3\cdot16$. We deduce this from the Ahmes Papyrus, where the area of a circle is stated to be $(d - \frac{1}{9}d)^2$, d being the diameter of the circle.

The Moscow Papyrus gives for the area of the surface of a hemisphere:

$$\begin{aligned} S &= [2d - \frac{1}{9} \cdot 2d - \frac{1}{9}(2d - \frac{1}{9} \cdot 2d)]d, \\ &= \frac{1}{2}(\frac{256}{81})d^2, \\ &= \frac{1}{2}\pi d^2, \\ &= \text{twice the area of the great circle,} \end{aligned}$$

which is exactly right if we accept the Egyptian value $256/81$ as the value of π .

How such a remarkable result was arrived at we do not know. There seems to be no record of any attempt to determine the surface of a sphere before the time of Archimedes, who was the first to *prove* that the surface of a sphere is equal to four times the area of the plane circle through the centre (four times the area of the great circle).

That the Greeks learned much from the Egyptians we know. That they learned much more from them than we are aware of is highly probable.

BOOKS FOR REFERENCE:

1. *Histories of Egypt*, by (1) W. M. Flinders Petrie; (2) E. A. Wallis Budge; (3) J. H. Breasted.
2. *Life in Ancient Egypt*, A. Erman.
3. *Operations at the Pyramids*, Howard Vyse.
4. *Life and Work at the Great Pyramids*, C. Piazza Smyth.
5. *The Pyramids and Temples of Ghizeh*, W. M. Flinders Petrie.

CHAPTER V

The Genius of the Greeks

The remarkable intellectual achievements of the hybrid race of people which in early historic times had settled down in Greece have always stirred the imagination of the modern world. The complete fusion of the successive hordes of invaders took many hundred years to bring about. Civil wars continued for centuries, and intellectual life was rather slow in its awakening. When at last it did awake it was on the periphery rather than at the centre, in the quieter colonies across the sea rather than on the mainland. Thus we find the first Greek "school" in Ionia—the islands and the coastal strip of western Asia Minor; the second a little later, in the Greek colonies of Sicily and southern Italy. The two famous schools at Athens, the Academy and the Lyceum, were founded later still. Eventually, all the local schools were overshadowed by the world university established at Alexandria. A Greek "school" must not be thought of as a specially erected building with a teaching staff and equipment of the modern type; rather it usually refers to a place where some prominent teacher had arisen, whose original methods and doctrines had attracted attention. That teacher might or might not set up an actual school for teaching purposes; in the main he was the founder of a new school of "thought".

People often wonder why the Greeks were so greatly the intellectual superiors of their predecessors, the Egyptians and the Babylonians. At least two reasons may be put forward as possible explanations. In the first place it is *probable*

that their intellectual gifts were the result of the particular race blend resulting from their hybrid ancestry. In the second place it is *certain* that they were completely free to give full play to their reason. In Babylonia and Egypt, science, such as it was, had been the monopoly of the priests; it thus became involved in routine observances and was used in a collection of lifeless formulæ. Any layman who searched for new knowledge was immediately suspected; he was a potential enemy of priestly privileges. Progress under such conditions was necessarily slow. But the Greeks, fortunately for themselves, had no organized priesthood. They were untrammelled by traditional dogmas or by superstition. They were free to give their reasoning faculties full play, and to create science as a living thing susceptible of development without limit.

There can be no question that the Greeks possessed the love of knowledge for its own sake. "To see things as they really are" was with them an obsession. To give a rational explanation of everything seems to have been almost their chief life-purpose. They were drawn to science, to mathematics, to logic, and to exact reasoning, as keenly as they were to literature and to art. Their methods were often faulty, their conclusions were often absurd; but they had that fearlessness of intellect which is the first condition of seeing truly.

That their methods of investigation were sometimes even a *little crude* need not surprise us at all, for they were first in the field, and they had to grope their way along. All methods they had to invent.

In their power of analysis, they have never been surpassed, and their mathematicians as a group take the foremost place in mathematical history. In their power of synthesis, they do not take a first place or even a second, and, judged by modern standards, their science is of little importance, although there are one or two bright patches. In matters of taste, again they stand first. Contrast the simplicity and the beauty of a Greek temple, with the lavish ornament of

a Gothic cathedral. Greek architecture, Greek statuary, Greek literature, are all singularly free from any sort of violent emphasis. What a contrast with our habitual use of florid language, our habitual exaggeration of small emotions!

Even the greatest of the Greeks appear to us moderns to have made so many mistakes of such an elementary character that we are inclined to castigate them over and over again. And yet again and again we go back to them, recognizing in them something immensely great, something permanent, something of eternal value. Always we find something that we failed to find before. All down the ages the Greeks have been recognized as subtle and profound; no great scholar has ever denied it. That so few of us fully appreciate them must probably be put down to some kind of innate mental deficiency, just as we may be tone deaf to Mozart or Beethoven, or colour blind to Raphael or Rubens.

BOOK FOR REFERENCE: *The Legacy of Greece*, R. W. Livingstone.

CHAPTER VI

The Greek "Schools"

The Ionian School.

The best known of the twelve Ionian cities are Miletus and Ephesus, and the best known of the islands, Samos and Cos.

The Ionian School was founded by **Thales** (624-547 B.C.), who was born at Miletus though he was of Phœnician descent. By profession an engineer, he constructed an embankment for the river Halys in Asia Minor. He went to Egypt and when he returned to Greece he brought back an extensive knowledge of practical geometry, about which he began to think and to theorize, and it is virtually certain that theoretical geometry owes its birth to him. Indeed we may almost say that mathematics, science, and philosophy all owe their birth to Thales and his successors. At this time the three subjects formed a single discipline, an undivided subject of study. Division came with Aristotle. The Ionians were men of science rather than philosophers in the strict sense.

Thales became famous through his prediction of a solar eclipse, but this reputation was probably very lightly won, as he seems to have had access to the Babylonian astronomical records, and his prediction amounted to little more than the working out of a simple arithmetical sum. His real reputation rests on the fact that he was the world's first mathematician. Certain propositions of geometry, with their proofs, afterwards embodied in Euclid, were almost certainly due to him.

The Pythagorean School.

Thales made a start, but the real foundations of mathematics were laid by another Ionian, **Pythagoras** (570-504 B.C.), who was born in Samos. He visited Egypt and Babylonia, and finally settled down at the Greek colony of Croton in southern Italy, where he founded a school of his own. The school was really a secret society, and left no writings. All discoveries were attributed to "the Master", and it is therefore not possible to distinguish the work done by Pythagoras himself from work done by his followers.

There can be no doubt that Pythagoras was a great mathematician. He was the founder of arithmetic. He discovered a great deal concerning the theory of numbers, more especially in connexion with music and geometry; in fact, it became a main tenet of the school that number was the mainspring of the universe. His greatest success, however, was in geometry; every schoolboy knows (or ought to know) "the theorem of Pythagoras", and most schoolboys nowadays have made models of Pythagoras's five "Regular Solids". We shall return to Pythagoras in the next chapter.

The Pythagoreans not only placed mathematics on a scientific basis, but they developed, however vaguely and imperfectly, the idea of a world of physical phenomena governed by physical laws. They also taught that the best and truest purification of the soul was scientific study. This seems to explain the religious note which is characteristic of all Greek science.

Three famous difficult mathematical problems that have come down to us from antiquity are: (1) To determine the edge of a cube twice the volume of a given cube; (2) To trisect an angle; (3) To find the area of a circle.

About a century after the death of Pythagoras, we find **Archytas** (430-361 B.C.) head of the school, and it was he who solved the first of the three problems. His remarkably

ingenious solution has been the admiration of modern mathematicians. It depends on a construction in three dimensions, from which a certain point at the intersection of three surfaces is determined, Sir T. L. Heath gives a workable figure in his books, to which the reader may be referred.

The Eleatic School.

The Eleatic School was so called because its leaders were natives of the Greek colony, Elea, in south Italy. **Parmenides** and his disciple **Zeno*** were the two leaders specially identified with its main principles. In particular, Zeno (495-435 B.C.) is famous for the difficulties he raised in connexion with questions that required the use of infinite series, such, for instance, as the well-known paradox of Achilles and the tortoise. Zeno's various paradoxes made the Greeks suspicious of the use of infinitesimals, and ultimately led to the invention of the method of exhaustions. Zeno went with Parmenides to Athens.

The Athenian School.

After the disastrous defeats of the Persians at Marathon and Salamis, the intellectual life of Greece became gradually centred at Athens, and eventually the intellectual prominence of that city was firmly established. As the wealth and power of Athens increased, many sophists settled there. Among the other things the sophists did was to teach the art of oratory: the power of effective speaking was a condition of success in Athenian public life. One of the best-known sophists was **Hippias** of Elis (*c.* 420 B.C.), a geometrician who managed to solve the second of the famous mathematical problems, viz. the trisection of an angle. For this purpose he invented a curve known as the Quadratrix (see p. 48). **Anaxagoras** of Clazomenæ, the last of the great Ionian philosophers, an astronomer, settled at Athens about 460 B.C. Zeno of Elea also settled there.

* Not to be confused with Zeno the founder of the Stoic philosophy of Epicurus, both of whom lived much later than Zeno the mathematician.

The history of the Athenian school begins with the teaching of **Hippocrates** of Chios* (c. 420 B.C.), one of the greatest of the Greek geometers. He succeeded in devising a simple method of finding the areas of lunes, and so of giving a useful clue to the connexion between the areas of rectilinear figures and of curved figures.

The Athenian school was put on a permanent basis by the labours of **Plato** (427-347 B.C.).



Socrates

From the bust in the Capitoline
Museum, Rome



Plato

From the bust in the Naples
Museum

Fig. 5

Plato had been a follower of **Socrates** (469-399 B.C.), and they were the only two Athenians to become front-rank philosophers. Socrates, a man of singularly independent mind, acquired a great reputation for "wisdom"; he was a great dialectician, and the influence of Zeno on his dialectic is unmistakable. He led his pupils to inquire what they really meant by the words they used, and so taught them to form the habit of scrupulously examining the premisses of all their arguments. His opponents he covered with ridicule by weaving around them a dialectical web from which

* To be distinguished from his contemporary, Hippocrates of Cos, the physician.

they simply could not disentangle themselves. Naturally he made many enemies.

Socrates did not invent a system: he devised a *method*. "All reasoning depends on original premisses; all premisses consist of words. Never attempt to reason until both premisses and words have been scrupulously examined, or the reasoning will infallibly be spurious." Can we imagine advice more sound!

This was indeed the golden age of Greece. Never before and never since in the history of the world has there been such a galaxy of intellectual stars, all within the space of about 100 years. Philosophy, history, the drama, poetry, architecture, sculpture, mathematics, science, all save the last were represented by intellectual giants. In mathematics alone there were at least a dozen whose names will live for all time. In philosophy there are at least two, Plato and Aristotle, who still dazzle the world by their remarkable gifts.

After the tragic death of Socrates, Plato remained away from Athens for eleven years. He then returned and became head of the Academy, over the portals of which he caused to be inscribed the words, *All Non-Mathematicians barred*. He was not a great mathematician himself, but he was fully alive to the necessity of giving education a mathematical basis. With Plato as head, no wonder the school produced such a large number of famous mathematicians. Though Plato did little original work in mathematics he made valuable improvements in the logic and methods employed in geometry. Perhaps the greatest achievement of Plato's school was the invention of *analysis* as a method of mathematical discovery and proof. The method had been used before, but it was Plato who systematized it and established it as a definite *method*.

We have no space to refer to Plato's philosophy, his main subject. As to his science, the reader may obtain a fairly accurate survey of his views from the *Timæus*. This particular dialogue seems at first to be rather obscure. Unless

the reader is a thoroughly competent Greek scholar, he had better be satisfied with Jowett's translation. We shall refer to it again.

Plato's most famous pupil was **Aristotle** (384-322 B.C.), a native of Stagira on the shores of the North Ægean, "who is felt to be so mighty, and known to be so wrong." Though for more than twenty years with Plato at the Academy, he was no mathematician, and after Plato's death, he set up in Athens another school which became known as the Lyceum. Though Aristotle took all knowledge for his province, he was primarily a zoologist. No later zoologist has excelled him in accuracy of observation. He also introduced a new method, a method which may be roughly described as the method of induction. He insisted on *observation*, on *facts*, on *verification*. The method he *taught* was well-nigh perfect. The method he *used* when investigating physical science was, outside the realm of zoology, almost puerile. He often made the most absurd statements about things which he must have accepted on hearsay and never attempted to verify. And yet the world has always recognized him—and rightly—as one of some half-score of its greatest sons.

The effect of Aristotle's rejection of the mathematics of Plato's Academy was to make a permanent breach between philosophy and science.

Aristotle's best-known pupil is **Theophrastus** (372-287 B.C.), who did for botany what his master had done for zoology. But with the death of Theophrastus, the Peripatetic School (as the Lyceum came to be called) practically died too. Then science for the most part came to a full stop. Mathematics still forged ahead.

Of the other mathematicians of the Athenian School, **Eudoxus** (407-355 B.C.), a student of Archytas, and then of Plato, was probably the most famous and second only to Archimedes. He developed the theory of proportion, and applied it to commensurables and incommensurables alike; he used the method of exhaustion for measuring curvilinear areas and solids; he discovered some theorems involving

golden section; he constructed an orrery, and he wrote a treatise on astronomy.

Democritus of Abdera (*c.* 460 B.C.) hardly belonged to the Athenian school, though he was a contemporary of Eudoxus. He was a front-rank mathematician but our main interest in him is as an atomist. **Hippocrates** of Cos (460–357 B.C.) was a little earlier than Democritus; he was the great physician of antiquity.

The Alexandrian School.

After Alexander's death in 323 B.C., his vast empire was divided among his generals, and Alexandria, the new Egyptian capital, fell to Ptolemy. Under the rule of the successive Ptolemies the city became the centre of the learned world. By 300 B.C., the "Museum" (the seat of the Muses), was founded and became, in effect, a university of Greek learning. Attached to it were a great library and lecture-rooms for the professors. Here for 700 years Greek science and mathematics had its head-quarters and its home. Athens was entirely eclipsed. Rome was never a scientific centre in ancient times, and Romans as well as Greeks went to Alexandria to study medicine, mathematics, astronomy, and geography.

It was at Alexandria during the third century B.C. that mathematics reached its highest development, and with this development are associated the great mathematicians, **Euclid** (*c.* 330–275 B.C.), **Archimedes** (287–212 B.C.), and **Apollonius** of Perga (*c.* 260–200 B.C.). **Aristarchus**, a contemporary of Archimedes, was famous as an astronomer.

The next century was a period of some decline, though not a few men came well to the front. **Hipparchus** (*c.* 160–120 B.C.) was perhaps the greatest astronomer of antiquity, though **Claudius Ptolemy** of Alexandria (*fl. c.* A.D. 140) was scarcely less distinguished.

Of inventors and engineers, there are two well-known names, **Ctesibius** (*c.* 135 B.C.) and his pupil **Hero** (*c.* 75 B.C.). Of physicians, **Galen** (*c.* A.D. 130) ranks high.

The last two Greek mathematicians of note are heard of

300 or 400 years later. **Diophantus** (c. A.D. 300), whose name is associated with algebra, and **Pappus**, who taught at Alexandria about the same time.

Despite the increasing opposition of the churches, science struggled on for a century or two longer, but in the fifth century A.D., the Greek torch, which had been aflame for a thousand years, flickered out. The Mohammedan invasion took place, and the famous Alexandrian library was ruthlessly destroyed by the caliph **Omar**. The next thousand years was mainly a period of darkness.

The Greeks had to begin at the beginning; they had to find the way. They were animated by the true spirit of inquiry, and this inquiry they were free to pursue for hundreds of years. They aimed at an interpretation in the light of reason. As time went on they learnt to verify their discoveries by repeated observations. But their power of analysis exceeded their power of deduction, and this explains why they made such amazing headway in mathematics, so little headway in other directions. As now, so then: scientific workers were far too prone to invent hypotheses, but unlike workers of the present day they had very few facts to work on, and nearly all their hypotheses in physical science eventually collapsed like soap bubbles.

But if their blunders were many, their achievements were many, too. Eventually, their supply of geniuses ran out, but even if the supply had lasted the new world conditions from the fifth century A.D. onwards would have proved fatal to them. With the Renaissance great men were born again.

Greek "science" is generally considered to include mathematics as well as physical and biological science. We shall consider briefly, in order, Greek mathematics, astronomy, biology, medicine, and physics and chemistry. This order probably indicates correctly the degrees of diminishing success. Space does not permit of a general historical treatment. Only the most famous leaders will be mentioned and the value of their work estimated.

The principal members of the earlier schools may be shown chronologically thus:

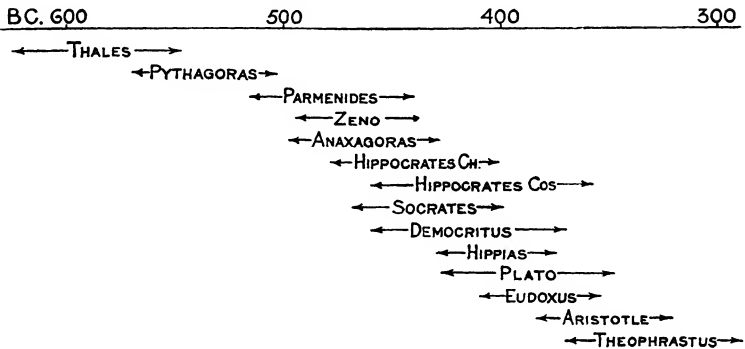

And of the great Alexandrian school thus:

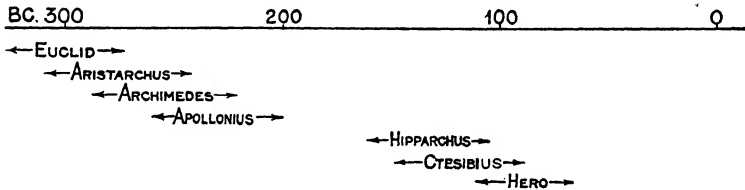

Note that Theophrastus in the first group and Euclid in the second were contemporaries, though Euclid was forty-two years the younger.

Ptolemy the astronomer flourished about A.D. 140. Galen was born in A.D. 130, and Diophantus and Pappus both flourished about A.D. 300. Some of the dates given in the chapter are necessarily rough approximations.

BOOKS FOR REFERENCE:

1. *The Legacy of Greece*, R. W. Livingstone. (A book by a number of eminent Greek scholars, specialists in their own departments—Literature, History, Philosophy, Mathematics, &c.)
2. *Histories*, Grote, Thirlwall, Bury.
3. *Early Age of Greece*, W. Ridgeway.
4. *Lectures on Classical Subjects*, W. R. Hardie.
5. *Some Aspects of the Greek Genius*, S. H. Butcher.

CHAPTER VII

Greek Mathematics

Pythagoras.—Pythagoras not only made great advances in practical arithmetic and in the theory of numbers, but his knowledge of geometry covered the greater part of the subject-matter of Euclid I, II, IV, VI. His theory of proportion did not apply to incommensurables, but he appears to have discovered the existence of the incommensurable or irrational in the particular case of the ratio of the diagonal to the side of a square. He was also acquainted with the five regular solids, and since the construction of a pentagon (the dodeca-

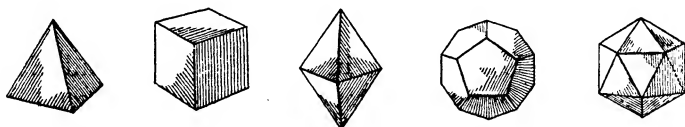

Fig. 6

hedron is based on the pentagon) required a knowledge of “golden section”, Pythagoras’s knowledge of geometry may have been much more extensive than we know. “Golden Section” (Euclid II, 11; VI, 30) is of far-reaching importance in mathematics.

Pythagoras certainly proved those properties of right-angled triangles which are given in Euclid I, 47, 48, but the proofs given in Euclid were Euclid’s own. What proofs did Pythagoras devise? We can only conjecture. It may have been based on some simple method of dissection: for instance, in two equal squares in which the sides of both are divided in the same ratio, it is obvious (fig. 7) that the four

shaded triangles in the one are identical with the four in the other, and that therefore,

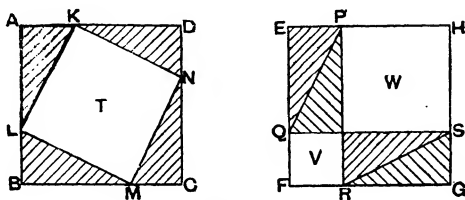

Fig. 7

$$\text{area } T = \text{area } W + \text{area } V.$$

Whether he succeeded in devising a rigorous proof we do not know.

The method attributed to him of proving that the ratio of the diagonal to the side of a square is incommensurable is quite easy to follow:

If possible, let the ratio be commensurable and consist of two integers, a and b , prime to each other, i.e. having no common divisor other than unity. Then (Euclid I, 47):

$$\begin{aligned} b^2 &= 2a^2, \\ \therefore b^2 &\text{ is an even number,} \\ \therefore b &\text{ is an even number.} \end{aligned}$$

And since a is prime to b , $\therefore a$ is an odd number.

Again, since it has been shown that b is an even number, b may be represented by $2n$;

$$\begin{aligned} \therefore (2n)^2 &= 2a^2, \\ \therefore a^2 &= 2n^2 \\ \therefore a^2 &\text{ is an even number,} \\ \therefore a &\text{ is an even number,} \end{aligned}$$

\therefore the same number a must be both odd and even, which is absurd.

\therefore the ratio of the side to the diagonal is *not* commensurable.

The point of interest in this is the *rigour of the proof* at this early stage of mathematics: the whole subject was still

in its cradle. (The proof appears as the last proposition in the tenth book of Euclid.)

Hippias is best known to us through his invention of a curve described by combining two uniform movements, one angular, one rectilinear, taking the same time to complete. The curve, known as the *quadratrix*, was used for the division of an angle in any ratio.

Let the rotating radius AD move through the right angle DAB to AB *in the same time* that AD moves, parallel to itself, to BC. The point determined by the intersecting lines describes the quadratrix BQ.

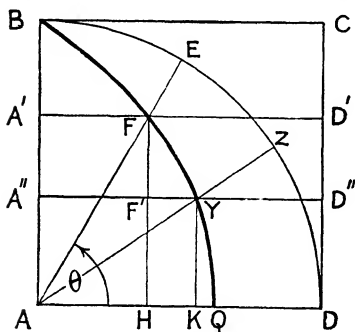

Fig. 8

For instance, let AD rotate to AE while AD moves to A'D'. Then F is a point on the curve.

$$\frac{\angle DAB}{\angle DAE} = \frac{\text{arc } BED}{\text{arc } ED} = \frac{AB}{FH}.$$

The curve once constructed enables us not only to trisect an angle but to divide an angle in any ratio. For

instance, divide the angle EAD in the ratio 3 : 4.

Divide the perpendicular FH at F' in the ratio 3 : 4 so

that $\frac{FF'}{F'H} = \frac{3}{4}$; and through F' draw the parallel A''D'',

cutting the quadratrix in Y. Join AY and produce it to meet the arc BD in Z. Then Z divides the angle EAD in the ratio 3 : 4. Draw the perpendicular YK.

$$\frac{\angle ZAD}{\angle EAD} = \frac{YK}{FH} = \frac{F'H}{FH};$$

$$\therefore \frac{\angle EAZ}{\angle ZAD} = \frac{FF'}{F'H} = \frac{3}{4}.$$

Such a simple expedient for solving such a difficult problem is remarkable. Hippias devised an instrument for

constructing the curve mechanically, but Plato would not allow the use of any instruments except a ruler and a pair of compasses.

Hippocrates of Chios developed the general geometry of the circle, but his most celebrated discoveries are in connexion with two of the three classical problems already referred to, the quadrature of the circle and the duplication of the cube. The reader will readily understand that to find the area of any given *rectilinear* figure is a comparatively simple matter, but that the transformation of the area of a curvilinear figure into an equivalent rectilinear area is another matter altogether. It will suffice here to indicate the way in which Hippocrates approached the problem. Again note the simplicity and the elegance of the solution.

The figure shows a right-angled triangle with semicircles described on the three sides. From Euclid I, 47, and XII, 2, it follows that

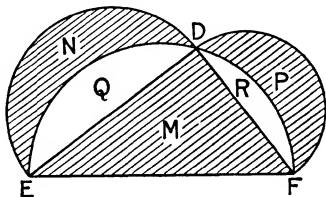

Fig. 9

area of semicircle on EF

= area of semicircle on ED

+ area of semicircle on DF,

that is, $Q + M + R = N + Q + P + R;$

$\therefore M = N + P,$

that is, the area of the triangle is equal to the sum of the areas of the two lunes. Thus we have the sum of two curvilinear areas expressed in terms of a rectilinear area.

Plato.—Compared with some of his contemporaries, Plato was not a great original mathematician, but he was a mathematical enthusiast, and above all things a mathematical teacher. We often hear it said that mathematics is a deductive science, and so it is if judged from the dress in which it is set out, for a mathematician sets out the solution of his problems as Euclid set out his propositions; the setting out consists of chains of deductive reasoning, based upon ultimate

premises. But the mathematician solves his problems *analytically*. As Plato so clearly showed, this method is the *only* method. We will take the reader back to his early school-days, and repeat a lesson in the form he probably received it. Let him observe how the data of the problem are examined and analysed, and how, once the solution has been discovered, the whole thing may be set out, deductively, rigorously reasoned from first principles.

ABCD is a parallelogram ; E is the mid-point of BC, and AE and DC produced intersect at F. Prove that AE = EF.

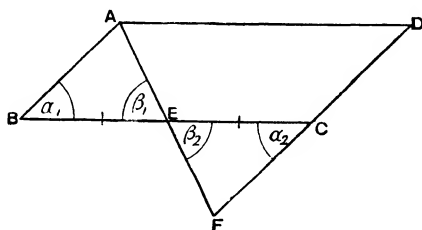

Fig. 10

Argument.

- (1) What facts are **given**?
 - (i) ABCD is a \square m; \therefore its opp. sides are \parallel .
 - (ii) $BE = EC$ (by constr.).
- (2) What have I to **prove**?
That $AE = EF$.
- (3) How have I been able to prove before, that two lines are equal?
 - (i) Sometimes by finding them in two congruent Δ s.
 - (ii) Sometimes by finding them in a Δ with two angles equal.
 - (iii) Sometimes by finding them to be the opp. sides of a \square m.
- (4) Does either of these plans seem possible, to prove AE eq. to EF ?

- (5) Yes, the first, for the Δ s ABE and FCE *look* congruent?
 (6) *Are* they congruent?
 (7) Yes. Two \angle s and a side, as marked.

Now I know how to write out the proof in the ordinary way.

Proof. In the Δ s ABE, FCE,

$$\begin{aligned} BE &= EC, & (\text{constr.}) \\ \angle AEB &= \angle FEC, & (\text{vert. opp. } \angle\text{s}) \\ \angle ABE &= \angle FCE, & (\text{alt. } \angle\text{s}; BC \text{ across } \parallel\text{s } AB, DF) \\ \therefore \Delta ABE &= \Delta FCE, & (2 \angle\text{s and a side}) \\ \therefore AE &= EF. & (\text{which was to be proved}). \end{aligned}$$

This is not one of Plato's own problems; it is just a simple illustration of Plato's method. Plato was a master of mathematical *method*; a great master too. We shall return to him as a teacher of science in Chapter XI.

Euclid.—Euclid's reputation rests mainly on his *Elements*. This treatise contains a systematic exposition of the leading propositions of elementary geometry, exclusive of the conic sections. It is largely a compilation from the works of previous writers.

The form in which the propositions are presented, consisting of enunciation, statement, construction, proof, and conclusion, is due to Euclid; as also is the synthetical character of the work, each proof being written out as a logically correct train of reasoning, based ultimately on a number of definitions and axioms, but without any clue to the method by which it was obtained.

The definitions and axioms contain, however, many assumptions which are not obvious; in particular, the postulate about parallel lines is not only not self-evident, it is not capable of proof. Further, no explanation is given as to the reason why the proofs take the form in which they are pre-

sented; the synthetical proof is given but not the analysis by which it was obtained. *How* Euclid solved his problems, we do not know; he merely wrote out the solutions, though that he did perfectly. On the other hand, the propositions are arranged in such a way as to form a perfect chain of geometrical reasoning. The logical relations of the first thirty-two propositions of the first book are clearly shown in this tabular scheme.

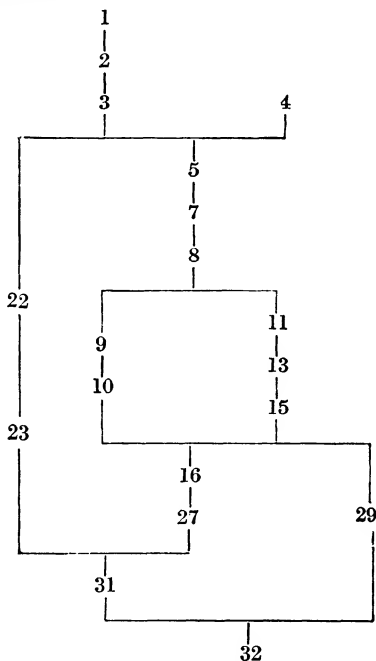

Books I–IV and VI deal with plane geometry, Book V with the theory of proportion, Books VII to X with the theory of numbers, Books XI and XII with solid geometry, and Book XIII, probably an appendix, with golden section, the construction of the five regular solids, and other matters.

Euclid also wrote a book on geometrical optics, and another on geometrical astronomy.

Euclid was essentially a *logician*. That he has now been

driven out of our schools may go far to explain why it is so often said that the reasoning of the ordinary educated man is much less rigorous than it was a generation or two ago.

Archimedes.—Every schoolboy knows the various stories about Archimedes—his excitement on discovering, when having a bath, the clue to solving the problem of the king's crown; his invention of "burning-glasses" by which he is supposed to have set fire to the Roman fleet; his death, when busy with a geometrical problem, at the hands of a Roman soldier. The record of his life, so far as it is known, is of absorbing interest (Portrait, Plate 3).

Which is the greatest mathematician that the world has hitherto produced, Archimedes or Newton? Opinion is perhaps about equally divided. Here is a list of Archimedes' writings:

1. *Geometry*:

- (1) Mensuration of the circle.
- (2) Quadrature of the parabola.
- (3) Spirals.
- (4) The sphere and the cylinder (2 books).
- (5) Conoids and spheroids.
- (6) The semi-regular polyhedra.
- (7) Various problems: for instance, "the shoemaker's knife".

2. *Arithmetic*:

The Sand reckoner.

3. *Statics, Hydrostatics, &c.*:

- (1) Equilibrium: levers, balances, centres of gravity.
- (2) Floating bodies.
- (3) *Catoptrica* (an optical work).

By far the greater part of these writings represents Archimedes' own original work. He differs from Euclid and Apollonius whose work consisted largely in systematizing and generalizing the methods and the results obtained by earlier geometers. Archimedes' objective was always something new.

Not only was Archimedes a great mathematician but he was in an eminent degree a practical man as well. There is little doubt that he usually obtained a clue to the solution of a new mathematical problem by adopting some practical device. For instance, to determine the area of a curved figure he would cut out the figure from some easily manageable material (paper, metal plate) and *weigh* it against some rectilinear figure (square, rectangle) cut from the same material and easily measured up. So with volumes: for instance, a sphere, and a cylinder of the same diameter and height as the sphere, might be cut from the same piece of wood, and the weights of the two compared. But once he had obtained an *approximate* result this way, he would set to work anew, and devise a method which would yield an *exact* result and which could be rigorously proved.

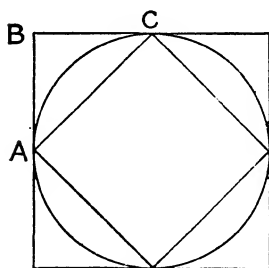

Fig. 11

It should be noted that, in his demonstrations, Archimedes did not use "infinitesimals". Like Eudoxus and Euclid, he took to heart the lesson to be learnt from Zeno's paradoxes. Apparently Archimedes considered infinitesimals sufficiently scientific to *suggest* the solutions of propositions, but not to furnish rigorous proofs.

We will illustrate his work by reference to two problems: (i) the determination of π , (ii) the quadrature of the parabola.

The determination of π .—Figure 11 shows a circle with inscribed and circumscribed squares, the sides of the latter being drawn as tangents at the angular points of the former. It is easily proved that the length of the arc AC is greater than the chord AC but less than the sum of the two tangents AB and CB. It therefore follows that the length of the circumference of the circle is *greater* than the perimeter of the inscribed square but *less* than the perimeter of the circumscribed square. The perimeters of the two squares are easily

measured, and thus we obtain a very rough approximation to the length of the circumference of the circle.

If instead of using squares we use regular polygons having a large number of sides, the perimeters will much more closely approximate to the length of the circumference. If, for instance, the diameter of the circle is 1", the length of the perimeter of the outer polygon is 3·1417", and that of the inner polygon is 3·1413"; since these two lengths *agree* to the third decimal place, the value 3·141 must indicate the length of the circumference of the circle to that degree of approximation. Obviously, by increasing the number of sides of the polygon, and so *exhausting* more and more the differences between their perimeters and the circumference of the circles, we obtain a value of π to any degree of approximation we please. This was Archimedes' method. He calculated the perimeters of polygons 96 sides, and he found π lies between $\frac{25344}{8069}$ and $\frac{29376}{9347}$. The reader may convert these fractions into decimals for himself, and compare the values.

Observe Archimedes' caution: he did not say that the circumference is the *limiting form* of the two polygons; he said merely that the polygons can be made to approach the curve *as nearly as we please*.

Euclid (and probably Eudoxus) had also used the method of exhaustion, but had used inscribed figures only. Archimedes' method leads to a proof of much greater rigour.

The Quadrature of the Parabola.—The parabola is, of course, an indefinitely extending curve. Let PQ be any chord. It is required to find the area of the segment QSP.

Let M be the middle point of the chord and draw MS parallel to the axis of the parabola. It is a well-known property of the curve that the greatest perpendicular from any point on the curve to the chord is the perpendicular from S, and this property is the key to Archimedes' solution (fig. 12).

In the two small segments bounded by the chords SQ and SP, draw triangles STQ and SUP exactly as the first triangle was drawn, viz. by bisecting the chords at N and R

and drawing parallels NT and RU to the axis. Archimedes proved that each of these two triangles TSQ and USP is equal to $\frac{1}{8}$ of the triangle SPQ, or together are equal to $\frac{1}{4}$.

Again, in each of the four small segments bounded by the chords QT, TS, SU, and UP, we may inscribe triangles, exactly as before, and so we can proceed indefinitely, *exhausting* to a greater and greater degree the area of the main segment QSP. The ratio $\frac{1}{4}$ holds good always. Thus the area of the parabolic segment approximates to the area determined by the sum of the following series:

(let the first triangle SPQ be denoted by Δ)

$$\Delta \left(1 + \frac{1}{4} + \left(\frac{1}{4}\right)^2 + \left(\frac{1}{4}\right)^3 + \dots \right)$$

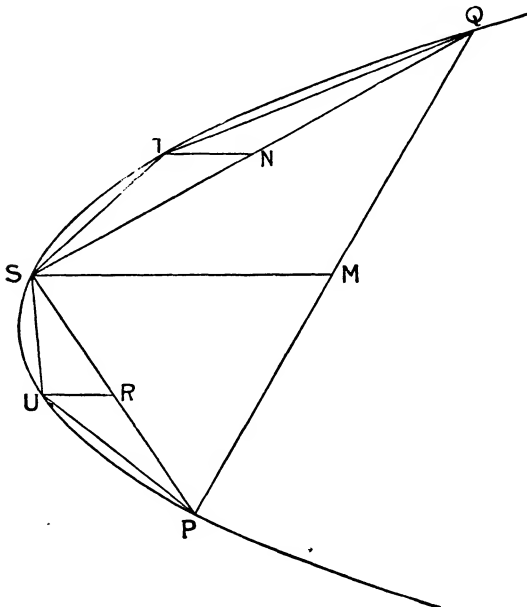

Fig. 12

This sum approximates ever and ever nearer to $\frac{4}{3}\Delta$ and thus it is easy to establish formally that the area of the parabola is $\frac{4}{3}$ that of the ΔSPQ , or $\frac{2}{3}$ that of the rectangle with base PQ and altitude the distance of S from PQ.

Only the mathematical reader is likely to appreciate the wonderful resourcefulness of Archimedes, some of whose works he is advised to read. We shall return to him again.

Archimedes established those principles of geometry that depend on measurements. The method of *exhaustions* which he used does not differ in principle from the method of *limits* as used by Newton.

The calculus was the natural sequel to Archimedes' work.

Apollonius is chiefly celebrated for having introduced a systematic treatise on the conic sections. He did the work so well that he left little for his successors to add. The treatise contains about 400 propositions. It was Apollonius who introduced the names ellipse, parabola, and hyperbola.

Apollonius was the last of the famous Alexandrian mathematicians. Together, Archimedes and Apollonius accomplished whatever was possible without the resources of analytical geometry and of the calculus. The world now had to wait for Descartes and Newton.

BOOKS FOR REFERENCE:

1. *Manual of Greek Mathematics*, T. L. Heath.
2. *History of Greek Mathematics* (2 vols.), T. L. Heath.
3. *History of Mathematics*, F. Cajori.
4. *History of Mathematics* (2 vols.), D. E. Smith.
5. *Short Account of the History of Mathematics*, W. W. R. Ball.

CHAPTER VIII

Greek Astronomy

The modern astronomer is not greatly interested in our little solar system. He rambles about the whole stellar universe, and even that he is making "expand" at a prodigiously rapid rate. But our solar system is not such a puny thing after all. An airman is now able to travel two hundred miles an hour. If he could keep up this speed (it is nearly five thousand miles a day) and, without stopping, travel straight to the sun, the journey would take him well over fifty years. Astronomically to the Greeks, the solar system—the "central" earth, the revolving sun, the moon, and the five known planets—meant practically everything. The stars were simply jewelled points of brilliant light, set in an outer sphere, quite close neighbours of the members of the solar system. Little did the Greeks dream that even the nearest star of all is so far away that the five-thousand-miles-a-day airman would take *ten million years* to cover the distance. Such a vast distance (in miles it is twenty-four billion) is beyond the comprehension of the ordinary man in the street, but to the modern astronomer it is the veriest bagatelle.

The Babylonians were astronomical observers and recorders. The Greeks saw, or thought they saw, the various celestial bodies in a state of motion, a motion with an obvious regularity of some kind despite many puzzling irregularities. Their great question was, How does the machine work?

Before the reader smiles at some of the early conjectures of the Greeks, let him examine his own first-hand knowledge of astronomy. Let him write down all he knows from his own observations of the sun, the moon, the stars, and (if he

can find them) the planets. How from these observations does *he* make the machine work? Doubtless he was told when a boy at school that the moon travels round the earth and the earth round the sun. Did he accept that statement unquestioned, or did he make himself a nuisance (as he would have been justified in doing) and press his teacher to *prove* that the moon and earth thus moved? Let him walk in a big circle slowly round a tree in a field, and let him instruct a boy to walk round him continuously in small circles as he himself walks round the big one. The boy may leave a trace of his path by dropping bits of paper on the ground, or, if the experiment is tried after a fall of snow, the boy's path may be seen plainly in the snow. The path is a continuous series of loops. Now does the reader honestly believe *from his own observations* that, if the moon could leave behind it in the sky a fiery track that we could see, its path in space would appear to be really looped? If he does, he is getting on.

It is instructive to note the progress of the Greeks, century after century, in the conjectures they put forward to explain the movements of the heavenly bodies.

Thales believed the earth to be a disc floating in water. What is there irrational in that? The hypothesis squared with all the facts he knew. But his pupil **Anaximander** shrank from the idea that the earth required support to keep it in its place; he believed the earth to be balanced in the centre of the universe, not tending, therefore, to fall in one direction rather than in another. Another pupil of Thales, **Anaximines**, conceived the stars to be fixed in a crystal sphere as in a rigid frame. Since the stars all appear to preserve their relative positions, surely this was a perfectly rational conjecture. **Pythagoras** regarded the universe as a sphere rotating about an axis passing through the centre of the earth, the earth remaining at rest—a simple hypothesis admirably explaining things as they appeared to the eye.

So much for the **Ionians** and **Pythagoreans**. When we come to Athens we find **Anaxagoras** (c. 460 B.C.) of Clazo-

menæ correctly stating the fact that the moon does not shine by her own light but by that of the sun. It was about this time that the more obvious irregularities of the planetary motions began to attract attention, and **Eudoxus** (407–355 B.C.), wrote a treatise on astronomy in which he put forward the hypothesis of a number of concentric spheres having their common centre at the centre of the earth. By their combined motions, one inside the other, and revolving about different axes, each sphere revolving on its own account but also being carried round bodily by the revolution of the next sphere encircling it, Eudoxus was able to explain all the various motions of the planets as actually observed, especially their apparent stationary points and retrogressions. The hypothesis was one of great mathematical ingenuity. **Heraclides** (388–315 B.C.), a pupil of Plato, put forward the then startling hypothesis that the earth is not at rest but rotates on its axis once in twenty-four hours. (Is the reader convinced—*convinced*—that the earth so rotates?) **Aristarchus** (310–250 B.C.) (we have now come to a really great astronomer—he belonged to the Alexandrian School) accepted Heraclides' views about the rotation of the earth, and put forward the still more startling hypothesis that not the earth but the sun is the central body of the solar system, and that the earth and the other planets revolve round it. Thus he actually anticipated Copernicus who lived nearly two thousand years later, but neither his contemporaries nor his famous successors Hipparchus and Ptolemy would accept the hypothesis. Aristarchus also estimated the sizes and distances of the sun and moon, but the results were only rough approximations. **Eratosthenes** (276–194 B.C.), librarian at Alexandria, and the inventor of the sieve for winnowing prime numbers, measured the diameter of the earth and determined the obliquity of the ecliptic.

But the greatest astronomer of antiquity was **Hipparchus** (c. 160 B.C.). Here is a list of some of his achievements:

1. He determined the length of the year to within six minutes of its true value.

2. He estimated the inclination of the ecliptic to the equator to be $23^{\circ} 51'$; actually at that time it was $23^{\circ} 46'$.
3. He estimated the annual precession of the equinoxes to be $59''$; actually it is $50.2''$.
4. He estimated the lunar parallax to be $57'$, which is nearly correct.
5. He estimated the excentricity of the solar orbit to be $\frac{1}{24}$; it is approximately $\frac{1}{30}$.
6. He calculated the extent of the shifting of the plane of the moon's motion.
7. He obtained the synodic periods of the five planets then known.
8. He gave the correct interpretation of the precession of the equinoxes (this was really the inspiration of genius).

He did many other things as well, and his work placed the subject of astronomy for the first time on a scientific basis.

In attempting to deal with the motions of the planets, as he had done with the motions of the sun and moon, he was baffled; the available data were insufficient, and he began a series of planetary observations, to enable his successors to account for the motions. He predicted it would be necessary to introduce epicycles, but he refrained from putting forward a complete hypothesis. This caution reveals the true man of science. Had Hipparchus adopted the heliocentric theory put forward by Aristarchus, it is not improbable that he would have solved the whole problem; he would certainly have anticipated Copernicus. But he did not think the available facts justified Aristarchus's theory. He was a very great but a very cautious investigator.

The last well-known astronomer of antiquity, **Ptolemy**, appeared about three hundred years later (*fl.* A.D. 140). Naked-eye astronomy naturally still held the field: at that time a telescope was never dreamed of, and Ptolemy's form of theodolite for angle measuring might well have been made by any ordinary mechanic. He produced a treatise on astronomy usually known as the *Almagest* in which was presented for the first time the whole of the astronomical science then

developed. He himself did not carry the subject forward to any appreciable extent. Ptolemy maintained the geocentric theory of Hipparchus, and his system, the "Ptolemaic system", was accepted, unquestioned, until it was overthrown by Copernicus some 1400 years later. He elaborated a theory of epicycles to account for the motion of the planets, thus fulfilling the prediction of Hipparchus. The scheme he put forward was so far satisfactory that he was able to prepare tables of the movements of the sun, moon, and planets, to a close degree of approximation. It is difficult to understand why Ptolemy did not adopt the hypothesis of Aristarchus that the sun and not the earth was the centre of the solar system. The epicycles with all their complications would then have disappeared, and simple circles would have taken their place. His system was a mere representation of motions as observed from the earth which he assumed to be fixed.

With Ptolemy's death all astronomical progress ceased.

Hipparchus's discovery that the planetary hypothesis he had received from his predecessors would not stand the test of known facts, and yet his consequent decision not to put forward a fresh hypothesis but to begin the accumulation of new facts which he knew could never be used by himself, ought to prove a lesson to modern investigators. Had he put forward a fresh hypothesis, he would have added greatly to his reputation amongst his contemporaries, but he was utterly indifferent to a great reputation; he wanted to *know*. This was the spirit that so strongly animated the ancient Greeks.

The reader will not find it difficult to understand how the Greeks came to stumble so badly over their hypothesis of planetary epicycles. In the first place, they could not bring themselves to believe that the earth was not the head-quarters of the solar system, with the sun, moon, and planets all revolving round it. Was not the earth obviously at rest, and were not all the other bodies actually seen to be in motion? In the second place, the planets sometimes seemed to stop, then

travel for a short distance backwards, then go forward again. How was this curious movement to be explained?

Let a pencil be stuck at right angles to the edge of a disc (a common bread-board will do) and let the disc be rolled on its edge along the end of the table which has been pushed up against the wall; the pencil will describe on the wall an epicycloidal path. Now let a cardboard disc 3" or 4" greater in diameter than the bread-board be fastened centrally to the latter, and let the pencil be stuck at right angles to the edge of the cardboard. If the bread-board be now rolled along the

table as before, the table being kept far enough away from the wall for the projecting edge of the cardboard to be below the table level, the pencil will trace out a looped epicycle on the wall. If, now, instead of the table a large cylinder (a garden roller would do if there is nothing else available) can be used, with its circular end parallel to and nearly touching the wall, and the compound

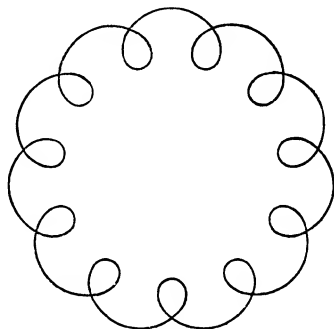

Fig. 13

disc rolled round it as it was rolled along the horizontal table, the kind of closed curve shown in fig. 13 results. It is a closed chain of epicycles, and it exactly represents what the Greeks thought to be the path of each planet as it revolved round the *earth*. We now know the planetary orbits to be a series of concentric circles (not quite *concentric*, not *quite* circles) round the *sun*; not as the Greeks believed, a series of concentric epicyclic chains, round the *earth*.

What was the justification for the Greek idea?

Mark out a circle, say 100 yards in diameter, on some large piece of level land (a large field would do), and instruct a boy to walk round this circle on a dark night, carrying a bright light, preferably on his head so that it may be seen whichever way he is facing. Now stand back several hundred

yards and watch the moving light; the night being dark, the boy himself cannot be seen. The light *appears* to move first (say) to the left, then to remain momentarily still, then to move to the right, then to remain momentarily still again, and so on, backwards and forwards like a pendulum. You *know* it is moving in a circle; it *appears* to be moving in a straight line. If you can make your observations from a church tower or from the top of a house or other building, you *may* be able to see that what appeared to be a straight line now opens out into a flat loop. Only when you are in

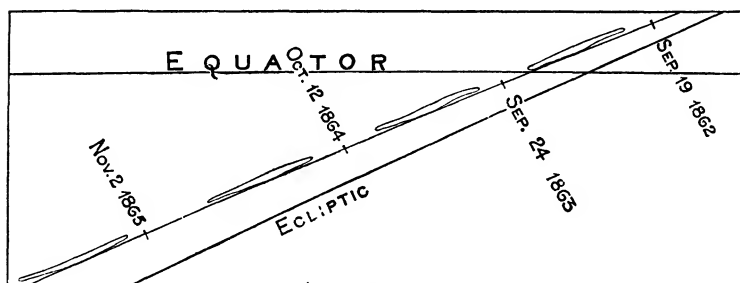

Fig. 14

the same plane as the light will the movement appear to be in a straight line.

Now if you note the position of a planet, say Mars or Jupiter, every starlight night for several months as it makes its way amongst the stars, you will find that while the path it makes is, *in general*, in the same direction, periodically there is a pause, then a backward movement, then another pause, then a general forward movement again. Ancient observers were well aware of this fact: what was the explanation? They could not bring themselves to believe that a planet could suddenly halt, and then move on again. Moreover, they observed that the path during the retrograde movement and the next forward movement sometimes composed a loop, and thus the idea of an epicyclic movement was born.

In Whitaker the reader will find the Declination and Right Ascension (a sort of latitude and longitude) of the various planets for every fifth day of the year. With some small help from an astronomical friend, he might take a star map and plot out the path of a selected planet for himself. The apparently epicyclic nature of the path will then be

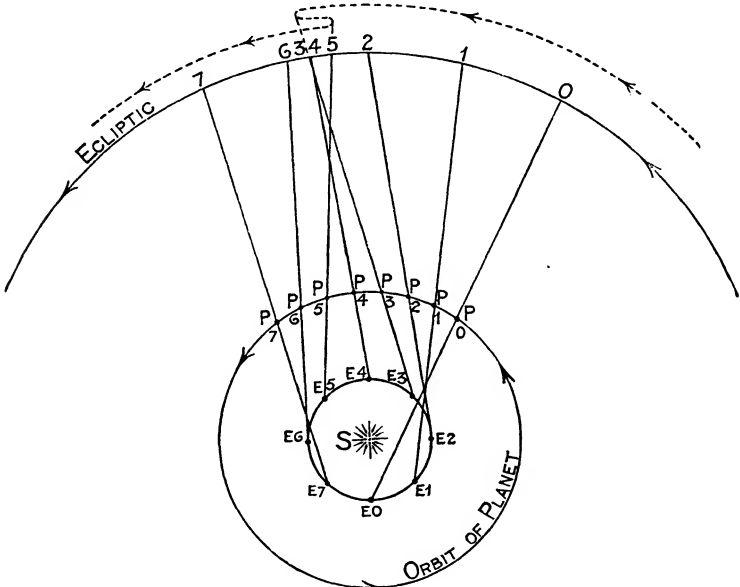

Fig. 15

obvious. He is less likely to be successful if he tries to plot the path from actual observations at night. Figure 14 shows Saturn's apparent path for four years (1862-65), as plotted by Proctor.

The diagram in fig. 15 shows the sun in the centre, a small circle denoting the earth's orbit with the earth in eight successive positions, 0 to 7, during the year, and a larger circle denoting the orbit of one of the superior planets, with the planet in successive positions, 0 to 7, corresponding, in time, to the successive positions of the earth. As the earth moves

round in its orbit, the planet is seen, of course, in or near the ecliptic, in the background of the sky, in the successive directions indicated by the straight line drawn through E_0P_0 , E_1P_1 , E_2P_2 , &c. Although the *general* apparent direction of the planet in the ecliptic is the same as in its actual orbit, an observer on the moving earth seems to detect a *backward* movement from 3 to 5, as more clearly indicated in the supplementary dotted path. (For simplicity, the three bodies are assumed to be in the same plane, hence loops do not appear.) This is merely the effect of relative motion. If we could watch the moving planets from the central sun, we should see them moving in circles; but we have to watch them *from the moving earth* and so we see the looped retrograde movements, to explain which we substitute epicycles for circles.

If we were travelling in a train which ran so smoothly that we could not *feel* its motion, it would be impossible to tell whether the train was moving or whether the landscape was moving. We might observe from the moving train that, for instance, the furrows of a ploughed field are apparently curving although we know them to be straight. We might observe more distant objects apparently travelling *with* the train as compared with nearer objects apparently travelling in the opposite direction. The apparently opposite motions apply to *any* two observed objects which are at different distances from the train; we judge their relative motion by referring them both to the more distant background. A balloonist cannot tell that he is moving at all: the only movement he is conscious of is that of the apparently moving landscape below.

The Greeks could not bring themselves to believe that the earth was a planet moving as the other planets did. They described the planetary movements correctly *as they saw them*. Not knowing that the earth moved, they unconsciously imposed its motion on the other planetary paths and turned circles into epicycles.

Later on, Copernicus adopted Aristarchus's suggestion

and made the sun the centre of the system. The planetary paths thus became simple circles (or rather ellipses) and the old complicated epicycles passed away.

But can we even now be sure that the sun should be given priority and that it does not revolve round the earth in company with the other planets, as the Greeks thought it did? How can we be *sure*, since we are dealing with relative motions? Well, consider one of the consequences of the contrary assumption. The volume of the sun is a million times that of the earth. If the huge sun moves round the tiny earth in twenty-four hours, it has to travel about 300,000,000 miles in that time (the distance and size of the sun are easily measured). The rate is about a million miles in five minutes. Probability is enormously against such an interpretation of the relative motions of the earth and the sun. But the *main* reason for our rejection of Ptolemaic geocentric hypothesis is that the alternative heliocentric hypothesis is geometrically so much simpler.

Still, it is only an hypothesis. Of course we are all apt to think it is sober fact. But we really do not *know*.

BOOKS FOR REFERENCE:

1. *Histoire d'Astronomie*, Delambre.
2. *History of Astronomy*, W. W. Bryant.
3. *History of the Planetary System*, J. L. E. Dreyer.
4. *The Legacy of Greece*, article on Mathematics and Astronomy.

CHAPTER IX

Greek Biology

The outstanding figure in this department of Greek science was **Aristotle** who, however, was a much keener student of animals than of plants (Portrait, Plate 3).

Though a distinguished zoologist, zoology was but one of many subjects of which he was master. In the matter of mere attainments he ranks easily first of all Greek scholars, even though he turned away from mathematics. But his training as a dialectician was a disadvantage to him as an investigator, for he was led to depend too much on formal reasoning, to accept words at their face value, to accept evidence without cross-examination, to be careless in the matter of verification. The method he *taught* was sound enough but, singularly enough, he did not always apply it in his own investigations.

Unlike most of the Greeks, Aristotle was a born naturalist. He was much more than a casual rambler about the field, the wood, and the seashore; he systematized the facts he accumulated. In short, he established a branch of *science*, and caused it to take rank side by side with astronomy and mathematics as departments of the general field of organized knowledge known up to that time as philosophy. He explains his purpose thus (we quote from Professor D'Arcy W. Thompson): "The glory doubtless of the heavenly bodies fills us with more delight than the contemplation of these lowly things; for the sun and stars are born not, neither do they decay, but are eternal and divine. But the heavens are high and afar off, and of celestial things the knowledge that our

senses give us is scanty and dim. The living creatures, on the other hand, are at our door, and if we so desire it, we may gain ample and certain knowledge of each and all. We take pleasure in the beauty of a statue; shall not then the living fill us with delight; and all the more if in the spirit of philosophy we search for causes and recognize the evidence of design? Then will nature's purpose and the deep-seated laws be everywhere revealed, all tending in her multitudinous work to one form or another of the Beautiful."

There was a wealth of known natural history before Aristotle's time, but it was that of the farmer, the woodsman, the huntsman, the fisherman. The knowledge was, however, unorganized. Aristotle did for it what the Pythagoreans had done for mathematics a century or two before: he made it a science.

What new facts of zoology Aristotle actually discovered, we do not know, but his knowledge of animals was certainly profound. His minute and accurate descriptions have always been the despair of young naturalists. Readers should dip into the *Historia Animalium* for themselves, and see what Aristotle has to say about, e.g. crustaceans, molluscs, and insects. There seems to be nothing more to find out about such a thing, e.g. as the cuttlefish, for apparently Aristotle discovered and told us everything that is to be known.

Aristotle was a great logician, and he discusses the principles of classification with great rigour. But he made no attempt at a logical classification of animals. He classified animals as he found them, pronouncing a logical dichotomy for every difference that presented itself; thus air breathers and water breathers would be divided, so would wild animals and tame animals, social and solitary animals. But he had a quick eye for the great natural groups.

All down the ages Aristotle's influence has been enormous, not so much in the department of zoology—that was almost a trifle in his vast store of learning—as in his methods, his teaching, his outlook, and his philosophy. At one of our oldest universities his influence is very great still. He made many

errors, some of them stupid and entirely unforgivable. But these were completely dwarfed by the great body of knowledge and positive truth with which he provided us.

Aristotle's greatness as a biologist was fully recognized by Charles Darwin, who said, "Linnæus and Cuvier have been my two gods, though in very different ways, but they were mere schoolboys to old Aristotle."

His pupil **Theophrastus** did for botany what he himself did for zoology. What Theophrastus owes to his master is uncertain (Aristotle's own book on plants is lost), but as an observer of nature he was unquestionably in the front rank. Parts of his *Historia Plantarum* are well worth reading. About the germination of seeds, for instance, he tells us simply everything that can be told from naked-eye observation, and until the invention of the microscope, no further facts were discovered. A particularly instructive feature of Theophrastus's description of germinating seeds is the distinction he points out between monocotyledons and dicotyledons, more especially the relation of root and shoot. In the former, root and shoot are represented as emerging from the same point in the seeds: in the latter, from opposite poles (Portrait, Plate 3).

BOOKS FOR REFERENCE:

1. *The Legacy of Greece: Biology*, C. Singer.
2. *The Legacy of Greece: Natural Science*, D'Arcy W. Thompson.
3. *Studies in the History and Method of Science: (a) Greek Biology*, C. Singer; (b) *Aristotle on the Heart*, A. Platt.
4. *Historia Animalium*, Aristotle.
5. *De Partibus*, Aristotle.
6. *The Enquiry into Plants*, Theophrastus. (Sir A. F. Hort, Bart., Loeb Library.)

CHAPTER X

Greek Medicine

In the systems of medicine practised by the Babylonians and the Egyptians, a great deal was based on some theory of disease which fitted in with the larger theory of the nature of evil. The commonest theory was the demonic, the view that regards deviation from the normal state of health as due either to the attacks of supernatural beings or to their actual entry into the body of the sufferer. Inevitably, therefore, the Greeks inherited a variety of systems of non-rational medicine, but to them belongs the distinction of throwing aside ancestral traditions and of introducing and practising a system based on their own observation of accumulated facts.

The earliest Greek medical schools we know anything about were those established in the outlying colonies, eastwards those at Cnidus and Cos on the shores of Asia Minor about the sixth century B.C., westwards those at Croton in south Italy, and Agrigentum in Sicily about the same time. The Cnidus School stressed diagnosis, and the Coan School, prognosis. **Empedocles** of Agrigentum (500-430 B.C.) put forward views concerning the function of the heart and lungs. **Alcmæon** of Croton (c. 500 B.C.), a pupil of Pythagoras, practised dissection of animals, and he discovered the optic nerves and the Eustachian tubes.

But the "Father" and by far the most distinguished representative of Greek medicine was **Hippocrates** (c. 460-c. 377 B.C.), who was born at Cos and practised in various places including Athens. The "Hippocratic Corpus" is a collection of sixty or seventy separate works, some written by

Hippocrates himself, others by members of his school, from which we learn much about the practice of Greek medicine during the earlier days of the Golden Age of Greece.

Hippocrates had to begin almost at the beginning. Something he did inherit from the earlier Greek schools, but not much, and even that was probably tainted by quackery and by prevailing quixotic notions in which it was utterly impossible to trace the relations of cause and effect. Hippocrates set to work to collect *facts*; never was there a more patient observer. His method was essentially a matter of induction. He was always sceptical of the unverifiable.

But it must be remembered that it was not until the days of the Alexandrian School that anatomy and physiology, the basis of our modern system, became the fundamental subjects of instruction. In these earlier days, the physician had to depend very largely on his examination of the exterior of the body. Still, some advance was made in surgery, e.g. the chest was opened for the condition of empyema, and a fractured skull was sometimes treated by trephining.

From the clinical point of view, perhaps the most interesting feature of the Hippocratic Collection is the description of cases. They are models, even for the present-day practitioner, of what such records should be. Here is one, presumably a case of diphtheria:

“The woman with quinsy, Aristion’s lodger: her complaint began in the tongue; voice inarticulate; tongue red and parched. *First* day, shivered, then became heated. *Third* day, rigor, acute fever; reddish and hard swelling on both sides of neck and chest; extremities cold and livid; respiration elevated; drink returned by the nose; could not swallow; alvine and urinary discharges suppressed. *Fourth* day, all symptoms exacerbated. *Fifth* day, she died.” The record includes all necessary facts, clearly stated, without a single superfluous word.

Another noteworthy record in the Collection are the minute directions for surgical operations: the preparation of the room, the management of the light, the scrupulous clean-

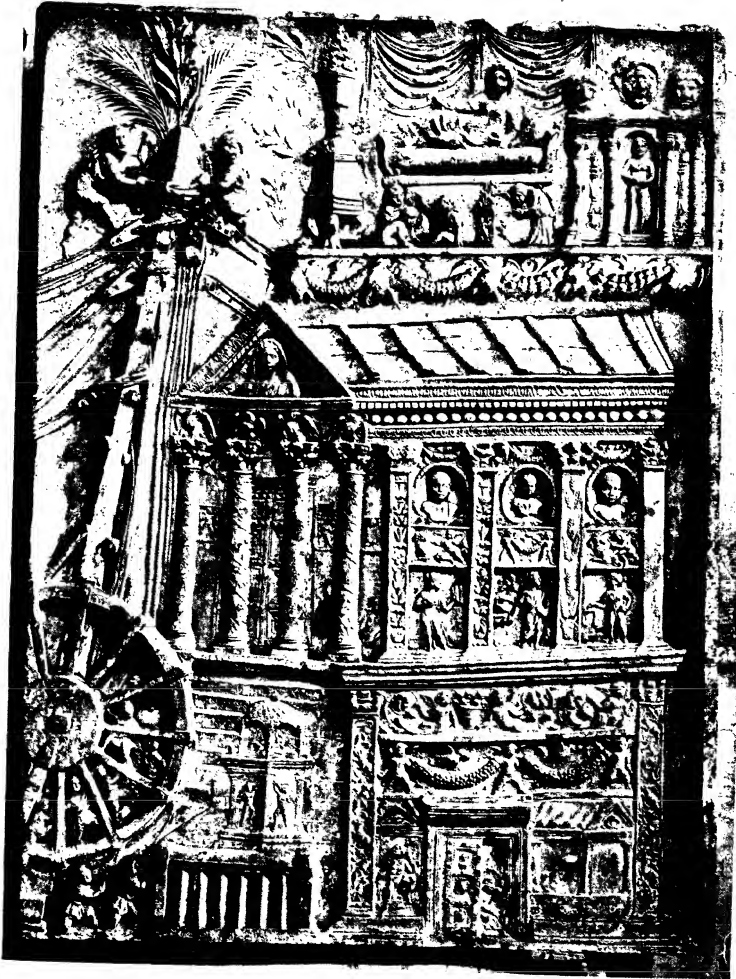

A Roman Crane
Mansell

liness of the hands, the care and the use of the instruments, the decencies to be observed, the general method of bandaging, the use and abuse of splints, the placing of the patient: it all sounds like a lecture to present-day medical students.

Still another interesting feature of the treatise are the useful medical aphorisms: e.g.

1. For extreme diseases, extreme methods of cure.
2. In disease, sleep that is laborious is a deadly symptom; but if sleep relieves it is not deadly.
3. Sleep that puts an end to delirium is a good symptom.
4. If a convalescent eats well, but does not put on flesh, it is a bad symptom.
5. Food or drink which is a little less good but more palatable is to be preferred to such as is better but less palatable.
6. The old generally have fewer complaints than the young, but those chronic diseases which do befall them rarely leave them.
7. Spasm supervening on a wound is fatal.
8. A convulsion or hiccup supervening on a copious discharge of blood is bad.

What modern practitioner has not embodied all such aphorisms in his daily practice?

The keynote of the Hippocratic treatment of disease was simplicity. After rest and quiet, the main factor was dietetics. Then came baths, warm and cold suffusions, massage, and gentle exercise. Drugs were few and not much used. Consider the wisdom of it all, in the light of modern practice.

When it is borne in mind that practitioners of the Hippocratic school had had no training in dissection or in experimental physiology, it seems remarkable that they acquired so much knowledge of the cause and origin of disease. The knowledge was all gained from observed facts by a process of scientific induction. Very few advances were made on their diagnosis, their prognosis, and their therapeutics, until the nineteenth century.

Hippocrates was to Greek medicine what Archimedes was to Greek mathematics and Hipparchus to Greek astronomy.

A century or two later the centre of medical interest is transferred to Alexandria; Athens fades into the background.

At Alexandria a great medical library was collected, and medical science made many new advances. Anatomy made a great leap forward. **Herophilus** (c. 300 B.C.) gave a detailed account of the brain and nervous system. **Erasistratus** (c. 290 B.C.) described correctly the action of the epiglottis, made detailed dissections of the heart, and distinguished between the motor and the sensory nerves; his attitude was definitely experimental.

The advances in anatomy naturally led to increased surgical efficiency at the Alexandrian School. Medical training became definitely organized, though no state diploma was introduced. General medical progress was maintained for three or four centuries though no names of great investigators are on record. **Celsus** (first century A.D.) wrote a treatise which probably represents the best Alexandrian medical practice.

Some hundred and fifty years later we read of **Galen** (c. A.D. 130–200), a Greek physician of Pergamos in Asia Minor who eventually set up a practice in Rome. He was honest, industrious, contentious, efficient, learned. He left behind him twenty-two big volumes of medical lore— anatomy, physiology, pathology, therapeutics, clinical medicine, and surgery. The great mass of writings not only tended to overshadow all the earlier Greek records but also tended to dominate medical schools for many centuries, in fact right down to the Renaissance. But Galen must not be ranked with Hippocrates who, as a man of science, was a man of far greater distinction.

(Portrait of Hippocrates, Plate 3).

BOOKS FOR REFERENCE:

1. *The Legacy of Greece: Greek Medicine*, C. Singer.
2. *Short History of Science*, Sedgwick and Tyler.
3. *Works of Hippocrates*, French translation by Littré.

CHAPTER XI

Greek Physical Science

It is a remarkable fact that physics and chemistry found scarcely any place in the science of ancient Greece. In the world of to-day, physics and chemistry, mechanics and engineering, enter into almost every department of life; but, in Greece, mathematics sat enthroned, isolated and alone, for a thousand years, from the time she was born in Ionia to the time of her decay in Alexandria. All branches of applied mathematics, with the exception of astronomy, remained undeveloped.

Why this curious limitation? Partly no doubt because the Greeks had no aptitude for experiments, but mainly because they had been systematically trained to place their confidence in deductive reasoning. "On the high *a priori* road" they felt themselves safe; to them the *a posteriori* road was a tortuous lane leading them into probable danger.

Greek *Physics* is of a singularly fragmentary character. **Pythagoras** evidently knew something of the properties of *stretched strings*, and was acquainted with the same results as the modern schoolboy who experiments with a monochord. **Archytas** was interested in the same subject. **Empedocles** held a theory that *light* travels and takes time to pass from one place to another. **Archytas** also wrote a treatise on *mechanics*, but it was **Archimedes** who developed this subject, and his *statics* held the field until the sixteenth century. (*Dynamics* had to wait for Galileo and Newton.) Archimedes' various mechanical inventions have always been interesting to schoolboys. If Archimedes really did harass the blockading Roman fleet by means of "burning-

glasses", it is much more probable that he used reflectors rather than refractors. Another famous inventor of mechanical appliances was **Hero** (c. A.D. 100), the Alexandrian engineer, in one of whose works is described about one hundred small machines and mechanical toys; e.g. a working steam-engine, and a double forcing-pump. Hero also showed that the angles of incidence and reflection of light are equal.

Probably the most noteworthy advance in physical science was made in *hydrostatics* by **Archimedes**. It is, however, doubtful if the account usually given of the bath-*"heureka"* incident is correct. Archimedes usually devised some scheme for first working out his various problems practically, thus getting a possible hint for a later mathematical demonstration. When he stepped into a bath full of water, the volume of water which overflowed must have been equal to the volume of that part of his body under the water still in the bath. Hence by immersing himself completely, and afterwards measuring the volume of water that had overflowed, he would know the volume of his body. The teacher of hydrostatics uses the principle of this scheme when dealing with relative densities. Into a beaker completely filled with water he lowers a suspended piece of, say, iron, and catches in an outer vessel the water that overflows. He now weighs the iron, dry, and then weighs the water that has overflowed. Clearly the former result (say 24 oz.) divided by the latter (say 3 oz.) gives the density of the iron in terms of water. If Archimedes worked this experiment, as presumably he did, first with a piece of pure gold, then with a piece of pure silver, and lastly with the suspected mixed-metal crown, he would have had all the data for solving the problem which the king had given him. The study of the upthrust of the water, and the discovery of the principle that a body immersed in water loses a part of its weight equal to the weight of the corresponding volume of water (a principle commonly known as Archimedes' principle) was in all probability the result of subsequent cogitation over the practical result. All that he had got in his mind when he

excitedly shouted "heureka" was only the germ of the principle, though a very fruitful germ it must be admitted. Great discoveries do not usually come down ready made from heaven, even to great discoverers.

As a science, *chemistry* was completely unknown to the Greeks, though the dyer, the perfumer, and the apothecary, had all established flourishing trades. But the trade secrets, not improbably obtained from Egypt, were too precious to be revealed and were never developed into a branch of science.

It therefore follows that there was no theory of chemistry, and yet, singularly enough, birth was given to the idea of the **atom** as far back as Ionian times. **Anaxagoras** advanced the view that the material cosmos had come into existence by the combination and differentiation of "seeds" of matter, and it was these seeds that led to the conception of the atom.

Ice turns into water, water into vapour; rocks turn to dust. Thus great masses change to small particles. Moreover, vapour vanishes, and dust disappears, and yet clouds and fogs make their appearance, and dust seems to accumulate from invisible sources. It seemed perfectly reasonable to assume that visible things are resolved into invisible particles, and that these in their turn condense into new substances. **Leucippus** (c. 460 B.C.) assumed that atoms were infinite in number, indivisible, ever in motion. **Democritus** (c. 460–370 B.C.) not only agreed with Leucippus but held that the world, together with all it contains, was produced by the moving atoms.

Be it observed, however, that this theory of atoms is not based on experiments of any sort and has no relation whatever to the atomic theory developed by Dalton more than 2000 years later. It was a mere conjecture put forward as a possible explanation of the appearance and disappearance, of the birth and death, of things. Democritus, one of the last of the great Ionians, was a very able mathematician, but like most of the Greeks he was prone to speculation. That he

happened to hit the mark in this particular case was just a piece of great good luck. It did nothing to enhance his deservedly great reputation.

The general outlook of the Greeks on physical science may be most correctly gauged from the works of the founder of the Athenian Academy, **Plato** himself. He embodied most of his views on the subject in the *Timæus*, which, however, has been well described as by far the most obscure of all the Platonic dialogues. Apparently Plato's intention was to include such knowledge as he had then acquired concerning the material parts of the universe, and he outlines an extensive scheme of mathematical and physical doctrine. Briefly, the Dialogue treats of "harmonical sounds", "visual appearances"; light, heat; the motions of the planets and the stars; water, ice; iron, rust, gold, gems, and other natural objects; colours, tastes, hearing, sight; and the whole domain of physiology. Plato's views on mathematics were sound enough, as might be expected, but his views on physics, chemistry, and physiology will not bear a moment's examination. On physiology, in particular, his views are of the most fantastic kind. For instance, the processes of digestion are said to be carried on by the superior sharpness of the triangles of the substances forming the human body, as compared with the triangles of the substances which are taken into it by way of food. The reader of the Dialogue is half repelled, half amused; but above all, he is puzzled how such stuff could have emanated from the mind of so great a thinker. What is the explanation? Why did Plato attempt to give a teleological meaning to the universe and everything in it on the strength of the very few basic facts of physical science with which he was acquainted? Why did such utterly irrational views enthrall the imagination of a large part of mankind for nearly 2000 years?

The vice of the Greeks was their indulgence in speculation. Their *a priori* notions were out of all proportion to their experience. They hardly ever tried experiments that would prove or disprove their theories. They tried to conceive the

whole of nature, though having a wholly inadequate knowledge of its parts. They generalized from superficial resemblances, and remained unsuspecting of deeper differences. They were dominated by their own abstractions. They were full of original thoughts, but they were liable to be imposed on by the most obvious fallacies. They were constantly deceived by analogies. Language exercised a spell over them.

Plato, great as he was, did not escape the infection.

Plato was a mathematician, and lived in a mathematical environment, and he seems to have been obsessed with the idea that the universe and everything in it were based on very simple geometrical and arithmetical foundations. The number sequences 1, 2, 4, 8, and 1, 3, 9, 27, were extremely common in mathematics: why, then, should they not be equally common in other branches of knowledge? The triangles 30° , 60° , 90° , and 45° , 45° , 90° , were at the very bottom of a vast amount of geometry; why should they not be of universal application? Assuredly, it was argued, the regular mathematical solids must supply the key to the structure of the universe.

Science had not then been differentiated into branches and it never occurred to the Greeks that numerical and geometrical relations which obviously applied to astronomy did not also apply to everything else. Hence when Plato laid it down that the earth was composed of cubes, the air of regular octahedra, water of regular icosahedra, fire of regular pyramids, and the human body of triangles, he was simply inventing hypotheses that seemed to square with the most basic conceptions of all, viz. mathematical conceptions. All nonsense? Yes. Utterly unrelated to verifiable facts? Of course. But a carefully thought out and reasoned scheme? Undoubtedly.

The only scientific *facts* of which the Greeks at that time were well informed were the facts of number and geometry, and having observed that these facts applied in a few instances, especially in astronomy, they applied them everywhere.

And it is only fair we should bear in mind that, after all, modern physics and modern chemistry are, at bottom, *quantitative*: the Greek instinct for mathematical relations was therefore right. That in those early days they should try to make such relations apply universally was not unnatural.

The *Timæus* is utterly unscientific, for it is a mass of conjecture. It is conjectural astronomy, conjectural physics, conjectural physiology, conjectural medicine. On the other hand Plato says repeatedly that he is putting forward views that are probable only.

Yet the *Timæus* remains the greatest effort of antiquity to conceive the universe as a whole.

Universe makers are still with us. What will our descendants of 2000 years hence think of them? They know more facts than Plato did, but, even so, how few facts they *know*!

BOOKS FOR REFERENCE:

1. *Short History of Science*, Sedgwick and Tyler.
2. *Dialogues of Plato: Timæus*, translation and introduction by Jowett.
3. Aristotle's Works on Physics, Astronomy, &c., (historically all of great interest).

CHAPTER XII

Roman Science

During the slow decline of Greek learning, two new and powerful states were rapidly developing on opposite sides of the mid-Mediterranean, Carthage and Rome. In the end Rome not only overthrew Carthage, but became mistress of the rest of the world as well. The Roman Empire was even more extensive than the Empire of Alexander 300 years before.

It is a little misleading to talk of "Graeco-Roman" civilization. The two races, the Greeks and the Romans, had hardly anything in common. The outlook of the one was as the poles asunder from the outlook of the other, and the reason for it is very hard to find.

The Romans, like the Greeks, were a hybrid race, yet the two races must have had in some measure a common ancestry. Southern Italy and Sicily were colonized by the Greeks at least as far back as Ionian times. The great Etrurian Empire west of the Apennines, which was not finally reduced by the Romans until the third century B.C., was probably also founded by emigrants from the east, perhaps western Asia Minor. Could the fusion of these immigrants into Italy with the aboriginal peoples of the peninsula have produced the type of people we know as "Roman"? We simply do not know. The essential fact is that the hybrid stock, whatever its origin, was in all essential characteristics completely different from that other hybrid stock which came into being a little earlier around the shores of the Ægean.

Above all things the Romans were a *practical* people. They were by nature constructive, whether in government,

in law, or in building. They had no sympathy whatever with the Greek tendency to indulge in abstractions, or, as they would have said, in Greek "sophistical futilities". The Romans were organizers and men of action. The Romans *did* things; the Greeks talked and argued about them. The Roman was curiously like the modern Englishman and Scotsman; he hated mathematics, and his natural tendency was therefore to shirk any sort of analysis, any kind of rigorous reasoning. Science he was inclined to treat with scorn; the building up of a body of abstract doctrine was alien to his nature. Most of the science he ever knew he obtained either from Athens or from Alexandria. Rome did not produce a single creative man of science, not a single mathematician of eminence. Yet, somehow, one would rather have lived with a Roman than with a Greek. One attractive side of the Roman was that he loved the countryside and was a naturalist; he loved his cattle and his crops, his birds and his bees, his fruit and his flowers. For these things the Greek had little affection though he catalogued them all. It is hard to weigh men of thought against men of action, and it would be rash to try to assess the relative values of Greek and Roman.

The few important Roman works dealing with science that have come down to us seldom reveal any sort of expert scientific knowledge; they deal in the main with the implications of science rather than with science itself, more especially with the implications from the standpoint of philosophy. Of such works the most noteworthy is *De Rerum Natura* by the poet **Lucretius** (c. 95-55 B.C.) a contemporary of **Cicero** and **Julius Cæsar**. Following Democritus, Lucretius explains the origin of the world as due to the interaction of *atoms*. But his atomic views are not based on experiments of any kind; like those of Democritus they are purely conjectural:

" How different is fire from piercing frost!
Yet both composed of atoms toothed and sharp,
As proved by touch . . .
How different, then, must forms of atoms be
Which such sensation varied can produce!"

There is nothing of the patient observer about Lucretius. He deals interestingly with large-scale phenomena like thunder and lightning, volcanoes and water-spouts, pestilences and suffocating vapours. His descriptions are full of interest and the book is a remarkable production, though as a treatise on science it is a poor thing.

In his eightieth year, Varro (116–27 B.C.) wrote *Res Rusticæ*, a treatise partly on agriculture, partly on natural history. Did he “anticipate” the modern discovery of the nature of malaria? He says: “In building houses, avoid the neighbourhood of marshes, because when the marshes begin to dry they engender a multitude of invisible insects which are introduced into the mouth and nostrils with the inhaled air and occasion serious illness.” The term “invisible insects” is hardly suggestive of mosquitoes, and Varro probably did not suspect the real cause of malaria.

Julius Cæsar himself has some little claim to be enrolled as a man of science, for he rectified the then highly confused calendar and he undertook a survey of the whole Roman Empire.

Vitruvius (c. 14 B.C.), a Roman architect and engineer, wrote *De Architectura*, a famous ancient work on architecture and building that became the text-book of the builders during the Middle Ages and the Renaissance.

The elder Pliny (A.D. 23–79) wrote a *Natural History*, but his descriptions of natural phenomena are uncontrolled by scientific standards of any kind, and it is obvious that he is devoid of any great critical power. His main sources of information are Aristotle and Theophrastus, but as a scientific observer he is not in the same class as they are, by a very long way.

Natural phenomena is the subject of the *Questiones Naturales* of Seneca (3 B.C.–A.D. 65), but, like Pliny’s natural history, it is borrowed material. Seneca was a very great Roman, but in the advancement of science he occupies a very small place.

Roman *Medicine* is of little importance. Rome produced

no medical practitioner of eminence. **Celsus** compiled a very readable medical work about A.D. 30, in which he describes Alexandrian surgery. A little later **Scribonius** wrote a "receipt" book, following the very unscientific method, which became so popular in the Middle Ages, of beginning with the head and working down to the feet, entirely disregarding the relations and functions of the internal organs. A little later still, **Pliny** wrote a treatise giving details of a vast series of remedies built on the supposedly firm ground of "experience". Pliny was a "scorner of medical science and of the starveling Greeks who practised it." The "experience" "was based on no theory, supported by no doctrine, founded on no experiment". Any corpus of doctrine, however carefully thought out, was scorned. "Experience, not theory" was the cry for the next 1500 years. And that same cry is still occasionally heard. The agricultural expert who advised the unintelligent Essex farmer to adopt more scientific methods was met with the reply, "this farm has been in my family for five generations, and yet you come here and tell me how to run it." The trained health visitor who advised a London mother on infant feeding was told afterwards that the mother had said, "a lady called this morning and told me how to bring up my children, and she an old maid, too. Why, I have had twelve and have buried six, so I do know something about it. An ounce of experience is worth a ton of theory any day."

If in medicine the Roman achieved but little, in the matter of hygiene he was a model for the ancient world. With the Romans the consideration of public health was almost an obsession. Sanitation was a feature of Roman life. Streets were kept scrupulously clean, and no modern city is better supplied with water than was Rome. The visitor to Rome may still see the remains of the fourteen great aqueducts which supplied the city with 300 million gallons of water daily. The Roman sewerage system has probably never been equalled.

However backward the Romans may have been in science

they excelled in the practical arts. They were highly efficient surveyors, map-makers, architects, builders, and engineers.

A very difficult problem which the Romans attacked and solved was that of spanning large openings and large enclosed spaces: it was solved by the invention of the *arch* and of the *vault*. The arch and the vault were not unknown to the Egyptians, the Assyrians, and the Etruscans, but they were first developed systematically and constructed in a large scale by the Romans.

Until that time the maximum width of a room had been limited by the possible lengths of the timber obtainable for making the roof; the only alternatives had been to divide the width of the room by a series of supporting columns. With the introduction of the arch the difficulty disappeared. A one-arch bridge might, for instance, be made to span a wide river.

The main difficulty to be considered in the construction of an arch is not the cutting of the constituent blocks of stone to shape and fitting them together, but the necessary provision for dealing with the thrust due to lateral pressure.

If the reader is unacquainted with the elementary principles of engineering, let him place two similar fairly tall stools a foot apart, and stand on them, one foot on each. Obviously the stools support his weight, and the system is a fairly stable one. Now repeat the experiment, with the stools *two* feet apart. The position is less easy to maintain, for the tendency is for the stools to be pushed *outwards*, though they still support the weight. The reader's two legs may be regarded as a bridge, and the rest of his body the weight which the bridge has to carry. The greater this weight, or the greater the distance between the stools, the greater the lateral thrust.

Thus a bridge builder has to build supporting piers which will not only carry the weight of the bridge but will resist the lateral pressure, and if the bridge be very wide or the weight it has to carry be very heavy, the lateral pressure will be great. To ensure stability, the problem is a really

difficult engineering problem, and the Romans were the first to solve it successfully. Of course if the bridge is level and is divided into several arches, the problem is simpler; the equal and opposite thrusts of the intermediate arches on the supporting piers are merely compressional; the thrust on only the outer piers now affords the engineer trouble.

It was just this kind of problem that the Romans solved so readily and so well. The arch came to be universally used in their buildings—doors, roofs, theatres, amphitheatres, fortresses, bridges, aqueducts, reservoirs, baths, dams, and main drains. Roman building tackle—cranes and derricks, multiple pulleys, windlasses—seems to have been particularly well designed. A Roman crane is shown in Plate 4.

Plate 5 (i) shows *Le Pont du Gard*, a Roman aqueduct near Nîmes, “un des plus beaux monuments que les Romains aient élevés en Gaule”, built to convey water to the town from springs twenty-five miles away. It is a vast structure, still “one of the wonders of the world”, rising 180 feet above the bed of the river. The huge blocks of stone were put together, and have held together, without any mortar or cement for close upon 2000 years, and are likely to hold together for thousands of years more. Plate 5 (ii) shows the squared water-channel on the top of the arches, at a place where the roofing stones have now disappeared. The great thickness of calcareous deposit, left by the water flowing through the channel for centuries, creates in the visitor the impression that the Romans must have raised to this great height vast masses of natural rock. The size of the channel may be estimated from the figure of the lady who allowed herself to be specially photographed for purposes of comparison.

There can be no doubt that the technical knowledge of the Romans in engineering, mechanics, hydraulics, architecture, bridge-building, and road-making, was of the highest order. The structural stability of much of their work may, even to-day, be readily verified on the spot. The surviving remains at Rome and elsewhere have impressed modern

architects and engineers from all over the world, and are likely to impress them for many centuries still to come.

When Alexandria fell into the hands of Rome in 30 B.C., it was at the zenith of its glory, but from that time onwards there was a slow period of decline, though it still continued to be a leading centre of learning for several centuries. The supply of intellectual giants had become exhausted: the genius of great originality and inventiveness was extinct. Most of the future Alexandrian teachers were merely students of older works, commentators, and co-ordinators, and they gradually accepted lower standards. Astronomy reverted to astrology. All learning tended to become superficial.

Perhaps the most serious factor in bringing about the decline was official Christianity, which, as soon as it felt itself strong enough, became bitterly hostile to Greek learning of all kinds. It seems to have disliked intensely the neutrally religious and non-moral intellectual attitude of Hellenism. Any form of learning that was not in positive and active sympathy with the new religion was assumed to be its enemy.

In the second century, Justin Martyr said, "what is true in Greek philosophy can be learned much better from the prophets". A little later Tertullian maintained that "since the time of Jesus Christ and His gospel, scientific research has become superfluous". In the third century, Clement of Alexandria "called the Greek philosophers robbers and thieves who had given out as their own what they have taken from the Hebrew prophets". In the fourth century, Lactantius "ridiculed the doctrine of the spherical figure of the earth and the existence of the Antipodes". Later, Isidore of Seville condemned Christians who occupied themselves with heathen books, "since secular learning develops pride in the soul". In the fifth century, even that very moderate man, Augustine, who in his younger days had been a student of Plato as well as of St. Paul, maintained that there is no historical evidence for the existence of the antipodes; it was a mere assumption that the opposite side

of the earth, " which is suspended in the convexity of heaven", is inhabited.

The last mathematician of note at Alexandria was a woman, **Hypatia** who was murdered at the instigation of the Christians, A.D. 415.

The last eminent Roman who studied the language and literature of Greece was **Boethius** (A.D. 450-524), who was born just as Rome fell. He was the author of books on music, arithmetic, and geometry, the geometry consisting of some of the simpler propositions of Euclid. What a contrast with the age of Archimedes 700 years before. The intellectual poverty of the time was such that those elementary books served for many centuries to set the standard of mathematical teaching.

Ever since the time of Plato, a certain number of professional mathematicians had lived in Athens, and after the murder of Hypatia students migrated to Athens from Alexandria. But in 529 the Christians obtained from Justinian a decree that " heathen learning should no longer be studied in Athens ", and the Athenian School was thereupon closed.

The greater part of the library and museum at Alexandria was destroyed by the Christians at about the same time. In A.D. 641 the city fell to the Mohammedans who destroyed the university buildings and the remains of the library; again in the name of religion.

Intellectual Athens, Alexandria, and Rome, all dead. Fanaticism had made men afraid to think. And they ceased to think.

BOOKS FOR REFERENCE:

1. *History of Science*, Sedgwick and Tyler.
2. *Legacy of Rome*: (i) *Science*, C. Singer; (ii) *Architecture and Art*, G. M. N. Rushforth; (iii) *Building and Engineering*, G. Gio rannoni; (iv) *Agriculture*, W. E. Heitland.



The actual Aqueduct over the Arches

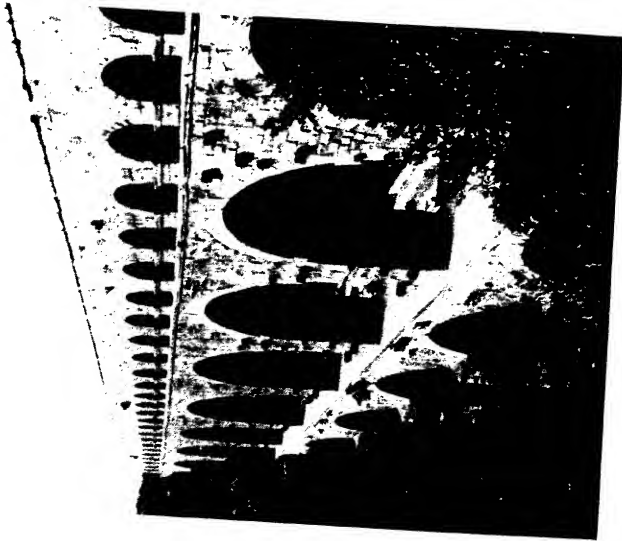

Roman Aqueduct, *Le Pont du Gard* (Nîmes)

CHAPTER XIII

A Thousand Lean Years

The ancient Roman Empire in Europe included modern Italy, France and Belgium, England, Spain, and the country along each side of the Alps and Carpathians and along the river Danube to the Black Sea. Outside the Empire to the north, beyond the Rhine and Danube, was a number of powerful "barbarian" tribes, mostly of Teutonic origin; the *Franks* on the lower Rhine, the *Jutes* in Denmark, the *Angles* in Schleswig-Holstein, the *Saxons* in the district of the lower Elbe and Weser, the *Vandals* between the Oder and Vistula in North Germany, the *West Goths* in the great bend of the lower Danube, the *East Goths* to the north-west of the Black Sea, and the savage *Huns* between the Black Sea and the Caspian. (The names of the modern countries will make identification simple.) In the early centuries of the Christian era all these tribes were rapidly increasing in numbers, and by the fourth century they had become very powerful. That they were entirely untutored and uncultured is probably true, and to that extent the term "barbarian" is aptly applied to them. But they were young and vigorous races, and gifted with natural intelligence and cunning. With their increasing numbers, they required new lands to live in, and quickly discovering the signs of decay in the once mighty Roman Empire, it was only a question of time before they made a forward move. From the end of the third century to the end of the seventh—for 400 years—the southern half of Europe was the scene of a great struggle between the old races and the new.

All schoolboys know that the Saxons and the Angles came over and took possession of Britain soon after the Roman garrisons had been called away to help defend Rome, but not all of them are aware that the British struggle was only a small part of the far greater struggle on the Continent. The Romans made no attempt to hold Britain: they were too hard pressed nearer home. When, a little later, the Saxons and the Angles were carving out Britain for themselves, the Franks took possession of Gaul and made Paris their capital. But it was the Goths, the Vandals, and the Huns that were the main factor in the general break-up of the Roman Empire. They began their attacks as early as the third century, and in the fifth century they carried everything before them, one or more of them at different times making their way eastwards into the Asiatic provinces, southwards into Italy, and westwards into France and Spain, and even on into northern Africa. Sometimes the "fall" of the Empire is dated from the sack of Rome by the Goths in A.D. 410, sometimes from the sack of Rome by the Vandals in A.D. 455, sometimes from the dethronement of the youthful emperor and the establishment of a Gothic kingdom in Italy in A.D. 476. But these are mere passing incidents in the Empire's long dissolution. The "Empire" did not however really die at Rome in the fifth century; it died at Constantinople 1000 years later. (Fig. 16.)

From the first the Roman Empire had been divided into two parts, the Hellenic East with its essentially oriental culture, and the Roman West consisting mainly of Italy, the small provinces north of the Adriatic, France, Spain, and N.W. Africa. The division was deep, and it ultimately led to the parting of the Empire into eastern and western halves. As early as the second century the Roman emperor had to devote a great deal of time to the turbulent peoples in the east, and apparently they became enamoured with eastern institutions and cults. The Emperor Constantine (A.D. 270-337) transferred his capital from Rome to Byzantium, renaming the city Constantinople, after himself. Henceforth

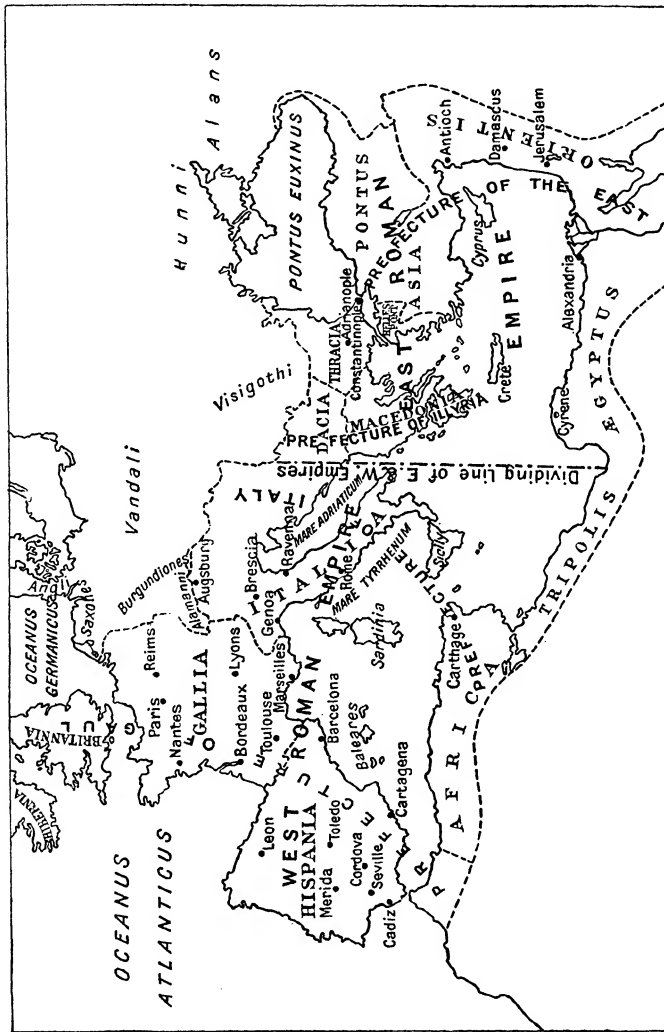

Fig. 16.—Map of the Roman Empire on the Eve of the Barbarian Invasions

Italy ceased to enjoy primacy. Gradually the Empire fell virtually asunder; it became two instead of one, and in the western half the Church instead of the State became the basis of life, with its head-quarters at Rome. Even from the end of the third century there had been "for the purposes of efficient administration" two emperors, one in the East and one in the West, but the emperors in the West, at Rome, soon took a second place to those in the East, and finally became little more than puppets in the hands of the Bishops of Rome (the Popes). Constantinople, not Rome, became the head-quarters of the Empire, and there the real emperor ruled.

For the thousand years 700 B.C.—A.D. 300, the State was the unit of life, and political interest was dominant; religion was a dependency on the State: this was the essence of Greek civilization. But for the next thousand years there was, in the West, a transfer of interest; the religious motive, or perhaps we should say ecclesiastical interest, was dominant; and this lasted until the great Church of the Middle Ages began to totter during the Pontificate of Boniface VIII. This does not apply to the Eastern Empire at Constantinople where the State remained supreme and survived until Constantinople was taken by the Turks in 1453. There was, it is true, still an Empire in the West, but there the Church, not the State, was supreme. And it was during this long supremacy of the Church that the world remained in intellectual darkness.

Although the Western Empire "fell" soon after it became a Christian society, this society gradually absorbed into itself the barbarians from the north, and thereby became greatly strengthened. Actually the Western Empire survived, though it survived as a mere shadow; it had no emperor, it had not even a capital: the Bishop of Rome was the real master. On the other hand the East had steadily drawn itself away from the West, and the emperor at Constantinople was head of the Eastern Church, the Church being a department of the State. This Eastern conception of State and Church

was inherited later by the Russian czars and by the Turkish sultans. Until the coronation of Charlemagne, the emperor at Constantinople was recognized, not only by the barbarian kings in the West but by the Bishop of Rome himself, though as time went on this recognition seems to have become more and more nominal. It was a sort of nominal recognition of the suzerainty of the Byzantium successors of Constantine. But with the Emperor far away at Constantinople, the Bishop of Rome was able to strengthen his position, and people began to look to him for political guidance just as they had formerly looked to the emperors. It was just as Rome "fell" that the supremacy of the Papacy came to be generally recognized in the Western Empire. To churchmen Rome still remained the capital of the world. Alcuin of York wrote (c. A.D. 800), "Roma potens, mundi decus, inclita mater".

A change came in A.D. 800. Charlemagne, a great statesman, soldier, and legislator, king of the Franks, made himself master of practically the whole of the Western Empire, and as he had championed Christianity the Pope was not only on his side but crowned him emperor at Rome in A.D. 800. Formally this was a transfer of the "Empire" to the Germans, but Charlemagne did not attempt to lay hands on the East, and the emperor at Constantinople was wise enough to ignore these western events. No doubt the Church hoped that, with a strong Western emperor as its ally, its own position would be greatly strengthened. Charlemagne was a wise and powerful ruler, and there were signs that Europe was settling down after the hundreds of years of warfare. But now invaders, Norsemen from the north-west, Hungarians from the east, Slavs from the north-east, were already under way. The Norsemen invaded England (we called them Danes), gave our own Alfred much trouble, and eventually gained the ascendancy; they invaded France, and settled down as the owners of Normandy. Europe remained in a turmoil until the eleventh century. Charlemagne's successors were weak. The Church was growing in strength. (Fig. 17.)

Until the Pontificate of Gregory VII (1073-85), the western world was under the dual authority of the emperor at Aix-la-Chapelle (his capital), and the Pope at Rome. But Gregory VII decided that the time had come to assert the supreme power of the Church. The German emperors at Aix-la-Chapelle were far too weak for a struggle with the now powerful Church. Though nominally kings of Germany, France, and Italy, the emperors had little real power; the cities of Italy were virtually independent, and tribalism and feudalism in Germany were defiant. In diplomacy the emperors were no match for the subtle churchmen. Henceforth, until the beginning of the fourteenth century, the Church was supreme. It dared to call upon even kings to abase themselves; it dared to put England under an Interdict. It dared to outlaw the English clergy. It went too far. Nationalist France eventually asserted itself, and Boniface VIII, the most famous of the popes, was arrested and imprisoned in 1303. Thereafter the power of the Church began to wane.

The sixth, seventh, and eighth centuries (c. A.D. 500-800) are appropriately known as the Dark Ages. Dawn broke once more with Charlemagne, who determined to promote learning as far as he was able, and he commanded that schools should be opened in connexion with all the monasteries. This was done under the direction of an Englishman, *Alcuin*, and men of all races flocked to the court of Charlemagne to place themselves under Alcuin's guidance. The curriculum included mainly theology and history, but a simple course of mathematics, following the lines of *Bœthius*, was included for the instruction of the young. After the death of Charlemagne, many of these schools continued to exist, but mathematics and science were for the most part dropped. A few of them had eminent teachers and became prominent, and the work they did gave rise to the term "Scholasticism", a term which eventually characterized the general intellectual activity of the Middle Ages, connoting the study of mainly philosophy and theology carried on for the most part in the

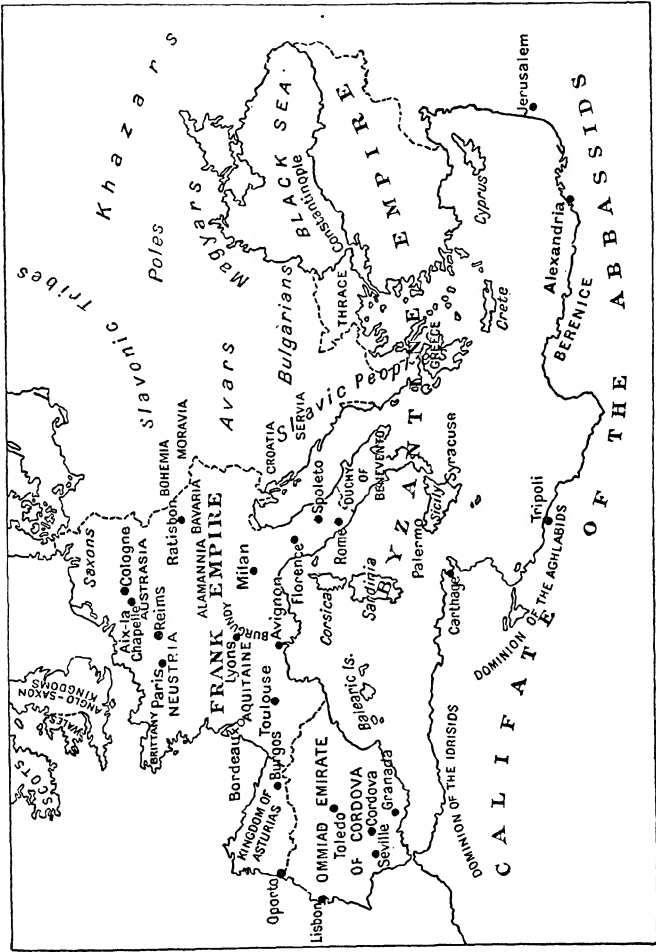

Fig. 17.—Europe in the Age of Charlemagne

abbeys and the monasteries. In its wider sense Scholasticism extends from the ninth to the fourteenth centuries, but the eleventh, twelfth, and thirteenth were the most productive, especially the thirteenth, which includes the names of **Albertus Magnus** and **Thomas Aquinas**. Plato was not available for the students of Scholasticism, and he would probably have been rejected if he had been; his dialogues might have proved too great a solvent for their dogmas! But Aristotle became available, and the Bible and Aristotle were the two great books of the whole movement. Mediæval thought was shaped partly by the traditions of Aristotelian logic, partly by the system of Christian theology. Throughout, the attitude of the schoolmen was that of interpreters and defenders, not that of independent investigators. They strove to place the dogmas of Christianity in a position of unassailable defence. During these 400 or 500 years some of the most brilliant men of the time devoted their great intellectual gifts not to the search for new things but to the putting of a ring fence round the old. Their conclusions were predetermined. They saw everything through the medium of Aristotelian logical formulæ. They did not dare give their reason free play, as the Greeks had done; they were subject to the iron authority of the Church.

But the fact that they *did* reason meant that, in the long run, the doctrines of the Church would inevitably be rationalized, and so it came about that, as time went on, doctrine after doctrine was withdrawn from the possibility of rational proof and relegated to the sphere of faith. Faith was something to which homage must be made, not something to be cross-examined. Thus logic and theology not only refused to be reconciled, but soon began to feel an imperative need of independence. The ultimate result of Scholasticism was therefore something entirely unexpected—the emancipation of Reason, and then the fearless, even the aggressive, assertion of its independence. It was in this way that light broke through the darkness of the Middle Ages. The Renaissance was at hand.

The Renaissance is the name given to the complex movement which marks the birth of modern Europe. It connotes the rebirth of intellectual liberty, the recognition of the power of self-determination, the throwing aside of superstitious reverence for authority; the encouragement of learning and of the study of nature. It began in the thirteenth century, when at places as far apart as Oxford and Cambridge, Paris and Bologna, a keen desire for knowledge was showing itself. The Crusades, and the travels of enterprising scholars, had reopened intercourse with the ancient East. When Constantinople fell, a stream of Greeks, bringing with them almost all the culture that had survived the dark ages, fled westward, and the revival of ancient learning, begun so well by the Italian poet Petrarch a century before, quickly extended throughout Western Europe.

The thousand-odd years between the entombment of classical learning and the Renaissance may be conveniently mapped out into a succession of periods: the reader should not attach too much importance to a century or so; there were no lines of demarcation.

200-500	Evening closes in.
500-800	Night.
800	First signs of dawn.
800-1000	Twilight, with thick mist.
1000-1200	Morning; mist gradually thinning.
1200-1400	Light breaks through clearly at intervals.
1400-1600	Clear sunlight.

But it must not be thought that, because there was a long period of intellectual darkness, the world was then asleep. Old nations were dying: new nations were being born. Men were striving as they had seldom striven before, some assailing ruthlessly, some defending desperately, all carving out a Europe for the centuries that lay ahead.

Finally, it must not be assumed that mediævalism made no sort of contribution to science. It made no great discoveries, it is true. But it prepared the way. The main

premisses on which the schoolmen based their reasoning were often unsound, were indeed often absurd. But if those premisses be accepted, the reasoning that followed from them was often unexceptionable in its rigorous and faultless logic. Thus more and more men put their faith in *reason*, and so they gradually became imbued with the inexpugnable belief that any event can be correlated, in a perfectly definite manner, with its antecedents. It is this basic belief, " vividly poised before the imagination ", that is the real motive power of all research workers.

BOOKS FOR REFERENCE:

1. *Decline and Fall of the Roman Empire*, Gibbon.
2. *History of the Later Roman Empire*, J. B. Bury.
3. *The Idea of Progress*, J. B. Bury.
4. *Decadence*, A. J. Balfour.
5. *The Roman Fate*, W. E. Heitland.
6. *The Legacy of Rome: The Conception of Empire*, E. Barker.
7. *The Legacy of Greece: History*, Arnold Toynbee.
8. *Medieval Contribution to Modern Civilization*, Hearnshaw.
9. *The Middle Ages, 300-1500* (2 vols.), J. Westfall Thompson.
10. *Introduction to the History of Science*, Vols. I and II, G. Sarton.

CHAPTER XIV

The Hindus and the Arabs

Outside the two halves of the old Roman Empire—the surviving Eastern half, far more Greek than Roman, with its emperor as Head of State and Church at Constantinople; and the Germanized Western half with its emperor on the Rhine and its spiritual Head on the Tiber—two other peoples had awakened, and these made a considerable contribution towards the new intellectual world which emerged at the Renaissance. We refer to the Hindus and to the Arabs.

(i) Contributions by the **Hindus**.—Intercourse with India had been stimulated by Alexander's conquests, and, in the centuries that followed, the Hindus were able to make substantial contributions to mathematical science just where the Greeks were relatively weakest, viz. in arithmetic, algebra, and trigonometry. The names of **Arya-Bhata** (c. A.D. 480), **Brahmagupta** (c. A.D. 600), and **Bhaskara** (c. A.D. 1120) are closely associated with it, Bhaskara making a great advance in abbreviated algebraic notation.

But in comparison with Greek mathematics, Hindu mathematical power and freedom were gained at the cost of much logical rigour. The Hindus had little interest in mathematical *method*. They shirked logical definitions, preserved little logical order, and were generally indifferent to fundamental principles. Unlike the Greeks they had no great power of thinking spatially; on the other hand they were good at algebraic manipulation.

(ii) Contributions by the **Arabs**.—**Mohammed** (A.D. 569–632), made himself the autocratic ruler of Arabia, and within a century his fanatical followers had conquered Asia

Minor and Mesopotamia, the northern shores of Africa from Egypt to Gibraltar, and Spain. They did not receive a serious check until they got into France, when they were turned back. Although at Alexandria they had destroyed the world-famous university library—one of the greatest disasters of all time, for in those days copies of original MSS were very few—they now settled down in the various countries they had conquered and patronized learning. The **Moors** who invaded Spain were not of Arabian stock; they came from northern Africa, having embraced Mohammedanism from their Arab conquerors.

On the capture of Alexandria by the Mohammedans, the majority of the philosophers who had been teaching there emigrated to Constantinople which then became the centre of Greek learning in the East and remained so for 800 years. Within a century or two of their arrival, the Arabs began to collect Greek manuscripts, and they may have obtained some from Constantinople itself, though it is very uncertain what had happened to the many manuscripts that had been dispersed, when, in accordance with the order of Justinian, the Greek schools were closed. From one source or another, however, they obtained a very considerable number. Moreover they observed that the Greek medical practitioners who attended the caliphs in Bagdad depended for their medical science on the writings of Hippocrates, Aristotle, and Galen. Before the end of the ninth century the Arabs had made translations of the works not only of those three Greek writers but also of those of Euclid, Archimedes, Apollonius, and Ptolemy. Further, they sent a special embassy to India, to obtain copies of the works of the Hindu writers. All Arab science was, in fact, built on Greek and Hindu foundations.

Alkarismi (c. A.D. 830), librarian to the caliph **Al Mamum**, wrote an algebra founded on the work of the Hindu **Brahmagupta**, and it became the basis of many subsequent Arab works. The work was termed *al-gebr* which means "restoration", and refers to the fact that in an equation any

given quantity may be added to or subtracted from both sides of the equation.

Al-Hazen (A.D. 965–1030) wrote a book on optics which includes the earliest scientific account of atmospheric refraction. He also made a study of spherical and parabolic mirrors.

The Arabs accepted the astronomical views of Hipparchus and Ptolemy. The caliph **Al Mamum** himself, son of the caliph **Haroun-al-Raschid**, a contemporary of Charlemagne, did much to encourage astronomy, and personally gave exact detailed instructions for the measurement of a degree of latitude on the plains of Shinar.

Arab schools continued to flourish until the fifteenth century but produced neither a man of science nor a mathematician of outstanding ability. But in arts and crafts and industries they were easily first of their time. This is well exemplified by the remarkable work of the Moors in southern Spain during the tenth century.

It is interesting to observe that there was relatively little hostility between science and the Mohammedan Church, as for many centuries there was between science and the Christian Church. Arab workers and thinkers were not discouraged, and they never worked with the fear of some dire punishment overtaking them. Yet no very great original ideas can be attributed to the Arabs, though they had a remarkable aptitude for absorbing the ideas of other peoples. In observation they were accurate; in algebraic manipulation, skilful. Their great merit was that they preserved the discoveries of the Greeks through the dark ages, and kept alive the interest in science.

The Arabs were, however, too fond of the fantastic and the occult, of horoscopes and talismans, of astrology and the transmutation of metals. They left us a heritage even smaller than did either the Egyptians or the Babylonians.

BOOKS FOR REFERENCE:

1. *A Short History of Mathematics*, W. W. R. Ball.
2. *A Short History of Science*, Sedgwick and Tyler.

CHAPTER XV

The Morning of the European Renaissance

The Thirteenth Century

The transmission of Greek learning through the centuries following on the fall of Rome to the dawn of the Renaissance in western Europe was effected in various ways; there was a small direct inheritance from the Italian peninsula itself; there was a substantial contribution that came indirectly from the Moors in Spain; and there was a still more substantial contribution from Constantinople. But Latin and Arabic translations were much more common than copies of Greek originals, and many of these translations were so badly done and were so inaccurate as to be seriously misleading. It thus came about that the philosophy so warmly defended by the earlier Schoolmen, on the ground that it could not be disputed because of its Aristotelian origin, often misrepresented what Aristotle had really said. At a later stage of Scholasticism, faithful copies either of the great originals or of accurate Latin translations became available, and by about 1225 the complete works of Aristotle were in the hands of scholars. In the earlier centuries of Scholasticism Aristotle had been known merely as a dialectician.

There were signs of a revival of learning as early as the close of the eleventh century, especially at certain of the monastic schools; and, in the vicinity of several of these,

teachers who were not actual members of the schools settled down as lecturers. As the students of such a centre grew in numbers, common interests were developed, and an association of the nature of some sort of guild (*universitas*) was formed. This was the first stage in the development of the earliest mediæval universities. Such voluntary associations were formed in Paris, Bologna, Salerno, Oxford, and Cambridge. Gradually they became independent of the neighbouring monastery schools, grew in importance, and were given special legal privileges, e.g. the power of granting degrees. Students and teachers flocked to these new universities from every part of Europe. Science and mathematics were recognized as subjects of study, but the main subjects were logic, philosophy, and theology. The important fact to be remembered about Scholastic philosophy is that although it was utterly barren in its provision of positive knowledge it was extremely subtle, and it did provide a severe intellectual training. It taught men to *reason*, and able men who have learned to reason are not always easily kept in leading strings.

All through the lean centuries, one catches an occasional glimpse of men who became interested in natural science. Even before the Norman Conquest we find a Frenchman, **Gerbert** of Aquitaine (A.D. 940-1003), who afterwards became Pope, famous as a mathematician and as an astronomer. He was by far the ablest man of his age, and his intellect was insatiable. He was an inventor, too. He made a clock which was preserved at Magdeburg, and a steam-organ which was preserved at Rheims.

During the reign of our own King John, a Spaniard, **St. Dominic**, and an Italian, **St. Francis**, established Orders of Friars, the Dominicans and Franciscans, respectively.* Originally established for rather different purposes, both became orders of mendicant preachers. Their vows

* These orders must not be confused with the Benedictines, a wealthy order of monks introduced into England by Augustine several centuries earlier. All our cathedral priories and most of the richest abbeys in England were of this order.

bound them to the interests of the Pope and to the extirpation of heresy. The most famous of the early Dominicans were a German, **Albertus Magnus** (1206–80), and his pupil, an Italian, **Thomas Aquinas** (1226–74), and one of the most famous of the Franciscans was an Englishman, **Roger Bacon** (1214–94). The work of Thomas Aquinas, perhaps the very greatest of the schoolmen, hardly comes within the scope of this book. But Albertus Magnus the Dominican and Roger Bacon the Franciscan, who were contemporaries, were both interested in science, though in very different ways.

The dogmas of the ancient Christian creeds were for the most part formulated as counter statements directed against heresies, and they embody the results of long and embittered controversies. Until Rome was invaded by the barbarians, the creeds were continually being developed to suit new conditions of thought and life, but this development was then cut short. When light began to dawn again in the twelfth century, the traditional formulas had become so firmly fixed that no one dared to raise any question in opposition to them. The earlier schoolmen made an attempt to harmonize philosophy and theology by placing Christian dogmas on a *reasoned* basis, but as time went on it became clearer and clearer that this could not be done. How, for instance, could the doctrine of the Trinity be placed on a reasoned basis? The Church had to say: the doctrine is embodied in the creeds and is therefore not to be doubted; he who doubts will do so at his peril.

The German Dominican, **Albert Magnus**, was an extraordinarily learned man. A modern edition of his works extends to thirty-eight volumes. He was not only a great theologian, but he knew far more about science than most men of his age. The Dominican Order asked him to write a work which would enable them to understand the writings of Aristotle, and the result was that he wrote an encyclopædia, including commentaries, on the physics and metaphysics of that Greek philosopher. It was in this encyclopædia that, as a man of science, he gave himself away. His science was

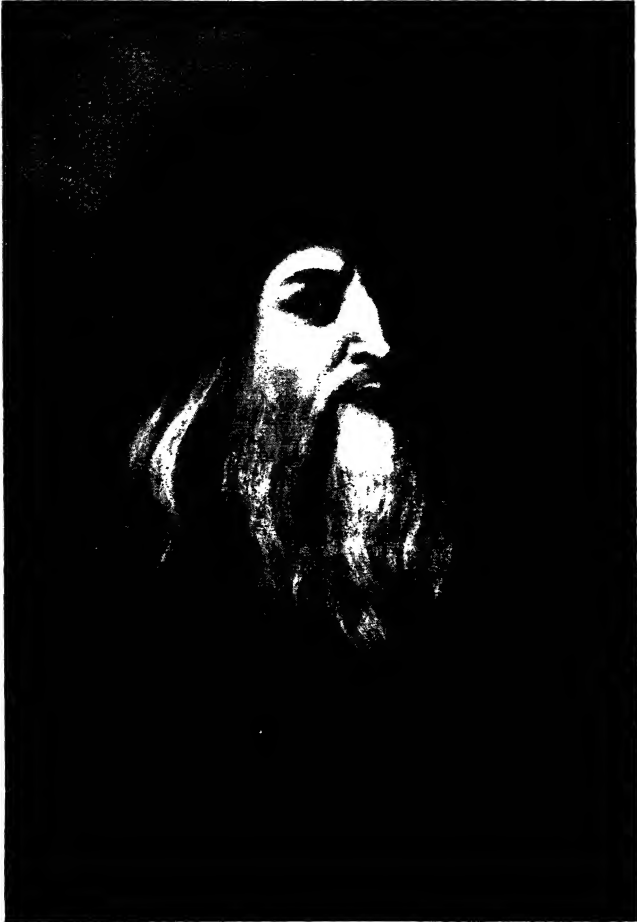

LEONARDO DA VINCI
Uffizi Gallery

not derived from first-hand observation and experiment, but from books, eked out with words and logic of his own. He failed to verify his statements, exactly as Aristotle had failed. Albert's one real value to us is that he presents us with a resumé, from the Scholastic point of view, of the knowledge already acquired by Western Europe at the end of the first half of the thirteenth century. It must, however, be recognized that he was one of the very few front-rank scholars of his age. This is freely admitted by Roger Bacon, his severest critic. He did not possess the critical insight of his Italian pupil **Thomas Aquinas**, but he was undoubtedly a very great scholar.

Albert's main business was, of course, to search for rational arguments that would not only support the dogmas of the Church, but would direct the ignorant, fortify believers, and refute unbelievers. It was essential that any doctrines he set forth should be in harmony with the views of the Church. It was therefore necessary to remodel, in some measure, the philosophy of Aristotle. For instance, Aristotle had held the view of "the eternal subsistence of the world"; Albert rejected this, holding that the doctrine of the Church, "that the creation of the world was an act in time", must be substituted. He justified the exclusion of certain doctrines from the sphere of things rationally knowable by asserting that the only things that can be reasoned about are those the basic principles of which are innate in us (*anima enim humana nullius rei accipit scientiam nisi illius, cujus principia habet apud se ipsam*). The idea of a tri-personed Godhead, for instance, is not innate in us; we can conceive of it only in so far as it is revealed, and our minds are thus illuminated by an act of grace. In this way Albertus argued.

Native German discipline thus seems to have asserted itself even in those days. Albertus apparently felt it his duty to evade the logical consequences of his researches. He remained a faithful servant of his Order and of his Church, and the title of "Great" was conferred upon him.

His Franciscan contemporary, the Englishman **Roger Bacon**, was less fortunate.

Grossteste became Bishop of Lincoln in 1235; he had been Chancellor of Oxford, head of the Franciscans in that city, and a lecturer on science in the Franciscan school, and it was there that Roger Bacon came under his influence. Bacon quickly became interested in physical science and made an intensive study of it. He soon showed himself to be a man of independent mind, and thus made enemies. He held that his contemporaries were necessarily ineffective teachers, for not only had they themselves never been properly taught but they did not take the trouble to verify the facts they employed. Though apparently he was never pre-eminently skilful in actual experimentation, he insisted on the necessity of experiment in scientific investigation, of accumulating facts, of discovering laws, of searching for causes. He stood out as the champion of unfettered inquiry, and he criticized severely the methods of his contemporary Albertus.

Like many other scholars of his time, Roger Bacon wrote an encyclopædia. But it was not like the other encyclopædias, a commentary on the works of Aristotle; it was a compendium of real knowledge. Though only parts of this great work have come down to us, it is certain that it must have been startling in the complete freshness of its outlook. It was no mere collection of facts and dicta culled from approved authors. It was entirely new, and it added greatly to the world's knowledge. A much smaller and better-known work was his *Opus Maius*, and a supplement, the *Opus Minus*. He also wrote two important works on Calendar Reform. The Sixth part of the *Opus Maius* is, in spirit, curiously anticipatory of the *Novum Organum* which Francis Bacon wrote three centuries later.

At the age of sixty-four Roger Bacon was imprisoned by the jealous and vindictive Minister-General of the Franciscan Order, and was released only a year or so before his death at the age of eighty. The charge against him was that of "suspected novelties"!

Roger Bacon wrote much on optics. His study of the theory of the subject went on hand in hand with practical work. He knew a great deal about the convex lens and there is little doubt that he was acquainted with the combination of lenses that make up a telescope. He certainly knew the properties of the parabolic mirror. Although his hypotheses concerning the origin and nature of the rainbow have since been proved to be rather wide of the mark, his record of the observations, experiments and measurements that he made during his investigation shows clearly that he had correctly anticipated the research methods of modern physicists. The transmutation of metals attracted him, but chemistry had not become separated from alchemy and had in no way been systematized. His books on the calendar show that he was an efficient astronomer.

Bacon attempted an elaboration of a mathematical theory of action at a distance, which appears in such a fruitful form in modern science. The only example of "force" which was well known to him and which was susceptible of measurement was *light*, and thus he did not get very far. Moreover, he does not appear to have been a very able mathematician.

Here is a typical extract from the *Opus Maius*:

"There are two modes in which we acquire knowledge, argument and experiment. Argument shuts up the question, and makes us shut it up too; but it gives no proof, nor does it remove doubt and cause the mind to rest in the conscious possession of truth, unless the truth is discovered by way of experience, e.g. if any man who had never seen fire were to prove by satisfactory argument that fire burns and destroys things, the hearer's mind would not rest satisfied, nor would it avoid fire; until by putting his hand or some combustible thing into it, he proved by actual experiment what the argument laid down; but after the experiment had been made, his mind receives certainty, and rests in the possession of truth which could not be given by argument, but only by experience."

Roger Bacon stands out for all time as the successful *pioneer of experimental investigation*. He had to fight alone. That he was courageous is shown by the fact that he dared to brush aside as "useless" many of the subtleties of the schoolmen: there could be no final answers, he said, to questions on such a subject as Universals; all such discussions were therefore idle.

Roger Bacon challenged the sophistries of his day. He exposed fallacies. He was a searching critic. He was constantly calling for evidence of things which his contemporaries had never before questioned. He held up to ridicule people who had not verified their opinions. No wonder he made enemies. No wonder he went unrewarded.

But Albertus? It is just possible that Albertus was lacking in courage and that he was fearful of the fate that would inevitably befall a son of the Church found guilty of expressing any sort of doubt on dogmas the Church held dear. It is also just possible that he deliberately adopted the rôle of an advocate briefed for the Church's defence. It is not a legal maxim but it is a maxim of legal practice that the main duty of an advocate is to win his case; only that way lies reward. If in the process truth is obscured, so much the worse for truth. But it is much more probable that Albertus was the kind of man who accepted without doubt or question the intellectual environment in which he happened to be born, and that he came to feel it a sacred duty not only to be the obedient servant of the Church but to devote his life to devising means of defending her. The chances are at least even that he acted in accordance with the dictates of his conscience, that he was not afraid, that he was not a time-server.

Some men are happier in defence, some happier in attack.

Men of science are often considered to belong to the latter category. That is merely because new knowledge is often disturbing to old opinions and therefore disturbing to the comfort of those who hold them.

Brief reference may be made to two other scholars of the same period. John **Duns Scotus** (c. 1265–1308), a Scottish Franciscan, was the greatest British mediæval philosopher. He was essentially a dialectician, and his leading contribution to philosophical speculation was his destructive criticism of the theories of others. At least to this extent he contributed to the principles of scientific method. His most famous pupil was **William of Occam** (c. 1300–40), a Surrey man, another brilliant Franciscan, who as a destructive critic rivalled his master. His famous dictum *Essentia non sunt multiplicanda praeter necessitatem*, known as Occam's razor, is one of the great axioms of scientific method.

BOOKS FOR REFERENCE:

1. *History of Philosophy*, Friedrich Ueberweg.
2. *The Medieval Mind*, H. O. Taylor.
3. *Histoire de la philosophie scolastique*, Hauréau.
4. *Histoire de la philosophie médiévale*, Wulf.
5. *Illustrations of the History of Medieval Thought*, R. L. Poole.
6. *History of Latin Christianity*, Milman.
7. *Roger Bacon and 13th Century Science*, Robert Steele.
8. *History of Modern Philosophy*, Höffding.

CHAPTER XVI

The Renaissance and the Reformation

14th, 15th, and 16th Centuries (1301-1600)

The complex movement called the Renaissance marks the birth of modern Europe. It is not easy to say exactly what the movement was, though it is certainly one of engrossing interest to the student both of science, and of literature, and of the arts, and of religion. In one sense it truly represents a "revival" or a "rebirth" of ancient learning, but it does much more than that. It gave "new birth to liberty—the spirit of mankind recovering consciousness and the power of self-determination, recognizing the beauty of the outer world and of the body through art, liberating the reason in science and the conscience in religion, restoring culture to the intelligence, and establishing the principle of political freedom." It is "the triumph of individualism: the Middle' Ages, with their superstitious reverence for authority and precedent, had invariably aimed at union and centralization, at a united Christendom either under the Pope or under the emperor or under both".

Thomas Aquinas (1226-74), was one of the last of the great schoolmen and represents the close of the Middle Ages. Another and equally famous Italian scholar, **Dante** (1265-1321), is a recognized link between the Middle Ages and the Renaissance; he did a great deal to awaken and to stimulate the minds of his contemporaries; he is best known as a poet, but he also wrote a scientific work, *De Aqua et Terra*. A little later came still another famous Italian scholar, **Petrarch** (1304-74), who is commonly regarded as the founder of the

Renaissance in Italy, for it was really he who initiated the general revival of interest in the ancient classical writers. By bringing men of his own generation into sympathetic contact with antiquity, he gave a decisive impulse to that European movement which restored freedom to the human intellect. In the next century, Constantinople fell (1453), and a stream of Greeks, bringing with them almost all the culture that had survived the Dark Ages, moved westwards, and in Italy they were received with wild enthusiasm. During the reigns of the English Kings Henry VII (1485-1509), and Henry VIII (1509-47), the Revival of Learning was at its height, and it was at this time that the notable scholars, **Erasmus** of Holland (1466-1536), and his English friends **Colet** (1467-1519), Dean of St. Paul's, **Sir Thomas More** (1478-1535), Lord Chancellor, and **John Fisher** (1459-1535), Bishop of Rochester, were so active.

Students of the movement must not overlook the giants in the world of painting that came into being at the time, especially in Italy—**Michelangelo** (1475-1564), **Raphael** (1483-1520), **Titian** (1477-1576), and many another. It seemed as if a new love of beauty, with a critically exacting demand for perfect expression, had been created, and as if the greatest painters the world has ever known were then born in response to it. Literature had to wait a little longer, and science a little longer still. It was at the Renaissance that men suddenly awoke again to a realization of the joy of living. A light-hearted worldliness characterized the age.

By the end of the fifteenth century, the condition of the Western Church had become deplorable. The worst example was set at head-quarters. Pope Alexander VI (1492-1503), the infamous Rodrigo Borgia, was a monster of depravity, a murderer given up to the practice of the foulest vices; **Julius II** (1503-13) was a mere secular statesman with no piety but with a decided talent for intrigue; **Leo X** (1513-21), was a cultured atheist who used to tell his friends that "Christianity was a profitable superstition for Popes". Under such Pontiffs all the abuses of the mediæval Church came to a

head. Corruption, open impiety, non-residence, neglect of all spiritual duties, greed for money, were more openly practised by the clergy than at any previous time.

Such a state of the Church would have provoked murmuring in any age, but at this time it led to open rebellion in those countries of Europe that retained some regard for religion and morals. Europe was now full of educated laymen who could criticize the Church from outside and compare its teaching with its practice. An outbreak against the papacy, its superstitions, and its enormities was bound to occur.

The occasion came from within the Church itself in 1517, when a German friar, **Martin Luther**, protested against the immoral Roman practice of selling "indulgences" or papal letters remitting penances for sins, in return for money; and he followed this up by preaching against many other papal abuses. The old resentment of Germany against the oppression of Rome, the moral revolt against the secularity and corruption of the Church, the disgust of the New Learning at its superstition and ignorance, combined to secure for Luther both a wide-spreading popularity and the protection of the northern princes of the empire. At first Luther's protest found no echo in England, but a few years later England was dragged into the general movement because of a quarrel between the Pope and the English King, Henry VIII.

But to the reforming Luther the New Learning made no appeal at all. He despised reason as heartily as any Papal dogmatist could despise it. He hated the very thought of toleration. He had been driven by a moral and intellectual compulsion to declare the Roman system a false one, but it was only to replace it by another system of doctrine just as elaborate and claiming precisely the same infallibility. Luther's doctrine trampled into the dust reason itself, the very instrument by which More and Erasmus hoped to regenerate both knowledge and religion.

In short the New Learning was equally poisonous to both the warring camps into which the Church was divided.

There can be no doubt that the civilization and outlook of the world were fundamentally changed in the fifteenth and sixteenth centuries. The principal contributing factors were the Renaissance, the Reformation, the discovery of America, and the invention of printing, but the resulting moral and intellectual revolution was so complex that it is practically impossible to assign any particular development to any one factor. From the Reformation, Protestantism as a powerful world force ultimately emerged; it was certainly less rapacious but hardly more tolerant than the parent church it broke away from, and the many sects into which it has split form a useful target for the parent church still to practise shooting at. As to the dreadful butchery of Reformation times, honours are pretty even between parent and child, though the vindictive temper of Rome towards those who criticize her has never quite disappeared; the Inquisition survived in Spain until the nineteenth century.

Nevertheless, intellectual freedom was born and the New Learning pursued its way. The clergy, who had depended for their intellectual fare entirely on the efforts of the schoolmen, were ceasing to be an intellectual class at all, for Scholasticism was moribund. The monasteries were no longer centres of intellectual interest. The New Learning was forging ahead outside them, at the universities and elsewhere. More's *Utopia*, in its wide range of speculation on every subject of human thought and action, tells us how utterly the narrowness and limitations of the Middle Ages had been broken up. Italy warmly welcomed the Greek scholars from fallen Constantinople, and Florence became a new centre of classical learning to which scholars flocked from all over Europe.

Moreover, the world as hitherto known was enlarging its bounds. Two Portuguese navigators, **Bartholomew Diaz** (in 1486) and **Vasco da Gama** (in 1498) doubled the Cape of Good Hope and anchored their ships in the harbours of India. **Columbus**, an Italian, crossed the Atlantic in 1492, and added a New World to the old. The **Cabots**

(father and son), also Italians, who had settled at Bristol, made further discoveries on the other side of the Atlantic. The world was expanding. People travelled. Knowledge grew. The first book of voyages that told of the new western world, the travels of **Amerigo Vespucci**, another Italian, was "in everybody's hands". There was a crude form of *mariner's compass* in use in those days. It may have been invented by the Arabs, but its history is uncertain.

Printing from movable type was practised in China in the thirteenth century, but whether the inventor of such printing in Europe was **Gutenberg**, a German, or **Coster**, a Dutchman, is uncertain. The Englishman **Caxton** made his first acquaintance with the press at Cologne, and set up his own press at Westminster in 1477. The art rapidly spread all over the world, and books began to multiply at a prodigious rate—a tremendous stimulus to the New Learning.

But rich as the fourteenth and fifteenth centuries were in art and in geographical discovery, they were almost destitute of positive achievements in natural science. The spirit of inquiry was active enough, but natural science did not greatly attract and had to wait.

Alchemy received a good deal of attention, however, as it had done all through the ages since the time of the early Egyptians. Alchemy is sometimes said to be related to chemistry much in the same way as astrology is to astronomy. But that is not quite true. Astrology has always been a spurious "science", practised by men who saw in it an easy means of making a living out of a credulous public; to that extent it is closely akin to phrenology, palmistry, and magic. But alchemy, wrong-headed though its practitioners may have been, has usually represented serious research, viz. of the transmutation of the baser metals into silver and gold. The basic hypothesis of alchemy was that all substances were ultimately composed of an elemental matter and that therefore it ought to be possible to devise a means of discovering the *materia prima*. The *materia prima* was early identified with mercury, not ordinary mercury, but the

“mercury of the philosophers”, that is, mercury freed from the four Aristotelian elements—earth, air, fire, water—or rather from the qualities which these represent. The *prima materia* thus obtained had to be treated with sulphur which was supposed to confer upon it the desired qualities that were missing. This “sulphur”, again, was not ordinary sulphur but some principle derived from it, which constituted the *philosopher's stone* or *elixir*. As a definite sequence of laboratory processes, the whole scheme is obscure. The general underlying hypothesis was, however, that metals are composed of mercury and sulphur. Thus the idea of transmutation was linked up with the Greek theories of matter.

Century after century there had been a transmission from worker to worker and from guild to guild, a knowledge of practical recipes and processes traditional among jewellers, metallurgists, painters, glass workers, pottery workers, and other handicraftsmen. Of systematic chemistry there was none, but there was a vast amount of applied chemistry practised. In some small measure alchemy did serve as a rough directing hypothesis, a centralizing principle, for the work of the chemical technicians working in so many different fields. It is in this way that the science of modern chemistry was born.

Roger Bacon himself was a believer in the philosopher's stone, a fact which shows that alchemy had a very strong hold indeed on the workers of that age. Even the far more advanced Boyle, a worker in the seventeenth century, was imbued with ideas of alchemy. During the twentieth century, radio-activity has given an entirely new turn to ideas of transmutation, and nowadays we hear of chemists who say that it is only a question of time before we shall be able to produce gold to order, no matter how great the order may be! If such hope is the inspiring motive of the modern worker, why should we scoff at the hope which inspired the work of the alchemist? The alchemist did at least spend laborious days and nights in his laboratory, experimenting and searching. Though he did not discover the gold he sought, he discovered

a multitude of facts which proved to be the very life-blood of the chemistry that was to come.

In its wider sense alchemy may be defined as the chemistry of the Middle Ages. Indeed, no less a man than Liebig declared that alchemy was never anything but chemistry. But at one end of the scale there appear to have been the philosophic alchemists to whom the attempted transmutation of metals was mainly of interest as an attempt to prove the truth, on the material plane, of an all-embracing philosophic system. At the other end of the scale were the materially-minded seekers after gold. Between these extremists were men whose work consisted of a complex and indefinite blend of chemistry with varying amounts of philosophy, magic, astrology, mysticism, and other ingredients.

Paracelsus (1493-1541) was an obstinate and arrogant Swiss physician and alchemist, interesting because of his stubborn opposition to the best contemporary opinion of his time. Though a popular surgeon he rejected the study of anatomy. He introduced antimony as a remedy, and was the first to use laudanum.

But if Paracelsus rejected the study of anatomy, **Vesalius** (1514-64), a Belgian, did much to advance it. He published some admirable drawings of his dissections of the human body. His work led to a great extension of the study of human anatomy in Italy, where **Eustachius** and **Fallopian** attracted great attention: the eustachian and fallopian tubes recall their names.

Three other names are deserving of mention.

1. "The world's most universal genius". **Leonardo da Vinci** (1452-1519), an Italian, was equally famous in the field of painting, sculpture, science, engineering, architecture, and invention. His remarkable pictures include the *Mona Lisa* in the Louvre, and the *Last Supper*. As a practical engineer he was unrivalled. Take him for all in all, the world has never produced another man to equal him. Record and legend represent Leonardo as aloof and magnificent, as scorning to compete with even his gigantic contemporaries.

Diffident he certainly was not, arrogant rather; respecting profoundly only two things in life: knowledge, and the cold heaven of his own art. It is no great extravagance of fancy to see in the famous smile of Mona Lisa the expression of his own inmost attitude towards both art and life. Few great men have felt such a disdain for art, and only those who have achieved as much as he did have any right to feel it. One can imagine Leonardo to-day not only welcoming with a smile of recognition Proust's bitter reference to art as "that insane barrel-organ that always plays the wrong tune", but also sympathizing with the impetuous rejection made by Ibsen's Hilda, "Books! they're so irrelevant". (Portrait, Plate 6.)

Leonardo was born an artist and always retained his wonderful artistic powers as if an innate inheritance. Yet he died a man of science, and in middle life his preoccupation with mechanism and engineering became so intense that sometimes he seemed to be on the verge of making the greatest discoveries of the twentieth century. But ordinary men and women were to him mere specimens to be put under the microscope. Whence was the origin of his complex self—his amazing powers, his disdain of his own great achievements, his cold contempt for men and women and even of life itself? Inheritance? Who shall say? He was the illegitimate son of an undistinguished Florentine lawyer, and his mother was a poor peasant girl who afterwards married a cowherd.

Truly Italy had her share of great men during the Renaissance.

2. **Bernard Palissy** (1510-89), a Frenchman world-famous as a potter and as an enameller, is interesting to geologists, inasmuch as he made a bold stand as to the origin of the petrified remains of plants and animals, urging that such remains are not freaks of nature but are really what they appear to be.

3. Lastly we come to an Englishman, **William Gilbert** (1540-1603), a Colchester physician, who wrote an exhaustive and original treatise on magnetism, a work which was highly praised by Galileo in his *Dialogi dei massimi sistemi*. His

conceptions of (i) the earth as a great magnet and (ii) the affinity of magnetism and electricity, were the inspirations of genius. For the first time magnetic and electrical phenomena were rationally treated.

But the greatest scientific advance of the time was in the field of astronomy, a subject we shall deal with in the next chapter.

It is important for the reader to realize that the sixteenth century was a period of great unsettlement. New lands were being discovered; new ideas were being born. Science was beginning to put its faith in direct observation rather than in speculative hypothesis. The century saw the rise of modern science as well as the disruption of the Western Church. Too much importance should not be attached to the Reformation which, after all, was a domestic affair of western Europe. The Christians of the Eastern Church looked on with profound detachment, perhaps with a little contempt. In the history of Christianity, as of other religions, disruptions are almost commonplace in their frequency.

Note.—Some famous men, Italians and others, of Medieval and Renaissance times are best known by their Christian names, e.g. MICHELANGELO (Buonarotti), DANTE (Alighieri), RAPHAEL (Sanzio), GALILEO (Galilei); some by their surnames, e.g. (Pietro) PERUGINO, (Sandro) BOTTICELLI, (Torquato) TASSO, (Ludovico) ARIOSTO; some by their whole names, e.g. LEONARDO DA VINCI (Leonardo was born at Vinci), VASCO DA GAMA (Da Gama was an established family name), TYCHO BRAHE. Sometimes the original name was Latinized, e.g. Nicolas Copernik came to be known as Nicolaus COPERNICUS.

BOOKS FOR REFERENCE:

1. *The Story of the Renaissance*, W. H. Hudson.
2. *The Story of the Renaissance*, Sidney Dark.
3. *The Renaissance*, E. Sichel.
4. *History of the Renaissance*, J. B. Oldham.
5. *The Renaissance and its Makers*, Symons and Bensusan.
6. *Italian Renaissance*, J. A. Symonds.
7. *Works of Bacon*, Ellis and Spedding, Vol. I, p. 461, and footnote, *De Augm.*, Liber Primus: Galileo's reference to Gilbert. For trans., see Vol. III, p. 293.

CHAPTER XVII

The New Astronomy

Relative Distances and Relative Motions

The astronomy of the Renaissance, like the astronomy of ancient times, was concerned almost entirely with the solar system. The stars were still looked upon as a species of scintillating jewels set in a crystal sphere. The planets were regarded as of infinitely more importance than the stars, and the movements of the planets formed a baffling problem still to be solved.

The fifteenth century produced three astronomers, all Germans, of considerable merit, **Nikolas of Cusa** (1401-64), **George Purbach** (1423-61), and **Regiomontanus** (John Müller) (1436-76). But they were altogether eclipsed by four of their successors in the sixteenth century: **Copernicus** (1473-1543), a half Pole, half German, whose name became descriptive of the system which superseded the Ptolemaic system; **Tycho Brahé** (1546-1601), a Danish nobleman who invented various astronomical instruments and was a wonderfully accurate astronomical observer; **Kepler** (1571-1630), a German who was celebrated as an astronomical mathematician; and **Galileo** (1564-1642), an Italian who invented the telescope and was by far the ablest man of science of his age. It will be observed that England is not represented in this group. Newton did not appear for another century.

The essential feature of the Ptolemaic system of ancient times was that the earth was the hub of the universe. The earth was the central body and motionless; round it the sun,

the moon, the planets, and the stars all revolved in *circles*; the paths of the planets were regarded as epicycles, it is true, but epicycles were, after all, paths compounded of two or more circles. Circles were the basis of all the movements.

The essential feature of the Copernican system of modern times is that the sun, and not the earth, is the central and relatively motionless body of the solar system, all the planets including the earth revolving round it. The paths of these revolving planets are not epicycles; they are not even circles, they are ellipses.

Before the reader can follow up the arguments of the **Copernicus—Tycho—Kepler—Galileo** developments, he must call back from his schooldays certain simple geometrical principles, and give a little thought to the significance of relative magnitudes and relative motions.

1. Take a piece of thread, say about 8 in. in length, and tie it into a loop. Stick a pin into a piece of paper on the table. Drop the loop over the pin, stretch it tight with a pencil point, and describe a circle. The circle is about 4 in. in radius.

2. Stick *two* pins into the paper, say $2\frac{1}{2}$ in. apart, and drop the same loop over them. Again stretch the loop tight with a pencil point, and describe a closed curve. The curve is an *ellipse*. Unlike the circle, it seems to have *two* centres; the centres are called *foci*. (The gardener adopts this plan for setting out elliptical flower-beds, and the carpenter for constructing elliptical wooden mats. Do not call an ellipse an "oval"; it is not egg-shaped. Kennington "Oval" is incorrectly named).

3. A section of a cone, AB, parallel to the base is a *circle*. Any other section, provided it does not pass through the base, say a section through AC or AD, is an *ellipse* (fig. 18). No matter how slight the deviation of the section may be from the horizontal AB, an ellipse is produced. Now the reader will remember from his geometry that an oblong (a rectangle) has certain properties, e.g. properties concerning its sides, its angles, and its diagonals. Whether the oblong is a long one



COPERNICUS



TYCHO BRAHÉ



KEPLER

From a contemporary painting

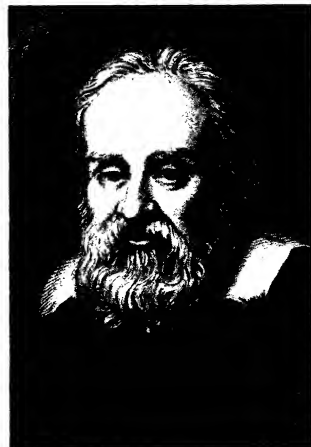

GALILEO

From a picture by Ramsay at Trinity College, Cambridge

or a short one, it always has exactly the same properties. But a long oblong might be made shorter and shorter until it became a square; no matter, the square must have all the properties that the oblong had (it also has some new ones but they do not concern us here). A square is therefore just a particular case of an oblong. So it is with a circle and an ellipse. An ellipse has a large number of properties, and a circle must therefore have the *same* properties, for it is a particular case of an ellipse. (The new properties that it also acquires at the moment it becomes a circle are interesting but they do not affect our present main argument.) The important thing in astronomy is not to think of an ellipse as a strange sort of curve but as just the parent of a circle. The ellipse becomes a circle when the long "major" diameter of the ellipse is shortened until it becomes equal to the short "minor" diameter, and the two foci of the ellipse approach each other until they coalesce at the centre of the circle.

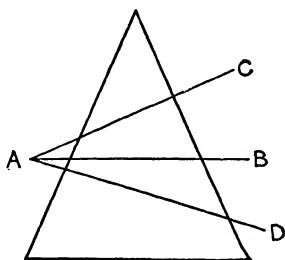

Fig. 18

The circle is thus merely a particular case of an ellipse. The Greeks postulated circular planetary paths simply and solely on the ground of the supposed simplicity and "beauty" of the circle; they little thought how great an assumption they were making in selecting the most particular case out of an indefinitely large number of possible cases. Perhaps we all find it a little difficult to uproot the old notion that nature necessarily works in accordance with "simple" laws.

4. It requires considerable effort to realize the utterly insignificant magnitude of the solar system compared with the stellar universe. We know that light travels at the rate of about 186,000 miles a second and that therefore, since the (mean) distance of the earth from the sun is about $91\frac{1}{2}$ million miles, it takes about 8 minutes 12 seconds for light to

travel from the sun to the earth: that is the first basic fact to remember.

Although when we look at the stars they seem to vary greatly in brightness, there is nothing in their appearance to suggest that they vary in *distance*; to the eye they look as if they were scattered about on a single sphere, and the ancients were convinced that this appearance corresponded to actual fact. Actually, however, the distances vary enormously. The nearest is *Proxima Centauri* 24 billion miles away; then α *Centauri* (easily identified), 25 billion miles away; then *Lalande*, 47 billion miles. The brightest star in the sky, *Sirius*, is 50 billion miles distant. There is a steady succession of distances until we come to objects 20,000 times as far away as *Sirius*.

It is useful to convert these vast distances into light-years. Since light travels 186,000 miles a second, it must travel 6 billion (6×10^{12}) miles a year, and this distance is called a "light-year". Thus the nearest star, *Proxima Centauri* is about four light-years distant. Some of the remoter nebulae are more than a million light-years distant (6×10^{18} miles), as we shall see later.

Note carefully these comparative magnitudes: Light takes just over 8 minutes to reach us from the sun, which is approximately $90 \cdot 10^6$ miles distant; it takes 4 years to reach us from the nearest star; it takes a million years to reach us from some of the remoter nebulae. There are hundreds of millions of stars in the sky, but the greatest number that can be seen with the naked eye is *only about five thousand*. We may fairly safely assume that the average distance of these five thousand stars is roughly 15 light-years or 90 billion ($90 \cdot 10^{12}$) miles. It therefore follows that the diameter of the visible (naked eye) stellar hemisphere is $90 \cdot 10^{12}$ divided by $90 \cdot 10^6$, i.e. 10^6 , or a million, times as great as the diameter of the earth's orbit. It is probably very much greater: the arithmetic is necessarily very rough.

Here is an illustration that may bring the facts home more clearly to a non-mathematical reader. In the middle

of the floor of a large room draw a circle one inch in diameter (i.e. the diameter of a halfpenny) to represent the sun; ten feet away mark a tiny dot to represent the earth (to scale this dot should be $\frac{1}{100}$ inch in diameter); then draw a circle of ten feet radius passing through this dot, with the sun as centre, to represent the earth's orbit. To show to scale the circumference of the visible stellar sphere, we should have to draw a circle with a radius of two thousand miles (a million times ten feet), that is, a circle a good deal larger than the area of the whole continent of Africa, or more than two hundred times the area of England. Thus we may think of the orbit of the earth (it is not quite circular) bearing the same relation to the apparent orbit of one of the visible stars as a circle of ten feet radius bears to the whole of Africa. It was this enormous difference between planetary and stellar distances that was not only unknown to but was even unsuspected by the astronomers of past ages, and it explains in no small measure their mistaken notions of astronomical relations.

Unless the non-mathematical reader is at some pains to realize the significance of big numbers, he will certainly fail to appreciate the work of the astronomer. After all, it is only a question of simple arithmetic. For instance, an ordinary watch ticks five times a second, or three hundred times a minute, or $300 \times 60 \times 24$ times a day. Hence the number of days it takes to tick a million times is 1,000,000 divided by $300 \times 60 \times 24$, or just about 2. Thus the time required to tick a *billion* times, i.e. a million times a million times, is a million times two days, or roughly six thousand *years*. Astronomical measurements are impressive by their vastness, just as the measurements of atomic physics are impressive by their minuteness. Let the reader ponder over the fact that the star groups we know as constellations—those fanciful mythological pictures representative of Hercules, the Bull, the Great Bear, &c.—are in appearance almost exactly the same now as they were to the ancients, thousands of years ago, and this despite the fact that they are all moving with

great velocities and with independent motions. The grouping never seems to change. It is the simple consequence of the almost inconceivably great distances. The dimensions of the earth, and even of its orbit, are as *nothing* compared with the distances of the stars.

5. The more the reader thinks about *relative motion*, the less he may feel inclined to criticize the Greek and Renaissance astronomers for their inability to see things as we see them now. If we are to form any just notion of the arrangement, in space, of a number of distant moving objects which we cannot approach and examine, but of which all the information we can gain is by sitting still and watching them, it is of primary importance to know in the first place whether we are *really* sitting still, or whether we and the earth to which we are attached are not really in motion, though the motion is unperceived. It may be that the distant objects which appear to be moving are at rest, and that only we are moving. This might very well be the case if we were in the cabin of a liner travelling, at night, on very smooth water. It might happen that the motion of the boat would be quite imperceptible, that we should believe we were at rest, and that the only objects we could see—the perfectly still lights on the shore half a mile away—would appear to be moving, and their relative positions changing. The apparent positions of a number of objects, and their apparent arrangement with respect to one another, will naturally depend on the situation of the spectator among them; and if this situation be liable to change, unknown to the spectator himself, an appearance of change in the respective situation of the objects will arise although there is no real change.

Thus a spectator in motion, but unconscious of that motion, inevitably though unconsciously transfers the motion to external objects, though in a contrary direction. Not only so, but those external objects appear to move each among the others—to shift their *relative* apparent places. A rapidly moving railway train is an excellent place for the study of this kind of relative motion. Fix the eye steadily

on one object, but not so entirely as to withdraw the attention from the general landscape; the landscape will then *appear* to rotate round the object as a centre; all objects between it and the observer will appear to move backwards, and all beyond it, forwards. Now transfer the eye to another object, and that new object becomes a centre of apparent rotation, with results exactly as before.

The apparent change of position of objects with respect to one another, arising from a motion of the spectator, is

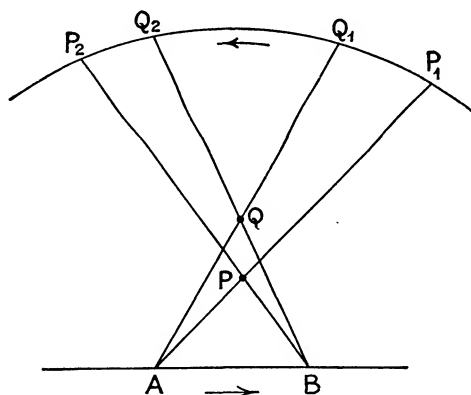

Fig. 19

called a *parallactic* motion.* It is easily understood if we refer the objects to a distant background, e.g. in the case of the planets, to the stars in the background of the sky (cf. fig. 15, p. 65); in the case of objects seen from a railway train, to the distant landscape. At the beginning of our journey from A to B (fig 19), from A we refer the object P to P_1 in the background, and the object Q to Q_1 in the background; and on reaching B we refer P to P_2 in the background and Q to Q_2 in the background. Thus both objects have appeared to move in the opposite direction to ourselves, but the nearer object P has appeared to move over a much greater distance

* Greek *παράλλαξις*: the apparent displacement of an object observed, due to real displacement of the observer.

P_1 P_2 in the background than the more distant object Q the distance Q_1 Q_2 . The reader may now work out for himself the apparent movements of P and Q when he refers P not to the background generally but to Q only. He should also be able to see the reason for the following fact: The apparent relative movements of two distant lights on a dark night, when nothing else can be seen, lights which we know to be fixed and not *really* moving, will decide which is the nearer and which the more remote; that which seems to advance with us and leave the other behind is the farther away.

The chapter on Greek astronomy may now be read again. Assuredly the Greeks may be forgiven for the mistakes they made concerning relative motion!

BOOKS FOR REFERENCE:

1. *History of Astronomy*, W. W. Bryant.
2. *Histoire d'Astronomie*, Delambre.
3. *History of the Planetary System*, J. L. E. Dreyer.

CHAPTER XVIII

Copernicus

The Renaissance astronomers soon began to feel that there was something seriously wrong with the cumbrous Ptolemaic system. Alphonso, King of Castile, who in 1488 had had a new set of astronomical tables prepared (they did not prove to be a success) was so disgusted at the complexity of the Ptolemaic system that he expressed his regret he had not been consulted at the creation of the universe!

The Ptolemaic system is commonly pictured as in fig. 20. The orbits of the planets should not, however, be shown as plain circles but as epicycles; the circles merely indicate the paths of the centres of the small circles round which the planets were supposed to travel, all synchronizing in their subordinate movements, with the sun circling in his special orbit. And there were many minor complications as well. Still, the essential feature of the system was that the *earth* was at the centre. The system was *geocentric*.

In the early days of Greek astronomy, each planet was supposed to be set in a crystal sphere which revolved in such a way as to carry the planet with it. The sphere had to be of crystal because of the necessary visibility. All the planetary spheres were supposed to be turned by an outside one, the *primum mobile*, within which were the stars. A very complicated system of axles linked the spheres together. A few privileged people were supposed to have the gift of hearing the music (the "harmony") produced by the moving spheres.

After a time it was realized that material spheres were impossible, if only because of the orbits of the comets.

Complicated epicyclic gearing was then invented to explain the planetary movements. Some people find these epicyclic movements so difficult to follow that we may give another simple illustration of them. The usual illustration given, that of a boy carrying a light and walking round and round a man as the man slowly walks round a circle in a big field

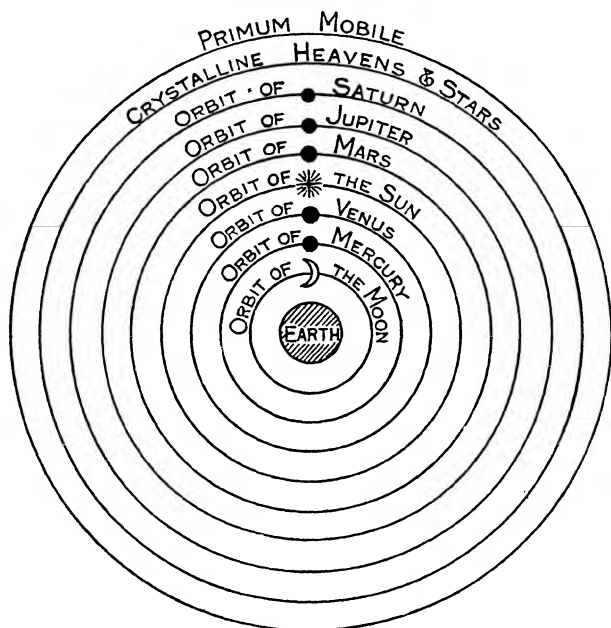

Fig. 20.—Ptolemaic (Geocentric) System

at night, is not very effective, though it would be if the light left a trail behind it. The writer once made the principle clear to a class of students by adopting the following plan. The class was taken to the local railway station where there was a large turning-table, used for locomotives. A boy was provided with a wooden rod about two feet long, from the end of which was slung an inverted tin cone filled with fine sand which trickled through a small hole in the apex. The boy was instructed to stand in a particular place on the

edge of the turning-table, to hold the rod out horizontally, radius fashion, and then to turn round and round on the spot where he was standing. Evidently the trickling sand made a circle round the boy, about half the circle being on the turn-table and half outside it. A man was now instructed to push the turn-table round, the boy himself continuing to rotate at the same spot on the edge of it. The trickling sand now marked out a perfect epicyclic train. The Ptolemaic fixed earth was represented by the centre of the turn-table; any given planet was represented by the cone of sand; the planet's main general path was represented by the circumference of the turning-table. Actually, this circumference represented the path of the travelling centres of the successive small circles made by the planet.

Copernicus had been a student at the universities of Cracow and Bologna and he was afterwards professor of mathematics at Rome. He took Orders, and he was correctly described as a scholarly monk. Though not a brilliant man, he was certainly an unbiassed thinker. He compiled tables of planetary motions, tables which were far more accurate than any that had appeared previously; but he was not an outstanding observer; his forte lay in his careful analysis and revision of the geometry underlying the Ptolemaic system.

The essential feature of the Copernican hypothesis as compared with the Ptolemaic hypothesis is that the **sun** and not the earth is the natural centre of the solar system. The old geocentric hypothesis thus gave place to the **heliocentric** hypothesis.

Copernicus first convinced himself, by laborious calculations based upon his own and previously recorded observations, that the sun is the centre of the orbits of the five planets. Then he argued that since all the planets thus move about one centre, it followed that the intervening wide space which remains between the circles of Venus and Mars must contain the earth and its accompanying moon. But Copernicus could not bring himself to believe that any of the motions were not circular. He insisted that all the heavenly bodies

moved either in simple circles or in orbits compounded of circles. He was therefore under the necessity of retaining some of Ptolemy's epicycles, though he reduced the number from 79 to 34; for of course all the large ones, rendered necessary by the motionless earth in the geocentric system, disappeared. The small ones were still necessary to explain

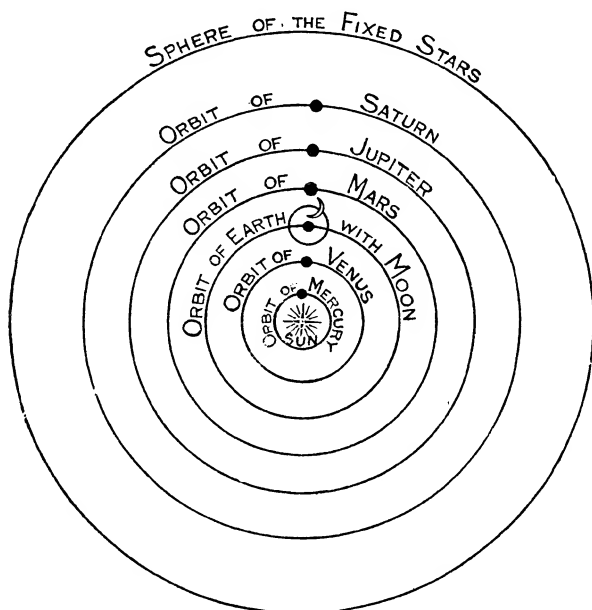

Fig. 21.—Copernican (Heliocentric) System

the many observed small variations of motion, and, not only so, but Copernicus had to provide a different centre for each of the planets. The sun was placed *within* the circular orbit of each planet but *not at the centre* of any one of them. Figure 21 is the one which commonly represents the Copernican scheme. But no planetary epicycles are shown. Neither is any orbital eccentricity shown.

The one substantial argument in favour of the Copernican hypothesis over the Ptolemaic is its greater simplicity and

therefore its greater probability. It was still inaccurate, but it had dissipated some of the old illusions of the senses.

In 1543 appeared Copernicus's famous work, *De Revolutionibus Orbium Caelestium*, but the author was on his deathbed when a copy reached him. Like a wise man he dedicated the book to the Pope, and its revolutionary import was not fully realized for a considerable period afterwards. The Church thus stood sponsor to a system against which, a century later, it hurled anathemas.

It should be realized that astronomy is a branch of science which, as regards the possibility of rigorous method of investigation, is comparable with chemistry. Observations are made, an hypothesis is constructed to cover these observations, the hypothesis is tested by a prediction of future events, and the future events as predicted are compared with the events as they actually occur. Such predictions are always possible because the essential characteristic of astronomy, at least of the astronomy of the solar system, is regular periodicity. It was the bad luck of the early astronomers that their hypotheses broke down time after time, because the events as predicted were not identical with the events as they occurred. There were always discrepancies. Then new observations were made and new hypotheses were constructed, and again a test was made. In the end the Ptolemaic hypothesis with its epicycles, secondary epicycles, and tertiary epicycles became so cumbrous that it was bound to break down. Even the Copernican hypothesis had to be drastically modified later on, mainly because it had been assumed that the planetary orbits were circles. The assumption that the orbits were circles was just an age-long and ineradicable prejudice, a prejudice moulded in cast-iron.

(Portrait of Copernicus, Plate 7).

BOOKS FOR REFERENCE:

1. *Pioneers of Science*, Lodge.
2. *History of Astronomy*, W. W. Bryant.
3. *Histoire d'Astronomie*, Delambre.
4. *History of the Planetary System*, J. L. E. Dreyer.

CHAPTER XIX

Tycho Brahé

Tycho Brahé (1546-1601), was born three years after Copernicus died, and was a contemporary of our own Queen Elizabeth. The eldest son of a Danish nobleman, he was adopted by an uncle who, a much better educated man than the father, sent him to the University of Copenhagen. Thus young Tycho, instead of following the idle pursuits of the well-to-do young men of his day, became interested in various branches of knowledge, including astronomy. But he inherited a good share of the old Norse blood; though kind, he was hot-tempered, imperious, and arrogant, and while yet a young man lost his nose in a duel. The loss does not seem to have worried him over much, for he made himself a new nose of (it is said) an alloy of gold and silver, which he wore until the end of his life; but the story of the box of cement which he always carried about with him in order to meet possible nasal emergencies seems to be a little on the tall side. Certain it is, however, that Tycho's artificial nose was, to many people, more interesting than his astronomy.

His uncle had made him his heir, and Tycho was therefore a relatively wealthy man, and with further help from the king he built for himself the magnificent observatory of Uraniburg, on the small island of Huen in the Sound between Denmark and Sweden, almost within sight of Copenhagen to the south and Elsinore to the north. There, with a competent staff of helpers, he made observations and kept records for many years.

He never lost his impatient and aggressive manner, and he offended many influential people. Eventually he was so cold-shouldered that he left the country, and he accepted an invitation from the Emperor Rudolph to set up another observatory at Prague. Amongst his new assistants was a young man named Kepler, destined to become more famous than his master. But Tycho's career at Prague was short. At the age of fifty-five he was seized with a painful illness and died.

Tycho could not bring himself to accept the Copernican hypothesis, putting forward several reasons against it. One

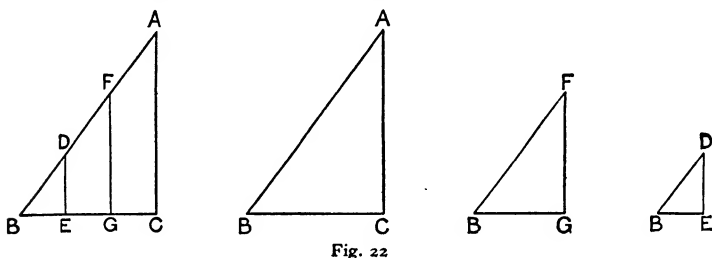

Fig. 22

was that if Venus and Mercury moved in orbits between the earth and the sun, they must exhibit phases exactly like the phases of the moon. Copernicus himself was well aware of this, and predicted that such phases would be seen if ever our powers of vision could be sufficiently increased. Another reason is a little more difficult for the non-mathematical reader to understand, and we must again take him back to his Fourth Form at school for a few seconds.

If in a right-angled triangle ABC we drop perpendiculars (say) DE and FG, on BC, the triangles DBE, FBG, and ABC are all *similar*. If they are separated they look exactly alike; they *are* alike. There is exact equality of angles, and there is proportionality of sides. For instance if AC is $1\frac{3}{4}$ times as long as BC, we are quite certain that DE is $1\frac{3}{4}$ times as long as BE. (Fig. 22.)

Suppose then that a surveyor measures up the sides and angles of the triangle DBE and discovers (1) that the angle

at B is 73° , and (2) that the side DE is $1\frac{3}{4}$ times as long as the side BE. He would make a careful note of the fact, and thus save himself labour on all future occasions. For instance, if he wanted to know the lengths of the sides AC and BC of the triangle ABC, he would only measure the length of BC, and then discover from his notebook that, since the angle at B is 73° , AC is $1\frac{3}{4}$ times as long as BC. This $1\frac{3}{4}$ is therefore a mere multiplier (the surveyor would probably call it a *tangent* but that does not matter). Every surveyor has a book of multipliers (tangents, sines, cosines, logarithms, &c.), a book which saves him an enormous amount of labour. For instance, when he is measuring triangles, he very seldom

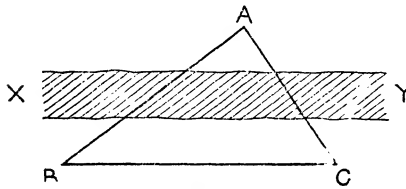

Fig. 23

measures more than one of the three sides, but he invariably measures two of the angles. Then he turns to his book of multipliers, works two little sums, and so obtains the lengths of the other sides. Let us suppose that he wishes to find the distance of a tree A on the other side of a river XY (fig. 23). He measures off a length BC on his own side of the river, measures the angles at B and C, looks out his multipliers, in his table book, and so determines the lengths of AB and AC. He might then drop a perpendicular from A on BC, and so determine the shortest and most direct distance to the tree.

Evidently, then, much depends on the accurate measuring of the angles. If the surveyor used the small semicircular protractors that schoolboys use, he could not expect to be accurate; the lines from the centre to the circumference are so short that he would almost certainly be a degree or two out. He uses a much larger protractor, on the circumference of which are not only marked degrees but fractions of a degree. The 60th part of a degree is called a minute, and the 60th part of a minute is called a second. A circular protractor marked with its 360 degrees and with minutes and

seconds as well would have on its circumference $360 \times 60 \times 60$ or 1,296,000 divisions; over a million! obviously impossible. And yet surveyors and astronomers nowadays work with such beautifully made instruments that they can easily measure an angle correctly even to the second of an arc, as the $\frac{1}{3600}$ ($= \frac{1}{60} \times \frac{1}{60}$) of a degree is sometimes called.

Range-finding at sea provides a useful illustration. A range-finder is an elaborate instrument, but the principle of it is simple. A measured line along the side of the ship is made the base of a triangle; at each end of the line telescopes are pointed to the enemy ship, perhaps ten miles away: the angles which the telescopes make with the base line are read off and the triangle is constructed. But consider: the measured base line may be only twenty or thirty feet long, whereas the other sides of the triangle may be ten miles! The two measured angles are therefore *very nearly* 90° each, and thus the triangle is exceedingly difficult to construct accurately. Evidently the estimated range may be very wide of the mark and the gunners' firing be quite ineffective.

We may now return to Tycho Brahé. He argued that *if* Copernicus was right, i.e. if the earth travelled round the sun, an infallible test ought to be possible. For since the earth is $91\frac{1}{2}$ million miles away from the sun, the two positions it occupies at any interval of six months must be 183 million miles apart. Hence the appearance of the constellations from two such widely separated positions must differ very appreciably. (He was thinking, of course, of parallactic displacement.) As we now know so well, it was impossible to detect any difference whatever in the constellations. Tycho therefore rejected the Copernican hypothesis.

Tycho had no conception of the vast distance of the stars, any parallactic displacement of which is, of course, absolutely undetectable. Imagine a vast stretch of land, perfectly flat, as large as Africa, with a circumferential fringe of lights so large and so intensely brilliant that they could all be seen by an observer at the centre. If the observer shifted his position (see p. 125) twenty feet one way or the

other, would there be any detectable difference in the relative positions of the distant lights? *None*. No telescope would detect the slightest difference. The analogy serves to show exactly why Tycho's argument failed, and why he was deceived.

Tycho, superstitious as well as pious, was not improbably anxious to disprove Copernicus's hypothesis. In any case

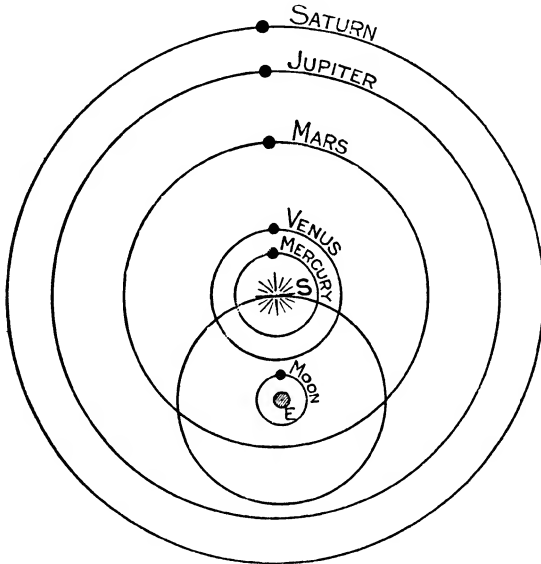

Fig. 24

he endeavoured to devise a system which should retain the earth as the central body of the solar system and should also include the obviously practical advantages of the Copernican scheme. He therefore made the whole celestial sphere, with the stars, sun, and planets, rotate round the earth, and, *besides*, the planets revolve round the sun and the sun round the earth (fig. 24). But Tycho's system died a speedy death. Astronomers could not bring themselves to go back to the Ptolemaic system, with the whole vast universe revolving round our own insignificant planet.

It is quite unjust to Tycho to say that his rejection of the Copernican hypothesis was due to stupidity. Rather it was due to his excess of caution. On weighing all the known facts, he believed that probability was against the hypothesis. And, naturally, there was the possible religious motive as well.

Though Tycho cannot be called a great astronomer, he was unquestionably a fine observer. His observations were far more accurate than those of any astronomer that had preceded him. The instruments he made were much in advance of anything that had been used before, though of course they were not to be compared with the instruments of the present day. In particular, the all-important telescope was lacking. All observations had to be carried out with the unaided eye.

Tycho was essentially a *practical* astronomer. In the making of instruments he was both resourceful and skilful; in their use he was meticulously accurate, and he was indefatigable. One of his many quadrants is shown in fig. 25. The graduated quadrant (0° – 90°) is fixed in a square frame and the sighting-arm (a telescope would be used now) is pivoted at A. The frame rotates on a vertical rod NR, sweeping round a graduated circle QS. Thus the altitude and azimuth of any star can be taken, for the sighting-arm can be pointed to any star above the horizon.

The reader will appreciate the work of the early astronomers much better if he will make a few observations for himself. Two well-known constellations visible in England

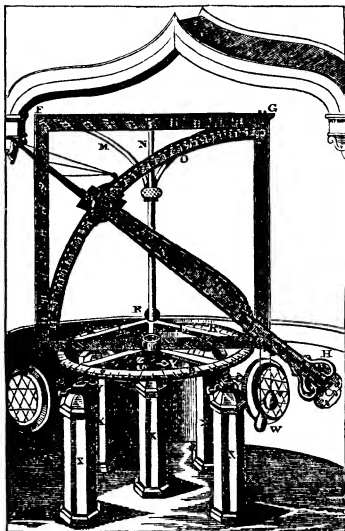

Fig. 25.—Tycho's Quadrant

all the year round are the Great Bear and Orion. By means of the Great Bear the Pole Star is easily found, i.e. the star round which the whole stellar vault appears to revolve in twenty-four hours. Orion's three-starred belt is in a line with, and is about equidistant from, two of the brightest stars of the sky, Sirius downwards and Aldebaran upwards. Aldebaran is in the "Bull", one of the constellations of the Zodiac. The "Twins" (Castor and Pollux) are to the left of the Bull (fig. 26). It is now easy to trace out the Zodiac,

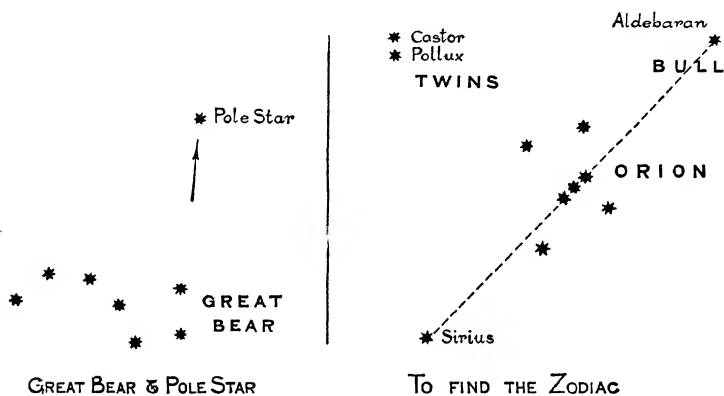

Fig. 26

with its imaginary mid-line, the Ecliptic. The Zodiac is the celestial "lane" along which the sun, moon, and planets all appear to travel. Imagine the sun and the earth both half-immersed in a great ocean; the surface of the ocean represents the plane of the Ecliptic. The moon and the planets do not travel *quite* in this plane. They all have planes of their own, differing just a little from the plane of the Ecliptic. They pursue half their journeys above, and half below, the plane of the Ecliptic.

The altitude of a star may be approximately obtained by means of any simple hinged instrument like a pair of compasses. Keep one leg of the compasses perfectly horizontal, and then point the other leg to the star. The angle between

the legs is the altitude of the star and can be measured from a protractor. To fix the position of the star a second measurement is, of course, necessary, just as both latitude and longitude are required to fix the position of a place on the earth's surface. This second measurement, the azimuth, is simply the angular measurement made on the great horizontal circle between zero and the star's own great vertical circle. (The zero coincides with the "meridian", i.e. the great north-south circle of the heavens, which passes through the polar star and the zenith, the point over the observer's head). Five minutes' chat with an astronomical friend, especially in an observatory, will make all these and many other things quite clear. It is of special interest to note how an altazimuth (Tycho's quadrant is really one) can be converted into an equatorial merely by tilting it so that the "vertical" of the instrument points to the pole star, and is then parallel to the earth's axis. To an amateur the special use of an equatorial is always of great interest.

(Portrait of Tycho Brahé, Plate 7).

BOOKS FOR REFERENCE:

1. *Pioneers of Science*, Lodge.
2. *History of Astronomy*, W. W. Bryant.
3. *Histoire d'Astronomie*, Delambre.
4. *History of the Planetary System*, J. L. E. Dreyer.

CHAPTER XX

Kepler

Kepler (1571-1630), a contemporary of Francis Bacon (Lord Verulam), was born at Weil in Würtemberg. From a charity school he passed on to the University of Tübingen and studied mathematics. His first post was a lectureship at Gratz where he became interested in astronomy, but as he was a Protestant and as he accepted the Copernican theory, his position soon became difficult, and he was glad to accept an engagement as Tycho's mathematical assistant at Prague. At the age of thirty-one he succeeded Tycho as imperial mathematician, and he obtained possession of his late chief's great collection of astronomical observations; and to the study of these he devoted the next twenty-five years.

Kepler's life was one long struggle against poverty, ill-health, and adverse conditions. Even so, he was never daunted, and his remarkable pertinacity in pursuing the special line of research he had marked out for himself has always been the admiration of men of science. He was a man with a fertile imagination but he was also a man of unimpeachable intellectual honesty. Pet hypotheses, one after another, were thrown away because they did not square with the facts of observation; and yet every hypothesis was such that it could only be tested by laborious calculations extending over a long period, and few men have voluntarily faced a life of such intellectual drudgery as Kepler did. (It should be borne in mind that the Scottish mathematician, John Napier (1550-1617), did not invent his logarithms until Kepler's work was nearly done.)

From the first Kepler became almost obsessed with the notion that the universe was governed by fixed mathematical laws; that there must, for instance, be simple geometrical and arithmetical relations amongst the orbits of the different members of the solar system. It was these relations that he set out to discover. Success eventually came to him, but only after many years.

Kepler believed that there must be some law determining the successive distances of the planets from the sun (the empirical "law" laid down by the Berlin astronomer, Bode,* did not appear for another 200 years); he also believed that there must be some law connecting the distances and the speeds of the planets.

While still a young lecturer at Gratz, he framed various hypotheses to explain the relations of the successive planetary distances.

Underlying one of his hypotheses was the following geometrical device. He inscribed a polygon in a circle, then a circle within that polygon; then a second polygon within this second circle, and a third circle within the second polygon; and so on, until he had a succession of circles to represent the successive planetary orbits. With infinite patience, he varied the polygons and so varied the circles, but he could obtain no result that anything like corresponded to observed facts. No such series of circles had the same proportions as the series of known planetary orbits.

He tried again, this time with the "regular solids". We quote from his own work *Mysterium Cosmographicum*: "The orbit of the *earth* is a circle: round the sphere to which this circle belongs describe a dodecahedron; the sphere including this will give the orbit of *Mars*. Round *Mars* describe a tetrahedon; the circle including this will include the orbit of *Jupiter*. Describe a cube round *Jupiter's* orbit; the circle including this will be the orbit of *Saturn*. Now inscribe in the *Earth's* orbit an icosahedron; the circle

* Bode's so-called law proved useful in one respect: it gave astronomers a hint to begin a hunt for other planets.

inscribed in it will be the orbit of *Venus*. Inscribe an octahedron in the orbit of *Venus*; the circle inscribed in it will be *Mercury's* orbit. This is the reason of the number of the Planets." (There were then six known planets and the five regular solids were fitted into the spaces between their orbits.)

This time Kepler thought he really had succeeded, for the results are, curiously enough, roughly in agreement with the facts. Ultimately, however, Kepler rejected it as being unsatisfactory.

Such attempts have been called fantastic, perhaps justly so. The hypotheses were not based on observed facts. They were mere shots in the dark. In his early days Kepler reasoned as the ancient Greeks did: the universe must be perfect and be very simple; the circle was a perfect and a very simple figure and therefore *must* form the key to the movements of the six planets. There were only five regular solids and they all fitted exactly into spheres; it was therefore eminently reasonable to suppose that they could determine the successive circles forming the planetary orbits.

Once on Tycho's staff at Prague, Kepler was tremendously impressed with the vast amount of accurate observational work that the master had done. He promptly put his apriorism behind him, and resolved to construct all future hypotheses on a basis of hard facts.

Hitherto no astronomer had dreamt of challenging Aristotle's dictum that all celestial motions were in *circles*. When it became evident that simple circles could not meet the case, simple circles were compounded, and thus epicycles were invented. When, later on, measurements made it clear that the planets (1) did not preserve a constant distance from the sun round which they revolved, and (2) did not travel with uniform speeds, they were still made to travel in circles but excentrically, i.e. round some other point than the centre of the circle. By giving the planets an excentric path, it was still possible to represent the speeds on the hypothesis of uniform motion. It was years before Kepler himself, working on Tycho's recorded observations, broke

away from this basic assumption of circles, so strongly was Aristotle still entrenched in the fields of philosophy and science.

Of all Tycho's observations, those of the orbit of Mars (the planet with the most obviously excentric orbit) was the most complete, and it was to these that Kepler devoted chief attention. The problem to be solved was this: from Tycho's recorded observations, to construct for the two planets, the earth and Mars, such orbits and such laws of speed that a line joining the planets and produced into the background of the sky would always give, as indicated by the stars, the exact position of Mars as seen from the earth. Everything seemed to point to the legitimacy of the assumption that there was *regularity* in the motions of the two planets. What were the laws underlying this regularity?

From the first Kepler pinned his faith to Tycho's observation, and in the end his faith proved to be justified. Considering that Tycho had no telescope, it is astonishing that his observation had always been correct to a small fraction of a degree.

Naturally, Kepler assumed that the orbits were circular and epicyclic: a departure from the circle was almost unthinkable. Naturally, also, he based his hypotheses on the assumption that both orbits were excentric. All his early attempts, and these extended over a long period, were devoted to finding *suitable excentric centres* for the circular orbits, in order that the planets would travel with uniform motion about the sun. Scheme after scheme failed. Years of labour were utterly fruitless. He subjected Tycho's observations to the closest scrutiny, and used every possible relation between recorded distances and movements, but hypothesis after hypothesis broke down when tested. However, his laborious and unsuccessful work told him one thing plainly, that there was certainly *some* connexion between motions, distances, and times. And so he plodded on.

Probably rather dimly and obscurely, Kepler felt from the first that the planets were in some way controlled by

some influence emanating from the sun, and at last it occurred to him that the motion of the planets, though in circular orbits, might not, after all, be uniform; it might be *variable*, perhaps inversely as the distance from the sun. To simplify his calculations, he divided up the circular orbits into triangles with their apexes at the excentric centre which was assumed to be the position of the sun, and he tried the plan of making all the triangles equal. To his delight this hypothesis admitted verification, for, according to it, not the rate of motion in the circumference is uniform, but *the rate of the sweeping out of triangular areas*. For instance, if the triangle SAB is equal

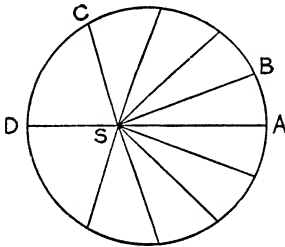

Fig. 27

in area to the triangle SCD, the planet would move from A to B in the same time as from C to D. Thus when distant from the sun it travels slowly, when close, fast. This is the basis of Kepler's second law (fig. 27).

But careful testing still revealed errors, though of a small kind, and as he had more faith in Tycho's

observations than in the completeness of his newly discovered law, he continued his researches. He felt that he had discovered the law of *speed* correctly. What then could be wrong? Was the shape of the orbit wrong? Could it be that after all Aristotle's circles were wrong?

He began to try orbits of a new type. First he tried ovals (egg-shaped curves), but they did not work. Then the ellipse occurred to him. How?

Figure 28 shows the usual Ptolemaic diagram of a planet, A, pursuing an epicyclic path, four positions of the small circles being shown, the centres of those being on the main path a, a', a'', a''' . If the planet A revolves round the small circle AKK' *in the same time* that the centre of this circle travels round the circle a, a', a'', a''' , *in the directions marked*, the planet A will trace out an ellipse, as can be easily proved mathematically. The four points A, A', A'', A''', are obviously

on an ellipse. A familiar figure of this kind *may* have given Kepler his first hint of elliptical orbits.

When once Kepler had hit upon this curve, he had to see if his law of speed would apply to it. He found that it did, *provided* that the sun was placed at one of the foci of his ellipse. Thus he had discovered the law of speed and the

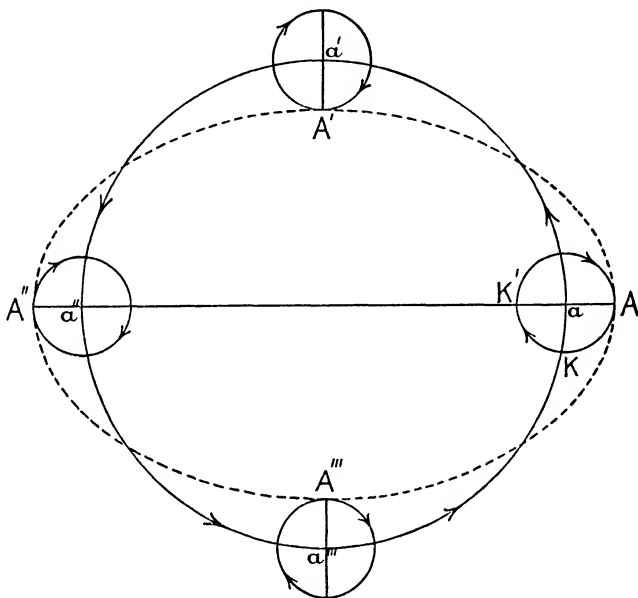

Fig. 28

shape of the orbit. The laws were tested again and again and found to be right. What applied to the earth and to Mars was soon found to apply to the other planets as well. The old planetary epicycles were at last swept away.

Kepler still felt that there must be some connexion between (1) the distances of the planets from the sun, and (2) their times of revolution (their "years") round the sun.

Eventually he discovered that the ratio $\frac{T^2}{D^3}$ is the same for all the planets, where T is the time of revolution of any planet

round the sun, and D is the mean distance of that planet from the sun.

This may be shown in tabular fashion. For convenience we may take the earth's period of revolution (365.24 days) and the earth's mean distance (say, 92,000,000 miles) as units in which to express the periods and distances of the other planets. Then we have:

	T (in earth Years)	D (in earth Distances)	T^2	D^3
Mercury	.241	.387	.058	.058
Venus	.615	.723	.378	.378
Earth	1.000	1.000	1.000	1.000
Mars	1.881	1.524	3.538	3.538
Jupiter	11.862	5.203	140.70	140.83
Saturn	29.457	9.539	867.70	867.92

When, later, Uranus and Neptune were discovered, it was found that they also complied with Kepler's three laws. The laws may be summarized thus:

1. The planetary orbits are ellipses, with the sun at a focus.
2. The radius vector (the line joining sun and planet) sweeps out equal areas in equal times. (See fig. 29.)
3. The ratio (square of planet's year)/(cube of planet's mean distance from the sun) is the same for all planets.

The full significance of these laws, that they were the mere consequences of the general law of gravitation, was not revealed until they were taken in hand by Newton.

Kepler has been adversely criticized because of the vast amount of time and labour that the discovery of the third law cost him. In seeking a law connecting the distances and times, what could have been more obvious (it has been argued) than that one of these quantities should vary either as some power or as some root of the other, or as some combination of the two? This principle having been decided upon, the testing of small powers and small roots was but a

few minutes' work. This *ex post facto* obviousness of discoveries is a delusion to which easy-chair critics are strangely liable. In this particular case it may be observed that in Kepler's time geometry was still the mathematician's great subject. Men were still a little shy, and often more than a little unfamiliar, with algebraic manipulation, and the principle of connecting two classes of quantities by comparing their *powers* is obvious only to those who are really familiar with algebraic processes. Moreover, Kepler always tried to base his formal laws on observed facts. He liked to devise

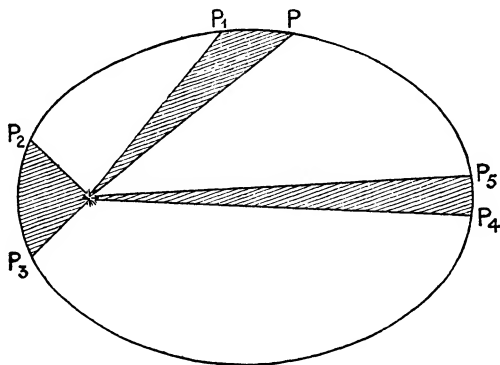

Fig. 29

a machine that would work and that he could see work. It is not likely that the present-day confidence in symbolism for representing spatial relations would have appealed to him.

The book in which Kepler's third law was published, *On Celestial Harmonies*, was dedicated to James I of England. In 1627 he published the Rudolphine astronomical tables. He also wrote an important work on Dioptrics, with a mathematical discussion on the different forms of the newly discovered telescope (he had become friendly with Galileo who was a little younger).

It is sometimes said that Kepler's scheme of work was by "trial and error"; sometimes it is said that the laws of

the motion of Mars were established by "clear induction". Both statements are substantially correct, for his succession of hypotheses, rather fanciful as some of them were, were all based upon the facts of observation. Each hypothesis was tested in the light of Tycho's recorded observations, and as far as possible in the light of Kepler's own observations. Eventually an hypothesis was hit upon that really did fit the facts.

Kepler gives us a detailed account of all his failures as well as his successes. He tells us how he followed up every clue; he explains all the suppositions he made, how he came to entertain them, and how eventually he found them to be false. He reveals the alternatives of hope and sorrow, of vexation and triumph, through which he had gone. "My first error was that the path of a planet is a perfect circle, an opinion which was a mischievous thief of my time."

It is interesting to note that the leading thought which dominated all Kepler's attempts was true, viz. that there must be *some* numerical or geometrical relations among the times, distances, and speeds of the revolving bodies of the solar system. Admittedly advances in knowledge are not commonly made without the previous exercise of some boldness and licence in guessing. The discovery of new truths unquestionably requires minds that are careful and scrupulous in examining what is suggested; but it requires, no less, minds that are quick and fertile in suggesting. The essence of invention is the talent of rapidly calling up many possibilities, and selecting the appropriate one. All who have discovered a truth have probably reasoned out many errors before obtaining it. In making many conjectures, which on trial proved erroneous, Kepler was no more unphilosophical than other discoverers have been. In short, Kepler's works provide us with an excellent example of the mental process of discovery. But one of the most important talents requisite for a discoverer is the skilful ingenuity which devises means for rapidly testing false suppositions as they offer themselves. This talent Kepler did not possess.

For testing his various hypotheses a vast amount of arithmetical calculation was necessary, and Kepler was a poor calculator though his defects in this respect were compensated by his remarkable perseverance.

Some men of science are, first and foremost, practical men, ever on the search for, and always putting their faith in, hard, undisputed, irreducible, stubborn facts. Others are of a philosophic temperament, devoted to the framing of hypotheses and to the search for law, to the weaving together of facts, to the discovery of principles. The two classes are never quite distinct, but in every worker a bias in one direction or the other is nearly always traceable. In the most successful workers there always seems to be a happy blend.

(Portrait of Kepler, Plate 7).

BOOKS FOR REFERENCE:

1. *Pioneers of Science*, Lodge.
2. *History of Astronomy*, W. W. Bryant.
3. *Histoire d'Astronomie*, Delambre.
4. *History of the Planetary System*, J. L. E. Dreyer.
5. *A Short History of Mathematics*, W. W. R. Ball.
6. *A Short History of Science*, Sedgwick and Tyler.

CHAPTER XXI

Galileo

It was Galileo (1564-1642) who invented the telescope, and before considering the work he did with it, the reader may care to return to school even once more, and revise his first lesson on optics.

An optical "prism" is a short length of glass with a section in the form of an isosceles triangle. Rays of light travelling through the air and falling on it are reduced in speed, a consequence of which is that they are *bent*, and on emerging into the air are bent again. This bending is called

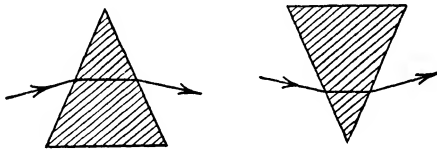

Fig. 30

"refraction" and it *always takes place towards the base of the prism* (Lat. *refractus* = bent back suddenly). (Fig. 30.)

If two prisms are placed base to base, the rays passing through them *converge* towards each other (fig. 31). If they are placed edge to edge, the rays passing through them *diverge* from each other (fig. 31). Convex and concave lenses, though curved, are very much like such pairs of prisms. Rays falling on a convex lens converge towards the axial line, and rays falling on a concave lens diverge from it (fig. 32).

The "image" seen in an ordinary looking-glass is only *apparent*; although it *appears* to be at the back of the glass,

nothing is actually there, as every small boy has found out. But an image may be *real*. For instance, hold a convex lens in position so that the rays of the sun fall directly on it. The sun being so far away, the rays are practically parallel, and parallel rays falling on a convex lens always converge to one

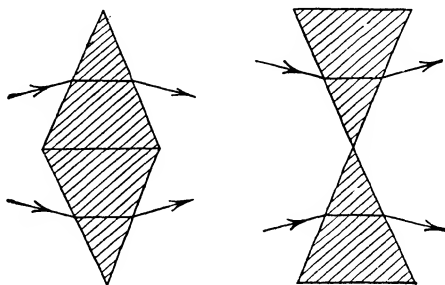

Fig. 31

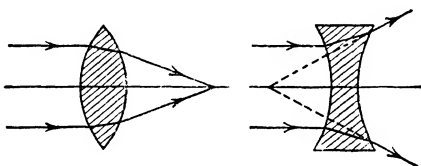

Fig. 32

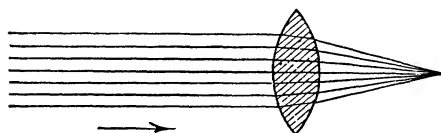

Fig. 33

point, the *focus*. If a piece of paper receive this concentrated light, a real though extremely small image of the sun is seen; and since heat rays as well as light rays are converging to the focus, the paper begins to smoulder, and may catch fire. This is the "burning lens" so well known to the ancients (fig. 33).

The same convex lens may be used as a simple magnifying-glass. But the object, say AB, to be magnified must be placed

between the lens and its focus. The image will be formed parallel to the object, and somewhere on the rays CA and CB drawn from the centre of the lens. Parallel rays from A and B will converge to the opposite focus, F' , of the lens. These rays and the rays through the centre of the lens do

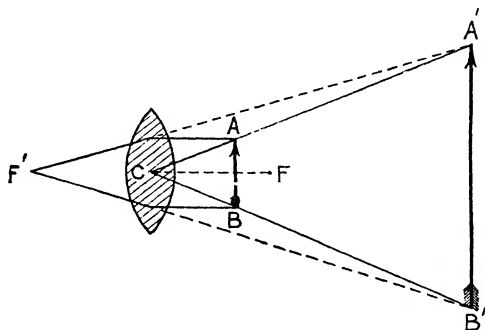

Fig. 34

not, however, meet on the left of the lens but on the right, viz. at A' and B' . $A'B'$ is therefore the magnified image of AB , though it is only *apparent*, not real (fig. 34).

An instance of a *real* image formed by a lens is the image formed in an ordinary camera. The lens of the camera produces on the ground glass screen an image of the thing

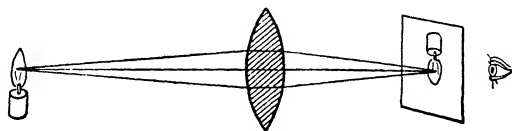

Fig. 35

to be photographed, and when the photographer has got this image sharply in focus, he exchanges his screen for a sensitized plate, on which the image then imprints itself. (The mechanism of the modern camera saves the amateur this trouble.)

The schoolboy receives on a screen of white paper an inverted image of a lighted candle placed a few feet away on the other side of the convex lens. When he places his eye

in the axial line, a few inches behind the screen, and takes the screen away, the real image is seen as if suspended in mid-air (fig. 35).

Now we come to the telescope. Let AB be a distant object and L a convex lens used as an object glass in the telescope. A small real inverted image ba is formed, exactly as in the case of the candle. The image is much too small to be seen distinctly and it has therefore to be magnified. For this purpose another lens, the eye-piece, L' , is used as an ordinary magnifying glass. A magnified image $B'A'$ is produced (fig. 36). It is only an "apparent" (virtual) image, but this is what the observer actually views. The observer does

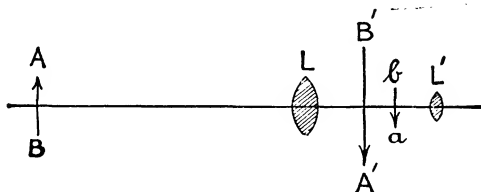

Fig. 36

not apply his magnifying glass to the object itself, but to an image of the object. The lenses are fitted into a tube with a blackened interior, to exclude all extraneous light. The sliding part of the tube permits of the adjustment of the magnifying glass (the eye-piece).

The modern telescope is much more elaborate than this, but the principles are the same. There is no essential difference between the telescope and the microscope, save that in the latter the object to be viewed can be placed where we please, so that the image is already much bigger than the object even before magnification by the eye-piece.

Galileo was an Italian, a Tuscan, born in the tower-leaning city of Pisa, not far from Florence. He became a medical student in the local university but his heart was not in the work and he preferred to train as a mathematician, though he knew well enough that the pay of a professor of

mathematics was only a few shillings a week as compared with the several hundred pounds a year paid to a professor of medicine. Even as a boy he showed remarkable ingenuity in doing things with his hands, and the toys he made are said to have astonished his elders. He was a born experimentalist; Archimedes and Faraday are perhaps the only two who in this respect ever equalled him. As a student it was typical of him that when he was supposed to be reading medicine he had concealed beneath the medical books before him copies of such works as those of Euclid and Archimedes. It was also when a medical student that he observed during a cathedral service a lamp swinging from its point of suspension high up in the roof, and he timed its swings, using the only watch he had, his own pulse: it was in this way that he established the principle of pendulum isochronism. In fact, from his youth upwards he showed a habit of mind that embodied the attitude and spirit of modern science. He was a keen observer, a master of analysis, a fearless and independent thinker. He has been rightly described as a universal genius.

The physics of those days consisted for the most part of unverified statements culled from old books. Aristotle 2000 years before had asserted things to be true, and they were still universally believed. It never occurred to the ordinary university professor to verify them. That would be casting doubt on authority, an impious thing to do.

But Galileo was the last man to take Aristotle's statements at face value. Aristotle had stated that heavy bodies fall to the ground more quickly than light bodies, and this Galileo had been duly taught at his university. "Have you ever tried to verify this experimentally?" he said to his Aristotelian teachers. "That is wholly unnecessary," they replied; "Aristotle's authority is unimpeachable." Arming himself with a 100-lb. weight and a 1-lb. weight, Galileo climbed to the top of the leaning tower and released the two weights simultaneously, and simultaneously they clanged on the pavement below. Was that the death knell of Aristotelianism?

Not a bit of it. Aristotelianism survives even now. Some ten years ago one of the most distinguished of our philosophers (he has since passed away) wrote to *The Times* a letter to show that Einstein was necessarily wrong, seeing that Aristotle had, once for all, defined in exact terms the nature of space.

Galileo's experiment had no effect on the Pisa Aristotelians; they simply denied its validity and ascribed the result to unknown disturbing causes. They had inherited and they maintained a crystallized and unalterable system of scientific truth, just as the Church had inherited and maintained a crystallized and unalterable system of theological dogma. In fact their science, their philosophy, and their theology were closely interwoven and it was a heresy to question any part of the interwoven system. They therefore felt that Galileo had tried to humiliate them, and "the irreverent young upstart" became so unpopular that he gave up his official position at the university and went to the neighbouring city of Florence.

The north-eastern part of the Italian peninsula was much less under the thumb of the Papal authorities than was Tuscany; and the Venetian university of Padua, hearing of Galileo's remarkable ability, offered him a professorship, and at Padua he embarked on a successful career of many years.

Whilst there, in 1604, a brilliant new star appeared in the sky, and Galileo delivered lectures on it, his main point being that it upset the Aristotelian doctrine of the unchangeability of the heavens. His brother professors expressed their annoyance in no unmeasured terms, and Galileo retaliated by boldly proclaiming himself a whole-hearted adherent to the Copernican theory: the earth was denied its premier position in the universe and was made one of the sun's humble servitors.

It came to Galileo's ears that in the window of a Dutch optician's shop was a new toy, a "spy-glass" consisting of two spectacle lenses at the opposite ends of a short tube, by the use of which the weather-cock of a local steeple was made to appear much nearer, though upside down. Appa-

rently the optician's assistant had discovered by accident this curious property of two aligned lenses. Galileo, thinking about this toy, quickly decided that within it there was an important secret to be discovered. Thereupon he promptly set to work to discover it, and the result was that he constructed the first telescope, using a piece of an old organ-pipe for his tube, and a concave lens instead of a convex lens for an eye-piece. The first telescope was, in fact, a modern opera-glass. By using a concave lens for an eye-piece, the difficulty of an inverted image was avoided. Rapidly effecting improvements of various kinds—he ground his own lenses—he

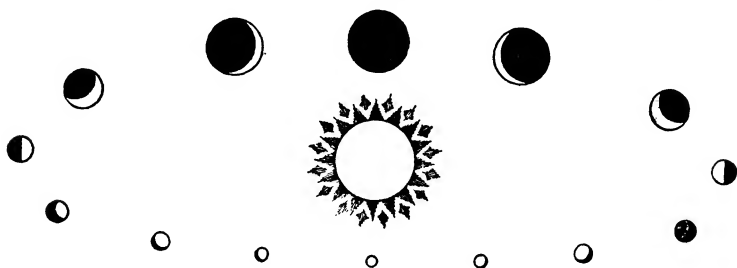

Fig. 37

produced in 1609 a telescope which magnified thirty times. Turning it towards the heavens he made discoveries that were startling: he saw that the milky way was composed of stars; that the moon was very much like the earth; that the planet Jūpiter (1610) had four satellites all revolving round him. He observed the phases of Venus, phases exactly as Copernicus had predicted (fig. 37). This particular discovery Galileo notified to Kepler in an anagram:

"Haec immatura a me jam frustra leguntur."

The letters of these words, properly transposed, form the sentence:

"Cynthiæ figuras æmulatur mater amorum ,

that is, "The mother of loves rivals the phases of Cynthia",

or, "Venus imitates the phases of the moon."

The anagram does not quite check, but it is clever.

The Copernican hypothesis was thus confirmed beyond all reasonable doubt.

The Aristotelian philosophers, especially those in Galileo's native city of Pisa, were furious. "Was not Galileo spoiling the pure crystalline face of the moon? Some of them refused even to look through the telescope, feigning to believe that it was an invention of the devil. One leading astronomer argued thus;

-“There are seven windows in the head: two nostrils, two eyes, two ears, and a mouth; so in the heavens there are two favourable stars, two unpropitious, two luminaries, and Mercury alone undecided and indifferent. From which and many other similar phenomena of nature, such as the seven metals, &c., which it were tedious to enumerate, we gather that the number of planets is necessarily seven. Moreover, these satellites of Jupiter are invisible to the naked eye, and therefore can have no influence on the earth, and therefore would be useless, and therefore do not exist. Besides, the ancient nations, as well as modern Europeans have adopted the division of the week into seven days, and have named them from the seven planets. Now, if we increase the number of planets, the whole system falls to the ground.”

Here is an extract from a letter which Galileo wrote to Kepler about this time:

“Oh, my dear Kepler, how I wish that we could have one hearty laugh together. Here, at Padua, is the principal professor of philosophy, whom I have repeatedly and urgently requested to look at the moon and planets through my glass, which he pertinaciously refuses to do. Why are you not here? what shouts of laughter we should have at this glorious folly! And to hear the professor of philosophy at Pisa labouring before the Grand Duke with logical arguments, as if with magical incantations, to charm the new planets out of the sky.”

Kepler was greatly impressed by the news of Galileo's invention, and he longed to have a telescope of his own in order that he might search for satellites revolving round the other planets.

It is a remarkable fact that three such famous astronomers should have been contemporaries. When Tycho was fifty-four, a busy observer at Prague, Kepler was thirty, working out the orbit of Mars, and Galileo was thirty-six, directing his telescope to the heavens.

Galileo went on with his work and amongst other things he discovered the spots on the sun, and, from the periodicity of their forms, the conclusion was irresistible that the sun rotated on an axis. The Aristotelians were more angry than ever. Galileo had blackened the fair face of the sun itself.

Galileo now made an unfortunate mistake. At times of leisure he had visited his native city of Pisa and had made friends with the Grand-Ducal House of Tuscany. He had always been anxious to have more time for research, and when Cosmo di Medici offered him a lucrative position at the Tuscan court at Florence, he promptly accepted it, throwing up his chair at Padua. But Tuscany was well within the zone of Papal influence, and the powerful Aristotelians whom Galileo had flouted knew that they could now find opportunities for revenge.

Venice and its neighbour Padua were far more enlightened cities than Florence and Pisa, and Galileo left behind him in the Venetian state a host of friends and admirers, all for the sake of a leisured life in a country teeming with mediæval superstition and full of watchful enemies.

It must be borne in mind that the doctrines of antiquity had for many centuries been accepted less as a science than as a religion. Aristotelian dicta were accepted as if inspired. It is true that no official pronouncement had been made by the Pope that the Copernican theory was a heresy, but the leading officers of the Roman Church did not shrink from calling it a heresy and from treating its advocates as heretics deserving of punishment.

Soon after Galileo had accepted the chair at Padua, Rome sent a message to Venice demanding the extradition of **Bruno**, an eminent philosopher, in order that he might be tried for heresy; the Copernican theory of the motion of the

earth had been publicly propounded and defended by him, and this seems to have been the main charge. The State of Venice was then practically independent of Rome, but to its shame it delivered up Bruno, who was "tried" and burned at the stake in 1600. A "natural" death in the dungeons of the Inquisition saved Archbishop **Antonio de Dominis**, who, amongst other things, had put forward an "heretical" explanation of the rainbow, from the same fate. But Galileo was not the sort of man to learn a lesson from these incidents.

In 1615, the Pope invited him to come to Rome and explain his views. Before the assembled dignitaries there, he adopted his usual method: he induced the leaders to open the discussion with a complete exposition of their own views, which he then proceeded to demolish. He led his opponents on and on, Socrates fashion, and then overwhelmed them in a complete rout. And this in Rome! Within a short time Copernicus's and Kepler's books were placed on the prohibited list, and Galileo was formally forbidden ever to teach or to believe in the motion of the earth.

Greatly disgusted, Galileo returned home to his villa at Arcetri just outside Florence, and settled down to write his famous work, *Dialogues on the Ptolemaic and Copernican Systems*. The argument in favour of the earth's motion were so cogent and unanswerable, and were so popularly stated as to do more in a few years to undermine the old system than all that he had written and spoken before. It is true that he put forward the main question as a mere mathematical hypothesis or speculative figment, but this did not deceive the cardinals, who resolved at once that the book must be suppressed. Galileo, now seventy and infirm, was peremptorily summoned to Rome, where he soon became a prisoner in the chambers of the Inquisition. The Inquisitors decided that he must be *made* to recant and abjure his heresy, torture being applied if necessary. Well enough he knew that unless he recanted he would be tortured, and probably be sent to the stake. It was only eight years

previously that Antonio de Dominis had been sentenced: "to be handed over to the secular arm to be dealt with as mercifully as possible without the shedding of blood", an atrocious formula committing a man to be burnt to death. (Actually, Antonio died in prison, but his corpse was afterwards publicly burnt.) Eventually Galileo had to undergo a "rigorous examination", and what occurred during the three days he was then shut up in the Inquisition's torture chamber has never been revealed. Certain it is that at last Galileo gave way. "I am in your hands; I will say whatever you wish." He was removed to a cell while his special form of perjury was drawn up, and this "blasphemous record of intolerance and bigoted folly" he was made to recite before the assembled cardinals and prelates (we append a shortened form):

"I, Galileo Galilei, aged seventy years, kneeling before your most Eminent and most Reverend Lords Cardinals, General Inquisitors of the universal Christian republic against heretical depravity, swear that I have always believed every article which the Church of Rome holds, teaches, and preaches. But although I had been enjoined by this Holy office altogether to abandon the false opinion which maintains that the sun is the centre and immovable, and had been forbidden to hold, defend, or teach the said false doctrine in any manner, and although it had been signified to me that the said doctrine is repugnant with the Holy Scripture, yet I have written and printed a book in which I treat of the same doctrine now condemned, and have adduced reasons with great force in support of the same; that is to say I have held and believed that the sun is the centre of the universe and is immovable. Willing therefore to remove from the minds of your Eminences this vehement suspicion rightfully entertained towards me, with a sincere heart and unfeigned faith, *I abjure, curse, and detest the said errors and heresies*; and I swear that I will never more in future say or assert anything verbally or in writing, which may give rise to a similar suspicion of me. I swear, moreover, that I will fulfil all the penances which shall be laid to me by this Holy Office."



DESCARTES

*From the portrait by Franz Hals
in the Louvre*



HUYGENS



NAPIER

*From the portrait in the University
of Edinburgh*



LOCKE

National Portrait Gallery

There is an old legend that as Galileo rose from his knees he whispered to the secretary of a cardinal whom he knew to be friendly, "nevertheless the earth *does* move." The story would be very apt if it were true.

Copies of the abjuration were sent far and wide to be read publicly.

Whether Galileo was put on the rack during those three days we do not know; he had been put under a solemn pledge of secrecy. But certain it is that afterwards he suffered from a severe form of hernia, an almost inevitable sequel to torture by the rack.

Eventually he was allowed to return to his villa at Arcetri near Florence, though for the rest of his life he was subjected to a severe form of supervision and to many other indignities. A broken man, he yet began to work again. He resumed his researches on falling bodies and eventually wrote his greatest work, a treatise on *Dynamics*, of which branch of science he was the founder. At this time Torricelli was one of his pupils. Eventually he became blind, and amongst the famous men who then visited him was John Milton, himself destined to be similarly afflicted. He lived until he was seventy-eight.

Considering that the Heliocentric theory did not appear to excite any alarm at Rome when it was promulgated by Copernicus a century before (lectures in support of the doctrine were given even in the ecclesiastical colleges), it may seem strange that Galileo's support of the theory should have excited such a storm of controversy.

But the change in the Church's view must be ascribed in a large measure to the controversies and alarms which had in the interval arisen out of the Reformation. Rome had developed an intense jealousy of all innovations in received opinions. And there is the further fact that Galileo, on his side, was very intolerant to those who opposed him. When he knew that he was undoubtedly right he found it difficult to refrain from holding his opponents up to ridicule. In the book that gave so much offence, he introduced into it a character under the name of Simplicius, into whose mouth

he put the defence of all the ancient dogmas; and, needless to say, poor Simplicius was defeated at all points of the discussion. The whole book was transparently ironical, all at the expense of the Church. In fact his sarcasm was too glaringly obvious to be forgiven.

Admittedly it was ecclesiastical pique that really brought about Galileo's trial; the interests of truth and free inquiry were much less deeply concerned. The ecclesiastical authorities saved themselves by still allowing the Copernican theory to be taught as an "hypothesis"; the theory was heretical only in so far as the theory was "contrary to Scripture".

The Roman Church was a great institution. Any great institution has important vested interests, to be defended at all costs. An attack on it inevitably calls forth counter attack: only that way lies safety. But the Roman Church was no more vindictive than any other church of that time. The Pope, Luther, Calvin, Knox, all pronounced the same doom: unless ye believe absolutely as I believe, eternal damnation awaits you.

On balance, however, Galileo's trial must be regarded as a reprehensible act, not to be forgiven. Personally Galileo was a man of sterling worth; he was probably the greatest man of his time, and was certainly one of the greatest men of all time; he devoted his whole life to the discovery of objective truth. Much too old and infirm to defend himself effectively, he was brought to trial by vindictive prelates whose pride he had wounded. The charge of heresy was a sham; and the trial was a blot on the fame of a great church.

(Portrait of Galileo, Plate 7).

BOOKS FOR REFERENCE:

1. *Pioneers of Science*, Lodge.
2. *History of Astronomy*, W. W. Bryant.
3. *Histoire d'Astronomie*, Delambre.
4. *History of the Planetary System*, J. L. E. Dreyer.
5. *A Short History of Mathematics*, W. W. R. Ball.
6. *A Short History of Science*, Sedgwick and Tyler.

CHAPTER XXII

The Foundation of Mechanics

1. STEVINUS (1548-1620) of Belgium.
2. GALILEO (1564-1642) of Italy, and his pupil
3. TORRICELLI (1608-1647) also of Italy.
4. HUYGENS (1629-1695) of Holland.
5. GUERICKE (1602-1686) of Germany.
6. PASCAL (1623-1662) of France.

Archimedes and other Greeks had laid the foundations of statics (including hydro-statics), but it was left to Galileo, nearly two thousand years later, to do the same for dynamics. Galileo had devoted attention to falling bodies when a young man at Pisa, but it was not until he was an old man and a virtual prisoner at Arcetri that his book *Discorsi e dimostrazioni matematiche* appeared. In his scientific method of attacking new problems Galileo overtowered all his predecessors with the single exception of Archimedes. The key to much of his success was that he asked the question *How* does it happen? not, *Why* does it happen? He always sought the *law* underlying phenomena. To ascertain the law, he made certain assumptions, and then he tried to ascertain by trial whether the assumptions were correct or not. Like Kepler, he "groped his way" towards the correct solution, but he was a better logician than Kepler, and his shots found the target much more quickly.

Galileo's demonstrations are always delightfully simple.

In all cases of motion, three quantities are involved: *space* (s), or the distance the object passes through; *velocity* (v), or the speed with which the object moves; and *time* (t),

the number of seconds (or other units) during which the object moves.

If the velocity does not change during the time, the relations between the three quantities are of the simplest. For instance, if a train travels the four hundred miles between London and Edinburgh at a uniform velocity of fifty miles an hour (we neglect starting, stopping, halts, and gradients), the journey takes eight hours, since $\frac{400}{50} = 8$. Putting this in general terms, we have $s/v = t$, or $s = vt$. This is the fundamental formula for uniform motion.

But the motion of a moving body need not be uniform; it may vary; there may be acceleration or retardation. A falling stone is constantly increasing in velocity until it reaches the ground; a stone thrown upwards is constantly diminishing in velocity until it reaches a maximum height and then momentarily stops; then it returns to the earth with constantly increasing velocity, its velocity at any given point below its point of turning being exactly the same upwards and downwards. From the height of 100 feet a cricket ball smacks the hand very much harder than from a height of ten feet. All such facts were, of course, thoroughly familiar to Galileo. He knew the relation between s , v , and t for uniform motion, and he set himself the problem, what is the relation when the motion is not uniform but is uniformly accelerating, as in the case of a falling stone?

A beginner is sometimes inclined to ask the question: Why did not Galileo let a heavy body fall from the top floor of the leaning tower of Pisa and let observers on all the other floors note the exact times when the stone passed them. The actual distances between floor and floor could be measured directly, and s and t now being known, v could be calculated for each floor.

But apart from other practical difficulties, the experiment would have meant measuring time to a very small fraction of a second, and even now we have no simple means of doing that. Galileo knew well enough that no *direct* experiment was possible.

Galileo decided that he must first of all argue the matter out mathematically, and establish a mathematical relation between s , v , and t provisionally; he would then check the mathematical law experimentally.

We may use a simple form of graph to show the relation $s = vt$ for uniform motion. On OM mark off equal lengths, to represent *time* (seconds) and on ON equal lengths to represent velocities (feet per second), and draw the parallels and perpendiculars. The rectangle PROQ (15 small squares) may be taken to represent the space travelled in 5 sec. by the body moving at a uniform velocity of 3 ft. per second (5×3

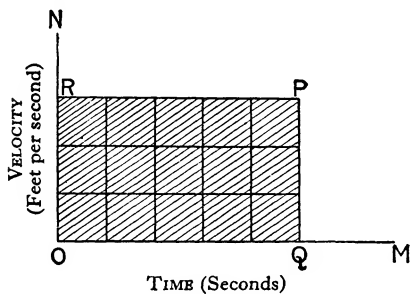

Fig. 38

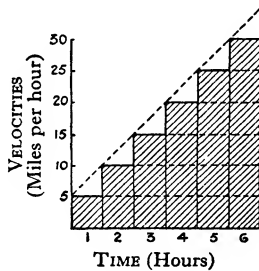

Fig. 39

= 15). Thus the space travelled is proportional to the product of the velocity and time ($s = vt$). (Fig. 38.)

Now consider accelerated motion. Suppose a train to move for 1 min. at a uniform velocity of 5 miles an hour; then to be suddenly accelerated to 10 miles an hour and to travel for 1 min. at that velocity; then to be accelerated to 15 miles an hour for a third minute; to 20 miles an hour for a fourth minute; to 25 for a fifth; and to 30 for a sixth. How far would it have travelled altogether? A velocity-time graph, modelled on the previous graph, shows this at once. The number of units of area under the graph is $1 + 2 + 3 + 4 + 5 + 6 = 21$, and this gives us the number of *miles travelled*. (Fig. 39.)

The dotted line passing through the top left-hand corners of the rectangles may easily be proved to be straight, and

this evidently indicates *some* sort of uniformity in the motion. But the whole of the area under this line is not enclosed by the rectangles; there are six little triangles unaccounted for. How are these triangles to be explained? By the fact that we have really imagined an impossible thing, viz. that at certain times the train's speed was *instantaneously* increased 5 miles an hour. Now although in practice we know that even in the very best trains acceleration is really brought about by sudden jerks, these jerks are virtually imperceptible, and it is therefore not impossible to imagine an acceleration free from such sudden increases. It is this *continuous* accel-

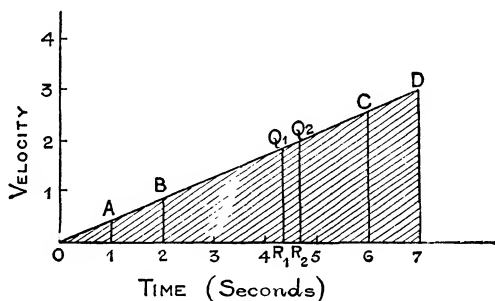

Fig. 40

eration, the velocity increasing not in jerks but *continuously*, that is characteristic of a falling body.

Hence a velocity-time graph, showing a velocity *continuously* accelerated, gives us an exact picture of the increasing "space" passed over, and thus in fig. 40 the shaded area represents a measure of the distances. For example, the ratio of (1) the area between the two verticals at A and B, and (2) the area between those at C and D is equal to the ratio of the distance travelled through in the second and seventh seconds. Or we may look at it in this way: the small area between Q_1R_1 and Q_2R_2 represents the space travelled in the small interval of time represented by R_1R_2 , for it is intermediate between the areas of the two parallelograms on the base R_1R_2 with heights R_1Q_1 and R_2Q_2 respectively.

And this must always be the case, no matter how close together Q_1R_1 Q_2R_2 may be.

All the above arguments, though they have been simplified in form, are due to Galileo, who now laid down two propositions.

Proposition I.—*The distance travelled from rest in any given time by a body moving with uniformly accelerating velocity is the same as if the body moved for the same length of time with a uniform velocity equal to half the final velocity attained in the given time.*

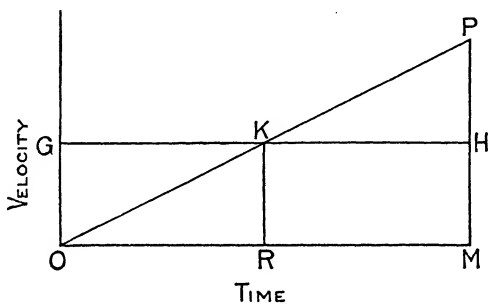

Fig. 41

Let OM represent the time, and MP the velocity at the end of the time. Bisect PM in H and draw GKH parallel to OM . The triangles KPH and KOG being equal, the parallelogram $GOMH$ is equal to the triangle POM , and $KR = \frac{1}{2} PM$. Evidently the parallelogram $GOMH$ represents the space travelled in the time OM with an average *uniform* velocity of KR or $\frac{1}{2} PM$ (fig. 41).

Thus if a body moving with a uniformly accelerating velocity starts from rest (velocity = 0) and at the end of 1 sec. has a velocity of 32 ft. per second, the distance travelled is the same as if it had travelled with a uniform velocity of $\frac{32}{2}$ or 16 ft. per second.

Proposition II.—*The distances travelled by a body moving with a uniformly accelerating velocity are to one another as the squares of the time.*

(This proposition is based on the well-known geometrical principle that the areas of similar triangles are in the same ratio as the squares on corresponding sides.)

Let OM_1 and OM_2 represent the time measured from O the beginning of the movement, and let P_1M_1 and P_2M_2 represent the velocities at the ends of those times (fig. 42). Since the velocity increases uniformly, OP_1P_2 is a straight line. The distances travelled are represented by the area OP_1M_1 and OP_2M_2 . But $\frac{\text{triangle } OP_1M_1}{\text{triangle } OP_2M_2} = \frac{OM_1^2}{OM_2^2}$ that is, *the distances are proportional to the squares of the times.*

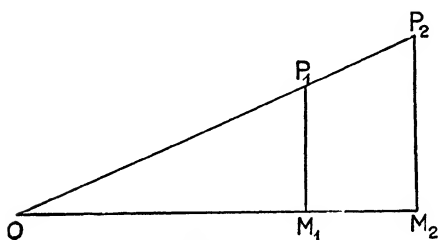

Fig. 42

Or we may obtain the result of the second proposition by using the result of the first proposition. We will call the velocity acquired at the end of 1 second by a body moving with uniformly accelerating velocity

from rest, g ; then at the end of 2 sec. the velocity must be $2g$; at the end of 3 sec., $3g$; and so on. From the first proposition we know that the distance is equal to the number of seconds multiplied by half the final velocity. Hence we may tabulate:

Time in seconds t	Vels. at end of each second v	Distances at end of each second $s = tv$
1	$1g$	$1 \times 1g/2 = 1^2g/2$
2	$2g$	$2 \times 2g/2 = 2^2g/2$
3	$3g$	$3 \times 3g/2 = 3^2g/2$
4	$4g$	$4 \times 4g/2 = 4^2g/2$
—	—	—
t	tg	$t \times tg/2 = t^2g/2$

Thus when we know the value of g , we can obtain the actual distances fallen through in any number of seconds.

In this way did Galileo show the relation between t , v , and s . He had made a previous assumption, viz. that the velocities acquired are proportional to the *distances* passed through, but he soon discovered that such a proposition is not tenable. In his second assumption, viz. that the *velocities* acquired are proportional to the *times*, he could detect no fallacy in the result he then arrived at. It now remained to subject this result to an experimental test. But the velocity of bodies falling freely under the action of gravity, as from a high tower, or down a deep well, is so great that the necessary measurement of time was beyond Galileo's experimental skill. He therefore decided to "dilute" gravity, to "slow down" the falling body, so that the time of descent could be measured. For this purpose he used an inclined plane. He *assumed* that, although the velocity of descent would be reduced, the *form of the law* of descent would remain unmodified.

Experiment.—Inclined-plane proof of the Second Proposition.

Galileo used a narrow stout board of hard wood several inches thick (to prevent sag) and some eighteen or twenty feet long, and throughout its length he gouged out an inch-wide very straight groove which he then lined with polished and burnished parchment, to reduce friction to a minimum. Down this groove he rolled a well-rounded and polished bronze ball, the wooden plane being inclined by raising one of its ends. He repeated the experiment many times with the board in one position, and then again and again with the board inclined at different angles, "to ensure from the number of observations that there shall be no difference in the results, not even as much as the tenth part of a pulse-beat". To measure time he had "a large bucket of water on a shelf, which, by a narrow tube soldered on to the bottom, pours a fine thread of water which can be caught in a beaker during the time that the ball is rolling. The water can then be weighed accurately". The bucket was very large, so that

during an experiment there was no appreciable difference in the pressure-height of the water, and the weights of the water discharged were therefore proportional to the times. The board was notched at distances 1, 4, 9, 16, and 25 from the top end, and it was found that the corresponding *times* the ball took to roll down these distances were 1, 2, 3, 4, 5, or $\sqrt{1}$, $\sqrt{4}$, $\sqrt{9}$, $\sqrt{16}$, and $\sqrt{25}$, respectively. The result was always the same, no matter whether the board was only gently inclined and gravity therefore making its effect felt only slightly, or whether it was greatly inclined and gravity therefore allowed to become effective in a much higher

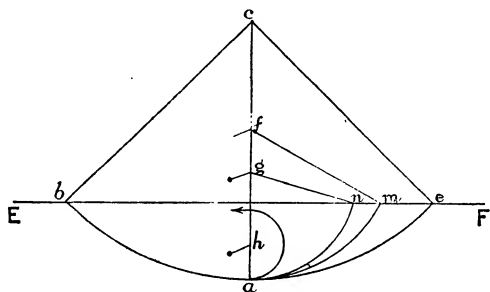

Fig. 43

degree. This old experiment is so fundamental that it is in constant use in schools, though now in greatly improved forms.

Galileo's assumption that a body which falls freely through a distance equal to the *vertical height* of an inclined plane attains the same final velocity as a body which rolls down the *length* of the plane, may seem to be bold, but Galileo considered it carefully, became convinced of its truth, and then devised an experiment to verify it:

Experiment.—To show that velocities acquired in rolling down planes of the same height, but different lengths, are the same (fig. 43).

A ball is suspended by a fine string from a nail c, and a horizontal line EF is drawn on the wall behind. The ball

is pulled back to the point b , and then let go. It descends to a , and the speed which it has then acquired carries it very nearly up to e in the line EF (not quite, because of the resistance of the air and the thread), i.e. it ascends to the same vertical height on the opposite side. Note that it is permissible to regard the motion of a pendulum in the arc of a circle as a motion along a series of inclined planes of different inclinations, the inclinations gradually diminishing downwards to a lowest point (as a), and then increasing upwards. If therefore we cause the body to rise on a different arc, it rises on a different series of inclined planes. To do this, we put another nail at f or g , vertically below c , and so prevent any given portion of the thread from taking part in the second half of the motion. Then f or g becomes the centre of the new rising arc described. The ball, again released from b , will on reaching a , have the same velocity as before, but will begin to ascend by a different series of inclined planes and describe the arc am or an ; it will *very nearly* reach the horizontal line EF as before, showing that the velocity acquired in descending the arc ba , and the velocities destroyed in ascending the arcs ae , am , or an , are all equal. If the nail h be driven in so low down that the remainder of the string cannot reach the level EF, the ball will turn completely over and wind the thread around the nail, because when it has reached the greatest height it can reach, it still has a residual velocity left.

Observe that Galileo did not supply us with a *theory* of the falling of bodies, but he investigated and established, wholly without preformed opinions, the *actual facts* of falling. Observe, too, that Galileo, in all his reasonings, followed the principle of continuity.

Later it was found by experiment that the velocity of a body freely falling from rest is 32 ft. at the end of 1 sec., 64 ($= 32 \times 2$) at the end of 2 sec., 96 ($= 32 \times 3$) at the end of 3 sec., 112 ($= 32 \times 3\frac{1}{2}$) at the end of $3\frac{1}{2}$ sec., $32t$ at the end of t sec. (The value 32 is a close approximation; it varies slightly from place to place.) Thus the velocity varies

with the time, increasing constantly with the time; it is uniformly *accelerated* by an additional 32 ft. every second. The inter-relations of Galileo's law are shown in fig. 44.

Note how the distance for any given time may be obtained by multiplying the square of the time by $\frac{32}{2}$.

TIMES (Seconds)	VELOCITIES (Ft. per Sec.)	DISTANCES (Feet)
0	0	0
1	32 (= 32 × 1)	16 = $\frac{32}{2} \times 1^2$
2	64 (= 32 × 2)	64 = $\frac{32}{2} \times 2^2$
3	96 (= 32 × 3)	144 = $\frac{32}{2} \times 3^2$
4	128 (= 32 × 4)	256 = $\frac{32}{2} \times 4^2$

Fig. 44

The acceleration of 32 ft. per second every second is commonly denoted by g . Hence the general law may be written: $S = \frac{1}{2}gt^2$.

Galileo's other original work included researches in heat, in light, in sound, in the mechanics of fluids, in the strength of materials under tension, and in other subjects too numerous even to catalogue. These discoveries did not bring to him

while living so much fame as his discoveries in astronomy. But the latter required merely a telescope and plenty of patience, whilst his work in mechanics, including as it did the discovery of some of the most fundamental laws of nature, was the work of an undeniably great genius. His methods were always the methods of a master.

Stevinus (1548-1620) was born at Bruges and in his early days was recognized as an authority on military engineering. His scientific investigations were directed to statics, and the most interesting of them was that concerning the mechanical properties of the inclined plane. Over a wooden triangular prism (the three sides of the triangle being unequal and the base being kept horizontal) he placed a freely hanging endless chain. Such a chain is either in equilibrium or it is not. If the latter, the chain once in motion must continue to move for ever, but Stevinus rightly rejected this hypothesis since "perpetual motion" is, he considered, absurd. Consequently only the former hypothesis, that of equilibrium, is tenable. But the symmetrical hanging portion of the chain ADC, is obviously by itself in equilibrium and may therefore be removed without disturbing the portion ABC; hence the portion BA of the chain exactly balances the portion BC. On this simple fundamental fact Stevinus based his complete theory of the inclined plane (fig. 45).

Mach says:

"Unquestionably in the assumption from which Stevinus starts, that the endless chain does not move, there is contained primarily only a *purely instinctive* cognition. He feels at once, and we with him, that we have never observed anything like a motion of the kind referred to, that a thing of such a character does not exist. This conviction has so much logical cogency that we accept the conclusion drawn from it respecting the law of equilibrium on the inclined plane without the thought of an objection, although the law if presented as the simple result of experiment, or otherwise put, would appear dubious. We cannot be surprised at this

when we reflect that all results of experiment are obscured by adventitious circumstances (as friction, &c.), and that every conjecture as to the conditions which are determinative in a given case is liable to error. That Stevinus ascribes to instinctive knowledge of this sort a higher authority than to simple, manifest, direct observation might excite in us astonishment if we did not ourselves possess the same in-

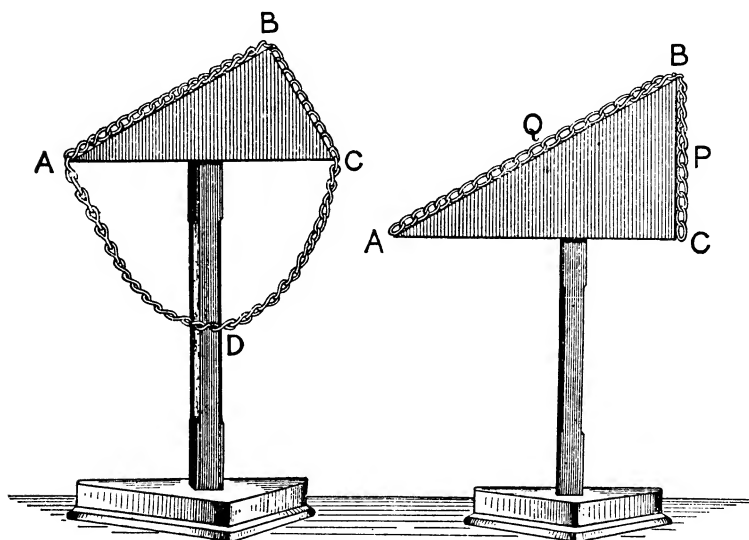

Fig. 45

clination. The question accordingly forces itself upon us: Whence does this higher authority come? If we remember that scientific demonstration, and scientific criticism generally, can only have sprung from the consciousness of the individual fallibility of investigators, the explanation is not far to seek. We feel clearly, that we ourselves have contributed *nothing* to the creation of instinctive knowledge, that we have added to it nothing arbitrarily, but that it exists in absolute independence of our participation. Our mistrust of our own subjective interpretation of the facts observed is thus dissipated.

“Stevinus’s deduction is one of the rarest fossil indications that we possess in the primitive history of mechanics, and throws a wonderful light on the process of the formation of science generally, on its rise from instinctive knowledge. We may recall to mind that Archimedes pursued exactly the same tendency as Stevinus, only with much less good fortune. In later times, also, instinctive knowledge is very frequently taken as the starting-point of investigations. Every experimenter can daily observe in his own person the guidance that instinctive knowledge furnishes him. If he succeeds in abstractly formulating what is contained in it, he will as a rule have made an important advance in science.

“How does this instinctive knowledge originate and what are its contents? Everything which we observe in nature imprints itself *uncomprehended* and *unanalysed* in our percepts and ideas, which, then, in their turn, mimic the processes of nature in their most general and most striking features. In these accumulated experiences we possess a treasure-store which is ever close at hand and of which only the smallest portion is embodied in clear articulate thought. The circumstance that it is far easier to resort to these experiences than it is to nature herself, and that they are, notwithstanding this, free, in the sense indicated, from all subjectivity, invests them with a high value. It is a peculiar property of instinctive knowledge that it is predominantly of a negative nature. We cannot so well say what must happen as we can what cannot happen.”

Huygens (1629-95) of Holland we shall meet again. It is sufficient to say here that he did much to advance our knowledge of mechanics. In his great work on the pendulum (*Horologium oscillatorium sive de motu pendulorum*), he displayed remarkable skill in his geometrical treatment of the mechanical problems involved. The use of wheel mechanisms with weights, for measuring time, had been familiar for centuries, but Huyghens devised a means of *regulating* the

motion by means of a pendulum. He also applied spiral strings to watches.

Torricelli (1608-47), an Italian who assisted Galileo at Arcetri, will always be remembered as the inventor of the mercury barometer. **Pascal** (1623-62), a Frenchman of extraordinary brilliance (as a mere boy he was a master mathematician), followed up the work of Torricelli and discovered the means of measuring altitudes by reading barometric pressures; he also discovered the principle of the hydrostatic press. **Guericke** (1602-86), a German, invented the air-pump.

In these days England had its share of the world's great men—**Spenser** (1552-99), **Shakespeare** (1564-1616), **Bacon** (1561-1626); but its great men of science had still to come.

BOOKS FOR REFERENCE:

1. *Science of Mechanics*, Ernst Mach.
2. *Short History of Mathematics*, W. W. R. Ball.
3. *Pioneers of Science*, Lodge.

CHAPTER XXIII

Advisers on Methodical Research

Bacon and Descartes

From the point of view of mere intellectual power, **Francis Bacon**, Lord Verulam, (1561-1626), easily stands in the very front rank of Englishmen. No one denies that as a man of letters he was brilliant, so much so indeed that some of his friends make him the real father of all Shakespeare's works. As a philosopher he had no contemporary to equal him. As Lord Chancellor he was one of the soundest lawyers that ever sat on the woolsack. His interests were catholic, and his exceptional ability has never been open to question.

England had been a laggard during Renaissance science, and whilst world-famous investigators were making great reputations for themselves in Italy, Germany, France, the Netherlands, and Denmark, most of her own workers remained Aristotelians and sought knowledge from the pages of their musty medieval books instead of going direct to nature and to the laboratory.

It was probably Bacon's keenness as a lawyer that made him dissatisfied with the methods pursued by English men of science. Though only an amateur in science himself, he saw plainly that much of the evidence from which many English investigators drew their conclusions had no basis in fact, and that, if progress was to be made, methods must be radically revised. He therefore wrote a book, the *Novum Organum*, which is so fruitfully suggestive that no student of science can afford not to read it.

The essence of his advice was that we must go direct to nature, and by observation and experiment collect facts; then organize the facts, and base our conclusions on them. So far, excellent. But his advice was not the outcome of a study of methods actually pursued. Indeed, there was little research work worthy of study going on in England at that time. It was just the kind of advice we should expect from an eminent lawyer: *first get your facts*. But Bacon knew too little of the technique of science to be aware of the essential nature of all research work. He did not know how largely intuition enters into almost all original investigation in science. He seemed to think that mechanical rules could be invented whereby any person of ordinary intelligence could become a successful research worker. Once the rules for unearthing the secrets of nature are laid down, he said, how simple it will all be.

Bacon made no important discoveries himself, and none have been made by adopting his methods. Nevertheless he exercised a very great influence on scientific workers; he got them away from their books and induced them to engage in observation and experiment. Above all things, he was "*the ploughman who prepared the ground for the seed*" of free and unprejudiced inquiry into the facts of nature. His *indirect* service to science was enormous. But he set out to reach an unattainable goal—to become the master of nature in its entirety.

Despite his great range of knowledge, Bacon remained curiously ignorant of the successful investigations being carried out by such of his contemporaries as Galileo and Stevinus. His rather scornful opinion of the Copernican system may be put down to the natural caution of a lawyer, but his hostile attitude to the work of his own countrymen, Gilbert and Harvey, is really extremely difficult to understand.

It has been well said that Bacon's voice was the voice of a great herald, compelling people to wake up; and startling them so much that they kept awake. This is an adequate answer to all Bacon's critics, who are many. Bacon will

always be remembered as a man who, though not primarily a man of science, brought to bear on scientific subjects a practical English mind. Nothing satisfied him that could not be brought to the test of verification and to the bar of cold reason, and on every subject he brought to bear his incomparable power of cross-examination. Bacon distrusted speculative hypotheses. His outlook was the outlook of a Newton, not that of a Descartes.

Bacon's rather younger contemporary, **René Descartes** (1596-1650), a Frenchman, belonged to a family very proud of its ancestry, a family to whom anything of the nature of a *mésalliance* would have been anathema. It is not altogether an advantage for a genius to be born in the purple; for the want of an incentive to hard work, he is apt to become a dilettante. Descartes never seems to have taken life very seriously, though at the age of twenty-four there flashed into his mind the first notions of a new and powerful mathematical method, and he soon afterwards abandoned his Parisian associates and withdrew to Holland where, after a few years of travel and soldiering, he finally settled down to work. This does not mean that he settled down to drudgery: far from it, for he was too idly inclined; moreover, he was not only reasonably well off but he could do more work in one hour than most men could do in three.

Descartes was born at a time when reactions against the Reformation—the great upheaval of European religious life—were making themselves strongly felt. In Germany, in particular, the Reformation found its weakness in its individualism, in its internal divisions, and in its struggles for supremacy. Its work, though undoubtedly very necessary, was work of a destructive kind, and therefore liable to reaction. Moreover, individualism which becomes too exclusive is always fraught with danger; when every man searches for truth and finds it in his own particular way, he is apt to think he has found it for all mankind. By the end of the sixteenth century, not a few of the old false standards had been swept

away, but the new ones that had been set up became as arbitrary as the old and were maintained with even greater vehemence. Catholicism had, however, learnt its lesson, and the Roman Church of the seventeenth century was very different from that of the sixteenth; she was far stronger and far more healthy and active.

Calvin's plea for individual liberty did at least have this effect, that men refused to be tied down any longer by artificial trammels. A restless spirit of inquiry was abroad. Progress was obvious everywhere. The wonderful success of continental science workers was teaching men to depend far more on their own powers, and far less on supernatural aid, for discovering exactly how the operations of nature were carried on.

Such were the intellectual influences under which the life of Descartes opened. It was precisely the time when latent talent was likely to be called forth, and since in no sphere of learning were the new intellectual movements more apparent than in that of natural science, Descartes was drawn into the scientific stream. The date of the dividing line between the old order and the new, is sometimes said to be 1600 when Bruno was martyred, but the act which in a far greater degree shocked all Christendom was Galileo's condemnation by the Inquisition in 1633. Until then authority had reigned supreme; from that time onwards men began to think seriously for themselves. Descartes was then thirty-seven. In England, clouds were gathering for civil war.

We may usefully touch upon three of Descartes' intellectual interests; his philosophy, his speculative science, his geometry.

Descartes' Philosophy.—Descartes adopted as a fundamental principle that nothing should be believed except on evidence so convincing that assent could not by any effort be refused. Yet in any existing philosophic system he could find no criterion of positive certainty. To him the great question therefore was, Is there in knowledge an ultimate basic principle which I can regard as absolutely true and certain?

His object was *to find a starting-point from which to reason*, to find an incontrovertible certainty. This he found in his own consciousness. "Doubt as I may, I cannot doubt of my own existence, because my very doubt reveals to me something which doubts." "*Je pense, donc je suis.*" "*Cogito, ergo sum.*" "This is a certainty if there be none other."

The vital portion of Descartes' system lies in this axiom: *whatever idea is clearly and distinctly conceived is true.* By *clear* Descartes meant with plenty of light on the idea, so that it is not dim or obscure; by *distinct* he meant standing out in bold relief, so that there is no difficulty in distinguishing one idea from other ideas. "We must not, of course, think that the clearness of its perception *constitutes* the truth of the idea."

Descartes' next step was to lay down four rules for the proper detection of the ideas: (1) Never accept anything as true that cannot be recognized as clearly and distinctly so; (2) Divide each difficulty into as many parts as possible; (3) Conduct the examination methodically and in order, beginning with the simplest and most easily-known objects; (4) Make enumerations so complete, and reviews so general, that nothing essential is omitted.

Descartes' method was profoundly influenced by his mathematical studies. His methods were essentially deductive. He felt that there was complete safety in a jumping-off ground of a few unassailable axioms. The suggestions he offered for a new method were entirely different from those of Bacon. Neither Bacon's nor Descartes' methods were very fruitful, but both philosophers saw the *need* of a new method, and considering the infant days of science in which they lived, they did a good deal to set men on the right path. But they showed an incomprehensible reluctance to confer with successful men of science who were masters of method and who so willingly would have helped. For instance, Bacon went out of his way to criticize his fellow countryman Gilbert harshly; and Descartes slightly ignored Galileo—a far greater man than himself.

Descartes' Vortices.—Kepler had shown *how* the planets move, but in doing this he had abolished Ptolemy's "primum mobile", and there was now nothing to show *why* the planets moved. Descartes was the first to offer a solution to this problem. He assumed that space is a plenum, filled with an all-pervading fluid, that this fluid is in a state of motion, and that the most natural kind of motion is circular. Doubtless he had seen light bodies carried round by eddies of wind and by eddies of water. At all events he devised a scheme of whirlpool-like movements for the universe and called them *vortices*. The sun he considered to be at the centre of an immense whirlpool of the primary fluid in which the planets floated and were swept round like straws in a whirlpool of water. Each planet was the centre of a secondary whirlpool, by which the satellites were carried round. He worked out his theory in great detail, and it was looked upon as providing a new era in astronomy; it was an attempt to explain the phenomena of the whole universe by the same mechanical laws which small scale experiments on the earth show to be true. Gravitation was explained by a settling down of bodies towards the centre of each vortex; cohesion by an absence of motion tending to separate particles of matter. Descartes could "imagine no stronger cement".

The theory attracted great attention. It was taught at the universities, and it was therefore included in Newton's own course of undergraduate study at Cambridge. People were pleased to think that they now knew *why* as well as *how*.

But the theory was not connected with Kepler's laws. Indeed, Descartes probably did not know anything about the laws. He read little, and the jealousy and selfishness in his nature caused him to work very largely alone. The theory was pure speculation, and was bound to collapse at the first touch of a master hand. A generation later, Newton examined it in detail and showed conclusively that the consequences were quite inconsistent both with Kepler's laws and with the fundamental laws of mechanics.

That the vortex theory foreshadowed modern theories of the origin of the solar system must be denied. Such theories, even those which have now been finally abandoned, have at least been based on numerous correlated facts of an undisputed kind. Nor can it be admitted that the theory has any sort of relation to modern theories of matter, ethereal or other, for again these have been the outcome of much carefully considered experimental and mathematical work, though some of them have collapsed in the light of new facts. Descartes' theory of vortices is just an ingenious speculation, not to be regarded as serious science, and only fit for the museum to which it has long been relegated.

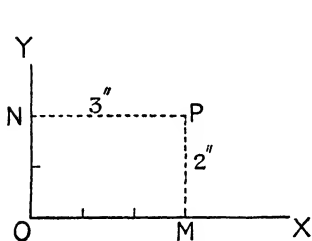

Fig. 46

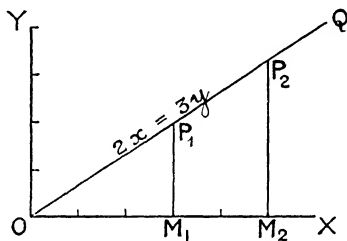

Fig. 47

Descartes' Geometry.— It is from this branch of Descartes' work that his real importance emerges. He was unquestionably a front-rank mathematician, and the system of algebraic geometry which he originated has proved an instrument of the greatest value in the hands of all subsequent mathematical workers.

The basic idea of the system was not new. The fixing of the position of a place by means of its latitude and longitude had been familiar to the Greeks. The position of a point in any plane may be similarly "fixed" by stating its perpendicular distances from two arbitrarily chosen lines drawn at right angles to each other. These lines are commonly marked OX and OY and are called "co-ordinate axes". Thus the point P may be 2 in. from the X axis and 3 in. from the Y axis. These distances, PM and PN, are known as the co-

ordinates of the point P, and if the co-ordinates are given the point can be fixed at once (fig. 46).

The reader will remember from his school-work on graphs that he had to "plot" such a line as $2x = 3y$. The algebraic equation was convertible into the geometrical line OQ (fig. 47). Since $2x = 3y$, $y = \frac{2}{3}x$, and this means that the y co-ordinate is always $\frac{2}{3}$ of the x co-ordinate. For instance, if from any point P_1 on the line we drop the perpendicular P_1M_1 on the OX axis, the co-ordinate (distance) P_1M_1 is $\frac{2}{3}$ the co-ordinate (distance) OM; so from any other point, say P_2 on OQ; the y co-ordinate P_2M_2 to the axis OX is $\frac{2}{3}$ of the x co-ordinate, OM_2 , to the axis OY.

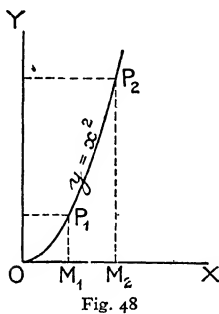

Fig. 48

Thus the plotted *geometrical* line OQ is the locus of points (we can obtain as many as we like), derived from the *algebraic* equation $2x = 3y$.

One more illustration. The curve (parabola) in fig. 48 is the *geometrical* equivalent of the algebraic equation $y = x^2$. Whatever the length of the co-ordinate (distance), x , along the axis OX, the length of the co-ordinate (distance), y , along the axis OY is the *square* of x . Thus if $OM_1 = 1$, $P_1M_1 = 1^2 = 1$; if $OM_2 = 2$, $P_2M_2 = 2^2 = 4$.

Again: suppose we have to solve two "simultaneous" equations. We may either solve algebraically, in the usual way, *or*, first draw the geometrical figures corresponding to the equations and then measure the co-ordinate distances of the point or points in which the geometrical figures, straight lines or curves, intersect.

In general, every algebraic equation in x and y that can be written down represents some curve in a plane, and the properties of this curve can be completely investigated in either one of two ways: (1) geometrically, from a geometrical figure; (2) algebraically, from the equation and without the use of a figure.

Even from the time of Euclid, algebra and geometry had

been made, in some small measure, to help each other. Descartes' great step was the recognition of the equivalence of (1) an algebraic equation, and (2), the geometrical locus of a point the co-ordinates of which satisfy the equation. He saw that in order to investigate the properties of a curve, it was sufficient to select, as a definition, any characteristic geometrical property, and to express it by means of an equation between the co-ordinates of any point on the curve. He thus translated the definition into the language of a special system of algebra. The resulting equation contains implicitly every property of the curve, and any particular property can be deduced from it without reference to the geometry of the figure.

It was Descartes who established the custom of using the letters at the beginning of the alphabet to denote known quantities, and those at the end to denote unknown quantities; who introduced the system of indices now in use; and who first realized the advantage of having all the terms of an equation on one side of it. Descartes knew that his system of co-ordinate geometry could be applied to space of three dimensions, but he did not work it out in detail.

"Cartesian" geometry, "co-ordinate" geometry, "algebraic" geometry, and "analytical" geometry, are different terms for the same thing. It is undeniably a great mathematical instrument, but it is a rather dangerous weapon in the hands of schoolboys, who are apt to cultivate facility in its use without much appreciation of the actual spatial relations involved.

Descartes' *Géométrie* is a difficult book to read, but the obscurity is intentional. "Je n'ai rien omis qu'a dessein . . . j'avois prévu que certaines gens qui se vantent de sçavoir tout n'auroient pas manqué de dire que je n'avois rien écrit qu'ils n'eussent sçu auparavant, si je me fusse rendu assez intelligible pour eux."—Descartes was vain and selfish, but the foibles of a great man are forgivable.

(Portrait of Descartes, Plate 8).

BOOKS FOR REFERENCE:

1. *Bacon's Works*, ed. Ellis and Spedding.
2. *Francis Bacon*, E. A. Abbott.
3. *Bacon's Novum Organum*, Fowler.
4. *Bacon's Realistic Philosophy*, Fischer.
5. *Descartes, His Life and Times*, E. S. Haldane.
6. *Descartes' Discourse on Method*, ed. Veitch.
7. *A Short History of Mathematics*, W. W. R. Ball.
8. *History of Mathematics*, Cajori.
9. *Histoire de la Philosophie Cartésienne*, Bouillier.
10. *Pioneers of Science*, Lodge.

CHAPTER XXIV

The Immediate Predecessors and the Contemporaries of Newton

During the latter half of the seventeenth century, that is, during later Stuart times, Western Europe was alive with brilliant mathematicians. Newton was, however, quite the outstanding figure amongst them, although, in order to appreciate the value of his work correctly, it is necessary to know something of the work of a few of the other leaders. But space will not permit of more than very brief reference to a small number of them.

CAVALIERI, 1598-1647.
FERMAT, 1601-1665.
WALLIS, 1616-1703.
PASCAL, 1623-1662.
HUYGENS, 1629-1695.
BARROW, 1630-1677.

WREN, 1632-1723.
HOOKE, 1635-1703.
NEWTON, 1642-1727.
LEIBNITZ, 1646-1716.
FLAMSTEED, 1646-1719.
HALLEY, 1656-1742.

Bonaventura Cavalieri, an Italian, born at Milan, became professor of mathematics at Bologna. It was he who invented the "principle of indivisibles", which he applied to numerous problems connected with the quadrature of curves and surfaces and with the determination of volumes. It served the same purpose as the old Greek "method of exhaustions" (see p. 55) and the two methods are, at bottom, almost identical, save that the notation of indivisibles is more concise and convenient. The principle of indivisibles is closely analogous to the principles of the integral calculus, so far as these are concerned with summation, and ultimately the integral calculus entirely superseded it.

Pierre de **Fermat** was a leisured Frenchman whose favourite study was the Theory of Numbers. From his correspondence it would seem that he had thought out the principles of analytical geometry for himself, before reading Descartes's *Géométrie*, and had realized that from the equation, or, as he calls it, the "specific property" of a curve, all the other properties of the curve could be deduced. His papers on geometry deal, however, mainly with the application of infinitesimals to the determination of the tangents to curves, to the quadrature of curves, and to questions of maxima and minima.

John Wallis was a Felsted boy who became a Fellow of Queen's College, Cambridge, and afterwards occupied the Savilian chair of geometry at Oxford. His most important work was his *Arithmetica Infinitorum*, in which the methods of analysis of Descartes and Cavalieri were systematized and greatly extended; it immediately became the standard work on the subject. He employed a process almost equivalent to, and certainly foreshadowing, integration; he explained negative and fractional exponents in the modern sense; and he developed ingenious methods of interpolation. Had he been acquainted with the binomial theorem, he would undoubtedly have carried his work much further. His *Algebra* is noteworthy as containing the first systematic use of formulæ.

Blaise **Pascal** was a French mathematical genius who deemed it his duty to devote so much of his time to religious exercises that his output of work was relatively small. At the age of fourteen he was admitted on equal terms to weekly meetings of well-known French mathematicians, and at sixteen he produced his famous theorem: *if a general hexagon be described in a conic, the points of intersection of the opposite sides will lie in a straight line.* With Fermat, he laid down the principles of the *Theory of Probabilities*. His famous *Arithmetical Triangle* is well known; it provides a very

simple means of finding the coefficients of the expansion of a binomial, or of finding the number of combinations of m things taken n at a time. He solved some very difficult problems on the cycloid, using the method of indivisibles; and his solutions are very similar to those which a present-day mathematician would give by the aid of the integral calculus. He also devoted attention to hydrostatics.

Christian Huygens (or Huyghens) was a Dutchman. For his astronomical observations, he required some exact means of measuring time, and he was thus led to invent the pendulum clock. The first watch made with a balance spring was also made under Huygens' directions. In 1690 he published his treatise on *Light* in which the undulatory theory was expounded; the general idea of the theory had been suggested by Hooke in 1664. But Newton advocated the emission theory, and his great reputation led to such a general disbelief in the rival undulatory theory, that the emission theory held the field until the theory of interference, suggested by Young a century later, was worked out by Fresnel. Huygens' demonstrations, like those of Newton, were rigidly geometrical, and apparently he made no use of the calculus.

Isaac Barrow was a boy at Charterhouse and then at Felsted and became a Fellow of Trinity College, Cambridge. Eleven years later he was appointed to the university professorship of Greek. Two years afterwards he was made professor of geometry at Gresham College, and within another year he was selected as the first occupier of the Lucasian chair at Cambridge. This chair he resigned to his pupil Newton after six years, "whose superior abilities he recognized and frankly acknowledged". He published his Lucasian lectures under the title *Lectiones Mathematicæ*. He also published *Lectiones Opticæ et Geometricæ* which Newton had revised and corrected. In the optical lectures many problems connected with reflection and refraction were treated with ingenuity. In his geometrical lectures he devised a method

for determining tangents to curves, a method which illustrates the way in which he and others were working, on the lines suggested by Fermat, towards the methods of the differential calculus. Indeed in some ways the method is hardly distinguishable from the procedure of the differential calculus.

Sir Christopher Wren was a Wiltshire man. His reputation as a brilliant mathematician has been overshadowed by his fame as an architect, but he was Savilian professor of astronomy at Oxford for twelve years, and for some time he was President of the Royal Society. With Wallis and Huygens he investigated the laws of the collision of bodies; and like Huygens, Hooke, and Halley, he made attempts to show that the force under which the planets move varies inversely as the square of the distance from the sun.

Robert Hooke, an Isle of Wight boy, was educated at Westminster, and Christ Church, Oxford, and became professor of geometry at Gresham College. Though an extremely able man, he was as jealous as he was vain and irritable, and he accused both Newton and Huygens of unfairly appropriating his results. Like Huygens he discovered that the small oscillations of a coiled spiral spring were practically isochronous, and was thus led to suggest the use of the balance spring in watches.

Gottfried Wilhelm Leibnitz was born at Leipzig in Germany. By the time he was twelve he had taught himself to read Latin easily and had begun Greek; and before he was twenty he had mastered the ordinary textbooks on mathematics, philosophy, theology, and law. From the age of thirty till his death at seventy he occupied the well-paid post of librarian to the Brunswick Ducal family at Hanover. Leibnitz fills at least as large a place in the history of philosophy as he does in the history of mathematics. The last seven years of his life were embittered by the long controversy

with Newton and others, as to whether he had discovered the differential calculus independently of Newton's investigations, or whether he had derived the fundamental idea from Newton. We refer to this in the next chapter.

John **Flamsteed**, a Derby man, was one of the most distinguished astronomers of his age, and was the first astronomer-royal. He invented the system of drawing maps by projecting the surface of the sphere on an enveloping cone, which can then be unwrapped.

Edmund **Halley** went from St. Paul's School to Oxford; he succeeded Wallis as Savilian Professor, and was subsequently appointed astronomer-royal in succession to Flamsteed. It was he who so generously secured the immediate publication of Newton's *Principia* in 1687. He also brought out a fine edition of the conics of Apollonius.

The three **Bernouillis**, James (1654-1705), John (1667-1748), and Daniel (1700-82), belonged to a Dutch family who were driven out of Holland and settled at Bâle in Switzerland. They were all distinguished mathematicians.

There were at least a score of others, perhaps two score, working in the same field at this time, their names all familiar to mathematicians.

But the central figure of the age was **Newton**. He towered above even the most distinguished of his contemporaries. He stood alone. We must consider him at some length.

(Portrait of Huygens, Plate 8).

BOOKS OF REFERENCE:

1. *History of Mathematics in Europe*, J. W. N. Sullivan.
2. *History of Elementary Mathematics*, F. Cajori.
3. *History of Mathematics*, D. E. Smith.
4. *A Short History of Mathematics*, W. W. R. Ball.

CHAPTER XXV

Isaac Newton

1642-1727

Some six miles south of Grantham, on the Great North Road, is the village of Colsterworth, and a few minutes' walk away is the tiny hamlet of Woolsthorpe where, in the modest Manor House, Newton was born. He was the posthumous child of a yeoman farmer, and though the family were not exactly poor they were certainly anything but wealthy. In due course he attended the local village schools.

Grantham Parish Church is one of the largest and finest in the country, and within its shadow still stands the old building of the King's School to which Newton was admitted at the age of eleven. It is a single room about seventy-five feet long, and, though modern buildings have been erected hard by, it is still used for various school purposes. In those days, as in later days, schoolboys loved to carve their names or initials on their desks or on the class-room walls, and young Isaac Newton's are still in the old school for all the world to see.

As a schoolboy he was thoughtful and rather silent, occasionally a little mischievous, not pugnacious, though he could use his fists effectively when necessary, and at first he showed no great ability except with his hands. His mechanical ingenuity seems to have been quite exceptional, and his biographers are fond of giving details of the many mechanical models he made—clocks, windmills, sundials, and so on. At about the age of fourteen he left school and went home to try his hand at farming, but his heart was in books, experiments,



LEIBNITZ
*From the portrait in the Florence
Gallery*



HARVEY
National Portrait Gallery



WREN
National Portrait Gallery



ROBERT BOYLE
National Portrait Gallery

and mechanism, and it soon became clear that he would never make a farmer. He was therefore sent back to school, where in due time he became head boy, and in his nineteenth year went on to Cambridge.

He did not enter Trinity College as a very learned youth. Other students had done more than he. Of mathematics he knew hardly anything. But the vigour of his intellect soon caught the attention of his tutors, and on more than one occasion he was found to have mastered, independently, important books which were to be prescribed for future extended lecture courses. The first book he read at College was Kepler's *Optics*, a subject in which, later, he made some of his first great discoveries. He bought a "Euclid" and though he probably mastered it at once his practical mind judged it to be trifling; the author seemed to be proving things that were self-evident. But here, of course, he made a mistake. When he was twenty-one he competed for a university scholarship, and although he was successful the examiners commented on his poor knowledge of geometry. He had, however, already read Descartes' *Géométrie*, and Wallis's *Arithmetica Infinitorum*; and he had attended Barrow's lectures.

It must be borne in mind that Newton had not spent his schooldays as other boys had done. His mind had been essentially that of an experimenter; he had been ever keen on *doing* things. All that was known of alchemy and chemistry he probably knew as a youth: he was certainly no mean chemist. "His main incentive to study was his desire to understand natural phenomena, such as the motions of the planets and comets, the periodic flow of the tides, the beautiful colours in the telescope and in soap-bubbles, the resistance of the air and the laws of motion, the properties of substances, and the transmutation of metals." And it must be further remembered that Oxford, not Cambridge, was then the home of English mathematics. The fame of Cambridge mathematics originated with Newton himself.

The examiners' rebuke was enough. Within a year

Newton had actually discovered the Binomial Theorem! He had thus secured for himself a niche in the temple of fame by the time he had taken his B.A. degree (1665).

The college was closed in 1665-6 because of the Great Plague, and Newton spent the time at home. During these few months he made brilliant discoveries: he thought out the fundamental principles of his theory of gravitation; and he worked out the main principles of the fluxional calculus (a document dated 13th November, 1665, shows that Newton, who was not quite twenty-three, actually used fluxions to find the tangent and the radius of curvature at any point on a curve). Newton communicated these results to his friends and pupils from and after 1669, but they were not published till many years later. Newton often kept his discoveries to himself for a long time. It was also while staying at home at this time that he devised some instruments for grinding lenses to forms other than spherical; and it was probably then that he decomposed solar light into different colours.

On his return to Cambridge in 1667, Newton was elected to a Fellowship at his college. In 1669 Barrow resigned the Lucasian chair in favour of Newton who was still under twenty-seven. Barrow had been so much impressed by Newton's learning and ability that he did not hesitate to nominate him as his successor.

Of Newton's numerous discoveries we may touch upon separately his (1) **Optics**, (2) **Theory of universal gravitation**, (3) **Fluxional calculus**. It is, however, utterly impossible to do justice to his work in a few pages, and we are forced to omit all reference to his chemical researches.

In what follows the reader should remember that Newton was looked upon by his contemporaries not as a "pure" mathematician but as a mathematical physicist. Newton seems to have looked upon mathematics as working tools for his physics, his mechanics, and his astronomy. Such tools as he found ready to hand he used, but when his work required a new tool he invented one. This explains the invention of the calculus. To him the calculus was not a

mere branch of pure mathematics for providing new puzzles for the examination-room; it was a tool to help him in his researches in gravitation and astronomy. The old tools were too clumsy. Wallis and others had already roughed out the sort of tool he wanted, but they left it in far too rough a state for the work he wanted to do, and he had to exercise much ingenuity to perfect it.

I. Newton's *Optics*.—The invention and use of the telescope by Galileo keenly interested scientific men in the seventeenth century. When still an undergraduate Newton engaged in optical research, and naturally, therefore, he had a telescope. But telescopes in those days were defective; images were not clear, and no means were known of eliminating the disturbing chromatic aberration due to unequal refraction of the different colours. (Spherical aberration, as distinct from chromatic aberration, was well known to Newton's predecessors.) Newton took the problem in hand, but for once his resourcefulness failed him, and eventually he abandoned the hope of making a refracting telescope that should be achromatic.

In 1663 (Newton was then twenty-one) James Gregory of Aberdeen had suggested that a *reflecting* telescope might perhaps be used instead of a refractor, a concave mirror being substituted for the object (convex) lens. Newton took the matter up and made a small model of a reflecting telescope in 1668. He now saw his way to solve the main problem—to make a telescope free from chromatic aberration—and a year or two later he made with his own hands the first reflecting telescope of standard form. The two types of instrument have this in common, that the eye-piece magnifies a real image, but in the refractor this image is formed by the object glass (convex lens), and in the reflector by the concave mirror. The reader may never have seen a reflecting telescope, but reflecting telescopes are in quite common use in astronomy. The largest telescope in the world, the 100-in. telescope in the Mount Wilson Observatory, California, is a reflector.

The Royal Society, then recently founded, asked Newton to send his telescope to London for their inspection. Their approval of the instrument was cordial and the result was Newton's election as a Fellow. Newton was then twenty-nine. The telescope (fig. 49) is now a treasured possession at the Royal Society's head-quarters.

Newton's researches on light are for the most part embodied in his book "Opticks, or a Treatise on the Reflections,

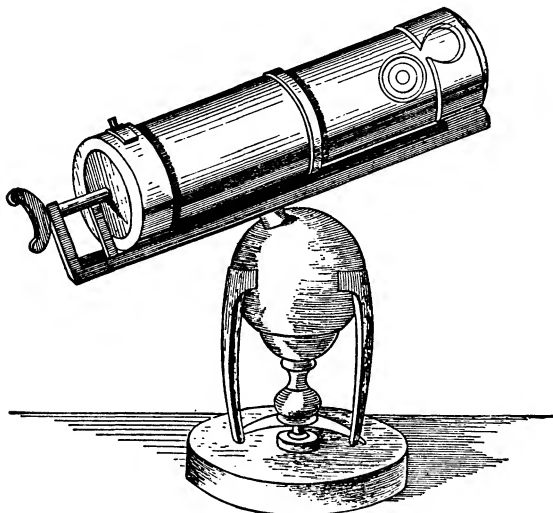

Fig. 49

Refractions, Inflections, and Colours, of Light". "My desire in this Book is not to explain the Properties of Light by Hypotheses, but to propose and prove them by Reason and Experiments." With the possible exception of Faraday's *Researches*, this book undoubtedly stands first in the whole range of scientific literature, from the point of view of revealing scientific procedure and method as pursued by a master mind. In contrast with the *Principia*, it is easy to read, and it should be read by everybody interested in science.

Before he was twenty-three years of age Newton was led to examine the formation of a coloured spectrum by a prism. To do this he darkened his room and let in a "convenient quantity" of sunlight through a small hole in the "window-shuts", placing a prism at the hole in order that the light might thereby be refracted to the opposite wall. He observed that the length of the coloured spectrum was many times as great as its breadth, and from further experiments he was

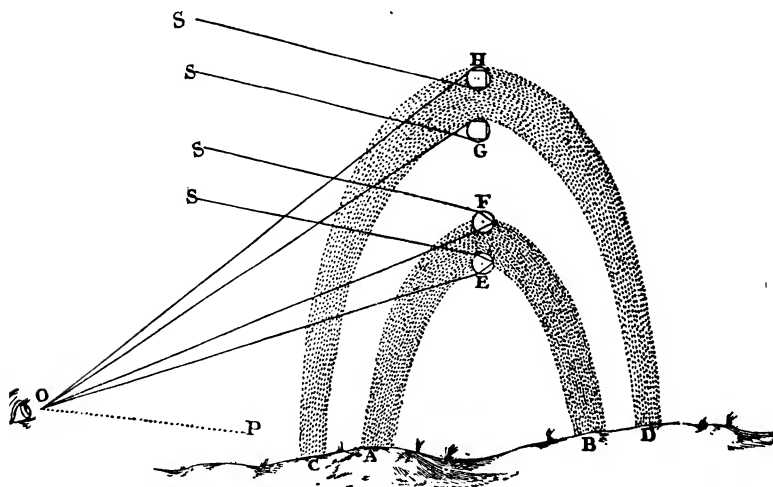

Fig. 50

led to the view that ordinary white light is really a mixture of rays of every variety of colour, and that the elongation of the spectrum is due to the differences in the refractive power of the glass for these different rays. "To the same degree of Refrangibility ever belongs the same colour, and to the same colour ever belongs the same degree of Refrangibility."

These and kindred discoveries formed the subject-matter of lectures which Newton delivered as Lucasian professor in the years 1669, 1670, 1671. His complete explanation of the theory of the rainbow (fig. 50) was a corollary to the discoveries. The results, in summarized form, were embodied

in a paper communicated to the Royal Society in 1672. Fig. 50 is Newton's own.

Naturally, Newton was deeply interested in the question *how* the effects of light were produced, and by the end of 1675 he had worked out the *corpuscular* or *emission* theory, and had shown how it would account for all the various phenomena of geometrical optics, including refraction, reflection, diffraction, and colours.

But Huygens and Hooke had put forward a different theory, namely that light was a *vibratory motion of the æther*, and that colour depends on the form of the light-wave. An acute controversy took place, and the irascible Hooke assailed Newton so vehemently that ever afterwards Newton showed much reluctance to make known his discoveries to the world.

Newton rejected Hooke's wave theory because it failed to explain either the rectilinear propagation of light or the facts of polarization. He outlined his corpuscular theory in this way: "Assuming the rays of light to be small bodies, emitted every way from shining bodies, those when they impinge on any Refracting or Reflecting surface, must as necessarily excite vibrations in the æther as stones do in water when thrown into it." In reply to Hooke's charge of holding the doctrine that light is a material substance, he said: "'Tis true that from my Theory I argue the Corporeity of Light, but I do so without any absolute positiveness, as the word 'perhaps' intimates; and make it at most a very plausible *consequence* of the Doctrine, and not a very fundamental *supposition*." "I do not think it needful to explicate my Doctrine by any *Hypothesis* at all;" "I have spoken of Light as something or other propagated every way in straight lines from luminous bodies, without determining what that thing is." "It seems impossible that the *waves* or Vibrations of any Fluid, can, like the Rays of Light, be propagated in straight lines, without a continual and very extravagant spreading and bending every way into the quiescent medium, where they are terminated by it." Newton also replied to

Huygens, the actual propounder of the undulatory theory of light, but Huygens's objections, unlike Hooke's, had been put forward courteously.

Newton, like Huygens, held the view that all space is permeated by an elastic medium or æther, but Newton maintained that the vibrations of the æther cannot be supposed *in themselves* to constitute light, and that therefore the most definite and easily conceived supposition is that rays of light are streams of corpuscles emitted by luminous bodies. Although this was not the hypothesis of Descartes himself, it was closely akin, and the scientific men of Newton's generation, who were for the most part deeply imbued with the Cartesian philosophy, instinctively embraced it.

Newton did not much like the assumption of an æther the existence of which he could not prove directly, and at one time he rejected it, though he revived it again later when universal gravitation was added to the things requiring explanation. It was a fundamental principle with Newton to place his confidence almost entirely in observation and experiment. Hypotheses he distrusted, though he soon found that without hypotheses of some kind he could not build up a consistent doctrine to explain all the phenomena of light.

At the end of the *Opticks* is a number of "queries". "Since I have not finished this part of my Design, I shall conclude with proposing only some Queries in order that a further search might be made by others." All are worth reading. Here is a portion of the 28th:

"Are not all Hypotheses erroneous, in which Light is supposed to consist in Pression or Motion, propagated through a fluid Medium? For in all these Hypotheses, the Phenomena of Light have been hitherto explained by supposing that they arise from new modifications of the Rays; which is an erroneous supposition. If Light consisted only in Pression propagated without actual Motion, it would not be able to agitate and heat the Bodies which refract and reflect it. If it consisted in Motion propagated to all distances in an instant, it would require an infinite force every moment,

in every shining particle, to generate the motion. And if it consisted in Pression or Motion, propagated either in an instant or in time, it would bend into the shadow. For Pression or Motion cannot be propagated in a fluid in right lines beyond an obstacle which stops part of the Motion, but will bend and spread every way into the quiescent Medium which lies beyond the Obstacle. The waves on the surface of stagnating water, passing by the sides of a broad Obstacle which stops part of them, bend afterwards and dilate themselves gradually into the quiet water behind the Obstacle. The waves, pulses, or vibrations of the Air, wherein Sounds consist, bend manifestly, though not so much as the waves of water. For a bell or a cannon may be heard beyond a hill which intercepts the sight of a sounding body, and Sounds are propagated as readily through crooked Pipes as through straight ones. But Light is never known to follow crooked Passages nor to bend into Shadow. . . . ”

A century later, Newton's corpuscular or emission theory gave way to the wave theory. A century later still, that is at the present time, the two theories seem to be melting into one.

II. Universal Gravitation.—When at home during the great plague, Newton brooded on the problem, as so many of his predecessors had done. “What makes the planets move round the sun?” Kepler had discovered *how* they moved, but it was still not known *why* they so moved.

The Laws of Motion, discovered by Galileo, were thus stated by Newton:

1. If no force acts on a body in motion, it continues to move uniformly in a straight line.
2. If force acts on a body, it produces a change of motion proportional to the force and in the same direction.
3. When one body exerts force on another, that body reacts with equal force upon the one.

These laws are fundamental. The old idea had been that some force is necessary to maintain motion. On the contrary,

as the first law asserts, some force is needed to destroy it. Leave a moving body alone, free from friction and other retarding forces, and it will go on for ever. The planetary motion through empty space therefore wants no keeping up; it is not the *motion* that demands a force to maintain it; it is the *curvature of the path* that needs a force to produce it continually. The second law asserts that the motion changes *either* in speed *or* in direction *or* in both. Hence since it is almost solely in *direction* that a planetary motion alters,

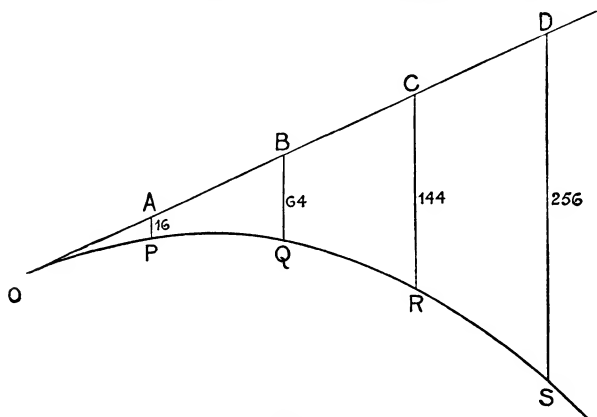

Fig. 51

only a deflecting force is needed, a force normal to the path. The third law states that it is impossible to have one force alone; there must be a pair.

The great law of mechanics is the second law. The change of motion of a body depends solely and simply on the force acting, and not at all upon what the body happens to be doing at the time the force acts. A stone thrown from O with a velocity OA would in 1 sec. reach A, in 2 sec. B, in 3 sec. C, and so on, in accordance with the first law of motion, if no other force acted. But since gravity acts, it falls 16 ft. by the time it would have reached A and so will be at P. In 2 sec. it will be at Q, in 3 sec. at R, and so on. Its actual path will be a curve, very approximately a parabola,

but actually an ellipse with one very distant focus and the other focus at the centre of the earth. It is not able to complete its orbit because the earth is in the way. Actually it is a minute satellite of the earth, a moon, and but for the air would accurately obey Kepler's laws (fig. 51).

As a force of attraction, "gravity" was, of course, known to the ancients as well as to Newton's predecessors, but the inverse square law was due to Newton himself, though it is probable that some of his contemporaries discovered it independently. The kind of argument that probably occurred to them at first was something of this kind. Suppose that from a point O there is a gravitational influence in all directions. Consider two spheres with centres at O, one having double the radius of the other. The same gravitational influence is spread out over the surface of the two spheres; but the sphere of double radius has a surface area *four times* that of the smaller sphere. Hence the gravitational pull at a point on the larger sphere must be *one quarter* of the pull at a point on the smaller sphere. This may be generalized into the inverse square law, viz. that at any point the gravitational pull exerted is inversely proportional to the square of the distance of this point from the gravitating body.

But Newton would not be satisfied with a theoretical argument of that kind and he sought to justify it by observation or experiment. Kepler's third law, the result of actual observations provided him with the very proof he required.

Every schoolboy who has done a little mechanics knows that if a particle is describing a circle of radius r with constant velocity v , then the acceleration f of the particle towards the centre is v^2/r , i.e.

$$f = \frac{v^2}{r} \quad (1)$$

This relation was first enunciated by Huygens.

Let v be the velocity of a planet, r the radius of its orbit

taken as a circle, and T its periodic time (time of revolution), and let $T^2 \propto r^3$ represent Kepler's 3rd law:

$$\begin{aligned} \text{Then, since} \quad v &= \frac{2\pi r}{T} \\ \therefore f &= \frac{4\pi^2 r}{T^2} \quad . \quad . \quad . \quad . \quad (\text{from (i)}) \\ \therefore f &\propto \frac{4\pi^2 r}{r^3} \quad . \quad . \quad (\text{Kepler's 3rd law}) \\ \therefore f &\propto \frac{4\pi^2}{r^2} \end{aligned}$$

that is, the acceleration towards the centre (the pull) is inversely proportional to the square of the distance.

Of course the planets move in ellipses, not circles, but the planets are *very nearly* circles. The larger problem Newton solved later.

Newton argued by analogy that if the gravitational pull of the sun on the planets follows the inverse square law, then the pull of the earth on the moon, like its pull on a falling stone, must also follow that law. He felt convinced that similar effects must be produced by similar causes.

He knew the moon's distance from the earth's centre to be sixty times the earth's radius. Hence the attraction exerted by the earth on the moon must be $1/60^2$ of the attraction exerted by the earth on a body near its own surface, such as a falling stone. Since the accelerative effect on a falling stone near the earth's surface is to add a velocity of 32.2 ft. per second every second, the accelerative effect on the moon must be a velocity of $32.2/60^2$ ft. per second every second, i.e. .00895 ft.

Now this result could be tested, and Newton took the problem in hand. He knew (or thought he knew) the *distance* EM of the moon and therefore the length of its circular path; and he knew the *time* (a month) that the moon took to go once round it. Hence he could easily find its velocity at any

given point such as M. He could therefore find the distance MT through which it would move in the next second if it were not pulled by the earth's attraction. At the end of the first second the earth was not at T but at M', and therefore the earth must have pulled it through the distance TM' in 1 sec. Obviously this distance TM' is a measure of the acceleration towards the earth (fig. 52, i).

(Fig. 52, ii shows how the moon may be supposed to be jerked back, from its tangential path, towards the earth at the end of each second for 3 sec., but of course the attract-

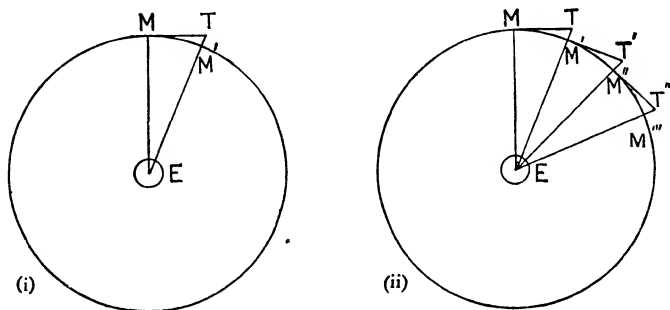

Fig. 52

ing force is *continuous*, not made in jerks, and the path is therefore curved, not polygonal. In the figures the angles are greatly exaggerated for the sake of clearness.)

Since $f = v^2/r$ (as before), since f is measured by TM' since r is known ($= 60^2R$ miles, where R is the radius of the earth), and since v is known ($2\pi 60^2R$ miles are traversed in 27 days 13 h. 18 min. 37 sec.), it follows that $f = .00775$ ft. per second added each second. (The arithmetic is simple but tedious.)

Thus Newton had two results for the accelerative effect of the earth on the moon:

- (1) From Huygens' formula for motion in a circle
 (then already established, and ever since recognized as a basic formula in mechanics), with no assumption as to the inverse square law. } $.00775$

(2) From the assumption that the inverse square law } holds good between the earth and the moon } .00895

Newton was keenly disappointed (he was only twenty-three): "my thought has been but an idle speculation." The discrepancy was much too great for the inverse square law to be accepted. He put the problem aside and said not a word to anybody about it. It never occurred to him to try to patch up his theory. He was far too honest intellectually for that.

But he had been right after all. Little more than boy as he was, he had divined one of the great secrets of the universe. We know now that the inverse square law is the law of universal gravitation.

His calculations from Huygens's formula were based upon the length of the moon's orbit which had been calculated from r , the radius of the orbit; and r in its turn had been calculated from R , the radius of the earth. The value of R was then supposed to be 3440 miles. As this length was more than 500 miles short of the true length, the result was necessarily wrong. On the other hand, the result as determined by the assumption of the inverse square law was *correct*; it was the Huygens' formula result that was wrong, that is, the formula which he used for checking purposes: it was 14 per cent short.

It was some years before Newton took up the problem again. In the meantime he pursued his researches in mathematics and optics. The discrepancy does not, however, seem to have shaken his faith in the belief that gravity extended as far as the moon, in accordance with the inverse square law. He seems to have inferred that some other force, probably Descartes' vortices, as well as gravity acted on the moon. It seems, moreover, that Newton already believed firmly in the principle of universal gravitation, that is, that every particle of matter attracts every other particle, and he suspected that the attraction varied as the product of their masses and inversely as the square of the distance between them.

But others as well as Newton were meditating seriously

about the gravitation problem, especially Newton's three friends, Hooke, Wren, and Halley. All three were extremely able men, and Wren and Halley were devoted and loyal to Newton, but Hooke was of a rather jealous, suspicious, and ill-natured disposition. There is little doubt that all three discovered the inverse square law independently of Newton, probably from considering Kepler's third law. There is equally little doubt that all three hoped to discover the secret of universal gravitation, and at least Hooke made some claims of having done so, though he never produced any kind of proof. Hooke became secretary of the Royal Society in 1678. He often made shrewd guesses, and his "dogmatism in writing" sometimes impelled Newton to look into them in order to discover if they contained a grain of truth, which they certainly often did.

In 1672 the Frenchman Picard communicated to the Royal Society the result of his measurements of the earth's radius, 3963 miles, at the very meeting at which Newton was elected a Fellow and at which his reflecting telescope was exhibited. Picard's value for a degree of latitude was 69.1 miles as compared with the former value of 60 miles which Newton had used in his calculations of 1666. It is difficult to imagine how the difference of about 14 per cent or 15 per cent could have escaped Newton's notice, for it was just the quantity required to correct his 1666 result. It was not, however, for some years that his attention was drawn to it, and then he unearthed his old papers. If gravity were the force keeping the moon in its orbit, it would fall towards the earth with an accelerative effect of .00895 ft. per second every second. What was the *actual* effect? Using the corrected value of the earth's radius, he calculated the result on the basis of Huygens's formula again. The discrepancy had vanished! A great secret of the universe was revealed.

But the great problem of universal gravitation was only at its initial stage, and Newton quietly settled down to solve it. He was only too well aware of the immense amount of labour in front of him. The **Principia** was begun.

Hooke, Wren, and Halley were also at work, though they could make no headway. They had all conjectured that the force of the attraction of the sun or earth on an external particle varied inversely as the square of the distance, but *they could not deduce from the law the orbits of the planets*, and this was the key problem. Baffled, Wren at last made a sporting offer that if Hooke and Halley could produce the mathematical proof within two months, he would present the discoverer with a book of forty shillings. Hooke pretended that he had made the discovery, but that he would conceal it for a time. After waiting seven months Halley went to Cambridge to see if Newton could help solve the problem. He said:

“What would be the path of a planet under gravitational attraction according to the inverse square law?”

“An ellipse,” Newton instantly replied, “with the centre of force at one focus.”

“How on earth do you know?” said Halley in amazement.

“Why, I have worked it out,” and he began hunting for the paper, which, however, he could not find, though he sent it on to Halley afterwards.

Halley was overjoyed. He went to Cambridge again, and found that Newton had already embodied the result, and much more, in a short treatise which afterwards became part of the *Principia*. The treatise was sent to and welcomed by the Royal Society in 1684, and Newton then intimated that he had a much larger and completer treatise on hand. He devoted to this great work two years of hard labour, 1684-6, that is between the ages of forty-two and forty-four. Flamsteed, the then astronomer-royal, supplied Newton with a large number of new and accurate astronomical observations, especially about the orbit of Saturn, the motions of Jupiter's and Saturn's satellites, the tides, and other matters, which went far to enable Newton to complete his great work.

The work completed, the question of its publication arose. The Royal Society was then too poor to undertake it; so was Newton himself. In the end Halley, by no means a rich

PHILOSOPHIÆ
NATURALIS
PRINCIPIA
MATHEMATICA.

AUCTORE
ISAACO NEWTONO, EQ. AUR.

Editio tertia aucta & emendata.

LONDINI:

Apud GUIL. & JOH. INNYS, Regiæ Societatis typographos.
MDCCXXVI.

man, volunteered to do it, and he also saw it through the press. And thus the *Principia* was given to the world.

The *Philosophiæ Naturalis Principia Mathematica* was published in 1687. Mathematicians and men of science* all over the world are unanimous in their opinion that, in their own subjects, it is by far the greatest book ever written. Indeed it stands alone. No other book has any claim to be placed in the same class. What the Bible is to Christians and the Koran to Mahomedans, the *Principia* is to men of science and to mathematicians. It has been well said that the mathematician who has not made a serious attempt to master it cannot possibly know his job. Even to the mathematician, however, it affords no easy reading. For 250 years the problems initiated and the results deduced have been the admiration of the successive generations of astronomers and mathematicians all over the world. Over and over again the greatest triumphs of human thought have been achieved as the direct consequence of the study of the *Principia*. The exact working out of the motions of the bodies in the solar system at the hands of Laplace, Lagrange, and their successors have introduced into astronomical prediction an accuracy that is almost incredible.

The title-page of the Third Edition is shown on p. 208.

The book was written in Latin, the international language amongst learned men until quite recent times. Much has been written about Newton's style; it is sufficient to quote Lagrange: ". . . tout cela présenté avec beaucoup d'élégance, assure à l'ouvrage des Principes, la prééminence sur les autres productions de l'esprit humain."

The demonstrations throughout the work are geometrical. The calculus had already been invented by Newton, but it was then unknown even to mathematicians, and had Newton used it to demonstrate results which were themselves opposed to the philosophy prevailing at the time, the controversy as to the truth of the results would have been hampered by a

* Much of the physics and chemistry of biology has still to be worked out and the mathematics of biology is still in its infancy.

dispute concerning the validity of the methods used in proving them.

The book consists of three parts, the first two being *De Motu Corporum* and the third *De Mundi Systemate*. *De Motu Corporum* contains a summary of the method of fluxions, a generalization of the law of attraction into the law of universal gravitation, and the principles of mechanics, hydrostatics, and hydrodynamics, with special applications to waves, tides, &c. *De Mundi Systemate* is concerned with astronomy.

Here is an extract from the Preface:

“All the difficulty of philosophy seems to consist in this, to investigate the forces of Nature from the phenomena of motions, and then from these forces the other phenomena. And to this end the general propositions in the first and second books are directed. In the third book we give an example of this in the explication of the System of the World. For by the propositions mathematically demonstrated in the first books we there derive from the celestial phenomena, the forces of Gravity with which bodies tend to the Sun and the several Planets. Then from these forces by other propositions, which are also mathematical, we deduce the motions of the Planets, the Comets, the Moon, and the Sea.”

The outstanding and basic discovery of the *Principia* is the **Law of Universal Gravitation**:

“*Every particle of matter attracts every other particle of matter with a force proportional to the mass of each and to the inverse square of the distance between them.*”

In an introductory chapter the *Principia* formulates *Axiomata, Sive Leges Motus*, the three laws which form the basis of the modern science of dynamics. Amongst the many discoveries made, described, and demonstrated in the course of the work are, the application of the principles of mechanics to the solar system, the principles of physical astronomy, the lunar theory, the cometary theory, and the theory of the tides.

It was Newton's treatment of the perturbations of the

moon that has probably struck with most amazement all future mathematicians. The moon is attracted not only by the earth but by the sun also; hence its orbit is perturbed, and Newton worked out the chief of these perturbations, viz. the evection, the variation, the "annual equation," the retrogression of the nodes, the variation of inclination, the progression of the apses, the inequality of apogee, and the inequality of nodes. There are said to be some thirty other minor irregularities. Altogether, the lunar theory, or the problem of the moon's exact motion, is one of the most complicated and difficult in the whole range of astronomy and mathematics. Some idea of the difficulty may be obtained by considering the following problem: "Given three rigid spherical masses thrown into empty space, with any initial motions whatever, and abandoned to gravity: to determine their subsequent motions." This is the famous problem of "the three bodies", and so far it has proved to be beyond the reach of mathematics.* But even when it is solved it will be only an approximation to the case of the earth, moon, and sun, for these bodies are not spherical and are not rigid. Now extend the problem to the multitude of bodies in the whole solar system. The mind almost reels at the thought of it.

The problem that has always most interested the present writer is Problem XXI (Proposition XLI) of the third book: *To determine the path of a comet, from observations made*—described by Newton himself as "a problem of very great difficulty". The demonstration extends to thirty-five pages with numerous tables and figures. The reader need not feel ashamed if he fails to follow it up: he will at least have learned to respect Newton. In the course of the demonstration Newton said: "Thinking it would not be improper, I have given a true representation of the orbit which this comet described, and of the tail which it emitted in several places, in the annexed figure." We give Newton's own figure (ABC is the orbit of the comet, D the sun, DE the axis, and

* Sir Oliver Lodge says that an American Professor has recently solved it.

I to V the positions of the comet on dates named from 4th November, 1680 to 9th March, 1681); the respective lengths of the tail seem to accord closely with the actual observations made by Flamsteed and others (fig. 53).

It is of interest to note that during the eighteenth century the Cartesian and Newtonian conceptions of the physical world gave rise to embittered controversies. For decades the Cartesians tried all the subtleties of logic and science to defend the vortex theory against the views based on universal

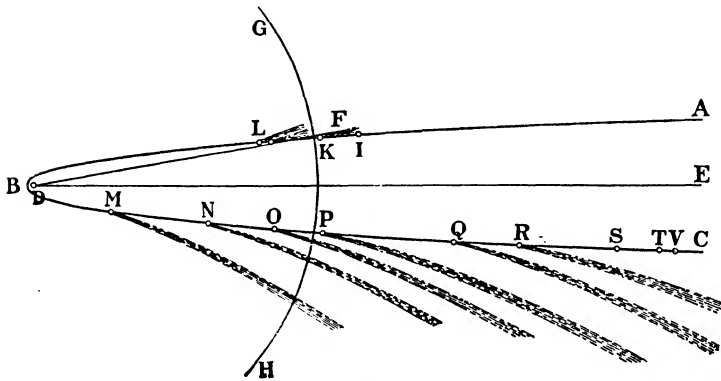

Fig. 53

gravitation. In the end they had to give way, and Voltaire's defence of Newton marked the turning of the tide. The opposition of the Cartesians may be explained by the fact that their master's theory was the first universal explanation of the solar system, independent of the occult forces which were in favour during previous centuries. But Cartesianism was bound to fall before the vast array of facts marshalled by Newton, especially as it was so strongly tainted with fancy and speculation.

III. The Fluxional Calculus.—The infinitesimal calculus, invented in the seventeenth century, provided mathematicians with a new and powerful tool for their work. Modern mathematics without the calculus is unthinkable.

In the study of natural science it is often necessary to deal with the *rates of change of various quantities*. In heat we have to deal with the *rate of change of temperature*; in dynamics, with the *rate of change of position*, and with *rate of change of velocity*; in engineering, with the *rate of change of work*; in mathematics, with the *rate of change in the direction of a tangent*. The differential calculus is that branch of mathematics dealing with such topics. In his theory of fluxions, that is, the *rates of flowing or changing quantities*, Newton discovered the first practical step in the development of the calculus.

Another kind of problem is to find the area of a closed curve. A rough way to do it would be to draw the curve on squared paper and count up the squares. The Greeks invented the "method of exhaustion" for the purpose (see p. 55). An extension of the area problem is to find the volume enclosed by a surface. In 1635 the Italian Cavalieri put forward a suggestion that an infinite number of points make a curve, an infinite number of curves make a surface, and an infinite number of surfaces make a volume. (He would have been more logically correct if he had said that a curve consists of an infinite number of infinitely short straight lines, a surface consists of an infinite number of infinitely narrow strips, and a volume consists of an infinite number of infinitely thin sheets). Cavalieri's suggestion began to bear fruit at once but for some time no rule for finding the areas of curves was discovered. Eventually Wallis put forward a rule for a particular class of curves, showing how "an infinite number of infinitely thin strips" might be summed. Before long Newton discovered the procedure for formulating the general rule, and the integral calculus was born.

The idea of a "fluxion" or "differential coefficient" is simple. When two quantities are so related that a change in one causes a change in the other, the one is said to be a function of the other. The *ratio of the rates* at which they change is termed the "fluxion" or the "differential coefficient" of the one with regard to the other, and the process

by which this ratio is determined is known as *differentiation*. The reverse is termed *integration*. Newton did not consider quantities to be composed of *indivisibles*, but to be *generated by motion*.

There are thus two kinds of problems, and Newton's treatment is as follows: (1) The object of the first is to find the fluxion of a given quantity, or, more generally, "the relation of the fluents being given, to find the relation of their fluxions". This is equivalent to *differentiation*. (2) The object of the second or inverse method is from the fluxion or some relation involving it, to determine the fluent, or more generally, "an equation being proposed exhibiting the relation of the fluxions of quantities, to find the relations of those quantities, or fluents, to one another". This is equivalent either to *integration* (which Newton termed the method of quadrature) or to the solution of a differential equation.*

The actual notation that Newton used would seem strange to modern mathematicians. The notation now in universal use is due to Newton's German contemporary Leibnitz. In principle, however, the two notations denote exactly the same thing.

Foreshadowings of the principles and even of the language of the calculus can be found in the writings of Kepler, Descartes, Cavalieri, Fermat, Pascal, Newton's friends Wallis and Barrow, and others. It was Newton's good luck to be born at a time when everything was ripe for the discovery, and his ability was such that he was able to construct the calculus when still a very young man. The invention would almost certainly soon have been made, even if Newton had not lived. Indeed Leibnitz claimed that he himself had invented it.

It has been a generally recognized principle that priority

* If the reader has been to school within the last twenty years, he will not probably have done at least a little to the calculus, and will thus gather the purport of the above paragraphs. Since an explanation of the development of principles would occupy more space than can be spared in this book, other readers may be referred to the author's *Craftsmanship in the Teaching of Mathematics*.

of discovery is decided by the date of publication, and not by the date of discovery in one's own study, or laboratory. Now there is no doubt at all that Newton had invented and actually used fluxions by 1666; there is documentary evidence to prove the fact, and the fact was also well-known to Newton's friends. But Newton did not trouble to publish it, and the subsequent trouble that arose was the result of that neglect.

Leibnitz visited London in 1673 and 1676, made the acquaintance of several eminent mathematicians, and was undoubtedly shown some of Newton's papers. Leibnitz afterwards admitted having seen the manuscripts, but he denied that what he had seen contained any part of the explanation of fluxions. He maintained later that he had invented the calculus in 1674, but his account was not published until 1684, though in his notebooks there were apparently traces of its use in 1675. No doubt Newton read Leibnitz's publication and decided that the time had come to publish an account of his own theory of fluxions. He accordingly included a summary in the *Principia* published in 1687, and a complete account of it was printed in 1693. Leibnitz's strong point was that he had published an account of the calculus before Newton had done so (which was true), and to the world he maintained that he himself was the inventor. But the prevailing view amongst mathematicians was that Newton had certainly been first in the field, and this seems to have rankled in Leibnitz's mind.

In a review of Newton's *Opticks* in 1704, Leibnitz offensively insinuated that Newton had been guilty of plagiarism—that Newton's fluxions was a thinly disguised copy of Leibnitz's own work. English mathematicians were furious, and the Royal Society undertook a special investigation, the result being that Newton was completely exonerated. The last years of Leibnitz's life were made very unhappy by a long controversy on the subject. It was no longer seriously maintained that Newton himself owed anything to Leibnitz. The question was, did Leibnitz invent the calculus independently, or did

he steal his ideas from Newton? It is at least highly probable that Leibnitz saw the all-important manuscript when he visited London.

I have read several books dealing in detail with the controversy, and my conclusion is that the case against Leibnitz is *not proven*. It is merely a case of strong suspicion. After all, Leibnitz was admittedly a great mathematician, and since he was as familiar as Newton with the work of such mathematicians as Cavalieri, Fermat, and others, he might well have made the same forward step as Newton did. Moreover, the invention of the calculus was not Newton's greatest work, not by a very long way. He was little more than a boy when he invented it, and he did it in a very short time. For one thing at least, credit must be given Leibnitz, and that is the *notation* of the calculus. Newton's fluxional notation has long since disappeared.

It would be foolish to deny Leibnitz's great reputation as a mathematician. It would be equally foolish to assert that Leibnitz was the equal of Newton. Here is a little story which will serve for purposes of comparison: The celebrated John Bernoulli challenged all the mathematicians of the world to solve two problems: (1) Given two points A and B such that the straight line joining them is neither horizontal nor vertical, to find how the curve joining them must be drawn, so that if a particle starts from the top end and falls along the curve under gravity it shall reach the lower end in the least possible time; (2) to find a curve such that if any line drawn from a fixed point O cut it in P and Q, then $OP^n + OQ^n$ would be constant. Leibnitz solved the first of these problems in rather *more than six months*, but failed to solve the second, and then suggested they should be sent as a challenge to Newton. Newton gave the complete solutions of both problems *the next day* after receiving them, and not only so but he generalized the second question. (The curve in the first problem is the brachistochrone.) An exactly similar case occurred in 1716 when Newton was asked to find the orthogonal trajectory of a family of curves. In five

hours Newton not only solved the problem but laid down the principles for finding trajectories.

Leibnitz was not an entirely ungenerous man. When the Queen of Prussia asked him his opinion of Sir Isaac Newton, he replied that Sir Isaac was responsible for much the better half of all the mathematics that had been done from the beginning of the world down to that time. He added that on certain very difficult points he had consulted all the leading mathematicians on the Continent, without getting any sort of help from them, but, as soon as he wrote to Sir Isaac Newton, he received complete answers the very next day.

Newton never married, though once there seems to have been a lady in the offing. Cruikshank's imaginary sketch of the courtship suggests that Newton found the problem a very knotty one. The sketch may be seen in the museum at Grantham.

In 1696 Newton was appointed Warden of the Mint, and three years later he was made Master. He resigned his Lucasian chair in 1701. In 1703 he was elected President of the Royal Society, an office which he held till his death twenty-four years later.

Newton's personal standard of morality was of the highest. "He had the whitest soul I ever knew," said Bishop Burnet. He was absolutely straightforward, honest, and just, but in controversy he was rather impatient and not always generous, and sometimes he took offence at a chance expression when no offence was intended. His genius was not fully appreciated until after his death. He was "a great experimentalist and manipulator, a profound mathematician and theorist, a clear and logical thinker, a fine writer."

Whewell, the famous Master of Trinity from 1841-66, said of Newton's work: "The great Newtonian Induction of Universal Gravitation is indisputably and incomparably the greatest scientific discovery ever made, whether we look

at the advance which it involved, the extent of the truth disclosed, or the fundamental and satisfactory nature of this truth."

Arago, the well-known French physicist spoke of Newton thus: "The efforts of the great philosopher were always superhuman; the questions which he did not solve were incapable of solution in his time."

Laplace, who ranks in the first half-dozen of the world's great mathematicians, said of Newton: "Newton was the greatest genius that ever existed, and the most fortunate, for we cannot find more than once a system of the world to establish."

Said the **Marquis de l'Hôpital**, an eminent French mathematician, "Does Mr. Newton eat, drink, sleep, like other men? I picture him to myself as a celestial genius, entirely removed from the restrictions of ordinary matter."

Pilgrims to Woolsthorpe Manor House, where Newton was born, will have seen the tablet, over the mantelpiece of the bedroom in which the birth took place, with **Pope's** famous epigram:

"Nature and Nature's laws lay hid in night.
God said, 'Let Newton be', and all was light."

Like all real thinkers he was overwhelmed by the immensity of knowledge and by the littleness of his own incomparable achievements. In a stately compliment to Hooke and Descartes, he finely wrote: "If I have seen further, it is by standing on the shoulders of giants."

At the end of his long life he said: "To myself I seem to have been only like a boy playing on the seashore and diverting myself in now and then finding a smoother pebble or a prettier shell than ordinary, while the great ocean truth lay all undiscovered before me." That is his own judgment of his life work and of the incomprehensible infinite that surrounds us. And he added: "New truths unfold themselves with the years; grander and ampler principles are revealed; but after each discovery the great ocean still stretches

out, illimitable in its immensities, until it seems to mingle with the heavens."

Newton was buried in Westminster Abbey, the actual grave being marked with a plain flagstone with the inscription:

"Hic depositum est Quod Mortale fuit Isaaci Newtoni."

Voltaire was present at the funeral. Four years later a monument, well-known to all Abbey visitors, was erected. The inscription closes thus:

"Naturae, antiquitatis, Sanctae Scripturae sedulus, sagax, fidus interpres, Dei O. M. majestatem philosophia asseruit; Evangelii simplicitatem moribus expressit. Tibi gratulentur mortales, tale tantumque exstitisse humani generis decus."

In the chapel of the great college whose chief glory is in Newton's fame, the inscription on his statue declares:

"Humanum genus ingenio superavit."

Mathematics after Newton.—In the early years of the eighteenth century, the English school of mathematics appeared vigorous and fruitful, but it became rather isolated, partly by its tendency to rely too exclusively on geometrical and fluxional methods; and mathematical supremacy soon passed over to the Continent. The leading members of the British school were Roger **Cotes** (1682–1716): he died at 34: "had Cotes lived, we might have learnt something," said Newton; David **Gregory** (1661–1708); Colin **Maclaurin** (1698–1746); Thomas **Simpson** (1710–61); and Brook **Taylor** (1685–1731). Abraham **Demoivre** (1667–1754) was a Frenchman who spent his later life in England; Pope said of him, "Sure as Demoivre, without rule or line"; Demoivre was chosen as arbitrator in the calculus dispute between Newton and Leibnitz. On the continent were such well-known workers as **Euler** (1707–83), the Swiss; and the four Frenchmen, **d'Alembert** (1717–83); **Lagrange** (1736–1813); Pierre Simon, Marquis de **Laplace** (1749–1827); and **Legendre** (1752–1833). The last three and

their followers formed a famous French school of mathematics in the eighteenth century.

The glamour of Newton must not mislead the reader into thinking that Britain is a nation of great mathematicians. We have generally had a few front-rank men of our own, but as a nation we have been completely outclassed by the Continental peoples, especially France, with Germany as a close second. Doubtless we may claim to possess many excellent national qualities, but unimpeachable logical reasoning is most emphatically not one of them. Let an English mathematician open up a subject in a circle of non-mathematical friends. How quickly they vote him a bore, and steal silently away!

(For portrait of Newton, see Frontispiece; for portrait of Leibnitz, see Plate 9).

BOOKS FOR REFERENCE:

1. *Life of Newton*, Brewster.
2. *Essays on the Life and Work of Newton*, P. E. B. Jourdain.
3. *Newton*, Professor D. E. Smith.
4. *Short History of Mathematics*, W. W. R. Ball.
5. *Sir Isaac Newton*, Professor Brodetsky.
6. *Isaac Newton*, ed. W. J. Greenstreet.
7. *Opticks*, Isaac Newton.
8. *Principia*, Isaac Newton (there are good English translations).
9. *Introduction des Théories de Newton en France avant 1738*, Professor Pierre Brunet.

CHAPTER XXVI

Locke

1632-1704

Against the churchyard wall in the village of Wrington at the foot of the Mendip Hills still stands the thatched cottage where in 1632 **John Locke** was born. Bacon had been dead six years and Shakespeare sixteen. The intellectual freshness of the great Elizabethan age still survived, as did also, indeed, especially on the Isis, a few musty remnants of scholastic philosophy.

Up to the age of fourteen, Locke was carefully schooled by his Puritan father, a typical rural tradesman of his day, prudent, self-reliant, pious, liberty-loving. In 1646 the boy was sent to Westminster School where he remained for six years. Though it has been suggested, it is very unlikely, that he was an eye-witness of the tragedy (the execution of Charles I) that took place in front of the palace at Whitehall on the memorable January morning of 1649; Westminster's Headmaster of the time, Dr. Busby, was far too stern a disciplinarian to allow his boys to be out on such an occasion. Locke's later judgment of the "verbal learning" that was "forced upon him at school" was severely critical.

In 1652 Locke passed on to Christ Church, Oxford. The Puritan revolution had not displaced, in Oxford any more than in Westminster, the "verbal exercises" inherited from the past, although in the lapse of time such exercises had degenerated into "childish sophistry". Locke spent no more time than he could help at "the disputations"; he

regarded the practice as one invented for "wrangling and ostentation rather than for discovering truth". He rebelled against empty verbal disputes, and his whole after life expressed his keen dislike of sophistry of any kind.

The head of Locke's College was John Owen who with Milton and Jeremy Taylor spent a good deal of time in vigorously defending the then unrecognized religious duty of toleration. This influenced Locke greatly.

The "new philosophy" of "free inquiry determined by experience" was then finding its way into Oxford, though through books rather than through college lectures. Aristotelianism was still strongly entrenched there, and Cambridge alone encouraged the new French philosophy of Cartesianism. But the works of both Descartes and Bacon were affecting leading minds in England, and Locke on obtaining copies of those of Descartes became greatly impressed with their logic and their lucidity. The works of Descartes were "the first books which gave him a relish for philosophical things". "The Englishman found the mind of the Frenchman like a revelation from heaven, and an inspiration of intellectual liberty."

Locke continued to live at Oxford after the Restoration, and he held various university appointments, but he did not take orders, for he not only disliked ecclesiastical impediments to free inquiry, but he was becoming increasingly interested in scientific research. The Royal Society had been recently founded (1660), and scientific inquiry was beginning to hold the first place in the minds of thinking men, who hitherto had been mainly interested in theological controversies. Mechanics, chemistry, and physiology were becoming much more interesting than the old tortuous questions of scholasticism.

Locke had become a serious student of chemistry in 1663, but his scientific inquiries mainly took the form of experiments in medicine, and by 1666 he was engaged in a sort of amateur medical practice. In 1668 he became a Fellow of the Royal Society, and almost at once he was made

a member of the committee "for considering and directing experiments".

A chance discussion with half a dozen friends at his house a year or two later led to Locke's turning from experimental science to philosophy. He gives an account of the incident in his Preface to his *Essay concerning the Human Understanding*. In the discussion, "difficulties arose on every side". "After we had puzzled ourselves, without coming any nearer a resolution of those doubts which perplexed us, it came into my thoughts that, before we set ourselves upon inquiries of that nature, it was necessary to examine our own abilities, and see what objects our understandings were or were not fitted to deal with. This I proposed to the company, who all readily assented."

Locke took the matter in hand at once, thinking it would be half an hour's work. Little did he dream that it would be the labour of years. The following seems to have been his original draft:

"Sic cogitavit de Intellectu humano Johannes Locke, anno 1671.

"Intellectus humanus cum cognitionis certitudine et assensus firmitate.

"First, I imagine that all knowledge is founded on and ultimately derives itself from *Sense*, or something analogous to it, and may be called *Sensation*; which is done by our senses (organs of sense) conversant about particular objects, and which gives us the simple ideas or images of things; and thus we come to have ideas of heat and light, hard and soft, which are nothing but the reviving again in our mind of the *imaginations* which these objects, when they affected our senses, caused in us—whether by motion or otherwise, it matters not here to consider—and thus we do observe, conceive (i.e. have ideas of) heat or light, yellow or blue, sweet or bitter; and therefore I think that those things which we call *sensible qualities* are the *simplest* ideas we have, and the *first* object of our understanding."

The philosophical enterprise in which Locke was thus

led to engage was undertaken in a spirit and by methods like those to which he had already become accustomed in natural science. He was therefore led to look at mental activity and human understanding as a *fact*—the supreme fact, it is true—to be approached like all other facts by careful observation and examination, and not in an *a priori* way. The enterprise was to be a plain matter-of-fact inquiry about man's mind, and to have the moral purpose of correcting certain common intellectual faults and fallacies.

Locke set out on his task, strongly opposed to the mediæval ideal of intellectual obedience to authority. He opened war upon all *a priori* abstract assumptions, and upon the use of all words void of meaning, even though these were protected under the claim that their meaning was "innate". Like Bacon he turned away from scholastic Aristotelianism because he saw in it not security for truth of fact but merely security for verbal consistency.

It must be borne in mind that the remarkable growth of observational and experimental science in England at this time was rapidly strengthening the disposition to bring every disputed belief before the tribunal of scientific reasoning and scientific method. Hence the philosophy natural to a representative thinker like Locke, who was disposed by temperament as well as by education and early environment to see the danger of all dogmatic claims to pre-eminence, was almost certain to be analytic and disintegrative. Locke's great aim was to expose empty verbalism, and to dissolve obstinate prejudices inherited from the past, prejudices which he assailed as "innate ideas". He wanted to explode all empty forms and dogmas that had usurped the place due to faithfully interpreted experience. He did not spare even Descartes and Bacon, pioneers as they were of free inquiry, because they had not completely freed themselves from the bondage of scholastic assumptions and abstractions.

Locke put his main question, thus: Whence comes the stock of knowledge of which I am now conscious? How has it entered into me? and how has it been built up? Of what

materials is it composed? Can I go back and examine, with any approach to probability, the process of building and growth? He affirmed that the mind was originally characterless, something like a sheet of paper not yet written on, or a photographic plate not yet exposed, and that at first it was entirely passive. Our life begins in sense. One after another, in lengthening series, sensations are experienced by us. We gradually learn to refer them to external objects, and to associate them with these objects as their causes. By degrees we learn to discriminate one sensation from another. We compare the results and we contrast the causes. "In time the mind comes to reflect on its own operations about the *ideas got by sensation*, and thereby stores itself with a new set of ideas, which I call *ideas of reflection*."

All the matter of our experience, says Locke, comes to us from without. Our knowledge is built up in us by a series of impressions. But we cannot understand those impressions, far less register them, without an active exercise of the understanding. We must bring to the knowledge, to the interpretation, to the registering, and to the storing, something which cannot have crept in by the doorway of sense. That something is the *mind*, which learns to become more and more active, to compare and contrast, to sort out, to reason. The mind becomes able to perceive a truth, "as the eye does light", by being directed by "intuition". The mind has an innate *power* to do these things, but it has no innate *ideas*. All the elements of its knowledge come from outside, but it has power to *reflect*, and all its contained ideas are either ideas of *sensation* or ideas of *reflection*.

Locke left much unexplained, and in spite of all the ingenuity of subsequent thinkers we are still profoundly ignorant of the precise nature of the so-called *a priori* element of our knowledge. Even the nature of perception is still uncertain, and hot disputes about it are still rife among psychologists.

Nevertheless Locke's main position is quite easy to understand; our ideas are derived from two sources: (1) ideas of

sensation derived from external objects through the senses; (2) ideas of reflection derived from ideas of sensation by means of an "internal sense" (as it might appropriately be called)—by the activity of the *mind*. He separated himself both from philosophers like Hobbes who believed that *all* our ideas are derived from sensations, and from philosophers who maintained that a part of human knowledge, and that the most important part, exists from the first, ready-made in our minds, innate, and prior to experience. It is quite true, however, that he does lay chief stress upon the then hitherto neglected factor, sense experience, as our chief means of obtaining knowledge; but to him that seemed necessary. Perhaps, therefore, he rather underrated the importance of the mental reaction which is essential to the formation of even the simple ideas of sensation.

Before trying to assess the value of Locke's philosophy, the reader should remember that ever since classical times there have been two opposed schools of philosophic thought. Each school has had its subdivisions, but the two main schools have always been antagonistic. Our ultimate interpretation of the universe necessarily depends upon the particular method by which our "faculties" are drawn forth into conscious exercise. When external observation, and the association and generalization of observed facts are allowed to take the lead, any kind of reflective thought and speculation being deliberately kept in check, then the prevalent philosophy naturally accepts the presuppositions of physical science, tends to repose in doubt, and may be tinged with agnosticism. On the other hand when reflective thought and speculation are given the rein and the sense faculties are left comparatively dormant, abstractions come to supersede concrete things, and the resulting philosophy becomes a web of subtle speculation spun out of the philosopher's own mind, *in* disregard of facts of experience which, if recognized, would destroy the unity of the system. The two types of philosophy may suitably be termed *Naturalism* and *Idealism*. But representatives of the latter school of thought sometimes apply

to the opposing school rather harsher terms than Naturalism: Empiricism, Sensationism, Materialism, Positivism, Agnosticism, and so forth. All these terms have really different connotations, but when philosophers throw stones at one another they do not examine them too closely. The philosophic term Idealism must not be confused with the popular term idealism used for connoting the pursuit of the ideal. A large number of terms in philosophy are ambiguous, because used with such varying connotations, none more so than Idealism, Realism, Rationalism, and Empiricism. In this book it will suffice to refer to the contrasted schools of philosophy as *Naturalism* and *Idealism*.

A philosophy to be acceptable should, of course, be complete. On this point Leibnitz, who leans to Idealism rather than to Naturalism, strikes an impartial note: "Those who give themselves up to the details of sense and to the natural sciences are led to despise abstract speculations and idealism, while those who habitually live among universal principles rarely care for or appreciate individual facts. But *I equally esteem both.*"

Bacon in a like spirit remarks: "Those who have handled knowledge have been too much either men of mere observation or abstract reasoners. The former are like the ant; they only collect material and put it to immediate use. The abstract reasoners are like spiders, who make cobwebs out of their own substance. But the bee takes a middle course; it gathers its material from the flowers of the garden and the field, while it transforms and digests what it gathers by a power not its own. Not unlike this is the work of the philosopher. For true philosophy relies not solely on the power of abstract thinking; nor does it take over the matter which it gathers from natural history and mechanical experiments, only to lay it up in the memory as it found it; for it lays it up altered and digested by the rational understanding. Therefore, from a better considered alliance between these two faculties, the empirical and the rational (hitherto never fully realized), much may be hoped for philosophy in the future."

Both Locke and Leibnitz were fairly representative of both sides of philosophy, but Locke's main sympathies were on the side of Naturalism and those of Leibnitz on the side of Idealism. It has been justly said that no philosopher since Aristotle has represented the spirit and opinions of an age so completely as Locke represented philosophy and all that depends upon philosophic thought, for more than a century following his death, especially in Britain and France. But some of his successors developed his main tenets in such a one-sided fashion that reaction was bound to come. Meanwhile the purely Idealistic side of the philosophy of Leibnitz had made a strong appeal to the naturally speculative minds of his countrymen the Germans, and the German soil was thus prepared for a system of all-explaining Idealism as worked out a little later by Kant and then by Hegel. Eventually German Idealism was transplanted by Coleridge to England, where for a considerable part of the nineteenth century Idealism held sway. But notwithstanding the natural disposition of the Teutonic mind to *a priori* philosophy and absolute Idealism, the influence of Locke even in the German universities was undoubtedly strong. Either directly or through Hume, Locke did much to shake the dogmatic confidence of Kant, whose *Kritik of Pure Reason* bears, in some of its main features, obvious marks of Locke's parentage.

The strong British reaction against Scholasticism in all its forms was bound to result in a philosophy of the Locke type. But the philosophy required could only be worked out with prospects of success by a man who had had a training in science, for only such a man would be likely to evaluate objective evidence justly. Locke proved to be the man. His distrust and rejection of all that could not be experimentally verified made him the very type of philosopher to be welcomed by thoughtful Englishmen. Although his analysis of the elements of consciousness could not be regarded as final, still he did bring back the mind of England from conjecture, airy hypotheses, and vague guesses, to bed-rock fact. That so clear and keen an English intellect was so honest in con-

fessing the limit of its own vision, that it proclaimed its dislike to all nebulous theories, that it banished "innate ideas" from the field of consciousness, all this was a tremendous gain both to philosophy and to science.

Of course Locke has had a host of critics, but that is the common lot of all philosophers. The great good that comes out of philosophy is that no philosophic system has ever been accepted as closed and final. A philosopher's criticism of a fellow philosopher's work should be warmly welcomed. About all philosophic systems there are bound to be different points of view. The only unforgivable criticism is the charge of stupidity. It has been said of Locke, for instance, that "he did not understand" the doctrine of innate ideas. Such a charge can only be described as childish.

"Few books have contributed more than Locke's *Essay* to rectify prejudice, to undermine established errors, to diffuse a just mode of thinking, to excite a fearless spirit of inquiry. The correction of intellectual faults is probably the greatest service which philosophy can render to science, and in this respect Locke is unrivalled. Locke's writings have also diffused throughout the civilized world the spirit of toleration and charity in religious differences; the disposition to reject whatever is obscure and fantastic in speculation; to reduce verbal disputes to their proper value; to abandon problems which admit of no solution; to distrust whatever cannot be clearly expressed; to make theory the simple expression of facts."

English people are not a philosophical people, neither do they hold philosophers greatly in esteem. It might, indeed, be plausibly argued that the value we attach to their teaching tends to diminish rather than to increase. No philosopher of the present day has the authority in this country that Herbert Spencer enjoyed forty years ago, though Spencer's authority waned as he grew in years and was never equal to that previously exercised by John Stuart Mill. Popular instinct nowadays places much greater confidence in science than in philosophy, distrusting not only the

weights and measures that philosophy uses but also the kind of proofs with which philosophy seems to be satisfied.

Popular instinct is justified to this extent, that certain well-known British philosophers do not express themselves lucidly: this does not refer so much to their technical terminology as to their English.* But the criticism certainly does not apply to Locke whose clarity of thought and lucidity of style are all the more convincing because so unpretending and so unadorned.

Locke studied and practised medicine and was one of the early Fellows of the Royal Society, and he deserves to be remembered in the annals of Science. He was a critical philosopher to whom, as already mentioned, even his famous successor Kant was greatly indebted. He was a politician, an economist, and a theologian; and he was an educationist who influenced English schools and teachers, both by his general philosophy and by his *Thoughts Concerning Education*, more profoundly and more permanently than any of his predecessors. He was one of the gentlest of sages, with something of the genius of the good physician—the genius of just diagnosis and sound, practical judgment. He also had the physician's kindness and gift for friendship: Shaftesbury and Sir Isaac Newton were among his great admirers and personal friends. Locke was no cloistered monk but a gifted man of the world who represented all that was best and most accomplished in the English lay mind. "He was one of the incarnations of the judgmental good sense of his country." His famous Essay will repay reading by all students of science, again and again.

Seven years after Locke died, David Hume was born in

* Or German. An old colleague of mine, Sir James Headlam, once told me that when after leaving Cambridge he became for a time a student in Germany, he had occasion to join some German students for the special study of *Kant*, but they read a French translation because it was so much clearer than the original German! Again, the late Lord Haldane when writing on philosophical subjects was sometimes unpardonably obscure (as, for instance, here and there in his *Reign of Relativity*), although it is said that his judgments as Lord Chancellor were models of lucidity. There is no excuse for obscurity in philosophic writings. The lucidity of French philosophers is universally recognised.

Edinburgh. When quite a young man Hume wrote his *Treatise of Human Nature*. In no small measure Hume accepted Locke's philosophy, and though he did not directly endorse it he traced what he considered to be its consequences, with the ultimate result that he landed himself in a general position of negativeness. "Nothing," he said, "can be more unphilosophical than to be positive or dogmatical on any subject. When men are most sure and arrogant, they are commonly most mistaken." All his critics call him a *sceptic*, and a doctrinaire sceptic at that, but Hume's scepticism was a scepticism of negation; he finally declined to speculate on ultimate problems, feeling that the entire region was one of haze. His arguments were not directed against the truths of religion—he was certainly not an irreligious man—but against metaphysical speculations. He insisted that we must be content to remain in darkness about the inner nature of essences and causes. The term "sceptic" in its unkind sense hardly applies to him; rather, the term "agnostic", in the literal sense, as intended by Huxley when he coined it, is much more applicable. "I don't know and you don't know" represents his general attitude, but when he goes on to suggest that "it is absolutely impossible to find out", his enemies promptly charge him with dogmatizing, the very fault he finds in them. But the core of Hume's philosophy is his doctrine of causation. The doctrine affects science very closely, and we refer to it in Chapter L.

(Portrait of Locke, Plate 8).

BOOKS FOR REFERENCE:

1. *An Essay concerning Human Understanding*, John Locke.
2. *Treatise of Human Nature*, David Hume.
3. *Inquiry concerning Human Understanding*, David Hume.
4. *Locke*, A. C. Fraser.
5. *Locke*, T. Fowler.
6. *Hume*, T. H. Huxley.
7. *Hume*, W. Knight.

CHAPTER XXVII

The Rise of the Academies, Institutions, and Societies

From time to time we have had occasion to refer to the Athenian "Academy", the Alexandrian "Museum", and the English "Royal Society", and some further reference to the origin and purpose of such Institutions may not be inappropriate.

A certain pleasure garden in a suburb of ancient Athens is supposed to have belonged to an Attic hero named *Academos* from whose name the Greek term "academy" (*ἀκαδημία*) is derived. The garden was walled in by Hipparchus and laid out ornamentally with attractive walks, groves, and fountains by Cimon, who on his death bequeathed it as a public pleasure-ground to his fellow-citizens of Athens. Plato who had a small estate in the neighbourhood used the garden a great deal, and here he taught for nearly fifty years. After his death his followers continued to make it their head-quarters.

The Academy lasted from the days of Plato to those of Cicero, that is, for over 300 years. During that time the Academic school of philosophy as founded by Plato was greatly modified; there was continuity of thought, it is true, but the identity of the original philosophy was almost lost as century succeeded century and head succeeded head. There was, in short, a change from the original dogmatism, which succeeding generations of scholars found more and more difficult to defend, to a mild form of scepticism, a

“probabilism”, an eclecticism compounded of almost equal sympathies with opposite schools of philosophic thought. This is the characteristic of Cicero’s philosophical writings. Cicero represents at once both the doctrine of the later Academy and the general attitude of Roman society when he says, “My words do not proclaim the truth, like a Pythian priestess, but I conjecture what is probable, like a plain man; and where, I ask, am I to search for anything more than verisimilitude?” And again: “The characteristic of the Academy is never to interpose one’s judgment, but to approve what seems most probable, to compare together different opinions, to see what may be advanced on either side, and to leave one’s listeners free to judge without pretending to dogmatize.”

In the modern acceptance of the term, “Academy” signifies a society or corporate body of learned men, established for the advancement of science, literature, or one or other of the arts. Modern academies almost always have some form of public recognition and are usually patronized by the head of the State. But the term is sometimes loosely used; it is, for instance, often attached to the public secondary schools in Scotland and Northern Ireland. It is correctly applied to the Royal Military School at Woolwich. Sometimes it is used, without any sort of authority, to give a fictitious dignity to some purely private concern; thus we hear of “dancing” academies.

The first academy, as thus formally defined, though it might with equal justice have claimed to be the first University, was the institution founded by the first Ptolemy at Alexandria (see p. 43). Ptolemy named it the *Museum*. For a long time it was the great teaching centre of the world, and the most eminent men of Greece and of the East flocked to it. Here the largest and most famous library of the ancient world was established. Later on, academies were founded by the Moors at Grenada and Corduba; one was also founded by Charlemagne at the suggestion of Alcuin (p. 94), and another by our own Alfred, at Oxford. The last was a grammar school

rather than a society of learned men, though it gave birth to the university.

Modern academies trace their lineage in direct descent from the troubadours of the early fourteenth century. The first Floral Games were held at Toulouse in 1325 at the summons of a guild of troubadours. Prizes of flowers of gold and silver were awarded to successful competitors. In 1694 the *Académie des Jeux Floraux* was constituted an academy by letters patent of Louis XIV. This academy still continues to award amaranths of gold and silver lilies for which there is keen competition. Prizes are given for the best ode, the best poem of 100 Alexandrian lines, the best prose composition, and the best elegy.

But if Provence thus led the way, it was in the Italy of the Renaissance where academies grew up and flourished. The Renaissance was indeed the era of academies, and as the Italians may be said to have discovered anew the buried world of literature, so it was in Italy that academies arose on all sides. The earliest of these was the *Platonic Academy*, founded in *c.* 1442 at Florence by Cosmo de' Medici, primarily for the study of the works of Plato but also for the study of Dante and other Italian writers. Machiavelli and other famous Italians were among its members.

With the doubtful exception of the Royal Academy of Arts, England has no Academies in the proper sense of the word, but she has a large number of highly important institutions corresponding, more or less closely, to the Italian Academies. The broad distinction is this: an *Academy* generally receives State support and patronage; a *Society* has been founded and is carried on by private collective effort. Large numbers of private scientific societies have been founded since the beginning of the nineteenth century, men of science having felt the necessity both of providing means for increased organization of knowledge and of providing a head-quarters for meeting, for comparing results, and for collecting facts for future generations. Every branch of science and every professional body of standing now has

one or more societies or associations, not a few of them of great reputation. The "Proceedings" of most of the learned societies are of permanent interest and great importance. Of course there are camp-followers, especially in medicine; even corn-extractors (they call themselves cheiropodists) gravely claim to belong to a "profession".

Academies and Societies of different kinds exist in every civilized country in the world, and many of those in the countries of western and southern Europe and of America are famous. Space permits a reference to only a very small number here.

The Royal Society or, more fully, *The Royal Society of London for Improving Natural Knowledge*, is the oldest and most exclusive scientific society in Great Britain and one of the oldest in Europe. It is usually considered to have been founded in 1660, but a nucleus had in fact been in existence for some years previously. Wallis tells us that as early as 1645 weekly meetings were held of "divers worthy persons, inquisitive into natural philosophy, and other parts of human learning, and particularly of what hath been called the *New Philosophy* or *Experimental Philosophy*," and there can be little doubt that this gathering of men of science is identical with the "Invisible College" of which Boyle speaks in various letters written in 1646 and 1647. These meetings were generally, but not always, held at Gresham College. The Charter of Incorporation granted by Charles II (who took a strong personal interest in the movement) was sealed in 1662, and the Council of the Society met for the first time on 13th May, 1663. Newton was elected Fellow in 1671 and became President in 1703, an office which he held till his death in 1727. The Society after "moving house" two or three times settled down in 1857 at Burlington House which still remains its head-quarters.

From 1780 onwards, admission to the Society was limited to men of exceptional distinction, and since 1847 the number of candidates annually recommended for election by the Council has been limited to fifteen, though quite recently this

has been increased to seventeen. Concurrently, however, with the gradual restriction of the Society's numbers was the establishment, one after another, of other scientific bodies. The founding of the *Linnean Society* in 1788 under the auspices of several Fellows of the Royal Society was the first instance of the establishment of a distinct scientific association under Royal Charter. The *Geological Society* followed in 1807, and the *Royal Astronomical Society* in 1820. The *Royal Geographical Society* followed in 1830, and the *Chemical Society* in 1841. During the last hundred years numerous other societies have been established.

University distinctions, no matter how high, are no sure passport to Fellowship of the Royal Society. A would-be Fellow has no chance of election unless he has done "original work and plenty of it"—work which will be readily recognized by the Society as a very serious and substantial contribution to some branch of science. The Fellowship is universally recognized as a hail-mark of great distinction.

The British Academy is a society which was incorporated by Royal Charter as recently as 1902. Its objects are defined to be "the promotion of the study of the moral and political sciences, including history, philosophy, law, politics, and economics, archæology and philology". The number of ordinary Fellows is restricted to 100. In prestige it already ranks with the Royal Society. It is closely associated with the *Union Académique Internationale*.

The Royal Academy of Arts in London was founded in 1768 "for the purpose of cultivating and improving the Arts of Painting, Sculpture, and Architecture". It consists of forty Academicians and thirty Associates—painters, sculptors, or architects.

Of the many hundreds of foreign academies and societies, not a few of them as distinguished as those of our own, space permits of reference to only one, *The French Academy*. It is perhaps the most widely known and the most discussed of all such institutions.

Concerning the French Academy we may first give the

opinion of an Englishman, Matthew **Arnold** (from his *Essay on the Literary Influence of Academies*): "An institution like the French Academy—an institution owing its existence to a national bent towards the things of the mind, towards culture, towards clearness, correctness, and propriety in thinking and speaking—sets standards in a number of directions, and creates, in all these directions, a force of educated opinion, checking and rebuking those who fall below these standards or who set them at naught . . . a sovereign organ of the highest literary opinion, a recognized authority in matters of intellectual tone and taste."

Secondly, we may give the opinion of a Frenchman, M. **Lanfrey** (from his *History of Napoleon*): "The French Academy seems to have received from its founders the special mission to transform genius into *bel esprit*. If we examine its influence on the national genius, we shall see that it has given it a flexibility, a brilliancy, a polish, which it never possessed before, but it has done so at the expense of its masculine qualities, its originality, its spontaneity, its vigour, its natural grace. It has disciplined it, but it has impoverished it. It sees in taste, not a sense of the beautiful, but a certain type of correctness, an elegant form of mediocrity. It has substituted pomp for grandeur, school routine for individual inspiration. In the works produced under its auspices, we discover the rhetorician and the writer, never the man."

Doubtless the French Academy, like most other Academies, tends to be conservative rather than creative; to be suspicious of originality and therefore to hamper and perhaps to crush it; to make rules and to impose them rigidly. But the French Academy has done at least one good thing—it has kept out of the French language the type of barbarism which is constantly forcing its way into our own. In England any tradesman is at liberty to invent any word-monstrosity he likes in order to describe his wares, and to flaunt it on every advertising hoarding in the country. There is no authority to say him nay.

Lanfrey's opinion of the French Academy is admittedly

severe, but then nearly all academies are criticized in much the same way. Those who are kept out are jealous of those who get in. In the world of learning, jealousy is unfortunately a petty vice by no means unknown, and disappointment often vents itself in spleen.

In Britain there have been recent important developments in connexion with professional associations, but in some professions the condition of professional "status" is still far from being satisfactorily defined. The medical profession probably stands first: the General Medical Council and the British Medical Association have apparently taken the most satisfactory steps in matters of qualification, status, and discipline. For a general survey of the present position of the professions, the reader may be referred to the first book named below.

BOOKS FOR REFERENCE :

1. *The Professions*, Professor A. M. Carr Saunders and P. A. Wilson.
2. *Whitaker's Almanack*.

CHAPTER XXVIII

The Beginning of Rational Medicine and Surgery.

William Harvey and his Contemporaries

VESALIUS, 1514-64.

SERVETUS, 1509-53.

COLUMBUS, 1516-59.

FABRICIUS, 1537-1619.

CLOWES, 1540-1604.

HARVEY, 1578-1657.

SYDENHAM, 1624-89.

WREN, 1632-1723.

KIRCHER, 1602-80.

LEEUVENHOEK, 1632-1723.

MALPIGHI, 1628-94.

We must return for a short time to the sixteenth century. When Galileo was at the University of Padua (see p. 155), a Cambridge medical student, **William Harvey**, was also there, attending lectures on anatomy and surgery under the celebrated **Fabricius**. Harvey's own later work was destined to effect a world-wide revolution in the practice of medicine and surgery.

The great artists of the pre-Vesalian period paid great attention to anatomy, especially **Leonardo da Vinci** and **Albrecht Dürer**. Leonardo believed that the scientific knowledge of anatomy so essential to an artist could be gained only at the dissecting table, and that a mere study of the human body externally was altogether insufficient. His 750 sketches of the bones, of the muscles, of the internal organs, and of dissections of all kinds, are all startlingly accurate in their delineation. But for teaching purposes dissecting was still hampered by the theological idea of the sanctity of the human body, and the anatomy of the medical

schools was still largely the anatomy of Galen. The first man to release his profession from the written authority of Galen was **Vesalius** (1514-64), the most commanding figure in medicine between Galen and Harvey. It was Vesalius who made anatomy what it is to-day—a living, experimental science. By nature blunt and independent, he was the last man to feed upon the dust of ages, and he soon established a European reputation for first-hand knowledge of the dissected human body. His work at Padua culminated in the production of his great work, *De Fabrica Humani Corporis*, which definitely threw overboard the traditions of Galen. Its language is scornful and almost violent in the treatment of Galenic and other superstitions. But he lived in dangerous times, and his distinguished contemporary **Servetus** (1509-53), who discovered that “the blood in the pulmonary circulation passes into the heart after having been mixed with air in the lungs”, was, by the influence of Calvin, burnt at the stake for an expression of heterodox theological views. Another contemporary of Vesalius was Matteo Rualdo Colombo (1516-59), usually called **Columbus**, who claimed to have discovered the pulmonary circulation, but his book did not appear until after the death of Servetus, with whose work he must have been well acquainted. A distinguished pupil of Vesalius was **Fallopium**, one of whose own pupils **Fabricius** (1537-1619) became Harvey's instructor at Padua, and he built at his own expense a fine lecture theatre for demonstrations in anatomy.

The greatest English surgeon during the reign of Queen Elizabeth is said to have been **William Clowes** (1540-1604). From his caustic pen we learn much about the medical practice of the period.

Medical practice during the Renaissance was bound up with superstition and quackery. The practising physician usually believed in astrology, and referred to the planets for the proper time for purging and blood-letting. Only the few surgeons of first rank were true surgeons. In the words of Clowes, the unclassed horde of wandering cataract-couchers, lithotomists, and booth-surgeons were little better than runa-

gates and vagabonds, shameless in countenance, brutish in judgment and understanding. Quackery was rampant everywhere, and was practised by "tinkers, tooth-drawers, peddlers, ostlers, carters, horse-leeches, witches, conjurors, sooth-sayers, and rat-catchers."

With the dawn of the seventeenth century, things began to change rapidly. It was the century of Shakespeare and Newton, of Bacon and Descartes, of Locke and Leibnitz. The very beginning of the century is memorable for the appearance of an epoch-making work in the history of physics, the *De Magnete* of **William Gilbert** (1540-1603), who was physician to Queen Elizabeth. But by far the greatest name in seventeenth century medicine is that of **William Harvey** (1578-1657), whose professional work forms the main subject of this chapter. His work has probably exercised a profounder influence upon modern medicine than that of any other man, with the possible exception of Vesalius.

A Kentish boy, Harvey went to the King's School, Canterbury, passed on to Caius College, Cambridge, and took an Arts degree (he took the M.D. degree later), then travelled in France and Germany and finally in Italy where he was to study those branches of science which are akin to medicine as well as medicine itself. The great north Italian universities of Padua, Pisa, Parvia, and Bologna were then at the height of their renown, especially in mathematics, law, and medicine. Harvey attached himself to Padua, celebrated for its anatomy school, which had been rendered famous both by Vesalius and by his successor Fabricius. Dr. Caius of Caius College, Cambridge, had lectured on Greek in Padua, and there was perhaps therefore at least a sentimental connexion between his college and the Italian university, but it was probably the fame of Fabricius that was the main inducement to Harvey to make Padua his training ground. In due course he returned to England, took his medical degree, and entered upon his professional career. In 1607 he was elected Fellow of the Royal College of Physicians, in 1609 he was made physician at St. Bartholomew's Hospital, and in 1615

he became Lumleian lecturer at the College of Physicians. He delivered his first anatomy lecture in 1616, and year by year his fame as a lecturer increased. He directed special attention to the heart and the movement of the blood, and in 1628 he published his famous essay, *Exercitatio de motu cordis et sanguinis*. Though occupying less than 100 pages of ordinary printed matter, it is one of the great classics of scientific method, and takes rank with Newton's *Opticks* and Faraday's *Researches*. It shows a complete breakaway from the bonds of classical traditions, it reveals the master-hand of a highly skilful and independent investigator, and it established new facts that entirely relaid the foundations of the theory and practice of medicine.

The arguments of the Essay are so lucid that the reader will be able to follow them readily, provided he is acquainted with a few of the known fundamental facts about the heart and the circulation. If he could induce a biological friend to spare a quarter of an hour to chloroform a frog and lay bare the heart and chief blood-vessels (the frog is a delightfully clean little animal, whose heart continues to beat a considerable time after death), he would be able to follow the arguments still more closely. A sheep's heart from the butcher's might also be examined: it differs scarcely at all from the human heart.

The elementary facts about the heart and the circulation are as follows:

The heart is a four-chambered muscular *pump*, beautifully fitted with valves to compel a one-way flow of the blood. Blood flows in from the various parts of the body by means of thin walled *veins* and is then pumped out into thick-walled elastic *arteries* by which it is again distributed over the body. Fig. 54 gives some idea of the complex nature of the circulatory system generally. To the novice even the heart itself seems a very complex thing, and some little difficulty is likely to be experienced in identifying its various parts and the blood-vessels which enter and leave them. Fig. 55 will help to make things clear.

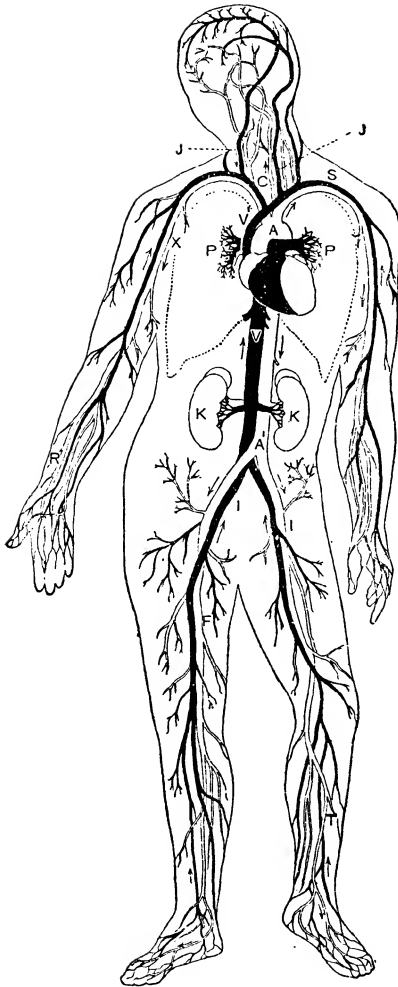

- J, J, Jugular veins.
 C, Carotid artery.
 S, Subclavian artery.
 A, Aorta.
 P, P, Pulmonary Capillaries (greatly magnified) between the pulmonary artery and pulmonary veins.
 V¹, Superior vena cava.
 V, Inferior vena cava.
 K, K, Kidneys.
 A', Point at which aorta branches into the two iliac arteries (I, I), one going to each leg.
 R, Radical artery and veins.
 F, Femoral arteries.
 T, Tibial Artery.
 X, Auxiliary artery (under armpit).

Diagram to illustrate the Circulation of the Blood

Veins in black; arteries in double lines. The direction of flow from and to the heart is indicated by arrows.

Fig. 54

The upper chambers of the heart, left and right, receiving blood from the veins are the *auricles*; the lower chambers, left and right, driving blood into the arteries are the *ven-*

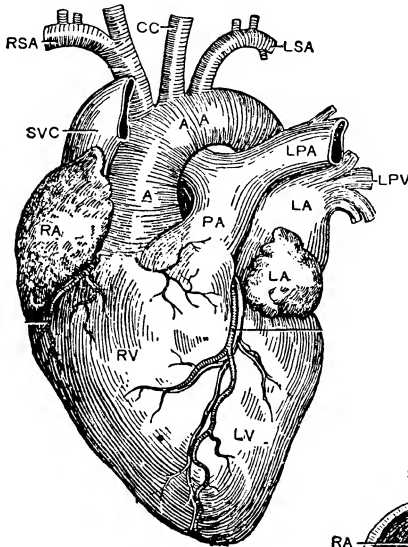

The Heart

A, Aorta. AA, Aortic Arch. RA, Right auricle. LA, Left auricle. RV, Right Ventricle. LV, Left ventricle. PA, Pulmonary artery. LPA, Left Pulmonary Artery. LPV, Left pulmonary vein. SVC, Superior vena cava. RSA, Right subclavian artery. LSA, Left subclavian artery. CC, Carotid Arteries.

The Heart opened to show its Chambers

RV, Right ventricle. LV, Left ventricle. RA, Right auricle. LA, Left auricle. SVC, Superior vena cava. PV, Orifices of pulmonary veins. IVC, Orifice of inferior vena cava. A, Aorta. PA, Pulmonary artery. MV, Mitral valve. TV, Tricuspid valve.

If a sheep's heart is bisected, all the parts may be plainly seen.

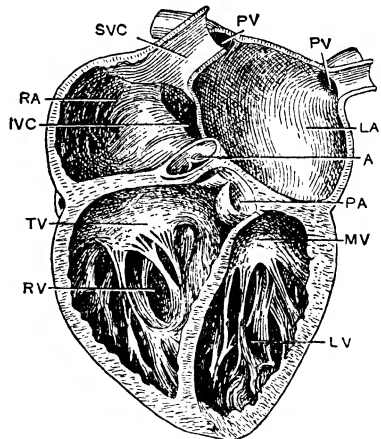

Fig. 55

tricles. Valves permit blood to pass from the auricles to the ventricles but not from the ventricles to the auricles. The principal artery of the body is the *aorta* which has its origin

in the left ventricle; it divides and subdivides, and distributes blood to the whole body except the lungs. The next important artery of the body is the *pulmonary artery*, which has its origin in the right ventricle and takes blood to the lungs. At the root of both the aorta and of the pulmonary artery are valves permitting a forward but preventing a backward flow. The arteries continue to subdivide until they are lost in a maze of very fine hair-like tubes called *capillaries*, which are to be found in every part of the body and are from $1/500$ to $1/3000$ of an inch in diameter. No matter where the skin is pricked, blood flows out from the local capillaries. Every capillary network forms an *anastomosis* or intercommunication between the arteries and the veins. The capillaries unite together to form small veins, and these unite to form larger and larger veins, until eventually the *venæ cavæ*, carrying back the blood from the whole body except the lungs, discharge into the right auricle, and the *pulmonary veins* from the lungs discharge into the left auricle. During its passage from the pulmonary artery through the lungs to the pulmonary vein, the blood is oxygenated. (There are two *venæ cavæ* and four pulmonary veins in man. In the sheep there are only two pulmonary veins.)

The valves in the sheep's heart may be examined, and if the butcher has left a sufficient length of each of the main blood-vessels, the valves may be tested with running water. In the left side of the heart, the *mitral* valve between the auricle and ventricle consists of two flaps of skin, and in the right side the *tricuspid* valve consists of three such flaps, all held in position by stretched strings. The *semilunar* valves at the base of the aorta and of the pulmonary artery are pouch-like in character.

A *beat* of the heart is a contraction of the walls of the auricles and the ventricles. The left and right sides of the heart are completely separated by the medial *septum*; nevertheless the two auricles contract at the same time and then immediately afterwards the two ventricles contract at the same time; then there is a pause with relaxation of both

auricles and ventricles. The two septum-separated halves of the heart work together.

When the auricles are full, they begin to contract just round the openings of the big veins discharging into them; the thin walls of these veins are easily squeezed together. The contraction then runs over the whole of the auricles towards the openings into the ventricles, into which the blood is therefore forced. Thus filled with blood, the ventricles in their turn at once begin to contract. This contraction closes the valves between the auricles and ventricles, and the pressure thus causes the semilunar valves to open and admit the blood into the big arteries (aorta and pulmonary artery). But the arteries being already full of blood are compelled to stretch. Two things now happen: the back pressure closes the semilunar valves, the forward pressure drives the blood onward. A new wave is therefore driven through all the elastic arteries of the body, onwards to the capillaries. The route via the lungs is short; the work to be done is relatively little. The other route is much longer, for it applies to the whole body, and heavy work having to be done, the left ventricle is thick and strong, far thicker and stronger than the right. The circulation is thus seen to be of a twofold character: (1) the *pulmonary* circulation through the lungs; (2) the main or *systemic* circulation through the main part of the body. In the latter, each new forward wave is easily felt when the artery is near the surface, as at the wrist.

The experiment of introducing into a main vein a chemical substance the presence of which in the blood is easily recognized shows that the blood circulates once completely round the system in about *half a minute*. By far the greater portion of this time is taken up by the passage through the capillaries. Through the aorta the blood flows at the rate of 15 or 18 in. a second, but through the capillaries only a small fraction of an inch in that time. With each branching of the arteries the total area of the arterial system is increased, and the total width of the capillary tubes put together side by side is much

greater than that of the aorta. Naturally, therefore, the blood flows more slowly as it passes into wider and wider channels, just as a river flows more slowly when it widens out into a lake. The resistance caused by the friction in the capillaries is, of course, thrown back on the aorta.

The flow of the blood may be observed in a transparent living membrane under the microscope. A suitable object is a tadpole, which will keep quiet if his body is wrapped up in a bit of wet cotton wool and laid on a glass slide, his transparent tail being exposed. The corpuscles moving with the flowing blood are readily observed as they squeeze their way onwards through their tiny tubular channels.

We may now return to Harvey.

When Harvey took up the subject of the circulation, all sorts of fantastic views were held about the functions of the heart and blood-vessels. Here are a few: (1) the heart was a workshop for manufacturing the "spirits" necessary for many parts of the body; (2) the arteries contained blood and air mixed together, or only air (literally the word *artery* signifies an *air-tube*); (3) the heart conducted "fuliginous vapours" along the blood-vessels; (4) the septum dividing the heart was a fine sieve through which the blood percolated from the right to the left side; (5) the blood moved in the blood-vessels but backwards and forwards, tide-like, along the same channels; (6) the arteries terminated in nerves (this last was the authoritative opinion then prevalent).

And yet a great deal of accurate knowledge of the anatomy of the body was available at the time. Vesalius's own knowledge was profound, and it is surprising that he did not forestall Harvey in the matter of the circulation. As to the lesser or Pulmonary circulation, it was certainly known to Servetus, and probably to Columbus, though neither of them had any notion of the greater or Systemic circulation. And it seems to be certain that none of Harvey's predecessors realized that in the pulmonary circulation the whole mass of the blood was continually passing through the lungs.

The following extracts* from Harvey's *Essay* will enable the reader to follow up the investigation fairly readily. But the whole *Essay* should be read: it is easily followed.

From the Introduction.—Almost all anatomists and physicians up to the present time have supposed, with Galen, that the object of the pulse was the same as that of respiration. It is affirmed, as by Fabricius in his book on "Respiration", that as the pulsation of the heart and arteries does not suffice for the ventilation and refrigeration of the blood, therefore were the lungs fashioned to surround the heart. But as the structure and movements of the heart differ from those of the lungs, and the motions of the arteries from those of the chest, so it seems likely that the pulsations and uses of the heart, likewise of the arteries, will differ in many respects from the heavings and uses of the chest and lungs.

When the windpipe is divided, it is sufficiently obvious that the air enters and returns through the wound by two opposite movements; but when an artery is divided, it is equally manifest that blood escapes in one continuous stream, and that no air either enters or issues.

That it is blood and blood alone which is contained in the arteries is made manifest by experiment; from a single artery divided, the whole of the blood (of the body) may be withdrawn in half an hour or less. If you include a portion of an artery between two ligatures, and split it open lengthways, you will find nothing but blood; and thus the arteries contain blood only. If we find the same blood in the arteries as we find in the veins, which we have tied in the same way, as I have myself repeatedly ascertained, we may fairly conclude that the arteries contain the same blood as the veins, and nothing but the same blood.

The blood escaping from the arteries escapes with force, now farther, now not so far, alternately, or in jets; and the jet always takes place with the diastole of the artery, never

* Occasionally words that are not necessary to the argument are omitted. Also a correction is occasionally made; for instance, Harvey sometimes says "heart" for "ventricle".

with the systole.* By which it clearly appears that the artery is dilated by the impulse of the blood.

When we see that the structure of both ventricles is almost identical, there being the same apparatus of fibres, and braces, and valves, and vessels, and auricles, why should their uses be imagined to be different, when the action, motion, and pulse of both are the same?

If anyone performed Galen's experiment of dividing the trachea of a living dog, forcibly distending the lungs with a pair of bellows, and then tying the trachea securely, he would find, when he laid open the thorax, abundance of air in the lungs, but none in either the pulmonary veins, or left ventricle of the heart. But did the heart either attract air from the lungs, or did the lungs transmit any air to the heart, in the living dog, by so much the more ought this to be the case in the experiment just referred to.

Still less is that opinion to be tolerated which supposes the blood to ooze through the septum of the heart from the right to the left ventricle by certain secret pores, and the air to be attracted from the lungs through the pulmonary vein. No such pores can be demonstrated. The septum of the heart is of a denser structure than any portion of the body, except the bones and sinews. But even supposing that there were pores in this situation, how could one of the ventricles extract anything from the other, when we see that both ventricles contract and dilate simultaneously?

Since therefore it is plain that what has heretofore been said concerning the motion and function of the heart and arteries must appear obscure, it will be proper to investigate and endeavour to find the truth.

From Chapter I.—When I first gave my mind to a means of discovering the motions and uses of the heart, and sought to discover these from actual inspection and not from the writings of others, I found the task full of difficulties. For I could neither rightly perceive at first when the systole and

* The "systole" refers to the period of *contraction*; the "diastole" refers to the period of relaxation, or pause, or *dilation* recovery.

when the diastole took place, nor when and where dilation and contraction occurred, by reason of the rapidity of the motion which in many animals is accomplished in the twinkling of an eye. My mind was therefore greatly unsettled. At length, by using greater and daily diligence, and collating numerous observations, I thought I had attained to the truth.

From Chapter II.—When the chest of a living animal is laid open, the heart is seen now to move, now to be at rest; there is a time when it moves and a time when it is motionless.

These things are more obvious in the colder animals, such as frogs and serpents. They also become more distinct in warm-blooded animals such as the dog, if they are attentively noted when the heart begins to flag; the movements then become slower and rarer, the pauses longer, by which it is made much more easy to perceive and unravel what the motions are, and how they are performed. In the pause the heart is soft, flaccid, exhausted, at rest.

In the motion, and interval in which this is accomplished, four principal circumstances are to be noted:

1. That the heart is erected, and rises upwards to a point, so that at this time it strikes against the breast and the pulse is felt externally.

2. That it is everywhere contracted, but more especially towards the sides, so that it looks narrower, relatively longer, more drawn together.

3. The heart being grasped in the hand, is felt to become harder during its action. Now this hardness proceeds from tension, precisely as, when the forearm is grasped, its tendons are perceived to become tense and resilient when the fingers are moved.

4. In cold-blooded animals such as frogs and serpents it may further be observed that the heart when it moves becomes of a paler colour, when quiescent of a deeper blood-red colour.

From these particulars it appears evident that the motion of the heart consists in a certain universal tension—both contraction in the line of the fibres, and constriction in every

sense. It becomes erect, hard, and of diminished size during its action; the motion is plainly of the same nature as that of the muscles when they contract in the line of their sinews and fibres.

We are therefore authorized to conclude that the heart, at the moment of its action, is at once constricted on all sides, rendered thicker in its parietes (walls) and smaller in its chambers, and so made apt to project or expel its charge of blood. This is made manifest by the fourth observation, in which we have seen that the heart, by squeezing out the blood it contains, becomes paler, and that when it sinks into repose and the ventricles are filled anew, the deeper crimson colour returns. But no one need remain in doubt of the fact, for, if a ventricle be pierced, the blood will be seen to be forcibly projected outwards upon each motion or pulsation when the heart is tense.

From Chapter III.—These things are further to be observed:

1. At the moment the left ventricle contracts, and when the breast is struck, when in short the organ is in its state of systole, the arteries are dilated, yield a pulse, and are in the state of diastole. In like manner, when the right ventricle contracts and propels its charge of blood, the pulmonary artery is distended at the same time with the other arteries of the body.

2. When the left ventricle ceases to act, to contract, to pulsate, the pulse in the arteries also ceases; further, when this ventricle contracts, languidly, the pulse in the arteries is scarcely perceptible. In like manner, the pulse in the right ventricle failing, the pulse in the pulmonary artery ceases also.

3. Further, when an artery is divided or punctured, the blood is seen to be forcibly propelled from the wound at the moment the left ventricle contracts; and, again, when the pulmonary artery is wounded, the blood will be seen spouting forth with violence at the instant when the right ventricle contracts.

From these facts it is manifest, in opposition to commonly received opinions, that the diastole of the arteries corresponds with the time of the heart's systole; and that the arteries are filled and distended by the blood forced into them by the contraction of the ventricles. It is in virtue of one and the same cause, therefore, that all the arteries of the body pulsate, viz. the contraction of the left ventricle; in the same way as the pulmonary artery pulsates by the contraction of the right ventricle.

From Chapter IV.—With all deference to authority I say that there are four motions distinct in point of place, but not of time; for the two auricles move together, and so also do the two ventricles, in such wise that though the places be four, the times are only two. The manner is as follows:

There are, as it were, two motions going on together: one of the auricles, another of the ventricles; those by no means taking place simultaneously, but the motion of the auricles preceding, that of the ventricles following; the motion appearing to begin from the auricles and to extend to the ventricles. When all things are becoming languid, and the heart is dying, there is a short pause between these two motions. At length, and when near to death, the ventricles cease to respond by their proper motion, and cease to pulsate sooner than the auricles, so that the auricles have been said to outlive them.

But this especially is to be noted, that after the ventricles have ceased to beat, the auricles however still contracting, a finger placed upon the ventricles perceives the several pulsations of the auricles. And if at this time, the auricles alone pulsating, the point of the heart be cut off with a pair of scissors, you will perceive the blood flowing out upon each contraction of the auricles. Whence it is manifest how the blood enters the ventricles, thrown into them by the pulses of the auricles.

Whenever I speak of pulsations as occurring in the auricles or ventricles, I mean contractions: first the auricles *contract*, and then and subsequently the ventricles *contract*.

From Chapter V.—From these and observations of a like kind, I am persuaded that the motion of the heart is as follows:

First of all, the auricles contract, and in the course of their contraction they throw the blood (which they as the head of the veins contain in ample quantity) into the ventricles, which, being filled, the heart raises itself straightway, makes all its fibres tense, contracts the ventricles, and performs a beat, by which beat the ventricles immediately send into the arteries the blood received from the auricles; the right ventricle sending its charge into the lungs by the pulmonary artery, the left ventricle sending its charge into the aorta and through this by the arteries to the body at large.

These two motions, one of the ventricles, another of the auricles, take place consecutively, but in such a manner that there is a kind of harmony or rhythm preserved between them, the two concurring in such wise that but one motion is apparent, especially in the warmer blooded animals. Nor is this by any other reason than it is in a piece of machinery, in which, though one wheel gives motion to another, yet all the wheels seem to move simultaneously; or in that mechanical contrivance which is adapted to firearms, where the trigger being touched, down comes the flint, strikes against the steel, elicits a spark, which falling among the powder, it is ignited, upon which the flame extends, enters the barrel, causes the explosion, propels the ball, and the mark is attained—all of which incidents, by reason of the celerity with which they happen, seem to take place in the twinkling of an eye.

The one action of the heart is the transmission of the blood and its distribution, by means of the arteries, to the very extremities of the body; so that the pulse which we feel in the arteries is nothing more than the impulse of blood derived from the heart.

The grand cause of hesitation and error in this subject appears to me to have been the intimate connexion between the heart and the lungs. When men saw both the pulmonary artery and the pulmonary veins losing themselves in the

lungs, of course it became a puzzle to them to know how or by what means the right ventricle should distribute the blood to the body or the left draw it from the *venæ cavæ*.

The father of physic, Galen, allows "that all the arteries of the body arise from the aorta and that the aorta takes its origin from the heart; that all these vessels naturally contain and carry blood; that the three semilunar valves situated at the orifice of the aorta prevent the return of the blood into the heart, and that nature never connected them with this unless for some most important end." If Galen admits these things, and I have quoted his own words, how could he fail to see that the aorta is the very vessel to carry the blood from the heart for distribution to all parts of the body? Or did he perchance hesitate, like all who have come after him, because he could not perceive the *route* by which the blood was transferred from the arteries to the veins, in consequence of the intimate connexion between the heart and the lungs?

From Chapter VII.—There are three semilunar valves situated at the orifice of the pulmonary artery, which effectually prevent the blood sent into the vessel from returning into the cavity of the heart. Explaining the uses of these valves, Galen said (*De Usu partium*, vi, 10):

"There is everywhere a mutual anastomosis of the arteries with the veins, and they severally transmit blood by certain invisible and undoubtedly very narrow passages. Now if the mouth of the pulmonary artery had stood in like manner continually open, and nature had found no contrivance for closing it when requisite, and opening it again, it would have been impossible that the blood could ever have passed by the invisible and delicate mouths, during the contractions of the thorax; anything is drawn more rapidly along an ample conduit, and again driven forth, than it is through a narrow tube. But when the thorax is contracted, the pulmonary veins, which are in the lungs, being driven inwardly, and powerfully compressed on every side, immediately assume a certain portion of blood by those subtile

mouths; a thing that could never come to pass were the blood at liberty to flow back into the heart through the great orifice of the pulmonary artery. But its return through this great opening being prevented, when it is compressed on every side, a certain portion of it makes its way into the pulmonary veins by the minute orifices mentioned."

This argument Galen adduces for the transit of the blood from the vena cava, by the right ventricle into the lungs; but we can use it with still greater propriety, merely changing the terms, for the passage of *the blood from the pulmonary veins through the left ventricle into the aorta and arteries.*

From Chapter VIII.—When I surveyed my mass of evidence, whether derived from vivisections and my various reflections on them, or from the ventricles of the heart and the vessels that enter into and issue from them, or from the arrangement and intimate structure of the valves in particular and of the other parts of the heart in general, I frequently revolved in my mind what might be the *quantity* of blood that was transmitted, in how short a time its passage might be effected, and the like. And not finding it possible that this could be supplied by the juices of the ingested aliment without the veins on the one hand becoming drained, and the arteries on the other getting ruptured through the excessive charge of blood, unless the blood should somehow find its way from the arteries into the veins, and so return to the right side of the heart; I began to think whether there might not be *a motion in a circle*, as it were. Now this I afterwards found to be true; and I finally saw that the blood forced by the action of the left ventricle into the arteries, was distributed to the body at large, in the same moment as it is sent through the lungs, impelled by the right ventricle into the pulmonary artery, and that it then passed through the veins and along to the vena cava, and so round to the left ventricle in the manner already indicated. Which motion we may be allowed to call *circular*.

From Chapter IX.—Three points present themselves for

confirmation, which being stated, I conceive that the truth I contend for will necessarily follow:

1. The blood is incessantly transmitted by the action of the heart from the vena cava to the arteries in such quantity that it cannot be supplied from the ingesta and in such a way that the whole mass must very quickly pass through the organ.

2. The blood under the influence of the arterial pulse enters and is impelled in a continuous, equable, and incessant stream through every part and member of the body, in much larger quantity than were sufficient for nutrition, or than the whole mass of fluids could supply.

3. The veins in like manner return the blood incessantly to the heart from all parts and members of the body.

These three points proved, I conceive it will be manifest that the blood *circulates*, propelled and then returning, from the heart to the extremities, from the extremities to the heart, and thus that it performs a kind of circular motion.

Let us suppose, either arbitrarily or from experiment, the quantity of blood which the left ventricle of the heart will contain, when distended, to be, say, two ounces. Let us assume, further, how much less the ventricle will hold in the contracted than in the dilated state; and how much blood it will project into the aorta upon each contraction. All the world allows that with the systole something is always projected, a necessary consequence already demonstrated and obvious from the structure of the valves. And let us suppose as approaching the truth that the fourth of its charge is thrown into the aorta at each contraction. This would give half an ounce of blood as propelled by the heart at each pulse into the aorta; which quantity, by reason of the valves at the root of the vessel, can by no means return into the ventricle. Now in the course of half an hour, the heart will have made more than a thousand beats, in some as many as two, three, and even four thousand. Multiplying the number of half-ounces propelled by the number of pulses, we shall have at least one thousand half-ounces sent from the

ventricle into the aorta, a larger quantity in every case than is contained in the whole body!

Upon this supposition, therefore, assumed merely as a ground for reasoning, we see the whole mass of blood passing through the heart, from the veins to the arteries and in like manner through the lungs.

From Chapter X.—By tying the veins some way below the heart, you will perceive a space between the ligature and the heart speedily to become empty; so that, unless you would deny the evidence of your senses, you must needs admit the return of the blood to the heart.

If on the contrary the aorta be compressed or tied, you will observe the part between the obstacle and the heart, as well as the heart itself, to become inordinately distended, to assume a deep purple or even a livid colour, and at length to be so much oppressed with blood that you will believe it about to be choked; but the obstacle removed, all things immediately return to their pristine state—the heart to its colour, size, stroke, &c.

From Chapter XI.—From certain experiments (with ligatures) it is obvious that the blood enters a limb by the arteries and returns from it by the veins; that the arteries are the vessels carrying the blood from the heart, and the veins are the returning channels of the blood to the heart; that in the limbs and extreme parts of the body the blood passes either immediately by anastomosis from the arteries into the veins, or mediately by the pores of the flesh, or in both ways.

[Harvey had no microscope, and his hand lens was not powerful enough to show him the capillaries. He had therefore no real knowledge of the way by which the blood passed from the arterioles (smallest arteries) into the venules (smallest veins). But he did not repeat the mistake made by Aristotle, and again in 1571 by Cesalpino, that the blood passed from the smallest arteries into “capillamenta”, the *νεύρα* of Aristotle.]

From Chapter XIII.—We have yet to explain in what manner the blood finds its way back to the heart from the extremities by the veins. It will be made sufficiently clear from the valves which are found in the cavities of the veins themselves.

Fabricius first gave representations of the valves in the veins, which consist of raised or loose portions of the inner membranes of these vessels, of extreme delicacy, and a semilunar shape. They are situated at different distances from one another, and diversely in different individuals; they are connate at the sides of the veins; they are directed upwards or towards the trunks of the veins; the two—for there are for the most part two together—regard each other, mutually touch, and are so ready to come into contact by their edges, that if anything attempt to pass from the trunks into the branches of the veins, or from the greater vessels into the less, they completely prevent it; they are further so arranged that the horns of those that succeed are opposite the middle of the convexity of those that precede, and so on alternately.

The office of these valves is by no means explained when we are told that it is to hinder the blood, by its weight, from all flowing into inferior parts; for the edges of the valves in the jugular veins hang downwards, and are so contrived that they prevent the blood from rising upwards; the valves, in a word, do not invariably look upwards, but always towards the trunks of the veins, invariably towards the seat of the heart.

There are no valves in the arteries, save where they emerge from the heart itself.

The valves of the veins are solely made and instituted lest the blood should pass from the greater into the lesser veins, and either rupture them or cause them to become varicose.

In many places two valves are so placed and fitted that when raised they come exactly together in the middle of the vein, and are there united by the contact of their margins;

and so accurate is the adaptation that neither by the eye nor by any other means of examination can the slightest chink along the line of contact be perceived. But if the probe be now introduced from the extreme towards the more central parts, the valves, like the floodgates of a river, give way and are most readily pushed aside. The effect of this arrangement plainly is to prevent all motion of the blood from the heart and vena cava; whether it be upwards towards the head, or downwards towards the feet, or to either side towards the arms, not a drop can pass. All motion of the blood, beginning in the larger and tending towards the smaller veins, is opposed and resisted by them; whilst the motion that proceeds from the lesser to end in the larger branches is favoured, or, at all events, a free and open passage is left for it.

From Chapter XIV.—And now I may be allowed to give in brief my view of the circulation of the blood.

Since all things, both argument and ocular demonstration, show that the blood passes through the lungs and heart by the action of the auricles and ventricles, and is sent for distribution to all parts of the body, where it makes its way into the veins and pores of the flesh and then flows by the veins from the circumference on every side to the centre, from the lesser to the greater veins, and is by them finally discharged into the vena cava and the right auricle of the heart, and this in such a quantity or in such a flux and reflux thither by the arteries, hither by the veins, as cannot possibly be supplied by the ingesta, and is much greater than can be required for mere purposes of nutrition: it is absolutely necessary to conclude that the blood in the animal body is impelled in a circle, and is in a state of ceaseless motion; that this is the act or function which the heart performs by means of its pulse; and that it is the sole and only end of the motion and contraction of the heart.

(The italics have been inserted in order that Harvey's long and rather cumbrous sentence may be more readily followed.)

Harvey's letters show that he was employed almost to the end of his life in devising fresh experiments in proof of the circulation of the blood. The fact remains, however, that Harvey really never knew how the blood actually passed from the arteries to the veins, in other words, how the essential part of the circulation is actually effected. He had no microscope, or at most a very crude one; the days of microscopes had yet to come. He never *saw* the capillaries, but as the result of his observations and experiments he was able definitely to *infer* that the gulf between the small arteries and the small veins was bridged in *some* way. The capillaries were not actually seen until 1661, four years after Harvey's death.

It should be borne in mind that the crux of Harvey's argument was his estimate of the actual quantity and velocity of the blood passing from the heart to the aorta. The only possible return route for such a large quantity of blood in so short a time was via the veins. This was the first application of the idea of any sort of *measurement* in any biological investigation.

The discovery of the circulation was undoubtedly the most momentous event in medical history since classical times.

Harvey's patients included Bacon, James I, and Charles I, but in later life his practice fell off; he devoted so much time to research that not improbably he tended to neglect his work as a physician. His published work on Embryology was of much greater length than that on the Circulation. As an anatomist and a physiologist he was easily the first of his time.

The microscope, though differing so slightly in principle from its parent the telescope, did not develop into a practical instrument very rapidly. The first microscopist of note was **Kircher** (1602-80), a German Jesuit priest. The second was **Leeuwenhoek** (1632-1723), a Dutch draper who devoted his leisure to natural history. He owned 247 microscopes with 419 lenses, most of which he ground and polished for himself. He became a Fellow of the English Royal Society in 1680,

but though a Fellow for forty-three years he never attended a single meeting. He has been called the "Father of Protozoology and Bacteriology". The greatest of the microscopists was, however, **Malpighi** (1628-94); professor of anatomy first at Bologna, then at Pisa, then at Messina. He was the founder of histology. His investigations into the embryology of the chick created a new epoch in medicine. But his great written work was *De Pulmonibus*, in which he demonstrated the capillary anastomosis between the arteries and the veins. "Harvey made the existence of capillaries a logical necessity; Malpighi made it a histological certainty". Malpighi was chief physician to Pope Innocent XII.

Harvey was unquestionably the founder of the *scientific* school of medicine, but he can scarcely be regarded as the prototype of the successful practising physician: he was so strongly attached to the work of his laboratory that the personal equation of his patients probably received less attention than it deserved. "The prince of practical physicians" of that century was Thomas **Sydenham** (1624-89), a Dorsetshire man with a thoroughly English type of intellect, a keen student of Bacon and afterwards of Locke. Perhaps something of a rebel by nature, he refused to be led by the hypothetical explanations current in his day, and he studied diseases without any preconceived hypothesis. He was a firm adherent to the principle that all disease is really cured by nature herself. Freeing himself from all contemporary schools, he claimed to be the disciple of Hippocrates and of Bacon. Science was his principal guide, but he maintained that science was incomplete; as a practising physician he had to listen to nature's *hints* as well as to her clear utterances. Medicine was a science based on definitely established general principles; healing was an art not only based on these general principles but to be applied to particular patients, whom therefore it behoved the physician to study with scrupulous care.

Not a few practising physicians of the seventeenth century made important discoveries. One was John **Mayow** (1640-79),

a Cornishman by birth, with a medical practice at Bath. He demonstrated that the dark venous blood of the veins is changed to a bright red by taking up a certain ingredient of the air in the lungs. He thus came very near to the discovery of oxygen.

It is not always realized that Sir Christopher Wren (1632-1723) was a physician and a highly skilful anatomist; he was one of the first to perform blood transfusions. Of course he was very much more. Newton ranked him as a mathematician with Wallis and Huygens. He was a sound physicist, and his quantitative studies of the motion of the pendulum won gratitude even from Newton himself. He was an accomplished mechanic. He was a foremost astronomer—was Savilian professor of astronomy at Oxford. He became the third President of the Royal Society. Yet with all this work in science he found time to take up architecture, and incidentally, to become the greatest architect of his time. At the age of thirty-six he became surveyor-general to the crown. It is as an architect that the world knows him so well—the builder of St. Paul's Cathedral and fifty city churches, Buckingham Palace, the Royal Exchange, the Sheldonian Theatre, Oxford, and many other notable buildings. Even a layman can appreciate the extraordinary beauty of the profiles of Wren's buildings. "As a boy he was a prodigy, as a man he was a miracle," said one of his contemporaries. What are we to call him? mathematician? physicist? astronomer? anatomist? physician? architect? As an all-round genius, should we not class him with Leonardo?

Examine Kneller's portrait of him. How the brow at once reveals the genius of the man. Look at the immense width between the eyes. Yet he was a small man, and "a certain young man two yards long", otherwise King Charles II, merrily mocked him about it. From youth to old age he remained simple, grave, and modest, and so sweet was his character that he did not even murmur when dismissed by George I. He had been a close friend of the last three Stuart monarchs, but the Hanoverian, "a stupid man notorious

for his stupid actions", wanted to find a job for one of his own creatures, a man grossly incompetent and entirely ignorant of the work he had to do. But Wren said never a word.

(Portraits of Harvey and Wren, Plate 9).

BOOKS FOR REFERENCE:

1. *Exercitatio de Motu Cordis et Sanguinis*, W. Harvey. (There are numerous translations. That by Robert Willis is one of the best known, and the *Everyman* edition has a good introduction by E. A. Perbyn).
2. *Records of William Harvey, with Notes*, James Paget.
3. *William Harvey, A History of*, Robert Willis.
4. *Masters of Medicine: William Harvey*, D'Arcy Power.
5. *History of Medicine*, F. H. Garrison.
6. *Thomas Sydenham*, J. J. Payne.
7. *Thomas Sydenham, Clinician*, D. Riesman.
8. *History of Medicine*, D. A. Gorton.
9. *Sir Christopher Wren*, L. Weaver.

CHAPTER XXIX

First Attempts at a Rational Chemistry

Alchemists, Drug Chemists, Phlogistonists

PARACELSUS, 1493-1541.

LIBAVIUS, 1540-1616.

VAN HELMONT, 1577-1644.

BECHER, 1635-82.

STAHL, 1660-1734.

JEAN REY, 1575-1645.

MAYOW, 1640-79.

BOERHAAVE, 1668-1738.

HALES, 1677-1761.

1. The Alchemists.

Alchemy had its origin amongst the ancient Egyptians and the ancient Greeks, and speculative alchemy probably reached its zenith at Alexandria. Like the modern chemist, both the Aristotelian alchemist of ancient times and the mediæval alchemist had worked out some sort of theory of their subject, a theory which at least served as a unifying working principle. Any worker who is constantly increasing his facts feels an increasingly imperative need to knit them together *somehow*. Consciously, or it may be almost unconsciously, he forms some sort of theory, and, no matter how careful he may be, his imagination may play too large a part, and notions thus creep into his theory that are entirely unwarranted by the facts. The theory may cover all the facts and may prove a useful working instrument, especially for making further discoveries, but if it is badly vitiated by extraneous elements it is bound to lead eventually to the worker's discomfiture. Even if the theory is nothing more than a perfectly constructed hypothesis embodying correctly-ascertained facts and nothing else, it is almost certain to prove



Chemical Laboratory—An Alchemist at Work

By Pieter Breughel

later on inadequate to include the further facts which new discoveries may yield. The hypothesis must therefore be superseded by a new and completer hypothesis. Meanwhile the old hypothesis may have served a useful purpose.

Even the Aristotelians had worked out a kind of theory, logical and complete as far as it went. Aristotle had taught that there were four "elements" of which all things consist. He did not, however, use the term "element" in the modern sense, that is, he did not imply that all kinds of matter can be subdivided or simplified into four constituents. Rather he understood the term element to signify a fundamental *property*. The four were:

1. *Fire*, the property of dryness and heat.
2. *Air* (or *vapour*), the property of wetness and heat, or of gaseousness.
3. *Water*, the property of wetness and cold.
4. *Earth*, the property of dryness and cold, or of solidity.

Everything was supposed to contain one or more of these fundamental constituents which imparted to it their properties.

The mediæval alchemists worked out a much more complete theoretical system, though much of it seems now to be very vague. (We have already referred to it in Chapter XVI.) The reader may call it philosophy or alchemical theory as he may feel disposed. They recognized:

1. *The Unity of Matter*.—They held that matter is *one* but can take a variety of forms from which an infinite variety of combinations can be effected. Although this *prima materia* changes its form, it cannot be destroyed.

2. *The three Principles*. All metals and minerals consist of certain principles. These were at first called *mercury* and *sulphur*, not the ordinary substances so named, but *philosophers' mercury* and *philosophers' sulphur*. At a later period they added a *philosophers' salt*.

The *mercury* of a metal represented its lustre, volatility, fusibility, and malleability; the *sulphur* of the metal, its colour, combustibility, affinity, and hardness; the *salt* of the

metal, the means of union between the mercury and sulphur. Mercury, sulphur, and salt, were not three matters, but one, derived from the *prima materia*.

According to this theory, when an alchemist converted a metal into its oxide, or "made a calx" (as he called it), he thought he had volatilized its mercury and fixed its sulphur.

3. *The Four Elements*. These were the four Aristotelian "elements", which the alchemists adopted.

To everything hot they applied the term *fire*; to everything cold and subtle, the term *air*; to everything moist and fluid, *water*; to everything dry and solid, *earth*. But as heat changes liquids to vapours, and consumes solids, they reduced the number of visible elements to two, *earth* and *water*, which contained within themselves the invisible elements fire and air. They were thus able to apply the conception of the "three principles" to that of the "four elements". *Earth* corresponded to *philosophers' sulphur*, *water* to *philosophers' mercury*. To correspond to the *philosophers' salt*, they devised a fifth element, "quintessence" or "ether".

4. *The seven metals*. These were gold, silver, mercury, copper, iron, tin, lead, corresponding respectively to the sun, moon, and five planets. Of these metals they regarded gold and silver as being *perfect*, because they were unalterable by any method with which they were acquainted. The other five were deemed *imperfect* because each could be formed into a calx or oxide, was readily attacked by acids, and so forth. They thought it possible to modify and purify the imperfect metals and so transmute them into the perfect.

On such foundations the alchemists built up a considerable system of philosophy, if such a term may be used.

The modern chemist is inclined to dub the whole system a farrago of nonsense, and in the light of present-day knowledge no doubt it seems to have that character. But if we are to be just we must project ourselves back into the age when the alchemist lived. It was still an age of speculation. Workers still had more confidence in the results of the working of their imagination (they called it reasoning, but the reasoning was

not based on hard facts) than on the results of laboratory experiments.

2. The Drug Chemists.

We have already referred to **Paracelsus** (more correctly, **Philippus Aureolus Theophrastus Bombastus von Hohenheim**), the Swiss physician who at the age of thirty-three became professor of medicine in the University of Basle. At his first lecture he ostentatiously burned the works of **Galen** and **Avicenna**, the great medical authorities of that age. Though a man of remarkable ability, he was aggressive, contemptuous of his fellow-workers, vitriolic-tongued, extremely vain, greedy, intemperate, and hated by everybody. He gave a new outlook to chemistry by insisting that its main business was the preparation of *drugs* and other remedies for use in medicine. He directed special attention to "sulphur, mercury, and salt", maintaining the doctrine that everything is ultimately reducible to these three "elements"; he advocated the use of antimony as a remedy, and he is said to have been the first to use laudanum. But he rejected the study of anatomy, and he considered diseases to be spiritual in their origin. "The true use of chemistry is not to make gold but to prepare medicines."

His onslaught on existing orthodoxy was so irresistible that it swept away many features of the older type of alchemy. His views were often ridiculous, often superstitious, always dogmatic, but rarely traditional. It is true that the search for the philosopher's stone and the elixir of life went on for another two centuries, but that search was no longer the main end of chemistry. Chemistry was at last a subject worth studying for its own sake. The great debt which chemistry owes to Paracelsus is his entirely new outlook on the practical side of his subject. The kind of work he introduced was bound eventually to undermine the whole doctrine of alchemy, though apparently Paracelsus formally adhered in some measure to this doctrine all his life.

For a period, *drug chemistry* had many devotees whose untiring labour, though directed into such a narrow channel, was the means of accumulating a vast number of valuable chemical facts. In their laboratory work the chemists gradually realized the prime necessity of ensuring *purity* in the drugs they made. This notion of chemical purity, once established as a key working-principle in the minds of practical chemists, was bound to pave the way for great leaps ahead. Scrupulous chemical cleanliness and purity is the first lesson that every schoolboy has to learn in the laboratory.

It must be borne in mind that the drug chemists knew practically nothing of the nature of disease, and that the drugs they compounded—tinctures, essences, and extracts—were usually at least as likely to kill as to cure. The disgusting concoctions used as medicines by the ancient and mediæval physicians and apothecaries (they were often made from the internal organs of such animals as snakes and toads, and from ingredients even far more repulsive) were usually as harmless as the brews made from the roots of her kitchen garden by the village housewife of fifty years ago. These dreadful potions seldom killed the patient, as the newer drugs did. On the other hand they often inspired the patient with the belief that he was getting better. To that extent at least there was virtue in the “medicine”. After all, does not the modern patient often “get better” on the strength of precisely the same sort of faith inspired by a harmless coloured mixture in a bottle labelled “three times a day”?

Among the many drug-chemists and vain theorists of those days, it is refreshing to come across a man who was a theorist indeed but also an acute observer and accurate experimenter, Andreas **Libavius** (1540–1616), another physician, this time a German. He published a book which has many claims to be regarded as the first real textbook on chemistry. As a physician he was an unflinching opponent of Paracelsus, but the sulphur-mercury-salt theory, developed by Paracelsus, he seems sometimes to have supported, sometimes to have opposed. He was essentially a

practical man and he devoted much time to the design and equipment of chemical laboratories.

But the greatest name among the drug-chemists is Jean Baptiste **Van Helmont** (1577-1644), still another physician, born at Brussels. He read Hippocrates and Galen but detected the futility of their methods of treatment. This led him to become a disciple of the Paracelsan school, but he soon found himself opposed to many of its views. He absolutely discarded the Aristotelian doctrine of the four "elements" (earth, fire, air, and water), as well as the doctrine of the three "principles" of Paracelsus (sulphur, mercury, and salt). He seemed almost to adopt the ancient theory of Thales, viz. that water is the essential principle of all things. He did not adopt this view as a mere flight of the imagination, but as the result of numerous experiments. The inner nature of these experiments he failed to understand, but to him the results seemed to afford irrefutable evidence in support of his theory. Van Helmont was the first to note that when a metal is dissolved in acid it is not destroyed but may by suitable means be recovered. Apparently he clearly recognized the law of the conservation of matter, at least in particular cases. But his outstanding discoveries were in connexion with gases. The term "gas" he himself invented. He certainly identified carbon dioxide, and apparently some kind of ammonia as well, but he could devise no means for collecting gases. The reader will probably have done at least a little practical chemistry at school, and will therefore remember the pneumatic trough: how simple it is to collect a jar of gas! But if he is a stranger to this work, let him try to collect, in some sort of vessel, a supply of gas, unmixed with air, from the gas supply of the house. He will probably fail. Could Van Helmont have devised a means of collecting gases, the chemistry of those days might have been carried very much further. As it was, carbon dioxide gas was not re-discovered for over a century.

By the middle of the seventeenth century, chemists had acquired sufficient skill in manipulation to prepare and

purify a large number of different substances. They were busy in their laboratories, and the absence of any generally accepted theory of chemistry did not greatly hamper them in the prosecution of their practical work. Aristotelianism was now little more than a shadow, and even alchemy had lost most of its substance. All chemists knew how to make the mineral acids—the commonest and the most frequently used of all the reagents even in a modern laboratory. In short, the chemist had ready to hand several of the main reagents which were to do so much for the future development of his craft. Was that craft to remain an art, or would it ever attain the dignity of a science?

3. The Phlogistonists.

Drug chemistry had originated in alchemy but had not superseded it, and when the drug chemistry period was, in its turn, followed up by the phlogiston period, alchemy in some of its forms still survived. The phlogiston period is the immediate precursor of modern chemistry, and although its leading principle was eventually found to be wrong, the whole period was productive of fruitful work, some of it done by chemists of great eminence.

The “phlogiston” hypothesis was an hypothesis as to the nature of *combustion*.

When a substance is heated in a crucible, in fact when anything burns, what exactly happens? It is not an easy question to answer. And yet the heating of substances is one of the commonest operations in the chemical laboratory. The very earliest chemists must have pondered over the nature of heating and burning, of flame and fire, in short of combustion. Even as late as the eighteenth century chemists were seriously occupied with the problem.

For a long time combustion had been regarded as the *decomposition* of the burning substance into its constituents. It therefore followed that only compound bodies were combustible and that all elementary bodies were incombustible. The combustion of a metal was thus easily explained on the

mercury-sulphur hypothesis; the burning merely meant the giving off and the loss of the sulphur constituent. Later, the combustibility of a substance was assigned to the presence of some *oily* constituent in it. It was believed that sulphur contained a large amount of this oil; it certainly has a greasy feel and when melted its surface has a rather oily appearance. A metal containing sulphur would therefore easily burn, and the residue left after the burning of the metal was regarded as the mercurial constituent contaminated with some kind of earthy impurity. The belief that anything which would burn contained an oily sulphureous principle—*ubi ignis et color ibi sulphur*—continued down to the time of Becher.

Johann Joachim Becher (1635–82) was a German physician who became Professor of Medicine at the University of Mainz. He was, however, interested in many other things besides medicine, especially chemistry, metallurgy, and mining. He was the first to suggest a rational theory of combustion, and though in some ways his views were rather pronouncedly alchemical and implied merely a change of terms rather than a change of principles, he did generalize so far as to propound a theory giving a fairly rational explanation of combustion which, although erroneous, was fruitful and enlightening. Here is a summary:

1. All minerals are composed of three constituents:
 - (α) *Terra pinguis*, the fatty or combustible principle (Lat. *pinguis* = fat).
 - (β) *Terra mercurialis*, the mercurial or fluid principle.
 - (γ) *Terra lapida*, the hard earthy principle (Lat. *lapis* = stone).
2. Combustion is the decomposition of a combustible body into its constituents.
3. A simple body cannot be split up into constituent parts and is therefore not combustible, that is, will not burn.
4. The cause of the combustibility of a body is the fatty principle, the *terra pinguis*, which the body contains.
5. Mineral substances, so far as they are combustible must contain this *terra pinguis*, and the calcination of metals depends upon the expulsion of the *terra pinguis* by fire.

Observe that although Becher's three "principles" are scarcely distinguishable from the three principles of the alchemists, his theory of combustion applies to *all* combustible bodies. His *terra pinguis* is virtually identical with the burning oil and the burning sulphur of his predecessors. To him, combustion is the disintegration of the burning body and the *loss* of its fatty, volatile, constituent. "By the action of fire, a metal gives off into the air its inflammable principle, *terra pinguis*, and the calx that is left is composed of the *terra mercurialis* and the *terra lapida*." "Whenever a body is *burnt*, its inflammable principle is expelled."

Becher's views were confirmed by his celebrated pupil **Georg Ernst Stahl** (1660-1734) and ultimately were developed into a doctrine commonly referred to as the *Phlogiston Theory*. Stahl was trained as a physician and became Professor of Medicine first at Halle and then at Berlin. He was keenly interested in chemistry.

Stahl maintained that every calcinable metal is composed of the calx of that metal and a special combustible substance which escapes into the air when the metal is burned. "*Ignobilia metalla continent substantiam inflammabilem, quae modo igne aperto in auras abiens, metallam in cinerem fatescens relinquit.*" The reduction of the calx is its combination with this combustible substance. "*Metallis ita combustis non licet in metallicam suam faciem reverti, quodcunque aliud experimentum vel additamentum, nisi quod materiam talem inflammabilem illis iterum communicare atque insinuare possit.*"

This combustible substance, the old *terra pinguis*, is not fire itself but rather the material or principle or condition of fire, "*materia aut principium ignis, non ipse ignis*". It was contained in all combustible bodies as an essential constituent. Stahl gave it the name of *Phlogiston*. Metals were composed of a calx, different for different metals, and phlogiston. Phlogiston was thus the principle of combustibility.

But, like all the phlogistonists, Stahl used the term phlogiston sometimes to denote a *substance*, sometimes to denote

the *property* of a substance. It is this ambiguity which so often tends to make the phlogiston theory obscure.

The theory, was, however, so far clear and complete that it covered a very wide range of experimental facts. Not only so, but as new discoveries were made the theory usually seemed to embrace the new facts as well as the old. Increasing confidence was therefore felt in it as a permanently established principle. It may in fact be regarded as the earliest great synthesis of chemical theory. And yet it was eventually overthrown, because certain fundamental experimental facts not only could not be brought within its ambit but seemed almost defiantly to remain outside.

A first objection to the theory was that chemists could devise no means of isolating phlogiston, bottling it up, and putting it on exhibition. "If phlogiston exists, let us *see* it." But the argument was not altogether reasonable, for we cannot bottle up gravity or electricity or magnetism, and put it on exhibition.

A second objection was that no burning could take place in the absence of air, and that if the supply of air was limited the burning soon ceased. Why should air be necessary if the combustion of a body meant merely the decomposition into its constituents and the escape of one of these constituents, viz., phlogiston? Stahl's explanation was altogether unsatisfactory—that phlogiston assumes a rapid whirling motion and that this cannot happen in a vacuum. He seemed to look upon the air as a sort of shock-absorbing sponge, in the absence of which phlogiston feared to free itself!

A third objection, and the most fatal, was that the phlogiston theory was in flat contradiction to certain fundamental experiments. According to the theory a body when heated loses phlogiston and therefore decreases in weight. But a metal when heated *increases* in weight. One particular experiment that had been much discussed as long ago as the previous century was that of heating some tin in an iron vessel placed in an open furnace; 2 lb. 6 oz. of tin was used, and after six hours the resulting white calx was found to be

2 lb. 13 oz. Nothing had been added, and yet there was an increase in weight of 7 oz. A French physician named **Jean Rey** (1575-1645) had looked into the experiment carefully. After considering many conflicting hypotheses he decided that the only hypothesis that squared with all the facts was that the extra weight came from the air, a particularly lucky shot, for he was correct though he knew nothing of oxygen and oxidation. Rey was on the brink of the discovery of the true theory of combustion, and just missed it.

The phlogistonists, well aware of this third objection, tried to meet it by attributing to phlogiston a natural buoyancy, a sort of negative gravity, and therefore a lifting power opposed to gravity. If, therefore, a metal was not subjected to combustion, but was lying quietly at rest in combination with its phlogiston, it would be lighter than when freed from the phlogiston because of the natural lifting power of the latter. Hence a metal after combustion, as now represented by its calx, would reveal its true weight and would *seem* to be heavier. Such an explanation, though at first sight ingenious, could not be supported by any sort of experimental verification, and eventually it was entirely discredited.

John Mayow (1640-79), an English physician greatly interested in chemistry research, maintained that "it has to be admitted that something aerial, whatever it may be, is necessary to the production of any flame", but he went further than other observers, and in the right direction, when he said that combustion is supported not by the air as a whole but by a more active and subtle part of it. Mayow exhibited great skill in the laboratory, and amongst other things he showed how a gas could be transferred from one vessel to another. But one of the greatest practical chemists of his age was **Hermann Boerhaave** (1668-1738), a distinguished physician who became professor of medicine in the University of Leyden. He combated many of the views of the drug-chemists, and he objected to a part of the phlo-

giston theory on the ground that there was no evidence that metals were composed of their calces and a combustible property. But Boerhaave's main work consisted in putting to an experimental test many of the supposed discoveries of the old alchemists. For instance he distilled mercury no less than *five hundred times* without change, thus disproving the old statement of the alchemists that a more volatile body may be obtained from mercury. He was the founder of that branch of chemistry which deals with the analysis of substances occurring in animals and plants—the chemistry of the carbon compounds. **Stephen Hales** (1677–1761), an English clergyman of a strong scientific bent, researched on the physiology of plants and thus had occasion to conduct many experiments with gases. The birth of the modern pneumatic trough is due to him. He also designed the manometer, which he applied to the measurement of arterial blood pressure in horses.

It is a remarkable fact that the Phlogiston theory held the minds of most chemists for more than a century after Stahl enunciated it. Even such pioneers of modern chemistry as **Black**, **Priestley**, **Cavendish**, and **Scheele**, were phlogistonists. Naturally, for they had drunk in the theory with their mothers' milk. Most of them eventually abandoned the theory, but not all. It was the pneumatic trough and the balance that eventually killed it. As we shall see later, it could not possibly survive the quantitative experiments of the great French chemist, **Lavoisier**.

It should, however, be noted that the existence of phlogiston had been inferred from experimental evidence. The inference proved to be wrong, but it was at all events of a *posteriori* origin. It had hardly anything in common with the *a priori* doctrine of alchemy, whether Aristotelian or mediæval. The alchemists' experimental work was *derivative*, the phlogistonists' experimental work was *basic*. The gap between Paracelsus and Stahl was far wider and deeper than between Stahl and Lavoisier. Phlogiston was not yet dead, and even

alchemy was kept alive by the stray seekers after gold and the elixir of life, until it was slain by the ridicule of Robert Boyle.

BOOKS FOR REFERENCE:

1. *A History of Chemistry*, J. C. Brown.
2. *History of Chemistry*, Sir E. Thorpe.
3. *Essays in Historical Chemistry*, Sir E. Thorpe.
4. *History of Chemistry*, H. Bauer.
5. *Makers of Chemistry*, E. J. Holmyard.

CHAPTER XXX

Robert Boyle

1627-91

1. Boyle as a Physicist.

Robert Boyle was the seventh son and fourteenth child of a Dorsetshire man, Richard Boyle, who was sent on an official mission to Ireland where he married a lady of great wealth, and who, ultimately, for services to the king, was created Earl of Cork. It was during the father's residence at Lismore in the county of Waterford that Robert was born and he is therefore sometimes regarded as an Irishman. Robert went to Eton at eight, passed on to Geneva at twelve, and, after travelling for a time in France and Italy, returned at the age of seventeen to the family estate in Dorsetshire. After a few years he moved to Oxford and later to London. Boyle devoted his life to the study of experimental science, and, being a man of ample means and not being driven therefore to seek a professional position, his researches were never hampered by personal anxiety concerning income and domestic comfort. He was one of the founders, and for a time was the President, of the Royal Society.

Every subject of science that Boyle took up he enriched. In his laboratory work he showed great resource and great originality, and his reasoning was always sound and unexceptionable.

In physics he devoted special attention to the pressure of the atmosphere and to the distribution of pressure in water and other liquids. His most famous discovery in physics

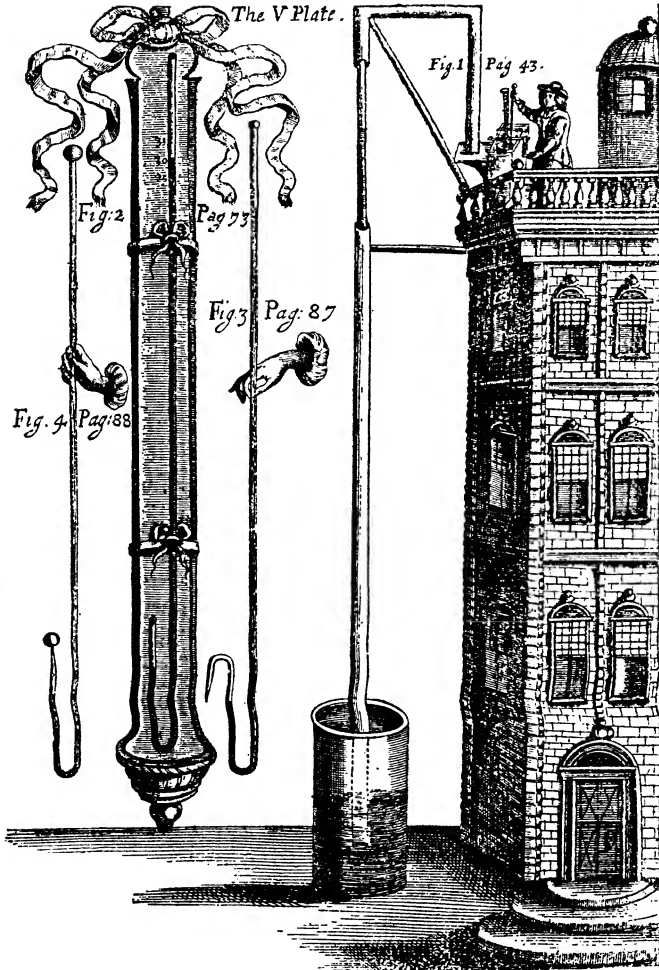

Fig. 56.—Boyle's experiment on spring of the air

was the law which bears his name and which every modern schoolboy knows, or rather thinks he knows. In short, his work in physics was essentially of a constructive character and went far to place the whole subject of hydrostatics on firm foundations. Though not less resourceful in chemistry, his main contributions to this subject took the form of a searching and relentless criticism of prevailing theories and of an insistence on the fundamental importance of the principles of scientific method as formulated a few years before by Francis Bacon.

We may exemplify Boyle's methods by quoting his own account of one of his researches in physics, and then by summarizing his critical views as a Sceptical Chemist.

The following extract is from Boyle's *New Experiments Touching the Spring of the Air, and Hydrostatical Paradoxes*.

"Paradox X.—The cause of the ascent of water in syphons, and of its flowing through them, may be explicated without having recourse to nature's abhorrency of a vacuum.

"Both philosophers and mathematicians having too generally confessed themselves reduced to fly to a *fuga vacui*, for an account of the cause of the running of water and other liquids through syphons; and even those moderns that admit a vacuum, having either left the phenomenon unexplained, or endeavoured to explain it by disputable notions; I think the curious will be much obliged to Monsieur Pascal for having ingeniously endeavoured to show that this difficult problem need not reduce us to have recourse to a *fuga vacui*.

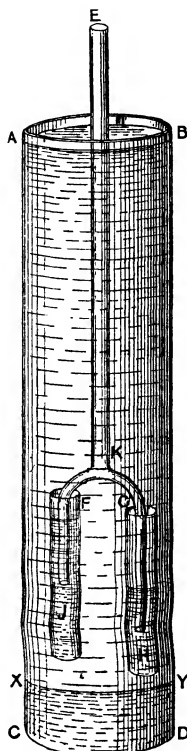

Fig. 57

And indeed his explanation of the motion of water in syphons seems to me so consonant to hydrostatical principles that I think it not necessary to alter anything in it. But as for the experiment he proposes to justify his reasoning, I fear his readers will scarce be much invited to attempt it. For besides that it requires a great quantity of quicksilver, and a new kind of syphon 15 or 20 feet long, the vessels of quicksilver must be placed 6 or 7 yards under water, that is, at so great a depth, that I doubt whether men who are not divers will be able conveniently to observe the progress of the trial.

“Wherefore we will substitute a way. Provide a glass jar ABCD, of a good wideness, and half a yard or more in depth; provide also a syphon of two legs FK and KG, to which is joined at the upper part of the syphon a pipe EK, in such manner that the cavity of the pipe communicates with the cavities of the syphon. To each of the two legs of this new syphon must be tied with a string a glass tube, J and H, sealed at one end: the open end of each tube admits a good part of the leg of the syphon to which it is fastened, which leg must reach a pretty good way beneath the surface of the water, with which the said tube is to be almost filled. But as one of these legs is longer than the other, so the surface of the water in the suspended tube J which is fastened to the shorter leg KF, must be higher (that is, nearer to K or AB) than the surface of the water in the tube H suspended from the longer leg KG, that (as usual in syphons) the water may run from a higher vessel to a lower (fig. 57).

“All things being thus provided, and the pipe EK being made fast that it may not be moved, pour oil of turpentine into the jar ABCD,* till it reach higher than the top of the syphon FKG (whose orifice E you may, if you please, in the meantime close with your finger, or otherwise, and afterwards unstop), and then the oil pressing upon the water will make it ascend into the legs of the syphon, and pass through it, out of the uppermost vessel J into the lowermost H; and if

* “If you have not much oil, pour in water beforehand till it reaches near the bottom of the suspended tubes, as to the level XY.”



SAVANTE ARRHENIUS
Photo. Exclusive News Agency



SIR JAMES DEWAR
Photo Edis.



MADAME CURIE



DR. IRVING LANGMUIR
Photo. Keystone View Co.

SOME SPECIALISTS IN MODERN CHEMISTRY

the vessel J were supplied with water, the course of the water through the syphon would continue longer than here (by reason of the paucity of water) it can do.

“ Now in this experiment we manifestly see the water made to take its course through the legs of a syphon from a higher vessel into a lower, and yet the top of the syphon being perforated at K, the air has free access to each of the legs of it, through the hollow pipe EK which communicates with them both. So that, in our case, where there is no fear of a vacuum, the fear of a vacuum cannot with any show of reason be pretended to be the cause of the water running. Wherefore, we must seek out some other.

“ And it will not be very difficult to find, that it is partly the pressure of the oil, and partly the contrivance and situation of the vessels, if we will but consider the matter attentively. For the oil that reaches much higher than K presses upon the surface of the external water in each of the suspended tubes of J and H. I say the *external water*, because the oil floating upon the water has no access to the cavity of either of the legs F and G. Wherefore, since the oil gravitates upon the water outside the legs, and not upon that inside them, and since its height above the water is great enough to press up the water into the cavity of the legs of the syphon and impel it as high as K, the water must by that pressure be made to ascend.

“ And this raising of the water happening at first in both legs, there will be a kind of conflict about K betwixt the two ascending portions of water, and therefore we will now examine which must prevail.

“ And if we consider that the pressure sustained by the two parcels of water in the suspended tubes J and H depends upon the height of the oil that presses upon them respectively, it may seem at the first view that the water should be driven out of the lower vessel into the higher. For if we suppose that part of the shorter leg that is un-immersed under water to be 6 inches long, and the un-immersed part of the longer leg to be 7 inches, then, because the surface of the water in the

vessel J is an inch higher than that of the water in the vessel H, it will follow that there is a greater pressure upon the water in which the longer leg is dipped by the weight of an inch of oil; so that that liquid being an inch higher upon the surface of the water in the tube H than upon that in the tube J it seems that the water ought rather to be driven from H towards K than from J towards K.

“ But then we must consider that though the descent of the water in the leg G be more resisted than that in the other leg by as much pressure as the weight of *an inch of oil* can amount to, yet being longer by an inch than the water in the leg F, it tends downwards more strongly by the weight of *an inch of water*, by which length it exceeds the water in the opposite leg. So that an inch of water being *ceteris paribus* heavier than an inch of oil, the water in the longer leg, notwithstanding the greater resistance of the external oil, has a stronger endeavour downwards than has the water in the shorter leg, though the descent of this be resisted but by a depth of oil less by an inch. So that all things computed, the motion must be made towards that way where the endeavour is most forcible, and consequently the course of the water must be from the upper vessel and the shorter leg, into the longer leg and so into the lower vessel.

“ *The application of this to what happens in syphons* is obvious enough. For, when once the water is brought to run through a syphon, the air (which is a fluid and has some gravity, and has no access into the cavity of the syphon) must necessarily gravitate upon the water in which the legs of the syphon are dipped, and not upon that which is within the syphon; and consequently, though the incumbent air has a somewhat greater height upon the water in the lower vessel than upon that in the upper, yet the gravitation it thereby exercises upon the former more than upon the latter, being very inconsiderable, the water in the longer leg much preponderating (by reason of its length) over the water in the shorter leg, the efflux must be out of that leg, and not out of the other. And the pressure of the external air being able

to raise water (as we find by suction pumps) to a far greater height than that of the shorter leg of the syphon, the efflux will continue, for the same reason, until the exhaustion of the water or some other circumstance alters the case. But if the legs of the syphon should exceed 34 or 35 feet of perpendicular altitude, the water would not flow through it, the pressure of the external air being unable to raise water to such a height. And if a hole being made at the top of a syphon, that hole should be unstopped while the water is running, the course of it would presently cease. For in that case the air would gravitate upon the water, inside as well as outside the cavity of the syphon; and so the water in each leg would, by its own weight, fall back into the vessel belonging to it.

“But because this last circumstance, though clearly deducible from hydrostatical principles and experiments, has not, that I know of, been verified by particular trials, I caused two syphons to be made, the one of tin, the other of glass, each of which had, at the upper part of the bend, a small round hole or socket, which I could stop and unstop, at pleasure with my finger. So that when the water was running through the syphon, if I removed my finger, the water would presently fall, partly into one and partly into the other of the vessels underneath. And if the legs of the syphon were so unequal in length, that the water in the one had a far greater height than in the other, there seemed to be, when the liquid began to take its course through the syphon, some light pressure from the external air upon the finger with which I stopped the orifice of the socket made at the bend.

“And in this occasion I will add what I more than once tried—to show at how very minute a passage the pressure of the external air may be communicated to bodies fitted to receive it. For, having for this purpose stopped the orifice of one of the above-mentioned syphons (instead of doing it with my finger), with a piece of oiled paper, carefully fastened with cement to the sides of the socket, I found as I expected that though by this means the syphon was so well closed that the water ran freely through, yet, if I made a hole with the

point of a needle, the air would, at so very little an orifice, insinuate itself into the cavity of the syphon, and thereby gravitating inside as well as outside, make the water in the legs to fall down into the vessels. And though, if I held the point of the needle in the hole I made, and then caused someone to suck at the longer leg, this small stopper sufficed to make the syphon fit for use; yet, if I removed the needle, the air would get in at the hole and put a final stop to the course of the water. Nor was I able to take out the needle and put it in again so nimbly, but that the air found time to get in at the syphon; and, till the hole were again stopped, render it useless, notwithstanding that the water was by suction endeavoured to be set a running."

2. Boyle as a Chemist.

Boyle's *Sceptical Chemist* deals with the experimental evidence and with the reasoning based on it, (1) of the "hermetick philosophers" or followers of the Aristotelian doctrine and their "proof" that all "mixt bodies" are compounded of the four "elements", earth, air, fire, and water; and (2), of the "vulgar spagyrist" and the "proof" of their assertion that the "principles" of things are three in number namely, mercury, sulphur, and salt. Despite the enlightening work of the previous century, both Aristotle and Paracelsus still had many followers.*

The *Sceptical Chemist* calls for an exact definition of terms, and for a plain statement of facts. It is not only an elucidation of the true method of scientific research but is an effective vindication of that method against the Aristotelians and Paracelsans who would make paramount the authority of what they are pleased to call their divine reason. At bottom, the theory of the Aristotelians and Paracelsans—the

* The term "hermetick" is derived from *Hermes (Trismegistus)*, an Egyptian god identified with the Greek *Hermes*, supposed to be the author of the occult sciences, especially alchemy. The term "hermetically" literally means "according to the hermetick books," that is, *secretly*; in chemistry it is specifically applied to a tube which has been sealed by fusion. The term "spagyrist" was coined by Paracelsus to signify *chemical* or *alchemical*.

“hermetick philosophers” and the “vulgar spagyrist” — was based on a purely *a priori* conception of the world, a conception to be understood only by looking inwards at one’s thoughts and emotions, discovering in these a guide to the unity of external nature, and then forcing objective facts to take the form that is required by the mentally constructed theory. The impressions which external events produced on the senses of observers were corrected, not by experimental verification and careful reasoning but by seeing whether they fitted into the scheme which had been elaborated from the imagination and accepted as the truth. But, as before stated, there were distinguishing differences, and these we may conveniently summarize again.

The Aristotelians taught that all material things are composed of some or all of the four “elements”, earth, fire, air, and water, but they did not mean those four things as they appear to the senses, but some unknown, imponderable, ethereal substratum of the gross earth, air, fire, and water. It is not possible to discover in ancient writings any definite, clear meanings about these four “elements”; their indefiniteness was their strength. When a speaker’s words mean anything, or everything, or nothing, and neither he nor his hearers know exactly what the words mean, the words cover every possible contingency and serve as opiates to lull to sleep the ordinary plain man. Even nowadays the plain man is daily taken in by the ambiguous nature of many scientific terms in common use; in those days he had come to assure himself that the four “elements” formed the very foundations of all philosophy and all science, and that their names were the perfection of terminology.

The Paracelsans who devoted themselves seriously to laboratory work found three substances of great use to them in their experiments: mercury, sulphur, and salt. Gradually they came to look on these as the simpler things by the admixture of which more complex substances are formed. But accustomed as they were to regard nature as half magical, they persuaded themselves that each of the three substances

owed its efficiency in bringing about material changes to some inner unknown essence, and so they came to distinguish between *ordinary* mercury, sulphur, and salt, and the working *essences* of mercury, sulphur, and salt, or philosophers' mercury, sulphur, and salt. What they meant by the "essences" they had no clear notion at all, and they therefore decided to call them *The Three Principles*, a new term as spurious as it was utterly meaningless.

Thus the characteristic of the newer school of alchemists—the spagyrist or the followers of Paracelsus—was that they compounded all mixed bodies from *Three Principles*; whilst the characteristic of the older school of alchemists—the hermetick philosophers or the followers of Aristotle—was that they compounded all mixed bodies from *Four Elements*.

It was these seven ghosts, the four "elements" and the three "principles", that Boyle set himself to lay. All seven still boldly stalked the night, and sometimes even the day as well.

"Tell me what you *mean* by your Principles and your Elements," said Boyle, "then I can discuss them with you."

Boyle pleads for the use of terms having a definitely recognized meaning, and for lucidity of expression. "I have long observed that these dialectical subtleties that the schoolmen too often employ are wont much more to declare the wit of him that uses them, than increase the knowledge or remove the doubts of sober lovers of truth. And captious subtleties do indeed often puzzle and sometimes silence men, but rarely satisfy them. Being like the tricks of jugglers, whereby men doubt not but they are cheated, though often times they cannot declare by what flights they are imposed on."

The *Sceptical Chemist* takes the form of a dialogue in which *Themistius* represents the older views, and *Carneades* who acts as the spokesman of Boyle. Themistius is allowed to expound his side of the question fully and completely. He is made to defend the Aristotelians but to attack the Paracelsans, for the latter had dared to call in question the

authority of the former. We will quote one of his earlier statements (one or two small emendations have been made in the rather old-fashioned English):

“ That great man, Aristotle, in his vast and comprehensive intellect, so framed each of his notions that, being adapted into one system, they did not need any defence than that which their mutual coherence gives them. How justly this may be applied to the present case I could easily show, if I were permitted, how harmonious Aristotle’s doctrine of the four elements is with his other principles of philosophy; and how rationally he has deduced their number from that of the combinations of the four first qualities from the kinds of simple motion belonging to simple bodies, and from many other principles and phenomena of nature, which so conspire with his doctrine of the four elements that they mutually strengthen and support each other. But since ’tis forbidden me to insist on reflections of this kind, I must proceed to tell you that those who maintain the doctrine of the four elements value reason so highly and are therefore furnished with arguments enough as to be satisfied that there must be four elements though no man had ever yet made an experiment to discover their actual number, yet they are not destitute of experimental knowledge to satisfy others that are wont to be more swayed by their senses than by their reason. And I shall proceed to consider the testimony of experiment, when I have first instructed you that, if men were as perfectly rational as ’tis to be wished they were, this clamant demand for proof by experiment would be as needless as ’tis wont to be imperfect. For it is much more convincing and philosophical to discover things *a priori* than *a posteriori*. And therefore we Aristotelians have not been very solicitous to gather experiments to prove our doctrines, contenting ourselves with a few only, to satisfy those that are not capable of being convinced by the nobler method of reasoning. And indeed we employ experiments to illustrate rather than to demonstrate our doctrines, as astronomers use spheres of pasteboard, merely in order to descend to the capacities of those who must be taught by their senses.

“ I speak thus merely to do justice to reason, and not from any want of confidence in the experimental proof I am to bring forward. For, though I shall describe but one, it will be

such a one as will make all others appear as unnecessary as itself will be found satisfactory.—If you but consider a piece of green wood burning in a fireplace, you will readily discern in the decomposing parts of it the four elements of which we teach.

- “ (1) The *fire* shows itself in the flame by its own light.
- “ (2) The smoke by ascending to the top of the chimney and there readily vanishing into *air*, like a river losing itself in the sea, sufficiently shows to what element it belongs and gladly returns.
- “ (3) The *water* in its own form boiling and hissing at the ends of the burning wood betrays itself to more than one of our senses.
- “ (4) The ashes by their weight, their fineness, and their dryness, put it beyond doubt that they belong to the element of *earth*.

“ If I spoke to less well-informed persons I should perhaps make some excuse for building upon such an obvious and easy analysis, but an apology to you would be wholly out of place, for you are too judicious either to think that experiments to prove obvious truths should be far-fetched, or to wonder that among so many bodies that are compounded of the four elements some of them should on such a slight analysis exhibit so plainly the ingredients they consist of. It is very satisfactory to discover a fundamental truth even in some of the most obvious experiments that men make.”

Themistius, having thus entered a defence on behalf of the Aristotelians, proceeds to attack the spagyrist (the followers of Paracelsus) who had now largely usurped them. He called them “sooty empirics”, and his abuse of them was strong.

“ By how much the more obvious we make our analysis, by so much the more suitable it will be to the nature of that doctrine which it is alleged to prove, which being as clear and intelligible to the understanding as obvious to the sense, it is no marvel that the learned part of mankind should so generally embrace it. For this doctrine is very different from the whims of chymists and other modern innovators, of whose hypotheses

we may observe that as they are hastily formed so they are commonly short-lived.

“ Being built perchance but upon two or three experiments, they are destroyed by a third or fourth, whereas the doctrine of the four elements was framed by Aristotle after he had leisurely considered the theories of former philosophers and had so judiciously detected their errors that his doctrine has ever since been embraced by the lettered part of mankind. Nor has an hypothesis, so deliberately and maturely established, been called in question till in the last century Paracelsus and some few other sooty empirics (rather than philosophers as they are fain to call themselves), having their eyes darkened and their brains muddled by the smoke of their own furnaces, began to rail at the Aristotelian doctrine, which they were too unintelligent to understand, and to tell the credulous world that they could see but *three* ingredients in mixed bodies; and these, to gain for themselves the repute of inventors, they endeavoured to disguise by calling them instead of earth, and fire, and vapour, *salt, sulphur, and mercury*; to which they gave the canting title of Hypostatical Principles. But when they came to describe them, they showed how little they understood what they meant by them, by disagreeing as much from one another as from the truth they agreed in opposing; for they deliver their hypotheses as darkly as their processes, and 'tis almost impossible for any sober man to find their meaning.”

The dialogue is now taken up by Carneades (Boyle's mouthpiece). We can afford space for only one or two short paragraphs:

“ I hoped for an actual demonstration, but Themistius hopes to put me off with an harangue. The rhetorical part of his discourse I shall say nothing to. In what he has said he makes it his business to do these two things: (1), to propose and make out an experiment to demonstrate the common opinion about the four elements; (2), to insinuate various things which he thinks may repair the weakness of his argument from the experiment, in order to bring some credit to the otherwise defenceless doctrine he maintains.

“ To begin, then, with his experiment of the burning wood, it seems to me to be obnoxious in several details.

“ I might make a good deal of the very method of proof which without the least scruple he employs to show that the bodies commonly called mixt are made up of earth, air, water, and fire, which he is pleased to call ‘ elements ’; for as the result of the analysis which the fire is supposed to make, he assumes that bodies emerge resembling those which he takes for the elements. But it may certainly be inferred from Themistius’s experiment that what he calls ‘ elements ’ are really *mixt bodies*.” “ There is not a shred of evidence,” says Carneades in effect, “ to support your contention that the flame, the smoke, the water, and the ash seen in the burning wood are *elements*, and that they cannot be decomposed into things still simpler. The four things you name can be seen, of course, but there is no justification whatever for calling them *elements* and for stating that they alone compose everything in the universe.”

But this is only the first round. Boyle brings forward masses of experimental evidence (incidentally showing that he is a first-rate practical chemist) to prove that the doctrines of both the Aristotelians (the hermetick philosophers) and the Paracelsans (the spagyrist) are utterly untenable.

In the fifth part of the book Boyle recapitulates his arguments:

1. The chymists’ supposition that fire is the real and universal decomposer of compounds is open to grave doubt.
2. It is also very doubtful if the different substances that may be obtained from a compound by the fire are pre-existent in it in the forms in which they are separated from it.
3. Though we might grant that the substances separable from compounds by the fire to have been their component ingredients, yet the number of such substances does not appear the same in all compounds, some of them being resolvable into more differing substances than three, and others not being resolvable into as many as three.
4. The substances which are thus separated are not for the most part elementary bodies but are new kinds of compounds. From these things we are entitled to infer that the vulgar experiments by which the spagyrist claim to prove that their three hypostatical principles do adequately compose all compounds are not so demonstrative as to induce a cautious person to acquiesce in their doctrine.

Towards the close of his book Boyle states, with much emphasis, that there is no sort of reason for limiting the number of elements to three, as the Paracelsans do, or to four, as the Aristotelians do, or indeed to any particular number. Some compounds may be composed of two different elements, some of three, some of four, some of five, some perhaps of many more than five. At present our knowledge is far too limited to determine the number of different elements in nature. Finally Boyle explains what he himself, as a chemist, means by elements. He regards them as certain primitive and simple bodies, not made of any other bodies or of one another, the ingredients of compounds and into which compounds are ultimately resolved. Every element is perfectly homogeneous. No substance is an element if it is further resolvable into two or more distinct other substances.

The chemists who had preceded Boyle, and some also who succeeded him, "were carried along by the genius of the age in which they lived, being satisfied with assertions instead of proofs, or, at least, often admitting as proofs the slightest degrees of probability, unsupported by that strictly rigorous analysis which is required by modern philosophy."

Boyle was not able to devise experiments to decide finally whether a given substance may or may not be considered an element. Let us suppose that, even at the present day, the question arises whether a particular substance is an element or a compound. The chemist applies all known methods for decomposing compounds into simpler substances. If the methods fail in the case of the given substance, that substance is *provisionally* regarded as an element. A distinguished living chemist puts the matter this way: "'Element' is a conventional term employed to represent the limit of present-day methods of analysis or decomposition. . . . An element is a substance which, as far as we know, contains only one kind of matter. To say that the substances we called elements cannot be decomposed may be regarded as an unwarranted reflection on the powers of our successors."

Boyle was a good-natured and eminently reasonable man,

but he could be impatient and even caustic on occasions. Speaking of some of his contemporaries, he said: "Methinks the chymists, in their searches after truth, are not unlike the navigators of *Solomon's Tarshish fleet*, who brought home from their long and perilous voyages, not only gold and silver and ivory, but apes and peacocks, too. For so the writings of several (I say not all) of your hermetick philosophers present us not only with diverse and substantial experiments, but also with theories which, either like peacock's feathers make a great show but are neither solid nor useful, or else like apes, who, even if they have some appearance of being rational, are blemished with some absurdity or other which, when attentively considered, make them appear ridiculous."

Boyle's researches in Physics were of the utmost importance, but his ruthless analysis and rejection of untenable theories of Chemistry were of even greater importance. "You state a theory, what is your evidence in support of it? *None*. It was born of your imagination. It is not susceptible of any sort of proof and it is bound to be provocative of ridicule."

A large number of chemists were engaged in laboratory work of a far-reaching kind and in discovering multitudes of new facts, but their speculations were for the most part fanciful. A leader was badly needed to help them build up a rational body of doctrine, and Boyle appeared just when the call was most urgent.

(Portrait of Boyle, Plate 9).

BOOKS FOR REFERENCE:

1. *The Spring of the Air, and Hydrostatical Paradoxes*, Robert Boyle.
2. *The Sceptical Chemist*, Robert Boyle. (There is an excellent introduction by Pattison Muir in the *Everyman* edition).
3. *Makers of Chemistry*, Holmyard.
4. *History of Chemistry*, J. C. Brown.
5. *History of Chemistry*, H. Bauer.

CHAPTER XXXI

From Black to Lavoisier

Phlogiston Yields to the Balance

BLACK, 1728-99.

CAVENDISH, 1731-1810.

PRIESTLEY, 1733-1804.

SCHEELE, 1742-86.

LAVOISIER, 1743-94.

When George III was King, not only when George Washington was keeping the English at bay in America but also later when Napoleon was preparing for Trafalgar and for Waterloo, a number of brilliant chemists, having learnt that weighing and measuring were the basic operations of the laboratory, were rapidly placing their subject on permanent foundations. The first of these was **Joseph Black**, the son of a Scottish wine-merchant. He was born in France where his parents were then residing, but he is never regarded as a Frenchman, though Boyle, for similar reasons, is sometimes regarded as an Irishman. He became Professor of Chemistry at Glasgow in 1756 and at Edinburgh in 1766. In 1755 he read a highly important paper entitled "Experiments on Magnesia Alba, Quicklime, and some other alkaline substances," a paper which has ever since been regarded as embodying the first great step in the laying of the foundations of chemistry as an exact science, in furnishing a model of carefully planned experimental investigation, and in providing clear reasoning from the results of chemical experiments. The leading feature of Black's work is the tacit assumption that quantitative results can alone assure certainty. While it is quite true that quantitative methods did not actually

originate with Black, it was certainly Black who took the lead in showing the world that the quantitative way was the only way.

Every reader interested in chemistry should read the whole paper (it is reprinted by the Alembic Club). The cogency of the successive arguments is impressive. Here we have space for only a few paragraphs. As the terminology is in some respects a little unusual, the following preliminary notes may be useful.

1. *Fixed "mild" alkalis:*

(1) Washing soda or sodium carbonate.

(2) Potash or potassium carbonate.

They are "fixed" because the fixed "air" is fixed in them.

2. *Fixed air* or "*air*": carbon dioxide.

3. *Caustic alkalis:*

(1) Sodium hydroxide or caustic soda.

(2) Potassium hydroxide or caustic potash.

(3) Calcium hydroxide or slaked lime.

The first two are white solids which become wet and sticky on exposure to the air. In contact with the skin they cause wounds that look like burns. Hence the term *caustic*. The third is a white powder made by adding water to quicklime. The water "slakes" the "thirst" of the quicklime.

4. *Quicklime:* burnt lime, resulting from burning limestone or chalk; calcium oxide.

5. *Magnesia alba:* magnesium carbonate.

6. *Limestone* or *chalk* contains 44 per cent by weight of carbon dioxide.

Black had been engaged in an investigation as to an effective means of dissolving urinary calculi, and that led him to study the action of quicklime in converting mild alkalis into caustic alkalis, in other words in converting the carbonates into hydroxides. At that time the caustic nature of these substances was held to be due to phlogiston. For instance, the caustic nature of quicklime formed by strongly heating chalk was explained by the assumption that

chalk had taken up phlogiston from the fire, but Black showed that the causticity meant not the gain but the *loss* of something; during the heating, weight was *lost*, and the loss was due to the fact that a gas, "fixed air" (carbon dioxide), was given off. Black also found that precisely the same thing happened when magnesia alba was strongly heated, but that heat had no action on the fixed "mild" alkalis.—Black said:

"It is sufficiently clear [from previous experiments] that the chalk (limestone), the mild alkalis, and the magnesia alba, contain a large quantity of fixed air, and this air certainly adheres to them with considerable force, since a strong fire is necessary to separate it from the magnesia alba, and the strongest is not sufficient to expel it entirely from the fixed "mild" alkalis, or take away their power of effervescing with acids.

Hypothesis. "These considerations led me to conclude that the relations between the fixed air and the alkaline substances were somewhat similar to the relations between these and the acids; that as limestone and fixed mild alkalis attract acids strongly and can be saturated with them, so also in their ordinary condition they are saturated with fixed air. And when we mix an acid with a fixed mild alkali, the fixed air is then set at liberty and breaks out with violence, because the alkali attracts it more weakly than it does the acid, and because the acid and fixed air cannot both be joined in the same body at the same time.

Further hypothesis. "I also imagined that when chalk (limestone) is exposed to the action of a violent fire, and is thereby converted into quicklime, it suffers no other change in its composition than the loss of its fixed air. The remarkable acrimony which we perceive in it after this process does not proceed from any *additional* matter received from the fire, but from some essential property capable of corroding on separation from the fixed air."

Chalk (limestone) was therefore considered to be a peculiar acrid earth which had been rendered mild by its union with

fixed air; and quicklime as the same earth in which, the fixed air having been separated, we discover that acrimony or attraction for water, for animal, vegetable, and for inflammable substances.

The general theory considered. “Chalk (limestone) deprived of its fixed air, or in the state of quicklime, greedily absorbs a considerable quantity of water, becomes soluble in that fluid, and is then said to be slaked; but as soon as it meets with fixed air, it is supposed to quit the water and join itself to the fixed air, for which it has a superior attraction, and is therefore restored to its first state of mildness and insolubility in water.

“When slaked lime is mixed with water, the fixed air in the water is attracted by the lime, and saturates a small portion of it, which then becomes again incapable of dissolution, but part of the remaining slaked lime is dissolved and composes lime-water.

“If this fluid be exposed to the open air, the particles of quicklime which are nearest the surface gradually attract the particles of fixed air which float in the atmosphere. But at the same time that a particle of quicklime is thus saturated with fixed air it is also restored to its native state of mildness and insolubility; and as the whole of this change must happen at the surface, the whole of the quicklime is successively collected there under its original form of insipid chalk, called the crusts of lime water.

“If quicklime be mixed with a dissolved mild alkali, it shows an attraction for fixed air superior to that of the alkali. It robs the mild alkali of its fixed air, and thereby becomes mild itself, while the alkali is consequently rendered more corrosive, or discovers its natural degree of acrimony or strong attraction for water and for bodies of the inflammable kind; which attraction was less perceivable as long as it was saturated with fixed air.”

Consequences of the Theory. “This account of lime and alkalis recommended itself by its simplicity, but appeared to be attended with consequences new and extraordinary. I

therefore resolved to examine these consequences, and found that the greatest number might be reduced to the following Propositions:

Proposition I. "If we only separate a quantity of fixed air from chalk and mild alkalis, when we render them caustic they will be found to lose part of their weight in the operation but will saturate the same quantity of acid as before, and the saturation will be performed without effervescence.

Proposition II. "If quicklime be no other than chalk deprived of its fixed air, and whose attraction for fixed air is stronger than that of alkalis, it follows that, by adding to it a sufficient quantity of alkali saturated with fixed air, the quicklime will recover the whole of its fixed air, and be entirely restored to its original weight and condition of chalk; and it also follows that the substances separated from lime-water by an alkali is the quicklime which was dissolved in the water now restored to its original mild and insoluble state."

Of Black's many quantitative experiments to verify his hypotheses and to prove his theory, we may summarise the most important:

- (1.) *Chalk strongly heated.* Loss of weight = 44 per cent. Residue = quicklime.
- (2.) *Chalk treated with dilute acid.* Effervescence. Evidently a gas given off. Loss of weight = 44 per cent. The result is the same as in (1). A gas ("air") previously "fixed" in the chalk has been released, in the first case by fire, in the second by acid. However much chalk is used, the result is always the same, that is, it is reduced by 44 per cent of its weight.
- (3.) *Quicklime treated with dilute acid.* No effervescence. No loss in weight. Thus no gas is separated from quicklime by an acid. "Chalk saturates the same quantity of acid after it is converted into quicklime as before."
- (4.) *Chalk weighed and converted into quicklime; treated with a solution of mild alkali.* Chalk formed, identical in weight with that originally taken. Hence the necessary fixed air must have been taken by the quicklime from the alkali

and the amount must have been exactly equal to that lost when the original chalk was converted into quicklime. The alkali solution originally mild is now caustic; the quicklime, originally caustic, is now mild (that is, is now chalk).

These and other similar experiments gave a complete solution to Black's original problem. He established definitely that chalk and limestone is a compound of quicklime and fixed air, and that the mild alkalis are compounds of caustic alkalis, and fixed air. The whole investigation consisted of a beautifully devised series of interrelated quantitative experiments.

Of course the research was undertaken before the time of chemical formulæ and equations. Black knew nothing of the real nature of carbonic acid gas, and had no means of telling whether quicklime was an element or a compound. He broke up compounds, not into elements, but into their constituent sub-compounds, and amongst these he established true quantitative relations. The only kind of equation he could formulate was of this type:

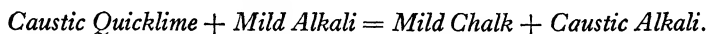

Freed from the restraining fixed air, the alkali naturally exhibits its acrimony or causticity. The fixed air transfers itself to the caustic quicklime and again acts as a restraining agent, and the caustic quicklime is converted into mild chalk. *Why* the transfer takes place, Black did not know. Do we?

Joseph Priestley (1733-1804) was a Yorkshireman trained for the Nonconformist ministry, but he engaged in religious controversy and adopted rather heterodox views. Indeed, he was something of a general agitator and his sympathy with the French republicans resulted in the destruction by fire of his chapel, his house, his library, and his apparatus, at the hands of a Birmingham mob in 1791.

Next door to his house in Leeds where he lived as a young man, was a brewery, and he amused himself by experimenting with the "fixed air" (carbon dioxide) produced there. It

was in this way that he became interested in science. He took up electricity, but in this subject he was described as being only "respectable". It was chemistry that most attracted him and as a chemist he made discoveries of far-reaching importance, especially in connexion with gases. His most famous discovery was that of dephlogisticated air (oxygen). He has been called "the father of pneumatic chemistry". In 1766 he was elected a Fellow of the Royal Society. He was then 33.

Priestley had had no serious academic training and as a research worker he was essentially an amateur. The view commonly held about him until recently was that he never seemed to work according to a carefully thought-out plan; that he "played about" with things, hoping for an occasional lucky shot; that, for instance, he would heat a number of substances, or treat them with a succession of reagents, just to see what might happen; that, in short, he was not methodical. But the researches of Dr. Douglas McKie, of University College, London, show that this view is erroneous. Boyle certainly had any amount of natural acumen, and he possessed exceptional experimental skill. He was remarkably ingenious in devising apparatus of a kind most suitable for carrying out his experiments.

We may quote a few passages from Section III (on Dephlogisticated Air) from his *Different Kinds of Air*.

"The contents of this section will furnish a very striking illustration of the truth that more is owing to what we call *chance* than to any proper *design* or pre-conceived *theory* in this business.

"At the commencement of the experiments recited in this section, I was so far from having formed any hypothesis that led to the discoveries I made in pursuing them, that they would have appeared very improbable to me had I been told of them; and when the decisive facts did at length obtrude themselves upon my notice, it was very slowly, and with great hesitation, that I yielded to the evidence of my senses.

“ There are, I believe, very few maxims in philosophy that have laid firmer hold on the mind than that atmospheric air is a *simple elementary substance*, indestructible and unalterable, at least as much so as water is supposed to be. In the course of my inquiries, I was, however, soon satisfied that atmospheric air is *not* an unalterable thing.

“ At the time of my former publication I was not possessed of a *burning lens* of any considerable force. But having afterwards procured a lens of twelve inches diameter and twenty inches focal distance, I proceeded with great alacrity to examine by the help of it what kind of air a great variety of substances would yield, putting them into vessels which I filled with quicksilver and kept inverted in a basin of the same.

“ With this apparatus I endeavoured to extract air from red calx of mercury, and I presently found that, by means of this lens, air was expelled from it very readily. Having got about three or four times as much as the bulk of my materials, I admitted water to it and found that it was not imbibed by it. But what surprised me more than I can well express was that a candle burned in this air with a remarkably vigorous flame. I was utterly at a loss how to account for it. A piece of red-hot wood sparkled in it and consumed very fast. I had no suspicion that the air which I had got from the mercury calx was even wholesome, so far was I from knowing what it was that I had really found.

“ But I was much more surprised when, after two days, in which this air had continued in contact with water (by which it was diminished about one-twentieth of its bulk) I agitated it violently in water about five minutes and found that a candle still burned in it as well as in common air. Though I did not doubt that the air from the mercury calx was fit for respiration, after being agitated in water, I still did not suspect that it was respirable in the first instance; so far was I from having any idea of this air being, what it really was, much superior in this respect to atmospheric air.

“ I procured a mouse and put it into a glass vessel con-

taining the air from the mercury calx. Had it been common air, a mouse would have lived in it about a quarter of an hour; in this air, however, my mouse lived for half an hour, and though it was taken out seemingly dead it presently revived. By this I was confirmed in my conclusion that the air extracted from mercury calx was, *at least, as good* as common air."

It is a curious fact that Priestley was one of the few surviving adherents to the discarded phlogiston theory, and he was faced with the problem of reconciling the theory with his discovery. His explanations betray puzzlement, confusion, and inconsistency. But his definite conclusions were, (1) that since phlogiston is considered to be evolved from all burning substances, atmospheric air must contain plenty of it; (2) that the new gas obtained from mercury calx was atmospheric air which had been derived of its phlogiston. He therefore called it *dephlogisticated air*. His great difficulty, of course, was to explain why mercury calx—a mercury *residue* according to the phlogiston theory—could yield dephlogisticated air when heated. His explanation was irrational, and is not worth repeating. He simply tied himself in a series of illogical knots. His logic was at fault, and he could not see that his discovery was utterly at variance with the phlogiston theory.

Priestley was engaged in his dephlogisticated air research in August, 1774. Three months later he visited Paris, and, dining with the famous French chemist Lavoisier, told him of his discovery. Lavoisier, though surprised, was not slow to turn the discovery to account. But nothing could shake Priestley's belief in phlogiston. Just before he died (in 1804) he wrote his *Defence of Phlogiston*.

In the face of his own discovered stubborn facts, Priestley's general adherence to the faith in which he was born is puzzling, for he certainly weighed the new facts very carefully.

Englishmen do not always realize that Priestley, in his discovery of oxygen (dephlogisticated air), had been antici-

pated by **Karl Wilhelm Scheele** (1742-86), a Swedish chemist who against great odds won for himself a European reputation. He was manager of an apothecary's shop, and only his scanty leisure hours could be devoted to chemistry. He had no great capacity for profound scientific thought, but he was a born experimenter, and the amount of work he got through in his short life (he died at the age of 44) is remarkable. The year before Priestley turned his twelve inch lens on mercury calx, Scheele had obtained a gas which he called *fire-air* or *empyrean air* by heating various substances, red calx of mercury being one of these. The gas was, of course, the same as Priestley's dephlogisticated air, but Scheele's results were not published until 1777, and thus Priestley was given the credit for the discovery. There is no reason to think that Priestley knew anything of Scheele's work: the discoveries by the two men were independently made.

Henry Cavendish (1731-1810) was a member of the Devonshire family (he was son of the 2nd Duke) founded by the 14th century judge, John Cavendish, who was murdered in the Jack Straw rising of 1381. Shy, reserved, taciturn, and a recluse, he is said to have uttered fewer words in the course of his life than the monks of La Trappe. A man of enormous wealth, he lived simply and alone. He was so far eccentric that he would not see his own servants and he ordered his dinner by leaving a written note on the hall table. If by chance a woman servant failed to keep out of his sight, she was instantly dismissed. But he was an untiring worker, though he tended to keep his discoveries to himself, and it is very doubtful if even now we are acquainted with anything like the whole of the work he did. His *Electrical Researches* written between 1771-81 were edited as late as 1879 by Clerk Maxwell from the original manuscripts in the possession of the Duke of Devonshire; they are in 696 articles. Of his chemical researches, the most noteworthy are on gases, the composition of water, and the composition of nitric acid. As

a chemist, he was one of the 'leading three or four of his time; as a physicist he was then easily first in England if not in Europe.

Reference may be made to (1) his discovery of *inflammable* air (hydrogen), (2) his discovery of the composition of water.

1. He prepared *inflammable air* (hydrogen) by the action of dilute sulphuric or hydrochloric acid on zinc, iron, or tin. He describes the results and compares and contrasts the action of the two acids, at different degrees of dilution, on all three metals. He determined the density of the gas (not accurately) and discovered its chief chemical properties, and from the study of these he concluded that the gas was practically pure phlogiston and was derived from the metals, not from the acids. Like Priestley he held to the old phlogiston theory, with the consequence that in some of his inferences he was altogether wrong. But he did discover hydrogen, and he gave it a suitable name (*inflammable air*), even though he was mistaken as to the actual nature and origin of the gas. It is interesting to note that Cavendish was the first to adopt a method of *drying* a gas, also of storing gases over mercury instead of over water.

2. *The composition of water*.—We may quote from Cavendish's own account (*Alembic Club Reprint*, No. 3):

“ In Dr. Priestley's last volume of experiments is related an experiment of Mr. Warltire's in which it is said that, on firing a mixture of common and inflammable air by electricity in a glass vessel, the inside of the glass, though clean and dry before, immediately became dewy; which confirmed an opinion he had long entertained, that common air deposits its moisture by phlogistication. As the latter experiment seemed likely to throw great light on the subject I had in view, I thought it well worth examining more closely.

“ In all the experiments, the inside of the glass globe became dewy, as observed by Mr. Warltire. Care was taken in all of them to find how much the air was diminished by

the explosion, and to observe its test. The result is as follows, the bulk of the inflammable air being expressed in decimals of the common air:

Common Air	Inflammable Air	Diminution	Air Remaining after the Explosion
1·000	1·241	0·686	1·555
1·000	1·055	0·642	1·413
1·000	0·706	0·647	1·059
1·000	0·423	0·612	0·811
1·000	0·331	0·476	0·855
1·000	0·206	0·294	0·912

“From the fourth experiment it appears, that 423 measures of inflammable air are nearly sufficient to completely phlogisticate 1000 of common air; and that the bulk of the air remaining after the explosion is then very little more than *four-fifths* of the common air employed; so that as common air cannot be reduced to a much less bulk than that by any method of phlogistication, we may safely conclude, that when they are mixed in this proportion, and exploded, almost all the inflammable air, and about *one-fifth* part of the common air, lose their elasticity, and are condensed into the dew which lines the glass.

“The better to examine the nature of this dew, 500,000 grain measures of inflammable air were burnt with about $2\frac{1}{2}$ times that quantity of common air, and the burnt air made to pass through a glass cylinder eight feet long and three quarters of an inch in diameter, in order to deposit the dew. The two airs were conveyed slowly into this cylinder by separate copper pipes, passing through a brass plate which stopped up the end of the cylinder; and as neither inflammable nor common air can burn by themselves, there was no danger of the flame spreading into the magazines from which they were conveyed. Each of these magazines consisted of a large tin vessel, inverted into another vessel just big enough to receive it. The inner vessel communicated with the copper

pipe, and air was forced out of it by pouring water into the outer vessel; and in order that the quantity of common air expelled should be $2\frac{1}{2}$ times that of the inflammable, the water was let into the outer vessels, by two holes in the bottom of the same tin pan, the hole which conveyed the water into that vessel in which the common air was confined being $2\frac{1}{2}$ times as big as the other.

“In trying the experiment, the magazines being first filled with their respective airs, the glass cylinder was taken off, and water let, by the two holes, into the outer vessels, till the airs began to issue from the ends of the copper pipes; they were then set on fire by a candle, and the cylinder put on again in its place. By this means, upwards of 135 grains of water were condensed in the cylinder, which had no taste nor smell, and which left no sensible sediment when evaporated to dryness; neither did it yield any pungent smell during the evaporation; in short, it seemed pure water.

“By the experiments with the globe it appeared, that when inflammable and common air are exploded in a proper proportion, almost all the inflammable air, and near one-fifth of the common air, lose their elasticity, and are condensed into dew. And by this experiment it appears, that this dew is plain water, and consequently that almost all the inflammable air, and about one-fifth of the common air, are turned into pure water. In order to examine the nature of the matter condensed on firing a mixture of *dephlogisticated and inflammable air*, I took a glass globe, holding 8800 grain measures, furnished with a brass cock and an apparatus for firing air by electricity. This globe was well exhausted by an air-pump, and then filled with a mixture of inflammable and dephlogisticated air, by shutting the cock, fastening a bent glass tube to its mouth, and letting up the end of it into a glass jar inverted into water, and containing a mixture of 19,500 grain measures of dephlogisticated air, and 37,000 of inflammable; so that, upon opening the cock, some of this mixed air rushed through the bent tube, and filled the

globe.* The cock was then shut, and the included air fired by electricity, by which means almost all of it lost its elasticity. The cock was then again opened, so as to let in more of the same air, to supply the place of that destroyed by the explosion, which was again fired, and the operation continued till almost the whole of the mixture was let into the globe and exploded. By this means, though the globe held not more than the sixth part of the mixture, almost the whole of it was exploded therein, without any fresh exhaustion of the globe.

“As I was desirous to try the quantity and test of this burnt air, without letting any water into the globe, which would have prevented my examining the nature of the condensed matter, I took a larger globe. The liquor condensed in this globe, in weight about 30 grains, consisted of water.

“We must allow that dephlogisticated air is in reality nothing but dephlogisticated water, or water deprived of its phlogiston; or, in other words, that water consists of dephlogisticated air united to phlogiston; and that inflammable air is either pure phlogiston, or else water united to phlogiston.”

Observe that Cavendish first showed that water, instead of being an element, was a compound of inflammable air (hydrogen) and one-fifth part of atmospheric air. He then showed that water resulted from exploding together inflammable air (hydrogen) and dephlogisticated air (oxygen). By thus determining the composition of water, and thus showing conclusively that it was not an element, “he drove the last nail into the coffin of Aristotelian chemical theory”.

That Priestley and Scheele were phlogistonists need not surprise us; they were eminent practical chemists but they were poor logicians. That Cavendish also was a phlogistonist is bound to surprise us much. It serves to show that in a theory eventually to be discarded, and discarded by all, there may be for a time something intellectually satisfying,

* In order to prevent any water from getting into this tube, while dipped under water to let it up into the glass jar, a bit of wax was stuck upon the end of it, which was rubbed off when raised above the surface of the water.

especially to men engrossed in practical work and disinclined to any sort of speculative thinking, something that really does seem to them to cover, in some sort of way, all the facts known.

The extracts from the original papers of Black, Priestley, and Cavendish will have served to show that 18th century chemists had advanced a long way beyond their predecessors.

They were engaged in serious experimental work and were not prone to devote much time to the purely theoretical side of their subject. For this reason, perhaps, they tended to adhere to old hypotheses even when new facts showed that the hypotheses had become untenable. This applies particularly to the phlogiston hypothesis which, despite the continued English defence put up by Black, Priestley, Cavendish, and others, was now destined to be definitely overthrown by a Frenchman.

This Frenchman was **Antoine Laurent Lavoisier** (1743-94), who was born in Paris. Originally intended by his wealthy father for the legal profession, he soon developed a marked taste for science and became a pupil of the French chemist Rouelle. At the age of 21 he won the gold medal offered by the French government for the best method of lighting the streets of cities, and at 25 was admitted as a member of the Academy of Sciences. Having become acquainted with the discoveries of Black, Priestley, and Cavendish, he decided to devote himself to chemistry research. In this work he was actively encouraged and helped by his highly intelligent wife who, in at least one picture of those days, is shown at work with her husband in the laboratory. His main work was concerned with problems of combustion. Within a very few years he had placed the whole subject of chemistry on a definite and permanent quantitative basis, and his secret was the unremitting use of the balance. He heated a substance and it gained weight: *how much* was the gain? He heated a substance and it lost weight: *how much* was the loss? The balance always told him. If a gain, where did the addition come from? If a loss, what had happened to the substance

that had disappeared. And so he went on. It was check, check, check, with the balance all the time.

He placed a piece of phosphorus under a bell-jar inverted over a trough of mercury, and ignited it by means of a burning glass. He noted that:

1. A limited volume of air will burn only a limited amount of phosphorus. If too much phosphorus is used the flame goes out before the combustion is complete (and to relight the remaining phosphorus more air must be admitted).

2. During combustion, a white powder is formed, "phosphoric acid".

3. When the reaction is complete, the residual air occupies four-fifths of the original volume.

4. The weight of the white powder produced, the "phosphoric acid", is about two and a half times the weight of the phosphorus burnt.

5. The residual air is slightly lighter than ordinary air and will no longer support either combustion or life.

How familiar this simple investigation is to the modern schoolboy, but how pregnant with new significance when Lavoisier first did it!

Lavoisier next proceeded to calcine tin. It was already common knowledge that tin and other metals when burnt increase in weight, but Lavoisier decided to calcine tin in a *closed vessel*. He found that the apparatus as a whole suffered no change in weight, although the metal was partially converted into a calx. He therefore concluded that the cause of the increase in weight must be sought in the interior of the vessel. He opened the vessel and air rushed in, the weight of which was found to be approximately equal to the difference between the weight of the tin and that of the tin calx.

From this and similar experiments Lavoisier concluded that the increase in weight of the metal is very approximately equal to the weight of the quantity of the air absorbed, so that the specific gravity of that portion of the air which combines with the metal during the calcination is nearly equal to that of atmospheric air. A further general inference

that he drew from his experiments was that the portion of the air which combines with the metals is slightly heavier than atmospheric air and that that which remains is rather lighter.

From his various experiments he was able to infer that atmospheric air contains two gases, only one of which is concerned with calcination. Priestley's visit to Paris took place at this time, and Lavoisier saw at once that Priestley's "dephlogisticated air" was that active constituent of the atmosphere concerned with calcination. He repeated Priestley's experiment, and devised other new and telling experiments, all of which confirmed his belief that the "principle" which combines with metals during calcination and increases their weight is nothing else than the active constituent of the air we breathe.

Lavoisier had shown (1) atmospheric air consists of two gases, one of which combines with metals and increases their weight; (2) the same gas is the active agent in combustion; (3) "fixed air" is a compound of charcoal and the same gas; (4) the calces of metals are not elements but compounds of the metals, again with the same gas. He decided to call this gas *oxygen*, because it seemed to be an "acidifying principle".

The time was now (1783) ripe for an onslaught on phlogiston. Said Lavoisier: "Chemists have made of phlogiston a vague principle which is not rigorously defined, and which consequently adapts itself to all explanations for which it may be required. Sometimes this principle has weight and sometimes it has not; sometimes it is free fire, sometimes it is fire combined with the earthy element; sometimes it passes through the pores of vessels, sometimes these are impervious to it. It explains at once causticity and non-causticity, transparency and opacity, colours and the absence of colours. It is a veritable Proteus, which changes its form at every instant." Phlogiston is "un être imaginaire".

Most of the phlogistonists hauled down their flags, openly or by stealth. Priestley alone remained obdurate and to the last he remained faithful to Stahl.

It must not be forgotten that Lavoisier was a Frenchman and that therefore Wurtz was in some measure justified when he said, "la Chimie est une science française". Lavoisier did not, however, underestimate the personal part he had taken in establishing the new combustion theory: "This theory is not, as I have heard it called, the theory of the French chemists in general; it is *mine*."

Before the French Revolution took place Lavoisier had held a government appointment. That was enough for the Committee of ruffians who were in control in 1794, and the President cynically remarked, "La République n'a pas besoin de savants". Lavoisier was guillotined. Had he lived, what might he not have done for chemistry!

BOOKS FOR REFERENCE:

1. *Alembic Club Reprints*.
2. *Makers of Chemistry*, Holmyard.
3. *History of Chemistry*, J. C. Brown.
4. *History of Chemistry*, H. Bauer.
5. *History of Chemistry*, Sir E. Thorpe.
6. *Essays in Historical Chemistry*, Sir E. Thorpe.

CHAPTER XXXII

The Atomic Theory Established

PROUST, 1755-1826.

DALTON, 1766-1844.

AVOGADRO, 1776-1856.

DAVY, 1778-1829.

GAY-LUSSAC, 1778-1850.

BERZELIUS, 1779-1848.

It has now long been an accepted theory that all matter, whether a solid, a liquid, or a gas, is composed of minute particles called *molecules*, and that these could be seen if we were provided with a sufficiently powerful optical instrument. They are so minute that it is utterly impossible for the imagination to visualise them. For instance, the evidence is practically incontestable that the number of molecules in a single pint of water is roughly equal to the number of *drops* of water in all the oceans of the world!

We may have a molecule of an element, like iron, or a molecule of a compound, like water. But nearly all molecules, even those of elements, are *composite* in character, the component parts being named *atoms*. A very small number of the elements are exceptional in that they have but one atom. But atoms do not normally exist singly; normally they remain quiescent in the molecules containing them. If, however, the molecules are violently disturbed, as they may be by great heat or some form of chemical action, they break up, either into sub-groups of atoms or into single atoms. This disturbance is almost certain to bring about a re-grouping of the single atoms or the sub-groups of atoms, with the consequence that entirely new molecules are formed. Except for a very short time during these violent commotions atoms have no independent existence. An atom almost always associates

itself with at least one other atom even if the other is exactly similar to itself. All this is now part of the basic theory of chemistry and is universally accepted.

It is very largely the result of a comparison of a host of experiments worked by many chemists in the latter half of the 18th century. Perhaps the most notable of these chemists was a Frenchman, **Joseph Louis Proust** (1755–1826), who analysed a large number of different substances and discovered that in the formation or in the decomposition of every compound the *proportions by weight of the constituents are always the same*. This is known to chemists as the Law of Constant Proportions. **John Dalton** had obtained similar results, and John Dalton began to think. He was a mathematician, and he asked himself, "What is the inner significance of the remarkable consistency underlying all these analogous results?"

The son of a Cumberland weaver, **John Dalton** (1766–1844) struggled almost unaided through boyhood and youth and eventually became a schoolmaster in Manchester. Though a teacher of mathematics he became keenly interested in meteorology (for 57 years he kept a meteorological diary and recorded over 200,000 observations), and this led him to direct special attention to the gases of the atmosphere. He seems to have known Newton's *Principia* very well, and apparently he long pondered over the 23rd Proposition of the second book: "*If a fluid be composed of particles mutually repelling each other, and the density be as the compression, the centrifugal forces of the particles will be reciprocally proportional to the distances of their centres.*" It was not improbably this proposition that led him to conclude that, after all, there was something in the old classical theories of atoms. He pushed ahead with chemical research, devoting special attention to quantitative analysis, and by the age of 36 he was able to publish papers which proved the foundation of a great reputation, though it was not till six years afterwards that he published his *New System of Chemical Philosophy*.

Dalton revived the atomic theory, but the entirely new feature that he implanted in it was that the main differentia

between any one substance and any other is in the *weights* of their respective atoms. He assumed that these ultimate particles of all substances are incapable of further division, that they are spherical, and that they possess characteristic weights. Could the theory be verified by actually *weighing* the particles? No, their isolation was impossible. Could their relative weights be ascertained? That seemed possible.

The actual experiment that led Dalton to initiate the experimental research seems to have been this.* He analysed the two gases, olefiant gas and marsh gas, both of which consist of carbon and hydrogen, and he obtained the following results:

Olefiant gas: 85.7 per cent carbon, 14.3 per cent hydrogen.

Marsh gas: 75 per cent carbon, 25 per cent hydrogen.

The mathematical side of him saw at once that those numbers are respectively 6 : 1 and 6 : 2. Why *just twice* as much hydrogen in the one case as in the other?

It is not quite certain, however, whether this experiment *suggested* the theory, or whether it was used to verify the theory already adopted as the result of pondering over Newton's proposition.

The following is taken from Dalton's *On Chemical Synthesis*:

“Chemical analysis and synthesis go no farther than to the separation of particles one from another, and to their re-union. No new creation or destruction of matter is within the reach of chemical agency. We might as well attempt to introduce a new planet into the solar system, or to annihilate one already in existence, as to create or destroy a particle of hydrogen. All the changes we can produce, consist in separating particles that are in a state of cohesion or combination, and joining those that were previously at a distance.

“In all chemical investigations, it has justly been considered an important object to ascertain the relative *weights* of the simples which constitute a compound. But unfortu-

* Some authorities disagree with this view. But the fact stated was given to me by Professor Sir Henry Roscoe and Professor J. H. Gladstone, both of whom called upon me when, as a young teacher, I was giving a lecture on the atomic theory in 1889. Like Dalton, Roscoe taught in Manchester and knew all about Dalton's work; and Gladstone as a boy had actually known Dalton a little.

nately the enquiry has terminated here; whereas from the relative weights in the mass, the relative weights of the ultimate particles or atoms of the bodies might have been inferred, from which their number and weight in various other compounds would appear, in order to assist and to guide future investigators, and to correct their results. Now it is one great object of this work, to show the importance and advantage of ascertaining *the relative weights of the ultimate particles, both of simple and compound bodies, the number of simple elementary particles which constitute one compound particle, and the number of less compound particles which enter into the formation of one more compound particle.*

“ If there are two bodies, A and B, which are disposed to combine, the following is the order in which the combinations may take place, beginning with the most simple, namely:

- 1 atom of A + 1 atom of B = 1 atom of C, binary.
 - 1 atom of A + 2 atoms of B = 1 atom of D, ternary.
 - 2 atoms of A + 1 atom of B = 1 atom of E, ternary.
 - 1 atom of A + 3 atoms of B = 1 atom of F, quaternary.
 - 3 atoms of A + 1 atom of B = 1 atom of G, quaternary.
- &c. &c.

“ The following general rules may be adopted as guides (postulates) in all our investigations respecting chemical synthesis.

“ 1st. When only one combination (compound) of two (elementary) bodies can be obtained, it must be presumed to be a *binary* one, unless some cause appear to the contrary.

“ 2nd. When two combinations are observed, they must be presumed to be a *binary* and a *ternary*.

“ 3rd. When three combinations are obtained, we may expect one to be a *binary*, and the other two *ternary*.

“ 4th. When four combinations are observed, we should expect one *binary*, two *ternary*, and one *quaternary*, &c.

“ 5th. A *binary* compound should always be specifically heavier than the mere mixture of its two ingredients.

“ 6th. A *ternary* compound should be specifically heavier

than the mixture of a binary and a simple, which would, if combined, constitute it, &c.

“7th. The above rules and observations equally apply, when two bodies, such as C and D, D and E, &c., are combined.

“From the application of these rules, to the chemical facts already well ascertained, we deduce the following conclusions; 1st, That water is a binary compound of hydrogen and oxygen, and the relative weights of the two elementary atoms are as 1 : 7, nearly; 2nd, That ammonia is a binary compound of hydrogen and azote, and the relative weights of the two atoms are as 1 : 5, nearly; 3rd, That nitrous gas is a binary compound of azote and oxygen, the atoms of which weigh 5 and 7 respectively; 4th, That nitric acid is a binary or ternary compound according as it is derived, and consists of one atom of azote and two of oxygen, together weighing 19; 5th, That nitrous oxide is a compound similar to nitric acid, and consists of one atom of oxygen and two of azote, weighing 17; 6th, That nitrous acid is a binary compound of nitric acid and nitrous gas, weighing 31.

“From the novelty as well as importance of the ideas suggested in this chapter, it is deemed expedient to give plates, exhibiting the mode of combination in some of the more simple cases. A specimen of these accompanies this first part. The elements or atoms of such bodies as are conceived at present to be simple, are denoted by a small circle, with some distinctive mark; and the combinations consist in the juxtaposition of two or more of these; when three or more particles of elastic fluids are combined together in one, it is to be supposed that the particles of the same kind repel each other, and therefore take their stations accordingly.

“ This plate contains the arbitrary marks or signs chosen to represent the several chemical elements or ultimate particles.

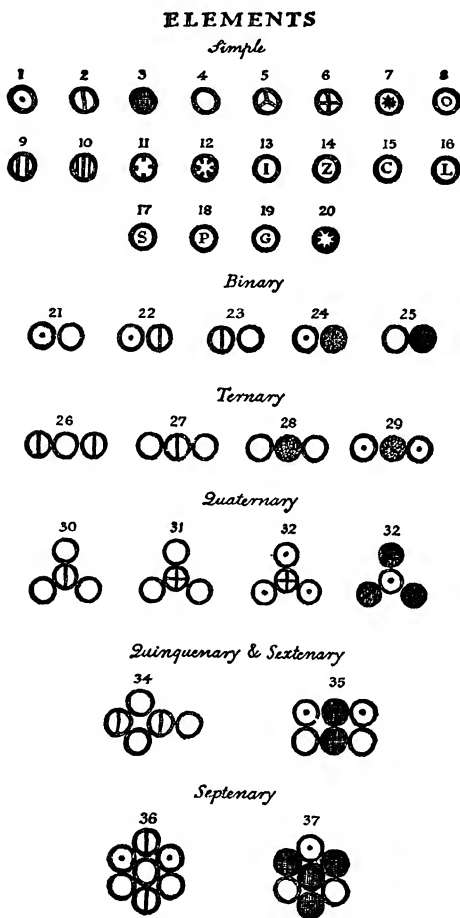

Fig. 58

1. *Elements:*

Fig.		Fig.	
1.	Hydrogen, its rel. weight	1	11. Strontites 46
2.	Azote 5	12.	Barytes 68
3.	Carbone or charcoal .. 5	13.	Iron 38
4.	Oxygen 7	14.	Zinc 56
5.	Phosphorus 9	15.	Copper 56
6.	Sulphur 13	16.	Lead 95
7.	Magnesia 20	17.	Silver 100
8.	Lime 23	18.	Platina 100
9.	Soda 28	19.	Gold 140
10.	Potash 42	20.	Mercury 167

Fig.	COMPOUND	Composition	Relative Weights H = 1
<i>2. Binary Compounds:</i>			
21	Water	1 oxygen 1 hydrogen	8
22	Ammonia	1 azote 1 hydrogen	6
23	Nitrous gas	1 azote 1 oxygen	12
24	Olefiant gas	1 carbone 1 hydrogen	6
25	Carbonic oxide	1 carbone 1 oxygen	12
<i>3. Ternary Compounds:</i>			
26	Nitrous oxide	2 azote 1 oxygen	17
27	Nitric acid	1 azote 2 oxygen	19
28	Carbonic acid	1 carbone 2 oxygen	19
29	Carburetted hydrogen	1 carbone 2 hydrogen	7
<i>4. Quaternary Compounds:</i>			
30	Oxynitric acid	1 azote 3 oxygen	26

[Continued over

Fig.	COMPOUND	Composition	Relative Weights H = 1
	<i>4. Quaternary Compounds:</i>		
31	Sulphuric acid	1 sulphur 3 oxygen	34
32	Sulphuretted hydrogen	1 sulphur 3 hydrogen	16
33	Alcohol	3 carbone 1 hydrogen	16
	<i>5. Quinquenary Compounds:</i>		
34	Nitrous acid	1 nitric acid 1 nitrous gas	31
	<i>6. Sextenary Compounds:</i>		
35	Acetous acid	2 carbone 2 water	26
	<i>7. Septenary Compounds:</i>		
36	Nitrate of ammonia	1 nitric acid 1 ammonia 1 water	33
37	Sugar	1 alcohol 1 carbonic acid	35

“ Enough has been given to show the method; it will be quite unnecessary to devise characters and combinations of them to exhibit to view in this way all the subjects that come under investigation; nor is it necessary to insist upon the accuracy of all these compounds, both in number and weight; the principle will be entered into more particularly hereafter, as far as respects the individual results. It is not to be understood that all those articles marked as simple substances, are necessarily such by the theory; they are only necessarily of such weights. Soda and potash, such as they are found in combination with acids, are 28 and 42 respectively in weight; but according to Mr. Davy’s very important discoveries, they are metallic oxides; the former then must be considered as composed of an atom of metal, 21, and one of oxygen, 7; and the latter, of an atom of metal, 35, and

one of oxygen, 7. Or, soda contains 75 per cent metal and 25 oxygen; potash, 83.3 metal and 16.6 oxygen. It is particularly remarkable, that according to the above-mentioned gentleman's essay on the Decomposition and Composition of the fixed alkalies, in the Philosophical Transactions (a copy of which essay he has just favoured me with) it appears that 'the largest quantity of oxygen indicated by these experiments was for potash 17, and for soda, 26 parts in 100, and the smallest 13 and 19'."

If the reader is acquainted with elementary chemistry, he will note that many of Dalton's values do not agree with the accepted values of the present time. Partly this is due to Dalton's inaccurate analysis, but mainly because he had no definite means of ascertaining the number of atoms in the ultimate particle of any compound. (The useful term "molecule" had not then been introduced.) For instance he assumed—how could he then have done otherwise?—that water contains only one atom of hydrogen and one of oxygen, and thus obtained 8 for the relative weight of oxygen, hydrogen being 1. But when later it was discovered that hydrogen could be turned out of water in two stages, it became necessary to assume that the water molecule contained *two* atoms of hydrogen (for the basis of the theory was that an atom is indivisible), and as the oxygen in the molecule is, by experiment, 8 times as heavy as the *whole* of the hydrogen, it must be 16 times as heavy as *half* the hydrogen, that is, one atom of oxygen must be 16 times as heavy as *one* of the two hydrogen atoms. And so generally. But although further quantitative facts caused many of the consequential details of his theory to be modified, as those facts were discovered, the main point of the theory, that every atom in the molecule of every compound always maintains its own relative weight, stands as four-square now as it did when first enunciated.

One important deduction from the theory is the *Law of Multiple Proportions*. Dalton must have made the deduction

himself, though he never expressed it formally. This was done by the Swedish chemist, **Johann Jacob Berzelius** (1779-1848), whose accuracy as a practical analyst has rarely been equalled. It was he who suggested the present system of chemical notation. Dalton's system had been found cumbersome.

Every teacher of elementary chemistry has his own pet illustration for making clear the Law of Multiple Proportions. Here is one. There are five oxides of nitrogen. Analysed, they give, respectively, the following percentages of nitrogen and oxygen. The percentages may be given the same relative values when exchanged for simple multiples of the now known atomic weights, 14 for nitrogen and 16 for oxygen.

	PER CENT. WEIGHTS OBTAINED FROM ACTUAL ANALYSIS		EQUIVALENTS		OTHERWISE		PROVISIONAL FORMULÆ
	Nitrogen	Oxygen	N	O	N	O	
1	64	36	28	16	14 × 2	16 × 1	N ₂ O
2	47	53	28	32	14 × 2	16 × 2	N ₂ O ₂
3	37	63	28	48	14 × 2	16 × 3	N ₂ O ₃
4	30	70	28	64	14 × 2	16 × 4	N ₂ O ₄
5	25	75	28	80	14 × 2	16 × 5	N ₂ O ₅

Observe the *small whole numbers* indicating the number of atoms of nitrogen and of oxygen in each molecule. There are never any fractions. No compound has been discovered of the kind represented by such a formula, for instance, as N₂₄O₃₁. To chemists this is absolutely unthinkable, so convinced are they that all molecules consist of whole atoms and never of fractions of atoms, and that these atoms always have the same relative weights.

Dalton's atomic theory ranks in importance with Newton's theory of mechanics. In the domain of chemistry it is universal; one might almost say it is both foundation and superstructure in one. Everything seems to depend on it. When put forward at first, there were sceptics (Davy himself was one), but there is probably not a reputable chemist in the whole world to-day



FARADAY
National Portrait Gallery

but who accepts it as the most fundamental principle of his professional faith.

Dalton was 56 when he was elected a Fellow of the Royal Society; he was a Quaker, and apparently a little ungracious in manner, and as a lecturer he seems to have been particularly dull. Towards the close of his life, honours flowed in upon him rapidly, and he had the satisfaction of knowing that the importance of his work was at last fully recognized.

He was 78 when he died.

Another celebrated English chemist of the time was Sir **Humphry Davy** (1778–1829). Born in Penzance, he was a rather uncouth little boy, not very fond of work but a keen angler, and he had a predilection for making fireworks. He was apprenticed to a local surgeon and apothecary, and soon showed a great interest in chemistry, especially of gases. It soon became obvious that he was a skilful and daring experimenter. His work attracted the attention of two distinguished chance visitors to Penzance, and they told the Oxford Professor of Chemistry about him, with the result that he was soon given the control of an institution at Bristol for investigating the medicinal properties of various gases. One of Davy's discoveries at that time was that nitrous oxide is perfectly respirable. Within two years (in 1800) he published an important work on nitrous oxide as an anæsthetic, and at once became famous. Count Rumford had just established the Royal Institution in London, and Davy was appointed Professor of Chemistry there in 1801. It was at the Royal Institution where Davy carried out his many researches, and from 1801 onwards his career was a succession of triumphs. He was elected a Fellow of the Royal Society in 1803.

Davy is popularly remembered as the inventor of the miner's lamp, but his real fame is due to his remarkably successful investigations in chemistry. He was not the first, it is true, to use the electric current for decomposing compounds, but it was he who first suggested that chemical and

electrical attractions were brought about by the same ultimate cause, and thus he made intelligible the decomposition of substances by electricity. What is decomposition? It is merely the breaking up of molecules. In some cases even a moderate heat will suffice to do this, but in others some much more powerful agency is required. Until Davy's time soda and potash had resisted all attempts to break them up, but Davy made a powerful battery of 500 cells (this was long before the days of the dynamo and the generation of electricity on a large scale), and succeeded in splitting up soda into sodium and the two gases oxygen and hydrogen, and potash into potassium and the same two gases. Another important research of Davy's was his experimental proof that chlorine is an element. Until then it had been assumed that muriatic acid (we now call it hydrochloric acid) was an oxygen acid, just as sulphuric acid is, and that chlorine (then called oxymuriatic acid) differed from it simply in containing more oxygen. But Davy proved that chlorine is an element, and that muriatic acid (hydrochloric acid) gas is a compound of chlorine and hydrogen, the chlorine taking the place of the usual oxygen in an acid. He devised the following experiment to show that there is no oxygen in the gas:

1. He sparked it and got no trace of oxygen.
2. He heated carbon in it and obtained neither carbon dioxide nor carbon monoxide.
3. He heated tin in it and got no oxide of tin.
4. He got no oxides with phosphorus, only chlorides.
5. He showed that chlorine is very different in character from the known oxides of chlorine.
6. He showed that the bleaching action of chlorine was due to its liberating oxygen from water.

Davy's work in this and other directions made a very great impression on the leading chemists of the continent. Many doubts about the nature of elements and compounds had been satisfactorily cleared up.

Davy became President of the Royal Society, and his distinctions were many.

Davy was a popular man, and figured in English society, but he was not very sweet-tempered, and his jealousy of his assistant at the Royal Institution, Faraday, is certainly not to his credit. For a time he lived on the continent, and his house among the mountains of Slovenia is still pointed out to tourists. He died at Geneva at the age of 51.

Different types of experiments were devised for determining atomic weights, and for a considerable period chemists were greatly puzzled by the apparent discrepancies. The root of the trouble was that they could not ascertain the exact constitution of molecules. Even now we cannot always be sure whether a molecule should be expressed, e.g. as X_1Y_2 , or X_2Y_4 , or X_3Y_6 . How can the relative weights as determined by simple decomposition decide?

But it was early discovered that additional facts could be obtained by considering the properties of gases. The most noticeable thing about gases is that they can be *compressed* to an enormous extent. It is, for instance, easy to compress oxygen to $1/200$ of its volume. The compression does not affect the individual molecules and therefore does not diminish the volume occupied by the actual oxygen, but it crowds the molecules closer together and diminishes to $1/200$ the space they occupy. Compressing a gas, in fact, is mainly reducing the *empty space* of which it chiefly consists. A jar of gas must be visualized as consisting of small particles (molecules) separated by relatively great empty spaces.

The reader will realize that, considering these empty spaces, it is a remarkable fact that the particles do not *settle*. The particles do not rest on one another; compressibility shows that clearly. The obvious inference is that they must be constantly moving about in all directions, for since they never settle they must be in perpetual motion. We are therefore bound to imagine that they are wholly unlike visible particles, in that they must have perfect elasticity, a conse-

quence of which is that they lose no energy after collision. The *pressure* of a gas must be attributed to the battering of the walls of the containing vessel by the contained molecules. If the volume is reduced, the number of impacts is increased, and therefore the pressure is increased; for every particle moves about with great rapidity and travels in a straight line until it strikes another particle or the wall of the containing vessel, when it rebounds like an elastic ball and continues its movement in a new direction. If a jar of gas is visualized like a jar of water, it is impossible to appreciate the significance of the special properties of gases. There is this specific difference between a liquid and a gas: a liquid is virtually incompressible, so that its molecules, unlike the molecules of a gas, may be visualized as in actual contact.

Joseph Louis Gay-Lussac (1778-1850), the son of a French judge, held a succession of professorships in Paris (one in physics and two in chemistry) and rapidly passed from one success to another until in 1831 he was made a Peer of France. He has always been regarded as one of the most brilliant of French chemists, and French chemists have always been world-renowned. He devoted his whole life to research, not only in almost every department of chemistry but also in many departments of physics as well. In the cause of his researches he hazarded his life more than once. For instance, in order to make observations on the temperature and humidity of the air, he made a balloon ascent in 1804 and reached an altitude of 23,000 feet. And, in those days, balloons were, indeed, fools' playthings.

It was in 1808 that he enunciated his *Law of the Combination of Gases by Volume*, now commonly known as Gay-Lussac's Law. He had proved experimentally that when gases react, their volumes bear a simple ratio to one another, and to the volume of the product if that is gaseous. The Law is sometimes stated thus: *Whenever gases unite and a gaseous product is formed, the proportions by volume of all the gaseous bodies concerned may be represented very accurately by*

small whole numbers, provided that all the measurements are made at the same temperature and pressure. For instance:

1 vol. of H combined with 1 vol. of Cl yields 2 vols. of HCl,
 1 vol. ,, O ,, ,, 2 vols. ,, H yield 2 vols. ,, OH₂,
 1 vol. ,, N ,, ,, 3 vols. ,, H ,, 2 vols. ,, NH₃,
 2 vols. ,, N ,, ,, 3 vols. ,, O ,, 2 vols. ,, N₂O₃,

and so on. Fractions of volumes take no part in the reactions. For instance, if 120 c.c. of O were exploded with 200 c.c. of H, only 100 c.c. of the O would combine with the 200 c.c. of H, and the other 20 c.c. of O would be left over. Generally, the volume of gas resulting from the combination is less than the sum of the volumes of the separate gases, but not always (as, e.g. in the case of HCl); nevertheless the volume of the resulting combination always bears a very simple numerical relation to the volumes of the separate gases before combination.

Chemists were not slow to believe that the remarkable simplicity of these volume relations had some deep significance. But what was it? Dalton suggested that in equal volumes of all gases, elementary and compound alike, there was the same number of ultimate particles, and that the ultimate particles of elementary gases were the *atoms*. But when say, H and Cl unite, there is no change in the total volume; the volume of HCl formed is exactly twice the volume of H, or twice the volume of Cl, used up. If Dalton's idea was correct the volume of HCl could not be more than, say, the volume of the H used, because every particle of HCl must contain at least one atom of H. For simplicity, let us imagine that we start off with 4 atoms of H and 4 of Cl. Then we have:

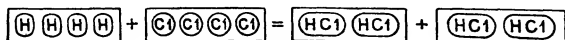

Thus according to the suggested explanation, one volume of HCl would contain only half as many particles as one volume of H (or of Cl). Yet all three gases exactly obey the gas laws (Boyle, and Charles) of pressure and temperature, showing that, physically and mechanically, their constitution is identical and that there must be the *same number* of particles in each

volume. Thus Dalton's suggestion was unacceptable. Dalton was, however, firmly convinced of the truth of the atomic theory and therefore was inclined to believe that Gay-Lussac's results were inaccurate (in point of fact, Gay-Lussac's manipulative skill was much superior to Dalton's).

The way out of the difficulty was found by an Italian chemist, Lorenzo Romano Amedeo Carlo Avogadro (1776-1856), Professor of Mathematical Physics at the University of Turin, who was a staunch supporter of the atomic theory, and his mathematical instinct told him at once that Gay-Lussac's Law of combining volumes was easily reconcilable with that theory if a distinction were made between the ultimate *chemical* particle (the *atom*) of an element, and the ultimate *physical* particle of a substance, element or compound (a particle we now call a *molecule*). He therefore put forward the hypothesis: *Equal volumes of all gases at the same temperature and pressure contain equal numbers of molecules.*

Consider, for instance, 2 volumes of hydrogen and 1 volume of oxygen, all equal. According to Avogadro these contain $2N$ molecules of hydrogen and N molecules of oxygen. After explosion and combination, the 3 volumes of gas are reduced to 2 (of OH_2), and these 2 volumes must, according to Avogadro, contain $2N$ molecules of OH_2 . Thus $2N$ molecules of hydrogen and N molecules of oxygen produce $2N$ molecules of OH_2 , or 2 molecules of hydrogen and 1 molecule of oxygen produce 2 molecules of OH_2 that is,

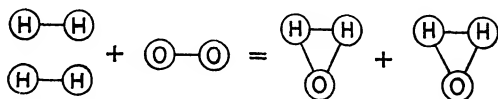

Thus a physical molecule of hydrogen contains 2 chemical atoms of hydrogen, a physical molecule of oxygen contains two chemical atoms of oxygen, and a physical molecule of water contains two chemical atoms of hydrogen and one of oxygen. On such an hypothesis Dalton's facts and Gay-Lussac's facts are reconciled, *but* the constitution of a water molecule is H_2O , and not HO as Dalton had supposed. Thus Dalton's

number 8 as the atomic weight of oxygen has to be doubled.

Consider another instance: 2 volumes of N and 3 volumes of O unite to form 2 volumes of N_2O_3 , all the volumes being the same: litres, pints, or what not; that is 5 volumes reduce to 2 volumes, and yet *all* the volumes must contain the same number of molecules. Avogadro's hypothesis is that each molecule of N and of O contains 2 atoms, and that each molecule of the N_2O_3 contains 5 atoms. Thus

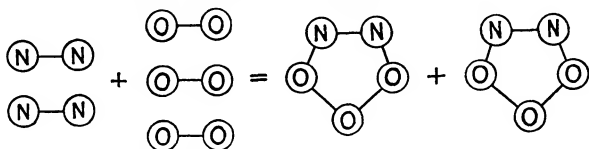

Hence, just as 5 molecules reduce to 2 molecules, so $5x$ molecules reduce to $2x$ molecules, where x represents the indefinitely large number making up the volume considered.

Chemists were not very keen on accepting the molecule as well as the atom, and it was a very considerable time before Avogadro's hypothesis was generally received. When, later on, it was attentively studied, the most important laws governing the combinations of atoms were soon discovered. Provisional "equivalent" weights of the earlier days gave way to finally established atomic weights, and a general theory of chemistry was soon built up on the basis of the foundational hypotheses of Lavoisier, Dalton, Gay-Lussac, and Avogadro. The first three of these men were really great chemists. Who would attempt to arrange them in order of merit? Dalton would have been the last man to claim to be *primus inter pares*, but the two Frenchmen, Lavoisier and Gay-Lussac, would probably have been generous enough to invite him to a seat between them.

(Portraits of Dalton and Davy, Plate 15).

BOOKS OF REFERENCE:

1. See end of previous chapter.
2. *Life of Sir Humphry Davy*, J. A. Paris.
3. *Sir Humphry Davy*, John Davy.
4. *Joseph Priestley* (Science Progress, 109), D. M'Kie.

CHAPTER XXXIII

Early Electrical Research

Faraday's Predecessors and Contemporaries

GRAY, 1696-1736.	VOLTA, 1745-1827.
DU FAY, 1698-1739.	OERSTED, 1777-1851.
MUSSCHENBROEK, 1692-1761.	AMPÈRE, 1775-1856.
FRANKLIN, 1706-90.	DAVY, 1778-1829.
CAVENDISH, 1731-1810.	SCHWEIGGER, 1779-1857.
COULOMB, 1736-1806.	ARAGO, 1786-1853.
GALVANI, 1737-98.	OHM, 1789-1854.

Electrical research was confined to electrostatics until almost the close of the 18th century, the first primitive battery for producing a current not having been put together until 1800. Historically, electrostatics is of some interest, and brief reference may be made to the more important of the early workers.

Stephen Gray, a Charterhouse pensioner, discovered the differences in degree of the electrical conductivity of different bodies, and he managed to electrify some of the Charterhouse boys by suspending them with silk strings.

Charles François de Cisternay du Fay, a Frenchman, attracted by Gray's experiments, pursued the same line of research, and he discovered that Gilbert's classification of substances into electrics and non-electrics, that is, bodies capable of being electrified by friction and those not capable of being so electrified, was incorrect; *all* bodies could be electrified: the so-called non-electrics were really good conductors, and they lost their charge to other conductors

around them as fast as they received it. Du Fay explained electric attraction and repulsion by postulating the existence of two "fluids" which are separated by friction and which neutralize each other when they combine. The two fluids he names *vitreous* and *resinous* electricity.

Pieter van **Musschenbroek**, a well-known Dutch physicist, attempted to electrify water in a bottle by holding the bottle in one hand, and, after charging, trying with the other hand to remove the wire connecting the water to the prime conductor of the electric machine.* The shock which he unexpectedly received was such that he told his friend Réaumur he "would not take another for the kingdom of France". The experiment was performed at Leyden; hence the term "Leyden jar", the principle of which was thus accidentally discovered. Not improbably the reader has received such a shock in his school physical laboratory, perhaps as one of a chain of boys linked together hand by hand. Leyden jar experiments were repeated in France.—The sudden and simultaneous jump of 180 linked soldiers greatly amused the French king. And a similar trick was played upon the Carthusian monks in Paris, who were formed up into a line 300 yards long, linked together by wires; the shock to their austerity and their dignity seems to have been even greater than the shock to their muscles. History is a little unkind in the way it dwells on the victims' discomfiture.

Benjamin Franklin was an American who at the age of 40 threw up his printing business and devoted himself to physical science. This was before the war of independence, and most of the colonists were far too busy with the stern realities of life in a new country to find time for purely intellectual pursuits; scientific research had therefore little interest for them. Franklin seems to have had business

* It is probable that the accidental discovery was made by Musschenbroek's inexpert assistant Cuneus, and that Musschenbroek himself repeated the experiment and afterwards developed the Leyden jar as we know it.

relations with a London merchant named Collinson who was a Fellow of the Royal Society, and Collinson interested him in the subject of electricity. He became an original investigator and in his researches he rapidly forged ahead. By 1747 he was describing the remarkable effects of sharply pointed metal rods, "both in drawing off and in throwing off electrical fire". Such pointed rods have since been used as collectors in electrostatic frictional machines, and the pointed lightning conductor is known to everybody.

Until that time thunder and lightning were generally believed to be due to exploding gases, though opinions differed as to the nature of the gases. In 1749 Franklin suggested the idea that lightning was identical with the electric spark, and in his note-book of that year occurs the following passage: "Electrical fluid agrees with lightning in these particulars: (1) giving light; (2) colour of the light; (3) crooked direction; (4) swift motion; (5) being conducted by metals; (6) crack or noise in exploding; (7) subsisting in water or ice; (8) rending bodies it passes through; (9) destroying animals; (10) melting metals; (11) firing inflammable substances; (12) sulphurous smell." He asked himself whether lightning might not therefore be drawn off by points, after the manner of "the electric fluid in his jars", and he suggested that a test might be made by means of a pointed iron rod fixed to the top of a steeple or tower. In these terms he wrote to his friend Collinson, who submitted the letter to the Royal Society, but the Society at first treated it with derision. However, an experiment with a 40 foot rod was tried in Paris, and though success was immediate and undoubted, Franklin was not satisfied that the rod had been electrified by lightning since it did not actually reach up into the clouds. The idea then occurred to him to send up a kite into the very interior of a thunder-cloud, the kite to be surmounted by a sharp wire a foot long. "To the end of the twine next the hand is to be tied a silk ribbon, and where the silk and twine join a key may be fastened." When the experiment was actually tried Franklin observed

that, when the thunder-cloud passed, the loose fibres of the string erected themselves. He thereupon presented his knuckle to the key, and the sharp shock he received was probably the pleasantest shock of his life. He had demonstrated that lightning was an electrical phenomenon.

Franklin also put forward a new theory of electricity—a *one* fluid theory, in contradistinction to Du Fay's *two* fluid theory. If a body acquired more than its normal stock of electricity, it was said to have a *plus* amount; if less than its normal stock, a *minus* amount. Hence arose the terms *positive* and *negative*. The theory very neatly explains all the ordinary phenomena of electrostatics, and it survived until quite recent times.

It was not until the latter part of the 18th century that any serious work in electrostatic *measurements* was undertaken. Henry Cavendish, to whom we have already referred in a previous chapter, made the capacity of condensers a subject of investigation, and he constructed for himself a complete set of condensers of known capacity. He also anticipated Faraday in the discovery of the specific inductive capacity of different substances. In 1781 he completed an investigation in which he virtually anticipated Ohm's law. Cavendish's *Electrical Researches* (a volume of 450 pages edited by Maxwell from the original manuscripts) shows what a remarkable amount of quantitative research in electricity the famous recluse completed during the ten years 1771-81.

Another worker in the same field was a Frenchman, Charles Augustin Coulomb, whose researches on the torsional elasticity of hairs and wires led in 1777 to the torsion balance, with which he proved that Newton's gravitation law of inverse squares holds also in electric and in magnetic attraction and repulsion. The torsion balance thus served a very useful purpose, but it is now relegated to the museum.

Although electrostatics is of great historic and academic

interest, and although many of its stock experiments are of a particularly elegant character (how even present-day school-boys like to discover the forgotten old Wimshurst machine in its dusty cupboard), yet the subject has little bearing on the technical applications of modern electricity. Modern electricity is almost entirely a question of electric current, and to the earlier developments of this current we now turn. The first two names associated with the history of the current are those of Italians.

Aloisio **Galvani** (1737-98) was a physician and professor of anatomy at Bologna, who had interested himself in the fact that certain species of water-animals are capable of giving electric shocks. An assistant called Galvani's attention to the twitchings and muscular contractions of the legs of a newly-killed frog lying on the table during the working of an electric machine close by; apparently there was an accidental metallic contact of some kind. Galvani investigated the phenomenon and he succeeded in obtaining a repetition of the movements by placing the dead frog on an iron plate and touching the lumbar nerves with one end of a copper wire, the other end of which was in contact with the iron plate. Did the cause lie in the leg, the plate, or the wire? Further experiments led Galvani to conclude that the cause was due to animal electricity in the leg; at the junction of the nerves and muscles there was a separation of the two electricities, the nerve being positively, and the muscles negatively, electrified; and the convulsive movements were due to the establishment of communication between these two electricities by means of the conducting metals. Galvani's experiments and conclusions attracted universal attention.

Alessandro **Volta** (1745-1827), Professor of Physics at the University of Pavia and the inventor of the electrophorus, challenged his fellow-countryman's conclusions. He suspected that the source of the current was not to be traced to the frog's leg but to the contact of two moistened dissimilar

metals. Various experiments tended to confirm this. For instance, a silver and a gold coin held against the tongue produced a bitter taste as soon as the coins were made to touch or were joined by a wire. The experiments seemed to prove that electricity was generated at the contact of two different metals, one metal becoming positively charged, the other negatively.

Volta followed up his conclusion by constructing his famous "Pile". Two discs of dissimilar metal, zinc and copper, were placed in contact and over them was placed a piece of flannel moistened with brine; to multiply the expected effect, the series was repeated several times and the whole made into a pile. Thus the pile consisted of copper, zinc, flannel, copper, zinc, flannel, and so on from the bottom to the top. The flannel was intended to act as a conductor and prevent contact between each zinc and the copper above it. A powerful current was obtained by joining with a wire the bottom disc of copper with the top disc of zinc. In this way the *first battery* was born.

Volta had found that brine gave better results than ordinary water, and a little later he found that acidulated water gave better results still. He now improved on the Pile by inventing his *Couronne de Tasses* (crown of cups), consisting of a series of cups arranged in a circle, each containing acidulated water (or salt water), with a plate of copper and a plate of zinc immersed in it, the copper of each cell being joined up with the zinc of the next, but the first zinc and the last copper being left free as terminals. Obviously we have here a number of simple voltaic cells linked up in series and forming a battery.

The cell was crude and the battery was not very produc-

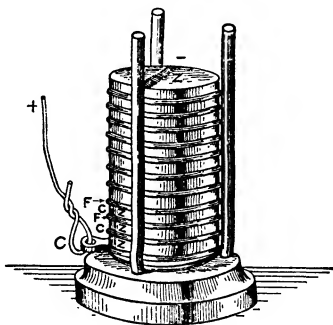

Fig. 59.—Volta's Pile

tive, nevertheless they are the parents of the modern cell and battery, and the discovery of the underlying principles of construction was wholly Volta's. The ineffectiveness of the cell was due to two or three causes, the chief of which was the hydrogen that was given off as the result of the action of the acid on the zinc. The hydrogen formed a film on the copper plate, and soon brought the action to a full stop. It was possible to brush off this hydrogen mechanically but in practice this was hardly feasible, and John Frederick Daniell (1790-1845), a Professor of Chemistry at King's College,

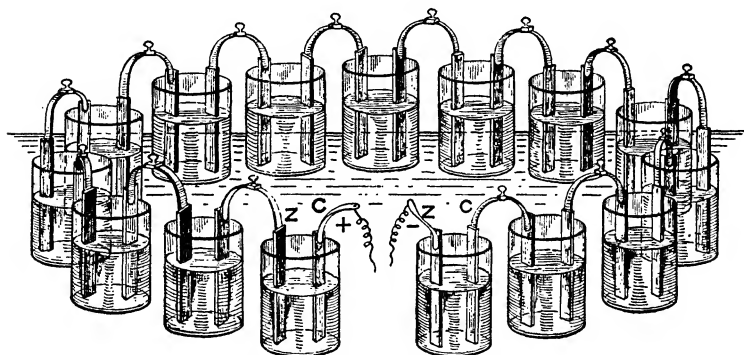
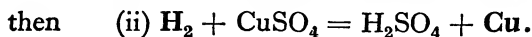
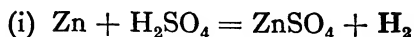

Fig. 60.—Volta's "Crown of Cups"

London, devised the ingenious plan of surrounding the two metals with different liquids, and separating these by a porous pot. The two liquids he used were sulphuric acid and a solution of copper sulphate. The pot prevented the liquids commingling but its porous walls permitted chemical action between the liquids to proceed. The liberated hydrogen on reaching the porous pot could not get through and travel on to the copper plate, but was immediately seized by the oxygen of the copper sulphate, the copper sulphate readily giving up its own copper in exchange for the hydrogen, and this copper travelling on to, and incorporating itself with, the copper plate where, unlike the

hydrogen, it did not oppose the current. As the chemists would say,



The chemical reactions of the cell are really rather more complicated than this, but the details are a little too difficult for those not versed in chemistry to follow.

A London lawyer, Sir William Robert Grove (1811-96), interested himself in science and invented a cell differing

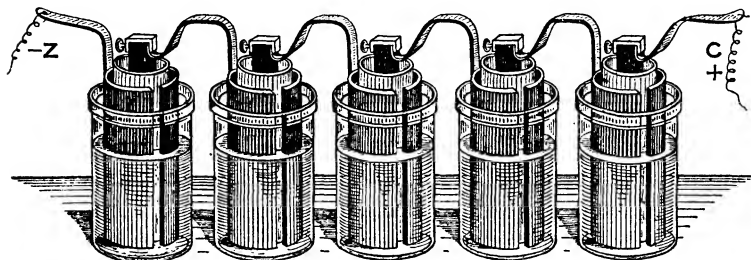

Fig. 61.—Bunsen's Battery

somewhat from Daniell's, the porous pot containing strong nitric acid instead of copper sulphate, and a plate of platinum instead of a plate of copper. In such a cell, the liberated hydrogen reaches the porous pot as before, in the wall of which, however, it now meets the nitric acid, which immediately seizes upon it and oxidises it to water, red fumes of nitrogen peroxide being given off. As this gas readily dissolves in the nitric acid, no film of gas is formed on the platinum plate as a hydrogen film was formed on Volta's copper plate, and no trouble therefore arises. Still another double fluid cell was invented by the famous German teacher of chemistry, Professor Robert Wilhelm Bunsen (1811-99) of the University of Heidelberg. It was much like Grove's, save that carbon was substituted for the expensive platinum. Every schoolboy is familiar with Bunsen's burner.

So much for electric batteries. Such a "messy" expedient

for producing the electric current had to serve for well over half a century. The dynamo had not been dreamed of. Think of the labour required to produce a powerful current: perhaps from 500 cells in series. Picture the preliminaries: 500 outer pots to be half filled with dilute sulphuric acid, 500 porous pots to be nearly filled with strong nitric acid, 500 zinc plates to be amalgamated, 500 clamps to be cleaned, 500 junctions to be made. Striking work was, however, done even with some of the earlier batteries, despite the hydrogen trouble. As early as 1808 Sir Humphry Davy (1778-1829) produced an electric arc between carbon poles: he used a battery of no less than 2000 cells!

The birth of *electro-chemistry* followed immediately on Volta's invention of his Pile, in 1800. Six weeks after Volta had written a letter to the Royal Society in London, describing his Pile, William Nicholson (1753-1815), a writer and lecturer on subjects of science and philosophy, constructed a pile for himself and almost at once succeeded in decomposing water by the electric current thus obtained. This was probably the first experiment in electro-chemistry, and Davy, a far abler man than Nicholson, was not slow to follow up the new line of research. He showed that in the decomposition of water the volume of hydrogen is double the volume of the oxygen; and by 1807 he had decomposed potash and soda, up to that time considered to be elements. But much more interesting than these beginnings in electro-chemistry were the discoveries made in *electro-magnetism*.

The radiant heat from a fire makes itself felt in all directions for a considerable distance around it; the nearer we are, the more "intense" is the warmth. Beyond a certain distance no warmth is felt; there seems to be no very definite boundary; rather there is a "fade-away". It is convenient to speak of the space thus influenced as a "field", namely a field of warmth. Similarly around a light we have a "light"-field, very intense around the source but gradually diminishing to a fade-away. So with sound. So with electricity. So with magnetism. If a sheet of thin cardboard be laid over a

bar magnet on the table and iron filings be sprinkled over it, a few taps on the cardboard will cause the filings to arrange themselves in symmetrical curves around the magnet (fig. 62). The magnetic field is, of course, three dimensional, and the filings merely help us to visualize a horizontal section of it. But this visualization leads us, almost compels us, to infer, (1) that the field is most intense round the poles of the magnet, (2) that the force, whatever it is, in the field is *directional*, and compels the filings to arrange themselves in lines.

It has long been known that the earth itself is surrounded by a field of magnetic force, though not a very strong one. The earth seems to act as if an enormous bar magnet were buried in it, with its poles nearly, but not quite, at the two geographical poles. Of course there is no such magnet, though why the earth acts in the way it does is a little uncertain. The magnetic field is not strong enough to move iron filings, but it may be easily detected by means of the magnetic "needle", that is a light magnet suitably suspended. Such a needle is easily made by magnetizing *with a bar magnet* a narrow piece of thin steel a few inches long, preferably pointed at both ends. This needle should be suspended horizontally by means of a silk thread, or supported horizontally on a needle point. Immediately it turns round and comes to rest in the magnetic meridian, one end definitely pointing to the north magnetic pole of the earth. Obviously it could not so move unless it were pushed or pulled into position by some force, and we feel bound to infer the existence of a magnetic field because the needle behaves exactly as it would behave if it were in the neighbourhood of a real bar magnet, the strong magnetic field of which would then completely overpower and practically nullify the weak field of the earth. Let the reader make a magnetic needle for himself; he will find that if he suspends it at its centre of



Fig. 62.—Magnetic Field of a Bar Magnet

gravity, it will not only turn into the magnetic meridian but its north pole will dip downwards. This is the perfectly natural behaviour of the needle attempting to point *directly* towards the earth's north magnetic pole; thus suspended, it is able to ignore the earth's sphericity. Normally it is more convenient to keep the needle horizontal, and so we make it obey only the horizontal component of the earth's total force. Hence we do not usually suspend it exactly at its centre of gravity but at a point, determined by trial, a little distance away.

It is clear from Bence Jones's *Life of Faraday* that even before the 19th century dawned there was a strong suspicion of an intimate connexion between electricity and magnetism, but the actual initial discovery of the connexion was made by a Dane, Hans Christian Oersted (1777-1851), a Professor of Physics at the University of Copenhagen. During the course of a lecture delivered in 1819, in which he was using a strong battery, he placed a portion of the wire of the closed circuit horizontally and *at right angles* above a magnetic needle on the table. Of course nothing happened, the needle remaining quietly in the meridian. Oersted decided that the current had no effect on the needle and proceeded no further with his tests. But note: that experiment was *intentional*, his successful experiment was *accidental*. Quite by chance at the close of the lecture he moved the wire of the closed circuit into a position *parallel* to the needle, which then promptly swung round through an angle of nearly 90° . Oersted was startled; he tried again, and again had the same result. Then he reversed the *direction of the current*, and the needle swung round in the opposite direction. He then interposed various substances—glass, metals, wood, water, &c., between the wire and the needle, but the effect was maintained. This was about all Oersted did, but he had made *the great discovery that there was some intimate connexion between electricity and magnetism*. The far-reaching significance of the experiment was realized by every physicist in Europe.

Immediately after Oersted's experiment became known, **Schweigger**, a German professor, invented the first galvanometer, and he increased the effective action of the current by coiling the wire many times round the magnetic needle.

In 1820, a well known French astronomer and physicist, **Dominique François Jean Arago** (1786-1853), observed that iron filings were attracted by the electric current. He therefore inferred that a wire carrying a current was the *equivalent of a magnet*. It was, however, another Frenchman whose researches in the subject impressed the world so greatly.

France has given to the world more front-rank mathematicians and mathematical physicists than any other country, and of these **André Marie Ampère** (1775-1856) is one of the most famous. Ampère was born at Lyons but was brought up in a village, his well-to-do merchant father having retired from city life soon after the birth of his only son. Ampère was hardly out of the cradle when he showed signs of a strong mathematical bent, and by the age of 18, though largely self-taught, he had mastered such treatises as Laplace's *Mécanique céleste* and Lagrange's *Mécanique analytique*. When still a young man he became Professor of Physics and Chemistry at Lyons, and in 1809 he was appointed to a Paris professorship which he held till his death.

When in 1820 he heard of Oersted's discovery he was profoundly impressed, and after a week's work in his own laboratory he was able to formulate a simple rule covering all cases of the effects of a current-carrying wire on a parallel magnetic needle whether above or below the needle. It was this: *Imagine a man swimming with the current in the wire, and that he always faces the needle, whether above or below it. Then the N-seeking pole of the needle will always be deflected towards his left hand.*

In Fig. 63 the current is supposed to be flowing, in both cases, from south to north. A is the north-seeking pole of the needle.

(Maxwell later gave a useful alternative rule.—*The direction of the current and that of the resulting magnetic force are related to each other as are the rotation and the forward travel of an ordinary corkscrew.*) (Fig. 64.)

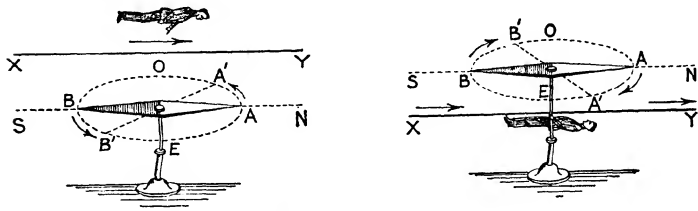

Fig. 63.—Ampère's Rule

From his extensions of Oersted's experiments, Ampère was led to consider the action of two parallel electric currents on each other. He argued that there ought to be attraction and repulsion exactly as in the case of the poles of two magnets. His experimental results enabled him to formulate the laws of

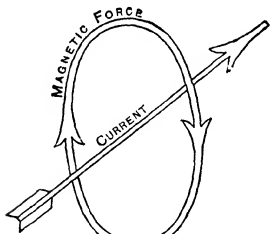

Fig. 64

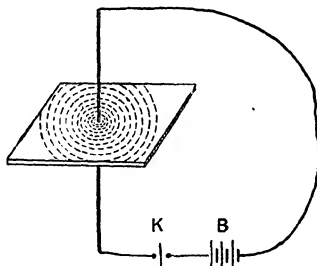

Fig. 65

the mechanical action between currents. Of these laws Maxwell said later, "the theory seems as if it had leaped full grown and full armed from the brain of the Newton of electricity. It is perfect in form and unassailable in accuracy".

It was obvious to Ampère that a magnetic field surrounds every electric current, and that therefore if the coil of a galvanometer is placed in the magnetic meridian and a current be passed through it, the needle must come to rest under the action of two forces acting simultaneously, viz. the earth's

magnetic force tending to keep the needle in the meridian, and the magnetic force due to the current tending to turn

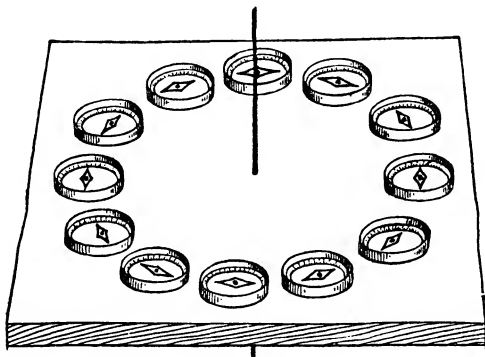

Fig. 66

the needle through a right angle. The actual deflection must therefore be a measure of the current strength employed.

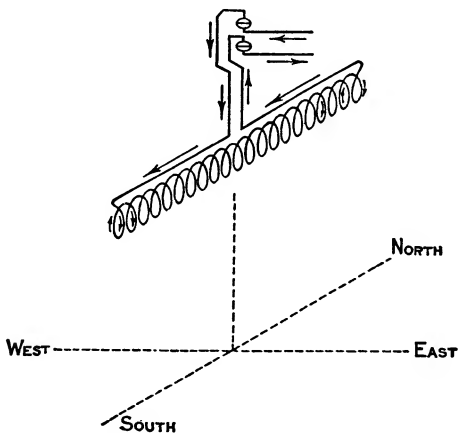

Fig. 67.—Orientation of Solenoid

If a vertical wire carrying a strong current passes through a horizontal sheet of cardboard on which iron filings are sprinkled, the filings will tend to arrange themselves in circles (fig. 65), and the next figure (fig. 66) shows how the

circular lines of force may be traced out by means of a small exploring magnet.

Schweigger had multiplied the turns of his galvanometer coil in order to increase the magnetic effect. Ampère utilised the same idea of multiplying coil turns for making a solenoid, or long coil, for he could see that, since at the centre of each turn there is a magnetic force at right angles to the turn, there must be a strong cumulative force right along the axis of the coil as a whole. Hence if the coil is suspended in such

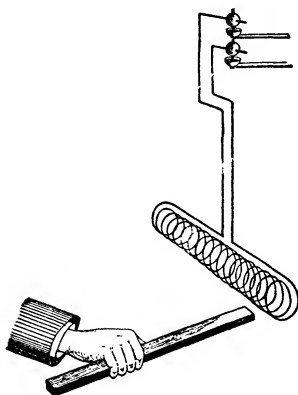

Fig. 68.—Action of Magnet on Solenoid

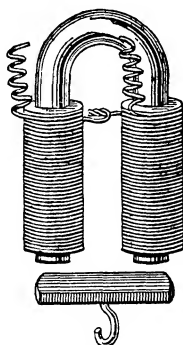

Fig. 69.—Horse-shoe Magnet

a way as to be free to turn horizontally, it must behave exactly like a bar magnet, and take up a position in the magnetic meridian. Ampère suspended his coil in mercury cups (fig. 67), and, since it was then free to rotate, it acted exactly like a suspended magnet, and was readily attracted and repelled by an ordinary bar magnet (fig. 68). A bar of soft iron within such a solenoid is, of course, immediately magnetized.—The origin of the electro-magnet is now obvious (fig. 69).

Ampère's theories of the nature of electro-magnetic phenomena are of considerable historic importance but of little permanent interest. The real importance of his work lies in the experimental development of the subject—in

showing conclusively that the generation of an electric current is invariably accompanied by the generation of a magnetic field.

Now came the great problem: since an electric current produced magnetism, could magnetism be made to produce an electric current? Did not such reciprocal action seem highly probable?

It is this problem that brings us to Faraday.

BOOKS FOR REFERENCE:

1. *A History of Physics*, F. Cajori.
2. *A Short History of Physics*, H. Buckley.
3. *A Short History of Science*, Sedgwick and Tyler.
4. *Makers of Science*, J. B. Hart.
5. *Britain's Heritage of Science*, Schuster and Shipley.
6. *Cavendish's Electrical Researches*, J. Clerk Maxwell.
7. *Life of Sir Humphry Davy*, J. A. Paris.
8. *Humphry Davy, Poet and Philosopher*, T. E. Thorpe.
9. *Humphry Davy, Collected Works*, 9 vols., 1839.

CHAPTER XXXIV

Michael Faraday

FARADAY, 1791-1867.

HENRY, 1799-1878.

TYNDALL, 1820-93.

MAXWELL, 1831-79.

Newton and **Faraday** are the two greatest men of science that this country has produced, and according to many competent critics they are the greatest the world has produced. They both certainly rank with Archimedes and Galileo, even if they are not given the first place of all. It is hardly likely, however, that France and Germany will agree with this view, for both countries have produced many very highly distinguished men of science of their own, men whose claims to a front-rank position cannot be gainsaid. Be the final opinion what it may, the great eminence of Newton and Faraday will never be denied.

Both Newton and Faraday were physicists, but there was this great difference between them: Newton was an eminent mathematician, while Faraday's knowledge of mathematics, outside simple arithmetic, was not equal to that of a boy in a Second Form. Faraday's fame arose from his amazing skill as an experimenter, and from his almost uncanny insight when researching in new fields of physics. In these matters, at least, the world has never produced another man to equal him.

Some six miles from Giggleswick, on the Yorkshire side of the Pennines, is the village of Clapham, the home of Faraday's paternal ancestors, all hardworking yeomen or

craftsmen, undistinguished and apparently unambitious. Michael's father, James Faraday, was one of ten children; he served his apprenticeship as a blacksmith, married in 1786 a farmer's daughter at Kirkby Stephen in Westmorland, and took his bride to London, there to set up business on his own account. He opened a blacksmith's shop near the "Elephant and Castle" south of the Thames, apparently an excellent place for that particular kind of business, for it was at the junction of two main roads from the south into London; post-horses passed in crowds and often had to be re-shod, and repairs to the post-chaises were frequently necessary. The dwelling-house which the young couple occupied was not far away but it has not been identified, though it was in this house that Michael Faraday, the third child, was born in 1791. James Faraday was industrious enough, but his health was indifferent and his business did not prosper. Reduced to poverty, the little family moved across the Thames to a very humble abode in Jacob's Well Mews near Manchester Square. In those days people kept horses and carriages as now they keep cars, and mews, rather unsavoury places, were an established feature at the backs of the fashionable streets of London. A spare room over the stables and coach-house was sometimes let to poor folk in search of a home. We know little of young Michael's childhood between the ages of five and thirteen. The family were desperately poor but the boy seems to have picked up the rudiments of reading, writing, and arithmetic in a local day school. Despite the poverty, Michael seems to have been brought up in a somewhat severely religious atmosphere. His father, like his grandfather, belonged to the very strict Nonconformist sect, the Sandemanians, and was evidently a man of high principles. Young Michael seems to have responded readily enough to his father's teaching; and industry, scrupulous honesty, personal integrity, and a rigorously moral outlook characterized him all his life.

At the age of 13 Michael eased the family exchequer a little by obtaining work as a newspaper boy at the shop of a

bookseller named Riebau, in Blandford St., Marylebone. His qualities so impressed his master that within a year (in 1805, the year of Trafalgar) he was accepted, without premium, as an apprentice for seven years to the trade of bookbinder and stationer. By reading the books he had to bind and to sell, more particularly articles in the *Encyclopædia Britannica*, and Mrs. Marcet's *Conversations on Chemistry*, he was attracted to the study of chemistry and electricity, and when he was 19 his brother helped him to pay a shilling a week for lectures given by a Mr. Tatum on those subjects. A year later a customer at the shop gave him some tickets for lectures by Sir Humphry Davy, Professor of Chemistry since 1802, at the Royal Institution. He had already taught himself to draw, and even in the early days of his apprenticeship he fell into the habit of making careful notes of things which impressed him. Thus he acquired the art of writing well and readily. With a few like-minded youths of his own age he formed a society for mutual higher education, and to this society he often lectured. Rapidly acquiring facility in speaking, he took great pains to improve his English, especially in style and delivery. By the time his apprenticeship was over at the age of 21, he could write and speak really well.

Davy's lectures at the Royal Institution turned Faraday's thoughts definitely from trade to science.

The leading spirit amongst the several distinguished founders of the Royal Institution was Count **Rumford**.

Benjamin Thomson was a native of Massachusetts, who, as a young man, was a teacher in a school at Rumford, afterwards called Concord, in that State. His acceptance of a commission in the English army during the American War of Independence estranged him from his fellow-citizens, and he was obliged to leave America. He came to England, and his excellent scientific work soon won for him the Fellowship of the Royal Society. Then he went to Bavaria, and became the chief in command of the Bavarian forces. For his military services he was made a Count, and he took the title of Rumford.

Returning to England, he proposed the establishment in London of a public institution for diffusing scientific knowledge, for facilitating the introduction of mechanical inventions, and for lectures on the applications of science. This was the origin of the famous Institution in Albemarle Street, established in 1799.

No idea of the research which afterwards grew up under Young, Davy, and Faraday entered the conception of the founders, who really seem to have had in mind a sort of Museum and Lecture Room for applied science. One of the rooms at the Royal Institution is still called the "Model Room". But the idea of an association of mechanics, philosophers, and managers of industry made no appeal, and within a year or two the failure of the new Institution seemed to be in sight. It was the scientific genius which Davy combined with social qualifications that reversed the downward trend. Society crowded to hear Davy and to be told of his discoveries. Finally, Davy's engagement of Faraday, the journeyman bookbinder, made the Institution safe, and ever since it has been the home of a succession of famous research workers.

The Royal Institution lectures for which Faraday had been given tickets happened to be the last that Davy gave. Faraday was intensely interested, and the wish to devote his life to science became irresistible. He made elaborate notes, as accurate as they were beautifully written, of the lectures, bound up the manuscript in a quarto volume that revealed great skill in the bookbinder's craft, and sent the volume to Davy with a request for employment in his laboratory.

Meeting W. H. Pepys, one of the original managers of the Institution, Davy showed him Faraday's letter and said: "Pepys, what am I to do? here is a letter from a young man named Faraday; he has been attending my lectures, and wants me to give him employment at the Royal Institution—what can I do?" "Do," replied Pepys, "put him to wash bottles; if he is good for anything, he will do it directly, if he refuses, he is good for nothing." "No, no," said Davy, "we must try him with something better than that."

Davy's recommendation was made to the managers at their meeting on 18th March, 1813:

"Sir Humphry Davy has the honour to inform the managers that he has found a person who is desirous to occupy the situation in the Institution lately filled by William Payne. His name is Michael Faraday. He is a youth of 22 years of age. As far as Sir H. Davy has been able to observe or ascertain, he appears well fitted for the situation. His habits seem good, his disposition active and cheerful, and his manner intelligent. He is willing to engage himself on the same terms as given to Mr. Payne at the time of quitting the Institution."

"*Resolved.* That Michael Faraday be engaged to fill the situation lately occupied by Mr. Payne, on the same terms."

Faraday's appointment was made on 18th March, 1813. His duties were those of a laboratory assistant to the Professors and Lecturers of the Institution; he rigged up the apparatus required for their lectures, and dismantled, cleaned, and put it away afterwards. His wages were 25/- a week, with the use of two rooms at the top of the building. In a letter he wrote six months later, Faraday said:

"I am absent from home nearly day and night, but this I will explain to you. I was formerly a bookseller and binder but am now turned philosopher [this term was still in general use to describe a man of science, and Faraday hated the modern term *physicist*] which happened thus.—Whilst an apprentice, I, for amusement, learnt a little chemistry and other parts of philosophy, and felt an eager desire to proceed in that way further. After being a journeyman for six months under a disagreeable master, I gave up my business, and through the interest of a Sir H. Davy, obtained the situation of chemical assistant to the Royal Institution of Great Britain, in which office I now remain. I have lately had proposals made to me by Sir Humphry Davy to accompany him in his travels through Europe. If I go at all I expect it will be in October next."

Davy had planned a European tour and he asked Faraday to accompany him. Lady Davy and her maid were to complete the party. It was to be a journey of scientific inquiry through France, Germany, Switzerland, and Italy, and they were to take with them apparatus for their researches. Faraday gladly accepted the offer though his duties included everything from those of a secretary to those of a personal attendant. He was secretary, scientific collaborator, and valet, all in one. Such intimate relations with an energetic, versatile, original, and distinguished man like Davy, must have made a lasting impression and have exerted a profound influence on such a keen and eager young man as Faraday. The party embarked at Plymouth on 17th October, 1813, and on arriving in France were given a cordial welcome by the French. Considering the state of Europe at that time, such a welcome was hardly to be expected, and a special word from Napoleon himself—ever a shrewd man—may have been sent to Paris. The expedition proved to be of great value on both sides. Davy gave lectures and conducted researches, and he was brought into personal contact with the leading research-workers on the continent. Faraday was not slow to seize the opportunity of making the acquaintance of and conversing with such distinguished men as Ampère and Gay-Lussac, Cuvier and Humboldt, Volta and De la Rive. In this way he was richly compensated for the menial duties he was sometimes called upon to perform.

Brande had succeeded Davy as Professor of Chemistry in 1813 and held the chair until 1852, but Davy filled the office of Honorary Professor from 1813–23.

The Davy party returned to England in the spring of 1815. Faraday was re-engaged at the Royal Institution as “Assistant in the Laboratory and Mineralogical Collection, and Superintendent of apparatus.” His salary was increased to 30/- a week. He was then 23. During the next four years he advanced rapidly, and by 1819 he was fully occupied with laboratory work and scientific meetings and was taking pupils. Nothing that was being done at the Royal Institution

escaped him. Everything that others published about physics and chemistry he greedily read and absorbed. And with all this he pursued his own general education, especially with such subjects as "composition, reading, style, delivery, grammar, pronunciation, and perspicuity". In the laboratory his experimental skill was astonishing, and he showed great ingenuity in devising apparatus for new experimental needs. Although from time to time before 1820 he published scientific notes, he was at that time mostly learning, not originating. From about 1818-20 Faraday definitely assisted Brande in his lectures, "and so quietly, skilfully and modestly was his work done that Brande's vocation at the time was pronounced 'lecturing on velvet'". In 1820 Faraday read his first paper before the Royal Society.

In June, 1821, after his promotion to the position of Superintendent of the house and laboratory, he married Sarah Barnard, a girl of 21, the daughter of a Sandemanian Church elder, a silversmith. He obtained leave to bring his bride to his rooms at the top of the Royal Institution. Some small increase of accommodation was granted them, and here they lived for 46 years, both quite contented and happy. Their pleasures were of the simplest; half an hour in the evening at bagatelle, or a game of draughts (with pink and white lozenges and a ruled sheet of brown paper); occasional visits to the Zoo, especially to the monkey house; short sketching expeditions in the country; and so on. They would linger to watch a Punch and Judy show, and would spend a shilling on a visit to an acrobatic or gymnastic exhibition. Occasionally they would wander unobserved into the pit of a theatre. But their social circle gradually extended, and eventually included the leading musicians and artists. Turner and Landseer became Faraday's close personal friends.

It was after his marriage (he was then 30) that the serious work of his life began, and for 40 years he was engaged in research. He was appointed Director of the Laboratory in 1825, and he was thus free to devote a good deal of time to the kind of work he loved best. His salary was now £100.

When in 1835 the Fullerian Professorship was established, Faraday was appointed to the Chair, without any obligation to deliver lectures; and research thereafter engaged his whole attention. One of Faraday's first acts as Director was to organize Friday evening gatherings of the members of the Institution, and these soon developed into the weekly discourses which have been famous ever since. His courses of Christmas "juvenile" lectures became equally famous. His election to the Royal Society took place in 1824, though it was opposed by Davy who was then President. By this time Davy had become a little jealous of Faraday: he never warmly welcomed possible rivals on the steps of his throne. Davy had a markedly dual temperament: calm and scientific, irritable and poetic (he wrote excellent verse); and when the latter was in the ascendant, he was apt to be unreasonable.

Even to give a catalogue of Faraday's original investigations would take up more space than we can afford, and a brief summary must suffice.

1. *Electrical researches.* Magneto-electric induction: electricity derived from magnetism. Lines of magnetic force, their definite character and distribution. Laws of electrolysis, and electro-chemical equivalents. Electricity and light: magnetization of light. Diamagnetism. Identification of voltaic and frictional electricity. The specific inductive capacity of insulators. The famous ice-pail and wire-cage experiments. Electro-magnetic rotations. Source of power in the hydro-electric machine. The Gymnotus. There is also a multitude of papers on minor subjects. Only a trained physicist can appreciate the vast amount of work involved in these discoveries. We shall refer to the greatest of them in the next chapter.

2. *Chemical researches.* Liquefaction of gases. The isolation of benzene, the parent substance of tens of thousands of known organic compounds, including dyestuffs, pharmaceutical chemicals, and photographic developers. Candle, gas, and oil-flames: all produced by the combustion of hydrocarbons in the air. *The Chemical History of a Candle*

is a masterpiece of scientific method. *Chemical Manipulation*, a book of 600 pages, was the laboratory worker's handbook for decades. It should be remembered that in these days the bunsen burner and the Liebig condenser were unknown. Similarly, for his electric current, Faraday had to depend on ordinary batteries which had to be made up each day; the dynamo was a thing of the future.

3. *Optical glass*. Faraday manufactured a new glass of great refractive power. This involved the erection of melting and annealing furnaces at the Royal Institution. When he became scientific adviser to Trinity House, he performed many experiments bearing upon the modern lighting of light-houses, and designed new lens systems. Of course oil lamps were then used, and the smoke was a source of great trouble; it was Faraday who invented glass-chimneys for them.

4. *Alloys*. At that time there was no demand for alloy steels in engineering, but Faraday was concerned with better material for surgical and other instruments. He succeeded in making a large number of alloys. Weighed amounts of the different elements required to produce binary or ternary alloys were placed in a crucible and melted by a "blast furnace" consisting essentially of a coke-fire in an earthen pot; the intense heat required was maintained by means of a hand bellows. When satisfactory alloys were thus produced on a small scale, Faraday sent down instructions to Sheffield for the manufacture of ingots of 10 or 20 lb. weight. All this was done before Faraday was appointed Director in 1825, and the work did not attract very much attention. But 79 specimens, weighing altogether 7 lb. 14 oz., were placed by their maker in a small deal box and labelled "steel and alloys", in his own handwriting. They were stored away and remained, virtually forgotten, for more than 100 years. In preparation for the Faraday centenary of 1931, Sir Robert Hadfield obtained permission to subject a small portion of each of the 79 alloys to mechanical, physical, and chemical tests. The result astonished even that eminent metallurgist, who did not hesitate to pronounce Faraday the

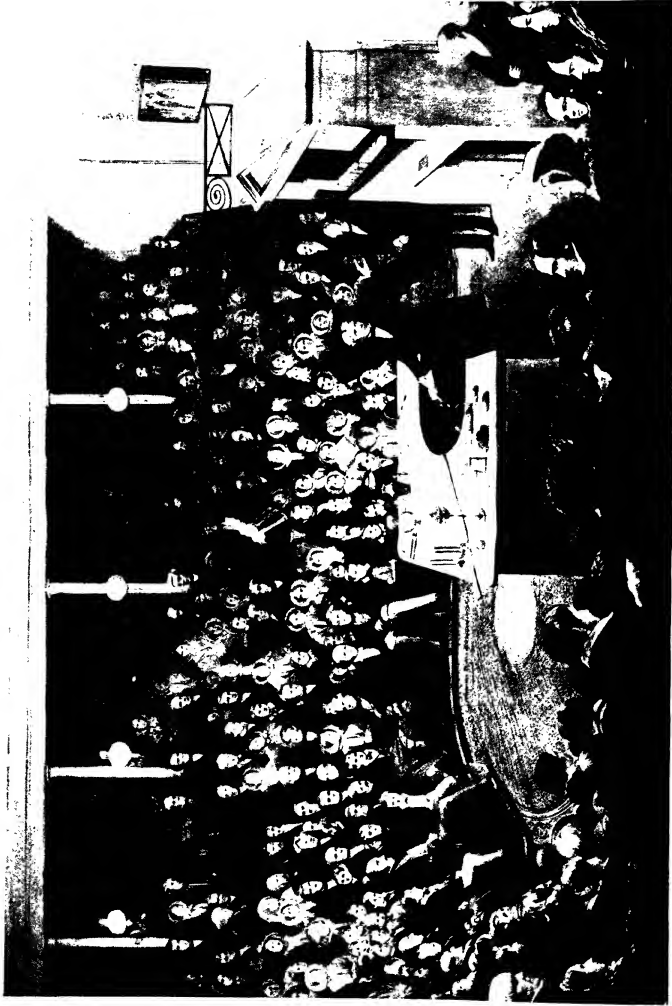

Faraday delivering a lecture at the Royal Institution, Christmas, 1855
By courtesy of the Authorities of the Royal Institution

pioneer of alloy steels. Faraday's systematic and comprehensive research had anticipated the work of metallurgists for nearly a century. What work they would have been saved had they known of the secrets of the old box stored away in the Royal Institution! How the progress of scientific metallurgy would have been accelerated! And Faraday was not only not yet Professor, he was not even Director. He was just a working assistant with very little time of his own.

When we consider the remarkable variety and the far-reaching importance of Faraday's contributions to science, we are impressed not only with his extraordinary industry and experimental skill but also with the unfailing originality of his mind in devising new methods of attack. As may be gathered clearly from his note-books, each day's work was carefully planned, and his hopes for the following day sometimes recorded.

At the beginning of a famous paper recording the discovery of a new relation between electricity and light, he makes the statement, often quoted: "I have long held an opinion, almost amounting to conviction, in common, I believe, with many other lovers of natural knowledge, that the various forms under which the forces of matter are made manifest have one common origin; or, in other words, are so directly related and mutually dependent that they are convertible, as it were, one into another, and possess equivalents of power in their action. . . . This strong persuasion extended to the power of light."—Faraday's researches show conclusively, in fact, that his underlying idea of the unity of all the forces in nature was the mainspring of all his principal investigations from the beginning of his scientific career. It is hardly too much to say that this conviction is the key to his extraordinary success in adding to knowledge. His general mental attitude may be illustrated by his remarks at the conclusion of his investigations on electrolysis:

"The harmony which this theory of the definite evolution and the equivalent definite action of electricity introduces into the associated theories of definite proportions and electro-

chemical affinity is very great. According to it, the equivalent weights of bodies are simply those quantities of them which contain equal quantities of electricity, or have naturally equal electric powers; it being the *Electricity* which *determines* the equivalent number, *because* it determines the combining force. Or, if we adopt the atomic theory or phraseology, then the atoms of bodies which are equivalents to each other in their ordinary chemical action have equal quantities of electricity naturally associated with them."

It was not, it is true, given to Faraday to understand the law of the conservation of energy in the whole of its simplicity and generality, the discovery of which (Mayer in 1842, Joule in 1843) came in the midst of his scientific work yet the general inter-relation of physical forces was a matter always in the forefront of his mind.

It is an interesting speculation whether Faraday, if, like Newton, he had gone to Cambridge, would have become a great mathematician. Faraday knew no mathematics, and yet he created independently and used with mastery a geometrical representation of forces, more especially lines of magnetic force (most readers when at school have probably made an attempt to map out these lines with iron filings). It was no scheme of symbols, such as is developed in algebra and mathematical analysis, but a pictorial representation of the real conditions of the thing itself. The forces operate in space, and the embodiment of their directions and intensities in Faraday's lines of force seems, in the case of electricity and magnetism, to be a direct representation of their true structure. This way of representing Nature's method of working was so entirely new and strange that Faraday's contemporaries completely failed to understand it: Airy, the astronomer-royal, openly scoffed at it. By great good chance a mathematical genius came along and not only silenced the critics but showed conclusively that Faraday had provided mathematicians for all time with a master key. This was **James Clerk Maxwell** (1831-79).

Airy and those who thought with him regarded the forces

between charges of electricity or magnetic poles as due to direct action at a distance, the space around these charges being just empty space and involving nothing but distance. On the other hand there was Faraday, a non-mathematician, inspired and guided by a completely different outlook and making discovery after discovery. To Faraday the charges at the poles were but the starting point of a series of lines—lines of force—spreading from them through the surrounding space. Faraday regarded the lines as something much more than geometrical lines; he supposed that they possessed definite physical properties, that, for example, they were in a state of tension.

Throughout his undergraduate career Maxwell was distinguished for preferring geometrical to analytical methods of solution. Mere symbols did not satisfy him; he liked to *visualize* spatial relations. When he heard of Faraday's lines of force, the geometry attracted him at once, and he began to put Faraday's ideas into a mathematical form. In fact, he translated Faraday's theory into a language intelligible to mathematicians. It was characteristic of Maxwell that he made models; he liked to consider concrete cases. Hence one of the first things he did was to construct a model to represent Faraday's magnetic field. The model consisted of a number of equal rotating cylinders, the axes of which were parallel to the magnetic force, and their velocity of rotation proportional to that force; the direction of the rotation determined the direction of the force. The cylinders were geared together in such a way that the working model accurately represented all Faraday's facts. The model did even more than this, it suggested that *changes* in an electric force must, even in an insulator, produce magnetic force. This is the essential feature of Maxwell's own theory and is of special interest as illustrating how a model designed to illustrate one phenomenon may suggest another. The model having done its work, Maxwell embodied the whole of the mathematical relations in a series of equations. These electromagnetic equations are not reproduced here as they appeal

only to trained mathematicians, but they are so all-embracing of the mathematical relations of magnetic and electric phenomena that Maxwell as a mathematician has always been ranked next to Newton himself. The present Master of Trinity, Sir J. J. Thomson, no mean judge, describes Maxwell's equations as the most important in the whole range of physical science.

Lines of electric force were introduced by Faraday to represent the state of electric and magnetic fields where the lines are at rest. When they are in motion they acquire new properties, and these new properties faithfully represent the new phenomena such as magneto-electric induction. This seems to be strong evidence of the fundamental character of the lines of force.

Of Maxwell's own general theory the most striking consequence is that changes in electric or magnetic force are propagated as *waves*. The velocity of propagation of these waves, as calculated from the values of purely electrical quantities, is the same as the velocity of light. This naturally suggested the theory that waves of light are waves of electric and magnetic force. Maxwell's theory did not, however, receive much support, and it was not until ten years after his death that direct evidence of the existence of electrical waves was obtained. The problem was first solved by Hertz in 1887.

Maxwell's own words may be quoted. "I have deduced the relation between the statical and dynamical measures of electricity and have shown by a comparison of the electromagnetic experiments of Kohlrausch and Weber with the velocity of light as found by Fizeau, that the elasticity of the magnetic medium in air is the same as that of the luminiferous medium, if these two co-existent, co-extensive, and equally elastic media are not rather one medium. . . . We can scarcely avoid the inference that light consists in the *transverse undulations* of the same medium which is the cause of electric and magnetic phenomena."

Maxwell was 40 years younger than Faraday, but they

became friends and collaborators. The one the "prince of experimenters", the other a great mathematician, they formed an ideal pair for the furtherance of electrical research. Faraday's discovery of magneto-electric induction gave the world its future large-scale electric supply; Maxwell's discovery of electric waves was destined to extend the range of human speech so that all the inhabitants of the world might be brought within hearing distance of one another. Both have had a profound influence on civilization.

Faraday was wont to deplore his "imperfect mathematical knowledge" and thought himself lucky to have for his interpreter such an outstanding mathematician as Maxwell. Yet there can be no doubt that, although an untrained mathematician, Faraday had a mathematical mind of a high order. How was it that he possessed such wonderful powers of insight into physical processes? This question admits of no answer. Heredity does not supply an explanation, for his forbears were very ordinary people showing no signs of intellectual eminence to be handed down to their descendants. Nor can an explanation be found in his nurture and education. At long intervals the world gives birth to a genius: and she gave us Faraday.

Faraday was a singularly modest man and never sought honours of any kind. Yet foreign monarchs conferred orders on him, universities showered degrees on him, and learned societies all over the world awarded him every medal they had the power to confer. Though pressed to become President of the Royal Society he refused. He likewise refused a Professorship of Chemistry in the University of London. He even refused the Presidency of the Royal Institution. He did, however, accept a lectureship in chemistry at the Royal Military Academy, Woolwich, and he became a sort of scientific adviser to various government departments, and was assigned a definite position as adviser to Trinity House. The calls upon his time, from home and abroad, asking for his guidance and help were innumerable. By 1831 he was making

an income of over £1000 from special fees of different kinds, and had he pleased he might soon have made an income of many times that amount. But he decided that the pursuit of wealth was not worth while, devoted himself almost entirely to research, for the most part gave up the fees, and was content with his small salary. He died a poor man.

Faraday was an intensely religious man. The Sandemanian sect to which he belonged were severe disciplinarians, and when on one occasion Faraday failed to attend the all-day Sunday service, in order that he might obey a command to lunch with Queen Victoria, he was excommunicated. However he continued his regular attendance, and later was re-admitted to membership.

Faraday's own Bible was a greatly treasured possession. He had bound it himself and with a craftsmanship so excellent that the pages are as firmly in their place to-day as when the work was finished. Faraday's written notes in it, of which there are about fifty, mostly concern cross-references; there are also nearly 3000 special signs, neatly pencilled in the margins of the pages, all reflecting in a very intimate manner Faraday's reaction to his reading. Two specially marked passages are, "The love of money is the root of all evil", and "avoid babbling and oppositions of science, falsely so-called."

To the world Faraday appeared the gentlest of men, but his friends knew, none better than his very intimate young friend and colleague, John Tyndall (1820-93), that beneath the gentle exterior reposed a volcano. Only once in all his married life did the volcano erupt before his wife. This was on Christmas Day, 1821. Faraday was working as usual in his laboratory in the basement when, unexpectedly, he succeeded in making a highly important experiment "work". (See the next chapter.) Excited almost beyond measure, he shouted up to Mrs. Faraday at the top of the house (the building is high, and presumably he ran part way up the stairs) where she, a six-months old bride, was cooking her first Christmas dinner, "Sarah, Sarah, come down at once

and see them dance." "I *can't* come; the goose would burn," was the reply. "Oh! *damn* the goose, come down and see them, I tell you." Mrs. Faraday went downstairs and her solemn face told her husband all too plainly of the dire effect of his first expletive. The experiment was forgotten, so was the burning goose, and the contrite husband did his best to placate the weeping wife, whose sensitive Sandemanian ears had been shocked by his unguarded Sandemanian tongue. Over a merry tea-table 30 years later they told this very human story to Tyndall,* and rather ruefully referred to that first Christmas dinner.

At the age of 70, Faraday's powers began to fail and, though he retained his Professorship till he died 6 years later, he did very little more work. His last illness has since been traced to mercury poisoning. He had been accustomed to use small cups of mercury for making electrical connexions, and during the course of years no doubt a good deal of spilt mercury had been trampled into the floor, there to prove an insidious source of trouble. Some 20 years before, the Government had granted him a pension of £300 a year, so that in his retirement he was fairly comfortable. He died at Hampton Court Green, in a house which had been given him by Queen Victoria.

"I could trust a fact but I always cross-examined an assertion." So said Faraday. It is a bit of wisdom that every true man of science lays to heart.

1. (Portrait of Michael Faraday, Plate 12).
2. (Faraday Lecturing, Plate 13).
3. (Page of Faraday's Diary, Plate 14).

* Tyndall returned from Marburg (where he had worked under Bunsen: he had obtained his doctorate for an essay on screw surfaces) in 1851, and the next year he was appointed Professor of Natural Philosophy at the Royal Institution, succeeding Faraday as superintendent in 1867. As a young man I knew Tyndall fairly well, and it was he who, about 1888 or 1889, gave me details of the Christmas Day story—F. W. W.

BOOKS FOR REFERENCE:

1. *Experimental Researches in Electricity*, 3 vols. M. Faraday.
2. *Faraday's Diary*, ed. T. Martin, 2 vols. of 7 now published.
3. *The Chemical History of a Candle*, M. Faraday.
4. *Chemical Manipulation*, M. Faraday.
5. *Faraday as a Discoverer*, J. Tyndall (rather sentimental).
6. *Life and Letters of Faraday*, Bence Jones (complete, but rather heavy).
7. *Life of Faraday*, J. H. Gladstone (a lively account of Faraday's vivid and eager personality).
8. *Life and Work of Faraday*, S. P. Thompson (the best account of Faraday's work).
9. *Electricity and Magnetism*, J. Clerk Maxwell.
10. *Life of James Clerk Maxwell*, Campbell and Garnett.
11. *Faraday Centenary Supplement*, "The Times".

Aug 29th 1831.

1 Effects on the production of Electricity from Magnets etc
 2 There had an iron wire (soft iron), was some ¹⁰ inches
 thick of my 6 inches in external diameter. Wound around
 coils of copper wire some are half the coils being separate
 to some fabric there were 3 lengths of wire each about 24
 feet long and they could be united as one length or used
 as separate lengths by hook with a branch each was
 connected from the other till call the side of the ring
 A. on the other side set separate by an
 interval was wound wire in two pieces
 together amounting to about 60 feet in
 length the description being as with the former
 wire this side call B

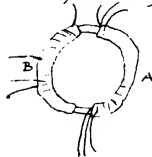

3 Changed a battery of 10 ft plates which appeared made
 the coil on B side one coil wire connected at other end by
 a copper wire passing to a distance, was just over a magnet
 north (1 ft from wire away) then connected the ends of one of the
 pieces on A side with battery immediately a visible effect or visible
 oscillations of needle at bit unorganized for bar. On breaking
 connection of A side with battery again a disturbance
 of the needle.

4 Made all the wires on A side one coil and sent one
 end from battery through the whole. Effect much much
 stronger than before.

5 The effect of the needle there had a very small part of
 that which the wire communicated directly with the battery
 would produce.

A Page of Faraday's Diary recording discovery of Electro-magnetic Induction
 By courtesy of the Authorities of the Royal Institution

CHAPTER XXXV

Faraday's Famous Experiments of 1821 and 1831

It will be remembered that Oersted stumbled on the principle that a current of electricity had magnetic properties and was virtually equivalent to a magnet; that Ampère went further and showed that two wires carrying electric currents could exert a mutual force on each other. Arago and Davy also showed, independently, that a wire carrying an electric current could magnetize steel and iron, and Ampère pointed out that the amount of deflection of a magnet could be used to measure the strength of the current which caused it. This was in 1820, and the subject occupied the thoughts of all men of science, who felt that there were important discoveries still to be made.

In this country, Wollaston, knowing that there was a *tendency* for a magnetic pole to rotate round a wire carrying a current, argued that, since action and reaction are equal and opposite, there ought to be an equal *tendency* for a conductor carrying a current to rotate round a magnetic pole. In the early part of 1821, he put this idea to the test of experiment in the presence of Davy and Faraday at the Royal Institution. He failed. But the observant Faraday was quick to grasp the significance of the attempt. He read up the subject carefully, and became convinced that the magnetic force acting transversely to a wire carrying a current *would actually cause a magnetic pole to move round the wire*, provided that one end of the magnet was free to move; it therefore followed, he argued, that since a magnetic pole would thus rotate round a current,

a wire carrying a current ought to move round a magnetic pole, provided the wire were free to move. But how to arrange the necessary experiment? Fig. 70 is a diagrammatic sketch of the apparatus he finally designed.

A is a battery, B and C are two glass bowls of mercury (a good conductor), E E' is a wire supported by a wooden rod R, with one end fixed and dipping into the mercury in B, the other end pivoted and free to rotate at *m*, and dipping into

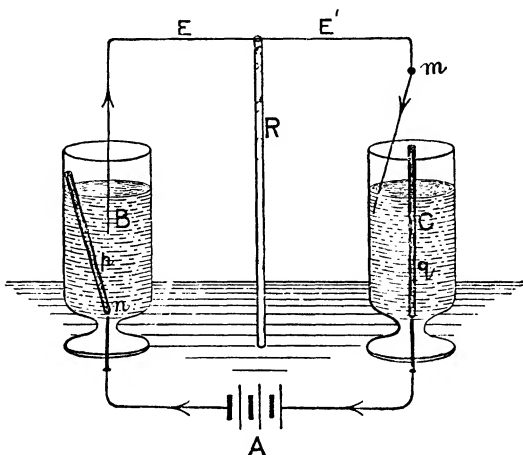

Fig. 70.—Faraday's Infant Motor

the mercury in C; *p* and *q* are two magnets, *q* being fixed but *p* being pivoted and free to rotate at *n*. The mercury serves to complete the circuit. When the current is turned on, the free pole of the pivoted magnet in the left-hand jar rotates round the fixed wire, and the pivoted part of the wire below *m*, dipping into the right hand jar, rotates round the fixed magnet though in the opposite direction. This is the famous Christmas Day experiment of 1821, when Faraday called up to Mrs. Faraday, "Come and see them dance". He had made what in fact was the first electric *motor*, by which electrical power is reconverted into mechanical motion. Wol-
laston was angry that he had been forestalled in this way.

Faraday celebrated his success by taking his wife to the theatre where, sitting on a hard and backless bench in the pit, the burnt goose and the swear-word were no doubt forgotten.

But Faraday's infant *dynamo* was not born for another ten years.

“ One of the most precious recoveries from the literature of antiquity is the *Method* of Archimedes, discovered in Constantinople in 1906, for it allows the modern scholar to study the theorems of Archimedes, not in the statuesque simplicity with which he presented them to the world, beautiful but cold, but as he hewed them out of his rough material, still glowing from his touch. It is for the same reason that the *Diary*, or laboratory note-book, of Faraday is one of the most valuable documents of science.” Upon his death, Faraday bequeathed to the Royal Institution two quarto and eight folio volumes, containing more than 4000 closely written pages, recording the experiments and observations made by him during the 42 years from 1820-62. These volumes, admirably edited by the general secretary of the Royal Institution, Mr. Thomas Martin, are now being published, and the whole of “ this most priceless possession of the Royal Institution ” will soon be in our hands.

All of us interested in science have long treasured our copies of Faraday's *Researches*, but these old volumes must not be confused with the *Diary*. The *Diary* is the day-by-day record of work done, and includes failures as well as successes in a sequence exactly as they happened. In his *Experimental Researches*, Faraday deliberately altered the order of his procedure, on the principle, “ These results I propose describing, not as they were obtained, but in such a manner as to give the most concise view of the whole.” The *Researches* represent his discoveries in a form suitable for delivering as lectures, or for reading before a learned Society.

The first volume of the *Diary*, like the first volume of the *Researches*, recounts Faraday's greatest claim to fame—

his induction of an electric current from magnetism, 29th August, 1831. It is of supreme interest to watch Faraday picking his way slowly through a trackless jungle to a goal of whose existence he was sure but which eluded him for 11 years.

One brief quotation from the *Diary* must suffice:

“28th Novr., 1825: Experiments on induction by connecting wire of voltaic battery. A battery of four troughs, ten pairs of plates each, arranged side by side.

“*Expt. I.* The poles connected by a wire about 4 feet long, parallel to which was another similar wire separated from it only by two thicknesses of paper. The ends of the latter were attached to a galvanometer—exhibited no action.

“*Expt. II.* The battery poles connected by a silked helix—a straight wire passed through it and its ends connected with the galvanometer—no effect.

“*Expt. III.* The battery poles connected by a straight wire over which was a helix, its ends being connected with the galvanometer—no effect.

“Could not in any way render any induction evident from the connecting wire.”

It will be observed that this is a record of *failures*. It was another six years before Faraday succeeded in this particular research, and to that success we now come.

When it had been established in 1820 that an electric current had a magnetic effect, this naturally led to the search for a reciprocal action—*ought not a magnet to have an electric effect?* If an electric current could develop a magnet where before there was none, *might we not expect a magnet to call into existence an electric current?* Or reciprocity might be looked for in a way rather different in form but equivalent in meaning. For instance, a magnet by mere proximity induces magnetism in a piece of iron; since electric currents behave like magnets, ought not one wire carrying a current to induce a current to run in a neighbouring wire by a similar proximity? It was this particular plan of mere proximity which Faraday tried in 1825, as recorded in his *Diary* and

quoted above. He expected a current to be set running in one wire by the mere proximity of a current running in the other. His failure puzzled him, for his experiments seemed to be a mere repetition of the alphabet of electrical science; they were exactly analogous to the usual induction experiments in magnetism and in frictional electricity.

He renewed his investigations in 1831, and these are recorded in the first volume of his *Electrical Researches*.

The first section is headed **Induction of Electric Currents**, and he began his new series of experiments with two insulated copper wires, each 155 feet long, which he wound into helices concentrically round the same wooden cylinder. One of these wires he connected with a voltaic battery of 10 cells, and the other with a sensitive galvanometer. When the connexion was made, and while the current flowed, the galvanometer showed no effect whatever. He then repeated the experiment, using coils of copper wire, each 203 feet in length, and a "well-charged" battery of 100 cells. "When the contact was made, there was a sudden and very slight effect at the galvanometer, and there was also a similar slight effect when the contact with the battery was broken. But while the voltaic current was continuing to pass through the one helix, no galvanometrical appearances nor any effect like induction upon the other helix could be perceived, although the active power of the battery was proved to be great, by the heating of the whole of its own helix, and by the brilliancy of the discharge when made through charcoal" (§ 10)*. The experiment was repeated with 120 cells, with exactly the same results. In both experiments it was noticed that "the slight deflection of the needle occurring at the moment of completing the connexion was always in one direction, and that the equally slight deflection produced when the contact was broken, was in the other direction" (§ 11).

What Faraday *expected* was to find an effect "while the current *flowed*", but there was no such effect, and most

* The numbered paragraphs refer to Faraday's *Researches*.

workers would probably have arrived at once at a definitely negative conclusion. Not so Faraday. He was ever on the look-out for even the slightest effects, and his keen eye caught sight of a very slight "kick" of the galvanometer needle, only just perceptible, at the very moment when the current connexion was made and again when it was broken. This almost imperceptible kick proved to be the key of the whole thing, the key to the future dynamo, the key to modern electrical engineering.

The result of this and other experiments led Faraday to the definite conclusion that the battery current through the one wire did in reality induce a current through the other, but that it lasted for an instant only, "and partook more of the nature of an electric wave from a common Leyden jar than of the current from a voltaic battery" (§ 12). The momentary currents thus generated were called *induced* currents, while the battery current which generated them was called the inducing current. It was immediately proved that the induced current generated at *making* the circuit was always opposed in direction to its inducing generator, while that developed on the *breaking* of the circuit coincided in direction with the inducing generator. As Tyndall put it, it was just as if the inducing battery-current on its first rush through the primary wire sought a fulcrum in the secondary one, and, by a kind of kick, drove backward through the latter an electric wave which subsided as soon as the primary current was fully established; and as if, when the circuit was broken, the battery current, in its last rush through the primary wire, set up in the secondary wire another electric wave which it dragged after itself in its own direction, itself dying a minute fraction of a second before the wave it had thus created died.*

The second section of the first volume of *Researches* is

* The word "induction" is not a very happy term. It does not, of course, in any way connote its much commoner meaning of the drawing of a special kind of logical inference, or of installation into a benefice. Rather, it means, specifically, to call forth similar properties in another body, or to cause similar properties to be created in another body.

headed **Evolution of Electricity from Magnetism**, and this brings us to Faraday's famous experiment of 29th August, 1831.

Faraday was quite familiar with the art of blacksmithing, and he took a piece of soft round bar-iron, about 20" in length, and turned it into a ring, welding its ends together. In thickness the ring was $\frac{7}{8}$ ", and in external diameter, 6". On the one half of the ring he wound 72 feet of insulated copper wire, and on the other half 60 feet. The coils had "the same common direction", and they were separated from each other by half inches of uncovered iron (§ 27). The original wire-covered ring is still preserved by the Royal

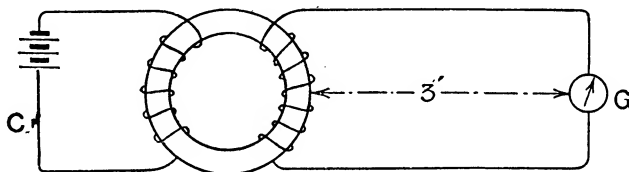

Fig. 71

Institution. Fig. 71 is a diagrammatic sketch of the ring, the coils, and the connexions.

Faraday linked up one coil to a galvanometer 3 feet away, and the other to a battery of 10 cells. "The galvanometer was immediately affected and to a degree far beyond" that when coils without iron were used with a battery ten times as powerful. But though the contact was continued, the effect was not permanent, and "the needle soon came to rest in its natural position, as if quite indifferent to the electromagnetic arrangement." Upon breaking the circuit (C in fig.), the needle was again powerfully deflected, but in the contrary direction (§ 28). Upon using a battery of 100 cells, "the impulse at the galvanometer when contact was completed or broken was so great as to make the needle spin round rapidly four or five times, before the air and terrestrial magnetism could reduce its motion to mere oscillation." (§ 31). "No making or breaking of the contact in any part

of the galvanometer circuit produced any effect at the galvanometer" (§ 30).

By using charcoal at the ends of the coil connected with the galvanometer, a minute spark could be perceived when the contact of the battery circuit was completed. This spark could not be due to any diversion of a part of the current of the battery through the iron to the coil connected with the galvanometer, for when the battery contact was continued, the galvanometer still resumed its perfectly indifferent state" (§ 32).

Faraday knew from the work of his contemporaries and predecessors, Arago and others, that the coil from the battery must be magnetizing the iron ring. Was he yet justified in assuming that *this magnetism was inducing electricity in the coil* connected with the galvanometer.

He now wound two coils, each 110 feet long, round a pasteboard tube, much as he had wound them round a wooden cylinder when he was devising an experiment for the "Induction of Electric currents." A battery of 100 cells was discharged through the one coil, but the effect on the other coil, which was linked up with the galvanometer in the usual way, "was hardly sensible". Faraday now took a soft-iron round bar, $\frac{7}{8}$ " thick, and 12" long, and introduced it suddenly into the pasteboard tube. At once the galvanometer was affected powerfully (§ 34). When the iron was replaced by a similar bar of copper, there was no effect beyond that of the coils alone (§ 35).

The inference was almost irresistible that the battery-current had turned the iron bar into a magnet, and that this magnet was inducing—creating—electricity in the coil connected with the galvanometer. If this were so, why not dispense with the battery altogether, and induce electricity by means of *ordinary magnets*?

Faraday now wound a coil of 220 feet round a short pasteboard cylinder, and a soft iron cylinder was introduced into the axis. Two copper wires, each 5 feet in length connected the coil to the galvanometer. "Two bar magnets,

each 24 inches long, were arranged with their opposite poles N and S in contact, so as to represent a horse-shoe magnet, and then contact made with the other poles and the ends of the iron cylinder, so as to convert it for the time into a magnet. By breaking the magnetic contacts or reversing them, the magnetism of the iron cylinder could be destroyed or reversed at pleasure" (§ 36). (Fig. 72.) (It should be observed that **no battery** is used in this experiment.)

"Upon making magnetic contact, the needle was deflected; continuing the contact, the needle became indifferent, and resumed its first position. On breaking the contact, it was again deflected, but in the opposite direction, and then again it became indifferent. When the magnetic contacts were reversed, the deflections were reversed" (§ 37).



Fig. 72

"But as it might be supposed that, in all the preceding experiments, it was by some peculiar effect taking place during the formation of the magnet, and not by its mere virtual approximation that the momentary induced current was excited," Faraday devised the following experiment. On his larger pasteboard cylinder he wound a coil of 220 feet, and connected it up with a galvanometer. Into this coil he suddenly thrust an *ordinary cylindrical magnet* ($8\frac{1}{2}'' \times \frac{3}{4}''$). "Immediately the needle was deflected in the same direction as if the magnet had been formed by either of the two preceding processes. Being left in, the needle resumed its first position, and then the magnet being withdrawn the needle was deflected in the "opposite direction" (§ 39). Fig. 73 shows a modern form of apparatus used for the same experiment.

Faraday's next paragraph (§ 40) shows the care he took in describing the details of his experiments. "In this experiment the magnet must not be passed entirely through the coil, for then a second action occurs. When the magnet

is introduced, the needle at the galvanometer is deflected in a certain direction; but being in, whether it is pushed quite through or withdrawn, the needle is deflected in a direction the reverse of that previously produced. When the magnet is passed in and through at one continuous motion, the needle moves one way, is then suddenly stopped, and finally moves the other way."

Faraday was able to produce striking confirmatory effects of these experiments by using a powerful compound magnet

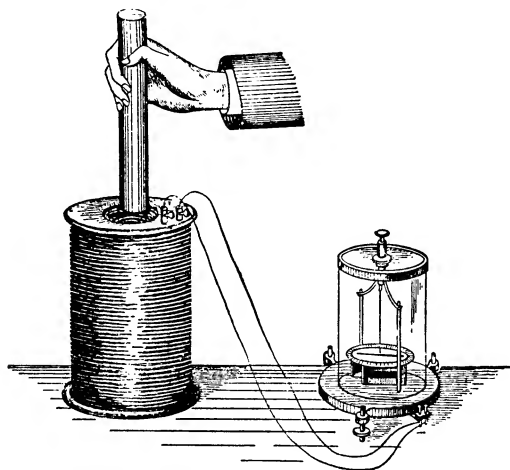

Fig. 73

in the possession of the Royal Society, composed of 450 bar magnets, each $15'' \times 1'' \times \frac{1}{2}''$ (§ 44).

Faraday thus concluded his investigation: "The various experiments prove, I think, most completely the production of electricity from ordinary magnetism. That its intensity should be feeble and its quantity small cannot be considered wonderful, when it is remembered that it is evolved entirely within the substance of metals retaining all their conducting power. But an agent which is conducted along metal wires in the manner described; which, while so passing, possesses the peculiar magnetic actions and force of a current of electricity;

which can agitate and convulse the limbs of a frog; and which, finally, can discharge a spark by its discharge through charcoal, can only be electricity (§ 57).

“ The similarity of action, almost amounting to identity between common magnets and either electro-magnets or volta-electric currents is strikingly in accordance with and confirmatory of M. Ampère’s theory, and furnished powerful reasons for believing that the action is the same in both cases; but as a distinction in language is still necessary I propose to call the agency thus exerted by ordinary magnets, *magneto-electric* induction ” (§ 58).

It is worth while recording that Faraday devised a final and conclusive experiment which enabled him to produce a continuous or uninterrupted current merely by the motion of a conductor between the poles of a magnet. He mounted a circular copper disc on an axis like a grindstone, and he applied two flexible pieces of metal to touch respectively the outer edge and the axis of the disc. These “ brushes ”, as we now call them, were connected by wires to the galvanometer, and the disc was placed with part of its area between the poles of a horse-shoe magnet in order that it might be traversed by the lines of force. When the disc was rotated, a continuous current flowed through the galvanometer. Thus Faraday produced a machine—he called it the magneto-electric machine, which is the parent of every dynamo machine yet made (fig. 74).

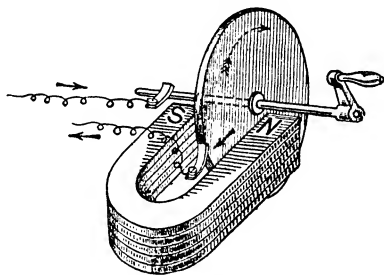

Fig. 74

The full significance of Faraday’s experiment with the iron ring on 29th August, 1831 (he had made what in these days we should call a closed transformer) ought now to be realized. When he sent the current from the battery through one of the coils in the ring, he *magnetized* the ring. This he

well knew from the work of Oersted, Ampère, and Arago. The magnetized ring passed through the second coil that was connected up with the galvanometer. *During* this magnetization *but only then*, and not when the magnetization was complete, there was an electric current in this second coil. It was not magnetism itself but *changing* magnetism that gave the looked-for reciprocity. So also when the battery connexion was broken, and the magnetism disappeared again, this change also produced its effect; there was again current in the second wire in the reverse direction.

Of course Faraday had discovered only the fundamental principle, and years of further work were required before he could establish its full significance.

It will be observed that the discovered reciprocity between electricity and magnetism was not of the expected kind. The argument had run that, since a wire carrying an electric current, when placed near a piece of iron, generated magnetism in the iron, *therefore* a magnet placed near a wire should generate electricity in the wire. The true reciprocity lay in this, that *moving electricity* (i.e. an electric current) had a magnetic effect, and that *moving magnetism* had an electric effect. *Motion* was essential in each case. The required motion is relative only; a magnet may be moved with respect to a stationary conductor, or a conductor moved with respect to a stationary magnet. In either case the result is a tendency to move electricity in the conductor. More comprehensively it may be said that changing magnetization tends to set electricity in motion.

The interplay of electricity and magnetism is a fundamental action of the universe. In a very direct form this action manifests itself as light and heat and radiation of all kinds. In another form it appears as chemical affinity governing all the material processes of nature, animate and inanimate. The physical properties of materials depend on it. Guided by it, the pioneer makes his way through the strange regions of modern physics, and the electrical engineer plans and constructs invention upon invention. But for the

gifted Faraday, with his primitive batteries and rough-and-ready equipment, we might still be where we were a century ago. Faraday taught us how amazingly simple it is to make electricity—*merely by moving magnetism*.

A brief reference may be made to the Dynamo. By means of sprinkled iron filings and by means of a small magnetic needle, Faraday was able to form a vivid mental picture of magnetic and electric "fields", and his "lines of force" have ever since that time served to show very clearly the direction and the intensity of the force acting in the medium between the charged bodies. In Faraday's experiment of inducing an electric current by means of a moving magnet, or, in popular parlance, of "making electricity out of magnetism", the essential thing was that the coil should cut *across* the lines of force due to the magnet. If the coil merely moved *along* the lines of force, no effect was produced. *Motion* was necessary, but whether the magnet was moved relative to the coil, or whether the coil was moved relatively to the magnet did not matter at all. A current was set up provided that the coil cut across the lines of force due to the magnet. The important thing was the constant variation of the number of lines of force passing through the conducting coil. The mechanical energy expended in causing the motion is really converted into electrical energy, the magnetic field acting as a converter. But, as we saw in the case of Faraday's primitive apparatus the currents produced are only momentary, and the successive currents are alternate in direction. Hence, to obtain a constant succession of currents, *either* the conducting coil, *or* the magnet must be continually in motion. Within a year or two after Faraday's discovery, inventors set to work, and, at first, bobbins of insulated wire were fixed to an axis and spun rapidly in front of or between the poles of strong steel magnets. But since the currents thus generated were alternately direct and inverse currents, a *commutator* which rotated with the coils was fixed to the axis to turn the successive currents all in the same direction. Figure 75 illustrates a plan adopted in 1836. A split tube of copper

commutes the connexion to the outer circuit at each half turn. The wire coil spins round a longitudinal axis, the upper portion coming towards the observer. The arrows show the direction of the induced currents delivered by the commutator to the contact springs (brushes) and thence to the collecting wire.

The reader should call at a local generating station and ask the engineer to show him round. He will learn more in ten minutes than he could learn from books in ten hours. The machinery will seem very complicated, so indeed it is. But it all reduces to a system of magnets (field-magnets, usually fixed), and coils (armatures, usually rotating).

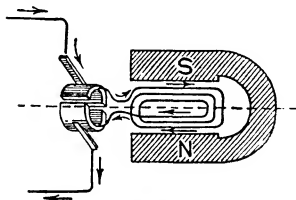

Fig. 75

The interesting feature of such a station is that, in spite of the extraordinary developments in electrical engineering in recent years, Faraday's magnet and coil of 1831 are still basic and fundamental. All the elaborate complexity of the generating station is just the outcome of a century of developments of that single basic principle.

Faraday himself was less interested in the technical developments and applications of the great principles he discovered than in pure science. What he sowed others reaped. And yet he would certainly be delighted with the utilitarian benefits that have followed on his labours, for he was always alive to the applications of science to practice; some of his works, such as that on steel alloys, and glass, were specifically directed to the improvement of materials used in technical processes. But above all he was a natural philosopher, the abiding purpose of whose life was to penetrate the mysteries of nature and to understand her workings; or, as Virgil put it, *rerum cognoscere causas*. To Faraday as to Bacon "works themselves are of greater value as pledges of truth than as contributing to the comforts of life."

Faraday's range was astounding, extending over the whole

gamut of the physical sciences, and there is scarcely one of them to which he did not make some notable contribution. If he had not made the discovery of magneto-electric induction, and no one else had made it, the world to-day would have been without any of the applications that depend on heavy currents generated by magneto-electric machinery—no general illumination by the electric light, no electric traction, no electrically driven factories, no electric furnaces, no electro-chemical industries. How amazingly the world may be indebted to the genius of a single man!

Joseph Henry (1797–1878) was an American physicist whose life was in many respects similar to that of Faraday. He was born in Albany, New York, of humble parentage. Like Faraday he was apprenticed to a trade and became interested in science by reading a text-book that fell into his hands. By great self-denial he attended classes at Albany Academy where in 1820 he was appointed Professor.

There is no doubt that in August 1831 he was busy with experiments on electro-magnetism and hoped to solve the problem that Faraday solved. Too busy at the time to pursue his research, he threw it aside. Later he said, "How could I know that another on the other side of the Atlantic was busy with the same thing?" Though he always ascribed the discovery to Faraday, there is little doubt that a short time before the discovery was made he was on the verge of making it himself. Henry certainly had a very great reputation as an American physicist during the middle half of the 19th century.

BOOKS FOR REFERENCE:

See the list at the end of the last chapter.

Reference may specially be made to the *Faraday Centenary Number of The Times*, particularly the Articles by Lord Rutherford, Sir J. J. Thomson, Sir William Bragg, Sir Oliver Lodge, Professor Wilhelm Ostwald, Sir Robert Hadfield, Sir Ambrose Fleming, Professor Debye, the Marchese Marconi, Sir Richard Gregory, Sir Robert Robertson, Professor Donnan, Professor Miles Walker, Professor Zeeman.

CHAPTER XXXVI

The Transition from the Older to the Newer Physics

The older attempts to frame a theory of the nature of that part of the material universe which could be explored by observation and experiment, and of which the underlying laws were sufficiently understood to be amenable to mathematical calculation, were signified by the general term "Natural Philosophy". Biology was excluded from its purview, for the nature of life was too little known or understood to be amenable to treatment of that thorough kind. The branch of natural philosophy that advanced most rapidly towards completeness was the mechanics of the solar system, in which the bodies considered were comparatively few and far apart and could readily be dealt with individually; the laws governing their movements could therefore be framed fairly readily and correctly. Under Newton this branch was so far perfected that its thoroughness and completeness set a standard for other branches to follow. After all, astronomy was only a special case of the motion of material bodies, and Galileo had already begun the study of the motions of bodies on the earth's surface. Newton's famous laws of motion were so fundamental and universal in character that they dominated every branch of physics for the greater part of two centuries.

If the reader will examine any standard textbook of physics published in the later part of the nineteenth century, he will find the contents marked off into definitely differentiated branches of study: Mechanics (Statics and Dynamics),



JOHN DALTON
After Lonsdale



SIR HUMPHRY DAVY
National Portrait Gallery



CLERK MAXWELL
*From the portrait by Lowes Dickinson
(Trinity College, Cambridge)*

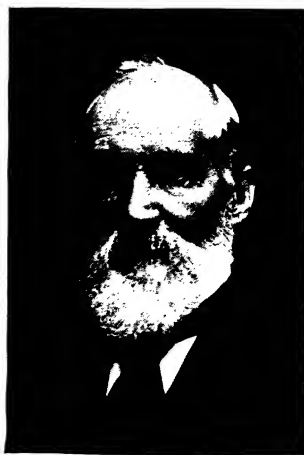

KELVIN
From a photograph by Annan

Sound, Light, Heat, Magnetism, Electricity, in addition to a number of subsidiary topics such as Gravitation, Elasticity, Surface Tension, Capillarity, Viscosity, and Diffusion. Of these, Statics and Dynamics are the most basic; they represent the fundamentals to which all the other branches are, from the point of view of measurements, ultimately reducible. Of the others, we are brought into immediate contact with Sound through the sense of hearing; with Light, through the sense of sight; with Heat, through the sense of touch. All bodies are subject to internal vibrations, and for the apprehension of these vibrations we have the special sense organs, the ear, the eye, and the skin. Unfortunately we have no special electrical sense. Our sense-organs are not, however, refined enough to be of much use to us in experimental physics, and we use them mainly for noting coincidences, for instance of a galvanometer pointer with a mark on a graduated scale. It has been aptly said that a physicist's main work is pointer-reading. The human eye is a poor thing: it can see neither very distant objects nor very small objects, and without the aid of optical instruments it could make little headway in physical research.

Even in the time of Newton a feeling arose that the dividing lines between the different branches of physics were probably rather artificial. Newton himself discovered the great law of gravitational attraction; the fall of the moon and the fall of an ordinary stone were shown to be due to precisely the same cause: the same dynamical laws applied to the members of the solar system as to bodies on the earth's surface. Since the time of Oersted, Ampère, and Faraday, magnetism and electricity have been known to be merely different aspects of the same ultimate phenomenon. About the middle of the last century, the mechanical equivalent of heat had been measured, and the kinetic theory of gases had been carefully studied; it therefore became clear that heat was a manifestation of moving particles, and that there was a close link between heat and mechanics. Maxwell showed that light waves were electro-magnetic in character, and that

therefore there was a close relation between light and electricity and magnetism. And it has long been known that sound is an affair partly of disturbed particles, partly of waves. Clearly, then, the old barriers between the different branches of physics have largely broken down.

But there still seems to be a barrier between mechanics, heat, and sound on the one hand, and, on the other, light, electricity and magnetism. The former subjects seem to be concerned mainly with *particles*, the latter with *waves*; the former seem to comprise phenomena associated with material things, the latter seem to be concerned with the transmission of energy across a vast space which seems to our senses to be utterly devoid of matter of any kind. Present day physicists are all engaged in the attempted demolition of the barrier between particles and waves. Material particles are necessarily *discontinuous*; waves are necessarily *continuous*. Is the gulf between them impassable?

The fusion of a particle and a wave into a single entity seems to be inconceivable, and yet physicists are convinced that it is this very fusion which will form the next great advance in physics. In the light of former discoveries it is dangerous to pronounce a thing as "inconceivable"; it is much safer to say it is "not yet conceivable". Again and again in the history of physics new facts have given rise to new conceptions which previously would have been pronounced absurd. Again and again such new conceptions have met with open hostility, and yet they have ultimately displaced others that had long held the field. All hypotheses are provisional; they are constructed to embrace known facts. If they are found to cover still newer facts, they survive; if they do not, they are superseded.

It may be asked, *why* are physicists attempting to fuse the particle and the wave? The answer is that they have no alternative. For instance, in the case of light the phenomena of interference, diffraction, and polarization afford irrefutable evidence that light is a wave-motion; but there are other facts, equally indisputable, that simply cannot be explained

by the wave theory, the effects pointing clearly to the presence of moving particles. Two phenomena discovered in recent times (the photo-electric effect and the Compton effect) seem incapable of explanation unless we assume the existence of particles of radiation.

Almost down to the present century the main task of physics was considered to be the *description* of natural phenomena and the summarizing of discovered facts in the form of laws. But it is now assuming a much greater task—that of giving an *explanation* of the phenomena, in terms of the ultimate particles which constitute the material world. It is attempting to discover the innermost mechanism of these particles, and thus to give a final and satisfactory explanation of all derivative phenomena.

Before the reader can profitably consider the problems of modern physics, there are certain aspects of the older physics which he should revise. We will therefore briefly touch upon:

1. The physicist as a mathematician.
2. Wave motion.
3. Light: wave and emission theories.
4. Spectroscopy.
5. Thermodynamics.

The first section deals with a subject which some people dislike, but it must be read if an increasingly important aspect of present-day physics is to be intelligently appreciated.

1. The Physicist as a Mathematician.

One of the most respected of our older living physicists, Professor **Schuster** (b. 1851), wrote (*Theory of Optics*) in 1904, "Those who believe in the possibility of a mechanical conception of the universe and are not willing to abandon the methods which from the time of Galileo and Newton have uniformly and exclusively led to success, must look with the gravest concern on a growing school of scientific thought which rests content with equations correctly repre-

senting numerical relationships between different phenomena, even though no precise meaning can be attached to the symbols used."

We will refer to this very pertinent criticism at the end of the section. Meanwhile, the reader may try to satisfy himself that *measurement* is the very essence of nearly all work in physics and that therefore mathematics is an essential part of the subject. Inasmuch as, however, this book is not intended for the trained mathematician, we will keep our remarks within the range of the mathematical work done by the reader when at school.

One of the first things a physicist wants to do is to compare similar substances from the point of view of some particular property, for instance, their "relative densities" or "specific gravities". By weighing equal volumes, perhaps specially prepared cubes or spheres of the substances, and comparing their weights with the weight of an equal volume of some standard substance, say water, he has the data for preparing a useful table. Strictly, the specific gravity of a substance is the *ratio* between the weight of a given volume of the substance and an equal volume of the standard substance, but by calling the weight of the volume of the standard substance, 1, the specific gravity of the given substance may be looked upon as a mere number; for instance, the S.G. of zinc is 7, i.e. it is 7 times as heavy as water, volume for volume; the S.G. of iron is 8; of copper, 9; of lead, 11; of gold, 19; and so on. Again: the physicist often wishes to compare the "capacities" of different substances for heat. Some substances take in and give out heat more readily than other substances. It takes much more heat to raise a pound of water to, say 100° C. than it does a pound of any given metal. "Specific heat" is the ratio of the two quantities of heat which would raise equal weights of a given substance and of cold water through the same difference of temperature. By assigning unity to the water, the specific heat of the given substance becomes a mere number and this special or specific number is the number that the physicist memorizes. The

specific heat of iron is about $\cdot 1$; of silver, $\cdot 05$; of mercury, $\cdot 03$. The fact that the specific heat of mercury is low is useful to the physicist, who knows, for instance, that a thread of mercury in a tube of fine bore will readily and quickly indicate a temperature difference. In electricity, also, we have "specific inductive capacities", again, in practice, a series of special or specific numbers attached to different substances. The special significance of all such numbers, the physicist carefully bears in mind.

Other series of special numbers are called *coefficients*. Thus we have coefficients of expansion, of friction, of elasticity. A bar of iron 1 unit in length (foot or metre, for instance) at 0° C. and heated to 1° C. would become $1\cdot 00001$ units in length, i.e. it would increase $\cdot 00001$ of its original length, and there would be very approximately the same amount of increase in length for every further degree of heating up to 100° . Such an increase of length is fairly constant for the same substance, but is different for different substances. It is known as the "coefficient" of (linear) expansion.

Such special numbers, indicating the measured relative values of particular qualities of substances, are the very stock-in-trade of the physicist. Usually he accepts them as determined by his predecessors, but sometimes he feels dissatisfied with some generally accepted result and undertakes the usually rather formidable task of making an accurate determination for himself. In his well-known "*C.G.S. System of Units*", Everett gives no less than 12 different results of the experimental determinations of the velocity of sound in air, all by eminent authorities, British and foreign, the results varying from $330\cdot 7$ to $333\cdot 7$ metres per second. Rough determinations are one thing; they can often be carried out by schoolboys. Accurate determinations, on the other hand, usually call for the highest experimental skill.

To the non-mathematician the mathematical formulæ which will be met with on almost every page of a textbook

in physics may be a little repellent, but the great majority of such formulæ are really very easy to unravel, to follow out, and to understand, and unless they *are* followed out and understood the rigour of the physicist's reasoning will be lost. The necessary work is really very simple: it is merely the translation of algebraic language into arithmetical language. Guided by the algebraic formula, a particular case may be thought out numerically, and then the particular case can be generalized, and again cast into algebraic language. The following passage, taken from one of the best of the text-books, will serve to illustrate the point:

“ We shall now consider the relation between the volume and temperature of the substance by the expansion of which temperature is measured. Let it be supposed that equal changes of temperature are measured by equal changes of volume of the substance. Then if V_0 be the volume at the zero of the scale, and V the volume at any temperature θ , we have

$$V - V_0 = v\theta,$$

where v is the increase of volume for one degree and is by definition the same all along the scale. This formula is merely the algebraic method of stating the definition, or the mode of measuring temperature, and may be written in the form:

$$\begin{aligned} V &= V_0 \left(1 + \frac{v}{V_0} \theta \right) \\ &= V_0 (1 + \alpha \theta). \end{aligned}$$

The quantity $\alpha = v/V_0$ is obviously the expansion *per unit volume* of the substance in changing its temperature from 0° to 1° . This quantity is called its *coefficient of expansion at zero*.”

Let us now change the algebraic letters into arithmetical numbers, the choice being made quite arbitrarily.

The volume of the given substance at $0^\circ = 1250 (= V_0)$. The substance is heated to $80^\circ (= \theta)$ and its volume is then $1275 (= V)$. The increase in volume is therefore $1275 - 1250 = (V - V_0) = 25$. Our object is to discover the in-

crease of *Unit volume* through 1° temperature. We argue thus:

$$\begin{aligned} &\text{Vol. of 1250 (= } V_0) \text{ heated through } 80^\circ \text{ yields an increase of } 25 \\ \therefore \text{ ,, } 1250 & \quad \text{ ,, } \quad \text{ ,, } \quad 1^\circ \quad \text{ ,, } \quad \text{ ,, } \quad \frac{25}{80} \text{ (= } v) \\ \therefore \text{ ,, } 1 & \quad \text{ ,, } \quad \text{ ,, } \quad 1^\circ \quad \text{ ,, } \quad \text{ ,, } \quad \frac{\frac{25}{80}}{1250} = \frac{v}{(V_0)} \end{aligned}$$

Since this quantity represents the increase of unit volume through 1°, it is the coefficient of expansion; we may call it α . The algebra and the arithmetic may now be written in parallel.

$$\begin{array}{l} V - V_0 = v\theta \\ \therefore V = V_0 + v\theta \\ \quad = V_0 \left(1 + \frac{v}{V_0} \theta \right) \\ \quad = V_0 (1 + \alpha \theta) \end{array} \quad \left| \begin{array}{l} 1275 - 1250 = \frac{25}{80} \times 80 \\ \therefore 1275 = 1250 + \frac{25}{80} \times 80 \\ \quad = 1250 \left(1 + \frac{\frac{25}{80}}{1250} \times 80 \right) \\ \quad = 1250 (1 + \alpha 80) \end{array} \right.$$

A particular arithmetical example is always easy to understand, and precisely the same arguments that apply to it also apply to the general algebraic case.

A simple thing like the thermometer is commonly regarded as an instrument giving the physicist no trouble: there is a sort of inevitableness about the particular form it takes, and about the principle underlying its construction. But why do we select change of *volume*, instead of change in some other property, when we measure change of temperature? Simply because it is most easily and exactly measurable. Obviously, however, this is quite arbitrary. The use of a particular thermometric substance, usually mercury, is also arbitrary. In point of fact hydrogen or helium is now often chosen as a thermometric substance; and it has been found an advantage not to measure the volume of the gas at con-

stant pressure but to measure the pressure of the gas at constant volume, and to use this as the measure of the temperature. There is, in fact, a great deal that is necessarily arbitrary in the work of the physicist, for he has to spend so much of his time groping about in unknown territory. In all his formulæ and equations only those physical facts appear which he regards as *essential*; masses of detail which he regards as unessential he ignores. That way always lies danger. He can by no means always be certain that *all* essential facts are included, and sometimes he may by chance include facts that are not essential. When he sets to work upon his equations, his mathematics may be all right (he is not likely, of course, to make elementary mathematical mistakes), but if his premisses are false, faulty, or in any way incomplete, his conclusions are bound to be unacceptable. The danger is that if neither he nor his critics have discovered that the premisses are not truly representative of essential facts, his conclusions may find a general acceptance which is not justified.

Even an apparently very simple problem which a physicist undertakes to solve may turn out to be very complex. Suppose, for instance, he undertakes to determine the solubility of common salt in water. How one question immediately suggests another! Does the solubility vary with the temperature? Does the quantity of salt dissolved increase or diminish with the temperature. What is the amount of variation? Is there a law of variation, and if so, what is it? Do different salts show different results? Does solubility vary with the pressure? Does the presence of other salts affect the result? Will different solvents lead to the same or to different results? At every stage *exact measurement* is necessary. The physicist is so essentially a measurer that he is sometimes apt to forget the nature of the thing he is measuring, to become a mathematician and *only* a mathematician.

Sometimes a physicist fails to devise an experiment for making a direct measurement, and falls back on indirect

means. How, for instance, is he to measure the thickness of gold leaf? **Faraday's** method was to weigh 2000 leaves each $3\frac{3}{8}$ inches square. From the total weight and from the known specific gravity of gold it was easy to calculate that the average thickness of the leaves was less than four millionths of an inch.

Here is another type of mathematical problem that the physicist often has to solve. **Hagenbach** measured the wave-lengths of the five principal hydrogen lines in the solar spectrum. The results were:

$$6563.04; 4861.49; 4340.66; 4101.90; 3970.25.$$

He was convinced that these numbers were in some way very closely related, but he could not discover what the relation was. He therefore handed over the problem to an assistant master named **Balmer** in a Basel Secondary school, known to be a capable mathematician. Here is the solution which Balmer, after many trials, gave to Hagenbach. (He found that all five numbers involved a constant of the value of 3645.6, a number now called the "Balmer constant" and written "B").

$$\begin{aligned} 6563.04 &= B \times 1.8 &= B \times \frac{9}{5} &= B \left(\frac{3^2}{3^2 - 2^2} \right) \\ 4861.49 &= B \times 1.3 &= B \times \frac{16}{12} &= B \left(\frac{4^2}{4^2 - 2^2} \right) \\ 4340.66 &= B \times 1.190476 &= B \times \frac{25}{21} &= B \left(\frac{5^2}{5^2 - 2^2} \right) \\ 4101.90 &= B \times 1.125 &= B \times \frac{36}{32} &= B \left(\frac{6^2}{6^2 - 2^2} \right) \\ 3970.25 &= B \times 1.08 &= B \times \frac{49}{45} &= B \left(\frac{7^2}{7^2 - 2^2} \right) \end{aligned}$$

Thus the general term is $B \left(\frac{n^2}{n^2 - 2^2} \right)$, and if we call the wave-length λ , we have

$$\lambda = B \left(\frac{n^2}{n^2 - 2^2} \right)$$

where n represents the natural numbers 3, 4, 5, 6, 7. The discovery of this relation provided physicists with a key with which they unlocked other important secrets of nature; the important thing to notice here, therefore, is that mathematics may thus form a bridge leading the way from a discovery already made to a discovery yet to come.

The physicist is often engaged in the search for a *rational formula* to embody the measured values of a number of experimental results. The way to it often lies through a kind of approximation formula, known as an *empirical formula*. From quantitative experiments he tries to obtain the relation between the different values of one quantity which may be varied at will and another quantity which is caused thereby to vary. The quantity which is directly *under his control* and "independent" of the other quantity is often called the *independent variable*; the other quantity which is determined by experiment or is calculated and therefore *depends* on the former: is often called the *dependent variable*. In plotting graphs, as every schoolboy knows, we use the x axis for our selected independent quantity and the y axis for our dependent, observed or calculated quantity. It is convenient to speak of the independent x variable simply as the variable, and of the dependent y variable as the *variant*. Thus the variable concerns the x axis and the variant the y axis.

Having obtained from a series of experiments a number of values of a variable and a corresponding number of values of the variant, the physicist tries to discover if there is any relation between them, and then to determine the empirical formula which expresses that relation. The empirical formula may or may not lead to the discovery of the *rational formula* expressing the actual underlying law of nature.

The physicist will naturally be tempted in the first place to draw a graph, just as a schoolboy draws his graph in algebra. Will the resulting curve reveal its secret? Is it part of a circle, or of a parabola, or of an ellipse, or of an hyperbola, or of some known higher curve? If so, all is plain sailing, for the

known curve enables him to write down the formula at once. But the chances are greatly against any such simple solution. The curve will probably be such a fragment of its whole self that its nature will not be recognizable, and the physicist has to fall back upon another method.

It is common knowledge that any ordinary number may be expressed as the sum of separate numbers the values of which depend on successive powers of 10. For instance,

$$7326589 = 9 + 8 \cdot 10 + 5 \cdot 10^2 + 6 \cdot 10^3 + 2 \cdot 10^4 + 3 \cdot 10^5 + 7 \cdot 10^6$$

Any fractional number may be similarly expressed; for instance,

$$.473925 = 4(\cdot 1) + 7(\cdot 1)^2 + 3(\cdot 1)^3 + 9(\cdot 1)^4 + 2(\cdot 1)^5 + 5(\cdot 1)^6.$$

Observe that the higher powers of these fractional terms represent increasingly small quantities, quantities which in actual measurement would soon become insignificant.

It was this numerical summation scheme that suggested to the physicist a means of determining an empirical formula, for he saw that by taking a sufficient number of terms he could, by adopting an analogous plan, reach any degree of approximation. He therefore wrote down the general equation

$$y = A + Bx + Cx^2 + Dx^3 + Ex^4 + \dots$$

But he argued that, as a rule, not many of the terms would really be necessary. If, for instance, x and y both represent lengths, and if it be assumed that $\frac{1}{10,000}$ part of an inch is the least that we can take note of, then when $x = \frac{1}{100}$ of an inch $x^2 = \frac{1}{10,000}$ of an inch, and if C is less than unity Cx^2 is inappreciable; and unless D , E , etc., happen to be very great, the terms beyond Cx^2 , if not Cx^2 itself, will be quite negligible. In actual practice, therefore, the physicist usually assumes that the quantities involved in his experimental investigation will approximately conform to a law of the form

$$y = A + Bx + Cx^2$$

in which x is the variable, y is the variant, and A , B , and C are "constants".

From the experimentally determined series, tabularly arranged, of x and y , the physicist will probably select three pairs, and, substituting them in the general equation, will solve the three derivative equations, and so obtain the value of the constants A , B , and C . (These constants are closely analogous to the A , B , C , etc., in the illustrative ordinary numbers given above.) He can now write down the empirical formula. It will usually be found that the formula thus obtained will yield the other values of the table to a considerable degree of approximation.

As an example we may take one of Perot's determinations of the densities of saturated vapours. Perot's method depended, in principle, on the isolation and weighing of a certain volume of the particular saturated vapour. The results for ether are given in the following table:

SPECIFIC VOLUME OF ETHER VAPOUR IN CUBIC CENTIMETRES

Experiment ..	(a)	(b)	(c)	(d)	(e)	(f)	(g)
Temperature (t) ..	28.4	30.0	31.7	31.9	57.9	85.5	110.5
Specific Volume (v)	426.2	400	375.1	373	168	77.77	43.94

Any three of these results may now be selected, say, (b), (d), and (e), and, substituting their respective values in the general equation, $A + Bx + Cx^2 = y$, we have,

$$\begin{aligned} A + 30 B + 900 C &= 400 \\ A + 31.9 B + 1017.61 C &= 373 \\ A + 57.9 B + 3352.41 C &= 168. \end{aligned}$$

Solving in the usual way, we find, $A = 1043.27$, $B = -28.24$, $C = .227$. Hence the empirical formula is

$$v = 1043.27 - 28.24t + .227t^2.$$

The next step is to see if the empirical formula thus found agrees with the remaining experimental results. We find that it does agree with (a) and (c). It therefore covers the first five cases (a), (b), (c), (d), (e). But it fails in the case of both

(f) and (g), and in these the approximation is so slight that we are driven to the conclusion either that the experimental results are wrong, or that the underlying law is more complex than would appear from the formula established. The best plan now is to take a new group of three cases, say (a), (e), and (g) (this is really a better selection than the first, for they represent a greater range), and see how nearly the formula derived from them, viz.,

$$v = 802.62 - 15.47t + .079t^2,$$

covers the remaining cases. The new formula will be found hardly more satisfactory than the other. It thus becomes necessary to formulate an equation in higher powers of the variable, though that involves a great deal of tedious mathematical work. It is always possible, of course, that some of the experimental results are wrong, but, given correct experimental results, an accurate formula is bound to follow, though the necessary labour of calculation may be heavy.

Sometimes even the second power of the variable is unnecessary, and then the task is lighter. Regnault found that the latent heat of steam at different pressures was represented with sufficient accuracy by the formula,

$$Q = 606.5 + 0.305t,$$

where Q is the total heat of the steam and t the temperature.

It must be clearly understood that empirical formulæ, although very useful tools inasmuch as they embody and correlate groups of experimental facts, are *not representative of natural laws*. They are only *approximations* to natural laws, and it is upon the general principles of approximation that they are founded. *They do not reveal what actual function the variant is of the variable.*

Yet it is precisely this function that the physicist is always anxious to discover. He wants the *rational* formula, which will exhibit the exact nature and origin of the law connecting the phenomena. The discovery of this function is often extremely difficult, and very frequently it is never made.

Consider the case of a stone projected vertically upwards. Five observations are made, and the results are as follows:

Number of seconds after the start ..	2	3	$3\frac{1}{2}$	$5\frac{1}{2}$	6
Number of feet covered after the start ..	88	180	270	504	648

Taking the formula $S = A + Bt + Ct^2$, and substituting the 1st, 3rd, and 5th of the pairs of results (the best selection), we have,

$$\begin{aligned} A + 2B + 4C &= 88 \\ 16A + 60B + 225C &= 4320 \\ A + 6B + 36C &= 648 \end{aligned}$$

which gives $A = 0$, $B = 12$, $C = 16$. The formula therefore is

$$S = 12t + 16t^2.$$

This will be recognized at once as the ordinary *rational* formula connecting space and time in the case of falling bodies (the value of g is assumed to be 32; and 12 represents, of course, the initial velocity of projection).

It need hardly be said that the above numbers were not obtained from actual experiments. They were made up from previous knowledge, specially for purposes of illustration. Actual experiments, however carefully performed, could have yielded results only approximately accurate, and the consequently complex empirical formula might or might not have given a clue to the rational formula $s = ut + \frac{1}{2}gt^2$. This rational formula, which is now so well-known, enables us to see a *reason* for the particular space and time relation.

The determination of an empirical formula of approximation is mainly a matter of skilful experiment and tedious calculation. The determination of a rational formula usually demands something more—keen mathematical insight. If the physicist on graphing a function is able to identify the particular curve, his work is done, but usually only the highly trained mathematician is likely to do this, for it often demands long familiarity with the many different types of

functions and of curves, and even then the curve may remain unread and the law unknown, though sometimes a law seems to be discovered quite unexpectedly and by chance. Yet discovery by "chance" seems to be generally the discovery of the exceptionally gifted man.

Only the very roughest measurements, or rather estimates of measures, can be made by the unaided senses, and for nearly all his work the physicist has to use accurately constructed measuring instruments. He *measures* the amount of pull or of push or of heat or of electricity or whatever it may be he uses for bringing about a change, and he *measures* the amount of extension or movement or expansion or turn of the needle or whatever other effect may be produced, and he compares the two measurements. But isolated experiments do not satisfy him. He *varies* the amount of, say, pull, and so obtains a varying amount of extension. He measures not only the different pulls which are under his control, but also the different extensions which result; he then tabulates them, and discovers the law of relation between them. Having formulated one equation which is, of course, representative of a group of physical facts he compares it with some other equation representative of another group of physical facts, and he is never without hope that, by mathematical manipulation, he may obtain a clue to some natural link between the two groups. The physicist is a great believer in the unity of all natural forces, and if there is such a unity he is full of confidence that an all-inclusive formula will some day be found to represent them.

The elementary mathematical problems we have touched upon are only a few of the many types that present themselves for solution to the physicist, but with a little patience the reader will find that he can understand the significance of most of those that appear in the more elementary textbooks. Advanced physics is, however, another matter, and only the reader who is fairly well-grounded in mathematics is likely to be able to follow up the mathematical reasoning

associated with many of the greater physical problems. Other readers will have to take the solutions on trust. This applies especially to problems depending for their solution on differential equations.

The differential equation is essentially a trained mathematician's weapon, and we must briefly refer to it, though only in a general way.

It is very natural for the novice to ask how new discoveries can be made by mere calculation. The mathematical physicist sorts out from the mass of experimental facts derived from a related series of experiments those which can be expressed in a definite and quantitative form and which he considers to be fundamental, and he expresses them in an equation, especially in that form of equation called a differential equation *which expresses the relations among the smallest parts*. A good illustration of the process is the discovery of the relation between electricity and magnetism on the one hand and light on the other. Clerk Maxwell took the known phenomena of electricity and of magnetism, and of their interactions as discovered by Faraday and others, and embodied them in a series of equations. These when combined, and manipulated in accordance with mathematical law, *produced a differential equation* containing nothing but electric and magnetic quantities, *and yet it corresponded in form exactly with the well-known equation for waves* (such as waves of sound or of light or on the surface of water). Maxwell therefore inferred that electro-magnetic experiments probably gave rise to such waves, and that they would travel with a speed which could be calculated in terms of the electric and magnetic constants of the æther. He devised a series of experiments which would determine, not the constants separately, but their product, this product appearing in the differential equation as determining the speed of the waves. He found that the velocity with which the waves presumably travelled was identical with that of light, and he thus came to the conclusion that light was an electro-magnetic phenomenon. This famous mathematical inference of Maxwell's was not

experimentially verified until after his death, but the verification left no sort of doubt that the inference coincided with unassailable fact, which, indeed, has since remained one of the main foundations of physics. The important point about Maxwell's work is that a great new *physical* discovery was made *by the use of mathematics*.

Thus differential equations may really embody more physical phenomena than the physicist knowingly first puts into them, for, after they have been manipulated mathematically, unknown and unsuspected further phenomena may be indicated, which may then be fully interpreted by the physicist. If the physicist is a competent mathematician he may do the whole thing himself.

The solution of some differential equations taxes the powers of the ablest mathematicians. The "pure" mathematician is not concerned with the physical content of the equation; he is concerned with the *symbols*. His manipulation is just as valid even if the symbols represent mere imaginary quantities, as they sometimes do. It is for the *physicist* to interpret the solution, and then there is a return from symbols to reality.

That latent facts may in this way sometimes be brought to light is not a matter of great surprise. If the symbols put into the equations represent physical facts, why should not the mathematically manipulated symbols represent in their transformations possible new combinations of those facts? It does not necessarily follow that new facts will be revealed. The solution of the equation *may* not have revealed any physical significance whatever. And even if it does, that significance may be wholly misinterpreted. It may be freely admitted that the general method of procedure—formulation of an equation, mathematical manipulation, solution, physical reinterpretation—has proved astonishingly fruitful in the hands of a few leading mathematicians and physicists. But there is always a source of danger—that of *misinterpretation*.

Professor Schuster's remark at the beginning of this section will now be appreciated. By no means all physicists

are satisfied that mathematics is an acceptable instrument of physical discovery, and they scoff at the suggestion of accepting *any mathematical interpretation that cannot be experimentally verified*.

We have a natural tendency to feel dissatisfied with any explanation of a physical phenomenon unless we can actually visualize all the operations concerned. If we can, in imagination, reduce any physical operation to some kind of movement or displacement taking place in some kind of material, we seem to arrive at a more or less satisfactory thought *terminus*. Lord Kelvin, one of our greatest physicists, was never satisfied unless he could form a clear mental picture of some sort of actual working model representative of the explanation. It is a very good fault, if fault it is, but it is nevertheless exceedingly doubtful *if we always know the whole of the facts*, and hence any working model we may coax our imagination to construct *may*, did we but know it, be an entirely deceptive thing.*

2. Wave Motion.

If we stand on the seashore, the water always seems to be coming towards us, even when we know that actually the tide is going out and when we can see, after a short interval, that the water has receded. A succession of long crests of water, more or less parallel to the shore, are continuously rolling inwards, and when they reach the shallow water on the beach they seem to topple over and, with much ado, to make a pretence of chasing us.

* The reader who is unacquainted with the calculus, but who knows something of elementary algebra, geometry, and trigonometry, should take his courage in both hands and master the elements of the subject. A few weeks' work would suffice. His satisfaction when reading through a book on physics would then be greatly increased. He should choose a book which reduces the academic side of the calculus to a minimum, and gets to grips with the practical problems of mechanics physics, and chemistry, almost at once. One such book is Mr. F. F. P. Bisacre's *Applied Calculus*. Its lucidity and simplicity make an immediate appeal to the non-specialist in mathematics, who feels that the subject, instead of being difficult and obscure as he thought, is easily within the range of a schoolboy. Indeed most Secondary schools now include the subject in their time-tables.

What is really happening? Very little. All the splashing, foaming pother is simply the result of the water ridges being suddenly obstructed by the shallow beach and falling over. Watch the water ridges when they complete their journey in deep water, for instance, when they arrive at a harbour wall. Very gently they lap against the wall, sometimes a little higher, sometimes a little lower, and that is all that seems to happen.

Imagine the sea suddenly frozen into ice, so that all movement ceased. The surface would be seen to consist of a series of equally-spaced parallel crests and hollows; its appearance would be *wave*-like.

Observe any bits of wood or seaweed floating on the surface of the water. They are not carried forward by the travelling crests and troughs; they merely *rise* and *fall*, or at the most describe little circles or ellipses. So it is with the particles of water. The water itself does not travel forwards, it merely rises and falls. It is a *wave* that travels forwards.

Scatter a few bits of stick or cork or paper over the still water of a small pond and then throw in a stone. The depression made by the stone immediately causes the formation of a little circular hill of water around it. The water of this little hill immediately sinks, not merely to its original level but below, and around it a circular trough-like depression is formed. But this trough is no more permanent than was the crest which produced it, and in recovering it brings about the formation of another circular hill of water. The formation of these crests and troughs continues until the whole surface is still again. The ripples seem to travel to the boundaries of the pond, and all the time the floating bodies gently rise and fall, and are in no way carried forward. Some beautiful photographs of the initial stages in the fall of a spherical body into water, taken by Professor Worthington at intervals of 0.003 of a second, may be seen in his book, *A Study of Splashes*.

Such effects are often produced in school laboratories by

a ripple tank, a shallow vessel a few feet square or in diameter containing water about an inch in depth. A vertically held round ruler, or even a pencil, may be gently plunged into the centre of the water every second or two, and a succession of circular waves produced which follow each other to the rim of the tank. It is particularly necessary to note that the

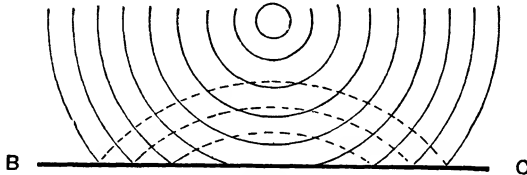

Fig. 76

moving waves are not moving masses of water. The only movement of the water particles is an upward and downward movement, as clearly indicated by any floating bodies. If a piece of board BC (fig. 76) be held vertically in the tank, across the expanding circular waves, the waves are reflected; like the original waves, the reflected waves are circular and seem to come from a point on the opposite side of the

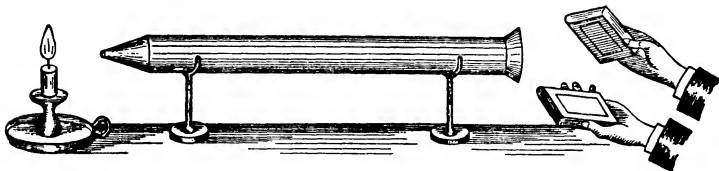

Fig. 77.—Propagation of Wave in Tube

obstructing board, but the reflected waves **freely pass through the original waves.**

If a thin piece of steel be held in a vice, and the free end be pulled aside and then released, it springs back, but it springs back not merely to its original position, *it overshoots the mark*; it vibrates backwards and forwards, and only gradually does it come to rest. This *overshooting of the mark* is the great characteristic of all wave motion.

Fig. 77 shows a stout paper tube three or four feet long

with a funnel-shaped open mouth at one end and a pointed nozzle at the other. A lighted candle is placed near the nozzle, and two books are clapped together at the mouth. The candle goes out. Fill the tube with smoke and repeat the experiment; none of the smoke is ejected. Fire a pistol across the mouth. Again the candle goes out, but no smoke is ejected. How is the transmission of the concussion to be explained?

Consider the action of an ordinary tuning fork, which has been struck, and is therefore emitting a musical note and vibrating, before a long tube (fig. 78). We may think of a

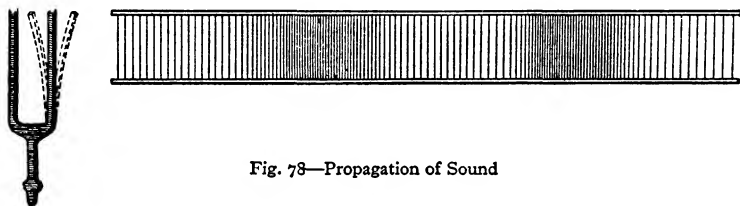

Fig. 78—Propagation of Sound

single line of air particles $p_1, p_2, p_3, \&c.$, extending from the tuning fork throughout the length of the tube. The vibrating prong of the fork strikes p_1 and springs back. In springing back it travels beyond its original position and overshoots the mark; it vibrates backwards and forwards. Meanwhile p_1 has done the same thing to p_2, p_2 to p_3, p_3 to p_4 , and so on throughout the length of the tube. The blow received by p_1 is *passed* on. Each particle vibrates backwards and forwards. There is no sort of bodily forward movement of the air. There is a crowding together or *condensation* of the particles, and the crowding together leaves behind it a spacing out or *rarefaction* of the particles, and as blow after blow is received by p_1 , the condensations and rarefactions seem to travel along the tube. Ultimately the rapid blows received by p_1 , are received by the drum of the ear placed at the other end of the tube, and in some way still very imperfectly understood the brain converts this succession of rapid blows into the sensation of sound. The schoolboy calls such

a sound wave a *push* wave; the physicist calls it a *longitudinal* wave.

There is a much more important type of wave which the schoolboy calls a *waggle* wave and the physicist a *transverse* wave. Fasten a stout rope 15 or 20 feet long to a hook in the wall, stretch it fairly tight, and give it a sharp jerk either to the right or to the left. A snake-like motion, a *transverse wave*, travels to the other end and returns. With a little manipulation, a second wave may be imposed on the first, and then a third, and thus a very lively kind of wave motion may be produced. But observe that no single particle of the rope moves forwards to the wall or back; every particle moves to *the right and to the left*. Again, however, there is overshooting the mark, just as with the push waves.

The successive movements of the particles of a transverse wave may be simply illustrated. Let 50 or 60 boys form a single-file column, standing one behind the other at intervals of about a foot. A chalk line will serve as a convenient guiding line. Let the order be given for every boy to move three paces to the right, then three paces to the left (i.e. back to the starting-point), then three more paces to the left, then three to the right (i.e. again back to the starting-point), and so on indefinitely until a halt is called. The boys are to move *in succession*. A takes one step, alone; when he takes his second step, B takes his first; when A takes his third, B takes his second, and C takes his first. And so on. Time may be

GRAPHIC REPRESENTATION OF WAVE MOTION

```

a b c d e f g h i j k l m n o p q r s t u v w x y z
a
- b c d e f g h i j k l m n o p q r s t u v w x y z
a
- b
-- c d e f g h i j k l m n o p q r s t u v w x y z
a
- b
-- c
--- d e f g h i j k l m n o p q r s t u v w x y z

```

```

      b
a-c
---d
----efghijklmnopqrstuvwxyz

      c
    b-d
a---e
----fghijklmnopqrstuvwxyz

      d
    c-e
  b---f
a----gghijklmnopqrstuvwxyz

      e
    d-f
  c---g
-b----hijklmnopqrstuvwxyz
a

      f
    e-g
  d---h
--c----ijklmnopqrstuvwxyz
-b
a

      g
    f-h
  e---i
---d-----ijklmnopqrstuvwxyz
--c
-b
a

      h
    g-i
  f---j
-----k l m n o p q r s t u v w x y z
--d
a-c
b

      i
    h-j
  g---k
-----l m n o p q r s t u v w x y z
a---e
b-d
c

      j
    i-k
  h---l
-----m-----s-----v
a-----g-----n-----r-----t-----w
b-----f-----o-----q-----x
c-----d-----p-----y

```

Fig. 79

kept by the beat of a drum. Watched from an upper window, the *forward travelling wave* along the line of boys is most impressive, and it is easily seen that any and every given element of the wave (i.e. any and every given boy) is simply moving to the right and left, i.e. *transversely*.

The illustration is imperfect in one important feature: in a medium carrying a real transverse wave, the particles are in some way *connected*, so that when one is moved it drags its neighbour with it.

Throughout the study of physics wave motion has become of such fundamental importance that the reader is advised to go to a little trouble to master its essential features. Here is a simple instructive experiment. Take a common blind-roller about five feet long, with a pulley runner fixed at each end. Into the roller drive 37 four-inch nails, at $1\frac{1}{2}$ inch intervals, in the form of a uniform spiral of three complete turns. The nails should be separated from one another by a uniform interval of 30° , so that the 1st, 13th, 25th, and 37th are in the same straight line; the 2nd, 14th and 26th in another straight line; and so on. Support the roller in a horizontal position in front of a white screen, and turn it by means of an improvised crank. Let a distant light throw on the screen a shadow of the rotating roller. Observe how the succession of shadows of the nail-heads exhibits progressive wave motion. Now observe the movement of the shadow of some particular nail; it is an example of simple harmonic motion, that is, of ordinary *pendulum* motion. The shadow of each nail remains in its own vertical plane; the progressive horizontal wave movement is one of *form* only. The distinction between (1) the actual to and fro movements of the elements in a wave-medium, and (2), the movement of the wave itself, *must* be appreciated: it is the essence of the whole thing. The second is merely an *appearance*, resulting from the successive real movements of the first. The first has the effect of making successive sections of the "medium" (as we may conveniently call it) assume

one after another the same shape. The shape therefore seems to be *something moving along*.

It will be clear that wave motion is a *periodic* motion, that is, it goes through the same series of movements at regularly recurring intervals. The periodic motion is also called *vibratory* or *oscillatory*, since it is being continually reversed in direction.

A few common terms frequently used in connexion with wave motion should be understood. A **complete vibration** is a complete forward and backward movement, corresponding to a complete "swing-swang" of a pendulum. At the beginning and at the end of a complete vibration, a particle of the vibrating medium (water, air, æther) is in exactly the

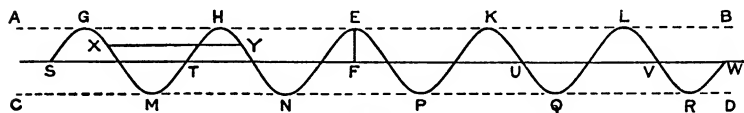

Fig. 80

same state as regards its motion. The **period** of a wave is the time of one complete vibration. The **frequency** (n) of a wave is *the number of vibrations per unit time*. The **wave-length** (λ) is *the distance travelled by the wave in one period*; in transverse waves it is the distance between two adjacent crests or troughs; in push waves it is the distance between adjacent compressions or rarefactions.

In figure 80 let the middle horizontal line represent the position of particles when no transverse wave is passing; it occupies a symmetrical mid-position between crests and troughs. The particle vibrates between the two tangents AB and CD. The distance from one of these tangents to the midline, say EF, is the **amplitude** of the vibration.

Wave lengths may be indicated in the figure not only by GH, HE, EK, KL, MN, NP, PQ, QR, but also by ST or UV, or by any other minimum distance between particles in the same *phase*, as XY.

The relation between *velocity*, *frequency*, and *wave length* is fundamental. It may be considered in this way:

The common equation connecting *space*, *velocity*, and *time* is $s = vt$. For example, if a train travels at a speed (velocity) of 30 miles an hour, it travels 150 miles in 5 hours: $150 = 30 \times 5$. Given any two of the three quantities, the third is easily calculated. Sometimes the velocity may be calculated in another way. Suppose a number of men walk from London to Brighton, one behind the other at equidistant intervals of 10 yards, and maintain a uniform speed: if 13 men pass a particular point in one minute, what is their speed (velocity) per hour?

Since 13 of the men pass the point, 12 intervals each of 10 yards are covered in 1 minute; hence 12×10 or 120 yards are covered in 1 minute, or 7200 yards in 1 hour. Hence if l be the length of the interval; if $n + 1$ be the number of men who pass in 1 minute (the frequency is then n); and if v be the velocity, then,

$$v = ln.$$

Precisely the same argument applies to the velocity of waves. If $\lambda =$ the wave-length, and n the frequency, then

$$v = \lambda n.$$

This is the fundamental formula for wave motion.

In the last figure, ST represents 1 wave-length, and between S and W there are 5 complete vibrations. If the wave travels from S to W in unit time, it travels 5 times ST in unit time. The wave frequency is therefore 5; and if the wave-length ST is λ , then the velocity $v = \lambda \times 5$.

Here is a simple analogy. A family of 4 people are walking along a snowy road, hand in hand, at the rate of 2 miles an hour. The father, a very tall man, takes steps of 3 feet; the mother, a woman of average height, takes steps of 2 feet; the older child of twelve takes steps of 1 foot 6 inches; the younger child of four takes steps of 1 foot. Walking hand in hand, they must all be travelling at the

same *speed* (velocity), (2 miles an hour), but as the lengths of their steps vary, the *frequency* of their steps must also vary. The numbers of steps each person takes can be counted up in the snow, or can be calculated by simple arithmetic.

In one hour,

- (1) the man takes 3520 steps each of 3 feet.
- (2) the woman takes 5280 steps each of 2 feet.
- (3) the older child takes 7040 steps each of $1\frac{1}{2}$ feet.
- (4) the younger child takes 10560 steps each of 1 foot.

Clearly, $3 \times 3520 = 2 \times 5280 = 1\frac{1}{2} \times 7040 = 1 \times 10560$,
 = the number of feet covered in an hour = the speed (v).
 Hence, *in every case*, $\lambda n = v$.

With the exception of the waves on the surface of a liquid, the velocity of waves is, speaking generally, always the same for the same medium, though always differing for different media. For instance, the velocity of sound in a particular gas (we ignore temperature and density differences) is always the same; so it is in a particular mixture of gases like the air, or in a particular liquid, or in a particular solid. In every case the velocity of a wave, sound or other, depends upon particular qualities of the medium, especially its *elasticity*. The *elasticity* of a body is the resistance of the body to change of size or shape. In every elastic body there is *resistance* to change of size or shape, but if this resistance is overcome there is a tendency to immediate *recovery*, and in effecting the recovery the displaced particles of the body *overshoot the mark*. This resistance, recovery, and overshooting of the mark are characteristic of both push waves (for instance, waves of sound), and transverse waves (for instance, waves of light). It is evident that push waves (like sound waves) are caused by resistance to change of size, and that transverse waves (like light waves) are caused by resistance to change of shape. A gas cannot resist change of shape and therefore cannot transmit transverse waves.

We know that the medium which normally carries sound waves is the gas mixture we call air. But what is the medium

which carries light waves? It is impossible to think of a wave without a material *something* in which the wave is transmitted. We know that light reaches us from the sun in about $8\frac{1}{2}$ minutes: what is the something that brings it? We seem bound to assume that the whole of interstellar space is filled with a wave-carrying material of *some* kind, and that we must endow it with such properties as will enable it to perform its task, for instance, that it will carry the waves at a velocity of 186,000 miles a second. Now the well-known phenomenon of polarization seems to prove that light consists of *transverse* waves, and transverse waves can only be propagated through a medium in which the various movable particles are linked together, so that when one is moved it pulls its neighbour with it. The medium must therefore be continuous, and possess rigidity and elasticity. This seems to put us on the horns of a dilemma: since all bodies move quite freely through the æther, we feel bound to think of it as if it were a highly rarefied gas; since it seems to conduct waves at an enormous velocity, we feel bound to think of it as a solid of great density. We shall return to this difficulty again.

Meanwhile let the reader ponder over this simple experiment. With a long pole, push forward some distant body. The push exerted by the hand is not transmitted *at once* to the body; the transmission is not timeless. Though solid the pole is slightly elastic and the impulse takes *time* to transmit, though the velocity is so great as to be virtually immeasurable. Were the pole absolutely rigid, the transmission would be instantaneous and timeless; but no material is known to possess the quality of absolute rigidity.

We referred to the fact that one set of waves may freely pass through another set. Nevertheless such waves are said to "interfere" with one another, and in the study of waves this phenomenon of interference is important. Drop two stones at some distance apart in the same pond. Circular waves from the one centre of disturbance will be seen to cross those from the other. At some points the crests will

coincide and reinforce each other's upward movements to a double height; at other points the troughs will coincide and reinforce each other's downward movements to a double depth; at still others the same particle of water tends to be lifted by one wave and depressed by another, and its position therefore *remains at normal water level*. The general result is an attractive pattern of interlacing ripples. At every point the resultant motion is the algebraic sum of the separate motions impressed upon that point. A score of stones might

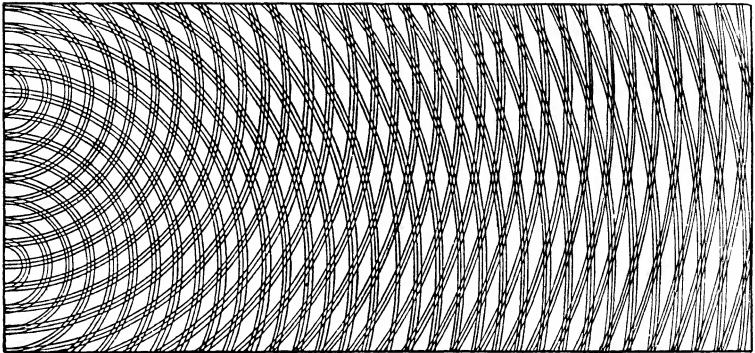

Fig. 81.—Interference or superposition drawn for two sets of ripples originating at A and B

be dropped into the water and a score of separate waves thus started, but each wave would travel calmly on just as if the others did not exist; they would “interfere” with one another merely at points of crossing, reinforcing one another, reducing one another, or cancelling one another out, as the case might be. Fig. 81 shows the interference effects resulting from two sets of ripples made by the simultaneous periodic plunging of pointed nails, at A and B, into a rectangular tray of mercury. Fig. 82 shows another set of effects; it is taken from one of Tyndall's books, and was made by the periodic dropping of small bullets into a circular vessel of water, at a point midway between the centre and the circumference. I well remember Tyndall's satisfaction when he produced beautiful patterns of this kind, and we were apt to spend our

time admiring the pattern instead of studying the interference phenomenon. Such patterns may be quite easily reproduced.

The composition of waves—the finding of the resultant wave by superimposing two or more simple waves on one another—is a common form of exercise often worked by boys learning trigonometry. In figs. 83 and 84, the lighter curves show ordinary simple transverse waves; the heavier

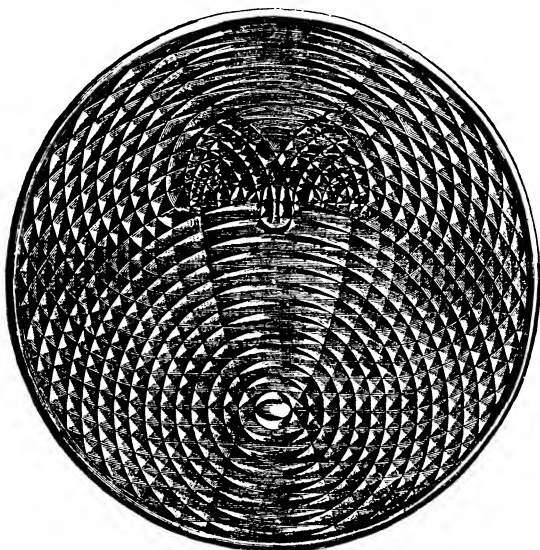

Fig. 82.—Interference Waves

curves show the composite waves, which are quite easily constructed by plotting points on a series of ordinates (the vertical lines of the figures, for instance), the points showing the algebraic sum of the ordinates of the constituent curves. Observe that the composite curves are still *periodic*, i.e. the units are repetitional, though they are no longer simple. Observe, too, that in fig. 83 the two constituent waves begin at the same point and produce a more symmetrical looking composite curve than do the two constituent waves in fig. 84, which begin at different points.

The composition of simple waves is easy enough, but the analysis of a composite wave into its elementary constituents

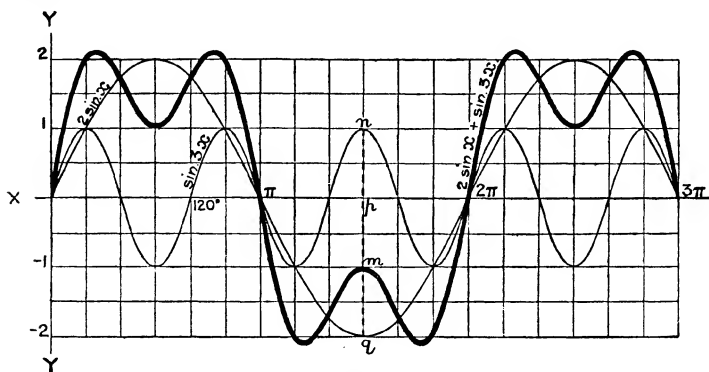

Fig. 83

is another matter altogether. Yet every wireless receiving set is virtually a piece of mechanism effecting such an analysis.

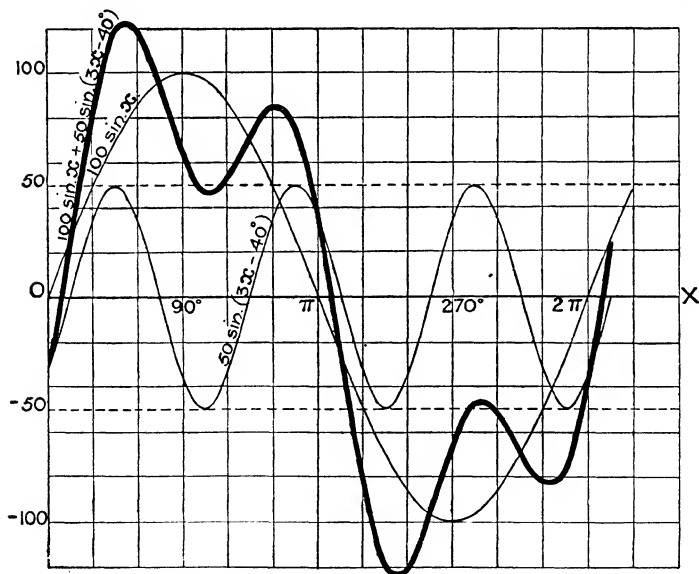

Fig. 84

Every broadcasting station sends out transverse electric waves, not just one series of simple waves direct to one receiving set, but waves of an extraordinarily complex kind which emerge like a series of expanding shells, affecting space in all directions. Fifty broadcasting stations may be doing this at the same time. All the waves travel at a speed of 186,000 miles a second, every one making its way through space, with its velocity quite unimpeded by the others. But the *form* of every one is necessarily modified by the forms of all the others. There is mutual "interference", that is, there is wave *composition*, and on a scale so grand and of a nature so complex that it utterly defies the imagination to picture it. That almost uncannily composite thing is the carrier of the music of perhaps fifty orchestras hundreds of miles apart. It sweeps across millions of aerials, including your own; that you *know*. You turn a knob and you hear a particular orchestra. *How has your receiving set analysed the composite wave*, and selected the constituent you wish to use. You may say you have attuned your set to a particular wavelength. But what does that mean? Can you picture your aerial actually functioning? Can you picture the ætherial commotion in and around your receiving set? Can you say exactly what it is that the wave itself is transmitting? Take any book that professes to give an explanation of the whole phenomenon: does the explanation really *explain*? The radio engineer's experience tells him what remedy is required for a particular defect. He applies the remedy and effects a cure. In the actual practice of his art he is thoroughly efficient. But his science? Have you ever met a radio-engineer who could transfer from his own mind to yours a complete mental picture of the happenings in the æther? You cannot have done so, for the radio-engineer *does not know*.

3. Light: Wave and Emission Theories.

It is assumed that the reader remembers from his school days something of the ordinary phenomena of light.

Reflection is the simplest of these phenomena to understand. When light strikes any sort of surface like that of polished metal or of a white wall, it rebounds, just as a billiard ball rebounds from the billiard-table cushion, or a fives ball from the wall of a fives court. In all such cases of rebound, the angle of incidence is equal to the angle of reflection, whether the two angles are measured between the rays and the surface or between the rays and a normal to the surface.

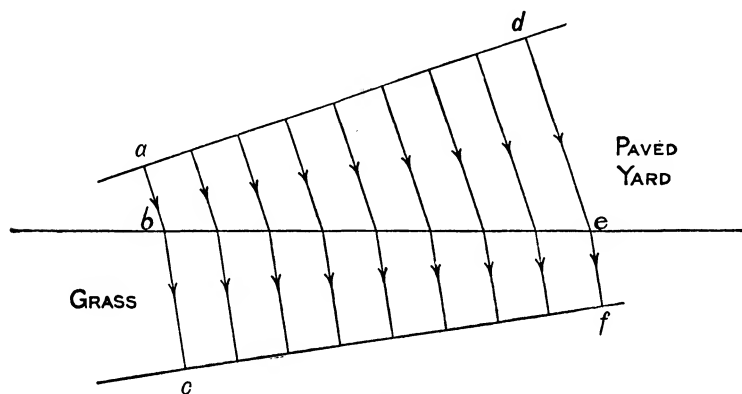

Fig. 85

Refraction is always associated with *bending*. Why? Imagine the front right wheel of a running motor-car suddenly to run over some rough stones. The obstruction would tend to reduce the speed of the wheel, while the left wheel continued at its original speed. The result would be that the car would tend to slew round to the right. Or imagine the same wheel suddenly to run over a greasy patch of road. The reduced friction would tend to increase its speed and the car would tend to slew round to the left. A slewing round is an inevitable consequence of such a change of speed. Or consider a line of soldiers marching shoulder to shoulder across a paved courtyard into a field of long grass, the line of march being oblique to the separating line between the paved yard and the grass (fig. 85). The first man to reach the grass would

be compelled to walk at a reduced speed, while all the others continued at their original speed. When, immediately afterwards the second man reached the grass, *his* speed would be reduced; and so on throughout the whole line. The net result would be that, when all the soldiers were marching in the long grass, their "front" would be slewed round, and every man would be marching in a new direction. For instance, the first man would walk the distance *ab*, in the direction *ab*, at his original speed, and then the distance *bc*, in the direction *bc*, at reduced speed. The last man would walk the distance *de*, in the direction *de*, at his original speed, and then the distance *ef*, in the direction *ef*, at his reduced speed. We may look upon the line *ad* as a *wave front*, or rather as a tangent to a series of elementary wave fronts, first reaching *be*, and then slewing round because of obstruction to speed, and reaching *ef*. Alternatively, we may call the single lines marked by arrows, *rays*, these merely indicating the *directions* of the light waves. Refraction, then, is simply a change of direction resulting from a change of velocity. When light passes into a denser medium its velocity is reduced; when into a rarer medium, its velocity is increased. In both cases there is a change of direction. The phenomenon does not apply merely to light. It applies to phenomena of movement generally.

Interference signifies, as already explained, the passing of one wave through another with a consequent mutual alteration of the *forms* of both. In light, the term most commonly refers to the phenomenon where the crest of one wave and the trough of another seem exactly to neutralize each other, so that at that point there is *no* wave, that is, there is darkness.

Dispersion. Ordinary white light is not a simple light, but a composite light of different colours and different wave lengths. Newton discovered that by passing white light through a glass prism the colours may be easily separated and shown side by side, the action of the prism being to *refract* them; but inasmuch as the constituent colours are of dif-

ferent wave-lengths, and since every colour has its own wave-length, the bendings of the respective rays are all different, and they are exhibited in order, according to their degrees of refrangibility. Such separation of the elementary constituents of white light is known as *dispersion*.

Diffraction.—That light travels in straight lines seems to be a natural consequence of the emission (corpuscular) theory. But a careful examination of the facts shows that light, when passing by the edge of an opaque obstacle, suffers some deviation from the rectilinear course. It bends round corners, but as the wave-length is excessively short, the intensity falls off rapidly within the geometrical shadow, and the amount of bending observable is so slight that very careful examination is required to detect it. When light passes through an exceedingly small aperture, the dimensions of which are comparable with the wave-length, it is not propagated through the aperture as definite rays, but *spreads out* in all directions, just as sound does when passing through an aperture a few feet in diameter.

The phenomena which occur when light passes either through a very narrow aperture or close to the edge of an opaque obstacle, and which arise from the light deviating from a straight-line path, are classified under the head of *diffraction*.

Sea-waves striking a harbour wall are readily seen to be *reflected*, but if there is a gap in the wall the waves pass through. They do not, however, continue their forward journey in a track the width of the gap. They at once spread out in an ever-widening series of semicircles. If there are two neighbouring gaps in the wall, the two sets of waves which pass through will “interfere” with one another, and the usual interference effects will be produced (p. 405).

Water-waves are long and are readily seen. Light-waves are extremely short, and are difficult to detect. Indeed, Newton found their detection so difficult that he was sceptical of their existence, and he favoured the corpuscular hypothesis rather than the wave hypothesis.

If, however, light consisted of corpuscles travelling in straight lines, the edge of the shadow ought to be sharply defined. But if a shadow be carefully examined, even the shadow of a knife held in a very bright light, it is seen at once that it is *not* sharply defined; there is a hazy coloured fringe along the margin of the geometrical shadow. If sunlight be admitted through a hole in a window shutter, it is true that the image of the sun received on an intercepting screen suggests that the light travels in true straight lines, but if the hole be made *very small*, we seem compelled to give up the straight-line explanation, for, as we have pointed out in a previous paragraph, the light is then seen to spread out on the screen uniformly in all directions, just like the sea-waves spreading out behind the harbour wall. The screen will be uniformly illuminated, and there will be no bright spot opposite the hole. If, however, *two* small holes be made very close together, the screen is no longer uniformly illuminated, but is crossed by alternate bands of light and darkness. Quite obviously the phenomenon is one of interference between two sets of spreading-out waves.

The phenomenon is more strikingly illustrated in this way. Cut a very narrow clean slit in a thin black card and hold it at arm's length in front of an electric lamp, so that it is highly illuminated. Blacken a piece of glass and with a needle scratch a fine straight line on it: this really provides us with a second light-admitting slit. Hold the scratched glass close to the eye and look through it at the illuminated cardboard slit, the scratch and the cardboard slit being maintained exactly opposite each other in the same vertical plane. We see a brilliant rectangle of light in the centre, and on each side of it *a series of coloured spectra*, thus proving conclusively that there is a lateral spread of light from the slit. The spectra represent, of course, overlapping images of different colours.

Instead of white light, substitute monochromatic light, say red light, by placing a piece of pure red glass in front of the slit, through which only red light is thus allowed to

pass. There is now a brilliant rectangle of red light in the centre, and right and left of it is a long series of red rectangles, decreasing in vividness and separated from each other by intervals of absolute darkness (fig. 86).

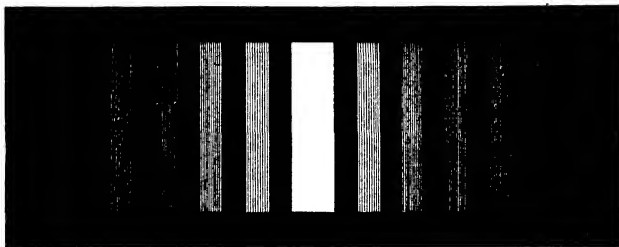

Fig. 86

If a piece of blue glass be substituted for the red, blue bands are obtained exactly like the red, save in one respect; the rectangles are narrower and *closer together*. Fig. 87 shows bands of red, green, and violet light superposed and separated. The emission or corpuscular theory seems to give no sort of

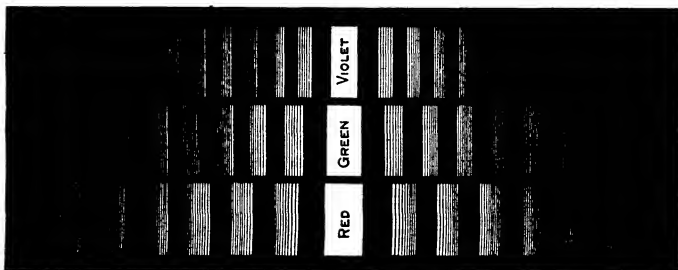

Fig. 87

explanation of this "spreading" phenomenon of light (diffraction); the undulatory theory, on the other hand, explains it perfectly as a simple application of the principle of interference. Huygens' famous principle is particularly useful and instructive: *every point of a wave which fills the slit is itself the centre of a new wave system which is transmitted in all directions through the æther behind the slit.* It is closely analo-

gous to the water-waves in the harbour: any particular water-wave front may be looked on as the circular tangent of an indefinitely large number of secondary circular waves set up at centres of disturbance in the circular wave preceding it.

But diffraction phenomena are much more easily produced by means of a *grating*. The ordinary slit effects are rather difficult to demonstrate satisfactorily, but by means of a grating the effects may be intensified and multiplied. A grating is made by tracing with a fine diamond point a number of parallel equidistant lines on a glass plate. These lines act just as if they were opaque wires so that the light incident on them is refused transmission, while it passes on through the transparent spaces (virtually "slits") between them. When the grating is held in the path of a beam of light, the successive interferences take place at exactly equal space-intervals. The greater the number of fine lines in the grating, provided they are equidistant, the purer the spectrum produced.

Gratings have been ruled with more than 40,000 lines to the inch. The essential part of the dividing engine for making these gratings is a perfect screw which can make a journey of $\frac{1}{40,000}$ part of an inch, halt and do some work, and then go on again. Think of the cutting diamond point! ever so little blunted it becomes useless. By the use of modern gratings of this kind, physicists are now able to produce diffraction spectra of great brilliance. In passing it may be noted that the beautiful colours of mother of pearl are due merely to the striated nature of the surface; if a sealing-wax moulding of the surface be taken, the moulding produces the same colour effects. Newton's famous "rings" produced round the point of contact of a convex lens of large radius pressed down upon a piece of plate glass is a well-known further example of interference.

Polarization.—There are certain mineral substances, more or less transparent, which are associated with a Light phenomenon peculiar to themselves. Tourmaline is one. If

a piece of tourmaline be cut into slices by sections *parallel to its axis*, it is found that when two of these slices are laid on each other and one is rotated through 90° from the original planes of attachment, the two form an opaque combination. The combination is most transparent as originally combined or when rotated through an angle of 180° , opaque when at right angles to these positions, and gradually diminishing or increasing in transparency when rotated from one position to the other (fig. 88).

This curious effect is easily explained by the wave theory of light, but not by any other theory that so far has been advanced.—Some crystals, for instance rock-salt, resemble

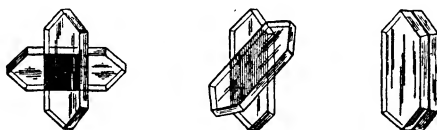

Fig. 88.—Tourmaline Plates

isotropic solids like glass in the respect that their physical properties are alike in all directions, but in such crystals as tourmaline the optical properties evidently differ in different directions in the same crystal. In such crystals there is a crystallographic *axis of symmetry*. Now, as already stated, ordinary light-waves in the æther are *transverse* waves, that is, they vibrate *across* the direction of the line of propagation. We picture the æther particles (as we may conveniently speak of them) as vibrating in all directions (or azimuths, as it is sometimes expressed) across this line. When, however, a beam of light falls on the tourmaline plate which has been sliced parallel to its own axis, its constituent transverse waves are, for the most part, compelled to vibrate in a single direction, namely, the direction parallel to the axis of the crystal. It is just as if the molecules composing the crystal were arranged in strings parallel to its axis, and as if therefore the waves were compelled to follow a one-way route between them. Any part of the beam the vibrations of which remain

perpendicular to the axis of the crystal or fail in any other way to follow the directed route is immediately extinguished; and the main part, which emerges with all its vibrations in planes parallel to the axis, is known as *plane polarized light*. (The term "polarized" simply means specially *directed*: the analogy is borrowed from directed or "polar" magnetism.) Naturally, if the second plate of tourmaline is held against the first with the axes of both in parallel, the plane polarized light will continue its journey unimpeded, but if the axes be crossed at right angles, that light will in its turn be extinguished, with the consequence that the whole of the original beam is now extinguished.

Physicists agree that the phenomenon of polarization is in this way perfectly explained by the hypothesis of transverse light waves. If the light waves were push (longitudinal) waves, like those of sound, the phenomenon of polarization would be impossible, and this very fact constitutes one strong reason for our belief that light waves are transverse waves.

Teachers sometimes make use of this rough analogy: Stretch a long rope from a hook in the wall to the other end of the room. Half-way along the room fix a vertical board at right angles to the rope, with a vertical slit just wide enough for the rope to move up and down freely. Give an upward or downward jerk to the rope and thus impress upon it an up and down transverse (waggle) wave. The wave freely passes along the rope from end to end. Now jerk the rope to the right or left and so impress upon it a side-to-side transverse wave. This wave fails to travel beyond the boards; it is extinguished by the vertical opening because this opening is perpendicular to its direction of motion.

The Transmission of Light.—We now come to the thorny question, what *is* light, and how is it transmitted?

Most of the Greek philosophers imagined that the reason why we could *see* things was because they were touched by rays which, acting something like antennæ, were sent out from the eye. But one of them, and he the greatest, **Aristotle**, scoffed at the notion, and he asked the embarrassing

question: "If the eye sends out feelers, as a lantern sends out light, *why is it that we cannot see at night?*" Aristotle recognized quite clearly that vision was not due to something sent out by the eye, but must be assumed to have its origin in the body which is seen, that is, light is transmitted from the body to the eye in a similar way to which sound comes from its source through the air to our ears. He required a suitable *medium* for the transmission of light, and he believed that the velocity through the medium was infinite. He could not bring himself to think that light could come to us unless there was some sort of medium to act as a carrier, but he believed that, however distant the source of light, the carrying medium must be of such a kind that the light struck our eyes at the very instant it was emitted. **Alhazen**, who lived 1500 years later in Spain, also maintained that the velocity of light was infinite and, 500 years later still, **Descartes** not only maintained the same doctrine, but claimed to have proved it. Descartes' view was that the transmission was effected by a sort of static pressure through a universal medium, something after the manner of an absolutely rigid pole passing on a push from a person to an object.

Galileo, a contemporary of **Descartes**, was very sceptical about the velocity of light being infinite, and to settle the question he put it to an experimental test. Two observers, A and B, each furnished with a lantern were placed a mile apart. At a given time, A removed the cover of his lantern and exposed his light. B, on the watch a mile away, instantly did the same thing. The time which elapsed between A's exposure of his own light and his perception of B's was, according to Galileo, the time necessary for the light to travel from A to B and back again. The experiments failed, for no interval of time could be detected. This was inevitable, for Galileo had no means of measuring the minute interval of time taken by light to cover the short distance of two miles. However, there is one thing that we now do know about this very difficult problem of light, and that is the velocity with which it travels. **Römer** in 1675, **Bradley**

in 1728, Foucault in 1862, Michelson in 1879, 1882, 1921-26, all measured the velocity, and all by entirely different methods, and we know for certain that the velocity is approximately 300,000 kilometres (186,000 miles) a second. The velocity of electro-magnetic waves has since been measured (by Hertz), also that of X-rays, and the result is the same in both cases as the velocity of light.

A further fact about which there is no doubt is that a hot luminous body like the sun is continuously radiating energy, and that this energy heats and lights up distant bodies on which it falls. We know of only two ways in which energy may be thus transferred; (1) by the actual projection of material bodies through space, (2) by the transmission of waves through an intervening medium. Consequently there have been two rival theories regarding the propagation of light, the *emission* theory and the *wave* theory.*

Newton, as we have already seen, adopted the former. He put forward the hypothesis that light is due to luminous particles (*corpuscles*) emitted by the luminous body, and that when these particles enter our eye they produce the sensation we call sight. The hypothesis seemed to give a reasonable explanation of all the facts then known, and so it grew into what came to be known as the *Emission* theory. Newton seems to have adopted it rather than the wave hypothesis (which he evidently also considered) because it afforded a much better explanation of the *rectilinear* propagation of light. Reflection was explained by the supposition that the particles acted like elastic spheres (something like billiard balls). Refraction was explained by the supposition that matter attracts the light particles, which are therefore accelerated as they approach the surface of a denser medium. If the denser medium is transparent and therefore offers no resistance to the travelling corpuscles, they maintain their

* An "hypothesis" is always looked upon as a *provisional* explanation. If it becomes generally accepted, it may crystallize into a "theory", though a theory sometimes contains several hypotheses. The two terms tend to shade off one into the other. New facts may cause the overthrow of a theory, as well as the overthrow of the much less settled thing, an hypothesis.

increased speed on entering the denser medium. Thus a consequence of Newton's emission theory is that *light travels with a greater velocity in a denser medium*. Newton attributed difference of colour to differences of size in the luminous corpuscles. As might be expected from Newton, the theory was logically worked out, and was given a general acceptance by physicists.

But **Huygens**, the Dutch astronomer, was not satisfied with the emission theory. He, like one or two others, felt that light, like sound, might be the product of wave motion, and he conceived a universal luminiferous æther which would act as a wave-carrying medium. The new wave theory was made to explain reflection, refraction, and other known phenomena, in a highly satisfactory way, but the authority of Newton was great, and the emission theory held the field until the time of **Thomas Young** (1773-1829), who is commonly regarded as the real founder of the wave theory. Long before Young's time, **Grimaldi**, an Italian physicist, had stated that under certain conditions, two small beams of light, acting singly, each produced a luminous spot on a white wall, but when caused to act together they partially extinguished each other and darkened the spot. Young saw that this experiment had a fundamental significance: it was clearly a case of *interference*. If the transverse wave theory were adopted, a whole multitude of experiments might be perfectly explained: they were all simple applications of the principle of interference. Diffraction and polarization were now for the first time explained adequately; *they had never been explained by the emission theory*. Young's own specially devised experiment afforded convincing proofs that the wave theory covered far more experimental facts and explained the phenomena of light far more satisfactorily than did the emission theory, and the latter was now abandoned. But the crucial experimental test to decide between the two theories was not made until 1849 when Foucault measured the velocity of light in different media (for example, air and water). According to the emission theory the velocity of light in a denser medium must be *greater* than

in a rarer; according to the wave theory, the velocity must be *less* in a denser medium. Foucault's experiment proved conclusively that the velocity in denser media is less than in rarer. It was in this way that the emission theory was superseded by its rival.

Sometimes it is said that the emission theory must necessarily be ruled out of court because it contradicts common sense, that, for instance, it is absolutely impossible to conceive of a material particle travelling from the sun to us at the rate of 186,000 miles a second, or of a force great enough to start it off on such a journey. Perhaps that may be conceded. But now try to conceive of a *wave* travelling through the æther with that velocity. Can it be visualized? It is worth while to make and to suspend a coil of wire, bifilar fashion, 30 feet or 40 feet long, to pinch a few coils together, and to watch the waves of compression and rarefaction actually travelling the whole length of the coil; then to jerk sideways a tightly stretched long rope and to watch the transverse waves travelling the length of the rope. Now try to think of an æther wave. The incandescent surface layers of the sun are undoubtedly in a state of violent agitation, and we are to imagine one of the agitated atomic particles giving a violent kick to the æther and thereby starting off a transverse wave which will carry onwards the energy of that kick *at the rate of 186,000 miles a second*, and, after travelling 92,000,000 miles, will deliver it up, intact, to our eyes. Can we picture that travelling wave? Can we imagine such a speed? Is this scheme of things less contrary to "common sense" than the other scheme of flying particles?

It is quite true that, since Maxwell's time, it has not been necessary to consider a simple transverse wave travelling in an elastic medium, but an electro-magnetic wave instead. Does that reduce our difficulty? That electricity is in some way concerned, experiment leaves no room for doubt, and since electricity and magnetism are virtually different aspects of the same thing, it is highly probable that electro-magnetic waves are in *some* way concerned. But if waves of any kind,

there must be a medium which will carry them, and, if they are carried with an enormous velocity, the medium must be one of very great rigidity. On the other hand, the heavenly bodies move at great speeds through space, so that if there is a space-filling medium it must be of the nature of a rarefied gas. Which medium are we to accept—a solid medium of great density or a medium of great tenuity? If the former we can admit the waves; if the latter, we can understand the freedom of movement of the heavenly bodies. On which horn of the dilemma are we to transfix ourselves?

Some physicists no longer use the term æther; the term repels them because of its old associations with great density and rigidity. They take the common sense view that it is impossible to conceive a universal medium with such properties, and sometimes they use the word "space" or "continuum" instead. But by "space" they do not mean mere *emptiness*; they refer to a medium having a *structure* of some kind, though the nature of this structure is entirely unknown. Whatever else it is, it must be a structure of a kind that will carry electro-magnetic waves; the transmission of waves across absolutely empty space amounts to a contradiction in terms.

All experimental facts are in harmony with the hypothesis (1) that light is due to transverse periodic electric displacements in a universal medium, set up by the agitation of the particles of matter; (2) that these waves are of different lengths (periods of vibration), though all very short; (3) that different colours correspond to different rates of vibration; (4) that waves of all lengths travel with the same velocity in free space but with different velocities in different material substances.

About the wave-carrying medium *we know nothing*, except that, unlike material substances, it is in no way subject to gravity. *How* the transmission of the electro-magnetic waves is effected, *we do not know*. What these electric waves in the transmitting medium are *like*, *we do not know*.

We shall return to the subject in a later chapter.

4. Spectroscopy.

Newton allowed a sunbeam to pass through a small hole in the window shutter of a darkened room, and, as he expected, the beam impressed a circular white image of the sun on the opposite wall. In the path of the beam he then placed a glass prism, expecting both to see the beam displaced and to see the image of the sun, after displacement, still circular. To his astonishment, the image was greatly elongated, its length being about five times its breadth; moreover it was no longer white

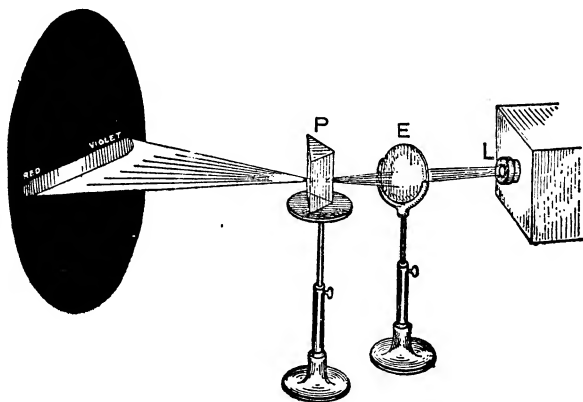

Fig. 89

but beautifully coloured, like a section of a rainbow. The various colours were not definitely separated, but seemed to melt one into the other; in fact, there seemed to be an indefinitely large number of colours, but it was possible to identify seven distinctly, and in this order: violet, indigo, blue, green, yellow, orange, red. One end was pronouncedly violet, the other pronouncedly red, and the middle pronouncedly green. Newton called the coloured band a *spectrum*. He saw at once that the sun's light was composite, not simple (monochromatic). The image showed that the prism had bent (refracted) the different constituents in different degrees, those at the red end being bent least, and those at the violet

end, most. Fig. 89 shows Tyndall's method of repeating the experiment. A beam from a lantern, L, was used instead of a beam from the sun, and it was made to pass through a lens E in order that a sharp image might be formed on the prism P before being refracted and spread out on the screen.

Newton performed two further important experiments. (1) He interposed a second prism, reversed as to position, in the path of the decomposed beam; the colours were all refracted back in the reverse direction, reblended, and the perfectly white disk restored. Thus analysis was followed by synthesis. (2) He received the coloured spectrum on a screen in which he had made a narrow slit, through which some particular colour, say, blue, was allowed to pass, and this colour was received on a second prism at the back of the screen. There was no further modification of the colour save for a slight additional broadening. The first prism had effected a complete analysis.

We saw (p. 410) that refraction is merely a phenomenon of changed velocity. It therefore follows that, since the coloured constituents of the sun's white light are refracted to different degrees by the glass prism, these coloured lights must travel through glass at different velocities, and each with its own velocity. And the same thing applies to any other refracting medium. But in interstellar space, there is no such variation of velocity. The constancy of the velocity of *all* waves coming to us from the sun or from the stars does not seem to admit of doubt. For instance, the variable star, Algol, exhibits rapid changes in brightness. Hence, if the different colours travel through space at different velocities, the changes in the brightness of Algol ought to be accompanied by corresponding exhibitions of colour. If, for instance, red light travels faster than the violet in interstellar space, as it certainly does in glass and common transparent substances, then when the star is growing faint it should be coloured violet, and when it is growing bright it should appear red. But no trace of a coloured tint has ever been observed. We may therefore conclude that the waves corresponding to the

various colours of the spectrum traverse the free æther with the same velocity.

A spectroscope is an instrument for viewing and comparing with facility different kinds of spectra. If the instrument is provided with means for making measurements, it is known as a spectrometer. The spectra produced on an open screen are not good enough for observation work of a serious kind, and are no good at all for measurement purposes.

If by means of the spectroscope we examine any bright white light, we get a *continuous coloured spectrum*, showing that we are getting waves of all wave-lengths from that source. A candle-flame would do, but an electric arc light is much better. In both cases the sources of light are the incandescent solid particles in the flame. Any white-hot solid will give a continuous spectrum of this kind. When we begin to warm a solid body, it first radiates long waves, longer than those of red light, waves giving us the sensation of warmth. As we go on heating, waves of shorter wave-length are produced *as well as* the longer ones, until the first red waves appear, and the solid begins to show a red glow. On further heating, shorter waves of still greater frequency are given out, until the whole range of the visible spectrum is included, and the solid becomes white-hot. The shorter waves are *added* to the previous longer waves; all remain.

At first sight a spectrum of sunlight seems to be of the same continuous coloured type. But if the light is admitted to the spectroscope through a very narrow slit, the coloured band is seen to be crossed by a multitude of dark lines, some fairly wide, some very narrow, all invariably occupying the same relative positions. What do these lines mean?

If we examine the flame of a Bunsen burner, we get practically no spectrum at all, but if we hold a pellet of sodium in the flame, two bright yellow lines, very close together, appear. These are known as *D* lines, and they invariably appear when any substances containing sodium are burnt, and always exactly in the same position. The presence of these lines in a spectrum, which are very easily recognized,



THOMAS YOUNG
After Lawrence



DMITRI IVANOVICH
MENDELÉEFF
From Engraving by Stoddart



RÖNTGEN



JULES HENRI POINCARÉ
Photo. Manuel

is accepted as conclusive proof of the presence of sodium. This spectrum is a *line* spectrum, and is the type of spectrum given by any incandescent gas or vapour.

Now if in the spectroscope we have a continuous spectrum, say from the electric arc, and if we then interpose a sodium Bunsen flame, so that the waves from the electric arc flame have to pass through the waves of the sodium flame, we might expect the yellow sodium lines to be reinforced by the yellow colour of the continuous spectrum; but, actually, the reverse occurs. The continuous spectrum is broken by *dark* lines, exactly at the positions normally occupied by the yellow sodium lines. What is the explanation? The sodium vapour radiates waves of a certain frequency. The electric arc flame which gives the continuous spectrum, radiates, of course, waves of many frequencies, including a small group of the same frequency as those from the sodium vapour. The arc waves, coming from a much hotter source than the Bunsen flame carrying the sodium vapour, are far more vigorous than those of the sodium vapour flame, and most of them pass on unimpeded and display themselves on the screen. But some sort of a struggle takes place between the two sets of waves of the same frequency, namely, the vigorous waves from the arc and the weaker waves from the sodium flame. Precisely what that struggle is we do not know, but it is usually said that the weaker waves "absorb" the stronger, and tend to suppress them. Be that as it may, the waves of that particular length that show themselves on the screen seem to arrive in an enfeebled condition, and their representative lines of feeble yellow look relatively dark against the background of brilliant colour.

It is experimentally possible to show bright line spectra and dark line spectra one over the other, in order to compare the positions of the lines. The spectra of most of the elements consist of numerous lines in different parts of the spectrum, always occupying exactly the same positions. A large variety of experiments over a space of many years makes the conclusion inescapable that some definite group of lines is cor-

rectly representative of a particular element. We are thus able to tell what elements are present in the sun. The principal portion of the sun's light comes from the photosphere, and we infer that it is this which gives the continuous spectrum. We infer further that the radiation from the photosphere passes through an outer stratum of vapours (specifically known as the chromosphere), and that these vapours reveal their identity by means of the dark lines they imprint on the photosphere's continuous spectrum. There is a struggle between two sets of waves of the same frequency, and the weaker from the outer vapour "absorbs" the stronger from the photosphere, or at all events leaves them badly damaged in appearance, robbed of their brilliant colour.

There is probably no better established fact in science than that the dark lines of the spectrum are representative of the various elements. Each element is represented not merely by one or two lines but by a very large number, and the group for each element is always the same and in the same position. With improved experimental methods, more and more lines are still being found, but, of the many many thousands now known, very few can be detected with the naked eye. And as the crowding and overlapping is excessive, the sorting out is one of the most difficult things to do in the whole range of physics. To the uninitiated, the mass of lines is utterly unintelligible, for apparently there is an entire absence of any sort of systematic arrangement. And yet each group, once separated out, tell us a very great deal about the element it represents.

To the physicist, the coloured band is of little interest except that it helps him to locate certain of the best-known lines. Indeed, the coloured band—the visible spectrum—is but a small fragment of the spectrum as a whole, which extends a long way below the red and a long way above the violet. Thus we have a "visible" and an "invisible" spectrum. A thermometer will soon tell us of the existence of a region below the red; it is a region of heat waves; and chemical tests will soon show that there is also an active region beyond the violet. And the "lines" are continued

SPECTRA

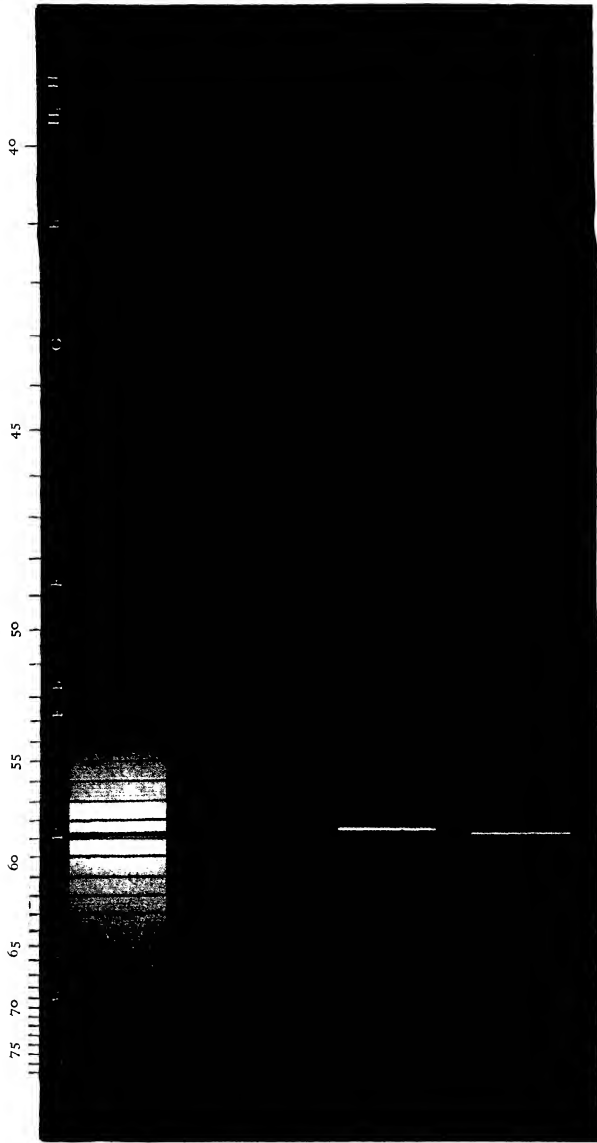

A, B, C, &c., Fraunhofer's Lines

The scale numbers give the wave-lengths in millionths of a centimetre: these have to be multiplied by 100 to give Angstrom units

into the regions of both the infra-red and the ultra-violet.

Whether the waves are long or short, and whether in the infra-red or in the coloured spectrum or in the ultra-violet, they always travel with the same speed, that is with the constant velocity, v . (We ignore the differences of speed when they are travelling through solids or liquids.) The sensation of heat is produced by waves of exactly the same velocity as those of light, though they are very much longer; the wireless waves with which we are so familiar are much longer still and are still further down the infra-red end of the spectrum. At the other end of the spectrum, up in the

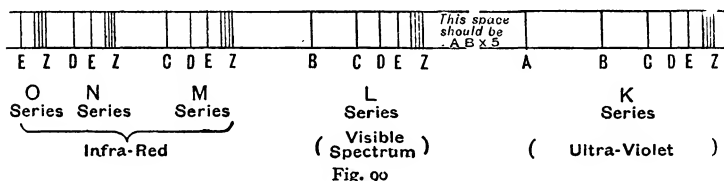

ultra-violet, we have the X-rays, amazingly short rays, but travelling with precisely the same velocity as all the others.

We may refer in some detail to the Hydrogen spectrum, which is sufficiently typical of the spectra of all the other elements. The best known lines in the H spectrum are the three discovered by **Fraunhofer** as black lines in the solar spectrum; the one in the red he labelled C; the one in the greenish blue, F; the one in the indigo, G. We now call them B, C, and D respectively, and we now know a fourth line E, as well as a number of fainter lines crowded together and finally coming to an end in the form of a fade-away and termed Z. Thus we think of the series as B, C, D, E, . . . Z. The series itself is called the "L" series, and it is the one series in the visible spectrum. There is a similar series (K) in the ultra-violet, and still others (M, N, O) in the infra-red. In each series the same letters (B, C, D, E, . . . Z) are used to distinguish the spectral lines, though not all the lines appear in the infra-red series. Fig. 90 shows a diagrammatic view of the successive series.

As might be expected the first series to be discovered was the L series in the visible spectrum. Observe that the head of each series is the fade-away, Z. The other end of each series is called the "fundamental", viz., A in the K series, B in the L series, C in the M series; and so on. The first and second series are a long way apart, about five times the length of the distance AB; space does not permit drawing to scale. Note that the K series less the A line gives the L series; the L series less the B line gives the M series; and so on. The



Fig. 91

spacing between the lines is the same for all; we may therefore cut up the whole spectrum into pieces, and place the parts in position as in fig. 91. Observe how the letters tally exactly in the vertical columns. We feel bound to infer that the various lines must tell us some important story about hydrogen, could we interpret them. We shall come to the interpretation in the next chapter. (For the present, the numbers in the figure may be ignored.)

Every line in the spectrum is the faithful representative of a wave, and it is important to know the *lengths* of all the waves. The direct measurement of wave-lengths is, however, an extremely laborious matter. Still, certain wave-

lengths have been measured, and with very great accuracy, especially those of the lines of the iron arc spectrum. The exact positions of these lines in the spectrum being known, and their wave-lengths being known, they may be regarded as *standard* lines, and by means of them the wave lengths of any other lines of known position may be readily calculated. It is merely a question of filling in the gaps on a scale of magnitudes. The few lines experimentally determined readily enable us to discover the *kind* of scale we have to deal with; whether, for instance, the scale is one with the graduations in ordinary arithmetical progression (as in a thermometer scale), or in geometrical progression (as in this case of waves); the more lines that can be experimentally determined, the more can be used for verification purposes.

A spectrum scale once prepared, all newly discovered lines may be referred to it, and their wave-lengths read off.

With very little trouble the reader may make himself familiar with the ordinary terminology used in connexion with wave lengths. For the most part, the waves are so excessively small that if expressed in terms of, say, the foot or the metre, we should have to use unwieldy decimal or vulgar fractions.

The fundamental formula connecting *velocity*, length, and frequency of waves is $\lambda n = v$ (see p. 402) where v is 300,000 kilometres (approximately 186,000 miles) a second.

Since the wave lengths are very small, and since we desire to express their relative values in whole numbers, we have to adopt a unit of exceedingly small dimensions.

The unit formerly used was the *micron* (μ), the millionth part of a metre, but in practice this was found too big. The unit now more commonly used is equal to the ten-thousandth of a micron and is called a *tenth-metre* or an *Ångström Unit* (A.U.) (*Ångström* was a Swedish physicist.)

The reader will remember that, when dealing with large numbers, we may often spare ourselves the labour of writing many noughts by using the index notation, and using these indices as freely as in algebra. Thus 100 may be written 10^2 ,

1000, 10^3 ; 1,000,000 (a million), 10^6 ; a billion (a million times a million), 10^{12} ; one-millionth, $\frac{1}{10^6}$ or 10^{-6} ; one-billionth $\frac{1}{10^{12}}$ or 10^{-12} . A "tenth-metre" (A.U.) derives its name from the fact that it may be written $\frac{1}{10^{10}}$ metre or 10^{-10} metre. Since 1 followed by 10 noughts represents ten thousand millions ($10 \times 1000 \times 1,000,000$), a tenth-metre (A.U.) is one ten-thousand-millionth part of a metre. It is a further useful point to remember that 100 ($= 10^2$) centimetres make a metre and 1000 ($= 10^3$) metres make a kilometre. Also that there are approximately 2.5 centimetres to an inch.

We may now return to wave lengths and frequencies.

Suppose we have measured the wave length of a particular colour, say green, in the middle of the visible spectrum, and find it is 0.0000005 (or $5 \cdot 10^{-7}$) metre. Since $v = n\lambda$, $n = v/\lambda$; and since $v = 300,000$ kilometres or $3 \cdot 10^5$ kilometres or $3 \cdot 10^5 \cdot 10^3$ metres or $3 \cdot 10^8$ metres, per second, and since $\lambda = 5 \cdot 10^{-7}$ metre

$$\therefore n = \frac{v}{\lambda} = \frac{3 \cdot 10^8}{5 \cdot 10^{-7}} = \frac{3 \cdot 10^{15}}{5} = 6 \cdot 10^{14}.$$

that is, the frequency is **600 billion** per second.

It therefore follows that, if the wave theory of light is truly representative of the facts, 600 billion transverse waves brush across the retinae of our eyes *every second*. How can we escape the conclusion? The velocity is a *measured* velocity; the wave-length is a *measured* length; the relation $n = v/\lambda$ applies to all waves whatsoever. But though the conclusion is inescapable, the actual facts are wholly beyond the reach of the imagination.

Be that as it may, the numbers we have used in this calculation are unwieldy and to avoid the unwieldiness physicists have adopted a useful alternative plan. Instead of expressing such minute wave lengths in terms of a big standard unit like the metre, they have adopted (as already

said) the "tenth-metre" (the A.U.), that is, a unit ten thousand million times as short as the metre. Hence our measured wave length of green light, instead of being expressed as $\cdot 0000005$ metre, can be expressed as $\cdot 000\cdot 0005 \times 10^{10}$ A.U., i.e. $5 \times 10^{-7} \times 10^{10}$ A.U., i.e. 5×10^3 A.U., or *5000 A.U.* We may thus speak of the *wave length as 5000 A.U.* The second part of the plan is to think of the frequency (n) not as the number of waves *per second of time*, but as the number of waves *per centimetre of length*. The frequency as above calculated, viz. $6 \cdot 10^{14}$, represents the number of waves produced in 1 second over a distance of 300,000 kilometres or $300,000 \times 10^5 (= 3 \cdot 10^{10})$ centimetres. Hence the number of waves in 1 centimetre is $6 \cdot 10^{14} / 3 \cdot 10^{10} = 20,000$. This number, representing *the number of waves in one centimetre of wave-train* is called the **wave-number**.

Thus the particular green-light radiation considered has

(i) a **wave-length of 5000 A.U.** (usually written $\lambda 5000$ A.U.)

(ii) a **wave-number of 20,000** (usually written $\nu 20,000$).

Such numbers are obviously far more manageable and significant than the big numbers and small fractions for which they have been substituted. But the special units they stand for must always be borne in mind.

Visible light extends from about $\lambda 7600$ in the red to $\lambda 3800$ in the violet. Note that the violet waves are about half the length of the red waves.

We may tabulate the approximate lengths of a few different types of waves (in Ångström Units).

Cosmic rays	0·00001?
Gamma rays	0·1
X-rays	1
Shortest visible rays (violet)	3800
Longest visible rays (red)	7600
Longest waves in solar spectrum, more than	53,000
Shortest electric waves	2,200,000

Fig. 92 represents the relative lengths of violet and red waves, both multiplied by about 10,000.

That we cannot "see" waves below the red or beyond the violet is simply due to the structure of the eye, not to any difference in the waves themselves, apart from their

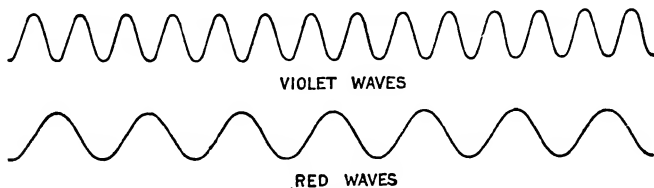

Fig. 92

length. It will be observed that the periodic time of the violet waves is approximately half that of the red waves. In sound, such a relation would just include all the sounds in one octave. The piano includes seven octaves and our ears readily respond to them all, as well as to others above and

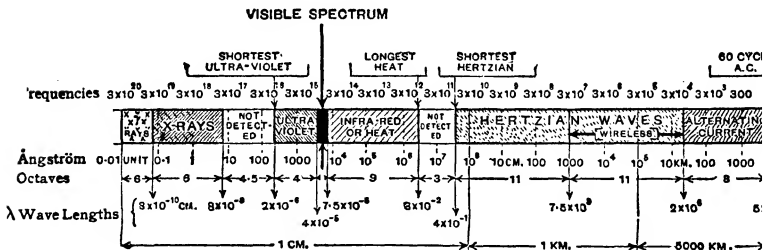

Fig. 93

below; but our eyes respond to only a single octave out of a vast number of octaves on the spectrum scale.

Fig. 93 will afford some idea of the vast range of electromagnetic waves in the whole spectrum. (Observe that the short waves are shown to the left of the spectrum.) What an insignificant fraction of the whole is represented by the single octave of visible light!

5. Thermodynamics.

Some brief reference must be made to this subject, inasmuch as one of its aspects, "entropy", is closely concerned with certain far-reaching considerations of modern physics. Its principles are based upon a series of important experiments, and their development is associated with rather subtle mathematical reasoning. Here, a short general description must suffice.

According to a theory now abandoned, heat was supposed to be a subtle, elastic, imponderable fluid, called *caloric*, which permeated all kinds of matter and existed in the interstices between the molecules. Its supporters were ready with a more or less satisfactory explanation of all the ordinary phenomena of heat experiments, but grave doubts arose when **Rumford** observed, in connexion with the boring of a cannon at the arsenal at Munich, that the heat developed by the steel borer was practically inexhaustible, and that such a large amount could not possibly be stored up within the metal. Rumford argued that heat could not be a material substance; it must be *motion*. **Davy** followed this up by rubbing together two blocks of ice at a temperature below 0°C ., and found that heat was developed and the ice melted. Caloric promptly died. Thenceforth heat was looked upon as a *mode of motion*.

One of Dalton's pupils, James Prescott **Joule** (1818-89), established the principle of equivalence between heat and work. The principle, which is known as the *First Law of Thermodynamics*, asserts that when work is spent in producing heat, the quantity of work done is directly proportional to the quantity of heat generated, and conversely, that when heat is employed to do work, a quantity of heat disappears which is the equivalent of the work done. Heat is thus regarded as a form of *energy*. Joule is responsible for the famous doctrine of the Conservation of Energy.

The Energy of a system, if due to *motion* (as in mass motion, wave motion, ocean currents, and electric currents) is

called *Kinetic* energy. The energy which a system possesses on account of either its *position*, as in raised masses (e.g. a ball thrown up into the air, at the moment it is about to return), or its state of strain, as in magnetized bodies, is called *Potential* energy. The great characteristic of all energy is its susceptibility to transformation, and in all its transformations there is invariably a *conservation*. The physical law known by the name of *conservation of energy* asserts that the total amount of energy in any isolated system is absolutely invariable in amount. Whatever transformation may take place, the total amount is neither increased nor reduced. An inescapable logical consequence of this law is that the total energy of the whole universe is a *fixed amount*.

The law of the Conservation of Energy is the most universal of all the laws of nature. There is no process whatever to which it does not apply exactly, no matter whether in physics or in chemistry or in biology, no matter whether on the earth or within the earth, in the sun or in the stars. But while we may rightly think of energy as indestructible we must not think of it as if it were some sort of *entity*.

The law of the Conservation of Energy is supplemented by an equally comprehensive second law, one which is even more fundamental in its significance. It is sometimes called the *Second Law of Thermodynamics*, or the *Law of Entropy*.

The chief and almost the only source from which the earth and the other planets receive their energy is the sun. The amount of energy which the sun pours forth unceasingly day and night has been experimentally determined, and it has been found that the earth receives *every minute* a quantity of heat sufficient to melt a cube of ice with edges two miles long. And yet the energy thus received by the earth is only the $1/2,200,000,000$ th ($1/22 \cdot 10^8$) of the whole which is radiated by the sun in all directions, most of this being lost in the vast depths of space.

Of the solar energy received by the earth, one small part is absorbed by the atmosphere and a second small part by the land, and in both cases it is stored as thermal energy; a little

of the second part falls on fields and woods and is stored up in the plants as chemical energy. By far the greater part falls upon the sea and is stored also as thermal energy, but a small portion of this causes water to evaporate and to ascend to form clouds. The potential energy which the clouds possess has thus evidently been acquired from the sun. The rain falls to the ground, where it forms lakes and rivers, and the kinetic energy resulting from the falling appears again as thermal energy. That which remains latent in the mountain lakes is easily converted into electrical energy which may drive machinery or make artificial light, but in the end it is all reconverted into thermal energy. A good deal of the sun's energy emitted ages ago was stored away in buried wood which has since become converted into coal. We use this coal, and again the energy appears as thermal energy. In short, in every process, small or large, every kind of energy, be it mechanical, electrical, or chemical, is eventually transformed into thermal energy. The sun's radiation comes to us as heat, does many different kinds of work, sometimes on its own account, sometimes because we harness it, but when the work is done it is again transformed into heat (thermal energy).

The important thing to notice about the transformations is this: the heat when radiated from the sun was at a very much higher temperature than after it had done work. Work was done, but at a cost: *there was a general cooling down.*

If the quantity of energy possessed by the sun is finite, and if its radiation is continuous, its temperature must be falling and must continue to fall until it cannot be distinguished from that of its surroundings. Its original vast store of energy will have been *dispersed* throughout the universe. The energy will still exist, not in the concentrated form of violent motion we think of as the sun, but in some form of universal and uniform gentle motion, never represented, however, by absolute zero of temperature, for we feel bound to assume that there is no absolute *destruction* of energy.

All this is based on the assumption that the energy transformations downwards into heat are *not reversible*. Is the

assumption justified? Can the thermal energy which has once been emitted from the sun and which has done work and has thus been de-graded, recover its vigour and return to the sun to replenish him?

Certain natural processes seem to proceed spontaneously in one direction but never in the reverse direction. A heap of oak leaves and a heap of beech-leaves lying side by side are suddenly scattered and mixed by a gust of wind, but we cannot imagine another gust of wind separating them again. *Why not?* A flask of nitrogen and a flask of oxygen are connected by a tap and the tap is turned on; diffusion takes place and the two mixtures become indistinguishable: even if the tap is left open for a thousand years we cannot bring ourselves to think of separation taking place again spontaneously. *Why not?* A rotating wheel is brought to a stop by friction as soon as its kinetic energy has been converted into heat; we cannot imagine the reverse process taking place spontaneously, the dissipated heat recovering and re-converting itself into kinetic energy. *Why not?* Two hot bodies of different temperatures are placed in contact, and the hotter body gives up some of its heat to the other. We cannot imagine the converse process taking place spontaneously, the less hot body giving up some of its heat to the other. *Why not?* We can easily invent explanations of all these things, but really *we do not know*. An *external agent* can effect the reverse processes, perhaps; for instance, a machine may be devised for converting heat into mechanical motion. But nature usually seems to work in only one direction. Not always: she sometimes turns ice into water, water into vapour, vapour into water, water into ice. But generally she is unidirectional.

The most useful forms of energy are kinetic energy, potential energy, and electrical energy, for they are easily and profitably converted into other forms. But the thermal energy which merely exists in bodies at higher temperatures than their surroundings (as, for instance, in a steam boiler), is less useful; however used, some of it is likely to be lost. As for

the energy which exists as thermal energy in bodies in a large extended space, it is practically useless, as it cannot be readily converted into any other form of energy.

Clausius (1822-88), a German physician, summed up nature's tendency to a one-way movement in the statement: *Heat cannot on its own account pass from a cold body to one which is hotter.* The important words here are *on its own account.* **Lord Kelvin** (1824-1907) expressed the same notion differently: *It is impossible to devise a machine which will run continuously by abstracting energy from its environment.* If by any means we cause heat to be transferred from one body to another at a higher temperature, we must in the process supply the system with energy from some outside source.

The great tendency of nature to transform all energy into heat at a uniform temperature was very strongly emphasized by Clausius after he had undertaken many researches on the subject. He embodied his results in this form: *In every closed system which neither receives energy from without nor loses energy, the entropy tends to a maximum.* This maximum is reached when all other forms of energy have become transformed into heat energy at a uniform temperature. So far as the whole universe can be considered as a closed system, the law of Clausius may be expressed thus: *The entropy of the Universe tends to a maximum.* In other words, the universe is running down like a clock, and like a clock will come to a full stop—*unless it is wound up again.*

Maxwell's view was that the second Law of Thermodynamics was undoubtedly true when applied to bodies in the mass, but he reminded us that we have no power of seeing or handling the separate molecules of which the bodies are made up. *We cannot get at the actual facts; our arguments are necessarily based on mere average effects.* Maxwell said:

“If we conceive a being whose faculties are so sharpened that he can follow every molecule in its course, such a being, whose attributes are still as essentially finite as our own, would be able to

do what is at present impossible to us. For we have seen that the molecules in a vessel full of air at uniform temperature are moving with velocities by no means uniform, though the mean velocity of any great number of them, arbitrarily selected, is almost exactly uniform. Now let us suppose that such a vessel is divided into two portions, A and B, by a division in which there is a small hole, and that a being, who can see the individual molecules, opens and closes this hole, so as to allow only the swifter molecules to pass from A to B, and only the slower ones to pass from B to A. He will thus, without expenditure of work, raise the temperature of B and lower that of A, in contradiction to the second law of thermodynamics.

“This is only one of the instances in which conclusions which we have drawn from our experience of bodies consisting of an immense number of molecules may be found not to be applicable to the more delicate observations and experiments which we may suppose made by one who can perceive and handle the individual molecules which we deal with only in large masses.” (*Theory of Heat*, pp. 338-9.)

Physicists have often tried to slay this “demon” of Maxwell’s, but they have never succeeded.

There is really nothing to prevent such a sorting out of the molecules into two classes *occurring naturally*, since the movements of the molecules are controlled *by chance*, subject to the condition that the sum total of their energies is constant. Ludwig Boltzmann (1844-1906), an Austrian physicist, considered the connected flasks of oxygen and nitrogen (p. 436) and reasoned in this way.—As long as there are more (say) oxygen molecules than nitrogen molecules in the oxygen flask, it is *more probable* that a molecule passing from the oxygen to the nitrogen flask will be an oxygen molecule than a nitrogen molecule. When, however, equality is once established, the *probability* with which an oxygen molecule may be expected to pass is equal to the *probability* with which a nitrogen molecule may be expected to pass. It is *not impossible* for complete separation to take place again, but it is so *highly improbable* that such a prospect is practically negligible.

We think of heat as a complex molecular motion. The

transference of heat from one body to another and the consequent equalization of temperatures really therefore seem to consist in the vigorously moving molecules at the higher temperature transferring some of their energy to the slower molecules at the lower temperature, by continued collision. What happens in the case of any *particular* molecule we do not know; any particular movement may be due to a vast number of "chances". The law of Entropy is thus a law of very large numbers; it becomes a *Statistical* law; and Boltzmann showed mathematically how the law could be deduced from the kinetic theory by simple application of the statistical rules of the calculus of probability. The basic assumption made is that all possible molecular velocities in all possible directions are in themselves *equally probable*, an assumption which has been proved correct for all ordinary temperatures.

To some minds statistical laws are repugnant; so are the laws of probability. But consider how often, even in science, our reasoning is necessarily based on average effects. We never consider blades of grass or raindrops or snowflakes separately; we study them in masses, and though we know that every individual blade, raindrop, or snowflake is different from every other, we deliberately ignore the differences and reason about them in large numbers, usually forgetting that the laws we formulate concerning them are statistical and representative of averages. When we are dealing with molecular effects, it is simply impossible to deal with individuals, and the effects we obtain from experiments are necessarily only very roughly representative of the effects individually. In point of fact physicists of the present day recognize, especially in connexion with their study of atomic structures, that the calculus of probability must enter very largely into their work. They cannot obtain certainty, for they do not know all the facts. They have therefore to be satisfied with a greater or less degree of probability, and more often than not this degree can be expressed with mathematical accuracy.

Throw up a score of pennies. The chance that they will

come down all heads or all tails is extremely small, but there ~~is~~ a chance, and if the experiment be tried a very large number of times the chance will, with very great probability, occur. In practice the mathematician's well known Laws of Probability are, *in the long run*, fully borne out by experiment, and the reader need not hesitate to accept the Laws with confidence.

It comes to this: that the Law of Entropy is *very probably true*. But since the Law is, at bottom, a statistical one, there is a *chance* of some or all of the dissipated energy being "collected together" again, reversing its direction of action, and becoming useful again. A completely and finally run-down universe need not therefore be thought of as something absolutely inevitable. *Given time enough*, the very remotest chance will almost certainly materialise.*

BOOKS FOR REFERENCE:

1. *Modern Physics*, Theodor Wulf, trs. C. S. Smith.
2. *Theoretical Physics*, W. Wilson.
3. *Modern Physics*, H. A. Wilson.
4. *A Text-Book of Physics*, ed. A. W. Duff.
5. *Heat and Thermodynamics*, J. K. Roberts.
6. *Theory of Heat*, Clerk Maxwell.
7. *Treatise on Natural Philosophy*, Thomson and Tait.
8. *Lectures on Theoretical Physics*, H. A. Lorentz.
9. *Opticks*, Newton.
10. *Waves and Ripples*, Fleming.
11. *Lectures on Light*, Tyndall.
12. *Thermodynamics of Fluids* and other kindred papers by Josiah Willard Gibbs (1837-1903), a Yale professor.

* Both the subject of Thermodynamics and that of Probability are very largely mathematical and difficult for the non-mathematician to follow. For some simple experiments on the tossing of coins, and of the harmonizing of theory with experiment, see the author's *Scientific Method*, pp. 264-5.



SIR J. J. THOMSON
Photo. Russell



LORD RUTHERFORD
*From a Painting by Oswald Birley,
by permission of the Royal Society*

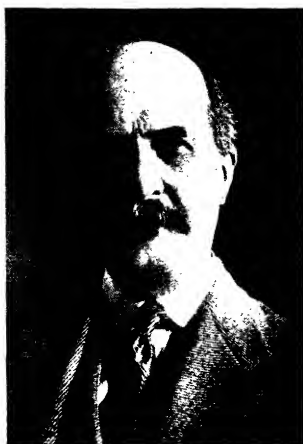

SIR WILLIAM BRAGG
Photo. Hoppé



PROFESSOR MAX PLANCK
Photo. Exclusive News Agency

CHAPTER XXXVII

Some Problems of Modern Physics

It was the custom of those of us who taught science forty-odd years ago to complete the course in chemistry by making some attempt to "classify" the chemical elements. The usual basis of this classification was the atomic weights, for attention had long before been drawn to an obviously deep-seated relation of some kind between these weights and the properties of the various elements.

As far back as 1829, for instance, Johann Wolfgang **Döbereiner** (1780-1849), a German Professor of chemistry at Jena, had drawn attention to the existence of closely similar elements in sets of threes (*triads*); if in each triad the three elements were arranged in order of their atomic weights, the middle one of the three, (1), had an atomic weight almost exactly the arithmetic mean of the other two; (2) exhibited properties intermediate in character between those of the other two. The three following triads illustrate this relation:

Chlorine.. 35.46	Sulphur .. 32.06	Calcium .. 40.07
Bromine.. 79.92	Selenium .. 79.2	Strontium.. 87.63
Iodine .. 126.92	Tellurium.. 127.5	Barium 137.37

In 1863 John Alexander **Rena Newlands** (1838-98), an English consulting chemist, discovered a surprising regularity when the elements were placed in the order of ascending atomic weights. There was a regular periodicity of chemical properties. Each element seemed to resemble closely the eighth element beyond or before it in the list. Newlands referred to his discovery as the *Law of Octaves*. But this regularity did not by any means apply to the whole

of the elements, and the law did not find general acceptance.

In 1869, Dmitri Ivanovich Mendeléeff (1834-1907), a Russian chemist, enunciated the Periodic Law: *The physical and chemical properties of the elements are periodic functions of their atomic weights*. Fig 94 shows a modern form of Mendeléeff's Periodic Table, in which the elements are numbered off according to their "atomic numbers". We shall refer to these numbers later. Mendeléeff's generalizations from his own periodic scheme were a great advance on any that had been made by earlier chemists, and his predictions of the properties of then undiscovered elements have since been borne out.

A year later, in 1870, Julius Lothar Meyer (1830-95), a German who became Professor of chemistry at Tübingen, examined with great care the recurrence of physical and chemical properties in various forms of classified schemes of the elements. Amongst the physical properties he found that the recurrence of density was very striking, for it regularly increased and decreased in each period. The connexion between density and atomic weight is best exhibited by taking the *atomic volume* instead of the density, i.e. the volume occupied by the atomic weight, instead of the weight of the unit volume.

The graph which Lothar Meyer constructed to show the relation between the atomic volume and the atomic weight is now rather out of date, and fig. 95 shows Professor Caven's form of it. Observe how related elements occupy analogous positions on the curve; for instance, the alkali metals sodium, potassium, rubidium, and caesium, occupy striking maximum positions, the halogens chlorine, bromine, and iodine are on ascending parts of the graph; the alkaline earth metals, calcium, strontium, and barium, are on descending parts. Readers interested in chemistry should examine the graph for the periodic recurrence of such physical properties as melting-point, malleability, coefficient of expansion, conductivity for heat and electricity, colours of salts in solution. The more the graph is examined, the more the conviction grows that

GROUP	0	I	II	III	IV	V	VI	VII	VIII
1st Short Period	2 Helium 4 00	3 Lithium 6 94	4 Beryllium 9 1	5 Boron 10 9	6 Carbon 12 00	7 Nitrogen 14 008	8 Oxygen 16 000	9 Fluorine 19 00	10 Neon 20 18
2nd Short Period	10 Neon 20 18	11 Sodium 23 00	12 Magnesium 24 32	13 Aluminum 25 98	14 Silicon 28 3	15 Phosphorus 31 04	16 Sulfur 32 08	17 Chlorine 35 46	18 Argon 36 9
1st Long Period	18 Argon 36 9	19 Potassium 39 10	20 Calcium 40 07	21 Scandium 45 1	22 Titanium 48 1	23 Vanadium 51 0	24 Chromium 52 0	25 Manganese 54 93	26 Iron 55 84
		29 Copper 63 57	30 Zinc 65 37	31 Gallium 70 10	32 Germanium 72 5	33 Arsenic 74 96	34 Selenium 79 2	35 Bromine 79 92	27 Cobalt 58 97
2nd Long Period	36 Krypton 83 8	37 Rubidium 85 46	38 Strontium 87 63	39 Yttrium 88 91	40 Zirconium 90 6	41 Niobium 92 9	42 Molybdenum 95 9	43 Manganese 95 9	28 Nickel 58 68
		47 Silver 107 88	48 Cadmium 112 40	49 Indium 114 8	50 Tin 118 7	51 Antimony 121 77	52 Tellurium 127 5	53 Cadmium 125 92	44 Ruthenium 101 7
2nd Long Period containing the rare earth group	54 Xenon 132 81	55 Cesium 132 81	56 Barium 137 37	57 Lanthanum 138 9	58 Cerium 140 25	59 Praseodymium 140 9	60 Neodymium 144 3	61 Promethium 144 3	45 Rhodium 102 9
									46 Palladium 106 7
									47 Silver 107 88
									48 Cadmium 112 40
									49 Indium 114 8
									50 Tin 118 7
									51 Antimony 121 77
									52 Tellurium 127 5
									53 Cadmium 125 92
									54 Xenon 132 81
									55 Cesium 132 81
									56 Barium 137 37
									57 Lanthanum 138 9
									58 Cerium 140 25
									59 Praseodymium 140 9
									60 Neodymium 144 3
									61 Promethium 144 3
									62 Samarium 150 4
									63 Europium 152 0
									64 Gadolinium 157 3
									65 Terbium 158 9
									66 Dysprosium 162 5
									67 Holmium 164 9
									68 Erbium 167 3
									69 Thulium 168 9
									70 Ytterbium 173 0
									71 Lutetium 175 0
									72 Hafnium 178 6
									73 Tantalum 181 5
									74 Tungsten 184 0
									75 Rhenium 186 3
									76 Osmium 190 9
									77 Iridium 193 1
									78 Platinum 195 2
									79 Gold 197 2
									80 Mercury 200 6
									81 Thallium 204 0
									82 Lead 207 2
									83 Bismuth 209 0
									84 Polonium —
									85 Astatine —
									86 Radon (radioactive) 222 0
									87 Francium —
									88 Radium 226 0
									89 Actinium —
									90 Thorium 232 0
									91 Protactinium 231 0
									92 Uranium 238 0
									93 Neptunium —
									94 Plutonium —
									95 Americium —
									96 Curium —
									97 Berkelium —
									98 Californium —
									99 Einsteinium —
									100 Fermium —
									101 Mendelevium —
									102 Nobelium —
									103 Lawrencium —
									104 Rutherfordium —
									105 Dubnium —
									106 Seaborgium —
									107 Bohrium —
									108 Hassium —
									109 Meitnerium —
									110 Darmstadtium —
									111 Roentgenium —
									112 Copernicium —
									113 Nihonium —
									114 Flerovium —
									115 Moscovium —
									116 Livermorium —
									117 Tennessine —
									118 Oganesson —

FIG. 94

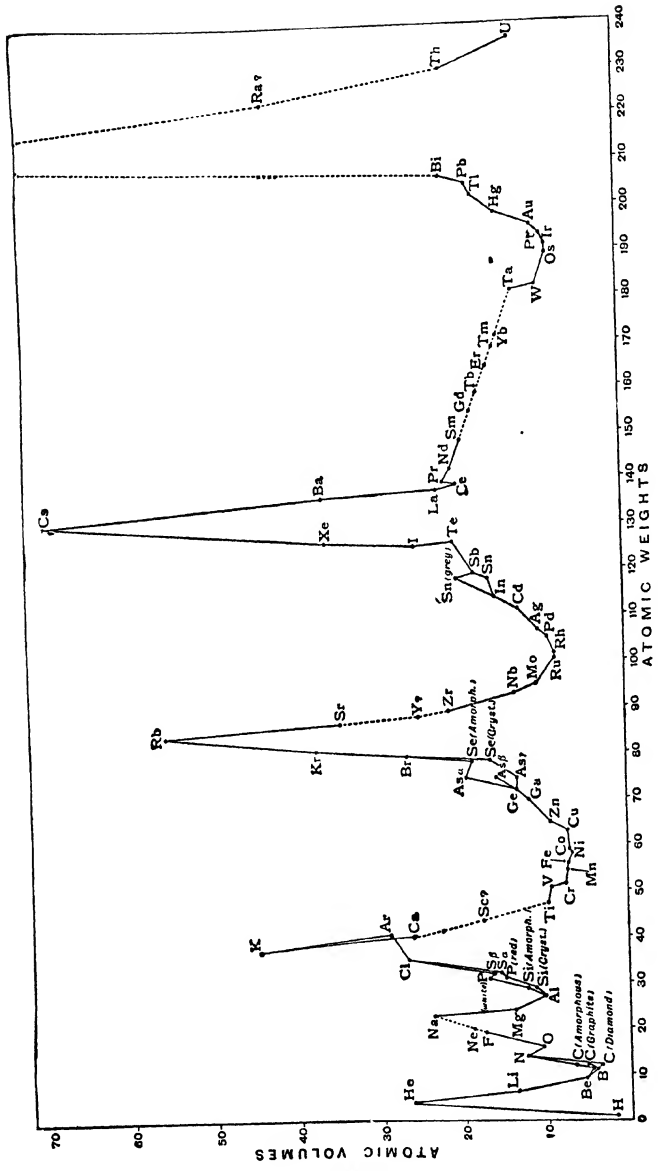

Fig. 95

it holds a profound secret. It is quite true that the curve as originally drawn was found to contain many imperfections and anomalies; assumptions were made which have since had to be abandoned. The Periodic Law, even if it is not yet in its final shape, is, however, now admitted to be one of the foundation stones of chemistry. As we shall see, the conception of atomic weight has been displaced by the conception of *atomic number*, and this new conception has contributed much to the removal of the anomalies of the Periodic Law as formerly laid down.

“Modern Physics” is very largely concerned with the structure of the atom. The following topics will be considered in this chapter:

1. *Rays, Radiation, Radioactivity.*
2. *The Atom: Fundamental Facts and Inferences.*
3. *Modern Theories of the Atom.*
4. *The Modern Molecule.*

1. Rays, Radiation, Radioactivity.

Electric Discharges in high Vacua. Just as teachers of chemistry a generation ago completed their course of instruction by touching upon the Periodic Law and admitting that its inner significance was not known, so teachers of electricity completed their course by showing pretty electric discharge effects with Geissler tubes and admitting that such effects remained without any sort of explanation. The so-called “electric egg” (an egg-shaped closed tube) (fig. 96) allowed these discharge effects to be seen clearly. When the egg, which had been exhausted as completely as possible by the air-pump, was connected up with an induction coil, three separate effects were noticed: (1) a purple-coloured luminous sheath extended from the



Fig. 96

anode (the positive electrode) to within a little distance of the cathode (the negative electrode); (2) the anode was surrounded by a bluish glow; (3) the blue and purple lights were separated by a small interval of darkness. If other gases were used instead of air, the tints changed, though there was always a marked difference between the tints at the two electrodes. If instead of the egg-shaped bulb a long tube was used, as constructed by Geissler of Bonn, and exhausted as completely as possible, a beautiful stratification phenomenon made its appearance. Fluorescent substances were often introduced into such tubes, for the sake of the brilliant effects they produced.

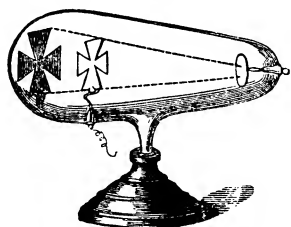

Fig. 97.—Crookes shadow tube

But the explanation? Eventually, the tube revealed three secrets.

(1) **Cathode Rays.** It was the distinguished English chemist, Sir William Crookes (1832–1919), who made the first real advance. By means of an improved Sprengel pump, he obtained a much higher degree of exhaustion of the tubes, and a new set of phenomena was the result. As the exhaustion proceeded, the dark space in front of the cathode increased and seemed to drive back the positive glow into the anode; eventually the dark space seemed to fill the whole tube, and then the surface of the glass glowed with a phosphorescent light. If the cathode was flat, and if an object was placed in the dark space, a distinct shadow of the object was projected in the glass tube (fig. 97). Something, though invisible, was obviously emanating from the cathode, and to this Crookes gave the name of *radiant matter*, or **cathode rays**. These rays always proceeded in straight lines and were always normal to the emitting surface of the cathode. Glass exposed to them became strongly phosphorescent, and a small delicately balanced wind-mill in the tube was set in rotation by the successive impacts of the cathode rays upon its blades. The rays acted only on those surfaces which were directly visible

from the cathode. If the cathode was concave, the rays could be made to converge on an object placed at the centre of curvature and thus be made to heat a piece of platinum foil to incandescence.

Certain other investigators identified the cathode rays with invisible light of very short wave-length, but Crookes regarded them as material particles. They were turned aside by a magnet just as if they were a stream of *negatively charged particles*, the particular direction clearly indicating that the charges were negative. Crookes was of opinion that they could not exist except in the highly exhausted tube, but Philipp Lenard (*b.* 1862, Professor of Physics at Heidelberg) let them emerge into the open by putting a small window into the tube (mica, or collodion, or gold-leaf, is a suitable substance for the window). The rays were thus shown to have a *penetrating* power, though they can travel only a few millimetres in air at ordinary pressure. The fact that they have this penetrating power suggests that they are really projectiles, not waves. *Outside* the tube cathode rays are called *Lenard rays*.

Later on it was proved that these negatively charged corpuscles could not be derived from the metallic cathode. They were destined to be identified with *electrons*, part of the "mother-stuff" of all atoms whatsoever.

(2) **Positive Rays.** The cathode rays are only one of the three secrets revealed by the Crookes tube. The second concerns the discharge at the positive electrode or anode. The anode rays are known as **positive rays**, or *anode rays*, or *canal rays*. The last term was applied to them in 1886 by Eugen Goldstein, a German physicist of the Royal Observatory, Berlin, who used a perforated cathode in the vacuum tube and saw a violet light streaming through the perforations. A magnet bent their straight-line paths into curves so that they were apparently corpuscular. These deviations were opposite in direction to those of the cathode rays, and the charges were therefore, as expected, positive.

(3) **X-rays.** The third secret of the Crookes tube were

the "X" rays (X standing as a symbol for the unknown). By means of a modified form of tube, a cathode stream may be made to impinge upon an obliquely placed platinum reflector forming the anode (fig. 98). The German physicist, **Wilhelm Konrad von Röntgen** (1845-1923), discovered, *outside* such a tube, the remarkable radiation to which he applied the now familiar term "X-rays". Many substances opaque to ordinary light are transparent to these rays, and thus the interior structure of many opaque objects, such as the human hand, can be rendered visible by throwing the shadow of the object on a photographic plate to be afterwards

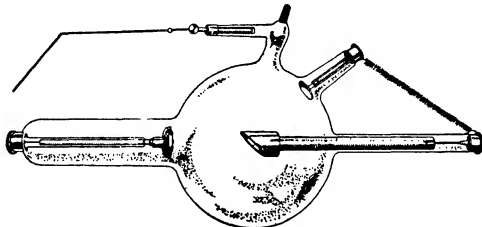

Fig. 98—X-ray Tube

developed. X-rays do not produce the sense of vision when they fall upon the eye, and they do not render ordinary objects visible; but they affect an ordinary photographic plate, and they produce fluorescence in certain substances, especially the platino-cyanides. Their course is always straight, and they are not bent by electric or magnetic fields; they are therefore *not charged particles*. They behave like *rays of light*, and have been identified as electro-magnetic waves of very short wave length. It is this exceedingly short wave-length, and their consequential hard stabbing nature, that carry them through many opaque bodies. The penetrative power of the rays increases with the power of the induction coil which is used to work the tube. The tube now in common use was designed by **W. D. Coolidge**, the American physicist.

It should be noted that all these effects of electric discharges in high vacua—cathode rays, positive rays, and



Tracks of α Particles by C. T. R. Wilson

From "Proceedings of the Royal Society"



Enlargement of portion
of preceding photograph

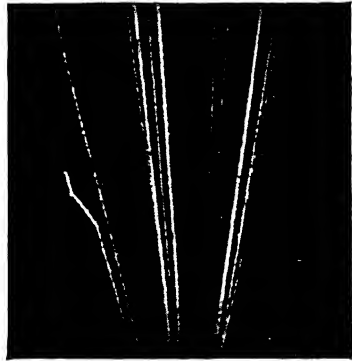

Photographs of α -ray tracks through nitrogen, by P. M. S. Blackett, showing collision between α -ray and nitrogen atom, at which a track branches into a thin straight track due to the ejected proton and a thick track due to the nitrogen atom combined with the α -ray.

X-rays—are produced artificially and are under human control. But there is a set of analogous effects which are entirely beyond human control; they are the phenomena associated with Radioactivity.

Radioactivity. The eminent Frenchman **Henri Poincaré** became interested in the fluorescence produced by X-rays in the glass of the vacuum tube, and he suggested that the rays from ordinary fluorescent and phosphorescent substances should be examined, in order to see if any rays were produced by them similar in nature to the X-rays. **Antoine Henri Becquerel** (1852-1908) undertook the examination, and, by chance, amongst the substances he examined were some of the compounds of uranium, the very last of the elements arranged in accordance with the principles of the Periodic Law, and having the heaviest and most complex atom of all atoms.

It should be understood that a *phosphorescent* substance is one which changes the character of the light incident upon it to a different wave-length or colour; this secondary light persists after the extinction of the exciting cause, and the substance shines in the dark with characteristic colours. A *fluorescent* substance is essentially similar, but in this case the secondary light does not persist long enough to be separately observed without special apparatus; it mixes with the primary light and gives the illuminated substance a peculiar “fluorescent” glow. X-rays afford an excellent illustration of fluorescence, for though quite invisible to the eye they are plainly visible when they fall on such a fluorescent substance as barium platino-cyanide.

On a thin metal tray Becquerel placed one of the fluorescent uranium compounds, placed the tray on the film side of a photographic plate enclosed in a black paper envelope, and put the whole away in the dark for some weeks. On developing the plate it was found to be fogged beneath the uranium compound in the tray. The uranium compound had emitted rays which had the power, like X-rays, of traversing a sheet

of metal. It was quickly found that neither sunshine nor fluorescence really had anything to do with the phenomenon, but that the emission of the rays from uranium or any of its compounds, whether these are fluorescent or not, was a spontaneous and inevitable process.

The new phenomenon aroused intense scientific interest, for it was soon convincingly demonstrated that radio-active elements are spontaneously and continuously emitting energy in new forms without any apparent external stimulus or supply: that they are, moreover, naturally undergoing transmutations into other elements. The rays thus naturally given out, though fairly closely corresponding to the rays artificially produced by the vacuum electric discharge, are in quality of a higher order than the latter. And just as they are given out without external stimulus or supply of energy, so no known process is able to produce them in non-radioactive matter. We are utterly unable to prevent their emission or to affect in the slightest degree the processes in which they originate in radio-active substances. This is the great feature of radio-activity. The chemist has no more control over it than the astronomer has over the movements of the planets.

We owe much of our knowledge of Radioactivity to **Madame** (Skłodowska) **Curie** (*b.* 1867), the daughter of a Polish professor, who went to Paris to research in chemistry and there married a French physicist, **Pierre Curie** (1859–1906). Husband and wife researched together until the former's death. Madame Curie is now Professor of Physics at the Sorbonne in Paris.

Madame Curie knew, to begin with, that uranium was a radioactive element, and she asked herself if any other of the elements were radio-active. She then entered upon a systematic investigation, and soon discovered that the very next element to uranium on the "Periodic" list, thorium, was radioactive. The oxide of thorium is the main constituent of the Welsbach incandescent gas-mantle, though radioactivity seems to be unconnected with the light-giving properties of the mantle. If such a mantle is cut open, laid out flat on a

thin sheet of aluminium foil, burnt off, and the whole carefully wrapped up in a light-proof envelope and placed on the film side of a photographic plate, the result on developing the plate after a fortnight or so will be a perfect photograph of the laid-out mantle. The rays from the ash have thus done effective work even after penetrating the metal foil.

In investigating the radioactivity of uranium, Madame Curie found that the natural uranium minerals were far more radioactive than could be accounted for by the uranium they contained. This applied specially to the ore pitchblende, then mined principally in Bohemia. She inferred that the mineral must contain elements more powerfully radioactive than uranium, and eventually she discovered three of them. One she named *Polonium*, after her native land; the second *Radium*; the third *Actinium*. These three elements exist in almost infinitesimally small quantities, but they are excessively active. Of the three, Radium alone exists in quantities sufficient for the chemist to work with in a really practical way. Even so, a ton of the most productive pitchblende, containing 50 per cent of uranium, yields less than three grains of radium. The process of extraction is laborious and expensive, so much so that the price of radium is nearly a hundred thousand times that of gold, weight for weight.

The discovery of radium was a challenge to physics, for the doctrine of the conservation of energy seemed to be defied. Every two days, radium emits more energy than can be obtained from the same weight of any combustible or explosive substance in the most energetic chemical changes known, and even after a quarter of a century a given specimen shows no apparent sign of change or exhaustion. It maintains itself indefinitely at a temperature several degrees above that of its surroundings.

An ingenious explanatory hypothesis of this spontaneous evolution of energy has been put forward by Lord **Rutherford** and Professor Frederick **Soddy** (*b.* 1877). It is that, during a given interval of time, a definite proportion of the

atoms of a radioactive element become unstable and *disintegrate* with the emission of a relatively large amount of energy, the result being the formation of a new element. This element is in turn unstable, and, in a given time, a different but definite proportion of its atoms disintegrate into a third element; and so on. Eventually a stable element is produced. The hypothesis has been worked out in great detail, and there is a very considerable amount of experimental evidence to support it.

The rays emitted by radio-active substances are of three types, and are called α , β , and γ rays, respectively. As a rule either α rays alone are emitted, or β and γ rays combined. The three types of radiation possess in common the power of acting on a photographic plate, of producing fluorescence in certain compounds, and of ionizing gases in their immediate neighbourhood. In many respects they are singularly like the anode rays, the cathode rays, and the X-rays, respectively, artificially produced in the vacuum discharge tube

(i) α -rays. These are positively charged helium atoms shot out with enormous velocities, varying in different cases from $\frac{1}{20}$ to $\frac{1}{13}$ of the velocity of light, that is from 9000 to 14,000 miles a second. No material projectile of anything like this speed has ever before been available, and this new weapon has told us much about the inner structure of the atom. The particles are really helium *nuclei*, that is helium atoms robbed of their two satellite electrons and carrying two positive charges. This will be more clearly understood in a future section.

(ii) β -rays. These are high-velocity electrons and are identical in nature with the cathode rays produced in a vacuum tube, but they differ from the cathode rays in having a much greater velocity; indeed this velocity may, in certain cases, nearly reach the velocity of light. The larger ratio of charge to mass in the β particle, compared with the α particle, is shown by the much greater deflection of the path of the

former when exposed to a magnetic field. The deflections obtained are naturally in opposite directions, owing to the charges on the two types of radiation being of opposite signs. Owing to the enormous velocity of the β particle and to its small mass ($\frac{1}{1845}$ that of the hydrogen atom), the penetrating power of the β radiation far exceeds that of the α radiation.

(iii) γ -rays. γ -rays accompany and are connected with β rays much in the same way as X-rays accompany and are connected with the cathode rays in a vacuum tube. They

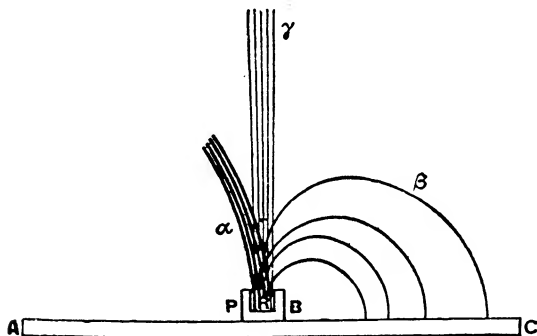

Fig. 99.—Curie Rays

are of the same nature as X-rays and light, i.e. they are non-material and not charged; they are described as electromagnetic waves in the æther. They are very penetrating, and those from 30 mgm. of radium have been detected after passing through 30 cm. (12 in.) of iron. Since γ rays are emitted only by radioactive bodies which also emit β rays, it seems probable that γ rays are somehow produced by β rays, just as X-rays are produced by the impact of the high-velocity cathode rays on the anti-cathode of an X-ray tube.

The effect of a magnetic field upon the three types of rays is clearly shown by a diagram due to Madame Curie (fig. 99). A small quantity of a radioactive substance P is placed in the deep hole of a lead container B, resting on a

plate AC, and is supposed to be emitting a pencil of rays upwards in the plane of the paper. Passing through this plane, at right angles to it, there are supposed to be lines of magnetic force produced by an electromagnet (not shown) with the S-pole below the plane of the paper and the N-pole above it. The γ rays pursue their course, unaffected; the β rays are easily coiled up into circles of varying radii; the powerful α rays are very slightly deviated (much exaggerated, for clearness, in the figure) in the opposite sense.

The reader should carefully compare the artificially produced rays of the vacuum tube with the natural rays of radioactivity. In essential respects the parallelism is exact.

	Character	Electric charge	Artificial Rays (Vacuum discharge tube)	Natural Rays (Radioactive)
1	Corpuscles	Positive	Positive or Anode	α -rays (helium ions)
2	Corpuscles	Negative	Cathode (electrons)	β -rays (electrons)
3	Waves	Uncharged	X-rays (very penetrating)	γ -rays (very penetrating)

The ambiguous character of the terms "corpuscles", "waves", and "rays" will be referred to in the next chapter.

The important thing about all these corpuscles and waves, artificial and natural, is the use to which they are put experimentally in the investigation of the structure of the atom.

2. The Atom: Fundamental Facts and Inferences.

During the last 20 or 30 years eminent physicists in many parts of the world have been engaged in researches on the structure of the atom. To give in a few pages even a bare outline of all they have done would be impossible. In this section, therefore, we shall merely quote the main facts, and the inferences therefrom, that are now generally recognized and acceptable, and we shall then give outlines of a few typical experiments that support such facts and inferences.

The more doubtful and disputed hypotheses we reserve for the next section.

(1). **The primitive stuff of atoms.** The atom, instead of being an indivisible thing, which its name implies, is now known to be complex. The atoms of all elements are built up mainly from two kinds of ultimate constituents, viz. *protons* * and *electrons*. The atom of one element differs from the atom of another element simply in the number of protons and electrons it contains. All protons are alike and are believed to be simply positive charges of electricity; all electrons are alike and are believed to be simply negative charges of electricity. The proton is very dense, and its mass is 184 $\frac{1}{2}$ times that of the mass of the extremely light electron. According to one well-known hypothesis, the atom is analogous to the solar system, in that it has a heavy dense *nucleus* round which *electrons revolve*, like planets revolving round the sun. The simplest of all the atoms is the hydrogen atom; its nucleus consists of a single proton, with a single electron revolving round it. It is the simplest possible solar-like system, being comparable with the earth and its solitary satellite, the moon.

(2) **Atomic weight.** The weight of the electrons is entirely negligible, so that when we think of the atomic weight we may think simply of the *sum total of all the protons* within the atom. Some of the atomic weights are not whole numbers. This is not because protons are divisible but because some elements are really mixtures, and the atomic weight represents the *average* weight of the constituents. These constituents are called *isotopes*, and they always have integral atomic weights. The term suggests *equal positions* (Gr. ἴσος and τόπος) in the Periodic table. All the properties of isotopes are identical, save that of mass. There are, for instance, two

* The word *proton* (Gr. πρῶτος, first) must not be confused with *photon* (Gr., φῶς, light). A *proton* is a "first" or primitive particle; cf. *proto-zoa*, first animals. A *photon* is a light corpuscle or light quantum; cf. *photo-graph*, a light picture. A photon differs from a proton and an electron in that it is never at rest but is always travelling at 300,000 km. a second. Photons are the hypothetical constituents of light.

sorts of chlorine, absolutely indistinguishable, except that their atomic weights are 35 and 37. When we "make" chlorine we make a mixture of the two isotopes, with an atomic weight of 35.46. Copper is generally said to have an atomic weight of 63.57; really this is the average weight of the mixture of two isotopes with atomic weights 63 and 65.

(3). **The Atomic nucleus.** The nucleus of every element with the exception of Hydrogen, contains both protons, and electrons. It always contains *all* the protons, and the total number of protons represents the atomic weight, the weight of a single proton being regarded as unity. Since the weight of the electrons is insignificant, the nucleus carries practically the whole mass of the atom. The nucleus as a whole is positively charged; nevertheless it consists of two distinct parts: (1) an inert core consisting of about half the protons neutralized by an appropriate number of electrons, apparently taking no part in the chemical properties of the atoms; (2) the remainder of the protons, grafted in some way on the neutral core, *active* with their positive charges and contributing to the electrical behaviour of the atom. The number of these *active protons* is always equal to the number of the revolving *planetary electrons*.

(4). **Atomic numbers.** The atomic number of an element represents the number of *active protons* in the nucleus, and is usually about half the total number of protons (rather less than half sometimes, there can be no fractions), and therefore about half the atomic weight. It follows that the number also represents the number of *planetary electrons*. The numbers run from 1 to 92 and represent the 92 elements respectively. Only 2 of the 92 elements now remain undiscovered.

The modern form of the Periodic Law is this: *The properties of elements are periodic functions of their atomic numbers.* Atomic numbers are now looked upon as more fundamental than atomic weights. In the Periodic Table arranged according to Atomic numbers (fig. 100), observe the successive "periods" of 2, 8, 8, 18, 18, and 32, represented

respectively, by $2(1^2)$, $2(2^2)$, $2(2^2)$, $2(3^2)$, $2(3^2)$, and $2(4^2)$. The table should be compared with figs. 94 and 95.

(5). **Electrons.** These were discovered by Sir J. J. Thomson. Whatever kind of atom he attacked, the only thing that he ever managed to drive out of it was one or more electrons, all identical, and all carrying the same electric charge. This charge is found to be the same as the unit charge in electrolysis.

The number of revolving planetary electrons in an atom is necessarily the same as the number of active protons, otherwise the atom would be electrically charged and not in its normal condition. The whole of the atomic "solar system" is presumably held together by electrical attraction between these two sets of particles. If there are one or more electrons too many, the atom is negatively charged; if one or more too few, the atom is positively charged.

It is the planetary electrons that determine the chemical properties of an element. At certain regular intervals in the Periodic Table there are certain elements known as the inert gases, argon, helium, &c., in which the planetary electrons are arranged in such a complete, symmetrical, and stable pattern, that the elements are "satisfied" to remain isolated, and to take no part or lot with their neighbours. On each side of an inert element occurs an element with either one more or one fewer electrons, and these elements are chemically active and tend to combine readily with each other; e.g. Na and Cl. Next door to these *monads*, as the chemist calls them, will be found *dyads*, in which the stable pattern of electrons will be diminished or increased by two. Again we have vigorous chemical action; e.g. Ca and O. The old and new Periodic Tables are worth careful examination from this point of view.

(6). **Statistics.** The following numbers are practically outside the comprehension of all except expert mathematicians. They are, however, worth pondering over. The reader ought to be able to convince himself that the atom with its constituent protons and electrons is utterly beyond

any sort of human visualisation. When we try to picture it, we are compelled to magnify it on an enormous scale, and then we are apt to think that the same physical laws which apply to big things necessarily apply to small. That way lies danger. From the figures we give, the reader may, for purposes of comparison, readily make up for himself such illustrations as the following:—Assume a single drop of water to be expanded as large as the earth. Any one of its contained atoms (the molecules as such may be ignored) would then be about the size of a large orange. The nucleus at the centre of the atom would be much too small to be seen with the naked eye, though it would be revealed by a microscope of fairly high power. (We shall return to this question of large numbers in a future chapter.)

- | | |
|----------------------------|---|
| (1). Weight of H atom: | 1.66×10^{-24} gram. |
| (2). Diameter of electron: | 10^{-13} cm. |
| (3). Diameter of atom: | 10^{-8} cm. |
| (4). Avogadro's number (N) | |
| | = no. of atoms in a gram of H |
| | = the reciprocal of the wt. of a H atom |
| | = 6×10^{23} . |

The number 10^{24} is a quadrillion, that is a billion of billions ($10^{12} \times 10^{12}$), and a billion is a million of millions ($10^6 \times 10^6$).

Experimental evidence. The preceding statements are now generally accepted as “facts”, though the evidence in their support is very largely of an inferential character. It is supported, it is true, by a large number of telling experiments, most of them designed and carried out by physicists of great eminence. In this connexion it is sufficient to mention the names of Sir **J. J. Thomson** and Lord **Rutherford**. Conviction of the truth of many of the facts is brought home, not so much from a single experiment as from converging lines of evidence from a large variety of experiments and from the substantial agreement among experts as to the interpre-

tation of the evidence. Even if the reader has only a very slight acquaintance with experimental physics, he will probably be able to appreciate the striking device underlying two or three of the following experiments—that of measuring the trajectories of particles subjected to the influence of electric and magnetic fields.

We have only space enough to outline a small number of the experiments and to give some indication of what the experiments teach.

I. Evaluation of mass and velocity of cathode particles. In 1897 J. J. Thomson (*b.* 1856) first successfully applied the method, which has now become classical, of

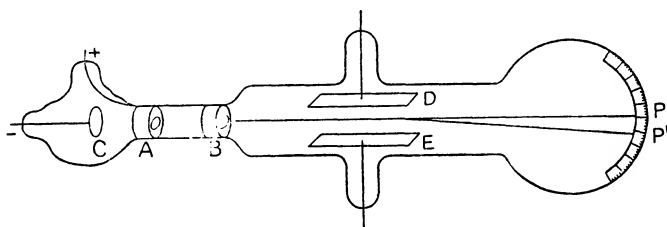

Fig. 101

determining the mass, charge, and velocity of the cathode-ray particle by measuring its deviation in magnetic and electric fields. Fig. 101 shows the form of tube he used. Cathode rays from C are directed (canalized) by passing them through two slits, A and B. They then pass between the oppositely charged plates D and E and impinge on a phosphorescent screen, producing a luminous spot at P. The charged plates deflect the rays in precisely the same manner as gravity deflects a projectile, fired horizontally, into a parabolic path, the negative plate repelling and the positive plate attracting the particles. When the current is off, the pencil of rays registers its position at P; when on, (say) at P¹. If a magnet is placed near the tube so that the magnetic lines of force pass through at right angles to the plane of the diagram, and the electric and magnetic forces be thus opposed, the strength of the magnetic

field can be adjusted to a value that will bring the luminous spot exactly back to P. The physicist is now able to evaluate the velocity and the mass of a cathode particle. The *velocity* is proportional to the ratio of the strengths of the electric and magnetic forces (in absolute measure). When the velocity is known, the *mass* (m) is easily found, for the *magnetic deflection* by itself is inversely proportional to the momentum (mv), and the *electric deflection* to the kinetic energy ($\frac{1}{2}mv^2$), of the particle. Strictly it is not m that is found, but m/e , where e is the charge carried by the cathode particle and must be determined separately.

Though since modified in many ways, this classical experiment of J. J. Thomson's was the real beginning of the investigation of the atom. Thomson was chief of the Cavendish Laboratory at Cambridge until 1918, when he was made Master of Trinity. His successor at the Cavendish Laboratory is Lord Rutherford, the most famous of Thomson's many former distinguished assistants and research workers.

II. Bombardment with alpha rays. Neptune, the major planet most remote from the sun, is rather less than 3,000,000,000 miles away from him. The diameter of the solar system is therefore in the neighbourhood of six thousand million miles. The only inhabitants of this vast space are the sun, the planets, and a few smaller bodies, spatially as insignificant, therefore, as a few midges flying about in some great hall. We can imagine a vast number of similar solar systems, fairly close together but sufficiently far apart for the outer orbits never to encroach on each other. Now imagine these solar systems bombarded from a great distance by a number of suns, say, all half the size of our own sun, and travelling at a speed of 10,000 miles a second. The vast majority of these bombarding suns would travel, unimpeded, in straight paths (we ignore gravitational effects). Now and then one might collide with a planet, knock it to pieces and continue its own journey. At rare intervals, a bombarding sun might collide with one of the huge central suns of a solar system. The con-

sequential damage would be serious, and the path of the bombarding sun (if this sun survived) would certainly be changed from the original straight line. If, on the other hand, each solar system had consisted of just one huge uncondensed spherical mass, instead of a relatively small condensed sun and planets, all widely separated, the bombarding suns would have met with much more frequent collisions, and though the density of the imagined great spherical masses would have been slight, the bombarding suns could hardly have continued in their original straight lines.

It occurred to Lord **Rutherford** (*b.* 1871), now Cavendish Professor and probably the most eminent of living physicists, to bombard atoms of gas, and to use for the purpose α -rays. He knew the α -rays to be Helium ions, and therefore to be fairly heavy, and he knew that they travelled with the great speed of something like 10,000 miles a second. A speck of radium with its never-ending magazine of α -ray bullets would provide the necessary gun. If such a gun fired its bullets into a gas, say air or hydrogen or nitrogen, what would happen?

The rays are invisible; how were they to be seen? A beautiful method of rendering the α -ray *tracks* visible to the eye and capable of being photographed was devised by **C. T. R. Wilson** (*b.* 1869, now Jacksonian Professor of Natural Philosophy, Cambridge). He sent the α -rays through dust-free air supersaturated with moisture, knowing that the ions themselves, instead of the usual dust particles, would be effective in bringing about precipitation of moisture. He induced the condition of supersaturation by expanding suddenly a saturated atmosphere, confined in a vessel, the vessel also containing a trace of radium on a needle point. Each α -ray particle traversing the air at the moment of expansion formed in its path a dense column of ions upon which the excess moisture instantly condensed, revealing clearly the whole track of the particle. Nearly all these tracks were perfectly straight, but a few indicated sudden bends (see Plate 18). What did these bends signify?

Clearly the great majority of the bombarding α -rays

passed through the atoms unimpeded, just as our imaginary bombarding suns passed through the solar systems, unimpeded. Relatively, therefore, an atom must be an empty thing. But *sometimes* there was a collision and a very effective one, for sometimes the bombarding α -ray particle was turned aside. There must, therefore, be a very small but very massive core to the atom.—And so the nuclear atom was born.

Professor **P. M. S. Blackett** has taken a very large number of photographs of this kind, and from them we have learnt a great deal about the structure of the atom. The measurement of the angle of track deviation is, as might be expected, of great importance.

Such evidence makes a convincing appeal to all people actually engaged in the work. There is, moreover, so much confirmatory evidence from other sources, that workers in the field no longer have any doubt about the main inferences drawn from the experiments. To see the experiments in progress adds enormously to one's feeling of conviction.

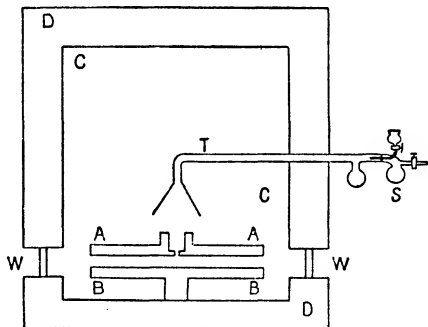

Fig. 102

III. Millikan's method of determining e (charge on electron). We said above (page 461) that e must be determined separately. This has been done by several well-known workers, notably by **J. J. Thomson**, **J. S. Townsend**, **H. A. Wilson**, and **R. A. Millikan**. The last named, **Millikan** (*b.* 1868), a distinguished American professor, devoted several years to perfecting the necessary apparatus for the experiment. Figure* 102 shows the essential part of

* Details of the apparatus are shown in fig. 3 of Cranston's *The Structure of Matter*.

it in diagrammatic form. AA and BB are two circular brass plates connected with a storage battery of 10,000 volts. Oil can be sprayed into the space above the plates by means of the atomiser S. A small pinhole in AA allows an occasional droplet to enter the electric field between the plates, this droplet being strongly illuminated by light entering the window W from an arc lamp. The plates are supported inside a metal box CC immersed in an oil tank DD. If required, X-rays can be admitted through the windows to produce additional ions near the droplet. The oil-drop is viewed through a telescope (not shown), a scale in the eye piece, and a chronograph registering hundredths of a second, making possible the measurement of the speeds of the drop. The few drops that fall through the small hole between the plates become charged, and usually have such masses and charges that they remain suspended in the electric field or move slowly up and down. A drop which moves slowly up is selected for observation and its velocity measured; the current is then turned off, and the velocity of the same drop, now falling, is again measured. By switching on and off the current, the drop may be kept under observation for hours, and its upward and downward velocities measured. All the necessary data are now available for calculating the value of the ionic charge e . The value was thus found to be

$$e = 4.774 \times 10^{-10} \text{ electrostatic units.}$$

The experiment showed conclusively that a droplet could never catch less than a whole e , and its charge could vary only by integral multiples of e . The magnitude and sign of the charge on the droplet made no difference to the rate of falling under gravity, so long as no electric field was operating. But the speed with which it was pulled up again after falling depended upon the number of e 's in its charge, which could only vary by integers, not continuously. The atomicity of the electric charge was thus most convincingly demonstrated. The speed at which it was pulled up by a field of known strength varied *abruptly* from one rate to

another. From this and the speed of the fall of the drop when no field was on, which was always the same, the magnitude of e could be deduced.

IV. Moseley's work. One of the most brilliant physicists of the last 50 years was killed, at the age of 27, in the fatal Gallipoli landing on August 10, 1915. This was **Henry Gwyn-Jeffreys Moseley** (1887-1915) who had shown how the atomic number of an element may be deduced from the X-ray spectrum. It was Moseley's work which first revealed the importance of atomic numbers, as distinct from atomic weights, and which formed the basis of much later work by **Sommerfeld** and others.

Ordinary and X-ray spectroscopy and ordinary chemical changes are concerned with the "planetary," negatively charged, electrons; they have nothing to do with either the protons or electrons in the nucleus. The wave-lengths of most X-rays are too short to be resolved into a spectrum by any grating that can be made mechanically, but particular *crystals* can be used as natural gratings of a far greater degree of fineness than even the best mechanically ruled gratings, for the atoms of a crystal are so arranged that their spacing is perfect and so remarkably close that X-rays can be diffracted by them. In 1908 **Barkla** had shown that any element, when irradiated by X-rays, *itself* emits a fluorescent radiation characteristic of that element and therefore having a characteristic wave length. In 1912 **Laue** had discovered that X-rays can be diffracted by natural crystals. (See the next section on *Theories of the Atom*.) An X-ray spectrometer is much like an ordinary spectrometer, except that the ordinary glass prism is replaced by a crystal of, say, potassium ferrocyanide, on a cleavage face of which the X-rays of any particular substance used as an anti-cathode of a discharge tube impinge. The radiation of a particular wave-length is reflected only when it strikes the crystal surface at a definite angle. The glancing angle has to be accurately measured, and then the wave-length is easily calculated. The wave-lengths of

X-rays are as small as atoms, or even smaller, but fortunately they retain the power of reducing the silver salts on a photographic plate. The wave-lengths being known, and the velocity being known, the frequencies are easily calculated. Figure 103 shows Moseley's famous "staircase"—a photograph of the X-ray spectra of the "K" series of several

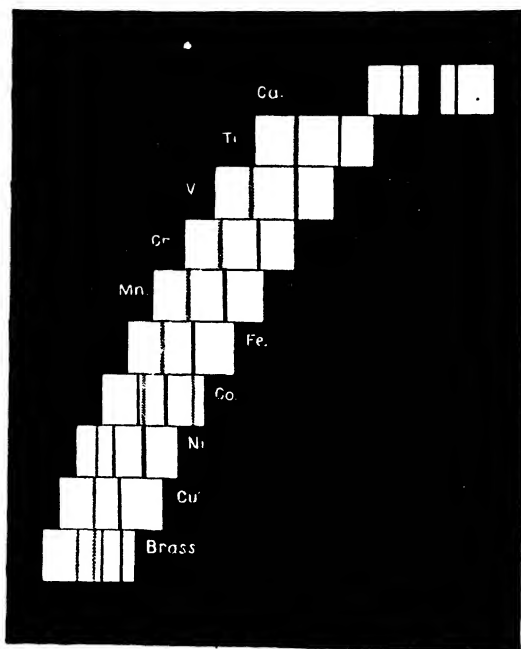

Fig. 103

elements. Observe that the spectrum of each element consists of two lines, one stronger, one weaker.

Moseley examined all the elements in the Periodic Table from aluminium to gold, and from their measured wave-lengths determined their frequencies. It was quite obvious from the staircase photograph that there was a regular increase of frequency (or decrease of wave-length) as we pass from element to element. What was the *law* underlying

this regularity? He took the square roots of the frequencies of the *stronger* line in each spectrum (see figure), and graphed the results against the corresponding atomic numbers of the elements under consideration. The graph was virtually a straight line, showing that the relation was one of simple proportion. The frequencies are, in fact, directly proportional to the squares of the successive natural numbers, each of these numbers being one less than the atomic number of the elements. It was thus experimentally established that the atoms of the chemical elements stepped from one to the

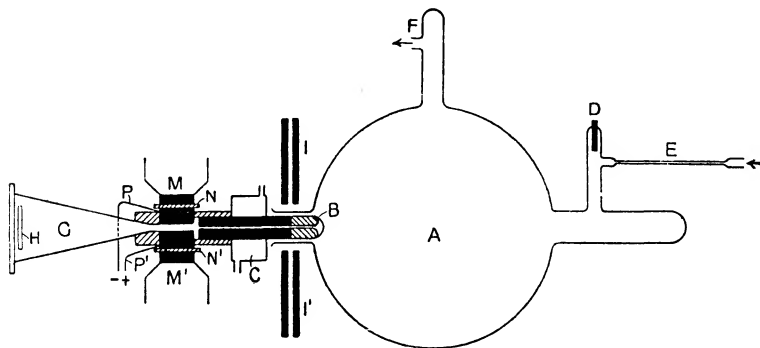

Fig. 104

other, by equal differences, in regular arithmetical progression. Moseley's own words were: "We have here a proof that there is in the atom a fundamental quantity which increases by regular steps as we pass from one element to the next. This quantity can only be the charge on the central positive nucleus". Thus he surmised that the indivisible positive proton was the step by which each element differed from the one below it.

V. Sir J. J. Thomson's Investigation of Positive Rays. Thomson showed that "positive rays" consist of positively charged particles, and he determined their velocity (v) and the ratio of charge to mass (e/m). The apparatus he used is shown in fig. 104. A is a glass bulb of 1500 c.c. capacity, with anode at D. Through the cathode B runs a very

fine tube, canalizing the positive rays which pass through it during the discharge; the rays then pass through the highly evacuated conical tube G and fall on the photographic plate H. P and P¹ are parallel plates of soft iron between the poles M and M¹ of an electromagnet and insulated from the latter by sheets of mica N and N¹. A magnetic field may be produced by the electro magnet; an electric field may be produced by connecting up P and P¹ with a battery. Shields of soft iron, I and I¹ prevent the magnetic field from disturbing the discharge in the flask A. The analysis of the rays depends on the actions of the magnetic and electric fields being "crossed", so that they deflect the beam in directions at right angles to one another and to the direction of the beam. When there is neither an electric nor a magnetic field between P and P¹ the particles travel straight on through the canalizing tube and strike the photographic plate normally at an "undeflected" spot; in an electric field, the spot will be deflected; in a magnetic field, the spot will also be deflected but in a plane at right angles to that in which the previous deflection took place. The simultaneous action of both fields will cause the spot to be deflected in both directions, and to appear at a point having co-ordinates x and y with reference to axes X and Y along the lines of separated electric and magnetic deflections. From simple mathematical considerations, y^2/x will be constant, and the locus of the spot will be a parabola. From these positive-ray parabolas, the value of m/e and therefore of m may be deduced. Plate 19 shows a number of parabolas obtained by Aston by this method, with the symbols of some of the positive ions producing them. The neon parabola is of special interest, as isotopes are clearly indicated. Field reversals result in curve reversals, as might be expected. (The principle of the experiment should be compared with that of experiment I.)

VI. Aston's Mass Spectrograph.* A new method of

* A photograph of the original mass-spectrograph set up by Aston in the Cavendish Laboratory appears in his *Mass Spectra and Isotopes*.

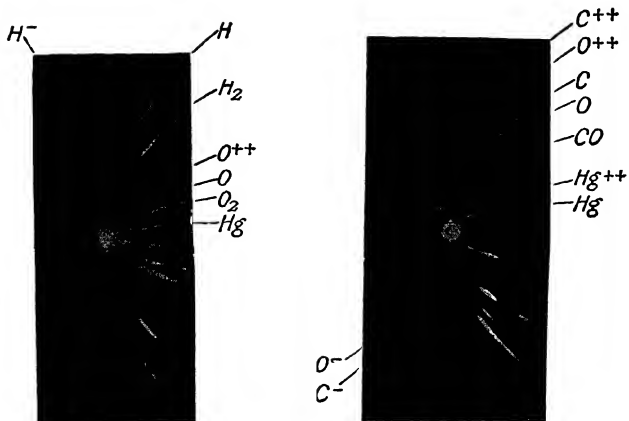

Photographs of Typical Positive Ray Parabolas

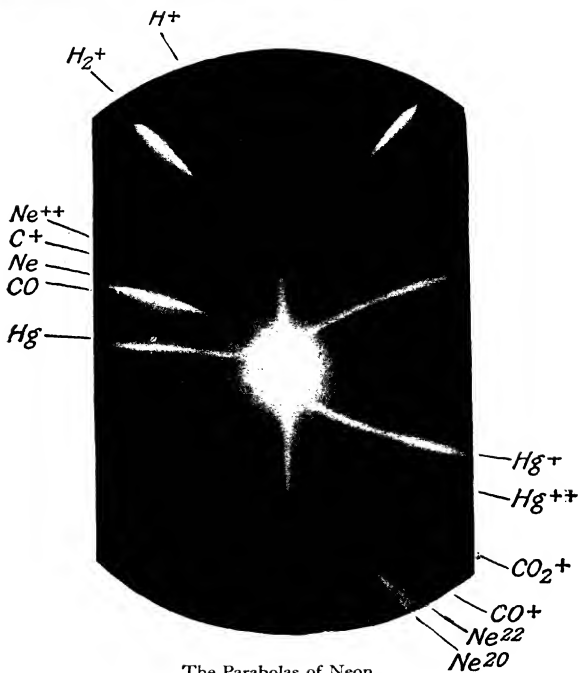

The Parabolas of Neon

From Aston, "Mass Spectra and Isotopes"
(Edwards Arnold & Co.)

positive ray analysis was devised by Dr. **Francis William Aston** (*b.* 1877), of Cambridge, which enabled him to obtain the value of m/e with much greater accuracy than by the parabola method. His apparatus is known as the "mass spectrograph". An outline diagram is shown in fig. 105.

The beam of positive rays is shown as a dotted line passing through the slits S_1 and S_2 to effect canalization, and then through the electric field between the parallel plates, P^1 and P^2 , to the central point Z , at which it is represented as

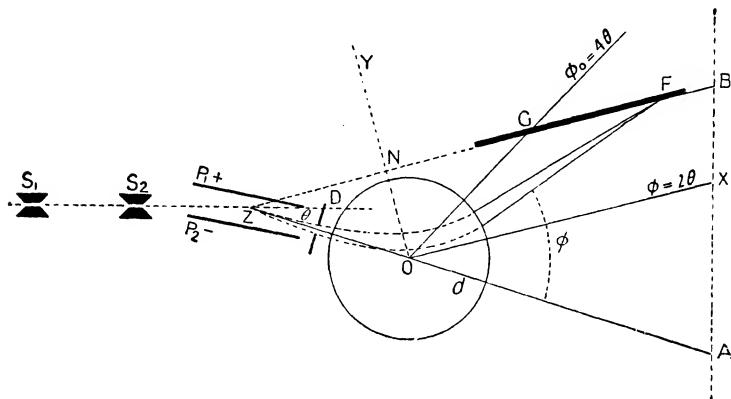

Fig. 105

deflected through an angle θ downwards, the actual deflection being, of course, gradual. From Z it is shown as a slightly divergent pencil passing through the magnetic field represented by the circle with O as centre, being turned upwards between 3θ and 4θ , and falling on the photographic plate FG at F , the plane of which passes through Z , the central point of the electric field. The easily deviated rays, with small m , fall near G , and those deviated with difficulty, with large m , fall near F . The result is that each particle registers an image of the slit on the photographic plate at a position depending on its mass (m) (strictly on its mass divided by its charge (m/e)). Thus lines on the plate are obtained one for each value of m . Such a series of lines is called a "mass-spectrum". In appearance the lines are not unlike those of

an ordinary spectrum, but they represent not wave lengths, but *masses*. (See Plate 20.)

Aston thus found that the relative masses of the atoms can be expressed by *integers*, within very small limits of error. For example the masses of the rays from C, N, O, and F, are proportional to 12, 14, 16 and 19 to within 1 part in 1000. (H rays are an exception, for taking $O = 16$, $H = 1.0077$, in agreement with the chemical atomic weight*.)

Amongst other things clearly shown in the mass-spectra is the heterogeneous nature of *neon*, which is clearly a mixture of isotopes. Our common definition of "element" evidently calls for modification.

3. Modern Theories of the Atom

J. J. Thomson's model atom consisted of a sphere of uniformly distributed positive electricity of the same diameter as the atom. Only the negative charges—the electrons—were discrete, and these were embedded in the positive sphere in the form of concentric rings or shells, in accordance with the successive "periods" of the Periodic Law. But the model did not explain satisfactorily the "scattering" of α -rays produced when atoms were bombarded by them, and it was gradually replaced by another conceived by Rutherford.

Rutherford's atom was designed mainly to meet the difficulty of scattering. It consists of a positively charged nucleus, very minute compared with the size of the atom, in which the essential mass of the atom is concentrated. Distributed around this nucleus, perhaps like planets around the central sun, are the electrons. The chemical properties are determined by the nuclear positive electric charge which conditions the distribution of the planetary electrons.

So far we are on fairly safe ground, as confirmed by such experiments as those referred to in the preceding section. That the nucleus consists of protons and electrons we are

* See Section 5 of this chapter.

reasonably certain, though we know nothing at all about their structural arrangement. That the electrons external to the nucleus are intimately concerned with the chemical and physical properties of the atom we are also reasonably certain, and an enormous amount of work has been done with the object of discovering exactly how these electrons are arranged and how they act. Perhaps we may put it this way: with the actual bricks and mortar of the atom we are familiar; of its architecture we are still profoundly ignorant.

If we are to construct an atomic model successfully, it must describe and explain, qualitatively and quantitatively, (1) the scattering of α -, β -, and X-rays; (2) all spectra phenomena, including the "series" in the visible and invisible parts of the spectrum; (3) the phenomena of radioactivity; (4) the existence and properties of isotopes; (5) the Periodic Law; (6) the laws of chemical valency and chemical combination; (7) the specific properties of chemical elements. No model so far devised has explained all these things, and it should be remembered that, even if some day one *is* devised, it will not necessarily truly represent the actual atom.

Are the parts of the atom with respect to one another in relative motion, or are they motionless? In other words is the atom a *dynamic* thing or a *static* thing? It is thus that the two main theories are differentiated. We will consider them in turn.

Bohr's dynamic model of the atom. This atom is described as "dynamic" because the extra-nuclear electrons are assumed to be in rapid motion round the nucleus. On the *classical* theory of electrodynamics, this implies instability, since any acceleration of an electron must be accompanied by radiation, by means of which the energy of the atom would thus be continually dissipated, the electrons finally falling into the nucleus. Further, as with the solar system itself, *any* orbit would be possible, the actual one depending on initial conditions; and we should expect not a series of sharp lines but a continuous spectrum. Actually, however, we do get a series of sharp lines, and the electrons do not fall into the

nucleus. The frequency of the spectral lines of atoms does not change with age. As long ago as 1873 Maxwell said that an atom of hydrogen, whether here or in Arcturus, bears upon it the stamp of a metric system as distinctly as does the standard metre preserved in Paris. The way out of the difficulty was found by Niels Bohr (*b.* 1885), Professor of Physics at Copenhagen, formerly a pupil of J. J. Thomson at Cambridge and afterwards of Rutherford at Manchester. Bohr advanced his theory in 1913.

Bohr suspected that there was some very intimate relation between the **Balmer** Law (see the last chapter), which had been deduced from the measured wave lengths of spectrum lines, and some sort of astronomical model. The formula was,

$$\lambda = B \left(\frac{n^2}{n^2 - 2^2} \right)$$

where λ is the wave length and n represents the series of natural numbers 3, 4, 5, 6, 7. Ritz afterwards used a modified Law,

$$R \left(\frac{1}{m^2} - \frac{1}{n^2} \right).$$

Bohr asked himself how he could reconcile the two following apparently antagonistic facts:

1. *According to the Ritz Law*, the frequencies of vibration of successive lines in the spectrum are represented by the difference of the reciprocals of the squares of the natural numbers.

2. *According to the law of gravitational orbits in astronomy*, the energy of a planet is proportional to the reciprocal of the radius of its orbit.

Applying the quantum theory to Rutherford's model of the hydrogen atom, Bohr postulated that although *any* planetary orbit round the *sun* is conceivable (depending merely on the original impulse with which the planet was originally shot forth) *there could be only specific orbits for electrons, the radii of these proceeding as the squares of the natural numbers.* This granted, everything else followed.

We are to suppose that in the (for instance) hydrogen atom there is a certain number of possible orbits in which an electron can revolve for an indefinite time at constant speed and distance from the centre, *without radiating*. Bohr called these the *stationary states*, meaning not that the electrons are stationary but that the *orbits* remain stationary, without shrinking because of a drain of energy. By thus preventing the electrons from radiating, he prevented them from falling into the nucleus.

There is nothing in Newtonian dynamics that enables us to determine the orbits in which an electron can revolve, and the rigour of Newtonian dynamics Bohr therefore abandoned. The existence of some responsible but unknown ultra-Newton-Maxwell principle is assumed: it is supposed that orbits can be selected upon the principle of "quantizing" the "action" of the system. This introduces Planck's radiation constant, to which we shall refer in the next chapter.

By hypothesis the orbits are stable, but an electron may pass from one orbit to another. Nothing is known exactly of this transition from one orbit to another, but spectra considerations suggested a further hypothesis, which we now proceed to outline.

Each orbit is supposed to have a characteristic rate of revolution, and an electron in a smaller and inner orbit must have a greater velocity than one in an outer. The innermost orbit, called the K orbit is a "one-quantum" orbit. The velocity in it is $\frac{1}{140}$ the velocity of light, and the revolution number is 6000×10^{12} per second. In this orbit we have the highest frequency and the shortest wave-length. It is the most stable orbit, and the single hydrogen electron is normally in it.

The next orbit, the L orbit, is a "two quantum" orbit. Then follow the M and N orbits, increasingly farther from the nucleus; and still farther orbits beyond, which may be ignored.

When an electron is excited from without (by collision, heat, an electric field, X-rays, &c.), it is apparently jerked

out from an inner orbit into an outer orbit, but it then has less stability. Left to itself, it jumps back, sooner or later, into some inner orbit. During this jump back, energy is liberated and is emitted in the form of mono-chromatic radiation (single-coloured light), that is, radiation of one wave-length. Only during these transitions is the light-energy radiated, and the energy emitted is the *difference* of the energy in the initial and final orbits. The *frequency* of the spectral lines produced by the transition is in this way determined. *Thus every spectral line is produced by an electron jumping from one orbit to another.* The particular rate of vibration depends both on the orbit jumped from and the orbit jumped into. A study of the spectra enables us to specify these two orbits.

The very essence of the hypothesis is that *an electron revolving steadily in an orbit does not disturb the æther.* But a jumping electron gives a sort of kick to the æther and sets up a wave. The frequency of this wave depends on the violence of the kick, i.e. on the energy liberated, and this frequency can always be easily determined by measuring the wave length of the spectrum line produced.

To produce K radiation and to produce K lines, an electron must be jerked into an outer orbit. The K ring of electrons (only 1 in Hydrogen) tries to complete itself again, and the missing electron may be furnished from the L or M or any other outer orbit. Whereas the process of excitation was accompanied by a gain of energy, the converse process takes place with loss of energy. According as the missing electron returns to the K orbit from the L, M, or N orbit, the energy set free will be different in amount. Hence there will be various possible K radiations, each of them represented by a definite wave length, and all of them together giving the K series of spectral lines. The K series occur high up in the violet.

To excite L radiation, an electron must be jerked out of the L orbit into an outer orbit. The L lines are the original Balmer series *and occur in the visible spectrum.* The charac-

teristic red line (Fraunhofer C) is produced by a jump from the M orbit to the L orbit; the blue line from N to L. And so on.

The *series*, and the *positions of the lines in the series*, are determined in this way:

1. The **series** is determined by the orbit *into* which an electron jumps.

2. The **lines in a series** are determined by the orbit *from* which an electron jumps.

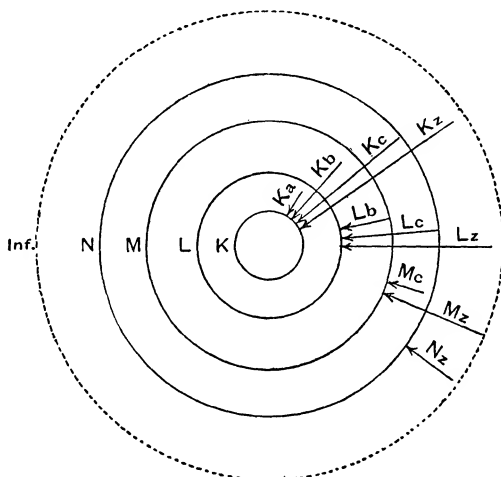

Fig. 106

3. The **fundamental** (lowest) line of a series represents a jump from the next orbit.

4. The **head** (highest) line of a series represents a jump from "infinity" (i.e. relatively an indefinitely great distance).

The results may be shown diagrammatically, as in fig. 106.

It may be asked why, since each series is so closely associated with a particular orbit, there is a *series* of lines instead of a single line. If electrons all jumped from the same outer orbit into the same inner orbit, their radiations *would* give rise to a single line. But if the Hydrogen is strongly excited, electrons will probably be jerked into many of the

outer orbits; the jumps back represent different energies, therefore different frequencies, and therefore different lines. We always deal with vast numbers of Hydrogen atoms, never with only one. So with all the other elements.

It should now be clearly seen in what ways Bohr broke away from the classical (Newton-Maxwell) theories of dynamics and electrodynamics. The main facts may be conveniently summarized: Bohr assumed the Rutherford atom, in which electrons are distributed around a small massive nucleus, and he assumed further that the electrons revolve in orbits under the inverse square law which prevails in ordinary electrostatics. He then made two new assumptions: (1) that the electrons can revolve in closed orbits *without radiating energy at all*. This is in contradiction to the classical theory which asserts that every acceleration of an electron must be accompanied by radiation. (2) That of the infinite number of different orbits which, from initial conditions, classical theory indicates as possible, *only certain discrete orbits are possible*, these being determined by certain quantum conditions. This, again is in contradiction to classical theory.

Adjudged by the classical theory of electrodynamics, Bohr's astronomical atom (as it may be called) implies instability, for, as we have already said, *any* acceleration of an electron must be accompanied by radiation, by means of which the energy of the atom would be continually dissipated, the electrons finally falling into the nucleus. Bohr avoided this difficulty by simply denying that classical relationships hold within the atom. To support his own novel assumptions, he adopted the quantum theory, and it must certainly be admitted that the quantum theory has proved its worth in many branches of electronic physics.

Hitherto no physicist has suggested a method by means of which the orbit hypothesis may be submitted to an experimental test. Its great merit as an hypothesis is that it is in exact accordance with a multitude of experimental results concerning spectrum lines.

Attempts have been made to develop Bohr's theory in

order that it may explain the chemical properties and the other physical properties of the atom, but they have certainly not been very successful. It was soon found that circular orbits could not be made to cover all the known facts, and Bohr utilized the theory of elliptic orbits developed by **Arnold Sommerfeld**, Professor of Physics at Munich. Elaborate systems of ellipses appeared in the text-books, becoming more and more complex with each attempt to

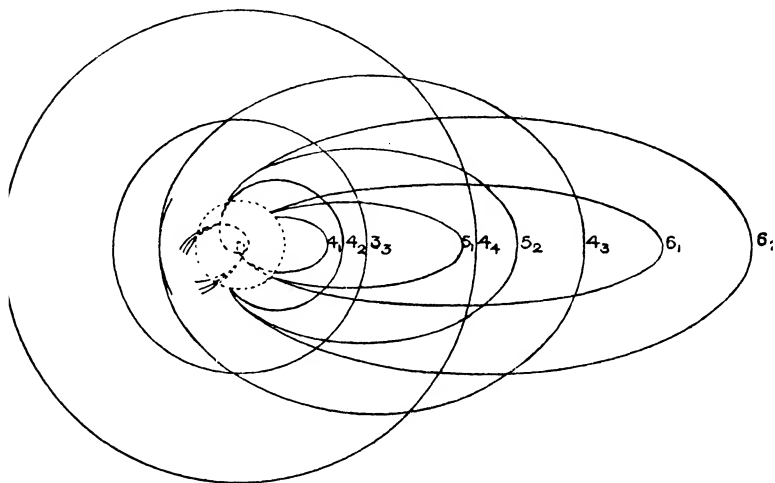

Fig. 107

include additional facts, always worked out, be it said, with mathematical support (see fig. 107). Did new variables appear? Very well, let the ellipses be interwoven. Still more variables? Then tilt the ellipses into different planes. Even still more? Then let the perihelion of the ellipse advance, like the perihelion of the planet Mercury (see fig. 108).

How, for instance, may we arrange, say, five electrons in elliptic orbits and preserve the Coulomb character of the field of force? Distribute them among five ellipses symmetrically inclined to one another at angles of $360^\circ/5$. The ellipses are traversed by five electrons in such a way that they all pass through the corresponding apheia and perihelia at the same

moment, respectively. Straight lines joining the electrons will form a regular pentagon which alternately contracts and expands. Clearly, in this pulsating polygon, the repulsions

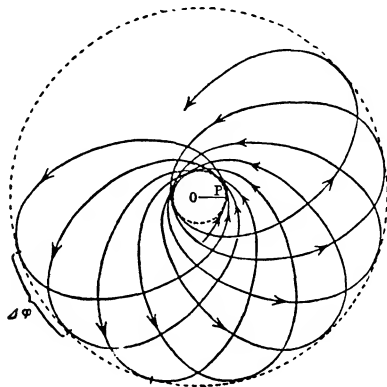

Fig. 108

exerted on one electron by all the remaining electrons must by symmetry give a resultant which passes through the nucleus (fig. 109).

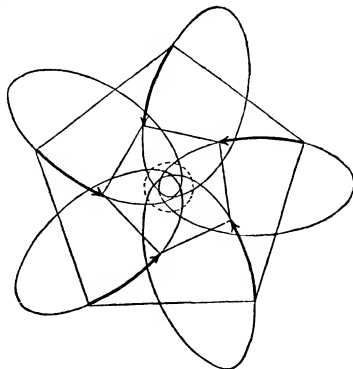
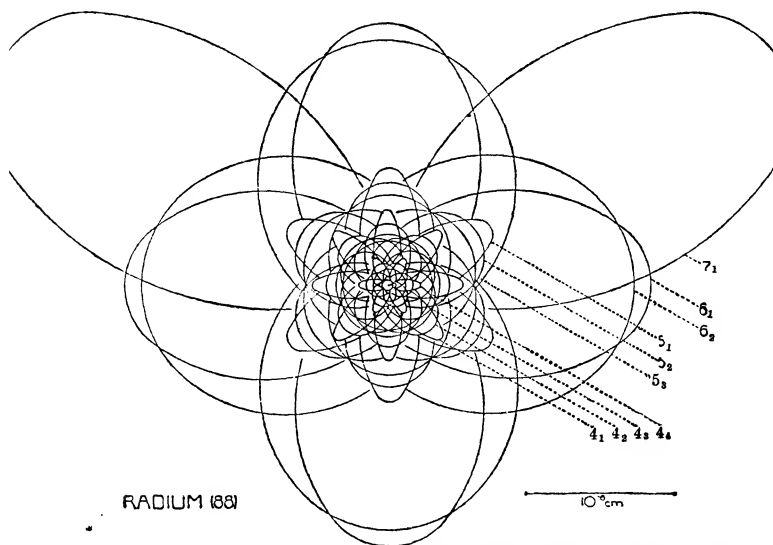

Fig. 109

How neat! How ingenious! But how unconvincing!

Fig. 110 was prepared by **Kramers** in accordance with Bohr's views, showing the supposed structure of the Radium

atom. It shows the older view of electronic distribution, now generally discredited. Again, how neat! how ingenious! *Was that ingenuity worth while!* It probably was. As more and more facts are accumulated, an hypothesis has to be modified again and again. But the successive modifications may cause the hypothesis to break down altogether, and then it has to give way to an hypothesis of a fundamentally different character.



[By courtesy of Messrs. Glyndendalk, Copenhagen.

Fig. 110.—Diagram of the Radium Atom

The Lewis-Langmuir Static Atom. Although the dynamic model of the atom gives an admirable account of spectroscopic observations, it does not give a satisfactory account of chemical properties. As for a molecule, even the simplest, that of hydrogen, we cannot conceive a satisfactory model of it based on the dynamic atom. It seems impossible to represent satisfactorily a model of a molecule in terms of moving electrons. In short, all acceptable considerations of chemical combinations have been based mainly on atomic

models in which the electrons are relatively *at rest*. The demands of structural chemistry indicate that the molecule, "whatever its internal squirm", has a definite structure with a shape and architecture of its own. We can hardly therefore escape the conclusion that the external electrons in the atom are *stationary*, and not revolving in orbits. This view is the general view of the chemists, and it has been developed by Professor G. N. Lewis and Professor Irving Langmuir, two of the most distinguished chemists of America, who, however, do not yet seem to have made any successful attempt to explain how the stability of the atom is maintained.

In this model, not only are the electrons stationary, but definite positions are assigned them. The planning is based on the succession of "periods" in the Periodic Law, viz.,

$$2, 8, 8, 18, 18, 32$$

which (apparently by mere chance) may be expressed

$$2(1^2, 2^2, 2^2, 3^2, 3^2, 4^2).$$

A "Period" signifies a sequence of elements ending in an inert gas, as shown in the first six sections of the Table (see fig. 100). Thus there are six completed Periods ending, respectively, in Helium, Neon, Argon, Krypton, Xenon, and Radon (the 7th Period is incomplete, and need not be considered here). In these Periods the Atomic numbers increase one by one from the beginning of the first Period onwards. These atomic numbers represent the total number of electrons external to the nucleus in the respective atoms, just as they represented the total number of planetary electrons in the dynamic model of the atoms. But in the static model, it is assumed that the electrons are symmetrically arranged as if they formed a succession of spherical shells, the radii of the spheres being in arithmetical progression. The number of electrons necessary to complete the innermost shell is 2; the next 8; and the others 8, 18, 18, and 32, respectively. When each shell is complete, it is representative of one of the inert and chemically inactive gases, and the addition of another



From "The Philosophical Magazine". By permission

Mass Spectra

electron then means the starting of another shell. Thus any given element may be thought of as containing the same arrangement of electrons as its predecessor in the Periodic table, with the addition of one more electron. Further, every element, beyond the first Period, unless it be an inert gas, will contain (1) one or more completed shells of electrons, and (2) an incompleting shell which is always external to the shells completed.

Hydrogen has, of course, but one electron, and in some ways ranks as an outside element. Helium has two external electrons, and these are assumed to be arranged symmetrically

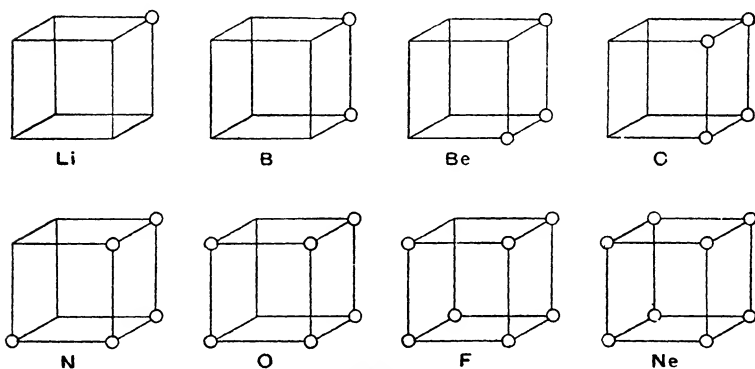

Fig. 111

at each end of a diameter of the one spherical shell belonging to that element. This inner shell of two electrons is present in every other element (save hydrogen), and determines an axis which may be called the polar axis. In neon, the 8 additional electrons which complete the second shell are arranged at the corners of a cube inscribed in the sphere, symmetrically arranged about the polar axis. Fig. 111 represents the electronic architecture of the second shell of electrons, as one element after another is built up, beginning with Lithium and ending with Neon. The first element beyond Neon is Sodium which begins the third shell with another electron. Thus each new shell grows, by the addition

of one electron at a time, from the beginning of a new Period to the end when the shell is completed. The Argon Period is represented by a second cube of 8 electrons; the 18 Krypton Period is represented by 2 new electrons on the polar axis and 16 others symmetrically arranged on the surface of the new spherical shell. And so on.

One great advantage of the static model hypothesis is that it affords a satisfactory explanation of chemical affinity. The very stable inert gases seem to act as points of reference to the elements on either side of them, and although the deductions drawn from the electronic arrangements in the longer Periods involve difficulty and a good deal of doubt, those drawn from the second and third Periods, in which the 8 electrons of each shell are arranged at the corners of cubes, do seem to throw a good deal of light on the nature of chemical affinity. Consider, for instance, the next-door neighbours of neon (atomic number 10). The electro-negative character of fluorine (atomic number, 9) is due to the tendency of the neutral atom of 9 electrons to capture an additional electron, and so to become a negative fluorine ion with 10 electrons similar to the neutral neon atom. On the other hand, the electro-positive character of sodium (atomic number, 11) is due to the tendency of the neutral atom of 11 electrons to lose one electron and so to become a positive sodium ion with 10 electrons, again similar to the neutral neon atom. The ready combination of sodium and fluorine is thus readily explained: it is simply the transference of an electron from the sodium atom to the fluorine atom. So it is with neon's two next-but-one neighbours, oxygen and magnesium, though in this case two electrons are transferred. It is as if two elements equidistant from an inert and chemically inactive element looked upon this inactive element as something to be imitated, especially as regards arrangement of electrons and chemical inactivity. Observe, analogously, how two fluorine atoms may unite to form a fluorine molecule (fig. 112). The tendency of the atoms to form octets of electrons is satisfied by a *sharing* of the 14 electrons on the two shells, to

form 2 cubes, 2 electrons being common to each cube. The figure shows the atom before and after combining. (The inner two-electron shells are, of course, ignored.)

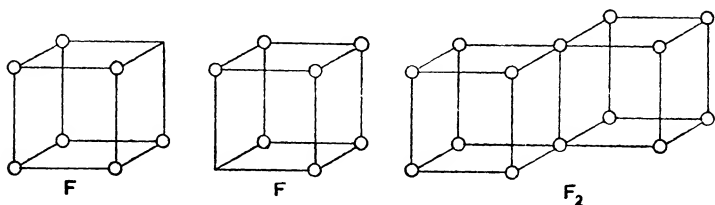

Fig. 112

Fig. 113, happily suggestive, is due to Professor Soddy. It diagrammatically represents the reaction of sodium and fluorine and the formation of sodium fluoride.

The whole theory of the static atom has been ingeniously worked out by Langmuir, C. R. Bury, and others, though with many differences of detail. All sorts of anomalies arise, especially in connexion with the longer Periods. In fact the theory as at present developed does not, by a very long way, cover all the known experimental facts.

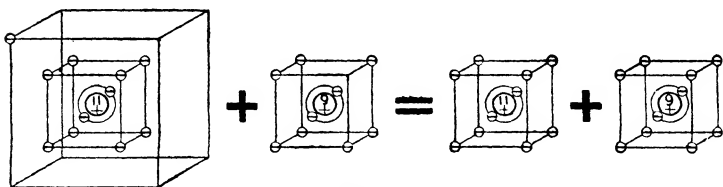

Fig. 113

The *dynamic* model of the atom, with its electronic orbits, explains the spectral lines almost perfectly, but it does not explain the chemical properties of the atom.

The *static* model of the atom, with its shells of stationary electrons, explains a few of the chemical properties of the atom in a way that seems almost convincing, but it does not give any real clue to the origin of spectral lines.

There seem to be no signs of developing the one hypothesis to the entire exclusion of the other, and there seem to be still fewer signs of merging them.

The reader must not for a moment think that either the dynamic or the static atom is truly representative of reality. The models merely serve the purpose of correlating known phenomena, and to that extent they are appropriately conceived mechanisms.

Pressed home really hard, some of the underlying assumptions become utterly unacceptable. In the dynamic model, for instance, we are told that an electron revolving in its orbit at a frequency of *billions* of times a second, may take a sudden jump into another orbit, land safely there, and revolve in this new orbit at an even greater speed. It is not everybody who is gifted with the power of visualizing an electron, travelling with an utterly unimaginable speed, suddenly turning inwards (or it may be outwards, if it is not changing its orbit of its own free-will), giving a mighty leap and landing exactly in a chosen spot, and then revolving in its new orbit with perfect regularity and with a greater speed than before. Does the electron pull up before making its leap? If not, that atomic gymnasium must be a truly wonderful place. Imagine Neptune reviving an old friendship by suddenly jumping into Jupiter's orbit, and landing without under- or over-shooting the mark, exactly at a spot where Jupiter is passing. Would Neptune pause in his own orbit and make his jump in a normal to the orbit? or would he, instead of pausing, make a sort of running tangential leap? And would he gauge this leap by guesswork, or would he, for safety's sake, first subject the proposed leap to mathematical analysis?

As for the static model, I remember a particularly effective lesson on the subject given to an intelligent sixth form by a science master. The boys had been well grounded in elementary chemistry, theoretical and practical. The master represented the atomic nucleus by a small orange, through which he thrust a knitting needle to represent the polar axis. Then around the orange he moulded, one after the other, a series of

shells of clay, sticking into each shell, in symmetrical positions, small wooden spheres to represent the electrons. Whilst the building up was proceeding, the following conversation took place between one of the boys and the master. (I give it as well as I remember it.)

Boy. "Is it really true, Sir, that when you put a ball into the clay it turns carbon, a black solid, into nitrogen, the sluggish constituent of the atmosphere; that when you put another ball in, that ball turns the nitrogen into oxygen, the active constituent of the atmosphere; that when you put in still another ball, it turns the oxygen into fluorine, a deadly poisonous gas; and this gas, by another ball, into neon, an absolutely lazy gas with no chemical properties whatever; and this lazy gas, by yet another ball, into sodium, a shining metal? Do the mere additions of the balls bring about these wonderful chemical changes, one after another?"

Master. "Not the wooden balls in the clay, of course. They merely represent the electrons, and the added electrons bring about all the changes you mention."

Boy. "Then if you put one more electron into an atom of oxygen, you make fluorine; and if you put two more electrons into an atom of fluorine, you make sodium."

Master. "Theoretically, yes."

Boy. "But *how* can an additional electron give rise to such different chemical properties?"

Master. "Well, it is just possible that each new electron disturbs the balance of the electric forces, and the properties are in this way changed."

Boy. "But, Sir, do you *really* believe all that?"

Master (sternly). "Sit down, you are now being rudely inquisitive."

"Out of the mouths of babes and sucklings. . . ."

Perhaps a score of the ablest physicists in the world have been devoting the last 20 years to the search for the secrets of the atom. Their experimental ingenuity has been remarkable; their striking theories command our admiration. But

the atom is still unknown; its secrets are still locked away.

To the physicist the atom is a "hive of activity", to the chemist, it is a "haven of rest". Will these two views ever be reconciled, or will they both be swept away?

4. The Modern Molecule

The term *molecule* is given to the smallest particles that still retain the specific properties of a given element or compound. The molecule of a compound usually contains several atoms, sometimes a large number, even hundreds; the molecule of an element usually contains two atoms, though a few contain only one and then the molecule and atom are identical.

Molecules, though so minute as to be utterly beyond the reach of the best microscope, can now be counted. Indeed they could be indirectly counted some thirty years ago when **Jean Perrin** interpreted the so-called "Brownian movement", a phenomenon which had been observed by **Robert Brown** (1773-1858), a Scottish botanist of world-wide reputation. If a turbid fluid containing particles sufficiently small (gamboge answers well) be examined under a high-power microscope, it is difficult to believe that the particles are not alive. The movement is virtually an ocular demonstration of the real *perpetual motion* of the molecules of matter, for it is they which keep the suspended particles in the turbid liquid in a state of perpetual motion. Modern thermodynamics does not deny the possibility of perpetual motion; indeed the universe itself is an excellent example of it; so is any jar of gas. But it does deny the possibility of a perpetual motion *machine*, i.e. a machine for converting the chaotic agitation of molecules, which constitutes heat energy of uniform temperature, into useful work.

When the attractive forces between the molecules are overcome by the effects of movement, the molecules have an independent individual existence and form a *gas*; when

the attractive forces just preponderate over the effects of movement, the molecules cling together and form a *liquid*, but the connexions between the molecules are loose enough to allow the molecules readily to change their positions and their partners; when the attractive forces have quite the upper hand, the molecules seem to be firmly bonded or locked together, and we get a *solid*. When the attractive forces are very strong, as in the case of the diamond or the metal platinum, the molecules are locked so closely together that they will not release their hold until raised to temperatures of several thousand degrees centigrade. On the other hand, molecules of such a substance as butter only just remain solid at ordinary temperatures. And as for gases, for instance carbon dioxide, and still more, oxygen or hydrogen, the difficulty is to get the forces of attraction to become effective, and solidification can be brought about only by *reducing* the temperature and reducing it greatly.

But we are here mainly concerned with the internal architecture of the molecule itself. The molecule is the completed building; the constituent atoms are the bricks. How is the building erected?

In what follows it should be borne in mind that the *valency* of an element indicates the number of other atoms with which one of its atoms can directly combine; or, better, the valency of an element is the number of equivalent weights contained in its atomic weight. The correct notion of valency is likely, however, to be a little difficult to grasp by those without at least a little laboratory experience.

We usually write H_2 to represent the molecule of hydrogen, and to signify that the molecule consists of 2 atoms; and we write $CaCO_3$ to represent the molecule of chalk, and to signify that the molecule consists of 1 atom of calcium, 1 atom of carbon, and 3 atoms of oxygen. But these formulæ give no sort of indication of the way in which the atoms are arranged to make up the molecule.

Chemists long ago learnt that when, by some sort of chemical action, a molecule is broken up, it does not at all

follow that the whole of its atoms are separated into single individuals; the separation is often a separation into smaller groups. This sort of separation has suggested formulæ of a new kind, viz., graphic formulæ pictorially representative of *structure*. Some of these graphic formulæ are representative of merely intelligent guess-work, but most of them are based on experimental evidence. We can, for instance, often drive out from a molecule an atom or a sub-group of atoms, and replace it by another atom or by another sub-group of atoms. It is true that much of the evidence concerning the structure of molecules is only inferential, but some of it is experimental and direct.

Archibald Scott Couper introduced "bonds" (lines or dashes) to indicate how the atoms in a molecule are probably linked together. The bonds correspond to *valencies*; they tell us, for instance, the number of uni-valent atoms with which any given atom may be associated at one time. Thus we may write hydrogen, oxygen, nitrogen, and carbon:

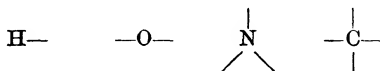

The graphic formulæ of the molecule of water, hydrochloric acid, ammonia, and marsh gas (H_2O , HCl , NH_3 , and CH_4), respectively, may be written:

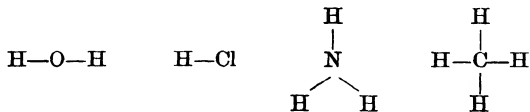

Oxides containing bi-valent oxygen, for instance, magnesium oxide, carbon dioxide, sulphur trioxide, and nitrogen pentoxide (MgO , CO_2 , SO_3 , N_2O_5) respectively may be written:

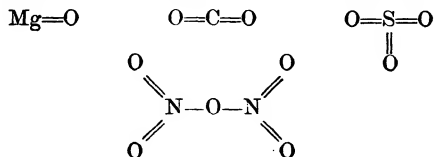



PROF. WERNER HEISENBERG
Keystone View Co.



L. DE BROGLIE
Wide World Photo.



PROF. E. SCHRÖDINGER
Gillman & Co.



PROF. P. A. M. DIRAC
Topical Press Agency

SOME SPECIALISTS IN QUANTUM MECHANICS

But some of these bondings may be artificial, and not truly representative of the facts. It does not at all follow that because valencies appear to be satisfied we have hit upon the structure of the molecule. For instance the above structural formula for magnesium oxide is almost certainly wrong. The formula for boric oxide (B_2O_3) we may write

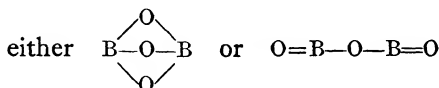

Each satisfies the requirements that oxygen is bi-valent and boron tri-valent, but one of the two is bound to be wrong. All such formulæ are valid only in so far as they represent the ascertained constitution of compounds. Sometimes two different substances, when analyzed, will reveal exactly the same percentage composition of constituents, so that we may write them both, say, X_3Y_2Z . Obviously the atoms within the molecules must be arranged differently in the two cases. A structural formula is best looked upon as an indication of chemical behaviour, though it *may* also indicate how the atoms in the molecule are actually connected.

In the structure of molecules, carbon is by far the most interesting element. The explanation of the *linking of carbon atoms* in the molecule is due to the German chemist **Friedrich August Kekulé**, who put forward the hypothesis (1) that carbon was not only always tetravalent and should therefore be shown graphically as having 4 bonds, but (2) that the atoms (α) may attach themselves to other elements by their bonds, and (β) *may* be linked with one another. By means of this hypothesis, we can explain the structure of a vast number of organic compounds. Consider two carbon atoms linked together; one bond of each is thereby utilized, leaving 6 bonds free for union with other atoms. Three bonds so linked leave 8 free; and so generally, thus:

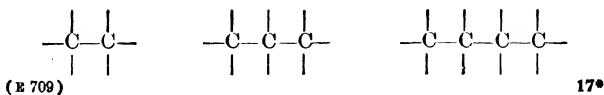

In this way we can build up *chains* of carbon atoms. If we supply the free ends of the links with hydrogen atoms, we have well-known compounds. For instance, Pentane, (C_5H_{12}), one of the Paraffins, is written thus:

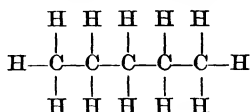

One of the "chains" of carbon atoms with hydrogen attachments is Hexane (C_6H_{14}).—In 1825 Faraday isolated a substance which we now call Benzene (C_6H_6). The molecule of this substance contains 6 carbon atoms like Hexane, and 6 hydrogen atoms. It can be made to take on 6 more hydrogen atoms, 12 in all, but no more, and the new molecule (Hexa-hydro-benzene) then behaves chemically very much like Hexane. But, having 2 hydrogen atoms less, it cannot have the same structure; it cannot be a **chain**. The riddle was solved in 1867 by Kekulé, who suggested that the framework of benzene is a **ring**, derived from the Hexane chain by the removal of the two hydrogen atoms at the ends and a bending of the chain round until the two ends meet and are joined up.

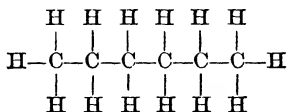
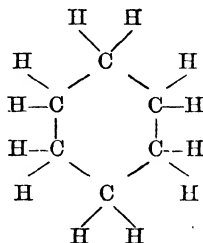
Hexane (C_6H_{14})Hexa-hydro-benzene
(C_6H_{12})

The carbon chain and the carbon ring are the foundations of the two great divisions of organic chemistry. Chain molecules are found in paraffin, fats, oils, &c., ring molecules in explosives, dyes, drugs, &c.

Sir Humphry Davy's isolation of sodium and potassium by the electrolysis of fused caustic soda and caustic potash led to the Swedish chemist Berzelius (1779-1848) putting forward the view that the forces of chemical affinity and electricity were one and the same. It was assumed that every atom in a compound possessed both positive and negative electricity, the positive or negative prevailing according as the atom was metallic or non-metallic. It thus followed that every molecule would have a positive and a negative part, and these parts in turn might consist each of positive and negative parts, and so on down to the individual atoms. This was the *dualistic* system which successfully explained the structure of electrolytes which are polar compounds; it failed, however, to apply to organic compounds, which are non-electrolytes and non-polar, or even to the common gases, H_2 , O_2 , N_2 , and the like. As the dualistic system would not apply to organic compounds, the French chemist Dumas (1800-84) propounded a *unitary* system of molecules; according to which every molecule formed a complete whole and did not therefore consist of two opposite and balanced parts. He thus referred the properties of a molecule, and therefore of the compound, to its *type*, rather than to the properties of the constituent atoms. For a time the unitary hypothesis prevailed and the dualistic hypothesis was discredited. When the doctrine of valency was developed, graphic formulæ with bonds were employed to represent both electrolytes and non-electrolytes alike.

But there was a return in part to dualism when the Swedish chemist Svante Arrhenius (1859-1927) put forward his hypothesis of electrolytic dissociation. This gave rise to the "ionic" school of physical chemists who regarded the electrolytes as existing in solution largely dissociated into oppositely charged ions.

There was much opposition to the view. It seemed incredible that + and - ions should remain permanently in the closest proximity without recombining. This difficulty has not been entirely overcome, but it must be remembered

that almost all the chemical tests by which the common elements are identified in the reactions of "wet" analysis are not tests for the elements but for their ions. We now regard chemical affinity as the self-contained affinity of each element for electrons in other elements.

Difficulties of various kinds, arising in part from the clashing of the dualistic and unitary hypotheses, had caused doubts to arise about the legitimacy of structural formulæ, though such formulæ seemed to show fairly satisfactorily the general structure of the molecule. In particular they seemed to explain **isomerism**, that is to say, the existence of such entirely different compounds as, e.g. ethyl alcohol and methyl ether, which have the same total number of atoms, and the same number of each kind of atom, in the molecule, C_2H_6O . The structural formulæ are, respectively,

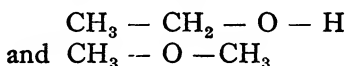

So accurately were many structural formulæ worked out that many natural carbon compounds were artificially synthesized.

And yet it was clear that structural formulæ set out in the form of *flat pictures* could not correctly represent the molecules, for molecules were undoubtedly three-dimensional and ought therefore to be visualized as "solids". It was this that led to **stereo-isomerism**, a subject which had its origin in the "asymmetric carbon atom" of the Dutch chemist, **Jacob Henry Van't Hoff** (1852-1911), and of a French chemist, **Joseph Achille Le Bel** (1847-1930).

A regular tetrahedron is a solid with 4 equilateral triangular faces. Whichever face is made its base, the solid has the same appearance—a regular pyramid with 3 triangular faces meeting in an apex centrally over the base. We may arrange the three letters around the base in two different ways, clockwise and anti-clockwise, ABC and ACB (fig. 114). If now we join the apex D to each corner of the base, we have two pyramids which are respectively right-handed and left-handed. No

matter how the pyramids are turned about, they cannot be made to look alike. *They are asymmetrical with respect to each other.** They are right-handed and left-handed, like a pair of gloves, just as certain crystals have long been known to be.

Now certain pairs of isomeric bodies crystallize in forms which are identical in all their individual parts such as angles and faces, but they are right-handed and left-handed and are therefore not superposable. This peculiar behaviour is associated with the property that the bodies are optically active. One turns the plane of polarized light to the right and the other to the left. It is known that this effect is not

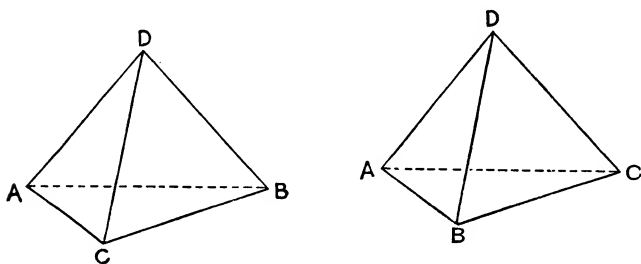

Fig. 114

due to the nature of the molecules but to their architectural make-up. Van't Hoff and Le Bel discovered the connexion between the rotation of light and atomic linking.

Fig. 115 shows a carbon atom at the centre of a tetrahedron with its four bonds projecting to the four corners M, N, P, and Q. To these four corners we may attach four groups of valency-satisfying atoms, *in two different ways*, right-handed and left-handed. Thus although we may have in the molecule precisely the same number of atoms of the same element, the *arrangements* of the atoms will be different in the two cases, and the compounds will therefore be different. Tetrahedral grouping seems to be the basis of

* The term "asymmetrical" must not be confused with the term "symmetrical" as used in plane geometry. "Asymmetrical" is a term derived from the triclinic system in crystallography, a system in which all three axes of the crystal are oblique to each other; and from this obliquity it follows that there can be neither planes nor axes of symmetry.

a great deal of the architecture of molecules. Certainly we must always think in terms of three-dimensional grouping of some sort.

Is there any experimental justification of these hypothetical chains and rings, and tetrahedral groupings? Modern research answers the question:

Molecular formulæ have long been used to express the reactions of *solids*, but this is less easy to justify than their

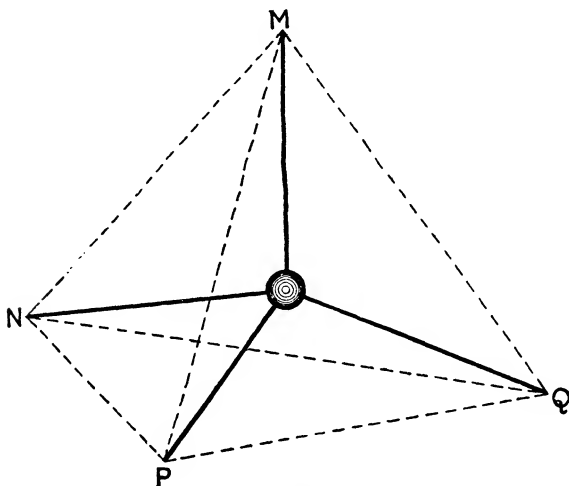

Fig. 115

use for expressing the reactions of gases. And yet it is the structure of solids upon which research is now throwing so much light. The leaders in this line of research have been Sir **William Henry Bragg** (*b.* 1862), a man who has held many important posts and is now Fullerian Professor of Chemistry at the Royal Institution, and his son **William Lawrence Bragg** (*b.* 1890). Father and son have worked together in investigating the structure of crystals, and their remarkable success has been due in large measure to their development of the X-ray spectrometer.

The beauty of crystals is well exemplified in small snow-flakes, especially under a low-power magnifying-glass. Fig. 116 shows a few of the many varieties of hexagonal forms.

When things are so minute that they are about the same size as the wave-lengths of light, the microscope fails us. But X-rays are some 10,000 times as short as those of ordinary light, and thus they enable us to go 10,000 times as deep into minuteness of structure; we can therefore get into the

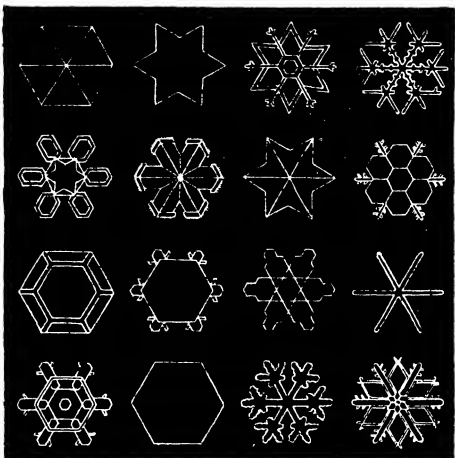

Fig. 116.—Snow-crystals

region of molecules and atoms. These have dimensions of the order of a hundred-millionth of an inch, and this is also the order of the wave-length of X-rays. It is true that the effect of X-rays on a single molecule is too minute to enable us to "see" the molecule, but in a crystal enormous numbers of molecules are set out in orderly array and make a perfectly regular pattern, and the effects of X-rays on their serried ranks are so combined as to make the molecules "sensible". We could not see the sun-flash from a bayonet carried by a single soldier five miles away, but the 30,000 flashes from the bayonets carried by a whole army, would be readily visible. The X-ray spectrometer is a sort of optical multiplier,

10,000 times as strong as the most powerful microscope.

If X-rays be passed through a crystal and then on to a photographic plate, spots are produced symmetrically. These spots are caused by the scattering of the X-rays by the atoms in the crystal. Space models may thus be photographed, and the spatial arrangement of the atoms in that way determined. Such analysis was successfully worked out by **Max von Laue** (*b.* 1879), a German physicist of high standing.

An ordinary piece of trellis-work can be opened out to make a number of perfect squares, or it can be partially

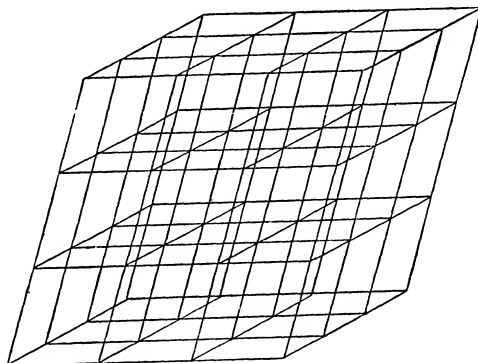

[From *Concerning the Nature of Things*, by courtesy of Sir Wm. Bragg

Fig. 117.—Space lattice

closed down, when the squares become rhombuses. The whole arrangement may be called a *lattice*, in which each rhombus or square represents one unit of pattern.

If a number of pieces of trellis work be placed in equidistant parallel positions it may be regarded as a three-dimensional "space" lattice, as represented in fig. 117. Each "cell" of this space lattice is bounded by 6 faces which are parallel in pairs. This is truly representative of a crystal, though the cell can have any length of side and any angle. The simplest and most regular form is the cube. Each such cell of a crystal contains a single complete pattern with all its details, and no more; it is the crystal *unit*. X-ray methods

enable us readily to determine the shape, size, and dimensions of the cell. The *number* of molecules (always very small) in each cell, the arrangement of these molecules, and the arrangement of the atoms in each of the molecules, are much more difficult to determine, though in the case of a few crystals these things have already been done. In such successful cases, many known facts of chemistry and physics have been called in to help the X-ray analysis.

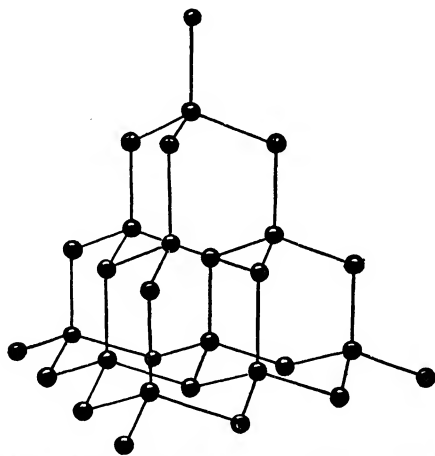

[From *Concerning the Nature of Things*, by courtesy of Sir Wm. Bragg

Fig. 118.—Diamond model

Fig. 118 shows the Bragg model of the structure of the diamond, which is, of course, really a piece of carbon. The black balls represent the carbon atoms, but only in respect of *position*. We know very little of their size and form. Every carbon atom is at the centre of gravity of 4 others; there is an endless repetition of perfect *tetrahedra*. The distance between the centres of any two neighbouring carbon atoms is 1.54 Ångström units (it will be remembered that this unit is the ten-millionth of a millimetre). Observe the hexagonal **rings** throughout the figure, and how very closely these rings are geometrically associated with the tetrahedral grouping.

Fig. 119 shows Bragg models of ice crystals. They are made up of white and black balls, the white representing oxygen and the black hydrogen. The second figure shows more

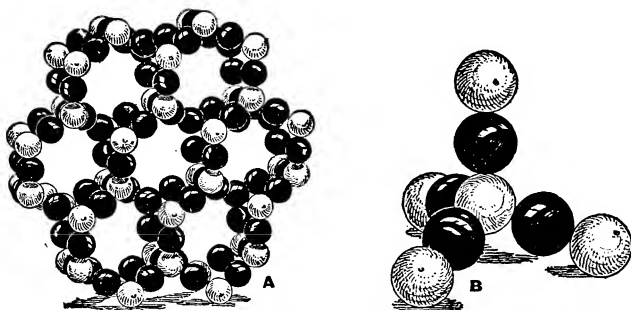

[From *Concerning the Nature of Things*, by courtesy of Sir Wm. Bragg

Fig. 119

A, Model is made of balls of two colours, the white representing the oxygens and the black the hydrogens. B, Section of the model showing the grouping of the oxygens and hydrogens.

clearly the grouping of the two kinds of atoms. The structure is something like that of the diamond. An oxygen atom stands at the centre of the tetrahedron, four others standing at the four corners. A hydrogen atom stands between each pair of oxygen atoms. Every oxygen has four hydrogen neighbours, and every hydrogen has two oxygen neighbours; hence there are twice as many hydrogens as oxygens.

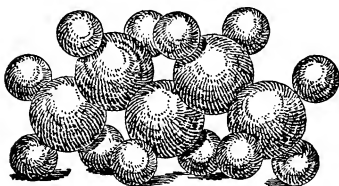

[From *Concerning the Nature of Things*, by courtesy of Sir Wm. Bragg

Fig. 120.—Model of a hydrogen chain, pentane containing five carbon atoms: large balls, carbon atoms; smaller, hydrogens.

Fig. 120 is a Bragg model of pentane (C_5H_{12}) showing a chain of carbon atoms. The larger balls represent carbon

atoms, and the smaller hydrogen atoms. But the figure is put forward tentatively. The X-ray evidence of chains is incomplete, though it leaves no doubt of the reality of chain grouping in a large number of organic molecules.

Crystals of common salt are of an entirely different type.

If we assume the truth of the static model of the atom, it will be seen from the Periodic Table that the chlorine atom requires one more electron to complete its outer shell (which has only seven electrons instead of the full complement of eight), and that the sodium atom has but a single electron in its outer shell (one instead of the full complement of eight). The unsatisfied chlorine atom seizes this solitary electron from the sodium, so that the chlorine atom has now the external appearance of the inert argon atom, and the

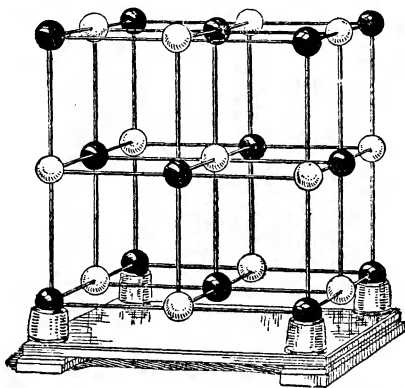

[From *Concerning the Nature of Things*, by courtesy of Sir William Bragg

Fig. 121.—Model showing the arrangement of the sodium and chlorine atoms in rock salt. The dark represent sodium, the white chlorine

sodium atom that of the inert neon atom. The two atoms are therefore now charged electrically; the chlorine is negative because it has one negative charge over and above its proper number; the sodium is positive because it has one too few. The salt crystal grows as the result of the oppositely charged atoms of chlorine and sodium successfully attempting to satisfy their mutual attractions, and the particular system of atom packing which Nature has adopted is that in which each chlorine atom is surrounded by six sodium atoms, and vice versa. Fig. 121 shows the Bragg model of sodium chloride; the white balls represent chlorine and the dark, sodium, or vice versa. The general arrangement is cubical, in which

each of the lines of atoms that are parallel to the edges consist of sodium and chlorine atoms alternately. It is because of this arrangement that salt crystallizes out from brine in cubic form. The lattice work may, of course, be extended indefinitely in all directions, the chlorine and sodium atoms always being given alternate positions.

The question may be asked, where is the *molecule* of sodium chloride? In the solid salt, no such molecule exists. It is *ions*, not neutral atoms, of sodium and chlorine, which are packed together in the solid salt; and when the salt disintegrates in water these ions wander about freely in the solvent, without forming sodium chloride molecules.

Many crystals are built on this principle, especially salts of the metals.

The main point of interest is that X-ray examination of crystals has already gone a good way to confirm many of the hypotheses concerning molecular architecture. The *molecule* is, in fact, becoming really friendly, and we shall probably soon learn to know it intimately. But the *atom* is fickle; it plays fast and loose with us; it tells us now one story, now another.

In his presidential address to the Royal Society in November, 1933, Sir F. Gowland Hopkins referred to certain far-reaching developments in recent physical investigations of the molecule.—Covalence, as distinguished from electrovalence, is a term now used to denote that form of atomic linking which applies when electrons are shared by adjacent atoms; it is the special concern of organic chemistry. If at any locality in a molecule electrons are shared unequally by adjacent atoms, the molecule will be *polar*, the atom which has the larger share of the two binding electrons being the negative end of a *bipole*. As a result the molecule orientates itself in any electric field, and a measurable *moment* is involved.—This molecular dipole moment serves to illustrate the value of modern applications of physical methods in chemistry.

5. Modern Transmutation

The transmutation of one kind of matter into another was the alchemist's dream. The work that is now being done at Cambridge and elsewhere suggests that, in the not very far future, such transmutation may, at least on a very small scale, become possible after all.

We have already noted that radio-activity is a direct manifestation of atomic instability. Occasionally an atom of a radio-active element breaks up with explosive violence, hurling out at great speed massive α -particles or light β -particles (electrons). As a consequence of this explosion, the residual atom has entirely different physical and chemical properties from the parent atom. The successive transformations of the two elements uranium and thorium have given rise to 30 or more new products, of which radium is the best known. But the transformation of the radio-active atom is a *natural* process, spontaneous and absolutely uncontrollable. The great majority of the elements seem, however, to be permanently stable under all normal conditions on the surface of the earth.

Can transformation of any of the elements be produced artificially?

As far back as the late nineties, it was discovered that one or more of the light electrons could be struck out of certain atoms either by the action of swift particles, or by ultra-violet radiation, or by X-rays. The modified atom had a positive charge and had different properties from the neutral uncharged atom. But the change of properties was only momentary, for in a very short interval another electron fell into the atom and filled the vacant place, and the atom was restored to its original constitution. Evidence indicates that it is impossible to cause a permanent transmutation of an atom by removing or adding outside electrons.

But we have now learnt how to attack the massive *nucleus* of the atom, and in some cases to break it up permanently. In this way permanent transmutation has been brought about.

Until a year or two ago it was generally supposed that the nucleus of an atom was ultimately composed of two types of electrical units.

- (i) the negative *electrons* of very small mass, and
- (ii) the positively charged *protons* of mass 1.

But it had already become clear that a third unit of a secondary type played a prominent part, viz:

- (iii) the α -*particle*, i.e. the helium nucleus, of mass 4.

Recently we have had to extend our vision further, for undoubted evidence has been obtained of the existence of a new type of particle,

- (iv) the *neutron*, with a mass of about 1, but with no electric charge.

And in 1933 still another nuclear particle was discovered in certain atoms, viz:

- (v) the *positron*, the positive electron of very small mass, the counterpart of the negative electron.

It may be assumed, with some confidence, that the nucleus of most heavy atoms is composed of a large number of the more massive particles, viz. charged α -particles and protons, and uncharged neutrons. They are all held together by powerful forces in an extraordinarily minute volume, and form a very stable structure. But we do not yet really know much about the number, arrangements, and motions of these constituent particles. As for the two types of nuclear particles of very small mass, the electrons and the positrons, we know hardly anything at all.

In order to transmute one atom into another, it appears essential to alter the charge on the nucleus. But the nucleus is held together so strongly that in order to disrupt it, intense forces must be brought to bear upon it. One method of doing this is to bombard it with particles travelling at very great speed. One of the most energetic particles known to

science is the α -particle, which is spontaneously ejected from radium. In 1919 Rutherford made the first experiments. A preparation of radium served as a source of α -particles, and the scintillation method was used to detect the presence of particles of any new kind. When oxygen gas was thus bombarded, no new effect was observed. When nitrogen was substituted, scintillations were observed far beyond the distance of travel of the α -particles, and they were found to be produced by charged hydrogen atoms which we now call protons. These protons could only be explained by supposing that they originated in the transformation of some of the nitrogen nuclei as a result of the α -particle bombardment.— This was the first time that definite evidence was obtained that an atom could be transformed by artificial methods. In the light of later research by Professor P. M. S. Blackett, the general mechanism of the experiment has become clearer. The conclusion seems inevitable that the bombarding α -particle actually penetrates into the nitrogen nucleus and is captured by it. The immediate consequence of this profound disturbance is the ejection from the new nucleus of a proton at high speed. The arithmetic of these changes shows the final results clearly:

	Mass	Nuclear Charge
Nitrogen nucleus	14	7
Captured α -particles	4	2
Momentary new nucleus	18	9
Ejected Proton	1	1
Final new nucleus	17	8

Thus we have an atom of mass 17 and a charge of 8. But the atom the nucleus of which has a charge of 8 is *oxygen*, so that as a result of the interaction of an α -particle, the nitrogen nucleus is changed into a nucleus of oxygen. It will be noted that the mass of the oxygen nucleus formed in

this way is 17 and not 16 as ordinarily observed. The actual presence of an isotope of mass 17 in small quantity in ordinary oxygen was disclosed later by direct experiments of another kind.

By improved methods in subsequent investigations, **Rutherford** and **Chadwick** showed clearly that at least 12 of the lighter elements could be transformed by α -particle bombardment. In every case protons were ejected, the number and speed varying from element to element. It is reasonably certain that the process of transformation is similar in all cases to that found for nitrogen. The α -particle (mass 4) is captured, a proton (mass 1) is ejected, and the new atom that is formed has a mass 3 units greater, and a charge 1 unit higher, than the original atom. In every case an atom of the element which has been bombarded has been turned into the atom of the element next higher in the normal order of the elements.

Success in the disruption of atomic nuclei is rapidly being increased by improved methods of bombardment, especially in regard to the particular projectiles chosen.

Although some of the lighter elements could be transformed by α -particle bombardment, such bombardment had no effect on lithium, carbon and oxygen. The effect on the light element beryllium (mass = 9) was strange: no ejected protons could be detected, but **Bothe** noticed the emission of a penetrating radiation which **M. and Mme Curie-Joliot** found had unusual properties. It was **Dr. Chadwick** of Cambridge who showed that this radiation consisted of a stream of fast particles of a new type, which he named "neutrons". This new particle has about the same mass, 1, as the proton, but has no electrical charge. The transformation of beryllium is thus of a different kind from that of most of the other light elements. As before, the α -particle is captured, but a high-speed neutron, not a proton, is ejected. By this process the nucleus of beryllium of mass 9 is changed into an atom of carbon (mass 12), accompanied by the ejection of a neutron (mass 1).

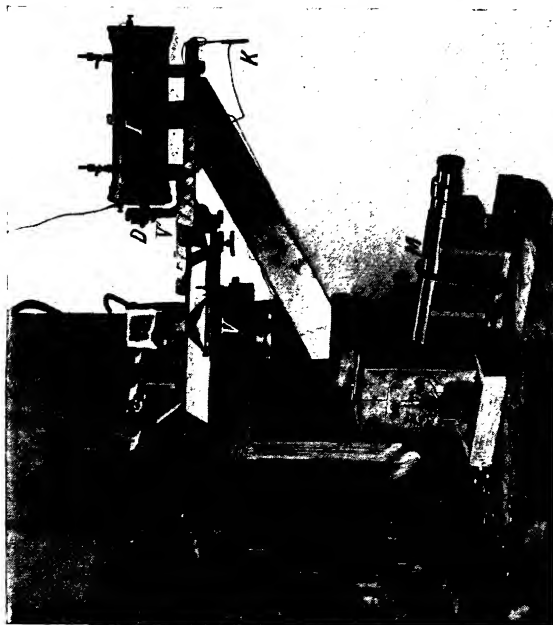

X-Ray Spectrometer

- LLL*, Lead box.
- A, B, D*, Slits.
- C*, Crystal.
- I*, Ionization chamber
- V*, Vernier of crystal table.
- V'*, Vernier of ionization chamber.
- K*, Earthing key.
- E*, Electroscope. *M*, Microscope.

The X-ray bulb is enclosed in the box *LLL*, from which the rays pass and fall on the face of the crystal *C*, and then pass into the ionization chamber *I*.



Diffraction of X-Rays by a Crystal of Beryl
 From "X-Rays and Crystal Structure", Sir W. H. and W. L. Bragg

These high-speed neutrons are, in their turn, now being used as projectiles. As they are uncharged they are able to pass freely through atoms of matter with little if any loss of energy. A neutron only makes its presence manifest when it collides with the nucleus of another atom. **Feather** has shown that fast neutrons will transform both oxygen and nitrogen, with the emission of fast α -particles, and recently **Harkins** has shown that they will transform carbon and neon.

Projectiles of heavy hydrogen (mass 2)—we shall refer to this newly-discovered isotope again presently—have also been found remarkably effective in causing disintegration in many elements. For instance, lithium (mass 7) was transformed into two α -particles each of speed greater than any α -particle observed from radio-active substances. Apparently an isotope of mass 6 was involved, for the capture of the heavy hydrogen particle of mass 2 led to the break up of the nucleus into two α -particles (each of mass 4) flying off in opposite directions. Other atoms have since been transformed by the same agency, with the emission of α -particles, and in some cases with very fast protons. The outlook for the disintegration of heavy atoms is promising. Professor **E. O. Lawrence** of the University of California has devised a very ingenious method, depending on multiple acceleration, of obtaining bombarding particles of tremendous energy; he has stepped up the voltage of heavy hydrogen particles to 3,000,000 volts.

Experiments of special interest have been carried out by Dr. **E. T. S. Walton** and Dr. **J. D. Cockcroft** of the Cavendish Laboratory, Cambridge. The apparatus they used produced protons having energies up to 700,000 volts, and with these protons they have disintegrated lithium, boron, and fluorine. Lithium split up into two α -particles, two types of transmutation occurring, in one of which an energy equivalent of 17,000,000 volts was liberated. Boron split into 3 α -particles, with a release of 9,000,000 volts. Dr. **M. L. Oliphant** has also met with great success in experiments of a kindred nature.

The energy changes involved in these transformations are

of great interest. A proton of energy corresponding to 30,000 volts can now be made to effect the transformation of lithium into two fast α -particles, which together have an energy equivalent of more than 16 million volts. The output of energy in the transmutation is therefore more than 500 times as great as the energy carried by the proton. There is thus a great gain of energy in a single transmutation, but we must not forget that, on an average, more than 1000 million protons of equal energy must be fired into the lithium before one happens to hit and enter the lithium nucleus. Hence it is clear that the energy derived from transmutation of the atom is small compared with the energy of the bombarding particles. Clearly there is no prospect of obtaining a new source of power by these processes. It has sometimes been suggested, from analogy with ordinary explosives, that the transmutation of one atom might cause the transmutation of a neighbouring nucleus, so that the explosion would spread throughout the whole of the material. But the explosion is confined to the individual nucleus and does not spread to neighbouring nuclei, which are relatively much too far removed from the source of the explosion to be affected. The assumption sometimes made that the world will one day be enriched—or it may be, annihilated!—by the release of stored atomic energy is, as Lord Rutherford aptly put it, all moonshine.

Ultimately, we ought to be able to transform the most massive of the elements, though even for this purpose we may not require the enormous voltages which some authorities have suggested. The extreme limit necessary is possibly about 5,000,000 volts, though with intensive streams of projectiles voltages of 60,000 or 70,000 ought normally to suffice.

But by no means all physicists are of this opinion, and plans are being matured in laboratories all over the world for obtaining much higher voltages and faster particles for a further intensive attack on the problem. Van de Graaff has devised a new type of electrostatic generator whereby he hopes soon to obtain a steady potential of 10 million volts

with which to drive at great speed atoms in a discharge tube. Lawrence, by his special method of multiple acceleration, hopes to obtain projectiles with energies greater still. Observations are also being made on the transformation effects of the extremely energetic particles present in the cosmic rays which pass through our atmosphere. Many of these have an energy of 100 million volts and some have probably more than 1000 million.

In the sun and in the other hot stars, transformation processes must have been going on for thousands of millions of years, and the existing relative amounts of the different types of the elements were probably therefore decided by those processes of building up and destruction of atoms, due to the emission of particles at enormous pressures and temperatures.

Concerning the "positron", a kind of positive electron, we have at present very little knowledge. Its discovery is associated with the names Anderson and Blackett. It was first detected by the "cloud method" study of cosmic rays. Its mass is comparable to that of a negative electron, and is therefore extremely small. Mass and charge do not seem to differ more than 50 per cent from those of the negative electron. Professor Blackett is of opinion that the positrons originate in some type of atomic or nuclear process brought about by the incident cosmic radiation. They have been found to be produced when the radiation from a beryllium target is bombarded by α -particles.

Concerning "heavy hydrogen" and "heavy water" we have already learnt a good deal. "Heavy hydrogen" or "isohydrogen" or "deuterium" (Gk. *δευτερος* = the second) is apparently a hydrogen isotope, D or H". Its discovery is quite recent. Just as Lord Rayleigh's attention to a very small difference in the density of (1) pure nitrogen and (2) residual nitrogen from air, led to the isolation of argon 40 years ago, so a small difference between (1) the chemical values for

the atomic weight of hydrogen and (2) Aston's mass-spectrograph determination (when, in the latter, allowance has been made for the existence of the oxygen isotopes), led **Birge** and **Menzel** to make the suggestion that ordinary hydrogen might contain a heavier isotope. The suggestion for the existence of heavy hydrogen arose in 1931, and it is scarcely more than a year since spectroscopic evidence provided by **Urey** and others made it certain. It has now been isolated, and the proportion to light hydrogen is only about 1 to 35,000. To have separated heavy hydrogen from light hydrogen in these circumstances points to great experimental resource and skill. The credit for having first done this must be given to three Americans, **Urey**, **Brickwedde**, and **Murphy**.

In heavy hydrogen the nucleus of the atom is about double the weight of that of ordinary hydrogen. It is this nucleus of heavy hydrogen which is called the *deuteron* or *deuton*. The most natural view of the deuteron is that it consists of two protons and an embedded electron, but the suggestion has also been made that it consists of two neutrons and a positron.

At the meeting of the Royal Society, 14th November, 1933, Lord **Rutherford** suggested that instead of "deuterium" the name *diplogen* should be given to heavy hydrogen; and instead of "deuton" the name *diplon* should be given to the nucleus.

At the same meeting Professor **Soddy** forcibly protested against the description of heavy hydrogen as an *isotope*. He expounded the view that the difference between the two hydrogens was analogous to the difference between oxygen and ozone.

"Heavy water" is the natural sequel to heavy hydrogen, and **Lewis** and **Macdonald** have already prepared and studied nearly pure D_2O , and many of its properties have been investigated by them and others. Its freezing-point is $+3.8^\circ C.$, and its boiling-point 101.42° . Its density is about 10 per cent higher than ordinary water. It will not support life: tobacco seeds refuse to sprout in it, and it causes the death of fish, tadpoles, and worms, though the animalcules

known as paramedia have held out for 24 hours. We do not yet know at what concentration it proves toxic.

It has been suggested that the discovery of heavy hydrogen must prove a nightmare to the organic chemist. Already the compounds of hydrogen with carbon and oxygen are bewildering in their number and complexity. Will the number have to be doubled?

The main lesson to be derived from the discovery is, for science, the old one. The more exact we make our measurements, the more likely are our existing theories to require amendment.

(For Portraits, see Plates 11 and 17.)

BOOKS FOR REFERENCE:

1. *The Structure of Matter*, J. A. Cranston.
2. *Concerning the Nature of Things*, Sir W. Bragg.
3. *The Interpretation of the Atom*, F. Soddy.
4. *The Structure of the Atom*, E. N. da C. Andrade.
5. *The Foundations of Chemical Theory*, R. M. Caven.
The above five volumes will together form a good detailed supplement to this chapter.
6. *Rays of Positive Electricity*, J. J. Thomson.
7. *Radio Active Substances and Their Relations*, E. Rutherford.
8. *The New Conception of Matter*, C. G. Darwin.
9. *X-rays and Crystal Structure*, W. H. and W. L. Bragg.
10. *The Electron Theory of Matter*, O. W. Richardson.
11. *The Chemistry of Radio-Elements*, F. Soddy.
12. *Isotopes*, F. W. Aston.
13. *Mass Spectra and Istopes*, F. W. Aston.
14. *Atomic Structure and Spectral Lines*, Arnold Sommerfeld.
15. *Modern Physics*, H. A. Wilson.
16. *Valence and the Structure of Atoms and Molecules*, G. N. Lewis.
17. *Analysis of X-ray Photographs* (Proc. R. S.), P. M. S. Blackett.
18. *The Theory of Spectra and Atomic Constitution*, N. Bohr.
19. *Heavy Hydrogen and Heavy Water*, Lecture by Professor H. C. Urey (*Nature*, 10th Feb., 1934).
20. *Artificial Production of New Kinds of Radio-Elements*, F. Joliot and Irene Curie (*Nature*, 10th Feb., 1934).

CHAPTER XXXVIII

Some Riddles of Modern Physics

Has Classical Mechanics broken down?

By the end of the 19th century, the superstructure of mechanics and physics, which had been placed on such firm foundations by Galileo and Newton, seemed almost complete. Faraday and Maxwell and their successors seemed to have built even better than they themselves had realized. The Laws of Motion, the Law of Gravitation, the great principles of the Conservation of Energy and of Momentum, the main Laws of Thermodynamics, the Undulatory theory of Young and Fresnel, the Electromagnetic theory of Clerk Maxwell, the values of the mass and the charge of electrons, all these things were regarded as constituting a classical position which would stand four-square against any conceivable attack from any possible quarter. At the beginning of the present century, however, doubts began to arise. Three subjects, which even now are something of the nature of unsolved mysteries, gradually became universal topics of discussion among men of science:

1. The Quantum Theory.
2. Wave Mechanics.
3. Relativity.

We will briefly touch upon them in turn.

1. The Quantum Theory

Consider an ordinary piece of metal, say iron. Its molecules are packed in orderly array, very close together, but

actually separate as individuals. Though in character apparently continuous, the solid structure is really *discontinuous*. So it is with water; the molecules move freely over one another, but they are really *discontinuous*, despite the apparent continuity of the liquid. So it is with air; push a piston into a gas-jar and we experience an opposing pressure; we feel that the increased pressure we exert is increased continuously, but we have good reason to believe that the molecules of air are bombarding the piston by separate blows and that the air is therefore *discontinuous*.

A common object on the pier at a seaside place is a penny-in-the-slot machine known as a "punch-ball"; a dial records in pounds and ounces the energy of the punch delivered by some enterprising youth. Now it is inconceivable that the dial will always register an *exact* number of pounds or of pounds and ounces. From the nature of things we are inclined to believe that our muscular effort is not to be measured by anything of the nature of a succession of steps, no matter how small these steps may be. Whatever we may say about the *discontinuity* of solids, liquids, and gases, we claim that an exerted force of any kind is necessarily *continuous*, one amount shading off imperceptibly into another, and not that one amount is separated from the next amount by a sort of empty interval.

This imperceptible shading off may perhaps be admitted in all kinds of human effort, but in physical science anything of the nature of "continuity of energy" the Quantum theory challenges.

In the last chapter we referred to the electronic orbits of the atom, and we may conveniently refer to them again here. The different orbits are characterized by different energies which are inversely as the radii. The radii of the orbits are represented by square numbers; the total energy corresponding to each orbit will therefore be represented by the reciprocals of the square numbers. Thus if the total energy associated with the K orbit is 1, that in the L orbit is $\frac{1}{4}$. Hence the step or difference in the energy from K to

L is $\frac{3}{4}$; from K to M it is $\frac{8}{9}$; from L to M, $\frac{5}{36}$; and so on. The energy in orbit N is $\frac{1}{16}$; hence to make an electron jump from K to N, $\frac{15}{16}$ of its energy must be supplied to it. And that is the amount of energy that will be *emitted* when the reverse step is taken.

If the orbits are represented by horizontal lines, the energy-differences between the levels are easily indicated (see

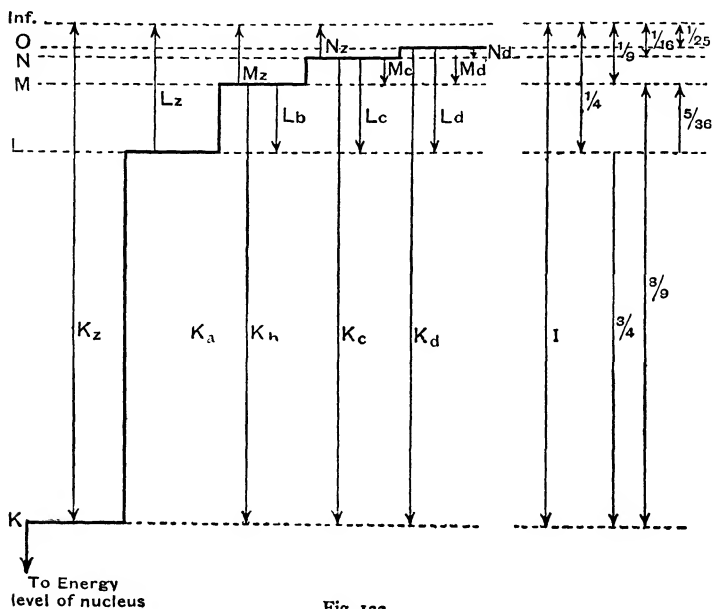

Fig. 122

fig. 122 and compare it with fig. 106). In the succession of energy steps, the difference in height between two steps shows the energy liberated when an electron jumps from a higher to a lower step. How is this curious connexion between the radiating atoms and the energy which they emit to be accounted for? Experiments show conclusively that the precise ratios above quoted do not admit of modification. A change, for instance, from $\frac{5}{36}$ to $\frac{5}{37}$ is simply impossible. *Why just these particular orbits, and no intermediate ones?*

In the solar system, the planetary orbits might be imagined to expand or contract to any extent, little or much, and the laws of classical dynamics would still apply. It was Niels Bohr who first saw a rational explanation of the restricted electronic orbits. It was quite obvious to him that no theory of *continuous* emission would apply. Either definite portions of energy are emitted, or none at all. Regularity and law remain, but everything takes place in *steps*, in *gushes*, though the steps are not necessarily equal. Planck's *quantum*, an accurately measurable constant, easily explained everything. Planck had created the Quantum some years before, for different purposes.

According to the classical laws of electrodynamics, the energy of an atom should continually decrease, owing to the atom scattering energy abroad in the form of radiation and therefore having less and less for itself. The same laws predicted that all energy set free in space would rapidly become transformed into radiation of almost infinitesimal wave-length. But just at the end of the last century experiments proved conclusively that these things simply did not happen. The most noteworthy failure of all was provided by "black-body" or "cavity" radiation.

A "black-body" is a theoretically perfect absorber. The black-body apparatus commonly used in experiments on heat consists of a small chamber, blackened inside, with an aperture. Any radiation entering through the aperture is scattered and absorbed by repeated reflection, so that only a minute fraction can possibly escape. The blackness thus secured is equally perfect for all wave-lengths, owing to the complete elimination of surface reflection at the aperture.

More generally, "cavity" radiation refers to the radiation from the interior walls of a hollow body which may be heated to incandescence and may be maintained at a constant temperature. The light imprisoned in the interior is let out through an aperture, and the character of its radiation is examined. By passing it through a spectrometer and measuring the energy in different parts of the spectrum, we can determine the *energy distribution* of the spectrum. This radiation is the

most complete we can obtain, for no colour is missing, and every colour is at full strength. Such a body is a "full radiator".

Now according to classical electro-dynamical laws, the whole of the radiation from such a cavity ought to be found at or beyond the extreme violet end of the spectrum, independently of the precise temperature to which the body had been heated. But experiment shows the radiation to be piled up at the opposite end. In no way could the laws derived from experiments be made to square with classical theory. It was Max Planck (*b.* 1858), Professor of Physics at Berlin, who stepped in and put forward an ingenious and far-reaching hypothesis. He assumed that all kinds of radiation are emitted by systems of *vibrators* which, on being excited, emit light. According to the classical theory each vibration should *gradually* come to rest and then stop until excited again, but Planck assumed, instead, that every vibrator always changed its energy by sudden *jerks*. This vibrator might have any integral number of units of energy but no fractions. Thus changes of energy are *never gradual* but are delivered in sudden gushes. In this way "gradualness was driven out of physics and discontinuity took its place".

A particular change of state in an atomic system can be brought about only by radiation of a certain definite colour and thus of a particular wave-length. An atom simply disregards any radiation that strikes it unless of the appropriate wave-length. This remarkable selective power of the atom has never been explained and it remains a complete mystery. The hypothesis nevertheless *works*, for it is in entire agreement with experimental facts. Each atom welcomes that radiation which is specifically of the correct wave-length for it, but absolutely refuses part or lot with radiation of any other kind.

Thus the Quantum theory arose as a means of escape from an *impasse* reached by classical physics in connexion with the laws of radiant heat. This was in 1900. Later on, the theory was called in to explain the Bohr orbits of the

atom, and it seemed to cover all the facts exactly. The separate spectrum lines were correlated with the gushes of radiation emitted by the electrons as they jumped from one orbit to another; intermediate orbits were excluded because they would require fractions of a quantum, and a quantum cannot be divided. The theory also helped to solve other problems in physics, problems which were causing unmistakable difficulties in the classical theory, especially ionization, chemical reactions, and photoelectric phenomena.

The important point is that the Quantum theory unequivocally denies certain fundamental views essential to the whole structure of traditional classical physical theory. Briefly, it denies continuity, and it asserts discontinuity. This is its main axiom; everything else in the theory is merely consequential.

The quantum theory introduces a new and universal *constant*, viz., the elementary *Quantum of Action*. We are already acquainted with other universal constants, e.g. the gravitational constant, the velocity of light constant, the electron mass and charge constants. Such constants form the very bedrock of physics. The new constant, the Quantum constant, does not, however, lend itself to a very simple explanation.

In principle the Quantum of action implies that an equation can be established between energy (E) and frequency (ν):

$$E = h\nu,$$

where h represents "Planck's constant". There are several ways of measuring h and therefore, in one sense, we know just what it is. Its value is 6550 *quintillionths* of an erg-second. This number may be written in full:

.00,000,000,000,000,000,000,000,000,655

Its utter insignificance of value is quite beyond the reach of the non-mathematician. Small as it is, however, it has a *real* value and this value is a correct index of all steps of "discontinuity". To *imagine* discontinuity of this amazing degree of fineness, and to contrast it with absolute continuity,

is impossible. We have to be content to accept it as a mathematical formulation of experimental results.

Planck's constant is commonly written

$$h = 6.55 \times 10^{-27} \text{ or } 6.55/10^{27}$$

The reader may find it helpful to ponder over an illustration of this kind. If a staircase were constructed to extend through a vertical height of 92,000,000 miles (the distance from the earth to the sun), and if the vertical rise of each step was $1/10^{27}$ (the denominator of Planck's constant) of the whole, there would be roughly *a hundred billion steps to the inch*. Truly a gently rising staircase! But no illustration of the minuteness of Planck's constant is likely to help the non-mathematician very much.

As Jeans has somewhere happily pointed out, an ordinary automatic machine provides a useful analogy to quantum action. Such a machine will deliver a quantum of chocolate or a quantum of matches, but not *part* of a quantum (bar of chocolate, box of matches). On the other hand it will deliver *as many quanta* (whole bars, whole boxes) as may be desired.

The constant h is expressed in "erg-seconds". The *erg* is the unit of energy, and the *second* is the unit of time so that h seems to be the product of energy and time. Now a mathematician often *divides* energy by time, but when he *multiplies* them together he feels that he is doing something unusual, something the very legitimacy of which may be open to question. The substance of the difficulty is purely mathematical, and is too technical to be considered here. The technical term applied to such a product is *action*, and for this reason h is sometimes known as Planck's "constant of action".

Care should be taken to distinguish between h , the Quantum of Action, and the Energy Equation, $E = h\nu$. The quantum theory may at first sight look like an atomic theory of energy, but it is anything but that. The quantum of energy (E) is a *continuous variable* and is always in proportion to the frequency, which is also a continuous variable. In

the equation, h is constant, but ν (the frequency) varies; therefore E varies. If ν is very large, as in the case of ultra-violet light, E (the quantum of energy) is large; if ν is small, as in the case of the infra-red heat rays, E is also small. The energy quanta of the cosmic rays, which are right away beyond the violet, are the largest known; then follow, in descending order, the quanta of the γ rays, of the X-rays, of the ultra-violet rays, of the visible rays, of the infra-red heat rays, and of the wireless rays. It is quite possible to imagine a frequency (ν) so high that all the energy in the universe would not suffice to make a single quantum.

And yet the ultra-violet end of the spectrum of a hot body shows very little energy. This sounds like a contradiction of what we have said in the previous paragraph. The explanation is that the difficult mathematical question of probability enters into Planck's quantum theory. Probability calculation shows that the *chance* of high frequency radiation actually receiving any of the large energy quanta *at all* is extremely small, but that the chance of low frequency radiation actually receiving any of the small energy quanta is very great. A rough comparison is the *small chance* of a single big shell fired from a great distance hitting a given mark, and the *great chance* of a multitude of small bullets fired from a number of machine guns at a short distance hitting the mark. Hence during a comparatively long period, the *average energy* of low frequency radiation at the red end of the spectrum is very much greater than that of the high frequency radiation at the ultra-violet end. As Jeans puts it: "very very few of the molecules or atoms in a hot body possess enough energy to emit a complete quantum of violet radiation." "In the physical system the energy of each vibration must remain the same and be equal to a multiple of $h\nu$, until a sudden cataclysm of some kind results in a change which again must be a multiple of $h\nu$."

The quantum theory originated in a happy guess. It has developed into a far-reaching hypothesis which has been constructed to bring into its ambit experimentally ascertained facts of different types, all of which seemed to stand outside

traditional classical theory. The hypothesis, though seeming to rest on inconsistencies and logical contradictions, and having no true foundations, is undoubtedly well-supported by a number of elegant and ingenious mathematical arguments. Mathematical physicists *feel* that the hypothesis, as now revised, may be considered to have advanced to the position of an established theory, but so far they have failed to put forward any semblance of a satisfactory explanation of its root principle—*why has nature tied up its energy in little packets?*

If we accept the Quantum theory, the old saw: "Nature never makes a leap" (*natura saltum non facit*), must be replaced by its converse: "Nature always proceeds in steps". We are asked to believe that Nature never flows, never glides; she always proceeds by jumps. It seems probable that the Quantum theory in some form has come to stay. It is, however, advisable to consider its present form as strictly provisional and to look forward to the time when it will be put on a much more rational basis.

2. Wave Mechanics.

What is the nature of *Light*?

As we have pointed out in previous chapters, **Newton** thought that light consisted of *corpuscles* of some kind, and by means of them he was able to explain most light phenomena satisfactorily. But they did not enable him to explain interference and diffraction, and the hypothesis of corpuscles eventually gave way to the hypothesis of *waves*, originated and developed by **Huygens**, **Young**, and **Fresnel**. The wave hypothesis survived until the beginning of the present century, and then arose doubts which caused **Einstein** to revive the hypothesis of corpuscles though in the form of light *quanta*. Einstein's light quantum, or *photon*, was a sort of atom of radiation, possessing energy of the amount $h\nu$.

For the last 30 years physicists have been busily engaged

in trying to come to a decision concerning the rival claims of corpuscles and waves to be regarded as the fundamental constituents of light. Generally speaking, optical effects point to waves and electrical effects to corpuscles. Some physicists have fought for corpuscles, some for waves, but all seem now to be convinced that the exclusive claims, either of corpuscles or of waves, must be rejected, and that a compromise must be found.

What is the evidence supporting the respective claims?

It very largely turns upon diffraction experiments. The reader will remember one such experiment in which light was made to travel through two slits one behind the other. The experiment may usefully be repeated here. Let a beam of sunlight be admitted through a small hole in a shutter and be received on a screen. The image leads us to infer that the light travels in perfectly straight lines and therefore consists of travelling corpuscles of some kind. The edges of the shadow are not, however, very sharp, and we therefore make the beam travel through a hole in a second shutter placed behind the first, in order that we may have a beam of nearly parallel light of breadth corresponding to the size of the holes in the shutters. We naturally continue to think of the beam as consisting of rays, and we try therefore to reduce these to just one. To do this, we continue to reduce the size of the hole; the beam gets narrower and narrower and the light image gets smaller and smaller. But when we get down to a very small hole indeed, any further diminution causes the image *to spread out* into an ever-widening circle (we may ignore the colours). Quite clearly this effect can no longer be explained by assuming that light consists of rays or corpuscles; but it *can* be explained by assuming that it consists of transverse *waves*, for it is the natural tendency of such waves to spread out. *Unless* we assume that this spreading out is due to waves, the wave theory of light can be dispensed with altogether.

Now precisely the same diffraction effects may be produced by electrons. That being the case, must we regard

electrons also as waves? If we do, how are electrons to be localized in space, or, for that matter, in time? If we regard them as *waves*, it is exceedingly difficult to deny to them the application of the general wave principle—that every photon and every electron extends over the whole of space and time? How in such circumstances can we *localize* an electron? How can we isolate a *piece* of a wave and say, “That’s an electron”?

Plate 23 (1) shows the typical ring-like character of X-ray diffraction. It is a photograph of a beam of X-rays which has passed through a powder of small crystals, the rings presumably being due to the diffraction of the X-rays by those crystals. X-rays provide a powerful means of effecting crystal analysis, but we are not now concerned with crystal analysis; we are concerned with the meaning of the rings. The presence of these rings seems to leave us no option but to infer that the X-rays which caused them were showing diffraction and that therefore X-rays are *waves*. (The round hole was cut in the centre of the plate to prevent fogging at the place where the intensely black central spot would fall.)

Now compare the diffraction of electrons. Although X-rays penetrate matter easily, electrons are entirely stopped even by thin sheets of matter, but the experimental ingenuity of Professor **G. P. Thomson** enabled him to construct extremely thin metallic films, strong enough to hang together but so thin (about $1/100,000$ of an inch) as to be virtually transparent. Plate 23 (2) shows electron diffraction through such a film of gold. The circles are not so sharp as those of the X-rays; that is hardly to be expected: the experimental difficulties are so much greater; nevertheless the general similarity is remarkable, and the conclusion seems irresistible that it is *waves* which were photographed. It is quite true that electrons travelling at a high speed generate X-rays, but it is certain that it was electrons and not X-rays that were diffracted, inasmuch as the circles shifted when photographed in a magnetic field. X-rays are not affected by a magnetic field.



Diffraction of X-Rays

A beam of X-rays passes through a powder of small crystals and falls on a photographic plate. The rings are due to the diffraction of the X-rays by the small crystals.

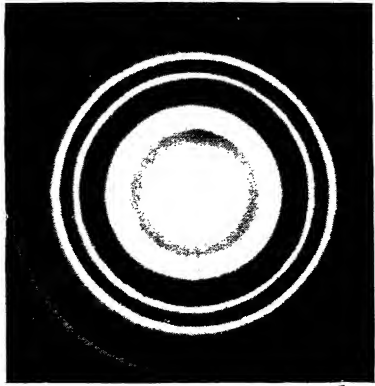

Electron Diffraction by Transmission through Gold Leaf

By courtesy of Professor G. P. Thomson

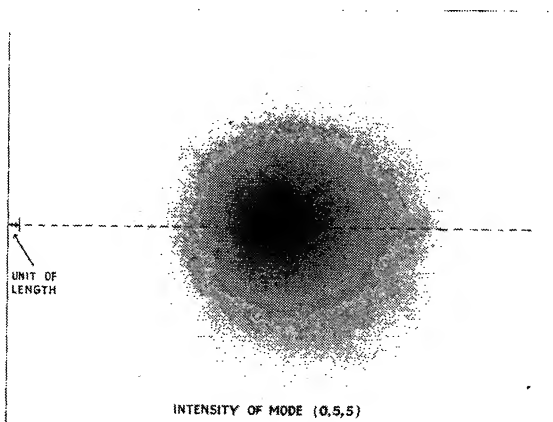

A Mode of the Hydrogen Atom

From "On New Conceptions of Matter", C. G. Darwin (Bell & Sons, Ltd.)

As Professor C. G. Darwin says, "The diffraction of electrons is a tremendous fact".

But this is only one side of the question. Just as we sometimes infer that light consists of corpuscles (photons) and sometimes that it consists of waves, so it is with electrons. If a stream of electrons is allowed to impinge on a zinc sulphide screen, beautiful scintillating effects are produced and these with the help of a magnifying lens can easily be seen in the dark. The conclusion is irresistible that we are watching a heavy shower like that of fine hail, and that a scintillation is produced every time a "hailstone" hits the screen; or that the electrons are virtually little bullets travelling along lines from machine-gun to target. If we watch these scintillations, or if we watch the track made in a Wilson's chamber, it seems impossible to bring ourselves to believe that the phenomena are due to interfering waves. We are driven to give our vote to particles.

Striking evidence that *light* consists of corpuscles (photons) and not waves is furnished by the *photo-electric* effect. The term "photoelectricity" is usually employed to denote a change in the state of electrification of a body exposed to light, whether the "light" is right down in the infra-red, or in the visible spectrum, or up in the ultra-violet, or even beyond in the region of X-rays. When X-rays fall on the atoms of a gas, electrons are ejected from the atoms; or when light shines on metallic films of potassium, sodium, rubidium, &c., free electrons are ejected from the atoms of the metal. These are called *photo-electrons*; they fly away at high speed, and it is possible to measure experimentally their speed or energy. It is necessarily the incident light which provides the energy of these ejections, but the speed of the electrons is not increased by using more powerful light. Strong light produces *more* ejections but not more violent ejections. But the speed *is* increased by using light of greater frequency. Thus the power of the light to act is not determined by its intensity but by its frequency. Blue light has great power, red light but little; it is simply a

question of frequency. The intensity of the light determines only the quantity, not the quality, of the photoelectric action. We may compare the phenomenon with the sea-waves breaking on a beach and rolling the pebbles about; the more violent the waves the more pebbles are thrown and the farther they are thrown. *If the water waves behaved like light*, an almost calm sea would throw a few pebbles as violently as a great storm throws them all. Obviously the light does not act as we usually conceive waves to act. Even with the feeblest light there is no detectable lag between switching on the light and the appearance of the photo-electrons.

The change of wave-length by the scattering of X-rays was investigated by **A. H. Compton** (*b.* 1892), Professor of Physics at the University of Chicago, who showed that it can be simply and satisfactorily explained by the quantum theory.

How can a *wave* give up its energy otherwise than *continuously*? Einstein could not answer this question and it was he who suggested that light contained units of energy which behaved exactly like particles. When one collides with an electron, we assume that it gives up its energy to the electron which can then escape from (say) the surface of polished metal. All the quanta in a given light are assumed to be the same, and the stronger the light the more numerous they are. If light is thus conceived to consist of particles instead of waves, it is essential for the explanation that the quanta shall be so concentrated that one electron shall catch a whole quantum. *Why should it?* This is the photo-electric paradox.

Einstein adopted a light-quantum formula in 1905 which has since been proved to be closely in accordance with a large number of experimental facts. According to that formula, light with a frequency ever so little below a certain minimum limit might fall on, say, potassium for a thousand years without ejecting a single electron. But let the frequency be increased to that minimum limit, and electrons are liberated at once. Experiments show that each electron comes out with a kinetic energy equal to, or at least not greater than,

the energy of the quantum of incident light, the difference representing the work necessary to get the electron out of the metal.

The Principle of Uncertainty. “Uncertainty” has invaded modern physics to such an extent that it has been reduced—perhaps we should say “elevated”—to a *Principle*. Underlying the notion is the apparent impossibility of deciding experimentally the question of particles *versus* waves.

Suppose, for instance, we wish to determine the relative *positions* and *velocities* of a number of particles, say electrons. Theoretically, there is no difficulty in doing this to any required degree of accuracy, but when we attempt to devise the necessary experiment, physical limitations arise which impose definite limitations on the accuracy we can obtain.

We have, of course, to make the electrons visible by some means, and we therefore employ a microscope supplied with light in the usual way, and take a photograph of the field of view. In practice we should necessarily view a multitude of electrons at the same time but we may argue the case logically as if we viewed only one.

The light we use is the real source of trouble. We see the electron by the light which it scatters, and the very least it can scatter is a single photon.

First, consider the *position* of the electron. We cannot fix the position with absolute exactness, because the image of the point appears in the focal plane of the microscope, not as a point, but as a disc, *the diameter of which is directly proportional to the wave-length of the light used*. Actually, of course, we are dealing with a multitude of electrons, and we shall therefore have a multitude of overlapping discs, and the only way of meeting this difficulty and of making accurate observations is by using light of very small wave-length, say ultra-violet light.

But—and here is the real trouble—the light we use *itself possesses momentum* and thus imparts momentum to the

electrons. The shorter the wave-length of light, the greater its momentum. If, then, in order to obtain a clear image of the electrons we use light of very short wave-length, the light itself introduces much disturbing momentum. If on the other hand, we try to keep down the errors of momentum, by using, for instance, red-light with its longer wave-length, the image becomes confused, and the fixing of exact position becomes hopeless. In any circumstances the electron receives from the light which it scatters a more or less violent kick, and it can be shown (compare de Broglie's equation $h = mv\lambda$, page 528) that the change in the electron's velocity due to the kick is *inversely proportional to the wave-length of the light used*. Thus the smaller the uncertainty of position, the greater the uncertainty of momentum; and vice versa.

To summarize. If we measure the *position* of the electron accurately, we shall measure its *momentum* very inaccurately, because of the disturbances caused by the outside momentum received from the light. If we measure the *momentum* of the electron accurately by using light introducing little outside momentum, there will be serious errors in the measurement of *position*.

In any given case there is a definite relation between the errors of the two kinds. The *product* of the two possible errors, or **uncertainties**, is independent of the wave-length, and is a multiple of Planck's constant h , e.g., $h/2\pi$.

All this sounds like a cunningly devised plot on the part of nature to prevent our seeing the locality and the motion of the electron within the atom. In such circumstances it seems reasonable to ask, *Is there such a locality?* But a question much more to the point is, *Is there such a thing in all nature as an exact position being associated with exact momentum?* It is certainly doubtful.

Ordinary experiments with gross matter are made with instruments so designed that they do not perceptibly disturb the object measured. When, however, we try to experiment with electrons, such non-disturbance is impossible; as we have just seen, the very light we use—and we are bound to

use it—scatters them in all directions. Moreover, the distances to be measured in atomic physics are unimaginably minute, though the ingenuity of physicists almost leads us to believe that there is scarcely any limit to the accuracy with which they may determine either position or momentum. In actual practice, however, the two measurements of position and momentum always seem to interfere with each other, so that the combination of the measurements legitimate in large-scale physics, becomes indefinable and impossible on the small scale. As we have said before, it is clearly impossible to identify and measure a single electron; we always have to deal with vast multitudes, and to deduce as best we can the sizes, velocities, &c. of individuals. But such results imply, not certainty, but only probability.

For reasons which we shall discuss in a later chapter, the term “Uncertainty” is preferable to the term “Indeterminacy” when applied to the questions we have been discussing.

We now come to the main question: can waves and particles be merged, and be conceived as a single entity?

We have seen that electrons may produce diffraction effects and therefore reveal their wave-like nature. Though experiments are at present lacking, theory predicts with some confidence that an electron moving at the rate of one centimetre a second is an electron-wave of wave-length seven centimetres. Now a wave of this wave-length does not signify a wave with only two crests seven centimetres apart; it means a train of waves stretching *indefinitely* in both directions with all the crests at seven-centimetre intervals. We may conveniently think of a small piece of this train, just a particular group of crests and troughs, in which the energy is specially concentrated, and ignore the remainder. Such a group is sometimes called a *wave-packet*. Figure 123 shows diagrammatically a wave-packet travelling to the right. We conceive the electron as *somewhere within the wave-packet*, but precisely where we cannot tell. The packet moves with the group velocity, and as the electron must keep in the packet

somewhere, it must move at something of the same rate. But the wave-packet lengthens, and the region available for the electron therefore grows; the speed of the particles may therefore be a little more or a little less than the packet. The important point is this: that though we think of a particle as associated with a wave, it is impossible to know where in the wave it is, and impossible to say what its velocity is. All we can be reasonably certain about is that the electron is *somewhere* in the wave-packet. To this, as to everything else in wave mechanics, the Uncertainty Principle applies.

The motion of the single electron in an atom of hydrogen provides us with the simplest case. Suppose we have a group

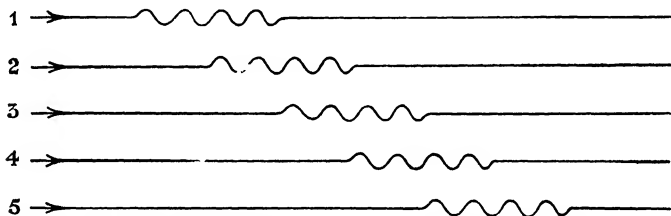

Fig. 123.—Travelling wave-packet. Positions at successive minute intervals of time.

of waves—a *wave-packet*—somewhere near the nucleus. It travels at first in an elliptical path round the nucleus, much as the Bohr particle does, but after a time the packet will have extended more or less right round the centre, perhaps something after the manner of a wave travelling round a bell just struck and therefore beginning to vibrate, the bell, like the atom, being a closed system. Plate 23 (3) shows Professor C. G. Darwin's conception of a *section* of the electron orbit of a hydrogen atom. It is supposed to be rotated about the axis on the left. The hazy ring shows the *wave* aspect of the orbit. We are not, however, supposed to think of the electron as a sort of solid ball travelling round a circular or elliptical tube. The travelling thing is the wave-packet, and somewhere in the packet is its sister-self, the two Siamese sisters being called a **WAVE-partICLE**.

We may provide ourselves with a rough analogy by

considering the appearance of a white spot chalked or painted on the tyre of a motor-car. The car begins to move and the white spot begins to revolve and appears to lengthen. As the car increases in speed, the white spot acquires the appearance of a complete circle; a rather hazy circle, especially at the edges. The hazy circle is analogous to the revolving wave packet; the white spot itself, now lost but known to be still there, is analogous to the electron as a particle. Such an analogy must not be pressed very far, as the differences from the real Wavicle are much greater than the resemblances. Modern physics has given birth to many strange children, many of them petted and spoiled, but the Wavicle is by far the greatest general pet at present. And yet physicists are one and all afraid of it. "What is it really like?" they say. "If we seek its intimate acquaintance, will it let us down very badly?" It probably will.

No exact description of a Wavicle is possible. What we have to *try* to do is to think of a wave system in which the individual waves cancel each other out by interference everywhere except at just one place, where they intensify one another. We may, if we please, look at this wave-point of intensity as giving birth to the electron as a particle; or we may, again if we please, look at the electron as a particle giving birth to a train of waves. Honestly we cannot distinguish parent and child. One rather caustic critic says: "It is all very much like trying to localize a violent agitation amongst the waves of a stormy sea. It seems to be now here, now there, now gone, now reappeared elsewhere, ever fugitive and escapable. There seems to be a disturbing entity of *some* kind, but it is unknown, and therefore neither describable nor definable. The physicists call this elusive entity in the waves ' ψ '. If you want to make a physicist really angry, ask him to describe ψ in exact language. To one physicist, ψ is a 'singularity'; to another, a 'wave function'; to a third a 'field symbol'; to a fourth, a 'probability'; to a fifth, an 'elementary indefinable'. To the mathematician ψ is a thing of joy; to the physicist a thing of terror."

The main problem is now in the hands of the mathematicians, and for the last five or six years a group of young mathematicians have been wrestling with it. We ought perhaps to call them mathematical physicists, for most of them seem to be almost equally at home in both subjects.

The most distinguished of them are **de Broglie**, a Frenchman; **Schrödinger** and **Heisenberg**, Germans; and **Dirac**, an Englishman.

The wave mechanics of de Broglie and Schrödinger.
 —Prince Louis Victor de Broglie (*b.* 1892), the younger son in a distinguished French family of Piedmontese origin, is a “master of Conferences” in the faculty of Science at the Sorbonne, Paris. It was he who first put forward an acceptable idea for bridging the gulf between corpuscles and waves. The general idea which first floated in his mind was virtually that of the wave-packet hypothesis. In the theory which he developed, the particle corresponds to a wave-group, and he tried to assimilate the motions of particles to the wave equations of Fresnel. The core of his theory was the hypothesis that a freely-moving particle with total energy E and momentum mv should be regarded as equivalent to a plane wave of frequency ν and wave-length λ . He adopted Einstein’s relation $E = h\nu$ and gave plausible arguments for another similar relation, viz., $mv\lambda = h$, where h is Planck’s constant or quantum of action (6.55×10^{-27} erg-seconds). This new equation of de Broglie’s has now been amply verified experimentally. De Broglie’s view was that *any moving particle must be accompanied by a wave*, and he assumed that *the wave must control the motion of the particle*. Thus instead of Newton’s laws of motion (which admittedly still hold good for the large-scale phenomena of everyday life), de Broglie substituted **a motion governed by waves**, and this is the basic idea of “wave mechanics”. As de Broglie himself put it: “The object of the wave mechanics is to create a synthesis embracing (1) the dynamics of a material particle, and (2) the theory of waves as conceived by Fresnel. On the one hand, the effect

of this synthesis must be to introduce into optics the idea of *points of concentration of radiant energy*, an idea which seems to be required by the recent results of experimental physics; on the other hand it must introduce *the conceptions of the theory of waves into our picture of material particles*, in order to account for the occurrence of quanta in mechanics, and for intra-atomic phenomena. The new mechanics defines the possible motions of material particles by means of equations of propagation."

Erwin Schrödinger used de Broglie's theory to build up wave mechanics into a rigorous mathematical system. He adopted the hypothesis that a corpuscle is resolvable into a wave packet, and the foundations of his mechanics are referred, quite generally, to the principles of wave motion. By finding the differential equations for de Broglie's waves, he successfully grappled with many of the problems of quantum phenomena. He showed, for instance, that it was meaningless to assign a definite path to an electron in an atom, and thus he turned the Bohr orbits into fictions. Light is still to be regarded as propagated in electromagnetic waves, but the energy of the light is concentrated in particles (photons) associated with the waves. In short, the de Broglie theory as developed by Schrödinger does seem to reduce to some kind of order the chaos of explanations of the properties of atoms; and it also seems to lend itself to physical interpretation. The scheme seems at first sight to fuse waves and particles together into a sort of entity that can be visualized, and this is very satisfying—satisfying because we can describe in exact language the picture we have conjured up. But, alas, the waves which emerge from the de Broglie-Schrödinger mathematics are only "probability" waves, to which we seem compelled to deny any sort of material nature.*

In many physical phenomena, it is very difficult to understand how localized energy can be carried by waves, and we feel driven to fall back on the language of particles. In classical

* Probability occupies, of course, a very important place in mathematics. We shall touch upon it in a later chapter.

physics the concept of particles implied the possibility of stating their position and velocity, but, as we have seen, in atomic physics this cannot be done. We seem bound to maintain the concept of a particle, but we then find ourselves compelled to face the question of its whereabouts at a given moment. It is not very satisfying to be told that mathematics demonstrates wavicles to be waves of probability, and that energy carriers are probably to be found somewhere in the probability region.

The de Broglie-Schrödinger theory was very popular for a considerable time, but the scheme is no longer representative, by a very long way, of all the known facts; in short, it has broken down.

The new theory of Quantum Mechanics. Even before Schrödinger had completely worked out his theory, W. Heisenberg put forward a new and entirely original scheme. Bohr had suggested that classical models might be used as an aid to the discovery of the correct algebraic rules for describing quantum phenomena. This suggestion was promptly adopted by Heisenberg, who within a short time did a great deal to transform previous tentative quantum methods into a compact mathematical scheme.

Heisenberg* rejected the wave-packet idea because it included an element of the unobservable. He maintained that, since all our knowledge of the interior of the atom comes to us from the study of the spectra, any rational scheme of interpretation must start off with a representation of the atom by means of quantities directly connected with *actually observed* spectral frequencies. This led to the development of the *matrix* † mechanics, every term of a matrix corresponding

* I do not forget Heisenberg's able collaborators Max Born and Jordan, but it is impossible in the limited space available to do more than give a general outline of the subject.

† Though the applications of matrices are only for the trained mathematician, the general principle of a matrix is easy to grasp. It is simply a rectangular array of quantities, usually square, in rows and columns. The reader interested in mathematics should read up the chapter on Determinants in any good algebra, then H. W. Turnbull, *Theory of Invariants*, and M. Bôcher, *Higher Algebra*. See also *Selected Papers on Wave Mechanics*, de Broglie and Brillouin, p. 22.

to something which is at least ideally observable. The table of rows and columns looks something like a determinant, and the rules of calculation which apply to them are those used by mathematicians for algebraic matrices. In a product of matrices the order of factors cannot be changed. This matrix method represents reality by means of a set of equations, but we are not supposed to inquire too closely concerning the physical implications of the mathematical processes.

Heisenberg's theory included the hypothesis of a *spinning* electron, the spinning making the electron a small magnet, the energy of which is, naturally, quantized. The hypothesis made it possible to give a full demonstration of the Periodic Law, and the Periods of 2, 8, 8, 18, 18, and 32 became really comprehensible. But the whole of Heisenberg's theory is highly technical and can be understood only by highly-trained mathematicians.

The present Lucasian Professor of Mathematics at Cambridge is **P. A. M. Dirac** (*b.* 1902), a distinguished son of the University of Bristol. His appointment to Newton's old Chair before he had reached the age of 30 shows fairly clearly what his brother mathematicians thought of him. The mathematical world are expecting him to do great things during the next 40 years.

Dirac introduced a method of quantum mechanics of an even more general character than that of Heisenberg. For the representation of atomic quantities he introduced quantum numbers ("*q*" numbers). With these *q* numbers, ordinary arithmetical operations can be carried out with the exception of the commutative law of multiplication. Dirac's scheme presents great mathematical difficulties, and it is significant that the term transcendent has been applied to it, which is another way of saying that it is beyond the comprehension of all ordinary people. There is, however, no doubt that the scheme presents us with a wonderfully complete and coherent system for codifying all our knowledge of "wavicles".

As with Heisenberg's scheme, so with Dirac's. A *physical*

interpretation seems impossible, but we cannot withhold our admiration of the mathematical craftsmen who have been able to crowd such a mass of facts into a symbolism which seems almost to defy criticism.*

Eddington asks his readers to contemplate the fundamental though mystic formula

$$qp - pq = ih/2\pi$$

which the few master mathematicians of the day are now so freely using. On the right-hand side, 2π we know, for it is merely a numerical factor; h we know, for it is the atom of action; i (or $\sqrt{-1}$) we know (or think we know) for it is an old friend from trigonometry and generally makes us think of waves of some kind. But what about the left hand side? We may call q and p co-ordinates and momenta, but that gives no explanation why qp is not equal to pq and why $qp - pq$ is not equal to 0. Quite obviously q and p cannot represent simple numerical measures.

Eddington puts it this way: For Schrödinger, p is an *operator*. His "momentum" is not a quantity but a signal to us to perform a certain mathematical operation on any quantities which may follow. For Heisenberg, Born, and Jordan, p is a matrix, an infinite number of quantities set out in systematic array. For Dirac, p is a symbol without any kind of numerical interpretation; he calls it a q number, which is another way of saying that it is not a number at all.

The deepest digging has been done by Dirac, but even he has not been able to unearth anything except symbols, and now we are gravely told that with symbolism we must be finally satisfied; we must give up our craving for clear

* Mathematical readers will, however, be interested in a paper, by LEVI CIVITA, headed *Some Mathematical Aspects of the New Mechanics*, which appears in the *Bulletin of the American Mathematical Society*, Nov., 1933, pp. 545-6. Levi Civita points out that DIRAC, in working out his equations, introduced as a mathematical tool an auxiliary lattice, without any reference to the atomic events; and that, since in the equations there is a residual influence of the lattice, the equations must be abandoned.

visualization, and for any kind of model-making; we are bidden even to be suspicious of a mathematician who shows a bias for an arithmetical interpretation.

But can the mind find repose in symbolism? We go out on a cloudless night and "see" a multitude of stars. We believe that "light" (whatever light may be) from every one of them has been travelling with a velocity of 186,000 miles a second, and that from the very nearest (*Proxima Centauri*) it has taken over three years to reach us. Imagine a light wave (as we will call it) set up as the result of a single emission from a single atom in a star, say ten light-years distant. The energy of the wave has ever since been spreading over an ever-extending sphere, which, after 10 years, must have a radius of about sixty billion miles. If at the appropriate moment at the end of the ten years we are looking in the right direction, that wave, weakened to an inconceivably insignificant degree since its start, strikes the retinae of our eyes and we "see" the star. But how? Is it conceivable that the wave will deliver a whole quantum of light? If it delivers less, nothing is supposed to happen. One explanation suggested is that if, say, one quadrillionth of a light quantum is brought within range of each atom of our retinae, one atom out of every quadrillion in the retinae will absorb a whole quantum. Alternatively, what the light-waves are really bringing within reach of each atom is not a quadrillionth of a quantum but the quadrillionth of a "chance" of delivering a whole quantum. This "propagation of chance", bizarre as it seems, has been put forward in all seriousness.

Of course we may if we please, imagine, not a wave, but a light-corpuscle, a photon, starting from the atom in the star, and, after its sixty billion mile journey, finding itself not too tired to interact with an atom in our retinae and enable us to catch a glimpse of its parent who kicked it out ten years before.

Physicists seem to be convinced that the interaction between radiation and matter in single quanta is something lying at the very root of physics, but they have not yet been

able to tell us precisely what that interaction is. They cannot devise a self-consistent scheme which will adequately cover all the known facts. It is not at all difficult to get some of the most eminent physicists to say, "We simply don't know".

Waves or Particles? That question answered, all difficulties will fade away. But an answer which conceals itself in a thick mist of mathematical symbols will never be regarded as an entirely satisfactory answer. So far, all the attempted reconciliations of the two opposing hypotheses have passed into a realm of abstract theory with apparently no relation to the world as we know it.

In his presidential address to the British Association in 1928, Sir William Bragg said, "On Mondays, Wednesdays and Fridays we adopt one hypothesis, on Tuesdays, Thursdays and Saturdays the other. We know that we cannot be seeing clearly and fully in either case, but are perfectly content to work and wait for the complete understanding." Most admirable advice. But what about Sunday, that famous day of dogmatism? There are a few—only a few—physicists and mathematicians who claim that they *know*, and their claim is put forward with all the certainty of medieval theologians.

Admittedly part of the trouble is due, as Dirac suggests, to the fact that some of the new concepts cannot be explained in terms of things previously known, and have for the present to remain in a mathematical setting. But that is surely no basis for dogmatism.

Perhaps our faithful little friend Alice will help us once more:

"Which of these finger-posts ought I to follow, I wonder?"

It was a difficult question to answer, as there was only one road, and the finger posts both pointed along it. "I'll settle it," Alice said to herself, "when the road divides and the posts point different ways."

But this did not seem likely to happen. She went on and on, a long way, but wherever the road divided there were sure to be two finger-posts pointing the same way, one

marked, " *To Tweedledum's House* ", and the other, " *To the House of Tweedledee* ".

" I do believe," said Alice at last, " that they live in the same house. I wonder I never thought of that before." She wandered on till, on turning a sharp corner, she came upon two fat little men standing under a tree (fig. 124).

" I know what you are thinking about," said Tweedledum, " but it isn't so, nohow."



[From *Through the Looking-Glass*, MacMillan & Co.

Fig. 124

" Contrariwise," continued Tweedledee, " if it was so, it might be; and if it were so, it would be; but as it isn't, it aint. That's logic."

" I was thinking," Alice said, very politely, " which is the best way out of this wood, it's getting so dark. Would you tell me, please?"

But the fat little men only looked at each other and grinned.

" It *was* funny " (Alice said afterwards) " to find myself singing, *Here we go round the mulberry bush.*"

3. Relativity

Until the beginning of the present century, classical mechanics, that is, the mechanics of Galileo, Newton, and Maxwell, was universally accepted, but some thirty years ago the development of extreme refinement in measurement led to the discovery of new facts and therefore to the revision of existing theories. The two new ideas which gave modern Physics its present characteristic shape were the Quantum hypothesis and the hypothesis of Relativity. Though each of these hypotheses is, in its own way, revolutionary, the two have nothing in common. It is to the second that we now turn.

As Whitehead and others have pointed out, the theory of Relativity is the product of many minds. Primarily, it is founded on the discoveries in mechanics by **Newton**, and in electromagnetics by **James Clerk Maxwell** (1831-79), first Cavendish Professor at Cambridge. For its development and proper handling, however, a substantial amount of a new and very special type of algebra and differential geometry has been necessary, and this mathematical equipment was provided by **Ricci** and his pupil **Levi Civita**, by **Riemann**, **Christoffel**, and **Minkowski**, all of them mathematicians of outstanding ability. The fundamental mathematical transformations that are used in the theory were the discoveries of **Larmor** and **Lorentz**. The work of all these men was brought to a focus by **Albert Einstein** in his theory that events in space and time can be treated geometrically in terms of a four-dimensional curved space-time.

The hypothesis of "Relativity" itself was expressly stated by Clerk Maxwell, before Einstein was born, in the following words:

"If every particle of the material universe within the reach of our means of observation were at a given instant to have its velocity altered by compounding therewith a new velocity, the same in magnitude and direction for every such particle, all the relative motions of bodies within the system would go on in a perfectly

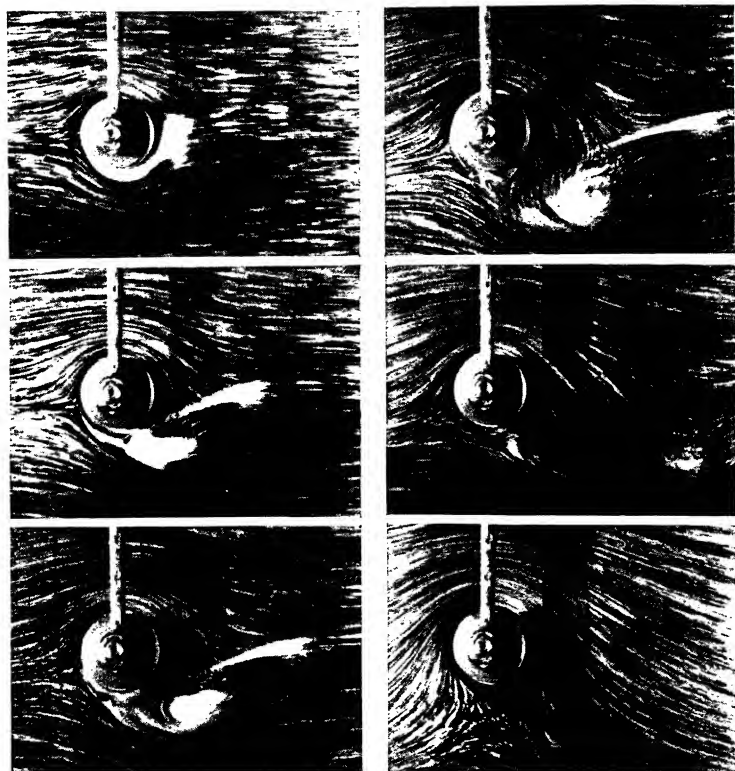

Successive Stages of the Flow round a Rotating Cylinder

continuous manner, and neither astronomers nor physicists, though using their instruments all the while, would be able to find out that anything had happened."

Sir **Joseph Larmor** (*b.* 1857), Lucasian Professor at Cambridge, 1903-32, made the following comment upon Maxwell's statement:

"This appears to be a very drastic postulate of relativity."

In making his statement, Maxwell had in mind what is briefly described by mathematicians as the "invariants" of the Newtonian mechanical equations for the ordinary kinematical transformations. This means that if we write down the Newtonian equations for the motion of a particle relative to the walls of the room in which we are sitting, and then deduce the equations of motion for the same particle relative to the walls of another room moving with constant velocity with respect to our room, then the two sets of equations of motion are exactly the same, and the particle will behave in exactly the same way with respect to the two different rooms.

The modern theory of relativity starts off with the laws of electromagnetism instead of the laws of mechanics, and from these laws as basic principles it works backwards. It assumes, for instance, that the electromagnetic behaviour will appear exactly the same as viewed from the two rooms, and then ascertains what the relations between the measurements taken relative to the two rooms and to any time must be in order that the electromagnetic phenomena should appear to be the same.

To the non-mathematician, the above brief statement will necessarily not be very clear, but in the next few pages we shall try to simplify the underlying implications as far as this is possible without the aid of serious mathematics; but the reader must remember that the whole subject is, in its very essence, mathematical, and if he is not a mathematician he cannot hope to get to the heart of the subject. We shall

therefore deal with the subject briefly and broadly, in the hope that the reader will be sufficiently interested to follow up these pages with a course of reading which we shall suggest later.

The main difficulty about the hypothesis of Relativity is its apparent antagonism to many of our settled views of physical science. In some ways this antagonism is real; in other ways we find that the antagonism vanishes as soon as we examine our old views critically.

Other special difficulties commonly associated with the subject arise from our unexamined predilections as to the nature of space and time. A few of these we may usefully touch upon first.

Try, for a moment, to imagine that we live in an absolutely dark, silent and motionless world. Should we then be likely to have any views *at all* as to the nature of space and time? Doubtless we have views of some sort *now*, but can we justify them? We can measure *lengths*; we can measure the *distance* between motionless objects, but if the objects were not there, we could not measure the *space* they occupied. We can count the beats of a pendulum, and we then say we are measuring *time*, but what *is* the eternally flowing thing to which we give that name? What *is* it that we thus measure off, apparently in successive equal bits? It is extremely difficult to say.

We sometimes say that New Zealand is "down under". The New Zealanders say exactly the same of us. We and they seem to occupy the same *relative* positions. Whenever we consider either space or time, we seem to be dealing with some sort of *relativity*. More often than not it is a question of *relative motion*, and then, as we saw in the case of the heavenly bodies, we are apt to be very easily deceived.

We sometimes speak of "infinite" space and "infinite" time, but the term "infinite" is a mathematician's term and is not likely to be understood by anybody else. It is easy enough to think of an infinite *series*. For instance, there is obviously no end to the series of natural numbers; and we may insert an infinite number of rational numbers between any given two, for instance between 4 and 5. The arithmetical

mean between 4 and 5 is 4.5; between 4 and 4.5, 4.25; between 4 and 4.25, 4.125; and so on indefinitely. But neither addition nor multiplication can lead to infinity, for it can never result in the unlimited. Nor can any process of reasoning lead to infinity, for unless the infinite is in the premisses it cannot be in the conclusion. Of course the mind is driven to believe that there must be something beyond its widest concept, but the actual imagining power of the mind can never go beyond an expansion with a boundary. No sort of clear conception is possible when we speak of infinite space or infinite time. Nevertheless, infinity of space and infinity of time may become *a necessity of thought*, and it would be quite impossible to justify a dogmatic denial.

We sometimes hear of different kinds of spaces and different kinds of geometries. What does this mean?

The ordinary space with which we are familiar is commonly said to be a space of "three dimensions", and the reason is simple. Any point in a *line* is determined by the distance from one of its ends, and a line is said to have "one dimension". Any point in a plane is determined by *two* measured distances, usually from two lines perpendicular to each other; for instance a point on a table may be 20 inches from one edge and 15 inches from an adjacent edge, and the two measurements 20 inches and 15 inches are sufficient to determine the point. Any place on an ordinary street plan is determined by two such measured distances. A plane is thus said to have "two dimensions". A solid, or an empty box, or an ordinary living room in a house, is said to have "three dimensions". For instance, the position of an electric bulb suspended from the ceiling is determined by three measurements; its perpendicular distance to the floor, and the two perpendicular distances of this point on the floor from two adjacent walls. Suppose we have an empty, perfectly regular, rectangular room (a parallelepiped), 20' \times 15' \times 12' and we fill it up with small wooden one-inch cubes; we begin with a row of 240 cubes, on the floor, against one of the 20' walls; 180 such rows would just cover the floor and give us a layer of 240 \times

180 cubes; 144 of these layers would just reach the ceiling and give us a total of $240 \times 180 \times 144$ cubes. The whole of the space of the room would now be full. The position of any cube could evidently be determined by three numbers, say 51 from the floor, 103 from the long wall, 29 from the short wall, or, more generally, by the three numbers x, y, z . Thus we are bound to think of ordinary space as having three dimensions and only three; up and down, right and left, front and back. But for all measurement purposes we want points and lines to measure *from*. In the case of a one-dimensional thing, say a straight line, we measure from one of its ends; in the case of a two-dimensional thing, say a table-top, we measure from each of two adjacent edges; in the case of a three-dimensional thing, say the room of a house, we measure down to the floor (the ceiling would generally be less convenient) and then to two adjacent walls. Thus for measuring, we always use a *frame of reference* of some kind. For three-dimensional measurements, our frame of reference is something like a common wooden box with its top and two adjacent sides knocked out. This notion of a frame of reference is of great importance in many Relativity questions.

In his scheme of algebraic geometry, Descartes used for his two-dimensional frame of reference, two lines at right angles to each other and for his three-dimensional frame, three lines at right angles to one another.

Of course algebraic equations with more than three variables (x, y, z) are possible (schoolboys often have to solve them), and the mathematician frequently has to use them, for he is often dealing with "manifolds" of more than three dimensions; but these multi-dimensional manifolds should not be referred to as multi-dimensional *spaces*. Such a usage makes the term space ambiguous. Relativity itself deals with four variables, but it does *not* deal with four-dimensional "space", such a space is inconceivable.

When we prove a proposition in geometry, we prove it by virtue of some other proposition, so that, eventually, at least

one proposition must be left undemonstrated. When geometrical knowledge was first systematized, such simple undemonstrable principles were placed at the beginning and took higher rank than demonstrated truths. Their empirical origin was often forgotten and they were called *axioms*. But axioms are certainly traceable to experience, and not only so but to experience gained in the small finite region of space with which we are familiar. It would be entirely illegitimate to extend such generalizations to all space. Axioms are not *necessary* truths, and since those we use are entirely a matter of choice, there is always the possibility of displacing them by others.

Consider the axiom, "Two straight lines cannot enclose a space." *Is this true?*—However we *define* a straight line, it is convenient to think of it as the shortest distance between two points and therefore to call it a *geodesic*. If we think of a geodesic between two points on the surface of a sphere, it is easily determined by a stretched piece of cotton, and this is seen at once to be part of a great circle, that is, a circle cutting the sphere into two equal hemispheres. But any two great circles on a sphere cut each other in two points; examples are two meridians, or the equator and a meridian, on the earth's surface. And since we live on the surface of a sphere, it follows that the two "straight" lines forming an angle on the paper before us are really parts of great circles, and therefore must, if produced to the antipodes, cut each other there a second time and therefore enclose space. This is not theory; it is sober fact; for the earth is demonstrably a sphere (we neglect its *precise* shape). Thus the axiom is clearly untenable, and, that being so, our confidence in Euclidean geometry is shaken. It must of course be realized that our most perfect "planes"—the surface of the sea, the surface of water in a basin, a perfectly planed table-top—are necessarily parts of a spherical surface.

Practically these are "planes", of course. But modern physics is concerned, not with rough approximations but with measurements of the most refined kind. Greek geometry was

derived from a mensurational experience, which Euclid idealized so far into a theory as to make the whole of it rest on a number of basic assumptions. But he made no allowance for curvature and his basic assumptions were therefore not strictly accurate. His geometry is presumably applicable to uncurved, flat space (sometimes called homaloidal space), though, strictly, we never measure *space*. *Practically* his geometry is applicable to all the measurement work we ever engage in, for, in all our ordinary measurements, there is no detectable curvature in the "planes" we test with our tools and apparatus. If, however, we do large scale work, we have to allow for the curvature; canal engineers, for instance, have to allow 8 inches to the mile. A canal made with a bottom absolutely "level" would eventually emerge at the surface of the earth; it would be the chord of an arc.

One of Euclid's propositions is that the angle-sum of a triangle is two right angles. Suppose we cut a sphere into 8 equal parts by means of three great circles at right angles to one another (if we "quarter" an apple in the usual way, then put the quarters together again, we may cut through the apple's equator and so obtain eight equal portions). If the 8 equal parts are put back into position, the surface of the sphere shows 8 equal spherical triangles, and every angle of every triangle is seen to be a right angle, and thus the angle-sum of each of the eight triangles is 3 right angles, not 2. In fact, the angle sum of *any* spherical triangle is greater than 2 right angles, and since we live on a spherical surface, the angle-sum of any triangle we may have to deal with will necessarily have an angle-sum of more than 2 right angles, though naturally in all ordinary cases the difference from 2 right-angles is quite undetectable.

Strictly, then, this particular proposition, so beloved of every schoolboy, is not true. The "proof" of the proposition is arrived at simply by considering the angles made by a transversal across parallel lines. Can there be anything wrong with Euclid's definition, or rather his postulate, of parallel lines? Readers may remember it:

“If a transversal cuts two straight lines in such a way as to make the two interior angles on one side of it less than two right angles, the two straight lines will, if produced far enough, eventually meet on that side.”

For a very long time mathematicians tried to prove the truth of this postulate, but they failed, and the result was that alternative systems of geometry were brought out.

Put into simple language, Euclid's contention amounts to this: *Through a point A outside a given straight line BC only one parallel to the line can be drawn in the same plane* (fig. 125). All non-mathematicians would promptly agree, but a considerable number of very able mathematicians have emphatically disagreed. **Gauss** (1777-1855), an eminent German mathematician, maintained that the postulate was probably false and urged that it ought to be empirically tested by measuring the angles of very large triangles. **Lo-**

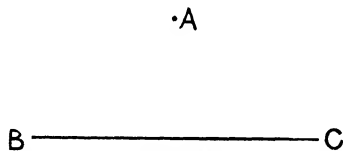

batchevsky (1793-1856), an eminent Russian mathematician, denied the axiom that only one parallel to BC could be drawn through the point A, and on this basis he built up a new non-Euclidean system of geometry though he accepted all the other axioms of Euclid. **Riemann** (1826-1866), another German mathematician, maintained that *no* parallel to BC could be drawn through A; he also denied the axiom that two straight lines cannot enclose a space; and he built up another system of non-Euclidean geometry. It is true that the fundamental assumption underlying these non-Euclidean geometries cannot be proved; but neither can they be denied. Lobatchevsky and Riemann were not, of course, considering merely *accessible* space, but the space lying indefinitely beyond. Lobatchevsky's geometry we need not consider further, but Riemann's geometry is practically the geometry of a positive spherical surface (e.g. the surface of an ordinary sphere); in other words it is just spherical geometry. But

Riemann extended the notion of measure of curvature from surface to *space*; he advanced proofs to show that observation cannot establish the fact that space is strictly Euclidean (that is, uncurved, flat, homaloidal), and he attempted to show that space may be finite though, like Euclidean space, unbounded. (Observe that although the surface of a sphere is finite yet unbounded, *this does not help us to visualize Riemann's space*). In Riemann's space every "straight" line (better, geodesic) would return into itself and be closed, like a geodesic on a spherical surface. Riemann's *geometry* is rational enough and convincing. His "space", on the other hand, is just an abstract mathematical manifold, logically deducible from his premisses but utterly inconceivable either as any sort of entity or as some modification of the space we know.

Relative Motion. If we are in a smoothly running train at night, travelling at a uniform speed, and we pass another train which is stationary, it is, as everybody knows, impossible to tell which of the two trains is in motion and which is motionless.

If from the window of a travelling train we drop a heavy body (heavy, so that the wind made by the moving train will have no appreciable effect on it), the body seems to us to fall in a vertical line, but to a person standing in an adjacent field the body seems to fall in a parabolic path. How can we say that one person is more "right" than another. When we are moving, our judgment of the position of a distant motionless object is bound to be different from what it would be if we were at rest; and if the distant object is itself in motion our judgment is more faulty still. It is with the *relative* motion of bodies that relativity is so largely concerned.

Fixed in a motor-car A is a big reel of measuring tape which can be paid out for measuring distances. A man in a motor-car B which is standing just in front of A takes the end of the tape. A remains stationary and B moves off at the rate of 20 miles an hour (we ignore local acceleration

and retardation). The length of tape paid out in 3 minutes is thus 1 mile. The car A now moves forward at a rate of 5 miles an hour and the car B accelerates to 25 miles an hour. Again the length of tape paid out in 3 minutes is 1 mile, showing that *relatively* the distance between the two cars is increasing exactly as before. Now suppose A to move backwards at 5 miles an hour and B forwards at 25 miles an hour; a mile of tape is now paid out in 2 minutes, showing that the cars are separating at the rate of 30 miles an hour. Thus when the cars are moving in the *same* direction, their relative motion is determined by taking the *difference* of their speeds ($v_1 - v_2$); when in *opposite* directions, their relative motion is determined by taking the *sum* of their speeds ($v_1 + v_2$).

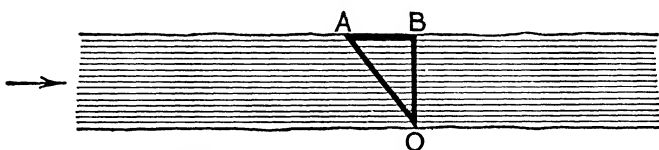

Fig. 126.—“Swimming across the river”

A river is 100 yards wide, and the rate of the current is 30 yards a minute. Let us compare the times taken by a swimmer, whose speed in still water is 50 yards a minute, (1) to swim a distance of 100 yards up-stream and back, (2) to swim directly across stream and back (fig. 126).

Against the current the swimmer covers $(50 - 30)$ yards a minute; *with* the current he covers $(50 + 30)$ yards a minute. Thus the time for the 100 yards up-stream will be $100/(50 - 30)$ minutes, and for the 100 yards down stream, $100/(50 + 30)$ minutes. The total time is thus $(5 + 1\frac{1}{4})$ minutes, i.e. $6\frac{1}{4}$ minutes. The swimmer going *across* the stream from O must aim at a point A above the point B where he wishes to arrive, so that OA represents the distance travelled in still water and AB the distance he has drifted down. Hence $OA/AB = 50/30 = 5/3$. Hence by the theorem of Pythagoras, BO (on the same $5/3$ scale) = 4. Since the actual length of OB is 100 yards, $OA = 125$ yards, and

the time taken is $125/50$ or $2\frac{1}{2}$ minutes. Another $2\frac{1}{2}$ minutes is required for the return journey. Thus the total time = 5 minutes.

We are now able to express the ratio

$$\frac{\text{Time for up and down swim}}{\text{Time for double transverse swim}} = \frac{6\frac{1}{4}}{5}.$$

This ratio may be otherwise expressed:

$$\frac{6\frac{1}{4}}{5} = \frac{50}{40} = \frac{1}{\frac{40}{50}} = \frac{1}{\sqrt{\left(1 - \left(\frac{30}{50}\right)^2\right)}},$$

which shows the manner in which the result depends on the ratio of the speed of the current to the speed of the swimmer, viz. $30/50$.

The ratio as thus expressed appears over and over again in the theory of relativity, and students of the subject will find that its significance is far-reaching.

The Restricted Principle of Relativity.

The well known phenomenon of the *aberration of light* led to the inference that the æther is stationary. The æther might therefore be used as a possible reference frame for all measurements.

But if the æther is stationary, the earth travelling in its orbit round the sun must be rushing through it and creating a sort of ætherial wind, much as a rapidly travelling motor-car or train creates an atmospheric wind. Plate 24, showing the successive stages of the flow of a fluid round a rotating cylinder, will perhaps help the visualization of such an ætherial movement.

Could the rush of the earth through the æther be put to an experimental test? The Michelson-Morley experiment was designed for this purpose. A. A. Michelson (1852-1931), of Polish birth, was Professor of Physics at the University of Chicago.

Michelson and Morley first performed the experiment in 1887. They used an interferometer, an optical instrument designed for producing interference fringes by the superposition of two beams of light originating from the same source, and for measuring the displacements of such fringes caused by any slight path difference between the two beams. The interferometer was constructed with two equal arms at right angles to each other, providing two equal tracks for the light beams. The two beams were made by dividing a single beam by partial reflection at a silvered surface, one of which was set to perform the up-and-down journey like the swimmer up-and-down stream, and the other the double transverse journey like the swimmer across the stream and back. When the two beams reached their turning points, they were sent back to their starting place by mirrors, and the result of the race was then easily determined. The apparatus was, of course, being borne along by the earth's orbital motion at a speed of 18 miles a second, and by varying its orientation and by performing the experiment at different times during the year, it was possible to ensure a maximum path difference between the two beams, if any difference existed.

To the astonishment of Michelson and Morley there was a dead heat. The half beam taking the longer journey in the direction of the earth's orbital motion got back at the same moment as the half beam taking the shorter journey transverse to the earth's motion. The earth's speed of 18 miles a second in its orbit had no effect whatever on the velocity of light. If the light travelling through the æther had behaved like the swimmer travelling through the water, there would have been an easily measurable difference denoted

by the factor $\frac{1}{\sqrt{\left(1 - \frac{v^2}{c^2}\right)}}$, where v is the velocity of the earth

and c the velocity of light.

A straightforward interpretation of the negative result is that when the light travels in the longitudinal direction,

its course is automatically *contracted*, so that whichever arm of the apparatus is placed up and down stream it straightway becomes *shorter*. If this contraction factor is of the value

$$\frac{1}{\sqrt{\left(1 - \frac{v^2}{c^2}\right)}}$$

everything is accounted for satisfactorily. This interpretation was put forward by the Irish physicist **G. F. Fitzgerald** (1851-1901), and was afterwards worked out theoretically by the celebrated Dutch physicist, Professor Hendrick Antoon **Lorentz** (1853-1928), of the University of Leyden. The explanation is really very plausible if we remember the electrical constitution of matter. Ordinarily, the form and size of a solid body is maintained by the forces of cohesion between its particles, and cohesion is assumed to be made up of electric forces between the molecules. But the æther is the medium in which electric force has its seat; hence it will not be a matter of indifference to those forces how the electric medium is flowing with respect to the molecules. When the flow changes there will be a readjustment of cohesive forces, and we may expect the body to take a new shape and size.

This Fitzgerald-Lorentz contraction explanation gave general satisfaction, though it was naturally impossible to put to an experimental test such a minute amount of physical contraction.

It is now that Einstein comes on the scene. Professor **Albert Einstein** is a brilliant German mathematician and physicist. He was profoundly dissatisfied with the explanation of the physical contraction explanation of Fitzgerald and Lorentz, and he put forward, nearly 30 years ago, an entirely different explanation of the null result of the Michelson-Morley experiment.

Einstein's Restricted or "Special" theory of Relativity is, in the main, just a new interpretation of the contraction (compensation) factor. The theory is based on two hypotheses:

1. *All reference frames in relative uniform motion are on an equality; no particular frame is privileged.*

2. *The velocity of light in vacuo is invariable and is independent of the motion of the body emitting the light.*

These two hypotheses granted, a rational explanation of the contraction factor follows.

The earth or any place on it (a laboratory, for instance) is not a *privileged* reference frame for making measurements of moving bodies; it is itself a moving body. There is no *real* contraction of a body moving in the direction of its length; there is, however, an *apparent* contraction (represented by the compensation factor) because of the relative motion of the reference frame and the body measured. Any velocity (v) that we are familiar with in every-day life is, however, so utterly insignificant when compared with the velocity (c) of light that the apparent contraction of a moving body, as determined by the contraction factor, is inconceivably small.

The second hypothesis seems strange. Suppose we are in a car travelling 40 miles an hour, and we suddenly turn on the head-lights. We are tempted to think that the light then travels at a velocity of $186,000 + 40/3600$ miles per second, the velocities being compounded in the usual way. But experiment shows that it is not so. As soon as light leaves the emitted source, no matter what the motion of the emitted source may be, the light seems to settle down at its own particular and unique velocity of approximately 186,000 miles a second, never more, never less.

There is only one real difficulty underlying the special theory of Relativity, and that concerns the notion of simultaneity. Events are usually reported to us by light-signals. Even if these come to us from relatively motionless bodies, they may deceive us; if they come to us from bodies in relative motion, they are almost certain to deceive us. *How*, in fact, can we determine whether events are simultaneous?—Look out of the window on to a busy street. The eye claims to see a hundred events all happening at the same moment. But clearly this is a fallacy. It is not the events that are hap-

pening in the instant *now* that the eye “sees”, but the sense impressions to which earlier events give rise. All the events had to be reported by light signals, and these despite their enormous speed take time. *All* the events happened before we could see them, and the more distant the event the earlier it happened. *We cannot dissociate time from space.* Again: suppose a man to die at the age of 80, 1000 miles from his birthplace. An inhabitant on a rapidly receding star might report the age to be 81 and the distance travelled to be billions of miles. A similar estimate would be made if we on the earth reported a like happening on the receding star. Relatively, the earth and star are receding from each other. Consider the earth and two such stars, all three receding

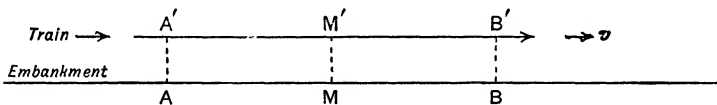

Fig. 127

from one another, and all reporting the happenings of events on the others. What about the attempt to discover absolute simultaneity amongst the reported events then?

Einstein's criterion of simultaneity is this. He measures off a length AB on a railway embankment, and places an observer, provided with two mirrors at 90° , at the exact mid-point M . If light flashes emitted from A and B are perceived in the two mirrors by the observer at the same time, then the flashes must have been emitted simultaneously (fig. 127).

He now considers a train moving with a constant velocity v , and we are to imagine that any event which takes place along the embankment also takes place at some particular point on the train. The criterion of simultaneity is to be applied with respect to the train in exactly the same way as with respect to the embankment. Einstein now asks if the lamp flashes which are simultaneous with respect to the embankment are also simultaneous with respect to the train.

Now events A and B correspond to positions A' and B'

on the train. Let M' , the mid-point of $A'B'$, be the position of the observer on the travelling train. When the flashes occur (as judged from the embankment), M' coincides with M , but is moving with the velocity v .

But not only is the observer at M' hastening towards the beam of light coming from B , he is also riding on ahead of the beam coming from A . Hence he will see the beam of light emitted from B earlier than he will see that emitted from A , not because the beam has changed its velocity but because it has a shorter distance to travel in order to meet him. He will thus conclude that the flash B took place earlier than the flash A . Hence events which are simultaneous with reference to the embankment are not simultaneous with respect to the train, and vice versa. Thus every co-ordinate reference system must have its own particular time; the idea of simultaneity is only a relative idea; "half-past one", or "fifty years" has no absolute significance. Einstein added: "Before the advent of the theory of Relativity, it had always been tacitly assumed in physics that the statement of time had an absolute significance, i.e. that it is independent of the state of motion of the body of reference. But we have just seen that this assumption is incompatible with the most natural definition of simultaneity; if we discard this assumption, then the conflict between the law of the propagation of light and the principle of relativity disappears."

On the same subject, Professor Eddington says: "Although there is an absolute past and future, there is between them an extended neutral zone; and simultaneity of events at different places has no absolute meaning. . . . The denial of absolute simultaneity is a natural complement to the denial of absolute motion. The latter asserts that we cannot find out what is the same place at two different times; the former that we cannot find out what is the same time at two different places. It is curious that the philosophical denial of absolute motion is readily accepted, whilst the denial of absolute simultaneity appears to many people revolutionary."

It is indispensable for the reader to bear in mind when considering the subject of Special Relativity that the behaviour of light is unique, inasmuch as its velocity is constant and cannot be increased or diminished, and is entirely independent of the motion of the source from which it is derived. If he remembers this, and remembers how easy it is to be deceived by relative motion, he should have little further difficulty.

The General Theory of Relativity.

In his Special or Restricted theory of Relativity Einstein had considered *uniform* rectilinear motion, but he decided to investigate the Relativity of *accelerated* motion, and sought to obtain a statement which should hold good for all observers, even though they are moving relatively to one another with different and possibly variable accelerations. The problem proved to be extraordinarily difficult and, able mathematician though he was, it took Einstein something like 10 years (1905-1915) to solve it. Only a thoroughly well-equipped mathematician can follow out the solution, and we shall have to be content with giving the reader a few hints as to what it is all about.

Newton's law of gravitation refers to a "force" and implies that the acceleration of a falling body is due to that force. But what *is* the force? How do we picture it? Do we imagine that some sort of invisible demon is engaged in a perennial tugging contest? If we try to think out the idea carefully, we are bound to confess that there is no justification for conferring upon some mysterious agency the same sort of pulling effort that we can exert with our own muscles.

Suppose that we are in an ordinary lift which is so well enclosed that we cannot see outside. If the lift is allowed to "fall" freely, that is, if it is given an acceleration of 32 feet per second every second, a stone in our hand when released would not fall to the lift floor but would appear to remain suspended in mid-air where we released it, though to an outside observer, if he could see what was going on in the lift, the stone would appear to be "falling" in the usual

way. Considerations of this kind show that it is impossible to decide whether the behaviour of a falling body is to be attributed to a gravitational field of "force" or to an acceleration of the reference frame. A gravitational field of force is obviously *equivalent* in its effects to an artificial field of force created by an accelerated reference frame. This is the essential point in Einstein's theory of gravitation.

Einstein expressed his Equivalence hypothesis thus: *A gravitational field of force is precisely equivalent in its effects to an inertial field produced by constant acceleration.*

By thus abolishing "force", Einstein virtually converted physics into geometry.

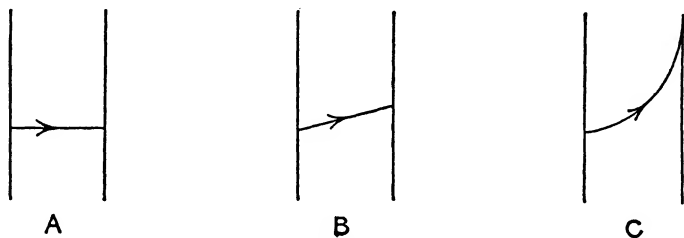

Fig. 128

Suppose a bullet which can leave a luminous trail in its wake is shot horizontally across a lift that is at rest: the luminous trail will be a horizontal line (A). Suppose the bullet is fired when the lift is descending with *uniform* motion; the bullet will hit the opposite side of the lift at a point higher than the point of entry, and the luminous trail will be a straight line sloping upwards (B). Suppose the bullet is fired when the lift is descending with *accelerated* motion; the bullet will again hit the opposite side of the lift at a point higher than the point of entry but the point will be much higher than before and the luminous trail will be a parabolic curve (C) (fig. 128). If the lift were moving upwards instead of downwards, the slopes of B and C would, of course, be reversed. Instead of a luminous trail from a bullet, a ray of light may be supposed to be crossing the lift. The inference

that *the path of a ray of light in a gravitational field is curved* seems to be legitimate.

One of the first problems given to beginners in astronomy is to prove that the effect of the earth's rotation is to decrease the weight of a body at the equator by about $1/289$ of the whole. If the earth rotated $\sqrt{289}$ ($= 17$) times as fast as it now does, the two forces, rotational and gravitational, would just balance, the "weight" of the body would be reduced to *nil*, and there would certainly be no tendency for the body to "fall" towards the centre of the earth; and we should be driven to invent an hypothesis to explain the neutral motion of the body. If the earth rotated faster still, the motion of the now flying-away body would be such that we should probably invent an hypothesis to the effect that the motion is due to a gravitational force of *repulsion* inherent in the earth.

Evidently, then, it is easy to confuse gravitational attraction with acceleration arising from the earth's rotation. In short, it is impossible to distinguish between the effects of gravitational attraction and the effects of acceleration of any kind whatever. Gravitational fields of "force" are really illusions. The apparent "force" arises solely from acceleration.

Einstein's task was to work out a law of gravitation *geometrically*. He had to bear in mind (1) the principle of equivalence, above quoted; (2) that space and time cannot be considered independently; (3) the finite and invariable velocity of light. The mathematical problem was formidable, but the previous and associated work of such eminent mathematicians as **Minkowski** and **Levi Civita** did much to help Einstein on his way. These mathematicians tilled the ground for Einstein much as Kepler and Galileo did for Newton.

In appearance, Einstein's gravitation law differs greatly from Newton's. But applied to particular cases the difference between the laws is almost negligible. Newton's principal incorrect assumption was that the velocity of light (and of gravitation) was infinite. It is not therefore difficult to see that the amount of error in Newton's calculations is of an order indicated by the ratio v/c in the contraction (com-

pensation) factor. Any ordinary velocity (v) is so insignificant compared with the enormous velocity of light (c) that the ratio v/c is almost, though not quite, negligible.

We may usefully quote from Mr. Bertrand Russell: "It now appears that the theorem of Pythagoras is not quite true, and that the exact truth which it adumbrates contains within itself the law of gravitation as an ingredient or consequence. Again, it is not quite Newton's law of gravitation but a law whose observable consequences are slightly different. Where Einstein differs from Newton in an observable manner, it is found that Einstein is right as against Newton. Einstein's law of gravitation is more general than Newton's, since it applies not only to matter but also to light and to every form of energy. Einstein's general theory of gravitation demanded as a preliminary not only Newton's theory but also the theory of electromagnetics, spectroscopy, observation of light pressure, and the power of minute astronomical observation, which we owe to large telescopes and the perfecting of the technique of photography. Without all these preliminaries, Einstein's theory could not have been discovered and demonstrated. But when the theory is set forth in mathematical form, we start with the generalized law of gravitation, and at the end of our argument arrive at those verifiable consequences upon which, in the inductive order, the law was based. In the inductive order, the difficulties of discovery are obscured."—They always are! and successful solvers of great problems seldom get full credit for their work.

In books on Relativity, the reader will be puzzled, unless he is a competent mathematician, over such terms as "intervals" and "world lines". The former term is well understood by mathematicians; the latter represents a misleading attempt to give a popular explanation of a continuous sequence of space-time events. The ideas of such events are embedded in mathematical symbolism, and I know of no successful attempt to present them in non-mathematical dress.

"Space-time" is another puzzling term, like the others, and can only be adequately explained mathematically. Some-

times it is referred to as "four-dimensional" space. That is utter nonsense. It is quite true that in all Relativity problems, space and time have necessarily to be considered together. Even our own *where* and *when* are always associated, as in the very headings of our letters, or in our preparations for a holiday. Space is *three-dimensional*, and when it is associated with time, we may treat time as a fourth dimension, and in that way we obtain a *four-dimensional manifold*, a quite common mathematical device for various purposes outside the realm of relativity. We may conveniently speak of a four-dimensional *continuum*, but the *time* dimension of this continuum cannot be treated in the same way as the three *space* dimensions are. Into the *time* element of the continuum, the mathematical symbol $\sqrt{-1}$ (often written *i*) enters, and for certain mathematical reasons this symbol forms the main *differentia* in space-and-time treatment. Admittedly its form $\sqrt{-1}$, gives rise to suspicion, and it is best not referred to as a number, even an imaginary number. Really it is a common mathematical *operator*, and there is nothing illegitimate about its use.*

Space-time should not be referred to as the "world" (a term connoting our own earth), or to the "universe" (a term connoting the concrete contents of space).

We live in three-dimensional space, though from this space we can never dissociate time. The geometry of that space *may* be Euclidean and must be if the space is flat (homaloidal); but if, as some Relativists urge, space is in some way curved, its geometry must be non-Euclidean, perhaps Riemannian.

When, at the close of the war, Einstein announced his theory to the world, he suggested that it might be tested in three different ways: (1) by the measured rotation of the orbit of Mercury; (2) by the measured deflection of light-rays in a gravitational field; (3) by the measured displacement

* For an interpretation of $\sqrt{-1}$, see Chapter XXVIII in the author's *Craftsmanship in Mathematics*, and the chapters on the Relativity of Simultaneity in his *Scientific Method*.

of spectrum lines towards the red. Some of our leading astronomers promptly set to work, and in all three sets of phenomena Einstein's calculations were found to be correct.

It was these three confirmations of Einstein's new gravitational law that caused many men of science to give it their adherence. But not a few shook their heads. After all, the law was the special interpretation of the result of the mathematical manipulation of certain measured quantities rather arbitrarily selected. *Was that interpretation necessarily correct?* If the four-dimensional continuum was interpreted as containing a three-dimensional space that was curved and finite, did not that interpretation so strongly oppose all our preconceptions that there was at least a possibility, if not a probability, of its being incorrect? It was not the mathematics that fell under suspicion: it was the *interpretation* of the mathematics.

For any sort of curved surface (or solid) which is *regular* the mathematician can easily devise an accurately representative formula, simple or complex according to the nature of the surface. It will readily be recognized that the formulæ for the surfaces of a sphere, an ellipsoid, an egg, a hollow ring (think of an inflated bicycle tyre), and a dumb-bell, would all be very different, but in all of them a trained mathematician would immediately see that curvature of *some* sort was implied. Einstein's final equations not only suggested that the continuum was curved but that the curvature was *positive*, i.e. that it was in some way convex, after the manner of a sphere. Doubts arose, partly about the interpretation and partly about the initial premisses. Were these premisses correct? and were they sufficient?

Ambiguities and Inconsistencies

On the 10th of May, 1932, at the University of Manchester, Sir James Jeans gave his Ludwig Mond Lecture on "The New Universe". In the course of the lecture he referred to the "expansion" of the universe. "Unless we have gone woefully wrong somewhere, the universe must be

doubling its linear dimensions about every 1,300,000,000 years." The lecture led to a long and animated discussion in *The Times*.

The Hon. **Stephen Coleridge** wrote: "Sir James Jeans says 'the universe is expanding'; what does he mean by 'the Universe'? Does he mean the stars and the space in which they are scattered? If he does, how can that collective entity expand? Space cannot expand, being of necessity infinite. It is absurd to tell us that space is not infinite, for if it does not go on for ever in every direction, the mind of man must conceive a limit to it, and then the same mind asks what is beyond the limit, and thus refutes the possibility of limit, unless the mind of man is diseased and incapable of reasonable thought. Then we are told that space 'must necessarily curve back on itself'. This means nothing unless space is something quite inconceivable to the human mind. Space being manifestly infinite cannot curve; a thing without limit can have no shape. 'The mathematical properties of such a curved space can, of course, be worked out'. I like the 'of course'. But you have to assert without relation to reason that space is curved before you can 'of course' work out its mathematical or any other properties. 'The universe is doubling its dimensions once every 1,300,000,000 years'. What is doubling? Into *what* is whatever it is doubling?"

(It will be observed that Mr. Coleridge quite correctly refuses to identify "the Universe" with "space").

In the course of his reply Sir **James Jeans** remarked: "Geography tells us that only a curved and finite representation of the earth's surface can be true to nature, and present-day science conjectures that the same is true of space. . . . We can only fit the parts of space properly together in a finite curved whole. It is not a matter of common sense or the reverse, but of interpreting the ascertained facts of Nature. When once this is understood there is no difficulty in thinking of space expanding. We know of nothing for it to expand into; nothing is needed, for what is expanding is the Universe, the whole. If we prefer, we may think of space as

retaining its size while all material bodies continually shrink. It comes to much the same, since the supposed expansion of space is only relative—to ourselves and our standards of length.”

(It will be noticed that Sir James does not preserve a constant connotation in his use of the terms “Universe” and “space”; and that science “conjectures” that “space” is curved and finite.)

Mr. Coleridge replied: “Common sense does not make me ‘conjecture’ that because the earth’s shape ‘is curved and finite’ it follows that ‘the same is true of space’. Common sense tells me that matter can and must have a shape, but that space does not and cannot have a shape. I decline to accept a truth about matter as being applicable to nothingness, i.e., space.”

Sir Robert Giles wrote: “Space, as we men in the street understand the term, means space in the sense of the total amount of available ‘room’ which may be occupied by matter in solid or attenuated form, or may be entirely unoccupied. If the universe can be correctly said to expand, then it would appear that it must occupy more of space than before and must necessarily be different from space. If space is curved, . . . it must have limits. . . . What ends it? . . . What lies beyond them, if not space?”

That distinguished Oxford logician, Mr. H. W. B. Joseph, expressed the opinion that “physicists cannot really claim to have appreciated the strength of their critics’ case.”

In the course of a further letter Sir James Jeans said: “The only things that permit of direct study, viz., events which affect our senses, can be arranged in a four-dimensional continuum (a blend of space and time), but science finds that the arrangements can only be logical and self-consistent if the continuum is curved. . . . We break this up for ourselves into space and time, and, however we do this, we obtain a space which is, we believe, curved and finite, and also, as we now think, expanding. . . . We still do not know what space is.”

(Here it is *space*, not the Universe, which is expanding.)

Mr. **Joseph** wrote again: "To consider how what I observe is arranged in space, I must already be familiar with space. I ask whether the events . . . of Sir James Jeans's construction seemed to him spatially related before he embarked on his construction. If he says *they did*, it was not according to the requirements of his four-dimensional curved continuum; and, as he is not merely proposing a new theory of how bodies are related in space but a new theory of space, he must divest himself in thought of every space relation of the kind of those they were once thought to have, before he can arrange them as he proposes. If he says *they did not*, equally what he proposes to arrange in elements have no space-relations. But we cannot arrange elements having no space-relations into space."

Dr. **Herbert Dingle** said: "Scientists . . . have erred in trying to make this new abstraction [the expanding universe] imaginable. The expanding spherical universe is only an analogy."

Professor **H. F. Hallett** wrote as a philosopher: "'Physical' space-time is, of course, not the same thing as mere emptiness (which only corresponds with its alleged boundlessness). It also possesses structure or metrical properties."

The discussion did not bring the physicists and their critics much closer together. Sir **James Jeans** probably erred in trying to provide the plain man with a picture of his interpretation of mathematical abstractions. Several of the writers (there were numerous others besides those we have quoted) were careless in the use of their terms. "Universe" must not be confused with space, and physical space (as Professor Hallett calls it) must not be confused with the empty, structureless, presumably unlimited, nothingness which we commonly think of (or try to) when we ordinarily think of space.

If we restrict the term Universe to the "stellar" universe (including our own sun and planets), and think of the "ex-

pansion" of the Universe as merely the recession of distant nebulae, a mental picture is possible. As for the empty nothingness, the "space", into which the universe may be said to expand, we necessarily know nothing at all. It is absolutely impossible to conceive infinite space; it is just as impossible to conceive finite space. When we try to do either, the mind seems to reel and to refuse to function.

Physical space, the possibly limited though inconceivably vast space having some sort of structure, may still be conveniently called the æther, not the æther of the last century, of course, with the extraordinary properties physicists had conferred upon it, but some kind of attenuated structure with light-wave carrying properties, though as to its actual nature, if it does exist, we know *nothing*.

But whether or not the æther itself is contained within an infinite void, it is entirely impossible to say. It may be that we are entirely wrong in differentiating between the two.

The really important point is this: is "space" (*not* the universe) flat, homaloidal, Euclidean, and perhaps infinite? or is it curved, non-Euclidean, and perhaps finite? Is the angle-sum of a stellar triangle *just* two right angles, or more than two right angles?

Most of the last fifteen years of agitation about Relativity has been over this question of curvature. It was **Einstein** himself who first postulated that space might be curved, but now-a-days it is only his disciples, not Einstein himself, who hold strongly to the original view. Both Professor **Einstein** and Professor **de Sitter**, the joint begetters of curved and finite space, appear to have disowned their progeny. Following a conference held at Mount Wilson, California, early in 1932, they announced (1) that it is quite possible to represent all the facts of observation *without assuming a curvature* of space; (2) that from the direct data of observation they found it impossible to derive either the sign or the value of any curvature; and (3) that ordinary Euclidean three-dimensional space might correctly find its way into the Relativity equations. Thus the Euclidean

universe seems to be re-enthroned, and when light is once started it does not traverse the "circuit" of the universe and return to its starting point, as the original conclusions of Relativity suggested, but goes on in a straight line indefinitely.

Einstein's modified views are probably due partly to a desire to make them square with his latest unified field theory, which includes both gravitation and electromagnetism in a single scheme; and partly to more recent interferometer experiments, like the original Michelson-Morley experiment. Professor **D. C. Miller**, who had taken part (in collaboration with Professor **Morley**) in the earlier experiments of 1904 and 1905, concluded that positive results with the Michelson-Morley interferometer would be obtainable in high altitudes. With improved apparatus at Mount Wilson Observatory, Miller conducted a series of experiments in 1921, 1924, 1925, and he announced that there was a positive displacement of the interference fringes, such as would be produced by a relative motion of the earth and the æther at the observatory, of approximately 10 kilometres per second. The experiment has been and is being repeated under more and more stringent conditions. Einstein admits that, if the æther drift really is confirmed, the special Relativity theory, and with it the general theory in its present form, will collapse. If it does, space may certainly be trusted to straighten itself out again.

Sir **James Jeans** seems to remain a faithful disciple of the Einstein of 15 years ago, and his philosophical views may make him reluctant to welcome the return of the Euclid of his school days. In his letter to *The Times* of 21st May, 1932, he said: "I am not a Realist", and he had already said (18th May, 1932), "If all consciousness were to vanish from the universe, how much would be left of space?" He seems to have become a disciple of Berkeley who believed that what are usually called "external objects" have no existence except as ideas in a percipient mind. Are we to infer that space only came into existence after consciousness had been evolved from life that had already appeared, and

that when consciousness vanishes space will vanish? If the radius of the universe (? space) doubles every 1,300,000,000, years, and if the last sentient being dies, say 10^{50} years hence, what a glorious sight we shall miss when, with the expiring breath of that being the colossal space-and-time bubble bursts and the whole universe shrivels up to nothingness. Berkeley would probably have claimed that even then space-time would continue to exist in the mind of the Deity. Would Sir James Jeans follow him thus far?

In one of his letters to *The Times*, Sir James Jeans referred to the four-dimensional continuum as a "blend of space and time"; this blend "we break up for ourselves into space and time" separately.—On the contrary: the "blend" is simply a useful algebraic device, and it is nothing more. We do not "break it up", for though we cannot completely dissociate space and time in thought, they are always separately present in our consciousness. Space has three dimensions and time has only one. Our experience of this one-dimensional time is immediate; the passage of time is a definite fact of the experience of every individual. Thermodynamics clearly distinguishes one portion of time from another; so does evolution. No difficulties of simultaneity can affect this main issue. The "present" is just an indefinitely fine line dividing the "past", which is gone for ever, and the "future", still to come. Those relativists who assert that "the flux of time is meaningless" are denying the universal experience of man, and they are making a statement which has no shred of evidence to support it.

Among living mathematicians none is more distinguished than Professor A. N. Whitehead. His three books, *The Principles of Natural Knowledge*, *The Concept of Nature*, and *The Principles of Relativity* are profound, and make difficult reading even for the professional mathematician. Even in the heyday of the General Theory of Relativity, Dr. Whitehead clung to Euclidean space, and he produced an alternative theory which, although very difficult of compre-

hension, includes all the facts on which the General Theory was based. In his *Principles of Relativity* he says:

“The present work is an exposition of an alternative rendering of the theory of Relativity. It is not an attempt to expound either Einstein’s earlier or his later theory. The metrical formulæ finally arrived at are those of the earlier theory, but the meaning ascribed to the algebraic symbols is entirely different. . . . I deduce that our experience requires and exhibits a basis of uniformity, and in the case of nature this basis exhibits itself in the uniformity of spatio-temporal relations. This conclusion entirely cuts away the casual heterogeneity of those relations which is the essential of Einstein’s later theory. It is this uniformity which is essential to my outlook, and not the Euclidean geometry which I adopt as lending itself to the simplest exposition of the facts of nature.

“Sir J. J. Thomson, reviewing in *Nature* Poynting’s *Collected Papers*, has quoted a statement taken from one of Poynting’s addresses:

“‘I have no doubt that our ultimate aim must be to describe the sensible in terms of the sensible.’

“Adherence to this aphorism, sanctioned by the authority of two great English physicists, is the keynote of everything in the following chapters. The philosophy of science is the endeavour to formulate the most general character of things observed. These sought-for characters are to be no fancy characters of a fairy tale enacted behind the scenes. They must be observed characters of things observed.”

In his *Concept of Nature*, Whitehead says:

“Those of Einstein’s results which have been verified by experience (see pp. 556–7) are obtained also by my methods. The divergence chiefly arises from the fact that I do not accept his theory of non-uniform space, or his assumption as to the peculiar fundamental character of light signals.

“In my judgment Einstein has cramped the development of his brilliant mathematical method in the narrow bounds of a very doubtful philosophy.

“ I should say at once that I am a heretic as to this explanation (the limiting of space).

“ I have reduced it [the Theory of Relativity] to a greater conformity with the older physics. I do not allow that physical phenomena are due to oddities of space.”

(Chapter VIII of this book gives a lucid descriptive summary of Whitehead's own method.)

In his *Principles of Natural Knowledge*, Whitehead remarks:

“ The whole investigation is based on the principle that the scientific concepts of space and time are the first outcome of the simplest generalizations from experience, and that they are not to be looked for at the tail-end of a welter of differential equations.”

On the whole it is reasonable to infer that Relativity is far less robust as an adolescent than as an infant it promised to be.

We shall return to the subject of Universe-making in a future chapter.

A Note for Mathematical Readers

Much of the misconception that exists in regard to the implication of the theory of relativity arises from an incomplete understanding of the procedure of mathematical analysts. The exact position is admirably stated by Professor Levi-Civita in the opening paragraph of his book on the *Absolute Differential Calculus*, a subject which he himself largely developed:

“ In Analytical geometry it frequently happens that complicated algebraic relationships represent simple geometrical properties. In some of these cases, while the algebraic relationships are not easily expressed in words, the use of geometrical language, on the contrary, makes it possible to express the equivalent geometrical relationships clearly, concisely, and *intuitively*. Further, geometrical relationships are often easier to discover than are the corresponding analytical properties, so that geometrical terminology offers not

only an illuminating means of exposition, but also a powerful instrument of research. We can therefore anticipate that in various questions of analysis it will be advantageous to adopt terms taken over from geometry."

In this paragraph it is plain that the language of geometry (i.e. the geometry we know *intuitively*: this intuitive knowledge is the whole point of the procedure) is merely borrowed.

The language is useful if it leads the algebra in a right direction, e.g. if we take two points on the surface of an ordinary globe (a two-dimensional curved manifold) there is plainly a "shortest" and a "longest" distance between them; in other words, *geodesics* exist, i.e., paths along which these "stationary" distances are to be measured. It is therefore legitimate to infer that, in an n -dimensional curved continuum, such special "paths" (or courses of the variables) enjoying similar properties may be expected.

When, however, the algebraical formulæ (which are *the* mathematical facts with which we have to deal) are interpreted geometrically in such a way as to force us to the conclusion that two distinct points need have no distance between them, the geometrical language is distinctly misleading, since it is *intuitively* obvious that, geometrically, two distinct points *do* have some distance between them. We cannot alter this fact by calling a "distance" an "interval", or by using any other euphemism; the fact remains that intuitively, there must be "separation", "distance", "interval". The geometrical language is therefore misleading, and we cannot possibly burke the fact.

Similarly, no mathematician maintains that an infinite Euclidean space is "unthinkable"; he is "thinking" it all the time and embedding his " n -dimensional non-Euclidean manifolds" in it—just as he embeds an ordinary globe in three-dimensional Euclidean-space before he tries to think of its surface as a two-dimensional non-Euclidean manifold. All through his book, Levi-Civita is doing this, e.g. "Take any hypersurface V , and consider it as immersed in a Euclidean space S_{n+1} , and consider also a hypersphere of unit radius,

and centre the origin" (p. 258). When the mathematicians say that "natural" space-time is a "four-dimensional curved-space" they merely mean that for many purposes *measurements* in space and time behave, *algebraically*, as if made on a four-dimensional curved manifold. This structure need no more be the "reality" than an ordnance survey map is the country which it represents metrically. The mathematician is merely trying to build up a geometrical model which may or may not be helpful, according to the tastes and prejudices of the user. Whether his model, as such, is or is not correct is a matter which can be, and can only be, settled by comparing it with *facts*.

This mathematical model which the mathematician tries to build is in four-dimensions and is therefore quite inconceivable to us, intuitively. Its use *to him* is that there is an *analogy of language* between (1) the algebra and the three-dimensional geometry with which we are intuitively familiar, and (2), the algebra and geometry of n -dimensions; and this analogy will, he hopes, lead his analysis in the right direction. The mathematician is under no misconception as to the true nature of his model. He knows well enough, no one better, that the model is just an abstraction, and the trouble comes when he tries to present a popular picture of it to laymen, who necessarily have to rely on their intuitive ideas of a three-dimensional space; he naturally finds it impossible to make the position intelligible to them. The task is, in fact, a hopeless one, and can only end in confusion and paradox.

It is this abstract geometrical model that has seized upon the public imagination, so that the theory of relativity has come almost to be identified with it. As has already been remarked, the theory is really quite independent of the model. **The theory is essentially an algebraic theory** based upon the invariants of differential algebraic forms for all classes of transformation. *This algebraic theory can be given an entirely different interpretation in which no space-time model at all is used.*

Such an interpretation has been given by Professor Whitehead, but it has not turned out to be so popular as the geometrical model. Professor Whitehead does not try to teach laymen what he knows they cannot understand.

(Portraits, Plates 21, 25, 27.)

BOOKS OF REFERENCE:

1. *The Quantum and its Interpretation*, H. S. Allen.
2. *Report on Radiation and the Quantum Theory* (Physical Society), J. H. Jeans.
3. *The Quantum Theory*, Fritz Reiche.
4. *La Théorie des Quanta*, L. Brillouin.
5. *The Universe in the Light of Modern Physics*, Max Planck.
6. *Quantum Chemistry*, A. Haas.
7. *The Physical Principles of the Quantum Theory*, W. Heisenberg.
8. *The Wave Mechanics and Free Electrons*, G. P. Thomson.
9. *Selected Papers on Wave Mechanics*, de Broglie and Brillouin.
10. *Collected Papers on Wave Mechanics*, E. Schrödinger.
11. *An Outline of Wave Mechanics*, N. F. Mott.
12. *The Principles of Quantum Mechanics*, P. A. M. Dirac.
13. *The Physical Significance of the Quantum Theory*, F. O. Lindemann.
14. *Space and Time*, Emile Borel.
15. *Relativity*, J. Rice.
16. *The Theory of Relativity*, Albert Einstein.
17. *The A B C of Relativity*, B. Russell.
18. *The Ideas of Einstein's Theory*, J. H. Thirring.
19. *Relativity and Gravitation*, T. P. Nunn.
20. *Scientific Method*, F. W. Westaway.
21. *Space, Time and Gravitation*, A. E. Eddington.
22. *The Principle of Relativity*, A. N. Whitehead.
23. *Newton's Law of Gravitation in an Infinite Euclidean Space* (*Phil. Mag.*, Vol. X, July, 1930, article by John Dougall).
24. *Some Points in the Philosophy of Physics* (Article in *Philosophy*, January, 1934), E. A. Milne.
25. *The Aether Drift Experiment*, Prof. D. C. Miller (*Nature*, 3rd Feb., 1934).

An excellent introduction to the subject.



The Million Volt Spark
Nat. Phys. Lab. and H.M. Stationery Office

CHAPTER XXXIX

Practical Developments in Physical Science

Even to summarize the various developments in the different departments of practical chemistry, practical physics, and practical engineering, that have taken place during the last 30 years, would require a book of many hundreds of pages. Keen and able research workers are busy in all the leading universities of the world, and abstracts of at least 5000 original papers are now officially published every year. There is, of course, a vast quantity of other work done, but probably not one research worker in ten achieves work of any permanent value. Thus there are great numbers of university students, especially in Germany, engaged in attempting the syntheses of new organic products. Such research, if it may legitimately be called research, is routine work of a rather hack kind; much of it is more likely to lead to the usual Ph.D. degree and then to be forgotten than it is to become a permanently useful contribution to scientific knowledge. Sometimes a great discovery is made by intelligent "trial and error". The aeroplane was thus born, the American brothers Wright being its parents.

We can afford space only to give some general indication of the scope of the work that has been done. To that end we may make a small selection of special interest, and then at the end of the chapter suggest a list of books wherewith the reader may supplement his knowledge.

Two preliminary matters may receive brief attention: (1) The necessarily provisional nature of all scientific hypothesis; (2) the nature of "units" in physics and engineering.

Scientific Hypotheses

To illustrate this subject, it must suffice to refer to a single instance, and for this purpose we will choose hypotheses of the nature of **Hearing**.

We are all familiar enough with noises; for instance, those from railways, factories, all forms of motor vehicles, electric drills, and many more, and we are hopeful that the work of Dr. G. W. C. Kaye at the National Physical Laboratory in connexion with noise abatement will soon bear fruit. The present available protection from noises seem to be: (1) suppression at the source; (2) the use of isolating screens or enclosures, or, alternatively, absorption; (3) the arresting of structure-transmitted noise by breaking its continuity in some way, or by the interposition of elastic isolating devices. There are, however, certain unsolved riddles concerning noises; for instance, a violent explosion may be heard for a distance of about 60 miles, then it becomes inaudible for about another 60 miles, when it may be heard again. But the main point at the moment is, *how* do we hear noise? If there were no ears there would be no noise. An uninhabited world would be a silent world, despite all the efforts of wind and waves.—How do we *hear*?

Certain interesting facts have certainly been discovered. For instance, the ears of insects are never found in the head, but usually in the thorax or abdomen, or, as in the case of grasshoppers and crickets, just below the knee-joint of the forelegs. Fish are certainly deaf to all air-borne sounds; so are snakes, though the snake-charmer would persuade us otherwise.

The structure of the human ear is well known, though it is extraordinarily complex. The ear drum is a flexible diaphragm which receives sound energy from the surrounding air and transmits it to the liquid-filled cochlea. The efficient transmission of this energy from a relatively light and yielding medium to a heavy resistant fluid requires the intermediary of a mechanical transformer, a lever, having the correct lever

ratio. This is provided by a chain of ossicles in the middle ear. The cochlea is a tiny tapering spiral tube, somewhat resembling a small snail shell, on the floor of which is the "organ of Corti", consisting of many thousands of *rods* of Corti, rather suggestive of a piano keyboard with thousands of keys, and it is something of a temptation to think that it must therefore be such a keyboard. Other parts of the inner ear are equally remarkable.

There are various rival hypotheses as to the nature of hearing, all of which are largely based on inferential evidence, because the small size, the delicacy, and the inaccessibility of the internal ear make direct observation and experiment virtually impossible. There are, e.g. the telephone hypothesis, the volley hypothesis, the pattern hypothesis, the stationary wave hypothesis, and the resonance hypothesis. Present-day controversy mainly centres round the telephone hypothesis and the resonance hypothesis. According to the *telephone* hypothesis, the ear behaves like a microphone; variations of air pressure in the ears are followed by the passage of impulses up the auditory nerve fibres to the brain which thereupon interprets them and assigns them to the external sources of noise, musical or non-musical, which originated them. According to the *resonance* hypothesis, the rods of Corti are resonators, the natural periods of vibration of which correspond to the range of audible frequencies. When physical tests are applied to hearing, evidence seems to favour the resonance hypothesis. But we really *do not know* what part the ear plays as an intermediary converter in bringing about the change from the external air-vibrations to the sensation we call sound. That the auditory nerve is a line of communication between the external source of sound and the brain, we know; and that is about *all* we know. The rest is, at present, nearly all guess work.

So it is with the various hypotheses of vision. *We do not know* either how we hear or how we see.

Beware of hypotheses. Never confuse them with facts.

Units in Physics and Engineering

Every teacher of physics and engineering insists upon his students acquiring a sound knowledge of units, and unless those readers who are untrained in science take the trouble to master some elementary text-book on the subject, they will always find their knowledge a little vague and unsatisfactory. Our notions of weight, distance, and capacity would be vague indeed if we knew nothing of the pound, the foot, and the pint.

It is really all very simple. Consider, for instance, the significance of the term "work". What do we mean when we speak of "foot-pounds" or "horse-power"?

A familiar example of mechanical work is the lifting of a load, and we may express the amount of useful work done by the product *weight* \times *vertical height*. Thus if we lift 1 lb. through a vertical height of 1 ft. we may say we have done 1 foot-pound of work; if 10 lb. through a height of 4 ft. or 4 lb. through a height of 10 ft., then we have done (10 \times 4) foot-pounds of work. But it is usually necessary to know the *rate* at which a man or a machine is working. A nineteenth century bricklayer with his coat, waistcoat, collar, and tie off, and shirt-sleeves up, would lay 1000 bricks in a day; a twentieth century bricklayer, with his packet of cigarettes and his betting news sheet, does well if he lays 350 bricks a day. Both eventually build a given wall, and therefore do the same "work", but for an effective comparison we have to think of work in *unit time*. Thus we think of a horse-power as 550 *foot-pounds per second*, or 33,000 *foot-pounds per minute*. We do not, however, usually think of actual horses these days; rather we think of a horse-power as the energy output of an *engine* which is capable of raising 550 lb. through a vertical height of 1 ft., or 55 lb. through a height of 10 ft., in 1 second.

The electrical engineer does not, however, use units based on the foot and the pound but on the centimetre and

gramme; his unit of work is called the *joule*, and his delivered rate of working, a joule per second, is called a *watt*. It is convenient to remember that 1 horse-power = 746 watts, and that a kilowatt (1000 watts) = 1.34 (= 1000/746) horse-power. The term *kilowatt-hour*, so familiar in our electricity accounts, is the amount of electricity used up when 1000 watts are taken from the supply for 1 hour, or 500 watts for 2 hours, and so on.

The *joule* is sometimes defined as the work done in one second by the *ampere* (unit of current) flowing through the *ohm* (unit of resistance). The ampere is sometimes confused with the *volt* (unit of pressure). If a water tap is directly connected with the main, and if the town reservoir is, say, 200 feet above the level of the house, the water is delivered from the tap with great force because of the pressure behind it; but if the town reservoir is only just above the house level, the water merely trickles from the tap, though, *if time is allowed*, any given amount may be delivered by the latter, just as by the former. If the pipe delivering at the tap is small, there is a *resistance* to easy flow, and the amount delivered in any given time is less than if the pipe is large. Very much the same sort of thing applies to a current of electricity as to a current of water. It would be of no use if electricity were allowed merely to "trickle" into the house; it would have no energy to supply any appreciable amount of light or heat; the electricity has to be *driven* along the cable, and the harder it is driven, the more energy it brings with it, and the more is used up in a given time. This driving force or *pressure* is measured in *volts*. Thus the current varies *directly* as the pressure. If, however, the wire carrying the current is small, there is much *resistance*, and the smaller the wire the greater the resistance: the current varies *inversely* as the resistance. Hence we may write:

$$\text{Current (amperes)} = \frac{\text{pressure (volts)}}{\text{resistance (ohms)}}$$

Evidently both pressure (volts) and current (amperes) are

factors in the electrical energy delivered and consumed, and we may say

$$\text{watts} = \text{volts} \times \text{amperes.}$$

Such a general description of units will give a fairly satisfactory idea of their relations, but laboratory experience is necessary to ensure exact knowledge of them. Failing such experience, a quarter of an hour's chat with an electrical engineer at a generating station will go a long way.

Chemistry

1. **Coal and coal-tar products.** Few people other than trained chemists are aware of the remarkably varied character of the hundreds of products derived from coal. We may give a short summary. A ton of bituminous coal distilled at 1100° C. yields about 11,000 c. ft. of gas, 1 cwt. of coal-tar, 13 or 14 cwt. of coke, 3 or 4 gallons of light oil, and 4 or 5 lb. of ammonia gas (as a liquor). The coal-tar itself yields, at successive distillations:

- (i) At 170° C., *light* oil; from which are derived benzene, naphtha, carbolic acid, toluene, &c.
- (ii) At 210° C., *middle* oil; derivatives:—aspirin, phenacetin, lysol, dyes, &c.
- (iii) At 240° C., *heavy* oil; derivatives:—creosote, &c.
- (iv) At 270° C., *green* oil; derivatives:—anthracene, &c.
- (v) Pitch: for roofings, waterproofings, &c.

The subdivisions are far too numerous to be included here. If the reader will obtain a book on the subject, and make out a kind of genealogical tree, showing a complete list of the divisions and sub-divisions of coal-tar products, he cannot fail to be impressed with the enormous value of common coal.

The potential scientific use of coal is almost unlimited. Synthetic albumin has been produced from coal at the Kaiser Wilhelm Institute. Another derivative, glyco-ethylene is now

being used extensively in the preparation of "low-freezing" explosives. A large class of plastic articles is being made from the resinic constituents of coal. The phenolic resins are being used to produce moulding materials, laminated products, and cements. Professor **G. T. Morgan** recently announced that synthetic resins can be used for the manufacture of a non-splintering glass for motor-cars. In America, alumina is being obtained from coal on a commercial scale. In another category are the aromatic compounds, the fungicides, and the wood preservatives.

The use of tar-oils as a substitute for petrol in driving vehicles has made some progress, and the most efficient process which has yet been devised is the hydrogenation process which has been developed at Billingham by Dr. **Friedrich Bergius**.

Essentially, all fuels consist of carbon and hydrogen combined in different proportions. In oil, the proportion of hydrogen is higher than in coal, though oil contains less oxygen than does coal. Obviously, then, in order to turn coal into oil, the proportions of carbon, hydrogen, and oxygen, must be readjusted. The possibility suggested itself of adding extra hydrogen to the coal substance in order to make up for the hydrogen deficiency, and then to devise means of inducing the molecules of the mixture to reshuffle themselves into oil molecules; and it was Dr. Bergius who, at Mannheim, was the first to liquefy coal by direct hydrogenation. The process consists essentially in subjecting coal to the action of hydrogen at a high temperature and a high pressure.

A commercial plant has been operating in Germany for some years, and the process, now enormously improved, is undoubtedly a technical success, in that it can produce spirit of very high quality. About 4 tons of coal are required to produce 1 ton of petrol, and, if produced on a large scale, the cost would probably be about ninepence a gallon. We import more than three million tons of petrol a year, and at first sight, therefore, it looks as if we might manufacture

our own petrol, with great profit to ourselves. But the hydrogenation process does not yet appear to be capable of standing on its own feet commercially, and private enterprise, unassisted by the Government, will probably shrink from setting up plant on the very large scale required. A full-scale plant for dealing with 10 or 15 tons of coal per day has been set up at the Billingham factory, but relatively speaking, this is a mere toy. Not the least of the mechanical difficulties of working on a large scale is due to the requirement of simultaneous high pressure and high temperature. The future of the infant industry is doubtful.

2. The Inert Gases and Low Temperatures. At the British Association Meeting of 1894, Lord Rayleigh (1842-1919) announced his discovery of argon. The discovery was the result of his patient weighings of the residual gas which was found after depriving air of all its oxygen. This was a discovery of the first magnitude, and it heralded the new physics. The next year, Rayleigh's colleague, Sir William Ramsay (1852-1916), exhibited to the Association other members of the inert gas family. Inert and chemically indifferent though these gases are, they have found industrial uses. Helium fills airships; argon fills incandescent lamps; neon is the ostentatious night-assistant to the pushing tradesman advertiser. Moreover, it was neon that first introduced us to isotopes, and helium is the key to all radio-active transformations.

Sir James Dewar (1842-1923) did prominent work in liquefying gases. In 1898 he liquefied, and in 1899 he solidified, hydrogen. For these purposes intense cold was necessary, and the schoolboy naturally asks, when he hears of these increasingly low temperatures, How cold *could* it be?

Cold is merely the comparative absence of heat, just as darkness is the comparative absence of light. If a body loses some of its heat it becomes colder; if it lost *all* its heat it could become no colder, but it has by no means lost it all at 0° C. A gas at 0° C. contracts $1/273$ of its volume



T. LEVI CIVITA



PROF. ARNOLD SOMMERFELD
Photo. Exclusive News Agency



SIR ARTHUR EDDINGTON
Photo. Clarke



SIR JAMES JEANS
Photo. London General Press

for every degree Centigrade that it is cooled. At -273°C . it will have lost all its heat: that is absolute Zero. But what the condition of the gas at that temperature would be we do not know. In recent years, however, absolute zero has been more and more nearly approached. Helium has been liquefied and it boils at -267°C . Recently it has been frozen into a solid at -272°C ., only 1°C . above Absolute Zero. What next? We must "wait and see". If we take Absolute Zero at the beginning of a temperature scale, then ice melts at 273°C . and water boils at 373°C .

Professor Lindemann has set up a Helium Liquefaction plant at the Clarendon Laboratory, Oxford, a type developed by Professor Simon and Dr. Mendelssohn in Berlin and Breslau. The main object of liquefying Helium is to provide means of cooling other substances, the characteristics of which it is desired to study in the neighbourhood of absolute zero.

Liquid air was originally produced at the cost of £100 a pint; now the cost is about a penny a gallon. Put into a teapot and set on ice it boils vigorously, the ice being relatively very "hot". Solid carbon dioxide (-80°C .) is much used in refrigeration; as much work can be done with 100 lb. of it as with a ton of ice. Even the Romans knew the use of refrigeration for the purpose of preventing decay and putrefaction, though ice and snow were the coldest substances with which they were familiar.

3. **Fine Chemicals.** Few people realize what a great advance Great Britain has made during the last 15 years in the chemical industry. In the production of fine chemicals we are now second to none, and a summary of the main groups cannot fail to be of interest.

(1). *Medicinal and pharmaceutical chemicals.* These constitute the most important group, for they provide the vitally essential antiseptics and anaesthetics which make modern surgery possible; narcotics and analgesics for the relief of pain; synthetic remedies used in the treatment of

diseases; alkaloids such as strychnine and morphine and other plant products. These, together with biochemical products, afford representative examples of medicinal fine chemicals.

(2). *Laboratory chemicals.* These are used in research laboratories, universities, and teaching institutions, professional analytical laboratories, and laboratories attached to industrial concerns.

(3). *Photographic chemicals.*

(4). *The so-called rare earths,* used largely in the electric filament lamp and gas-mantle industries.

(5). *Synthetic essences and perfumes,* comprising such things as artificial musk, vanillin, coumarin, and many other such substances.

The biochemical products of the first group are of the greatest and of growing importance. They comprise the hormones and other gland products of which the outstanding example is insulin, and the vitamins and their preparations. With these things we are well ahead of all other countries. The new discoveries in biochemistry, especially in vitamins and hormones, which are still taking place with great rapidity, redound greatly to the credit of British scientific workers who have done such brilliant pioneer work in the subject.

We have no space to refer to other branches of industrial chemistry, but readers who are interested in the subject should refer to the better-known text-books on perfumes, flavourings, dyestuffs, the cellulose industries (mercerized fibre, vegetable parchment, artificial silk, lamp filaments, photographic films, celluloid, enamels), rubber, explosives, luminous paints, artificial manures, food preservatives, evaporated foods and condensed foods, and so forth. Industrial chemistry has become a very big thing; it is representative of a highly intelligent personnel and of highly skilled labour. Such industries as the chemistry of dye stuffs and the chemistry of artificial silk always prove of fascinating interest to the uninitiated.

4. Chemistry in Warfare. The uninformed public have fastened on this corner of chemistry as if it were truly representative of the whole subject.

It is quite true that, if there is another world-war, it will probably be largely war from the air, and huge cities may be almost wiped out in the course of an hour or two. In his book, *Disarmament*, Professor Noel Baker says that the Berlin bombs prepared for use in the 1919 campaign would have killed every person in the open within 600 or 800 metres of the spot where a bomb exploded, that is, an area roughly equal to the city of London. Even if bombs are not dropped from aeroplanes, shells will be propelled from guns, though it is true that in the former case the civilian population will be brought within the war zone.

But it is the supposed possibilities of gas poisoning, rather than the dire results of high explosives, that tend to stir the imagination of the general public. Such possibilities are enormously exaggerated, as we shall show in the last chapter. In any case it is impossible to limit research on poisonous compounds, for they play a necessary part in the development of insecticides, fungicides, germicides, disinfectants, preservatives, fumigants, and drugs. In the United States alone the annual destruction by insect and animal pests reaches the astonishing total of more than two billion dollars, and quite evidently the production of insecticides on a very large scale is necessary. In this country, thousands of tons of chlorine are annually used in perfectly legitimate peaceful occupations such as bleaching, and any number of other dangerous chemicals are produced and used in industry.

The war-maker will use any effective weapon that comes to hand. Why should the chemist be blamed for this?

Physics and Engineering

1. Electricity. Astonishing advances in electrical developments have taken place during the last 20 years.

When war broke out in 1914, the largest generators were rated at about 10,000 kilowatts; now, they are 100,000. Electric traction on main lines had hardly begun; now, we have thousands of miles of it. Electric light and household appliances were luxuries for the well-to-do; now, they are common in the homes of villagers. Wireless telegraphy was still in its birth-pangs; now, perfect receiving sets are the toys of millions of people.

Electrical appliances have invaded every field of mechanical engineering. The electrical driving of factories has become general. The very heaviest kinds of machinery such as the rolling-mills for rolling boiler-plates and rails are now driven electrically. In our mines electricity is becoming more and more widely used for driving coal-cutters and conveyers, as well as for hauling and winding. In the deposition and refining of metals, electrical processes are all-important. The electric furnace is by far the most efficient for the treatment of metals at high temperatures. The electrical equipment of motor-cars has become an important industry in itself.

The Electricity Supply Act of 1926 brought into existence the Central Electricity Board and the "Grid". Two principal functions were entrusted to the Board:

1. To construct a great system of interlinked main transmission lines extending all over Britain and fed with current from a limited number of large generating stations.
2. To work the system as a commercial enterprise and act as wholesale dealers in electricity for the supply of the distributing undertakings which retail it to the public.

The first part is practically finished. In less than six years, 4000 miles of transmission lines have been provided, with 26,000 steel towers to support them. Good progress has also been made with another part of the Board's preparatory work—the concentration of the generation of electricity in large stations selected for their efficiency and the suitability of their geographical positions. The inter-connecting main transmission lines operate at 132,000 volts capable of carrying quantities of energy up to 50,000 kilowatts.

Every generating station connected to the grid is controlled by a highly accurate master clock, which runs at exactly 50 cycles a second.—A modern electric clock is simply a synchronous motor (a certain type of alternating current motor) running at a strictly uniform and accurate speed, mounted behind a clock dial, and suitably geared to hands of the ordinary type. It is highly probable that the electric clock will, within a few years, drive every other type of clock out of existence, or at least into museums.

Following fast on the Weir report, which showed what economies might be effected by the electrification of our railways, comes the wonderful development made possible by the grid-controlled mercury-vapour arc. A recent improvement in electric traction is due to Dr. **J. J. Drumm**, of University College, Dublin, whose new electric cell promises great things. The cell is an alkaline cell, and the only metals which enter into its construction are stainless steel, nickel, and, at present, nickelled steel. It has a high voltage, and its charging and discharging rates are very high. Already the Drumm storage battery employed on the Great Southern Railway of Ireland has shown such remarkable characteristics as a traction battery that it has revived the hope that some method of storing electrical energy will make the electric locomotive independent of any connexion to a trolley. Battery-driven locomotives are bound to be followed by battery-driven motor-cars. This time is not yet, and we shall probably have to tolerate the evil-smelling petrol fumes for many years to come.

The electrical engineer is doing his work magnificently. Super power stations and the equipment of overhead lines and sub-stations leave nothing to be desired. The increase of output of some of the power houses feeding the grid is remarkable. Power is generated and supplied to the grid at about a halfpenny a unit, but in some districts it is supplied to the consumer at ten times that amount. The great question for all electricity users and would-be users is, *what happens to the 4½d.?*

Any reader who takes up the subject of electricity seriously should remember that the available books are of two kinds, those dealing with electricity as a pure science, and those dealing with the practical applications of electricity. Both are equally important. The visit of an amateur to a power station is apt to be confined to admiration of the machinery *en masse*, but he should have an eye to detail. Even small schoolboys are interested in, for instance, the ingenuity underlying the methods of armature winding. The details of cable construction are equally full of interest; so are switch-boards, and a score of other things. See figs. 129 and 130.

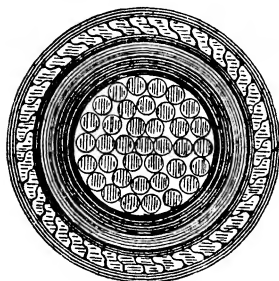

Fig. 129.—Lock-coil steel armoured cable

2. **Turbines.** A turbine is a rotary engine consisting essentially of a shaft carrying a number of vanes or blades; jets of steam directed against these cause the shaft to rotate at a high speed. A modern turbine consists of three distinct parts: (1) a rotor which may be a solid steel drum, or a number of steel discs fixed on a shaft; (2) a cast-iron cylinder inside which the rotor revolves, made in two halves bolted together; (3) a large number of blades of stainless steel in the annular space between the rotor and the cylinder. The blades are arranged in circular rows round the turbine, alternate rows being attached to the rotor and cylinder, respectively, so that the steam, passing along the cylinder from the high pressure end to the low pressure end meets fixed and moving blades alternately. The turbine was the invention of the Hon. Sir Charles Algernon Parsons, O.M. (1854-1931), son of the third Earl of Rosse. The Parsons works are at Newcastle-upon-Tyne.

Parsons "was incomparably the most illustrious and most revolutionary engineer of his time". His invention "was a piece of creative work comparable to that of a great writer or

artist". It was an invention for which the time was ripe. The slow-speed reciprocating engines developed from the original inventions of Newcomen and Watt were ill-adapted for driving the electric generators which were just coming

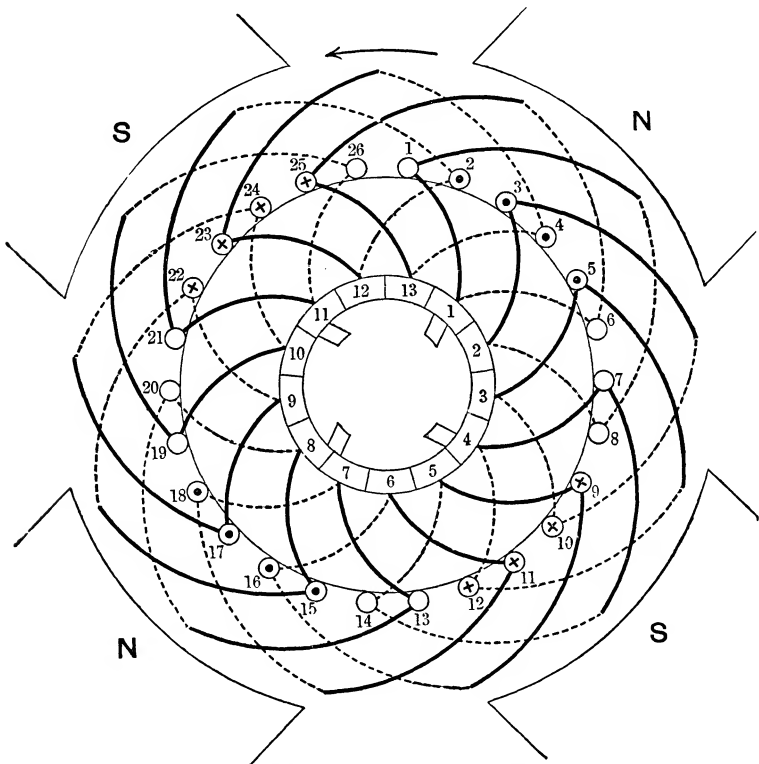

Fig. 130.—Four-pole lap winding

into use when Parsons started work. The historic generator which Parsons made in 1884 ran at the extraordinary speed of 18,000 revolutions a minute; the turbine drove an armature of only $2\frac{5}{8}$ in. diameter, the construction of which displayed as much ingenuity as the turbine itself. Parsons successfully attacked the many problems which arose as the turbine gradually superseded steam-engines in power-houses and

ships, and his invention has certainly halved the cost of generating electricity. And yet many of Parsons' fruitful experiments were done with coffee-tins and rubber tubes!

Turbine plant is now in general use all over the world, and the statistics for Britain are probably typical of those in other countries. In Britain alone, during 1930, "steam turbines provided more than $5\frac{1}{2}$ million kilowatts, while all the other types of heat-engines accounted for less than a quarter of a million".

The turbines at a power-house are not of great interest to a visitor, because the blades are all inside the closed cylinders. An open turbine is, however, an impressive thing.

The great names of **James Watt** (1736-1819), the real inventor of the steam-engine, and **Parsons**, the inventor of the turbine, will go down into history together.

3. Internal Combustion Engines. Even errand-boys with their motor-cycles have become familiar with these. The basic principle is of the simplest and here we need only refer to recent developments.

From the beginning of the war it became obvious that the light mobile high-speed type of internal combustion engines would almost universally apply to transport, aircraft, and (later) tanks, and by the time the war was over, astonishing progress had been made in their development. The annual power-output of the light high-speed type of engine is now at least ten times that of all other types.

In a time so short as to be almost incredible, the internal combustion engine has gained practically undisputed sway over all forms of road transport. It has also opened up the possibility of general aerial transport. It is already ousting the steam-engine from the smaller classes of shipping, though it cannot hope to make much progress with the larger vessels, for the turbine shows to particular advantage as a marine engine. Alone of all forms of transport, the large steamship requires a very high-powered installation, and it is in units of high-power output that steam retains its supremacy.

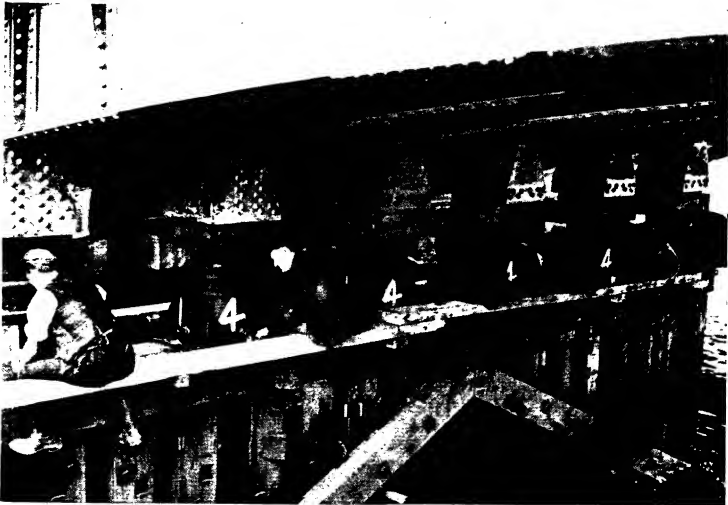
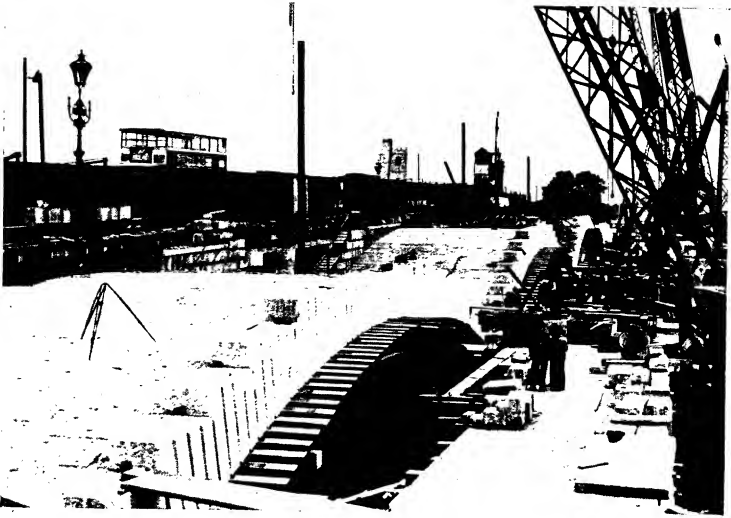

Putney Bridge
By Courtesy of "The Times"

Steam, oil, and electricity are great rivals. All have their enthusiastic supporters, but electricity is almost certain to be the ultimate winner.

4. Modern Structures. In the erection of many types of modern structures, the engineer, the architect, and the builder have to work in close collaboration. Every visitor to a large city in recent years must have seen, in course of erection, the steel skeleton framework of some new large building. These are days, when, in one sense, the foundations of a large building often extend from the bottom to the top, and the ordinary builder finishes off what the engineer has begun. Modern architecture, as exemplified in, for instance, Park Lane and the Euston Road, does not appeal to every eye, but it is the kind of architecture asserting itself in many of the big cities of the world. Those who knew "Old Madrid" half a century ago will be a little startled at the very imposing new University buildings recently erected. Verily all things medieval are rapidly passing away.

The modern bridge is in some ways representative of the engineer's art, whether it be of the cantilever type, the suspension type, the arch type, or any other. Everybody is familiar with at least pictures of our own Forth Bridge and Tower Bridge, of the Victoria Bridge, Montreal, of the Niagara Falls Bridge, and perhaps many others. One of the newest, and in some respects the finest in the world, is the Sydney Harbour Bridge, which has cost over £5,000,000 to build. It has a main span of 1650 feet, and provides a headway for shipping of 170 feet. The total length of the structure including the approaches is 3816 feet. The huge abutment towers at each end, faced with granite masonry, are particularly imposing features.

We can afford space for only one detail of bridge construction. On 13th September, 1932, *The Times* reported that "yesterday the arches were swung at Putney Bridge". What does this mean? It means that the five spans of granite blocks across the river were no longer resting on the steel

girders which had hitherto supported them, but were supporting themselves. Photographs of the bridge are shown in Plate 28.

The new bridge of five arches is constructed in granite. During the process of building the granite blocks were placed in position on steel girders which carried the weight of the arches. At about a quarter of the distance from the main piers along each arch were five supports on which the girders rested. Those supports consisted of wooden piles driven deep into the river bed, and on the top of each one there was a cylindrical water-tight iron box. The box was filled with specially prepared dry sand in which was embedded a plunger on which the girder actually rested. On the lower part of each box were four "nipples" firmly closed with iron bolts. On the day named, the bolts were removed and the sand taken out of the iron boxes. The girders were thus gradually lowered by one inch and the granite settled into position. Gradualness in the operation was essential, and the sand was removed from each nipple in small tins about the size of a half-pint measure. Sixty men were employed at the 60 boxes, one man at each box. A whistle signal enabled the men to set to work simultaneously at 10 minute intervals, every man then to remove his half-pint of sand. During the whole time a large number of engineers were engaged in taking measurements of stresses and strains at various points on the bridge. The whole operation was one of the greatest delicacy. The interested reader might well ask himself what scheme *he* would have devised for removing the under-structure, supporting, as it did, the whole weight of the new granite bridge. No one will deny that the modern engineer's work demands the highest skill and the greatest resource.

The engineer's principal medium of construction is steel, and the present generation is apt to forget that it is less than a century ago (it was in 1856) that **Bessemer** first described his process of making the new material we now call mild steel, by blowing air through melted pig-iron.

5. **Photography.** During the last twenty years photography has made notable advances and it has been of the greatest use in observational scientific work. The convenience, rapidity, and exactness of photographic methods have established photography firmly as a necessary aid to research in, for example, astronomy, surveying, aeronautical observation, microscopy, metallurgy, engineering, and physics. Exact methods of technique have been developed by experts in these and other spheres of research, but it must be remembered that a technique developed for one subject is by no means necessarily suitable for another. Plate 29 shows four examples of photomicrography. Plate 30 is a photograph of a flying bullet: note the two conical wave-fronts of air, one at the head and the other at the base.

Rapid headway is also being made in the technique of colour photography.

Infra-red Photography. A bar of iron heated just to redness and taken into a dark room may be photographed in the usual way, the photographic plate being sensitive to the red rays. It is also possible to photograph the bar just before it becomes visibly red, provided that the photographic material composing the film is sensitive enough. It is over half a century since Sir **William Abney**, the first man to place photography on a scientific basis, photographed, in a dark room, a kettle filled with boiling water, the only source of radiation being the kettle itself. In his Traill-Taylor memorial lecture in 1900, Professor **R. W. Wood** dealt at great length with photography by invisible radiations from the infra-red and from the ultra-violet as well. Both Abney's and Wood's photographs were taken in the usual way on plates sensitized for infra-red.

More recent developments in infra-red photography have been brought about by means of special sensitizing dyes added to the emulsions. These add new spectrum regions of sensitivity to that region lying between 2200 and 5800 Å which is possessed by almost all photographic emulsions

used for making negatives. Certain dyes, which have been introduced since 1930, make sensitivity possible between 6800 Å. and 12,000 Å.

The main goal sought by earlier infra-red workers was in the field of spectrography, but the field has now become greatly extended. There is, for instance, a very great difference between landscape photographs taken as infra-red plates and those taken on ordinary materials. The infra-red pictures are far clearer, and bring out details that are absolutely invisible to the photographer when using his camera.

An important application of infra-red photography is the penetration of haze. The obscuring effect of mist and haze is largely due to light scattered from the suspended particles. Since the scattered light is often bluish in colour and is very deficient in infra-red, it has very little influence on an infra-red plate, provided the latter is shielded from the blue by means of a filter. Some of the problems connected with haze penetration which are now being attacked are aerial surveying and the navigation of ships in fogs. In future wars photographs of the enemy's lines may be taken as readily during a dense fog as during sunshine. In its own way, the camera is now a far more efficient optical instrument than is the human eye. When, as in a thick mist, the human eye is almost blind, the camera now is virtually as efficient as ever.

6. Television. The Televisor was invented by **John L. Baird** (*b.* 1888) of Helensburgh, Scotland. It was the first practical television apparatus for the instantaneous transmission of scenes or objects over a distance by wire or wireless. Experiments with infra-red rays or "black light" also led Baird to design the "noctovisor", which makes possible visual impressions to be recorded in total darkness.

At the 1933 meeting of the British Association at Leicester, Major **Archibald Church** outlined recent advances in television, pointing out that it was less than 10 years since Baird first obtained televised images of simple stationary

objects. Real television, or the instantaneous reception of optical images of moving objects, the images of which have been transmitted by means of a variable electric current, dates only from 1926.

In Baird's original apparatus, the subject to be televised was bathed in light from powerful electric lamps. Between the illuminated subject and the photoelectric cells there was a scanning device, consisting of a disc, in which holes were punched at regular intervals in a spiral, revolving five times a second. A rotating optical element thus scanned the subject strip by strip, each strip being presented in sequence to a sensitive light element. The varying current transmitted in this way by the photo-electric cells modified the light in a neon lamp at the receiving end, and this varying single light-source was scanned in turn by a "Nip kow" disc in synchronism with the disc at the transmitting end. The reconstituted image was seen by looking at the neon lamp through the scanning disc.

Baird made a notable advance upon this apparatus by his invention of the light-spot method of scanning. The subject to be televised was traversed only by a spot of light, and a sensitive light cell was so placed that light reflected back from the spot of light traversing the subject fell on the cell. By 1928 Baird had televised images across the Atlantic, and in 1930 the Baird Company were giving demonstrations at the London Coliseum.

Meanwhile, an alternative means for the transmission and reception of television images was gradually being worked out, cathode ray oscillograph tubes being used. The development of this device is largely due to the youthful German inventor **Baron von Ardenne**. Researches into the possibilities of cathode-ray television engaged the attention of workers in America, France, and Germany, but the Baird Company made further developments in the older mechanical methods, and gave important demonstrations in London in 1932.

Amongst other developments of 1932 were (1) the in-

stallation of a complete transmission equipment at Rome by a German company; (2) the television and the projection on a London cinema screen of the Derby at the time it was being run; (3) the marketing by the Baird company of an improved home television receiver.

During 1933, American, Canadian, French, German, and English companies have been actively forging ahead, and the technical developments which are now being rapidly made are promising of great television advances in the early future.

7. **The Photo-Electric Cell.** We have already referred to photo-electricity and it may be remembered that

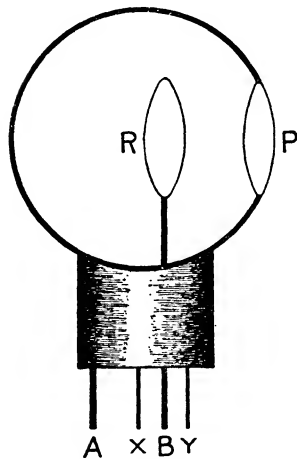

Fig. 131.—Photo-electric cell

the photo-electric effect is the emission of electrons from a metallic surface when light falls on it. The modern photo-electric cell is an invention of the last few years. It is a device in which the action of light produces an electric current, or changes the magnitude of an electric current. In general appearance it is not unlike a wireless valve, even to the four pins A, B, X, Y, in the base, by which the cell may be held in an ordinary valve holder, though two of the four, X, Y, are dummies (fig. 131). The glass cell may be spherical, coated on the inside with a deposit of potassium

distilled into the cell while the latter is highly evacuated, but a small circular area P of the glass is left quite clear of the metal, and is rather suggestive of the pupil of an eye. Hence the term "electric eye". Before the cell is sealed off, a trace of the inert gas neon is introduced. R is a thin metal ring connected to the pin B and is kept at about $+150$ volts relative to the potassium, so that the electrons flow from the potassium to the ring. The potassium deposit is connected by a wire

to the pin A. Potassium is generally used because the photo-electric effect is greatest with this in ordinary light. Electrons are emitted immediately light falls on the potassium, and their speed depends only on the wave-length of the light. The electric current so generated is very minute, but it can be amplified by means of an ordinary wireless valve, and the amplified current can be made to operate a relay that acts as a switch in an electrical circuit. The photo-electric cell when coupled up in this way behaves like an automatic eye.

Photo-electric cells are now used for scores of useful purposes. They are used to switch on the lamps in large buildings whenever the intensity of the daylight falls below a certain level. They are used as burglar alarms, operating the bells when a beam of light falling in the cell is interrupted; readers may remember that when, at the Royal Academy Persian exhibition, a visitor stretched out a hand towards the Shah's jewels, bells rang all over the building. As the cells are sensitive to the changes in the colour of the light falling on them, they are used for such purposes as rejecting discoloured beans *en route* for bottling, or for rejecting proprietary articles that have accidentally shed their labelled wrappers, or for the automatic opening of doors when a person approaches. It is almost uncanny to watch the rejection of discoloured beans. The beans pass along a conveyer belt at the rate of 90 *a second*. As they do so each bean is inspected by the Electric Eye, and if its colour falls short of a pre-determined standard, a jet of compressed air kicks the bad bean aside. Think of the speed of the process! and the process never fails. Boys who visited the special exhibition at the Science Museum at South Kensington in the Spring of 1933 talked excitedly for days afterwards of the wonders of the Photo-electric cell.

8. Inventions. To catalogue the inventions of the twentieth century would be to mention tens of thousands of items. The American inventor **Thomas Alva Edison**

(1847-1931) himself took out over 1000 patents. The reader should distinguish between the developed inventions which were the evolutionary results of the efforts of many workers, and those inventions which were due, in the main, to the inspiration of the genius of individuals. In the former class we may include modern ships, modern bridges, modern power stations, aeroplanes, airships (when the inner history of the British airship is written, it will be found that the final catastrophe was not the fault of British engineers), water-power electric installations (especially in Norway, Switzerland and America), artificial silk, and many more. In the latter class we may include the Thermionic valve (Sir John Ambrose Fleming, *b.* 1849), the modern telephone (Alexander Graham Bell, 1847-1922), "wireless" (the Marchese Marconi, *b.* 1874), phototherapy (Niels Ryberg Finsen, 1860-1904); also thermit welding, the electric furnace and electric welding, the improved gyro-compass, the ultra-microscope; and so on almost indefinitely.

Successful research workers and inventors have by no means always worked with an elaborate equipment. When some American visitors called on Wollaston (1766-1828) and asked to see his optical laboratory, he rang the bell for the butler. On the butler appearing Wollaston said, "John, bring in the tray"!

Where the Work is Done

It is safe to say that keen research workers are busy in every great University of the world, and it would be difficult to place in order of merit those of the four leading countries—Britain, America, France, and Germany. Famous men of science have not by any means been the exclusive production of any one country, though we may rightly take a legitimate pride in our own. We may certainly claim to be *inter pares* even if not *primus inter pares*, and in any case Newton stands alone. But most of our leading University workers are, first of all, teachers, and to this occupation they usually have to

devote so much of their time that research is apt to be a very broken form of occupation. On the other hand, many of our great industrial organizations are now employing full-time research workers, with the special object of advancing the interests of the particular industry. For the most part, University research is directed to pure science, though not exclusively so; and industrial research is directed to technical improvements and efficiency. Occasionally a leisured man will devote his life to research. Lastly, all the greater governments engage in certain lines of research, but not always openly. For instance our own army, navy, and aircraft research workers keep their doors carefully closed.

We can afford space to touch upon only a few of the leading centres of scientific development.

1. The Department of Scientific and Industrial Research. A special Committee of the Privy Council, for Scientific and Industrial Research, was appointed by order in Council in 1915. The Committee consists of the holders for the time being of certain ministerial offices, and they have a permanent advisory council of distinguished men of science. There are several departments:

- (i) *Building Research*, with a research station near Watford.
- (ii) *Chemical Research*, with laboratories at Teddington.
- (iii) *Food Research*, with stations at Maidstone, Cambridge, and Aberdeen.
- (iv) *Forest Products Research*, with laboratory at Princes Risborough.
- (v) *Fuel Research*, with station at East Greenwich.
- (vi) *Radio Research*, with station at Slough.
- (vii) *Water Pollution Research*.

Outside these departments much special work has been done, a great deal of it at the National Physical Laboratory. Some of the work has been done in conjunction with the Universities, some at Woolwich, some in association with the Geological Survey and Museum of Practical Geology, some at the Royal

Aircraft Establishment, Farnborough, and some at other places. The Report for the year 1931-2 covers a small multitude of activities, and is a valuable record of what was done to make the British citizen better fed, better clothed, and better housed. It shows clearly what scientific discovery is doing for the betterment of the conditions of human existence.

The official Report also states that there are no less than 27 outside Research Associations attached to the Department. That industry generally now fully recognizes the importance of Research is shown in the support given by a large number of firms to these Associations. In short, British industry seems now, despite its many difficulties, to be very much awake.

2. **The National Physical Laboratory.** This Laboratory, situated at Teddington, was founded in 1900 at Bushy House, an old Royal residence granted by the Crown for the purpose. The original accommodation comprised the ground floor and basement of the house, and some outbuildings. The Laboratory now includes 12 large and numerous small buildings and in the 30 years the Staff has grown from under 30 to over 600. Until 1918 the Laboratory was controlled by the Royal Society, but it then became part of the Department of Scientific and Industrial Research. It has had two distinguished Directors, **Sir Richard Glazebrook**, who retired in 1919, and **Sir Joseph Petavel**, the present Director.

The purposes for which the Laboratory was founded were (1) to carry out research, including, in particular, research required for the accurate determination of physical constants; (2) to establish and maintain precise standards of measurement; and (3) to make tests of instruments and materials. It also undertakes investigations of special problems on behalf of Government departments and of the Research Associations representative of various industries. In short, the Research work of the Laboratory covers a wide field, and includes all branches of physics, electricity and magnetism, wireless

work, engineering, metallurgy, aeronautics, and ship design in relation to form and propulsion.

There are eight main departments: Physics, Electricity, Metrology, Engineering, Metallurgy, Aerodynamics, the William Froude National Tank, and Administration.

A few references to the work in progress must suffice:

(1.) 50,000 clinical thermometers are tested every month in the *Heat Division* of the Physics Department.

(2.) The *Optics Division* investigates problems connected with the design of lens systems, and carries out tests of all classes of optical instruments. The Hilger Universal Lens Interferometer which is used is remarkable as an accurate measuring instrument.

(3.) The maintenance of electrical standards occupies a large part of the time of the *Electrical Standards Division*. Comparisons of electrical standards can be made with an accuracy of 1 or 2 parts in a million.

(4.) The plant in the *Laboratory for high voltage work* consists of three similar transformers, each capable of giving 375,000 volts when supplied with a power of 1000 volts. They can be used in series, giving over 1,000,000 volts (see Plate 26).

(5.) The *Photometry Division* is responsible for the maintenance of the standards of illumination of the country. It also undertakes the determination of the candle power of any source of light, e.g., gas lamps and motor-car headlights, life tests of glow lamps, &c.

(6.) The *Metrology Division* tested, during the war, over a million engineers' gauges. The Division possesses a ruling engine for the purpose of ruling diffraction gratings, the normal spacing of which is 14,400 lines per inch, though twice this number is possible.

(7.) In the *Aerodynamics Department* there is a first-rate equipment for wind-tunnel experiments. It consists of (a), a duplex tunnel 14 ft. \times 7 ft. in section; (b), three tunnels 7 ft. square; (c), two, 4 ft. square; (d), two, 1 ft. square; (e), a whirling arm; (f), a new compressed-air

tunnel. The last-mentioned is unique, for there is only one other like it in the world and that (in the United States) is much smaller. A few remarks about it will be apposite.

The compressed-air tunnel is a development of the older wind tunnels. The significant thing about it is that it is not subject to the important variations between model and full-scale results which were frequently encountered in the use of the older tunnels. The theoretical basis is to be found in Rayleigh's law of dynamical similarity.

So large are the component parts of the tunnel that the building which houses the complete structure had to be built round it. In appearance it is something like a huge ship's boiler. It is 50 ft. long, with an internal diameter of 17 ft. It has no longitudinal joints and it can withstand an internal pressure of 350 lb. a square inch. The steel shell is $2\frac{1}{2}$ inches thick, and the whole weighs 310 tons. The four sections composing the cylinder were each rolled from a single ingot and were jointed together by circumferential straps fitting over flanges on ends of the rings. The cylinder is completed by hemispherical steel castings at the ends. The whole tunnel is of enormous strength; when it is charged with compressed air the pressure on each end casting is 5000 tons. Air is compressed into the shell by three 400 horse-power compressors in an adjoining room, and it is circulated by a metal air screw driven by a 400 horse-power motor. A wind speed of 60 miles an hour can be attained at 25 atmospheres pressure, and this wind, blowing upon a model of one-tenth scale will simulate precisely the conditions of the full-scale machine flying at 150 miles an hour.

Great things are expected from tests in this new tunnel, but the older, duplex tunnel has proved to be of the greatest value during the last six years. It has been used for tests of high speed of very large machines in various stages of their development. Models of the British machines which competed successfully for the Schneider Trophy were tested here, and the performances predicted from the wind tunnel experiments were in close agreement with those eventually

obtained on these racing seaplanes. All the constituent parts of an aeroplane—wings, body, struts, wires, ailerons, tail, rudders and propellers—are tested in the Aerodynamics Department.

(8). *The William Froude Laboratory.* William Froude constructed at Torquay in 1870 a tank for testing the models of ships, and he worked out the rules which subsist between the performance of a model and that of a ship of like form. Since that time, tanks have been installed by various shipping interests in both Europe and America; in England the chief of these is at the National Physical Laboratory, and it has been given the special name, "The William Froude Laboratory". The Laboratory consists of three sections: (1) The Alfred Yarrow Tank, opened in 1911; (2) The New Tank, just completed; (3) The Propeller Tunnel, also recently completed. Our remarks must be confined to the New Tank.

The New Tank is much more than a Tank in the ordinary sense; it is a ferro-concrete water basin 678 ft. long and 20 ft. wide at the water surface, except at the eastern end where the last 19 ft. consists of a small dock. The depth of water is 9 ft. at the eastern end for a distance of 446 ft. The bottom of the Tank then rises at a uniform gradient for a distance of 36 ft. to the shallow western end, where the depth of water is 2 ft. for the remaining length of the Tank.

The travelling carriage is a rectangular steel framework, rather less than 5 tons in weight, running on rails fixed to the walls of the Tank. In the central portion of the carriage is an open well, within which the model testing apparatus is erected. The gear controlling the speed of the carriage is operated by hand and is arranged to give steady speeds from 2 to 30 ft. per second.

The tank enables shipbuilders to obtain the best design both for the hull and for the superstructures of high speed ships. To determine the best shape of the hull, ships' models made of wax are towed down the canal and the resistance of their passage through the water is measured. The lines of the models are varied and the best results obtained. Data

obtained from the completed ship usually agree with that predicted from the small-scale models, within two per cent. The superstructure resistance is measured by *inverting* the models; the resistance in the water being known, that in the air can be calculated.

The water-way is useful not only for sea-going vessels but also for river barges, for which an increase in towing efficiency of 30 per cent has been obtained.

3. **The Cavendish Laboratory, Cambridge.** In the early seventies a strong movement grew up in Cambridge to improve the teaching of physical science, and the then Chancellor, the Duke of Devonshire, provided the money for building and equipping a laboratory. A well-designed, and for those times spacious, laboratory was erected and opened in 1874, and it was named the Cavendish Laboratory in honour of that eccentric experimental genius, **Henry Cavendish**, grandson of a former Duke of Devonshire. The fame of the Laboratory as a great centre of teaching and research has grown with the passing years, and all four of the Cavendish Professors have been world-famous men of science:

1. James Clerk Maxwell, 1874-79.
2. Lord Rayleigh, O.M. 1879-84.
3. Sir J. J. Thomson, O.M. 1884-1919.
4. Lord Rutherford, O.M. 1919-

Not a few of the leading physicists of Europe and America are grateful to the Cavendish Laboratory for part of their early training.

Some of Lord **Rutherford's** present coadjutors are doing notable work. We have already mentioned Dr. **Chadwick**, who bombarded the metal beryllium with α particles and caused the expulsion of uncharged particles of mass 1 which have been named neutrons; and Dr. **Cockroft** and Dr. **Walton**, who have effected the transformation of lithium. Lord Rutherford's old students are more famous for getting things *done*, than for indulging in speculative hypotheses.

And yet the material equipment for such a world-famous laboratory is of the most modest character. On the other hand, it has always been remarkably well equipped with brains.

The following are among the more important researches carried out since 1919:

1. Isotopes and the measurements of the masses of atoms.
2. Artificial Transmutation by α Particles.
3. Production of Intense Magnetic Fields.
4. Investigations of the β and γ ray spectrum of the Radioactive bodies.
5. Discovery of the Neutron.
6. Application of High Voltages to Discharge Tubes and Artificial Transmutation by Protons.
7. Discovery of the Positive Electron.

Besides the work coming under these main heads, there have been researches on many other different subjects, for instance, the properties of positive ions, the collisions of electrons and atoms, and the reflection of wireless waves from the Heaviside layer.

4. The Mond Laboratory. This Laboratory, which has been presented to the University of Cambridge by the Royal Society, stands in the courtyard of the Cavendish Laboratory. It was opened in 1933. A visitor at the formal opening thus described his impressions:

(i) "A room containing a generator capable of sending out, in the hundredth part of a second, a current as powerful as that supplied by the gigantic power station at Battersea.

(ii) "Apparatus which produces a temperature so low that the atoms composing the material under investigation slow down their perpetual random motion until they are almost completely at rest.

(iii) "Experiments of the most extreme delicacy, which must all be carried out in less than the fiftieth part of a second in order that the apparatus may not become red hot."

The Laboratory is under the directorship of Professor

Peter Kapitza, who was born in Russia 40 years ago.

The twofold purpose of the laboratory is to provide facilities for investigating the properties of matter in the highest magnetic fields that have yet been reached; and to provide for the carrying out of experiments at the lowest obtainable temperatures.

In magnetic fields and at very low temperatures, matter exhibits unsuspected properties, and as far back as ten years ago it was thought desirable to attempt to produce magnetic fields of much greater power than could be obtained by electromagnets. Professor Kapitza showed that it was possible to obtain such fields by sending a very strong current, of the order of 50,000 amperes, through a suitably constructed coil for a very short interval, though in order to reap the full advantage of the method, it was necessary to study the magnetic effects at the lowest possible temperatures where the effects are not complicated by the heat motions of the atoms. Hitherto liquid hydrogen has been used for producing very low temperatures, but a helium liquefier is being installed, and a temperature approaching absolute zero will then be obtainable. The coils for the electric current have to be of very great strength to withstand the enormous disrupting forces involved in the experiments.

5. The Imperial College of Science and Technology.

In the quadrangular area between Kensington Road and Cromwell Road, Queen's Gate and Exhibition Road, at South Kensington, stands range after range of buildings, with the Albert Hall, now relatively a midget, to the north, and the Natural History Museum to the south. There are also other buildings to the east of Exhibition Road. Several of the buildings are museums; others include the administration headquarters of the University of London and the Imperial Institute, and others the Royal Colleges of Art, Music and Organists. The remainder constitute 'The Imperial College of Science and Technology, the leading "school" of the University of London. The College was established by Royal



Four Examples of Photomicrography

1. Face of *Dinopis* Spider ♀ × 7. Aldis 3-in. photomicrographic lens $f/8$; no microscope and no eyepiece; 25-c.p. silvered metallic-filament lamp; Wellington anti-screen plate; 3 min. exposure.

2. Hairs on Wing of House-fly × 243. $\frac{3}{8}$ in. Swift panaplanatic objective; No. 4 eyepiece; Nernst $\frac{1}{4}$ amp. lamp; transmitted light; blue glass filter; Imperial special rapid backed plate; 12 sec. exposure.

3. Group of Diatoms (Hungary) × 40. $\frac{3}{8}$ in. Swift panaplanatic objective; No. 2 eyepiece; Nernst $\frac{1}{4}$ amp. lamp; transmitted light; green filter; Imperial special rapid backed plate; 12 sec. exposure.

4. Hairs of Larva of *Dermestes* Beetle × 160. Reichert 4 cm. objective; No. 1 eyepiece; 100 c.p. Pointolite lamp; Wellington Anti-screen backed plate; 25 sec. exposure.

Charter in 1907 and includes (1) the Royal College of Science (2) The Royal School of Mines, (3) The City and Guilds (Engineering) College.

The College is organized into a number of departments:

- (i) Aeronautics (including Aerodynamics).
- (ii) Biology (including Botany, Zoology, Biochemistry, Bacteriology, &c.).
- (iii) Chemical Technology (including Chemical Engineering, &c.).
- (iv) Chemistry (Inorganic, Organic, Physical, &c.).
- (v) Mechanical Engineering.
- (vi) Civil Engineering.
- (vii) Electrical Engineering.
- (viii) Geology (including Mining Geology and Oil Technology).
- (ix) Mathematics and Mechanics.
- (x) Metallurgy.
- (xi) Mining (including Mining Surveying).
- (xii) Physics (including Astrophysics, Technical Optics, &c.).

The various buildings are remarkable for the completeness of their accommodation and equipment. A very few details must suffice for mention here. In the Chemistry Department there is ample accommodation for some hundreds of students to be doing practical work at the same time; the physics department includes 6 large laboratories, 3 lecture theatres, and about 40 other rooms; the four-storied Chemical Technology building is specially equipped for advanced study and research in fuel analysis, ignition phenomena and explosives, pyrometry, refractory materials, industrial catalysis, blast furnace reactions, and much more; in the Explosive Research laboratories, special high speed cameras have been installed for the rapid photography of explosion flames; the main engineering laboratories and workshops on the ground floor of the City and Guilds College cover an area of over $1\frac{1}{4}$ acres; the Engineering workshops contain 40 machines representing the most recent products of British and foreign manufacture; the equipment of the Electrical Power Laboratories includes an artificial transmission system electrically

equivalent to 100 miles at 132,000 volts. And so generally. It is doubtful if either wealthy America or Scientific Germany has an Institution more completely equipped or more efficiently staffed for teaching pure and applied science on the Imperial College scale. The Staff includes more than 20 Fellows of the Royal Society, and many scores of others holding the highest academic distinctions their universities could give them. Under the Rector, Mr. H. T. Tizard, the College is a veritable triumph of organization, and its annual output of work, whether judged by its scientific and industrial research or by the number of higher degrees conferred by the University, is remarkable.

6. The Henry Herbert Wills Physical Laboratory, Bristol. The late Henry Herbert Wills decided to provide funds for the erection of a new Laboratory through which the University of Bristol might become an important centre of Physical research and teaching, and to this end he made two gifts, each of £100,000, in the years 1919 and 1920. As designed, the building is the first instalment of an extensive scheme of University buildings to crown the top of a hill overlooking the city. The new Laboratory is L-shaped, the short arm of the L forming the Theatre wing, and the longer arm consisting of Teaching Laboratories, Research Rooms, &c. The junction of the two arms is surmounted by a tower 64 ft. square. There are four floors, and some 80 rooms in all. The supply of electric current for the use of students in the various rooms is in accordance with a particularly well-thought out scheme. For the supply of compressed air and of vacuum, the unit system has been preferred to that of general distribution, and any worker who requires either of them thus has it under his complete control.

In addition to the building, a number of research fellowships and studentships have been founded through a bequest by the donor. Moreover, a substantial research endowment fund has been created through a gift from the Rockefeller Foundation.

Though the direction of the laboratory is in the hands of the Professor of Experimental Physics (Professor A. M. Tyndall), a chair in Theoretical Physics has also been endowed by a brother of the donor, and Mr. N. F. Mott has been appointed to it. Professor Lennard-Jones has just passed on to Cambridge. This combination of both Experimental and Theoretical Physics under one organization is an example of far-sighted policy in view of the inter-relation of the two branches in recent developments.

The laboratory, though only opened near the end of 1927, is rapidly growing in reputation and is now attracting workers from different parts of the world.

Watch Bristol.

We have no space to refer to Manchester and Liverpool, Leeds and Sheffield, Birmingham and Newcastle, but this certainly does not mean that the value of the work they are all doing is underestimated. Far from it.

Lastly there is Oxford.—The research worker who invents an hypothesis would do well, before announcing it to the world, to send it up to Oxford for examination. That way lies safety. Watch Oxford's work in biology.

7. **Work in other Countries.** On the continent there are at least half a dozen Universities in Germany, in France, and in Italy, regularly turning out work of a high order. The smaller countries, too, are all doing their share. The University of Leiden in Holland, for instance, has for centuries been in the very front rank. Then there is Russia, which, despite blood and tears, is reported to be doing memorable work. As for America, its success in scientific research during the present century has been impressive indeed. Those who are opposed to what is sometimes called capitalism must admit that, but for the personal wealth accumulated by such generous individual men as Rockefeller and Carnegie, America would not have reached her present position in the world of science by a very long way. In this

country, universities and other research institutions have to depend, in the main, on grants from the Government and from Local Authorities, and everybody knows that official purses are hard to open.

BOOKS FOR REFERENCE:

1. *Modern Physics*, H. A. Wilson.
2. *Electricity and its Practical Applications*, Magnus Maclean.
3. *The High Speed Internal Combustion Engine*, H. R. Ricardo.
4. *Steel and its Practical Applications*, W. Barr and A. K. Honeyman.
5. *Photography as a Scientific Implement*, A. E. Conrady and others.
6. *Colour Photography*, F. R. Newens.
7. *The Technique of Ultra-Violet Radiology*, D. T. Morris.
8. *Any standard works published since 1920 on Chemistry and Physics.*
9. *Discoveries and Inventions of the 20th Century*, E. Cressy.
10. *National Physical Laboratory, various publications* (S. O.).
11. *Department of Scientific and Industrial Research Report*, 1931-2.
12. *University Calendars, Reports, &c.*
13. *The Steam Engine and other Heat Engines*, Sir J. A. Ewing.
14. *Electrical Machine Design*. Alexander Gray.
15. *General Lectures on Electrical Engineering*. C. P. Steinmetz.
16. *Strength of Materials*. A. Morley.
17. *Theory of Structures*. A. Morley.
18. *Technische Mechanik*. Föppl. (5 vols.).

CHAPTER XL

Astronomy and Cosmogony

Astronomy is that branch of science concerned with the solar and stellar systems and all phenomena connected with them. The observational astronomer surveys and explores the universe; he describes and classifies the various types of objects of which it is constituted, and he attempts to discover the laws underlying their observed arrangement and behaviour. His principal instruments are the telescope (of various types and mounted in various ways), the spectroscope, and the camera. The astronomer has to be a competent mathematician, for the theoretical side of his subject is largely a branch of higher mathematics; he also has to be a trained physicist and to have more than a nodding acquaintance with chemistry. During the past thirty years atomic physics, associated with astrophysics, has led to a large number of fruitful astronomical discoveries. In short, our leading astronomers are universally recognized as among the most severely trained and the most highly skilful of men of science.

Cosmogony is that branch of science which makes an attempt to deal with the origin of the universe. "Cosmogony studies the changes which the play of natural forces must inevitably produce in the objects discovered by the astronomer; it tries to peer back into their past and to foresee their future, guided always by the principle that the laws of nature have moulded the present out of the past and will in the same way mould the future out of the present."

Such great advances have been made in *astronomy*

during recent years that the known facts are extraordinarily impressive. It is however necessary always to speak with caution when referring to astronomical "facts", for almost all the evidence is necessarily inferential. How little we really know, for instance, of even our nearest neighbour, the moon; we cannot yet visit her and check the evidence with which our telescopes have furnished us. When we come to the region of *cosmogony* we are necessarily in a region which is full of doubt and is necessarily of a highly speculative character. Hypothesis is built on hypothesis; imagination is sometimes allowed to run riot; and not infrequently the most fantastic nonsense is served up with an apparent seriousness of purpose which is likely to deceive all but the very elect. If the cosmogonist happens to be an astronomer of recognized standing, as is sometimes the case, his speculations may be received as if they were of the nature of a fifth gospel. But the more cautious type of cosmogonist considers his task finished when he has described and interpreted to the best of his ability the observed sequence of astronomical changes which seem to be invariable and which seem to constitute the history of the material universe. Perhaps the easiest of his problems is the interpretation of the observed shapes of astronomical bodies and their formations. Here the effects of rotation have proved to be of primary importance. The degree of orange-shaped flattening is such as would be produced by relatively slow rotation about an axis, and there is little room for doubt that this is the actual cause of the flattening. Mathematical investigation shows that such shape is assumed by all bodies in slow rotation, no matter what their internal constituents and arrangements may be. It is with such problems as this that the cosmogonist is on fairly safe ground.

The Solar System

Even down to the time of Newton, astronomers concerned themselves almost exclusively with the solar system—the sun and the planets. The stars were little more than points of

light, of varying degrees of brightness, irregularly arranged but fixed in a vast dome. Sometimes flaming meteors rushed across the sky, and went out. Occasionally a comet appeared, stayed a little while, then disappeared. The milky way was recognized as an irregular belt of light extending right round the sky, and when the telescope was invented that belt of light seemed to resolve itself into a multitude of stars. And that was nearly all.

Thanks mainly to the spectroscope, we now know a great deal about the sun. Plate 31 shows the solar spectrum made with the 13-foot spectroheliograph at the Mount Wilson observatory, extending over the range, $\lambda\lambda$ 3900–6900. The band is broken up into four parts, for convenience of printing. (There is a little overlapping.) Every one of the multitude of lines has its own story to tell about the sun. Think of the work of interpretation! and yet this is the every-day work of trained experts.

The modern astronomer is giving much more attention to the stellar system than to the solar system, and in this chapter our limited space compels us to follow his lead. But in view of the great differences of magnitude between the two systems, the reader would do well to try to form a clear conception of the sizes and distances of the solar system in order that he may have a convenient scale of reference when he considers the stellar system. Astronomical sizes and distances are so vast that it requires a very considerable amount of mental effort to grasp the real significance of the figures when they are given.

The diameter of the earth is 8000 miles and that of the sun is 100 times as great, viz., 800,000 miles. The volume of the sun is thus $(100)^3$ or 1,000,000 times that of the earth.

The distance of the moon from the earth is 240,000 miles, and that of the sun from the earth is 93,000,000 miles, that is, the sun is about 400 times as far away as is the moon. Since light travels 186,000 miles a second it takes a little over 1 second to come from the moon, and about $8\frac{1}{2}$ minutes to come from the sun. Neptune, the outermost planet of the

system (ignoring Pluto) is about 3,000,000,000 miles distant, so that light from it takes 4 or 5 hours to reach us.

Thus if the sun is represented by a circle the size of a halfpenny, the earth's orbit will be represented by a circle 15 or 16 feet in diameter (about the area of an ordinary living room), and Neptune's (practically the boundary of the solar system) by a circle 500 feet in diameter (an area rather larger than a four-acre field). In other words, a halfpenny in the middle of a four-acre field represents to scale the sun in the midst of his own domains. At first sight the solar system seems large: a central sun nearly a million miles in diameter, with planets revolving around him, all within an outer circle 3,000,000,000 miles radius, i.e. a circle enclosing an area of 30 trillion square miles. But although compared with stellar and nebular distances these solar distances are utterly insignificant, they may be usefully kept in mind for purposes of future comparison. For most stellar measurement purposes, we make most use of the *earth's orbit*, about 93,000,000 miles in radius. A suitable scale picture to bear in mind is a circle about the area of an ordinary living room with a central ball one inch in diameter to represent the sun, and a small grain of mustard seed on the circumference to represent the earth.

More about Dimensions and Distances

The non-mathematical reader may once more be reminded of the useful "index" notation in arithmetic.

1	followed by 3 ciphers is called a thousand, and may be written	10^3
1	" 6 " " million " "	10^6
1	" 12 " " billion " "	10^{12}
1	" 18 " " trillion " "	10^{18}
1	" 24 " " quadrillion " "	10^{24}

and so on. Intermediate numbers are read in this way:

$$100,000,000,000,000 = 100 \times 10^{12} = 100 \text{ billion.}$$

$$10,000,000,000,000,000,000 =$$

$$10,000 \times 10^{18} = 10,000 \text{ trillion.}$$

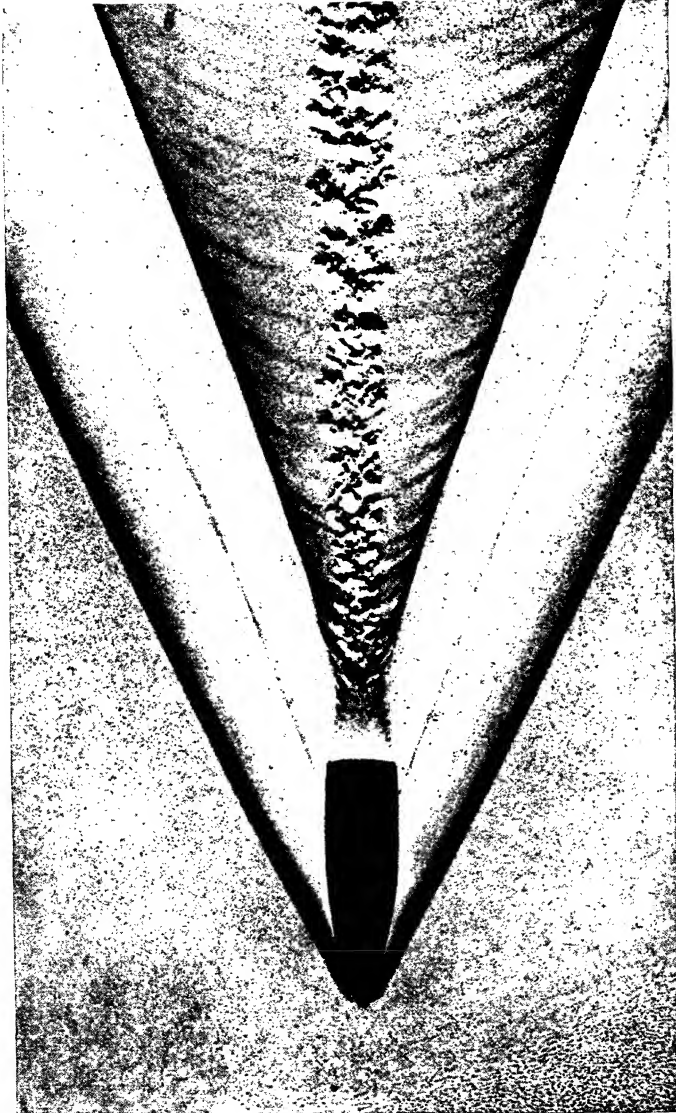

Photograph of an 8-mm. Bullet moving with Velocity of about 880 M./S.
C. Cranz (*Berlin*, 1917)

An index preceded by a minus sign indicates that the number is the denominator of a fraction, thus:

$$10^{-3} = \frac{1}{10^3} = \frac{1}{1000} = \text{one thousandth.}$$

$$10^{-14} = \frac{1}{10^{14}} = \frac{1}{100,000,000,000,000} = \frac{1}{100 \times 10^{12}} \\ = \text{one hundred billionth,}$$

and so on. The ciphers (noughts) are usually marked off in groups of threes from the right to facilitate reading.

Our system of notation differs from that of the United States whose billion is 10^9 (i.e., a thousand million), trillion is 10^{12} (i.e. a thousand American billion), and so on. To avoid confusion some writers omit the terms billions, trillions, &c., altogether, and read

10,000,000,000,000 as ten million million.

In this book we shall call the last 6 figures of 7 or more, millions; the preceding 6 of a total of 13 or more, billions; and so on. Thus, 14,723,125,206,710,216,945,101,201 =

quadrillions	trillions	billions	millions	
14	723,125	206,710	216,945	101,201

would be read, 14 quadrillion, 723,125 trillion, 206,710 billion, 216,945 million, 101 thousand, 201.

But in practice such numbers as these never appear. The astronomer is content with powers of 10, preceded by 1 or 2 significant figures. Thus for the above numbers he would probably write:

either	14	×	10^{24}
or	15	×	10^{24}
or	1.47	×	10^{25}

He can rarely hope to be able to do more than show the general *order* of the magnitude he is considering. More often than not his estimates are necessarily only extremely rough approximations. The above number he would *read*, "14 (or 15) into 10 to the 24th", or "1.47 into 10 to the 25th".

The significance of these big numbers is very difficult to grasp. As we pointed out in Chapter XVII, an ordinary watch ticks 5 times in 1 second, or a million times in two days, or a billion times in 6000 years, or a trillion times in 6000 million years (we neglect wear and tear!): this is simple arithmetic, but how impressive, if a moment's thought is given to it.

The astronomer avoids such numbers as far as he can by adopting very large units. The unit best understood is the

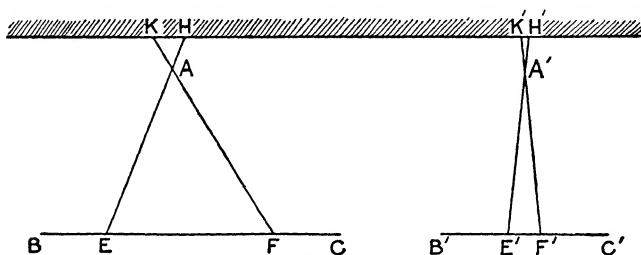

Fig. 132

“light-year”: it is a *distance*, viz., the distance travelled by light during one year. Since light travels 186,000 miles in a single second, it travels 6,000,000,000,000 (six billion) miles in a year. This distance ($6 \cdot 10^{12}$ miles) is the “light-year”. The nearest star to us is Proxima Centauri, 24 to 25 billion miles distant; the brightest star in the sky is Sirius, 50 billion miles distant. Reduced to light-years these distances become, approximately, 4 and 8 respectively.

But the astronomer now uses a rather greater unit, called the “parsec”. In Chapter XVII we referred to *parallaxic* motion, that is, the change of position of objects with respect to one another, arising from the motion of the spectator. Suppose we want to know the distance of an inaccessible tree A from a road BC (fig. 132). We measure off a base line* EF

* A surveyor desiring very accurate results never tries to measure a base line more than a mile or two in length: the job is far too difficult. But having measured such a line he thereafter depends on the measurements of angles. The astronomer accepts the surveyor's measured short distances, for instance the distance between two places on the same meridian of the earth, and then proceeds with larger and larger triangles of his own, always measuring angles.

in the road, measure the angles at E and F and either draw a figure to scale and measure the lengths EA and FA, or calculate these distances by applying a simple and well known trigonometrical formula. The perpendicular distance from A to BC is then easily determined. Suppose that at some distance behind the tree there is a background, say a wood. As we moved from E to F the tree would *appear* to move from H to K. Any sort of background enables us to *see* the parallax movement of the tree. If the base line E' F' were very short, or, alternatively, if the tree was a very long distance

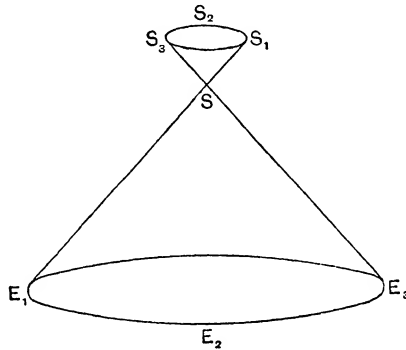

Fig. 133

away, the angles at E' and F' would be very nearly right angles, the parallax distance H' K' and the parallax angle A' would be very small, and the measurement of distances would be very rough and probably very inaccurate.

The moon being so close to us (240,000 miles), the measurement of its distance is little more than a surveyor's problem. The base line commonly taken is the line between the Greenwich and the Cape observatories, the length of which is, of course, known. The angles at the respective ends of this base line being measured, the rest is an affair of five minutes' calculation.

But with the stars the problem is altogether different; their distances from us are so colossal. And yet, ultimately, the principle is the same as before.

In the course of a year, the earth travels through a nearly circular orbit and it occupies opposite ends of any diameter (186,000,000 miles long) approximately every six months. This diameter we use as a base line for our triangle. Any nearer star will describe a parallactic movement against the background of more distant stars. When the earth is at E_1 , the star appears at S_1 , and when the earth is at E_2 and E_3 , the star appears at S_2 and S_3 , respectively (fig. 133). As the earth moves through its orbit, the star appears to trace in the sky a minute path similar in shape to the earth's orbit. If then the angle $E_1S_2E_3$ can be measured, the distance E_1S_2 can be determined in terms of the radius of the earth's orbit. *Half* the angle $E_1S_2E_3$ or that subtended by the *radius* of the earth's orbit, is called the star's parallax.

This parallactic angle of a star is so extremely minute that it is useless to try to determine it by measuring the base angles, and we have to be content with measuring *relative* distances by measuring the parallactic displacement of selected bright stars relatively to the faint and (presumably) more distant stars in the background of the sky. From these relative distances, absolute distances are easily calculated, once the absolute distance of some selected star is determined by some other method. More than one such other method is now known. The light of a star might be compared, for instance, with the light of the sun, and the distance of the sun being known, the distance of the star could be estimated by the inverse square law.

A triangle with a vertical angle of 1° would be so "lean and lanky" that its two long sides, say each a yard long, would be scarcely distinguishable from each other, and its base would be so short as to be insignificant. But the astronomer's main triangle has a vertical angle of only $1/3600$ part of a degree, that is, an angle of only a *single second* of arc ($1''$); the base line is the radius of the earth's orbit, 93 million miles; either of the two long sides (which we may assume to be equal) is the astronomical unit called the "parsec," the length of which is about 19 *billion miles* or $3\frac{1}{4}$ *light years*.

The astronomer thinks in terms of parsecs; the man in the street usually finds it easier to think in terms of light-years.*

The reader may usefully remember details of the nearest star, Proxima Centauri, and of the brightest star, Sirius:

Star	Parallax	Distances in		
		Parsecs	Light Years	Miles
Proxima Centauri	0.765"	1.31	4.3	25,000,000,000,000
Sirius	0.377"	2.65	8.6	50,000,000,000,000

The Mount Wilson Observatory

The Mount Wilson Observatory has become the most famous Observatory in the world, and some reference to the work it is doing is necessary for an adequate appreciation of recent developments in astronomy. Mount Wilson is about 8 miles from the Californian city of Pasadena and some 15 or 20 miles from the larger city of Los Angeles. It is one of the higher peaks of the Sierra Madre range and has an altitude of nearly 6000 feet above the sea. It is an ideal place for a large observatory, for it is singularly free from haze and fog, temperature changes are moderate, wind velocities are low, and observing conditions are good. Observations may be made on nearly 300 days of the year. Plate 32 gives an aerial view of the Observatory site and buildings.

The former Director of the Yerkes Observatory, Dr. G. E. Hale,† wished to set up a special telescope for solar observations under the best obtainable climatic conditions, and Mount Wilson was chosen upon the recommendation of Professor W. J. Hussey of the Lick Observatory. The Carnegie Institute of Washington became interested in the

* There are 206,265 seconds of arc in a radian; hence the parsec is 206,265 times the radius of the earth's orbit, or about 19 billion miles.

† Professor Hale is the subject of an appreciative article (No. XLVII, "Scientific Worthies") in *Nature*, July 1, 1933. A photogravure portrait accompanies it.

project and supported it with substantial funds. Dr. Hale was appointed first Director in 1905, and several of the Yerkes Staff joined him in pioneer work on the mountain.

The Observatory offices, the library of 11,000 volumes, the laboratory, and the workshops, are maintained in the neighbouring city of Pasadena, where also the Observatory Staff live.

The Observatory equipment is the envy of the astronomical world. The major instruments may be briefly described:

1. For Solar Observations

(1). **The Snow Horizontal Telescope.** A coelostat receives the light from the sun and reflects it to a plane mirror which in turn throws the beam nearly horizontally upon a concave mirror of 24 inches aperture and 60 feet focal length.

(2) and (3). **The two Tower Telescopes.** In these the path of the beam is vertical instead of horizontal, and the mirrors are placed high above the ground where they are less disturbed by heat waves rising from the earth. In each case the spectrograph is mounted in a well under the tower, the depth of the well being one-half the height of the tower. The *smaller* tower has a lens of 60 feet focal length for forming the solar image. The *larger* tower has a lens of 150 feet focal length, and on account of the tower's great height an image of the sun 17 inches in diameter is formed.

(4). **The Pasadena Telescope.** This is in a separate Solar Laboratory in the city of Pasadena itself. The telescope and spectrograph are somewhat similar to the equipment of the 150 foot Tower.

2. For Stellar and Nebular Observations

(1). **The 60-inch Reflector.** The disc of glass for the 60 inch mirror was obtained from France. Grinding was begun at the Yerkes Observatory in 1897, and was completed

in the Pasadena optical workshop several years later. Observations were begun in 1908 and for ten years this telescope was the largest in active use.

(2). **The 100-inch Reflector.** This is by far the largest telescope in the world and is indeed a wonderful instrument. In 1906 Mr. John D. Hooker made a gift of £9000 for defraying the cost of the mirror itself. The rough disc was cast in France and the work of grinding was begun at Pasadena in 1910. After six years of work, a paraboloidal figure of great accuracy was produced. The mirror is 101 inches in diameter and about 13 inches thick, and it weighs $4\frac{1}{2}$ tons. The total cost of the installation of the telescope and dome was about £120,000. Plate 33 shows the interior of the Dome.

The tube of the telescope is hung in a rectangular steel frame which is parallel to and therefore virtually part of the polar axis of the earth. The bearings are relieved by a mercury flotation system with drums over the north and south pedestals. By this method the telescope, which weighs over 100 tons, is easily moved to follow the course of the stars. The telescope is driven by a clock mounted in a room under the south pier, the clock driving a 17-foot wheel attached to the polar axis.

The optical arrangements of the telescope provide for its use with three different focal lengths suitable to different kinds of observations. (i), In the *Newtonian* form there is a single plane mirror to throw the beam from the large concave mirror to the side of the tube. (ii), In the *Cassegrain* form, there are a convex secondary and a plane mirror. (iii), In the *coudé* form there are a convex mirror of greater curvature and a plane mirror. The corresponding focal lengths are 42 ft., 134 ft., and 250 ft.

The 100-foot revolving dome is made double in order to reduce the heating effect of high day-time temperatures, and the mirror itself is surrounded by thick cork-board coats. The silver coating of the mirror is frequently cleaned and polished with cotton and rouge, and twice a year the mirror is lowered to the room below and an entirely new coat of silver is applied by chemical deposition from silver nitrate.

The performance of the telescope is so good that a 200-inch reflector is already under way. The reflector is to be made not of glass—which has been ruled out as impracticable for so large a mirror—but of fused quartz. A scheme for a 300-inch is also now under consideration. It is being worked out by the American astronomer, Professor Todd, who suggests the use of an old mine-shaft in the Andes for the tube and rotating mercury for the mirror. The focus of the telescope would be 1200 feet. Not all astronomers agree that the scheme is practicable.

(3). **The 10-inch Refractor** has a triplet lens of 45 inches focal length. It is used for the photography of wide fields of stars, for photometric observations, and for other purposes.

(4). **The 50-foot Interferometer**. Since 1920, measurements of the angular diameters of stars have been made with a 20-foot interferometer attached to the 100-inch reflector. A larger instrument with a soft beam has recently been completed in order to measure fainter and more distant stars. The mounting is entirely independent, with its own 36-inch reflecting telescope. The steel framework carrying the mirrors is mounted equatorially, and the mirrors, which are 15 inches in diameter, may be separated to a distance of 50 feet.

An astonishing amount of systematized work and research has been done at the Observatory since it was established nearly thirty years ago. For instance, the photographic record of the sun's surface includes over 50,000 plates for future study. Direct photography has revealed the forms of nebulae and star clusters, and has made it possible to study their nature, size, and distance. It has also served as an invaluable means of investigating the number, brightness, positions, distribution, colours, and distances of the stars. Spectrographs used in connexion with the large reflectors have supplied a large mass of information concerning the constituent elements, temperatures, motions, intrinsic brightnesses, and distances of the stars and nebulae.

The first Director, Dr. G. E. Hale, was succeeded by

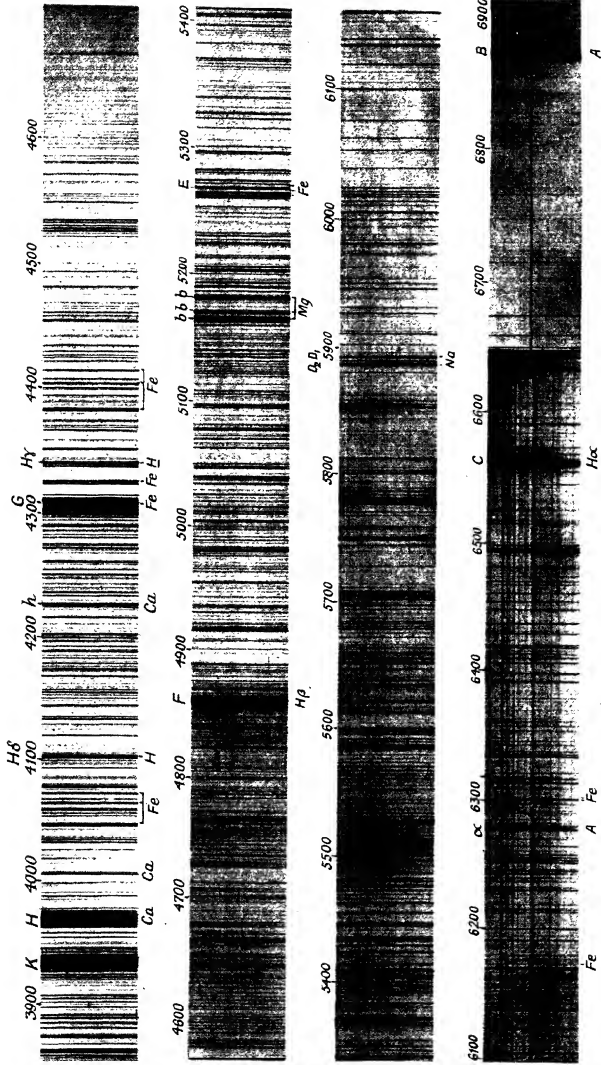

Spectrum of the Sun, $\lambda\lambda$ 3900-6900, with 13-ft. Spectrograph
Mount Wilson Observatory

Dr. W. S. Adams, who had been Assistant Director, and Professor F. H. Seares was appointed Assistant Director in 1925.

The Scientific Staff number 20, in addition to 12 computers and a librarian: the special work of Dr. E. P. Hubble and Dr. M. L. Humason is familiar to all astronomers. In addition there are some 40 others on the permanent staff, engaged in the regular work of operation and construction of some kind.

A number of distinguished astronomers from other observatories in different parts of the world have from time to time carried out notable researches at Mount Wilson.

There are numerous other well equipped observatories in America. Next to that at Mount Wilson, the most notable is at Toronto where Messrs. Howard Grubb, Parsons and Co., of Newcastle-upon-Tyne have erected a 74-inch reflecting telescope, the second largest in the world.* Ottawa has possessed a 72-inch reflector for some years, and Canada thus possesses the two largest telescopes in the British Empire. Of English observatories, that at Greenwich ranks first, and it is now the possessor of the largest telescope in the country, a 36-inch reflector presented by Mr. W. J. Yapp. Our Astronomers Royal at Greenwich have always been distinguished men.

During the present century a vast amount of observational work has been done, and great masses of undisputed facts have been accumulated. These facts the reader may accept without demur, but he must not allow the facts to be obscured by the many speculative hypotheses that have grown up around them in recent years.

The Galactic System

The Galactic system is sometimes referred to as "our neighbourhood". As will be seen in the sequel, the term is particularly apt.

* A detailed description of the telescope will be found in *Nature* for October 14, 1933.

Look up into the sky on a clear starry moonless night. How many stars can be seen with the naked eye? *Not* millions, *not* hundreds of thousands, *not* even tens of thousands. No matter how efficient the gazing eye may be, it will not see more than 3000 stars, and about the same number may be seen in the southern hemisphere, say from New Zealand. It is not at all difficult to form an estimate for oneself. Stand in front of a small-paned window, count the stars seen through each pane, add together and so obtain the number of stars in that particular patch of sky seen from the window. Or take an old picture frame and with stretched string divide it up into squares, add together the number of stars seen in the various squares, and so gauge the number in that particular bit of sky. If the main constellations (see fig. 134) are recognized, as they ought to be by everybody, it is not difficult to divide up the sky into roughly 15° sectors extending from the zenith to the horizon, and to gauge the number of stars in one of these sectors; then multiply by $360/15$ ($= 24$). Naturally such gauging is extremely rough, but it tends to satisfy the mind that the number of stars visible to the naked eye are far, far fewer than is commonly supposed.

The first astronomer to form some clear notion of the stellar system as a whole was Sir **William Herschel** (1738–1822), a German musician who had settled in England. He first became interested in astronomy when he was an organist and music teacher at Bath, at about the age of thirty. He was unable to measure either stellar distances or stellar motions, and he had to be content with gauging stellar *distribution*; he made a careful survey, and then a catalogue of the stars of the northern hemisphere. His son, Sir **John Herschel** (1792–1871), who was born at Slough and educated at Eton and Cambridge (he was Senior Wrangler and Smith's prizeman), did for the southern hemisphere what the father had done for the northern.

F. G. W. Struve (1793–1864), a German astronomer, who was director of the Observatory at Pulkowa, engaged in the

same problem as the Herschels. The English astronomer **Richard A. Proctor** (1837–88) also did excellent work on star charting; and the German astronomer, **F. W. A. Argelander** (1799–1875) of Bonn, compiled a catalogue and constructed



Fig. 134.—Map of main constellations (Proctor)
From Proctor's *Half hours with the Stars* (Longmans)

an atlas of 324,198 stars. Later on, about 1890, the Dutch astronomer, **Jacobus C. Kapteyn** of Groningen, devised a remarkable statistical method for ascertaining the general structure of the stellar system, in which the intrinsic brightness or “luminosity” of the stars played an important part.

He divided space up into a number of "shells", and gauged the probable number of stars in each shell. There have been many other workers in the same field, including **F. H. Seares** of Mount Wilson, **P. J. van Rhijn** of Groningen, **Seeliger**, **Chapman**, and **Melotte**.

Any attempt to decide with the naked eye the distribution of stars in the stellar system is bound to end in failure; we can see only 3000 out of probably 100,000,000,000 (one hundred thousand million). Even a one-inch telescope will reveal 120,000.

On a clear night a band of faint stars known as the Milky Way is readily seen arching over the sky (see fig. 134). It is approximately a great circle dividing the sky into nearly equal halves. The plane of this circle is called the *Galactic* plane and passes very nearly through the earth.

The more powerful the telescope we use, the more stars we see, and if the stars were uniformly distributed in space we ought

to be able to estimate the number of stars to be seen with a telescope of any given aperture. But they are not so distributed. It is evident at once that the stars "thin out" in certain directions and are densely grouped together

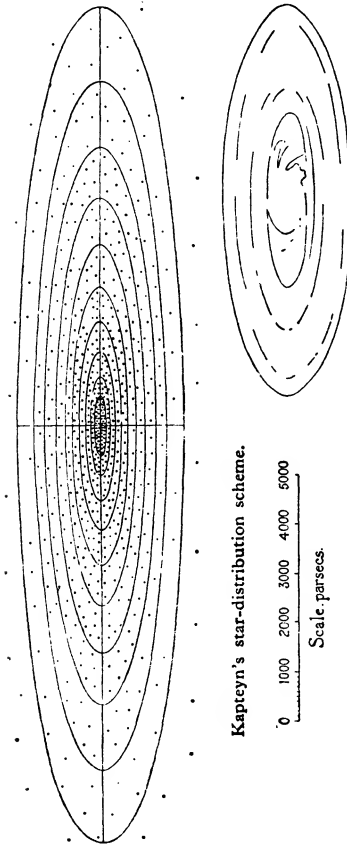

Fig. 135

in other directions. A detailed study of this thinning out enables us to form a fairly complete picture of the galactic system as a whole. This was the main work of the Herschels and of Kapteyn.

It has been estimated by competent astronomers that in the neighbourhood of the sun the stars are scattered at the rate of about one star to every 10 cubic parsecs; in other words, every such star has a space of its own to roam about in of $10 (19 \cdot 10^{12})^3 (= 7 \cdot 10^{40})$ cubic miles. This amount of space per star is almost incredible, but the estimate is very probably of the right order of magnitude. How far from the sun must we go to find the star field thinned out to any given fraction of its density in the neighbourhood of the sun? This was Kapteyn's problem. He found that if we travel in any direction whatever *in the galactic plane*, for a distance of 8465 parsecs (27,000 light-years), the star density is reduced to $\frac{1}{100}$ of its value in the regions surrounding the sun; but that if we travel *in any other direction* we need not travel so far to reach a corresponding reduction of density. If, for instance, we travel in a direction perpendicular to the galactic plane, the same reduction of density is reached after travelling only 1660 parsecs (5400 light-years). Kapteyn's general conclusion was that the various points in space at which the star density is $\frac{1}{100}$ of that near the sun lie on a very flat spheroid, a spheroid almost as flat as a watch. The mid-plane of the galaxy (the galactic plane) is thus a circle of a radius of 8465 parsecs; the mid-perpendicular section is a flat ellipse with a semi-minor axis of 1660 parsecs. Had we selected any other fraction instead of $\frac{1}{100}$, we should, according to Kapteyn, still have obtained a flattened spheroid with axes in the same proportion. Fig. 135 shows Kapteyn's diagrammatic cross-section through the central axis of his star distribution scheme.

The sun is supposed to be near, though not exactly at, the centre of the system. We should not look upon the Milky Way as a *ring* of stars around us. The sun (our own star, with which we may identify ourselves) is a true member of the galaxy even though he seems to be so isolated. But he is no

more isolated than a tree in a forest except that he and all his neighbours are so far apart; his neighbours are, however, so multitudinous that to him they seem quite close together.

Kapteyn's scheme probably presents us with a good general picture of the stellar system, but of course it does not show us the stars beyond a certain distance. His estimate of the total number of stars was about 1500 million, but, by extrapolation from known observational results, **Seares and van Rhijn** have estimated (*Mount Wilson Contribution* 301) the total number of stars at 30,000 million, or 20 times Kapteyn's number. With more powerful telescopes, what may we not find? Sir **Arthur Eddington** already speaks of 100,000 million.

Kapteyn's galactic system, "our neighbourhood", is, at best, but a small island in the vast depths of space. Presumably, however, it has a diameter of at least 17,000 parsecs ($3 \cdot 10^{17}$ miles). Compare it with our puny Solar system. Neptune's orbit has a diameter of 6000 million miles. The two diameters bear the same ratio to each other as the two lengths 1000 miles and one inch. "Our neighbourhood" wants pondering over. We shall be leaving it and starting on a long journey presently.

We can touch only very briefly upon one or two of the more interesting features of the galactic system. Looked at with the naked eye most of the stars seem to be single, solitary, and independent. Most of the familiar groups (constellations) that we know so well are entirely artificial, entirely man-made. The fanciful mythological names are convenient and suggestive, but they have no inner significance. There are, however, certain exceptional cases of special grouping.

Associated pairs, triplets, and clusters of stars are quite common. The Pleiades and the Hyades are clusters familiar to schoolboys. Far more conspicuous groups are, however, easily found. For instance, practically all the bright stars in the constellation of Orion, the most familiar constellation of all, are a naturally associated group, though the brightest

of them, Betelgeux (α Orionis), seems to be journeying alone. The constellation of the Great Bear is another associated group though again the brightest of the group (α Ursæ Majoris) is a solitary traveller. The famous "globular" clusters form a different category, and are more or less spheroidal in form; they are so remote as to be entirely outside our system of stars or to be at least in regions where stars are exceedingly few. Dr. Harlow Shapley, now Director of Harvard Observatory, working with the 60-inch reflector at Mount Wilson, found that the distances of the globular clusters varied from 6500 to 67,000 parsecs, and that their diameters are all of the order of 150 parsecs (490 light-years). Dr. V. M. Slipher of the Lowell Observatory showed in 1917 that globular clusters as a whole have negative radial velocities, that is, these great stellar systems are approaching the sun, and therefore the galactic system, with large velocities.

We may perhaps regard the globular clusters as links of some kind between "our neighbourhood", the galactic system, and the stupendously distant nebulae to which we must now refer.

The extra-Galactic System

The sun is the chief member of our own little solar system which has a diameter of a mere 6000 million miles. He is one of possibly 100,000 million stars, each of which has perhaps a space of 70,000 sextillions of cubic miles to roam about in (p. 621). These stars form our own galactic system, and this system is just one of a vast number of other such systems scattered about, but all pursuing definite journeys, in the far depths of space.

The extra-galactic systems are at such vast distances that they can be recognized only as small patches of cloud, and these cloud-like patches in the sky are known as *nebulae* (Lat. *nebula* = mist). The two brightest patches are just

visible to the naked eye. One of them, the great Nebula of Andromeda, was referred to by a Persian astronomer over 1000 years ago, and it appears on a Dutch chart of the constellation Andromeda drawn about 1500 A.D. After the invention of the telescope it was rediscovered in 1612 by **Simon Mayer**, who aptly described it as resembling "a candle shining through horn".

In 1656 **Huygens** drew attention to "one phenomenon among the fixed stars which has hitherto been noticed by no one, and indeed cannot be well observed except with large telescopes. In the sword of Orion are three stars quite close together. In 1656, as I chanced to be viewing the middle one of these with the telescope, instead of a single star, twelve showed themselves (a not uncommon circumstance). Three of these almost touched each other, and with four others shone through a nebula, so that the space around them seemed far brighter than the rest of the heavens, which was entirely clear and appeared quite black, the effect being that of an opening in the sky through which a brighter region was visible."

Objects in the sky may be divided into two main groups, according as the telescope shows them as mere points of light or as measurable areas. The planets, even the smallest, belong to the latter group; the stars, even the largest, belong to the former, they are so far away. From this point of view the nebulae may be grouped with the planets.

Nebulae are commonly divided into three classes. (1) The first, which is comparatively unimportant, are called "planetary" nebulae, an unfortunate name since they are not nebulae in any strict sense and they are not planetary except in the sense of showing a disc of planetary size through a telescope. They are comparatively rare. In general they are apparently spheroidal or ellipsoidal in shape and are near enough for their distances to be estimated by the direct trigonometrical method. They all lie within our own galactic system of stars. (2) The second class of nebulae are the "irregular" nebulae; these also belong to the galactic

system. They are all completely irregular in shape, their general appearance being that of wisps of glowing gas stretching from star to star, and this is probably very much what they are. A cursory examination shows that each irregular nebula contains several stars enmeshed with it; a minute telescopic examination often extends the dimensions of the nebula almost indefinitely so that it seems to embrace almost a whole constellation. One of the irregular nebulae is shown in Plate 34. It is the beautiful network nebula in Cygnus (note the number of stars shown in such a tiny patch of sky). Another is the famous "Horse's Head" in the Great Nebula of Orion, south of the star Zeta (Orionis). (3) The third class of nebulae is by far the most important of all; they are the extra-galactic nebulae.

The extra-galactic nebulae comprise the huge nebulae of regular shape which lie far outside our galactic system. They may be circular, elliptical, spindle-shaped, or spiral, though they are all commonly referred to as the *spiral* nebulae. Two of them, one (M. 31) in Andromeda and one (M. 33) in Triangulum, are of outstanding brightness and apparent size, and are just visible to the naked eye, and their distances are easily estimated by the circumstance that they contain Cepheid variables (we shall explain these in the next section). Dr. E. P. Hubble of Mount Wilson estimated that the distance of M. 31 is 285,000 parsecs (900,000 light-years), and that of M. 33, 266,000 parsecs (850,000 light-years). Such figures show that the nebulae are quite outside our system of stars (the galaxy). They constitute what Herschel described as "island universes" distinct from the stellar universe (the galaxy) that contains our sun. Their distances known, their sizes are easily calculated. The diameter of M. 31 (Andromeda) which extends nearly 3° in the sky is about 15,000 parsecs; that of M. 33, extending about 1° , is about 5000 parsecs. The nebulae are called extra-galactic on account of their distance. They are at enormous distances from our own galaxy.

Plate 35 shows a beautiful photograph of the Spiral

Nebula in the constellation of Ursa Major (N.G.C., 3031; Messier, 81). It was taken by the 60-inch reflector at Mount Wilson. The exposure was $4\frac{1}{4}$ hours.

Through the telescope the great spiral nebulae differ enormously in apparent size, shape, and brightness. Hubble has shown that the differences in size and brightness in spiral nebulae of the same shape are almost entirely due to distance effect. It is thus possible to estimate the distances of all nebulae, down to the very faintest visible, with fair accuracy. The faintest nebulae visible photographically in the 100-inch telescope give only about a $\frac{1}{100,000}$ part of the light of the brightest. Assuming the difference in light to be due to a distance effect, the 18th magnitude nebulae must be at a distance of about 140,000,000 or of 150,000,000 light-years. This represents the range of vision of the 100-inch telescope for objects having the luminosity of the great nebulae. It is the greatest distance with which practical astronomy has so far had to deal, and is the greatest distance that the aided human eye has so far seen into space. Hubble estimates that within this distance there must be about 2,000,000 nebulae, uniformly spaced at about 570,000 parsecs, or 2,000,000 light-years, apart.

Sir James Jeans says: "We can construct an imaginary model of the system of the great nebulae by taking about 50 tons of biscuits and spreading them out so as to fill a sphere of a mile radius, thus spacing them at about 25 yards apart. The sphere represents the range of vision of the 100-inch telescope; each biscuit represents a great nebula of some 4000 parsecs diameter. A few nebulae of exceptional size must be represented by articles rather larger than biscuits, while our system of stars, up to Kapteyn's 10th spheroid, would be represented by a flat cake 13 inches in diameter and $2\frac{1}{2}$ inches in thickness. On this scale the earth is far below the limits either of vision or of imagination for it is little more than an electron in one of the atoms in our model; and we should have to multiply its dimensions many millions of times to bring it up to the size of even the smallest particles

which are visible in the most powerful microscopes." This striking illustration is worthy of very careful attention.

There is a good deal of evidence which encourages the conjecture that the great nebulae, which are all of comparable size and comparable with, though rather smaller than, our own galactic system, may be clouds of stars, of the same general nature as the stars surrounding the sun. This view of the first nebulae has been very prevalent since the time of the Herschels. Some of the nebulae have actually been resolved into stars by our telescopes, at least in their outermost regions. A further fact that tends to confirm the same view is that the nebulae have the same general shape and build as the galactic system, that is, they are flattened discs with high central condensation.

No ordinary terrestrial telescope will break up the nebulae into separate points of light, but powerful modern celestial telescopes, like those at Mount Wilson, will break up the outer nebular regions readily. The cloud of shining particles are seen as clearly as were the stars of the Milky Way when viewed through Galileo's primitive little telescope 300 years ago. It is certain that some at least of the spots of light are stars because they are unmistakably recognizable as Cepheid variables. The other shining particles show a brightness of such a range above and below that of the Cepheids that we are probably fully justified in inferring that they are ordinary stars.

It is possible to estimate the total numbers of stars in a nebula. It may be fairly safely assumed that the outermost stars in our galactic system are describing orbits under gravitational attraction; we are therefore probably justified in assuming that the outermost stars in a nebula are describing orbits under the gravitational attraction of the main mass of the nebula. Thus we can weigh the nebulae by precisely the same method as we weigh our own sun, or our own galactic system. This is all simple arithmetic if the main assumptions are accepted, as they are by astronomers. Dr. **Hubble** estimates in this way that the weight of the nebula

M. 31 in Andromeda is about 35,000,000,000 times that of the sun. One authoritative estimate is that each extra-galactic nebula contains about enough matter to make some 2,000,000,000 stars. Whether the central regions of the nebulae are yet actually composed of stars it is impossible at present to say. Perhaps the 200-inch telescope will tell us, or will at least resolve into stars a much greater part of each nebula. There is reason to think that the central regions are masses of gas which are destined in time to form stars, and that the nebulae are really star nurseries.

It is of considerable interest to note that the greatest distance which the human eye has yet penetrated into space, viz., 150,000,000 light-years (900 trillion miles), is 2500 times as great as the 60,000 light-years which form the diameter of the whole of one galactic system.

One is almost staggered by the thought that the light by which we see one of the remoter nebulae has taken 150,000,000 years to reach us, and during all that time has been travelling at the rate of 186,000 miles a second. The picture of such a nebula as we see it is a picture of the nebula *as it existed 150,000,000 years ago*. What may have happened to it since then? What may it be like now? For $\frac{99}{100}$ of its long journey, the light from the nebula travelled towards an earth *not yet inhabited by man*. The last $\frac{1}{100}$ of its journey covers the long stretch of time since man emerged from the apes, something of the order of 1,500,000 years.

Sir **Arthur Eddington** is of opinion that the total number of nebulae in the universe must reach 100,000,000,000. He gives us a "celestial multiplication table":

100,000,000,000 stars make one Galaxy.

100,000,000,000 Galaxies make one Universe.

His estimate of the number of stars in the Universe is thus

$$10^{11} \times 10^{11}, \text{ or } 10^{22}$$

that is, ten thousand trillion. This number is of the same order as the number of grains of very fine sand that would

cover the surface of England and Wales to the depth of a foot, or the number of drops of water in all the oceans of the world, or the number of molecules in a glass of water. With some effort the number is imaginable. Bear in mind it refers to *stars*, each of them comparable with our sun!

More about celestial measurements. The Cepheids.

The diameters of the larger stars are readily measured by the interferometer, the development and far-reaching use of which we owe to Professor A. A. Michelson (1852-1931). The instrument superposes two different diffraction patterns of the same star, and sets one off against the other in such a way as to disclose the diameter of the star producing them.

More important, however, than the sizes of the stars are their distances. The direct method of parallax measurement enables astronomers to survey the universe only to a distance of about $3\frac{1}{4}$ parsecs (10 light-years) from the sun. What a small fraction of the whole! The apparent diameter of the orbit of a star 1000 parsecs distant is equal to the apparent diameter of a pin-head held 50 miles away. It is utterly impossible to measure such a small parallax motion. To survey the remote depths of space, an entirely different method is necessary.

The older astronomers were fully alive to the limitations of the parallax method and attempted to devise alternative methods. Kepler, for instance, had maintained that the stars were merely distant suns; it followed that the enormous differences between the intensities of sunlight and starlight might be explained by assuming enormous differences of distance. Could some photometric method of determining distance be devised? The planet Saturn is one of the brightest objects in the sky, and is just about as bright as Altair (α Aquilæ), one of the brightest stars. But Saturn shines only by the light it reflects from the sun, and its distance from the sun is such that it receives only 1 part in 2500 millions of the sun's total light. As the surface of Saturn reflects back only about two-fifths of the light it receives, it follows that

Saturn shines with a light equal to 1 part in 6000 millions of the sun's total light. If we assume that Altair has about the same candle-power as the sun, it follows that since the apparent brightness of an object falls off in the inverse square of its distance, the distance of Altair is $\sqrt{6000}$ million, or about 80,000 times the distance of Saturn. Since we know the distance of Saturn, we can now calculate the distance of Altair. Such an estimate does not very seriously differ from estimates made in other ways. The method is at least a rough and ready way of measuring distances.

The method of **spectroscopic parallaxes** is a modern, much more important, and more far-reaching method. It was discovered by Dr. **W. S. Adams**, now Director of Mount Wilson, and others. Two stars which are of exactly similar structure in all respects necessarily emit light of precisely similar quality, so that their spectra must be similar in all respects. As the stars are at different distances, the spectra would naturally differ in brightness, and on measuring the ratio of their two intensities it is possible to deduce the ratio of the distances of the stars. Thus if the distance of one star has already been determined by a trigonometrical or some other method, the distance of the other can be calculated. In practice the method is difficult, but it is certainly reliable.

Cepheid Parallaxes. The measuring of distances by means of Cepheids is really based on the same simple property of light, viz., that the intensity is inversely proportional to the square of the distance.

The majority of the stars shine with a perfectly steady light, and we are therefore able to say that a star is of so many candle-power. Our own star (the sun), for instance, emits a light of 3.23×10^{27} candle-power. But there are classes of exceptional stars in which the light varies, and the most interesting of these is a certain class of *regularly* varying stars, called the Cepheid variables, after their prototype the

star *delta* of the constellation Cepheus, in the neighbourhood of the Pole Star (see map). Cepheid variables show perfectly regular fluctuations, flashing out to some two or three times their normal brightness at intervals which range from a few hours to several days for different stars, but always at perfectly uniform and regular intervals for the same star. "It is as though some one were throwing armfuls of fuel into a fire at perfectly regular intervals."

In 1912 Miss **Leavitt** of the Harvard observatory, who was studying the Cepheid variables in the lesser Magellanic cloud, discovered a law connecting their time of fluctuation and their brightness (apparent magnitude), and Dr. **H. Shapley**, now Director of that observatory, then of Mount Wilson, subsequently proved that this law was true of Cepheid variables in general. Dr. Shapley and Professor **E. Hertzsprung** of Leiden quickly turned the discovery to account. If two Cepheids in different parts of the sky are found to fluctuate with equal intervals, then their intrinsic candle-power must be equal, and any difference in their apparent brightness must be traceable to a difference in their distance from us. If one looks 100 times as bright as the other, then the latter must be $\sqrt{100}$ ($= 10$) times the distance of the former. And so generally. Any two may thus be compared, and thus we have a measuring rod which admits of almost indefinite extension. A small number of the Cepheids are close enough to us to admit of parallactic measurement and therefore of the calculation of their absolute distances. Clearly then we have the necessary data for measuring the absolute distance of any Cepheid. The "period-luminosity law" can be made to provide a scale on which the candle-power of a Cepheid can be read off directly; we read off their candle-power from the period of their light-fluctuations. The apparent brightness of the Cepheid tells us the distance.

We may work out an example by Sir James Jeans's method: a Cepheid whose light fluctuates in a period of ten days has a luminosity 1600 times that of the sun, or a candle-power of 5.17×10^{30} . If, therefore, a particular star

is observed to fluctuate with a ten day period, and the quality of its fluctuations shows it to be a Cepheid variable, we know that its actual candle-power must be 5.17×10^{30} . Now we have to observe its *apparent* brightness. We will suppose this to be that of a star of magnitude 16, which means that we receive as much light from it as from a single candle 570 miles off.

The mathematical relation between 1 candle and 5.17×10^{30} candles accordingly corresponds to the mathematical relation between a distance of 570 miles and the distance of the star. Since light falls off as the square of the distance, the distance of the star must be:

$$\begin{aligned}
 & 570 \text{ miles} \times \sqrt{5.17 \times 10^{30}} \\
 = & 570 \text{ miles} \times 2.27 \times 10^{15} \\
 = & 1294 \text{ miles} \times 10^{15} \\
 = & 216 \text{ miles} \times 6.10^{15} \\
 = & 216,000 \text{ light-years} \\
 = & 70,000 \text{ parsecs.}
 \end{aligned}$$

In 1924 Dr. **Hubble** of Mount Wilson detected Cepheid variables in the near spiral nebulae which he was thus able to show were about 1,000,000 light-years distant. Using this distance as a measuring rod, he found that the remotest of the visible spiral nebulae were well over 100 times as far away as the nearest, probably something like 150,000,000 light-years. More recently Dr. Hubble has confirmed that size and brightness in nebulae of the same shape are almost entirely due to a distance effect. There is, in fact, good reason to be confident in the distances calculated by reference to the Cepheid variables. Happily the distances obtained by one method are checked and largely confirmed by other methods, and we need not feel much doubt about the results, though they are never put forward as more than rough approximations. A result which is 10 per cent out might easily represent an error of hundreds of thousands of millions of miles; nevertheless the general order of the result would be quite acceptable.

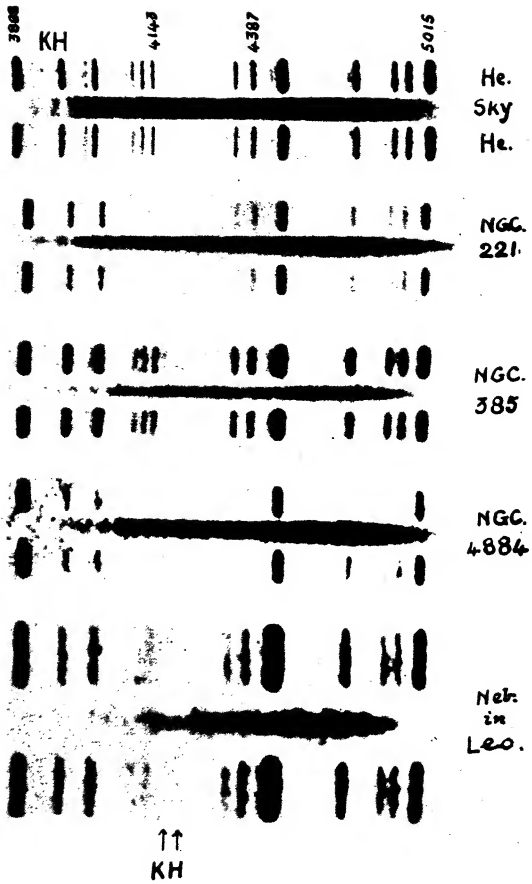

Nebular Spectra, showing Red Shift Increasing with Distance
Mount Wilson Observatory

Recession of the Nebulæ. The Doppler Effect

An Austrian physicist, **Christian Johann Doppler** (1803-1853), is chiefly remembered for the *Doppler Principle*, which may be stated thus: (a) The pitch of a sound is changed if the object emitting it is moving relatively to the observer; (b) the light emitted by a moving star is changed in colour as perceived by a relatively stationary observer.

Ordinarily, the frequency of vibration in the source of sound is the same as in the ear of the listener and in the intervening medium. This identity does not, however, hold good if the source of sound and the ear of the listener are approaching or receding from each other. Approach of either to the other produces increased frequency of the pulses on the ear, and the sound is heard at a higher pitch. Careful observation of the sound of a railway engine whistle as an express train dashes through a station has confirmed the fact. A speed of about 40 miles an hour will sharpen the note by a semitone during approach and flatten it by the same amount during recession, the natural pitch being heard at the instant of passing.

Perhaps the best observations of this kind were made by **Buys Ballot**. Trumpeters with their instruments tuned in unison, were stationed one on a locomotive and three others at intervals along the railway. Each trumpeter was accompanied by trained musicians whose business it was to estimate the differences of pitch between the note of the one trumpet and the notes of the others, as heard during the experiment.

Doppler's suggestion that the principle would explain the colours of the stars has not borne fruit, but the principle has been of very important service in connexion with spectroscopic research. Displacement of a spectrum line towards the violet end of the spectrum indicates approach of the source of light; displacement towards the red indicates recession. With approach, the number of waves received in a second (the frequency) is increased; with recession, the number is decreased. The velocity of approach or recession

can be calculated from the observed displacement of the line from its normal position. In the very early days of spectroscopy, a displacement of the F line towards the red end of the spectrum of the brilliant Dog Star (Sirius), as compared with the spectrum of the sun, was detected. The displacement was very minute, but it indicated a motion of recession of 30 miles a second.

It should be observed that the shift is interpreted as a true Doppler effect; it is assumed that what applies to sound waves also applies to light waves, in so far as there must be an increase or decrease of frequency. Can we find any sort of experimental confirmation of the accuracy of the interpretation? Apparently we can in the case of the sun. Owing to the rotation of the sun about its axis (the fact of the rotation admits of no doubt), the eastern edge, or limb, is approaching us and the western edge is receding. Although the differential shift of the spectra of the two edges amounts to only about one-twentieth of an Ångström,* this can easily be detected, for the light we receive from the sun is sufficient for the employment of spectrographs of high dispersion. The velocity works out at 2 kilometres a second, a velocity which corresponds almost exactly with the velocity calculated from the rotation of the sun spots. The spectra of Saturn and his rings also seem to provide confirmatory evidence. Outside the solar system we have higher speeds to deal with. Some of the spectra of the stars, for instance, show shifts of an Ångström or more, so that relatively to the earth the stars seem to be moving at a velocity of over 50 kilometres a second. In all such cases we have confirmatory evidence

* It will be remembered that the unit of measurement in the spectrum is the Ångström (= 10^{-10} metre, or the ten-thousand-millionth of a metre), named after the Swedish physicist Anders Jonas Ångström (1814-1874). It is a *wave-length* unit. A wave-length of 5000 Ångströms (representing a green colour) is usually written $\lambda 5000$ A.U. Visible light extends from about $\lambda 7600$ in the red to $\lambda 3900$ in the violet of the spectrum, and thus has a range of about 3700 Ångströms. A wave-length of 5000 A.U. has a "wave-number" of 20,000 (usually written $\nu 20000$). This wave-number represents the $\frac{\text{true frequency}}{\text{velocity of light}}$, or the number of waves contained in one centimetre of the wave train. (Cf. pp. 429-31).

to show that the shifts of the spectral lines were due to actual velocity changes in the line of sight. It was therefore perhaps natural to assume that, when similar effects were found in the spectra of the extra-galactic nebulæ, they were due to the same cause.

The pioneer work on radial velocities was carried out by Dr. **V. M. Slipher**, at the Lowell Observatory in Arizona. It has since been extended to the fainter nebulæ by Dr. **E. P. Hubble** and Dr. **M. L. Humason**, by means of the 100-inch reflector at Mount Wilson. As those astronomers have pushed their operations deeper into space, they have had to employ spectrographs of smaller and smaller dispersion. The remote extra-galactic nebulæ give so little light that to dissipate it by spreading it out into a long spectrum would be fatal. For the necessary spectrographs, lenses of very short focal length are required, and one based on the principle of a microscope objective was specially designed by Dr. **W. B. Rayton**. When this lens is used with one prism, the spectrogram has the extremely small scale of 875 Ångströms to the millimetre, and thus the whole spectrum as photographed is only a very small fraction of an inch in length. Even with such an instrument, very long exposures, sometimes of as much as 45 hours spread over several nights, have been required to obtain sufficiently strong spectra of the faintest nebulæ. It is also necessary to use fast plates with extremely coarse grain, so that the lines of the spectrograms are hazy and difficult to measure. Errors of one or more Ångströms are almost inevitable, and this may mean an error of as much as 100 kilometres a second in the derived velocities.

By the courtesy of Dr. **Humason**, we are able to show four of these nebular spectrograms, greatly enlarged, in parallel with one another and with the spectrogram of the sun. (Plate 36.) Above and below each of them is a spectrum of helium, from $\lambda 3888$ nearly at the end of the visible violet to about $\lambda 5015$ towards the visible red. It is the torpedo-shaped middle bands which are the spectrograms of the nebulæ; they appear as negatives, i.e. the continuous

spectrum appears dark and the absorption lines as gaps in it; and it is these absorption lines that chiefly concern us. At the top is the spectrum of sunlight, showing clearly the normal position of the H and K lines. The first nebula is number 221 from the New General Catalogue (N.G.C.), one of the companions of the great nebula in Andromeda. The lines are shifted very slightly to the left, i.e. towards the *violet*, indicating a velocity of *approach* of 200 kilometres a second. In the 2nd, 3rd, and 4th nebulae, the H and K lines are shifted progressively farther to the right, i.e. towards the *red*, indicating velocities

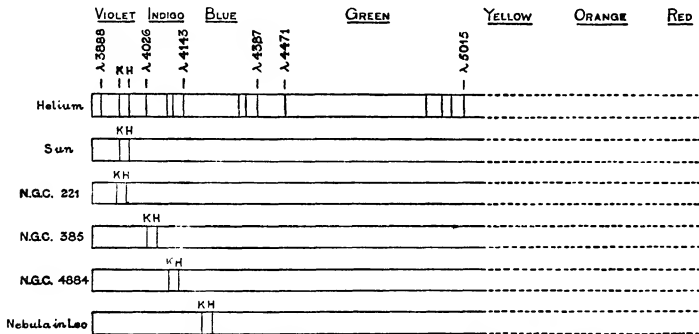

Fig. 136.—Dotted sections not to scale. Red extends to λ 7600

of recession of 4900, 6700, and 19,700 kilometres a second. The lines in the Leo nebula (the last) are found to have shifted nearly 300 Ångströms, i.e. about $\frac{1}{12}$ the length of the whole visible spectrum. The entire length of the Leo spectrum on the original negative is less than $\frac{1}{10}$ of an inch; the obtaining of even such hazy lines is thus a remarkable feat, and the subsequent measurements demanded the highest skill. In some nebular spectra, other lines besides the H and K lines are often recognizable, and all seem to conform to the conditions of a true Doppler effect, i.e. their shifts are proportional to their wave-lengths.

We have taken out the lines from the torpedo-shaped dark bands and show them in a separate diagram, where the shifts may be compared more easily (fig. 136).

The measured velocities are predominantly those of recession, and apply to all except a few of the nebulæ nearest us. The velocities are, of course, relative to the earth. The earth revolves round the sun, the sun is moving with respect to the stars, our galaxy is itself rotating, and every extra-galactic nebula probably has a velocity peculiar to itself, apart from any systematic general nebular motion. When we free the observed velocities of the nebulæ from the effects of the velocities of the earth, the sun, and the galaxy, most of the apparent velocities of approach appear to be merely reflections of our own motion, and the corrected nebular velocities are almost without exception recessive.

The highest velocity hitherto found is that of a nebula in the constellation Gemini, which is receding at the incredible velocity of 25,000 km. (15,000 miles) a second, the speed of an alpha particle! The present distance of the nebula is estimated at 150,000,000 light years, i.e. 900 trillion miles, and even at the present velocity this distance is being increased at the rate of about a billion miles every two years.

It seems to be fairly definitely established that there is a relationship between the velocities of the extra-galactic nebulæ and their distances. The graph works out to a practically straight line, showing that the law is one of *simple proportion*.

The simple proportionality of speed to distance was first found by Hubble in 1929. According to his most recent determination, the speed of recession amounts to 550 km. per second per megaparsec (a megaparsec = 3.26 million light-years). That is to say, a nebula which is

1 megaparsec distant should have a speed of
550 kilometres per sec.,

10 megaparsecs distant should have a speed of
5500 kilometres per sec.,

and so on. Fig. 137 shows this graphically. The graph was constructed by Dr. Knox Shaw, Radcliffe observer at Oxford.

Of course such estimates are necessarily very rough; they

are based on so many uncertain factors. But the general *order* of the numbers is probably not a great way out.

It should be understood that to the astronomer photography has become as absolutely essential an aid as is spectroscopy. Photography has not only multiplied the observer's productivity by a large factor but it has also made the observations more impersonal. When a result is fixed on a photographic plate, it is always possible to return to it

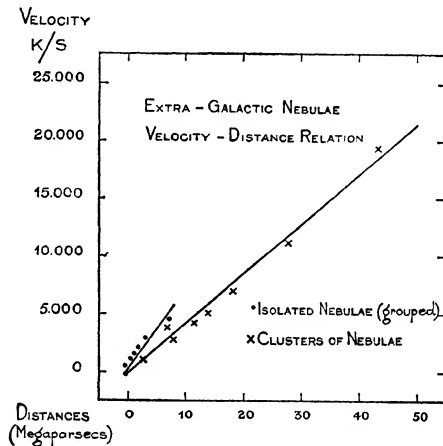

Fig. 137.—Knox Shaw's diagram from Hubble's Figures

and verify or amend the conclusions. Photographic methods are specially suited for the measurement of proper motions and parallaxes, as well as for the determination of positions.

“ The Expanding Universe ”

“ The Expanding Universe ” is a particularly ambiguous expression. Sometimes the term “ universe ” refers to the material content of space, sometimes to space itself. Sometimes “ space ” is intended to refer to an objective reality having an inherent structure of some kind, sometimes to just

empty nothingness. Sometimes "expansion" is made to refer to the recession of the nebulae, sometimes to the assumed curved space of the Relativist. Sometimes a writer will, in the compass of a single article, use the terms in different senses, thereby making it impossible to understand what he means.

The only objective facts supporting the hypothesis of expansion are those which emerge from a study of the recession of the nebulae. But it must be borne in mind that we do not really *know* that the nebulae are receding. The recession is an *hypothesis* based on a particular interpretation of the spectral shifts towards the red. If this interpretation falls to the ground, as it may, the whole theory of expansion will collapse. Informed opinion is by no means unanimous that the interpretation is justified. Assuredly the Doppler effect is not the only possible interpretation. For instance, it is by no means impossible that light may, in travelling over vast distances, *slow down*, and for that single simple reason shifts towards the red would then be expected. In a letter to *Nature* of 16th January, 1932, Professor W. D. Macmillan suggested that the red shift is due to the loss, in course of time, of energy in the photon, due either to inherent instability or collisions with other photons. He concludes: "Such an interpretation of the extraordinary shifts that are observed will be more acceptable to many than an interpretation which makes our galaxy a centre from which all others are fleeing with speeds that are proportional to the distances". Dr. Zwicky of Pasadena (Mount Wilson) also put forward a theory that light, by its gravitational effects, parts with its energy to the material particles thinly strewn in intergalactic space which it passes on its way. If we have to choose between the hypotheses (1) light must lose some of its energy during a journey of 100,000,000 years or more, (2) the nebulae, including our own galaxy, are moving bodily through space with velocities up to 15,000 miles a second, not everybody will be inclined to accept the latter rather than the former. But it is the latter that has stirred the imagination of

laymen, and it certainly now finds favour with certain well-known theorists.

Sir Arthur Eddington says: "We have no *direct* evidence of an outward acceleration of the nebulæ, since it is only the velocities that we observe";* And again, "the outward speed of the nebulæ are known by observation".†

But is this quite fair? We do not *observe* the velocities; we *assume* that the shifts towards the red are to be interpreted as if they represented velocities. The interpretation is purely hypothetical. It assumes that what applies to light in our own "neighbourhood" applies to it throughout the universe. How can this be justified? Sir Arthur admits that the "observational evidence" is "not quite strong enough in itself to warrant far-reaching conclusions," but that "it is backed up by relativity theory."

But assuming the expansion of the material universe to be real, we may think of it in this way. Let G represent our own galactic system, and let $N_1, N_2, \&c.$, represent the position of a number of nebulæ at the present moment. After 1500 million years these distances will be doubled, and we shall then have the nebulæ at $N'_1, N'_2, \&c.$ (where $G'N'_1 = 2GN_1, \&c.$). After another 1500 million years the distance will be quadrupled ($G''N''_1 = 4GN_1, \&c.$). (Figs. 138). For in his address to the Mathematical Association, January, 1931, Sir Arthur Eddington said: "About every 1,500,000,000, years the universe will double its radius, and its size will go on expanding in this way in geometrical progression for ever". Note the word *for ever*, and let the reader determine for himself, if he can, the radius of the universe 10^{100} centuries hence]

Figs. 138 are a little misleading, in that they are only two-dimensional. Of course, the material universe is three-dimensional, and the millions of nebulæ are receding outwards in all directions. We ought not, however, to think of them as receding from any particular centre, for our own galaxy must really be considered one of them, and *all* are

* *The Expanding Universe*, p. 23.

† *ib.* p. 86.

receding from one another. If we mark a slightly inflated toy balloon with a number of equidistant ink-dots, and then inflate further, we can see such an expansion in progress. The expansion does not apply to the nebulae themselves but to the *intergalactic spaces*. The universe thus corresponds roughly to the surface of the balloon, not to its interior.

We may evidently think of the galaxies as a kind of closed system, for we can conceive them on the surface of a sphere, even though that sphere is rapidly expanding. We may thus

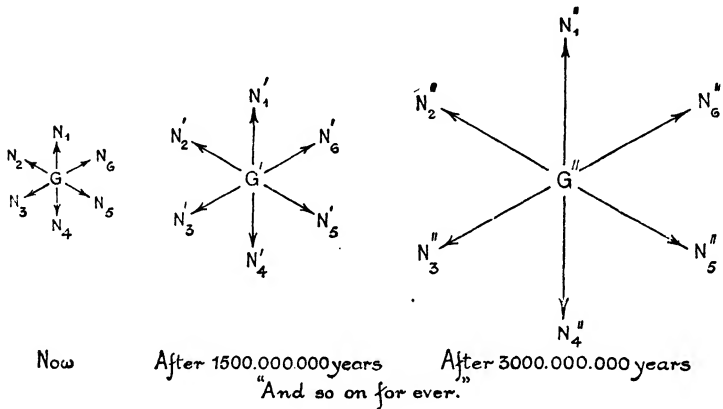

Fig. 138

think of the *space* which encloses them, and this may give rise to the idea of expanding *space*. Sir Arthur Eddington says: "We are familiar with the curvature of *surfaces*; it is a property which we can impart by bending and deforming a flat surface. If we imagine an analogous property to be imparted to *space* (three-dimensional) by bending and deforming it, we have to picture an extra dimension or direction in which the space is bent. There is, however, no suggestion that the extra dimension is anything but a fictitious construction useful for showing its mathematical analogy with the property found on surfaces". The reader cannot too carefully bear in mind that space-curvature is a *fiction*. Space of more than three dimensions has no reality, though the

mathematician often makes use of more than three *variables*—a very different thing. That the space we know has some sort of structure is highly probable; when a magnet approaches a needle it is almost impossible to resist the conclusion that the intervening space is doing work of some kind, though we have abandoned the properties of the æther of thirty years ago.

According to the theory of relativity the “universe” (whatever the term is intended to mean) is “finite yet unbounded”. **Einstein** and his co-worker, Professor **W. de Sitter** of Leiden, have estimated the size of the universe from the mean density of matter in space. They found that its radius is 10^{13} times the distance of the earth from the sun, so that it would take light 1000 million years to “go round” the universe. But **Hubble** estimates the radius of curvature of the universe to be 600 times 140 million light-years, i.e. about half a quadrillion ($5 \cdot 10^{23}$) miles, in which case it would take light nearly a billion years to “go round” the universe.

Both the Einstein universe and the de Sitter universe were closed and spherical. Both were static and would therefore remain unchanged, and would provide a framework within which the galaxies and stars could change and evolve. But Einstein’s universe has been described as containing matter and no motion, and de Sitter’s motion but matter of a density so low as to be almost zero. Clearly a whole series of universes between motionless matter and matterless motion is possible. A non-static intermediate solution was discovered by a Belgian mathematician, the Abbé **G. Lemaître**, in which both the material system and the closed space in which it exists are supposed to be expanding. Lemaître argued that no universe could stay permanently in the state considered by Einstein because it was unstable. Immediately it came into being it would start to expand, and would not cease from expanding until it became a de Sitter universe.

In working out his law of gravitation, Einstein added to the Newtonian attraction of bodies a repulsive scattering

force which is called *cosmical repulsion*. It is utterly imperceptible within the solar system, but since it increases proportionally to the distance, it ultimately becomes overwhelming; amongst the extra-galactic nebulae it becomes dominant and seems to be responsible for the dispersion. In the de Sitter universe, the density of matter being indefinitely small, the Newtonian attraction would be negligible, and the cosmical repulsion would therefore act without check. If we assumed that more matter were inserted, the mutual gravitation would tend to hold the mass together and would oppose the expansion. At a particular density, the Newtonian attraction would just balance the cosmical repulsion, so that the expansion would be zero. This is Einstein's universe. Eddington's view is that the universe started off as an Einstein universe and will finish up as a de Sitter universe.

Since the radius of Eddington's universe is doubling itself every 1,500,000,000 years, we may work backwards from the present and reach the beginning of the universe which (according to Eddington) then had an initial radius of 328 megaparsecs = 1068 million light-years = $6 \cdot 10^{21}$ (6000 trillion) miles. What was the first thing that happened at the beginning? Eddington suggests that "the most satisfactory theory" would be one which made the beginning "not too aesthetically abrupt". This condition is easily satisfied by Einstein's unstable universe. Eddington pictures a primordial state of things as "an even distribution of protons and electrons, extremely diffuse and filling all (spherical) space, remaining nearly balanced for an exceedingly long time until its inherent instability prevails". The calculated density of this distribution is about one proton and one electron per litre, which is almost inconceivably below the very best vacuum we can create. "There is no hurry for anything to begin to happen. But at last small irregular tendencies accumulate, and evolution gets under way".—Oh to have been present when these accumulated tendencies made the first proton or electron jump! We all

envy Sir Arthur Eddington's mathematical powers; we also envy his incomparable powers of imagination.

The reader should not waste his time by trying to conjure up a picture of inherently curved space. Such a conjuring up is impossible. As we have said before, curved space is entirely a mathematical fiction. It is just a far-fetched interpretation of the equations of general Relativity. No single astronomical observation has yet been made which suggests that space is curved. (The bending of light-rays in a gravitational field is a different thing altogether.) Light was supposed to go "right round" the Einstein Universe, following a circular path, but the only basis for this supposition was algebraic manipulation. Even Eddington says that the theory of star-ghosts was developed more as a mathematical curiosity than as a serious physical speculation: "In a perfectly spherical world [whatever a "world" may be] rays of light emitted in all directions from a point will, after travelling round the world, converge to the same point; thus a real image is formed from which light will again diverge in all directions. Such an image might optically be mistaken for a substantial body. Owing to the time taken in going round the world, the image is not formed until at least 6,000,000,000 years later than its source. Other images would be formed after two circuits, three circuits, &c. We can thus imagine space to be populated not only with real stars and galaxies but with ghosts of stars which existed 6000 million, 12,000 million, &c., years ago".—Yes, we can *imagine* it.

Sir James Jeans says: "According to Einstein's original theory, the dimensions of space are determined by the amount of matter it contains. Hubble estimates that the mean density of matter in space must be about 1.5×10^{-31} times that of water. On the assumption that matter is distributed with this density through the whole of space, *including those parts which our telescopes have not yet penetrated*, we can *calculate quite definitely* that the radius of space is 84,000 million light-years, or 600 times the distance of the farthest visible nebula. The journey round space would take 500,000 million

light-years, and *if ever our telescopes show us the solar system from behind*, we shall see it as it was 500,000 million years ago". (The italics are ours). Thus there seems to be a chance of our descendants having a free and never-ending cinema exhibition of the events of half a billion years ago.

Sir James Jeans also writes an interesting paragraph on the creation of the cosmos (*The Universe Around Us*, p. 79). "Einstein's cosmology supposes that the size of the cosmos is determined by the amount of matter it contains. If it was decided, at the creation, to create a universe containing a certain amount of matter which was to obey certain natural laws, then space must at once have adjusted itself to the size suited for containing just that amount of matter and no more. Or, if the size of the universe and the natural laws were decided upon, the creation of a certain definite amount of matter became an inevitable necessity. De Sitter's universe is less simple or, if we prefer so to put it, allowed more freedom of choice in its creation. After the laws of nature had been fixed, it was still possible to make a universe of any size, and to put any amount of matter within limits into it. Looked at from the scientific point of view, Einstein's universe has one element of arbitrariness fewer than de Sitter's universe". Of these two universes, Einstein's seems to be the less interesting. For in the case of the de Sitter universe the Deity seems first of all to have occupied Himself with fixing the laws of nature, and *then* to have made a universe and to have put into it "any amount of matter within limits." But we do not seem to have been informed where the Deity resided before He constructed the universe.

Einstein amended his original law of gravitation (see p. 562) by inserting into the equation the "cosmical constant", the famous and mysterious λ , supposed to represent a measure of universe curvature. Here is what de Sitter, one of the foremost astronomers in the world says about it. "This [λ] is a name without any meaning. We have, in fact, not the slightest inkling of what its significance is". But Sir Arthur Eddington says: "If ever the theory of Relativity falls into

disrepute, the cosmical constant will be the last stronghold to collapse. *To drop the cosmical constant would knock the bottom out of space*".—When the bottom of space is knocked out, what will the yawning abyss reveal?

When we refer to the space of the plain man, that is the empty nothingness which remains after all material things, including even the æther, are supposed to have been removed, we should beware of calling that space either infinite or finite. *One is just as inconceivable as the other*. It may be that the presence of gravitating matter confers on the neighbouring space a structure of some kind, and that this specialized space may exist within a limitless void. But we do not really know. It is wise to assume that space is flat, homaloidal, Euclidean, uncurved, though even then we are constructing an hypothesis, simpler, it is true, than any other hypothesis, and a simple hypothesis is always safer than one which is complex. If we are honest, we shall admit that science tells us *nothing* about the nature of space; neither does mathematics. Our objective knowledge is knowledge of the material universe. All else is speculation.

And sometimes that speculation is wild.

Any sort of scale-model of the measured universe is a little difficult to think out satisfactorily, but that suggested by Sir James Jeans is worth putting on record. Let the earth's orbit of 600 million miles be represented by a circle $\frac{1}{16}$ inch in diameter. The central sun will be a speck of dust $\frac{1}{3400}$ inch in diameter, and the earth will be a still more minute speck, far too small to be seen under the most powerful microscope. The nearest star will be 225 yards away, the outer limits of our own galaxy of stars 7000 miles distant, and the farthest visible nebulae 4,000,000 miles distant. With this basic material the reader may complete the picture.

Professor E. A. Milne's views

Cambridge, as represented by Eddington and Jeans, apparently still has strong sympathies with a closed space-

time. Oxford, at least as represented by the Rouse Ball Professor of Mathematics, **E. A. Milne**, advances a much simpler hypothesis of the structure and expansion of the universe. And it is interesting to note that Einstein and de Sitter have now come to the conclusion that it is impossible to determine the algebraic sign of the curvature of "space", and that the facts of observation can be described by assigning fixed co-ordinates to a distant nebula in a quasi-Euclidean space expanding with the time. So far as I know, however, Eddington and Jeans's own views have not been substantially modified.

Professor Milne's explanation abandons the curvature of space and the notion of expanding space, and regards the observed motions of distant nebulae as their actual motions in Euclidean (flat, homaloidal) space.

He assumes a spherical region of Euclidean space (the sphere of radius r_0) occupied at time $t = 0$ by a uniform spatial distribution of particles moving with random directions with velocities distributed according to a definite law. The density is supposed to be so small that collisions do not occur, and forces of interaction are supposed negligible. Outside the sphere, space is assumed to be empty. Then the *outward* moving particles will move into the empty space outside, and the faster particles will gain on the slower. At any time t , the fastest moving particles will form an expanding spherical frontier, followed by the next fastest, and so on. The *inward* moving particles will traverse the sphere of radius r_0 , emerge at the other side, and then move outwards. Thus at any sufficiently large time t all the particles moving with a given speed V will be found between the spheres of radii $Vt - r_0$ and $Vt + r_0$. Evidently after the lapse of sufficient time, all the distant particles will have velocities of recession, and the mean velocity of recession at any distant point will be ultimately proportional to the distance, the constant of proportionality being simply $1/t$. The interior of the sphere remains occupied throughout. The density everywhere decreases with the time and the particles sort

themselves out in velocity, the sorting becoming more perfect the larger the velocity.

The restriction to an initially uniformly occupied sphere is unnecessary. The essential aspect of the hypothesis is that we are dealing with **an unenclosed system**.

The explanation applies immediately to the system of nebulae. The fastest moving ones will have velocities exceeding the velocity of escape against gravity and will ultimately pursue curves indistinguishable from their linear asymptotes.

Such a common-sense explanation renders entirely unnecessary the introduction of a curved "space". It also shows at once that the system is necessarily an expanding system after a sufficiently long time.

Milne's mathematical exposition of his hypothesis is straightforward and rigorously logical. It should be observed that Milne accepts the recession interpretation of the shifts towards the red, but he explains "expansion" on the common-sense basis as the expansion of intergalactic spaces due to the nebulae receding from one another. The outward moving frontier of the expanding sphere is marked out by nebulae dotted about the spherical surface. At any given moment the contained space is limited, though it is constantly expanding into the infinite space outside.

In the discussion on the subject at the Leicester meeting* of the British Association, 1933, Professor Milne maintained that the system of nebulae is that of a system of particles in free flight, subject to negligible gravitational influences. "The expansion is an inevitable kinematic phenomenon, and is the most natural thing in the world."

Milne recognizes that to speak of "space" itself as curved or finite is meaningless, for "space" is no objective entity.

It will be observed that Milne's universe is a little humdrum. There are no star "ghosts", nothing to excite the attention of the Psychical Research Society.

* Professor de Sitter and M. l'Abbé Lemaître were both present and contributed to the discussion. The former's general survey of the problem was masterly.

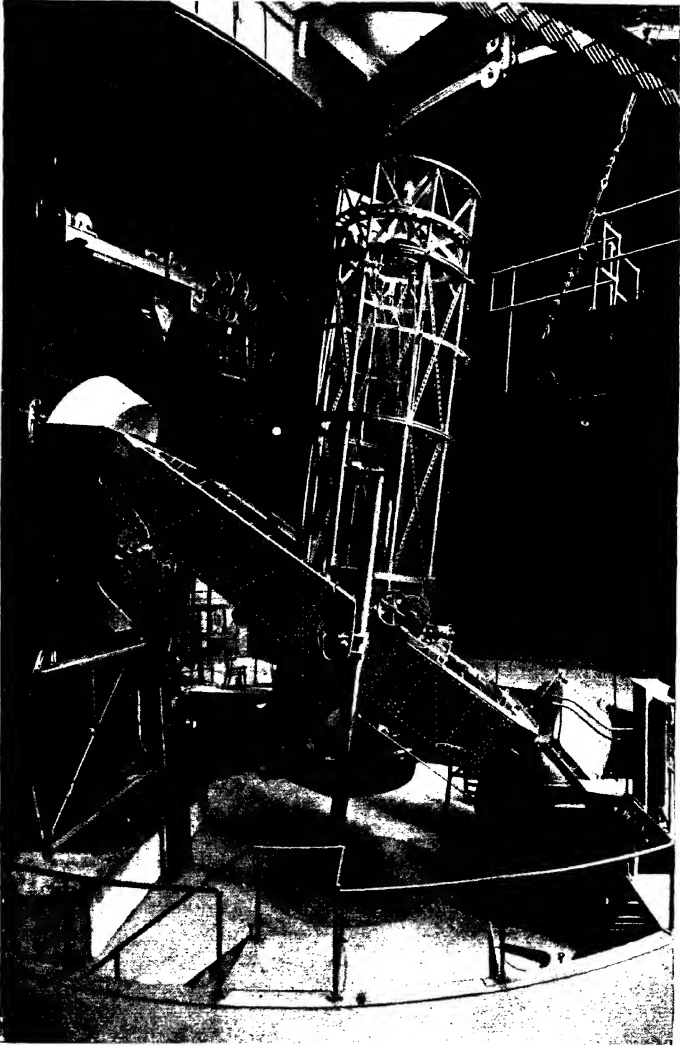

Interior of Dome, with 100-inch reflector, Mount Wilson Observatory

The Savilian Professor of Astronomy at Oxford, Professor **H. H. Plaskett**, delivered his inaugural lecture at the university on 28th April, 1933. His subject was " The Place of Observation in Astronomy ", and he referred to the great development of the theoretical method of attack in astronomical problems. To such an extent was theory now dominant, he said, that it claimed to refine observations and to be able to infer the physical conditions of regions which would be for ever inaccessible to actual observations. He showed, however, that the observational method was still the dominant one and was still likely to play at least an equal part with theory. He might perhaps have gone further and have castigated the present day tendency both to indulge in spectacular hypotheses and to extrapolate so far beyond the range of immediate experience.

The Radcliffe Observer at Oxford, Dr. **H. Knox Shaw**, now president of the Royal Astronomical Society, read an important paper on " The Observational Evidence for the Expansion of the Universe " on 25th November, 1932, at the Royal Institution. He also delivered an address " On the Distances and Motions of the Extra-Galactic Nebulæ " in February, 1933, to the Royal Astronomical Society. Both the addresses are of great weight, and all available evidence is impartially and objectively reviewed. Dr. Knox Shaw is well known as a rigorous logician.

Still another Oxford voice is that of Professor **F. A. Lindemann**, Professor of Physics in the University. His views on stellar structure command respect. Before coming to a conclusion he scrupulously reviews the available evidence.

" The Universe and The Atom "

" The Universe and The Atom " is the heading of the last chapter of Eddington's *The Expanding Universe*. Before actual astronomical observations pronounced in favour of recession, Relativity theory had predicted such recession.

But that theory could not give the amount of recession, and it occurred to Eddington to consider Relativity in connexion with Wave Mechanics. He was then able to make the necessary calculation.

He calls his solution of the problem "a new adventure". An adventure it certainly is. The chapter in question makes extraordinarily interesting reading and may be followed by anyone having an elementary knowledge of mathematics.

The radius of curvature of empty space he calls R .

The number of protons or electrons in the universe he calls N .

From the relativity theory he borrows the equation

$$\frac{N}{R} = \frac{\pi}{2\sqrt{3}} \cdot \frac{c^2}{Gm_p}$$

when G is the constant of gravitation (6.66×10^{-8}), c is the velocity of light, and m_p is the mass of a proton.

From wave mechanics he borrows the equation

$$\frac{R}{\sqrt{N}} = \frac{e^2}{mc^2}$$

when e is the charge of an electron or proton, and m is the mass of an electron.

Combining the results he finds N and R separately. For N the value is 10^{79} . From R the limiting speed of recession of the galaxies, c/R , is found immediately.

By making a simple change of unit the *second* of the equations may be written

$$\frac{R}{\sqrt{N}} = \frac{2\pi e^2}{hcm},$$

or inverting

$$\frac{\sqrt{N}}{R} = \frac{hc}{2\pi e^2} m.$$

The co-efficient $hc/2\pi e^2$ works out to 137; it is the "fine structure constant", and is a pure number.

Using this number 137, Eddington now formulates a

quadratic equation, solves it, and shows that the ratio of the two roots is the mass-ratio of the proton and electron, viz. 1847.

Thus to measure the mass of an electron, all we need do is to make astronomical observations of the distances and velocities of spiral nebulæ!

What of the reverse process?

Can it by any chance involve the fact that 137 happens to be the one number which is its own logarithm?

Astronomical Pessimism

Sir James Jeans reminds us that the sun weighed 360,000 million tons more yesterday than to-day, the difference being the weight of twenty-four hours' emission of radiation which is now travelling through space and apparently is destined to journey on through space to the end of time. The same transformation of material weight into radiation is in progress in all the stars. Is this wastage being made good elsewhere, and is the universe a cyclic system? The first Law of Thermodynamics which embodies the principle of the conservation of energy teaches that energy is indestructible. It may change from one form to another but its total amount remains unaltered through all these changes, so that the total energy of the universe remains constant. Energy continually changes in *form*, and, generally speaking, there are upward and downward directions of change, but the latter are far more usual than the former. For instance, both light and heat are forms of energy, and a million ergs of light energy can be transformed into a million ergs of heat with the utmost ease; but the reverse transformation is impossible. According to the second Law of Thermodynamics, heat cannot itself pass from one body to a hotter body. A gradual cooling down is inevitable. The general principle is that radiation energy tends always to change into a form of longer, not shorter, wave-length.

Energy cannot, however, run downhill for ever. It will

eventually reach the bottom rung of the ladder. The energy is still there but it has lost all capacity for change. The final state of the universe will, says Jeans, be attained when every atom which is capable of annihilation has been annihilated and its energy transformed into heat energy wandering for ever round space. The universe will have run down. The total annihilation of all the matter of the existing universe would only fill space with energy enough (Jeans adds) to raise the temperature of space from absolute zero to $1/6000$ of 1° centigrade. Space is so vast that the annihilation of all the matter it contains cannot warm it up more than that.

Eddington's estimate of the initial radius of the universe is 1068 million light years, and, according to Jeans, matter was created about 200 billion ($2 \cdot 10^{14}$) years ago, though how it had been wound up in readiness to run down we are not told. Anyhow, a start was made, and Eddington has told us all about the rate of subsequent expansion. And here we are.

Eddington is quite cheerful about the end of things, though he does not tell us in very plain words if time and space are to be annihilated. "I would feel more content that the universe should accomplish some great scheme of evolution, and, having achieved whatever may be achieved, lapse back into chaotic changelessness than that its purpose should be banalized by continual repetition. I am an Evolutionist, not a Multiplicationist. It seems rather stupid to keep doing the same thing over and over again."

Astronomical Optimism

Both Eddington and Jeans disagree with the possibility of an ultimate reversal of the running down process, that is, of a building up again or the re-creation of the universe. But Dr. **Robert Andrew Millikan** of Pasadena, recognized as one of the ablest of American physicists, is of a contrary opinion. Millikan was the discoverer of the *cosmic rays*, the shortest electromagnetic waves known, and he holds the view that these rays have their origin in the process of the creation

of complex atoms from simpler atoms in the stars themselves.

In 1909 **Gockel** took an electroscope up in a balloon to a height of $4\frac{1}{2}$ kilometres and found that its rate of discharge was much greater at that height than on the earth, showing that there were rays whose origin was outside the earth. Later, Millikan himself went up to a height of $15\frac{1}{2}$ kilometres. Three main points about the rays were definitely established: (1) the intensity of the rays is practically uniform day and night, and they are therefore independent of all celestial objects; they seem to come from inter-stellar space; (2) they are not influenced by the earth's magnetic field; (3) the rays are extraordinarily penetrating and "hard", but at $15\frac{1}{2}$ kilometres up it was found that not all the cosmic rays are equally penetrating; at that height there are "soft" cosmic rays which do not penetrate through the whole of the atmosphere.

The soft cosmic rays have an energy of 25,000,000 volts, being ten times as intense as the radio-active gamma rays of thorium, and they will pass through five times as much water.

Millikan gave good reasons for his belief that there is no atomic transformation which can furnish the necessary energy except an *atom-building* process, and that the cosmic rays are wireless signals of the building in interstellar space of at least some of the heavier elements out of the lighter. There is of course experimental evidence that the various elements are built up from hydrogen and helium, the atom of helium being built out of the four atoms of hydrogen.

In 1933, Professor **A. Piccard** of Belgium ascended to a height of over 10 miles (16 kilometres) for the purpose of experimenting on cosmic rays. Two distinct types of observation were made: (1) to determine the variation of intensity of the rays with height; (2) to determine the distribution of the radiation in different directions. His results agreed fairly closely with those of Professor **E. Regener** of Stuttgart, who a little while before had measured the intensity of cosmic rays in the high atmosphere, at air pressures down to 22 milli-

metres of mercury, by means of two rubber balloons and a self-registering electrometer. Another ascent was made on 30th September, 1933, by the Russian **Prokofieff** from Moscow, in the Soviet balloon "Stratostat S.S.S.R." A height of 19,000 metres (nearly 12 miles) was reached. In November, 1933, two Americans, **Settle** and **Fordney**, went up from New Jersey and reached a height of 59,000 feet (11 miles). At a depth of 750 feet below the surface of Lake Constance, **Regener** found the cosmic rays extremely "hard"; and at a depth of 1650 feet in the salt mine of Stassfurt in Prussia Professor **W. Kolhörster** found them still harder.

No definite conclusion has, however, been arrived at as to the actual origin of the rays. Facts of importance are now gradually being accumulated by Professor **A. H. Compton** and others.

In his inaugural address on "Cosmic Rays," delivered at Birkbeck College, London, 2nd November, 1933, Professor **P. M. S. Blackett** gave a comprehensive survey of the history of the subject. He said it is certain that in high altitudes particles of energy 10^{10} electron volts are entering the earth's atmosphere, the majority of them positively charged. He estimated that those positive electrons which are so rare on earth fill the universe and constitute a thousandth of its mass.

Admittedly all radiation has its origin in a gross number of individual atomic disturbances of one sort or another, but what may be the particular atomic disturbance that gives rise to cosmic rays still baffles men of science. There are, however, two main theories. One finds the origin of the cosmic rays to be the *annihilation* of matter, and another finds it to lie in the *building up* of matter—of helium and other elements out of hydrogen. The theories are diametrically opposed, yet mathematical reasons can be given in support of either, and inasmuch as there are degrees of hardness or penetrating power, in the rays, both may be true. The real point of interest is the search for an answer to the question whether the universe is steadily running down or continually

being built up. Eddington and Jeans are all for the running down; other equally eminent authorities are for the building up. At the moment the latter certainly are in the ascendant.

There is thus no reason to despond.

It should be remembered that we know very little about the nature of light, and very little indeed about the nature of radiation.

All the universe makers seem to have built up their systems on the assumption that radiation from the sun or a star is uniformly propagated in space. Professor **F. Soddy**, professor of chemistry at Oxford, pertinently asks (*Nature*, 21st February, 1931, 5th September, 1931) whether there is any evidence whatever for such an assumption. It is strange how many unverified assumptions underlie many of the basic theories of science.

BOOKS FOR REFERENCE:

1. *The Nature of the Physical World*, A. S. Eddington.
2. *Stars and Atoms*, A. S. Eddington.
3. *Space, Time and Gravitation*, A. S. Eddington.
4. *Astronomy and Cosmogony*, J. H. Jeans.
(The above are standard works of great weight.)
5. *The Universe Around us*, J. H. Jeans. (A lighter work, full of interest.)
6. *The Mysterious Universe*, J. H. Jeans
7. *The Expanding Universe*, A. S. Eddington.
8. *Kosmos*, W. de Sitter. (An admirable exposition of de Sitter's views.)
9. *Modern Cosmologies*, Hector Macpherson.
10. *Observational Evidence for the Expansion of the Universe* (Royal Institution Address, 25th November, 1932), H. Knox Shaw.
11. *Distances and Motions of the Extra-galactic Nebulæ* (Address to the Royal Astronomical Society, February, 1933), H. Knox Shaw.
12. *World Structure and the Expansion of the Universe* (*Nature*, 2nd July, 1932), E. A. Milne.

CHAPTER XLI

Geology and Geophysics

As a branch of inductive science geology is still comparatively young, although it is clear from the writings of Pythagoras and Strabo that the phenomena with which the subject deals claimed some attention in very early times. The belief of Oriental cosmogonies in the alternate destruction and restoration of the world may well have been the result of the observation of the occurrence of sea shells in rocks far removed from the sea. In the tenth century, fossil shells were regarded as evidence of geographical changes, and in the seventeenth and eighteenth centuries such shells were looked upon as relics of the Noachian deluge. In the eighteenth century geology showed definite signs of systemization, especially in Italy; and in 1760 **John Michell** (1724-93), a Fellow of Queens' College, Cambridge, wrote an important work on earthquakes. In 1775, **Abraham Gottlob Werner** (1750-1817), Professor of Mineralogy at Freiberg in Saxony, determined the order of succession of the strata in the Hartz mountains, and his contention that the classification was applicable to the sedimentary strata of the whole world established a definite geological principle. Werner looked upon the igneous rocks as chemical precipitates, but **James Hutton** (1726-1797), a Scottish geologist, upheld the igneous origin of those rocks, and a great controversy arose between the Wernerites and the followers of Hutton, the Neptunists and Vulcanists as they were called. The latter maintained that the records of the past were to be

interpreted only by understanding the methods of nature at the present.

The foundations of stratigraphical geology were laid by **William Smith** (1769–1839), an English surveyor and canal engineer working in the neighbourhood of Bath. Smith observed that each group of stratified rocks which came under his review was characterized by its contained fossil remains. By thus establishing this far-reaching geological principle, he gained for himself the title of “The Father of Geology”. In 1815 he published a geological map of England. This map, together with Hutton’s *Theory of the Earth*, and Hutton’s canon that the best interpreter of the past is the present (the doctrine of “uniformitarianism”), were the inspiration of **Sir Charles Lyell** (1797–1875), Professor of Geology at King’s College, London, whose great revolutionary work, *The Principles of Geology*, was published in 1830. It was Darwin himself who said, “The science of geology is enormously indebted to Lyell—more so, as I believe, than to any other man who ever lived.” The Geological Society had been formed in 1807, and under Lyell’s influence it did much to discountenance speculative views; it urged caution, advised the accumulation and recording of observations, and stressed the fact that time was not yet ripe for forming theories of the earth. The study of the palæontological side of geology was greatly stimulated by the publication of **Charles Darwin’s** *Origin of Species* in 1859, and that of the petrographical side by the researches of **Henry Clifton Sorby** (1826–1908).

The remarkable advances which geology has made during the present century are due to the laborious work of a large number of well-trained and able observers. There are unfortunately signs of a recurrence of an indulgence in speculative hypotheses, especially on the side of geophysics.

Present-day geology has to keep in very close touch with astronomy, physics, and chemistry, as well as with botany and zoology. Although its own special territory is mainly the outer rocky shell of the globe, it seems to be ever branching

out in new directions. A competent geologist has to be even a mathematician, as a glance through any serious book on geophysics immediately shows. During the latter part of the nineteenth century geologists were beginning to direct attention to definitely different branches of their subject, for instance to structural, dynamical, palæontological, or stratigraphical geology, and every branch has now developed to such an extent, and so many new branches have grown up, that it is exceedingly difficult for any one person to master the vast mass of facts which have been accumulated. Nevertheless geology remains essentially an *observational* branch of science. Geologists cannot be trained in a laboratory. The work they have to do in the laboratory—and they now have to do much—is complementary and supplementary to their field work.

The beginner in geology should make himself acquainted with the fundamentals of stratigraphy. Some such table as that on p. 683 is easily memorized and serves afterwards to place newly acquired facts into a proper perspective. But the beginner should above all things spend a few days with a trained geologist in the "field", in a mountainous or hilly district if possible, though much can be learnt from quarries, railway cuttings, and from sea-cliffs and beaches. His equipment need include little more than hammer and chisel, knife, magnet, lens, and (for testing carbonates) a small bottle of hydrochloric acid. He should make himself thoroughly familiar with the lie of strata and the appearance of different kinds of rocks. He should realize at the outset that most of the rocks have been formed under water, and he should try to understand the evidence of this, and how such evidence is quite unmistakable. But he should also understand that the rocks now visible on the earth's surface are seldom to be seen in their original position. Even a cursory examination reveals convincing evidence of movement. The strata nearly always make an angle with the horizontal, and sometimes stand vertically: how have they been disturbed? There is

little difficulty in finding examples of dip, outcrop (the edges of strata which appear at the surface of the ground), synclines, anticlines, inversion, crumpling, contortion, and the like. When the beginner has actually seen examples of these kinds of disturbance, he will be able to approach the subject with a far clearer understanding of what he is dealing with than would be possible from diagrams and pictures. A geologist's eye can be trained only in the field.

But as his name implies, the geologist's ally—the geophysicist—is largely a worker in the laboratory. The earliest synthetic work on the chemistry of igneous magmas and rocks was accomplished by **James Hall** (1811–98), an American State geologist, who actually melted and recrystallized rocks in the laboratory, and investigated the conditions of temperature and pressure that resulted in the recrystallization of limestone. He heated powdered chalk in gas-tight gun-barrels and converted it into a crystalline mass of calcite, thus supporting the contention of Hutton that heat and pressure had consolidated limestones and converted them into marbles. In 1878 the French petrologists **Fouqué** and **Michel Lévy** began their extensive researches on the synthesis of minerals and rocks by pyrogenetic methods, and they succeeded in producing, by the use of a gas furnace and a nitrogen thermometer, such rocks as porphyrite, basalt, and dolerite, even obtaining the characteristic textures by modifying the conditions under which the melts were cooled.

During the present century, a long line of experimenters has followed on, but the elaborate equipment now required for physico-chemical investigations in petrology is too costly for much to be attempted at our own universities. On the other hand the Geophysical Laboratory at Washington has to its credit a wonderful record of recent achievement. The feature of this work at Washington is that it is quantitative, not merely qualitative. The natural process operating in rocks may have extended over a temperature region to 1400°, an enormous range over which to extend the application of laboratory methods, and one likely to threaten the apparatus

with destruction. The electric pyrometer has, however, now reached such precision that an error of one or two degrees is all that need be expected in measuring temperatures up to 1600°. Moreover, such temperatures can be steadily maintained for days or weeks at a time. It is, of course, taking a great leap in the dark to assume that small-scale operations in the laboratory are accurately representative of the large-scale operations of nature, but there is common agreement that the evidence thus provided is eminently suggestive and confirmatory.

Nor must we forget another valuable, if older, aid with which the petrologist provides the geologist. It was Sorby who first produced very thin sections of rocks for examination under the high powers of the microscope. To-day the densest, blackest rock can be made to yield a section of 1/1000 inch in thickness, so thin and transparent that fine print can be easily read through it, and transmitting light so clearly that the highest powers of the microscope can be used for examining the minute structures it presents.

The petrologist can hardly, however, be considered a geophysicist, except in a very restricted sense. The term geophysics is not a term with a very definite connotation. Literally it means "earth-physics", but it is usually made to include theories of the origin of the solar system, theories of the formation of the earth's crust, the theory of isostasy, tidal theory, the thermal history of the earth, terrestrial magnetism, atmospheric electricity, meteorology, and a few other subjects. Some of the theories involve the application of advanced mathematics.

We cannot afford space to touch upon more than a very few topics:

- (1) The Origin of the Earth.
- (2) The Infancy of the Earth.
- (3) The Age of the Earth.
- (4) Earthquakes.
- (5) Applied Geophysics.

1. The Origin of the Earth

Of the several hypotheses put forward, only two have commanded serious attention.

1. *The Rotational Hypothesis.*

Pierre Simon, Marquis de Laplace (1749-1827), born in humble circumstances near Trouville in Normandy, became one of the very greatest of French mathematicians and astronomers. Certain remarkable facts concerning the planets seemed to him to point unmistakably to the probability of the members of the solar system having a common origin: (1) all the planets and all the planetoids move round the sun in the same direction, and most of the satellites move round their planets also in that direction; (2) the planets, as far as they can be observed, rotate on their axes and in the same direction as they revolve round the sun; (3) all the planets and many of the planetoids have their orbits very nearly in the same plane, just as if they were swimming round the sun all half immersed in some vast ocean, though it is true that some of the planetoids rise above and fall below this plane. Laplace pointed out that the solar system "offers 37 movements whose planes are inclined to that of the solar equator by at most a right angle. Supposing that their inclinations are due to *chance*, they could have extended to two right angles; and the probability that at least one of them would have exceeded one right angle would be $1 - \frac{1}{2^{37}}$ or $\frac{137438953471}{137438953472}$. It is then extremely probable that the direction of the planetary movements is not at all the effect of chance." More recently it has been calculated that the odds against the uniformity of the various movements of the (say) 500 bodies being due to any other cause than that of a common origin in the sun is about 10^{100} to 1. Such an extraordinarily high degree of probability amounts to virtual certainty.

Laplace assumed the existence of a primeval nebula

which originally extended so far out as to fill at least all the space equivalent to that within the present orbit of Neptune, the sun being the central and the more condensed portion, and the whole rotating on its axis. As the mass cooled it must have contracted towards its centre, and as it contracted it must, according to dynamical principles, have rotated more rapidly. The time would therefore come when the centrifugal force (if we may still use the term) on the outer parts of the mass would more than counterbalance the gravitational attractive force towards the centre, and the outer part would thus be thrown off as a ring. The inner portion would still continue to contract, and the same thing would be repeated. Thus the planets would be born. The materials of each ring would continue to cool and contract and would (it was assumed) tend to aggregate into a spherical mass round some centre of maximum condensation. Uniformity of direction and rotation was thus accounted for.

The hypothesis seemed to be supported by the existence of rings around Saturn, and by different stages of condensation observable in some of the great spiral nebulae. But Laplace never considered his hypothesis quantitatively, and it hopelessly breaks down at the first touch of mathematics. For instance, one of Laplace's fundamental assumptions was that the original nebula had a certain rotation when it was in its most expanded condition, and that, to preserve the value of its rotatory momentum, its rate of rotation increased with the shrinkage due to cooling. Now the constancy of the rotatory momentum in such a system is a definitely established dynamical principle, and it is possible to calculate not only the diameter of the original nebula, but also the velocity of the equatorial rotation at each stage when a ring is assumed (according to Laplace's hypothesis) to have been thrown off. When the nebula had contracted to the present diameter of the sun, it ought, by such calculation, to have had a velocity of 270 miles a second. Actually, its velocity is now only $1\frac{1}{3}$ miles a second. There is no way of accounting for such an enormous discrepancy.

There are other equally weighty objections. For instance, each planet is supposed to have acquired, by some unspecified process, a rotation in the same direction as its revolution, and the condensation of the planets is supposed to have led afterwards to the formation of systems of satellites by the same mechanism as produced the planets. But eight of the satellites now known revolve in the opposite direction, a fact which is quite inexplicable by the hypothesis. Another unsolved difficulty is that of a ring breaking up and collecting into a sphere. Even if a large nucleus were formed at some point in the ring, to serve as a collecting centre, it is improbable that it would gather to itself bodies from a sector greater than one-sixth of the ring.

These and other objections have proved fatal to Laplace's nebular hypothesis. No astronomer any longer accepts it.

Professor **Harold Jeffreys** of Cambridge, the leading geophysicist in this country, says: "The theory of rotational instability is not a possible explanation of the origin of the solar system. It has been proved by **Jeans** that a nearly homogeneous mass broken up by rotational instability would give rise to a double or multiple star, the masses of the components being comparable; while a mass with a strong central condensation, if it condensed elsewhere at all, would probably give a spiral nebula, the arms consisting of streams of stars, each with a mass comparable with that of the sun. In neither case would anything resembling the solar system be produced."

Mathematics shows clearly that the hypothesis simply will not work.

2. *The Tidal Hypothesis.*

Professor **Thomas Chrowder Chamberlin** (1843-1928), formerly Professor of Geology at the University of Chicago, assisted by a colleague, Professor **F. R. Moulton**, put forward an hypothesis in 1916 which met with almost universal acceptance. We give an outline of it:—

Any acceptable hypothesis of the origin of the solar system must stand the tests of known dynamical laws, and, in framing it, it is necessary to bear in mind that:

(1) Our planetary system consists of a number of bodies revolving round a primary in an approximately invariable plane;

(2) The total mass of all the revolving bodies is only $1/745$ of that of the primary, the sun;

(3) If the sun and the planets are the divided parts of a common nebula, the process of partition must have been such as to result in this very unequal division in this very specific form;

(4) The flatness of the discoidal form of the system points to some powerful genetic agency competent to enforce on the system the geometrical configuration it now bears;

(5) The hypothesis must provide for deviating agencies to explain the departures from symmetry in the discoidal form, especially as regards the eccentricities and inclinations of the orbits;

(6) The invariable plane of the planetary system formed by the algebraic summation of the respective planes of the various members of the system is inclined to the plane of rotation of the sun, though gravitatively the sun is the controlling body and possesses $744/745$ of the entire mass of the system;

(7) Although the sun possesses such a very large proportion of the mass, it carries less than 2 per cent of the revolutionary momentum of the system. The remaining $1/745$ of the mass carries more than 98 per cent of the momentum;

(8) Certain directions of revolution are retrograde.

Professor Chamberlin put forward an hypothesis satisfying all these points. It was suggested by considerations of the consequences of disruption due to the too close approach of two stellar bodies. It is conceivable that if only a portion of one of these bodies was disrupted, the remainder might, by its attractive force, control the dispersion, and, continuing

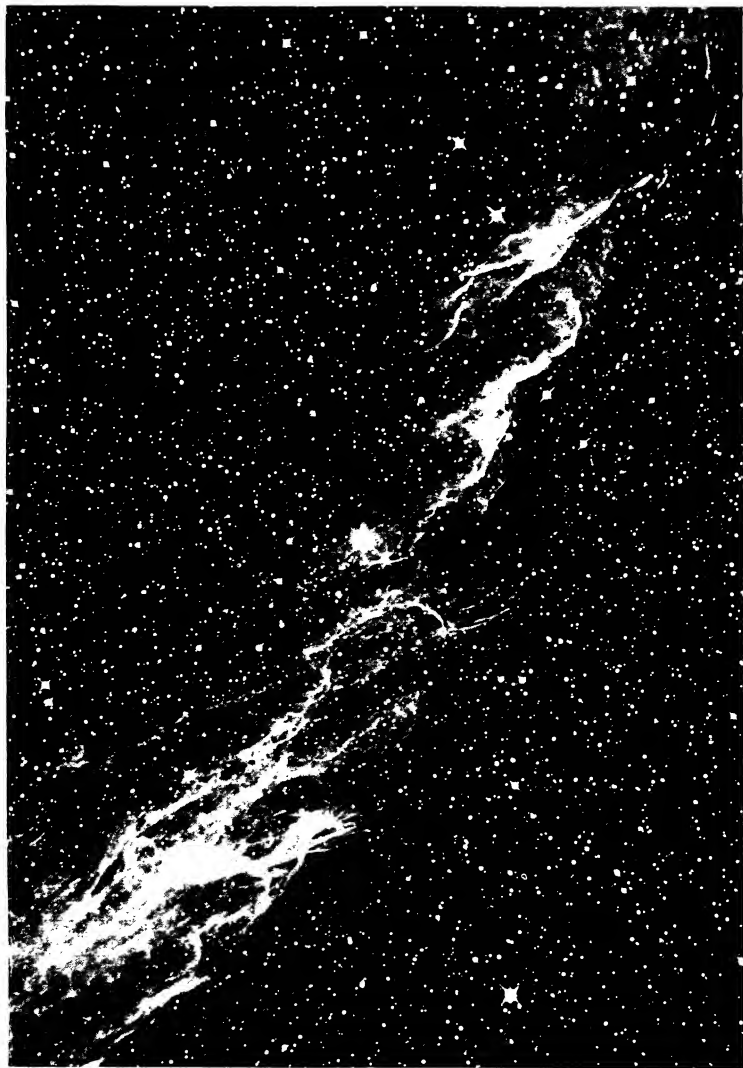

Larger Network Nebula
Mount Wilson Observatory

its own orbital journey, draw the scattered material after it, not unlike a tail, with an increasing curvature impressed upon it.

In the sun there is known to be such a persistent eruptive tendency that huge masses from the interior, conveniently termed "sunbolts", are frequently shot forth at velocities of 100 miles or more per second, and they often rise some thousands of miles above the glowing surface. This constantly takes place without any obvious outside attraction. If at any time there happened to be a sufficiently strong outside attraction, such as that of a passing star, bolts of greater mass would be ejected with greater violence. Thus from so simple a cause as the gravitational attraction of a star approaching the sun, there may arise a series of violent eruptions graded according to the closeness of approach. Each of the ejected masses will swing into an orbit of its own, the particular orbit being determined by the forces of attraction brought into play by the changing relations of the two bodies, both of which are necessarily in rapid curving motion relative to each other. No very close approach of the star would be required in order to call forth a very great response in such a highly eruptive body as the sun, but only relatively small ejections for the birth of the planets were necessary, for only $1/745$ of the sun's substance was required for the whole planetary system of many hundred bodies; the average mass of the planets alone is only $1/6000$ that of the sun. Thus it may be assumed that the passing star kept well away from the sun; also that it was so large, dense, and inert that its own response to the reaction of the sun was negligible.

The attraction of the star would gradually increase to a maximum at the position of closest approach, and then diminish. Its general effect at any one time would be that made familiar by the study of the *tides*, for the attraction would reduce the gravitational pressure in the interior of the sun along the line joining the centres of the star and sun, and there would be a *tidal response* which would take the form of conical bulges on each side, one towards the attracting

star and one on the opposite side; and, according to the law of least resistance, the bulges would tend to allow the eruptive forces within the sun to ease themselves along the lines of this reduced pressure. Eruptive action would thus take place in the direction of the axes of the bulges, and, in accordance with tidal principles, one set of bolts would be shot out directly towards the passing star and another set, rather smaller, in the opposite direction.

While a bolt is moving out and falling back, it would be drawn aside in the direction of movement of the passing star, since the pull of the star is always moving to a new line directed from its new position. A tangential element is thus introduced. The relative amounts of the forward and tangential pulls are obviously dependent on the distance to which the bolt is projected. For instance, the bolt may actually fall back into the sun, just as ejected bolts are doing every day; but it would carry with it such transverse momentum as it had gained by the forward motion imparted to it by the pull of the star; its only effect would be slightly to increase or to retard the sun's rotation. But if the ejected bolt were pulled sufficiently far forward by the star, it would, on its return journey, fail to strike the solar disc, and, sweeping by, would swing into an elliptical orbit about the sun.

When one star passes another, each causes the other to deviate from its straight course. At long distances the deviations are slight, but the closer they approach the greater the curvature; and, during the stages of their nearest or perihelion approach when their speeds are greatest, their relative positions are rapidly changing. The tidal bulges are therefore caused to shift their positions rapidly, as well as their directions in space. Hence, in the particular case now under consideration, each of the succession of bolts ejected from the sun must have taken on a new direction, and, of mechanical necessity, the chain of bolts must have assumed the form of a spiral.

The planes of the orbits of all the projectiles must obviously lie in or near the plane of movement of the passing star,

the whole group of orbits forming a discoidal configuration. It seems, however, to be in the highest degree improbable that this plane should coincide exactly with the plane of the rotating sun's equator, for there is no reason to think that the respective motions could be otherwise than absolutely independent.

It is assumed that, at the time of the birth of the planets, or rather the birth of the knots which acted as collecting centres for the planets, the greater eruptions of the sun were, as now, concentrated in *two belts* not far from the solar equator. It is also assumed that, as the star approached from a distance, its first feeble pull led to the ejection of only small bolts which, for the most part, fell back on the sun, merely modifying his rotation. With nearer approach, some of the projectiles would, on their return, fail to strike the sun's disc and would swing round into orbits. So far, the pull of the star is assumed to have been mainly on the polar regions of the sun and therefore oblique to his equatorial belts of great eruptions; but when the star approached the perihelion part of its path, it would pass directly over the first belt of these great eruptions, and a maximum co-operation between the star and sun would thus be realized.

Nearly simultaneous bolts would now issue from the proximate and distal sides of the sun, and the first pair of great planets, viz. Neptune and Uranus, would be born. At the crossing of this first eruptive belt, the action would be particularly effective, for the stored-up eruptive energy within the sun would be at a maximum, and the bolts would be projected with great velocity. A second pair of great eruptions is assigned to the stage when the second belt of solar eruptions, on the farther side of the solar equator, was crossed, and Saturn and Jupiter were born. As the star passed on in its perihelion curve towards the polar latitudes of the sun, its action once more would become very oblique to the solar equator; nevertheless, the maximum approach which would here take place would lead to a multitude of imperfectly associated eruptions giving rise to the planetoids. The star

having taken its perihelion turn, its return journey over the two solar eruptive belts would be attended by the eruption of two more pairs of bolts giving rise to the four interior and smaller planets, first Mars and the Earth, and secondly, Venus and Mercury; and, with these, the larger order of eruptions would cease, though many smaller eruptions, like those which attended the early approach, would continue until the star's pull became inappreciable. But from first to last myriads of small bolts would be ejected, these scattered products of dispersion giving rise to the planetesimals. The whole process must, of course, have extended over a vast period of time; even at perihelion the passing star must have been a stupendous distance away.

It is thus assumed that the solar system was originally a spiral nebula—a pair of spiral arms of nebulous matter shot out from the sun, studded with knots. Although a spiral form was, of mechanical necessity, at first imposed upon the chain of knots, each knot pursued an independent elliptical orbit of its own.

When the earth-bolt was about to be lifted from its place deep in the sun, it must have been gaseous or potentially gaseous, and it must have contained all the chemical substances present in that part of the sun from which it came. On being ejected into the approximate vacuum of surrounding space, it must have undergone great expansion and great reduction in temperature. But the mean specific gravity of the earth is now high (5.5), and the greater part of it must therefore be made up of far heavier materials than the surface atmosphere and hydrosphere. Few of these heavy substances could remain gaseous except at very high temperatures. We therefore infer that the more refractory materials on emerging from the sun into the cold of space probably condensed to the liquid or solid state. Despite an original tendency to dispersion due to the projective force outwards, gravity must have effected the concentration of a considerable portion of these heavier materials. The very existence of the knots implies this, dynamically. It seems probable

that the greater part of the nebulous matter controlled by the ejected earth-bolt gathered into a knot soon after emergence and became the collecting centre of further material.

It was inevitable that the main bolts ejected from the sun should have been attended by great fragments torn from them during their eruption, and that these should, under the control of the main masses, have taken on independent orbits. These were the knots of future satellites.

Of course this tidal hypothesis of Chamberlin's is only an hypothesis, but it seems to cover all the facts and to satisfy all dynamical principles, and this cannot be said of any other hypothesis yet put forward. It has been put to various mathematical tests, such factors as known masses, velocities, distances, ellipticities, and inclinations, all being considered; and in every case the result has been to confirm the probability of the truth of the hypothesis. Analogical evidence from observations of the spiral nebulae is also wholly confirmatory.

But although this particular tidal hypothesis has been generally accepted in principle, it has been criticized in detail. Professor **Harold Jeffreys** revises the hypothesis in certain important respects. For instance, Chamberlin believed that the planets would cool chiefly by adiabatic expansion, but Jeffreys shows that at any rate the larger ones would cool chiefly by radiation from the surface. Chamberlin also asserted that all the planets, large and small, would form liquid drops at once, that these would quickly solidify, and that the planets formed by the aggregation of the solid particles would themselves be solid from the start; Jeffreys shows that, in whatever way the planets cooled, they would always pass through a liquid stage. Further, Chamberlin supposed that two spiral arms (tails, filaments) were formed, projecting from the sun at diametrically opposite points; Jeans, our leading cosmogonist, has shown how it is possible that only one filament was formed, and Jeffreys' modified theory is worked out on the basis of only one. It is quite possible

that even if a shorter one was ever formed it was wholly reabsorbed into the sun.

Jeffreys' arguments are weightily supported by mathematical considerations and are convincing. He does not see quite eye to eye with Jeans, but the differences of opinion are negligible. We may give a few of his more general points: they are illuminating.

“The fundamental feature of the hypothesis is the approach to the sun of a star considerably more massive than itself. This raised two large tides on the sun, the greatest protuberances being at the points of the sun nearest to and farthest from the star. When the distance between the two bodies became sufficiently small, the tendency to disruption due to the difference between the attractions of the star on the two opposite sides of the sun became greater than the sun's gravitation could counteract, and a portion of the sun was torn away. This afterwards condensed to form the planets and the satellites.”

Jeffreys is particularly convincing when he is dealing with the neutralization of the sun's own gravity by the greater gravitational pull of the passing star.—There comes a moment when the sun's own pull of its own matter towards its own centre ceases. With the closer approach of the star, the pull is reversed in direction, and the matter of the sun is gradually drawn out in the form of a tidal cone, first squat and then sharper, at a point in the direction of the star. This tidal rise will continue until the star has receded again to such a distance that its gravity is no longer enough to neutralize that of the sun. The star's maximum pull is, of course, at the point of nearest approach. The conical tidal bulge is always in a line with the star and the centre of the sun.

The star pursues an independent path, and moves transversely as well as towards the sun. Hence any portion of the tidal cone which has broken away, though first moving directly outwards, will soon be attracted sideways by the star which in the meantime has moved on in its own course. Thus the detached mass will acquire a velocity round the

sun as well as away from it. Figure 139 is a slightly modified form of the figure which Jeffreys gives to illustrate his argument.

The long arrow-headed curve shows the orbit of the passing star, three successive positions of which are at S_1 , S_2 , S_3 ; NS is the rotating nebular sun showing successive tidal cones at

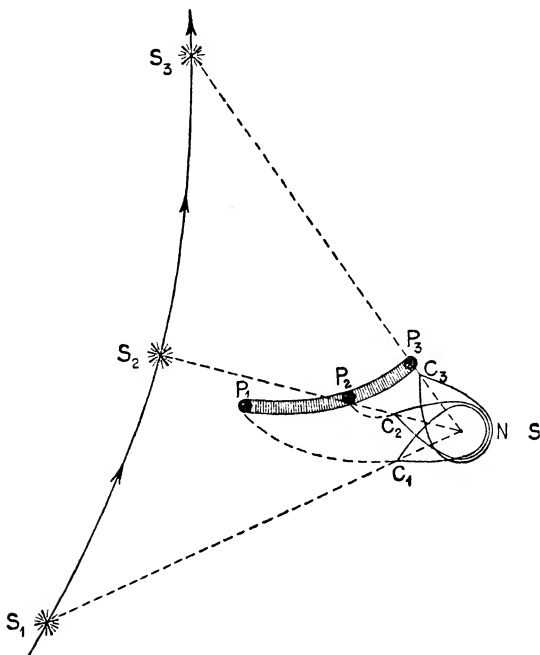

Fig. 139

C_1 , C_2 , C_3 , as drawn out by the star at S_1 , S_2 , S_3 , respectively, to which the cones directly point; P_1 , P_2 , P_3 , are masses detached from the successive tidal cones by the star when at the three positions shown. The figure is much exaggerated for the sake of clearness. Of course the pull is continuous, and the ejected mass is continuous, but for simplicity only three separate masses and their positions are shown. The ejected mass as a whole eventually takes the form of a continuous

filament, something like a nebular spiral arm or tail, a sort of long boomerang-shaped cylinder (shaded in the figure). It should be observed that the point where the ejection takes place is always necessarily immediately towards the star, and is therefore continually changing as the star moves. The tidal cone is exactly analogous to the tidal hump which travels across our own oceans in obedience to the pull of the moon; there is no *current* either of water in the ocean or of solar matter in the sun, only a travelling wave. The parts of the ejected mass all start from different positions and therefore travel on different paths; they do not follow one another on the same path, as might at first be thought. The paths C_1P_1 , C_2P_2 , and C_3P_3 should be noted.

Before reaching the position S_1 , the star must have raised a tidal cone in the sun, but not enough to bring about actual disruption; the cone fell back as the star passed on, and new cones, one after another, continuously took its place, until at last the pull of the star became so great that the first mass broke away. The pull would become stronger and stronger as the star approached its nearest position to the sun. Jeffreys thinks that as soon as the star passes S_2 and is therefore in retreat, no further matter from the sun could have been permanently ejected, though this seems uncertain: there are so many unknown factors. Certain it is, however, that even some of the matter which had been ejected during the star's approach fell back; only that part which had acquired a sufficient transverse velocity to travel in an orbit of its own would remain permanently detached.

So far, we seem to have a single planet, but in the obviously impossible permanent form of a long filament; this filament consists of $1/746$ the mass of the sun and is the future parent of eight planets and their satellites and a host of smaller children. But we really ought not to picture the breaking away from the sun of a single filament of this kind; it probably came away in parts, each part representing a future planet. Jeans has shown that condensation of a gaseous filament would begin when the length of the strip reached a particular value;

the ejected portion would then begin to detach itself from the main body and soon would lead an independent existence as a planet. But the pull of the star and therefore the ejection of the filament would continue, and other planets would be formed until the disturbing pull became so reduced that the sun's own gravitational action sufficed to counteract it.

Most of the satellites were probably formed by the tidal disruption of their primaries by the sun.

The mutual gravitation of the parts of a great gaseous planet would hold it together, but radiation from the surface would gradually bring about liquefaction. Since cooling would take place at the outside, drops would be formed there and would fall inwards under gravity. They would collect, the densest naturally finding their way to the centre. In due course, solidification would set in.

The smaller planets and the satellites probably had a more complicated history.

The assumption that the star exerts a gravitational "force" or "pull" is admittedly of Newtonian origin. The hypothesis of such a gravitational pull, though possibly wrong, is at present much more acceptable than the rather fantastic hypothesis of any sort of gravitational space-curvature. How could space-curvature bring about parturition? It had not yet suffered its own birth-pangs.

2. The Infancy of the Earth

Professor P. G. H. Boswell of the Imperial College of Science says: "Geology makes contact with astronomy at an early stage in the history of our planet, when the astronomer hands over the new-born earth for the consideration of the geologist. We accept the astronomer's assurance that its birth was an extremely unusual, if not almost unique, event, in that it was procreated in the mere approach of solar parents and suffered gestation in a hypothetical tidal disruption. By a process of condensation and sweating, its

constituent matter became arranged in the concentric shells that allowed life to develop on the surface and provided there the means of its maintenance. The earth's history has been that of a pulsating globe, its crust subject both to disturbances that have originated below that surface and to modifications that have arisen from the interplay of the successive spherical shells known as the lithosphere, hydrosphere, and atmosphere."—What were the successive happenings between the time of the earth's birth and the first appearance of life? Scores of volumes have been written in reply to this question and many ingenious explanatory hypotheses have been put forward, but we are still without definite answers either to that main question or to other questions closely associated with it. For instance, are the present continents much the same as they have always been or have there been great changes? What is the origin of the vast quantity of water on the earth's surface, and why does it now remain constant? Why do not the mountains, with their enormous weight, break through the earth's crust, and how does the same crust support the enormous weight of water in the ocean beds? Numberless questions of this kind may be asked, and any answers that may be given are necessarily mere guesses, though we may give them the more dignified title, "hypotheses". All the explanatory hypotheses of the early history of the earth, and there have been many, are, at most, *possible* explanations, though they differ much in degree as to the *probability* of their being accurately representative of the facts.

William Thomson, Lord Kelvin (1824–1907), was a recognized authority on the Properties of Matter, and his view as to the manner of solidification of the earth is still accepted. Most rocks contract in cooling, and the first step in the solidification of the liquid globe which had condensed from the original nebular gas would be the formation of a thin superficial crust of higher density than the liquid below it; this would be unstable and would therefore break up and sink until melted again. The process would be repeated until so much of the heat of the interior would be used up

that solid fragments would no longer so readily tend to melt. But as the newly formed solid sank, it would be exposed to greater pressure, and its temperature would rise through compression, and it might therefore melt again. Such fragments of the crust would not, however, sink to any great depth, as the huge liquid core would consist of the heavier materials which had already found their way "downwards" by gravitation. Much heat would be radiated from the surface of the crust, until eventually there would be a kind of balance between the solar radiation absorbed and terrestrial radiation emitted. The reader must be on his guard, when he reads of the "solidification" of the interior. Technically the interior is doubtless solid, but, under the conditions of temperature and pressure there, the solid is bound to retain some of the properties of a liquid. Under such conditions we must give up the ordinary idea that a liquid is a substance that can be "poured". Is ordinary pitch a solid or a liquid? Place an iron weight on a hard block of pitch; it gradually sinks to the bottom. Is shoemakers' wax a solid or a liquid? From this substance a tuning fork can be made that will emit a musical note, but let the fork lie on the table for a sufficient time and it will gradually run, like a liquid, "all over the place". These cases are not strictly analogous to the heavy core of the earth, but they serve to show the danger of trying to draw a fine line between liquids and solids. So much depends on pressure, temperature, melting-points, and so on. Jeffreys rightly stresses the necessity of considering all these things carefully in connexion with any theory of the evolution of the planetary earth.

It is unlikely that below a depth of 400 miles any appreciable cooling of the earth has yet taken place. The core though "solid" must still be so far like a liquid that it is capable of being deformed to any extent by a shearing stress; it must also be devoid of rigidity and therefore unable to transmit distortional waves.

Whatever hypothesis we adopt about the final shaping of the earth, about its departure from a perfect spherical or

even spheroidal form, or about the marked irregularity of its surface as shown by continental elevations and oceanic depressions, we must begin by considering the facts as we actually find them now.

An examination of the distribution of land and water over the surface of the globe suggests some kind of original basal planning. There is, for instance, a predominance of land in the northern and of water in the southern hemisphere; the great continents form a nearly complete ring round the northern hemisphere and only about $1/27$ of this land has land antipodal to it; in the northern land hemisphere there is a polar ocean, and in the southern water hemisphere there is a polar continent; many of the geographical units are of triangular shape. However this planning may have been brought about, it is pretty safe to assume that the general form of the earth and the irregularities of its surface are the effects of simple causes of a dynamical character: gravitation; rotation; a tendency to an ellipsoidal figure with three unequal axes, associated with the attraction of the much nearer moon in a bygone age; shrinkage due to cooling; and the eccentric position of the centre of gravity probably arising from a past state of inadequate resistance to compression.

The antipodal arrangement of lands and seas led to the tetrahedral hypothesis of **Lothian Green**, who based his arguments on two well-known facts in geometry: (1) a sphere is a solid which contains the *largest* volume with respect to surface area; (2) a tetrahedron is a solid which contains the *smallest* volume with respect to surface area. Any "shelled" body which is contracting by internal shrinkage is encumbered with excess of surface, and a spherical body can most easily dispose of this extra surface by approximating to the form of a tetrahedron, this being the shape which most easily relieves the tangential stresses. In other words the excess of surface is disposed of with the least movement by flattening on four faces. Balloons composed of a skin of uniform thickness pass, during their collapse, through a tetrahedral form.

A model of a tetrahedron is easily constructed by cutting from a piece of stiff paper an equilateral triangle, bisecting its three sides, joining the points of bisection so as to form four equilateral triangles, and folding the three outer triangles on the inner triangle until the three angles of the original triangle meet in a common apex. It will be observed that each of the four corners is antipodal to a face (fig. 140). Within each triangular face construct as much as possible of a circle, concentric with but rather larger than the "inscribed" circle, so that the inner circular part is $\frac{5}{7}$ of the whole triangle. Then the whole area of the four inner circular parts is $\frac{5}{7}$ the area of the whole tetrahedral surface, and the total area of the angular portions (shaded in the figure) is $\frac{2}{7}$ of the area of the tetrahedral surface. Hence if the inner circular

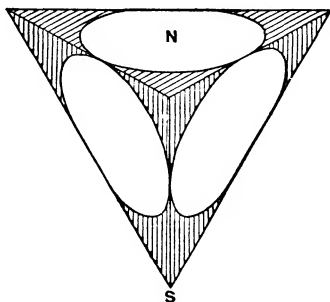

Fig. 140

parts represent water and the corner parts land, we have the correct proportions of water and land on the earth's surface. In the figure, N will represent the Arctic Ocean which is seen to be surrounded by a nearly complete ring of land, and S will represent the Antarctic continent which is seen to be surrounded by oceans into which the three great northern land masses project southwards and end in triangular apexes.* The three great oceans are represented by the unshaded circular portions of the lower tetrahedral faces. If the edges of the model be made of thin strips of whalebone and the faces of elastic tissue, and air be pumped in, the tetrahedron may be blown out into a sphere (in practice, difficult), and the general resemblance of the land and water areas to the existing continents and oceans is striking.

* It will, of course, be realized that the figure is only a diagrammatic sketch of the tetrahedron, and that the 4th triangular face is supposed to be at the back of the figure.

The late Professor **J. W. Gregory** (whose death last year by drowning in South America is to be deplored) was an enthusiastic supporter of the tetrahedral hypothesis which will not, however, stand the test of careful examination. The tetrahedral shape cannot be maintained by a body rotating at a high speed. The earth has merely *tended* to become tetrahedral, and this tendency may have played an important part in the shaping.

In recent years numerous hypotheses have been put forward to explain the surface structure of the earth, the stability (or instability) of the great continents, and the formation of mountain systems; many of the hypotheses are suggestive but most of them are open to criticism. **L. Kober** advanced a geosynclinal hypothesis, contending that contraction has been going on since the earth's birth. **Wegener's** hypothesis maintained that inter-continental "drift" has taken place and that it may still be in progress, though his explanation of the movements does not seem to be clear. Professor **J. Joly** of Dublin advances a drift hypothesis based on the postulate of radio-activity. **R. A. Daly** contends that there has been a downhill sliding movement of the continental masses, the controlling factor being gravity. Professor **Arthur Holmes** of the University of Durham puts forward an interesting hypothesis of convection currents in the substratum, and supports it with many striking facts. Perhaps the most convincing hypothesis of all is the contraction hypothesis of **Jeffreys**, whose cogent arguments are based on carefully sifted evidence, supported by well-established physical laws, and often reduced to rigorous mathematical form.

New evidence from seismology and from isostasy may eventually help us to sift the various hypotheses. "Isostasy" (*στατικός* = stable) connotes a sort of flotation of the earth's crust on the substratum, not a truly liquid substratum but still a substratum capable of preserving a hydrostatic equilibrium. This subject has been very carefully considered by **Jeffreys**.

Naturally the greater part of the evidence on which these hypotheses are based is inferential. Undisputed facts are few. The mean density of the earth, for instance, is said to be 5.5, but we cannot *weigh* the earth, directly, we estimate the weight from gravitational attraction. The mean density of the surface rocks is said to be rather less than 3, and that of the liquid-solid metallic core of (presumably nickel-iron) is about 10 or 11, but again these numbers are obtained by inference and calculation. So it is generally. All that we really *know* by observation about the earth is confined to a surface layer of the crust, some 3 or 4 miles thick. How thin a shell compared with the earth as a whole, with its 8000-mile diameter!

Philip Lake refers in this way to the general difficulty: "In considering the origin of continents and oceans, it is important to have a clear idea of the magnitudes concerned. If we imagine a globe a foot in diameter to represent the earth, with all its features in their true proportions, by far the greater part of the ocean will be less than $1/200$ inch deep, and only its extreme depths will reach $1/100$ inch. Almost the whole of the land will rise less than $1/1000$ inch above the sea, and even Mount Everest will have an altitude of less than $1/100$ inch. Leaving out of consideration exceptional heights and depths, the difference in the level between the surface of the land and the floor of the deep oceans will be less than $1/200$ inch. These are the features for which we are trying to account. On the 12-inch globe, all that lies more than an inch beneath the surface is under conditions of temperature and pressure which cannot be approached in our laboratories, and we have no experimental knowledge of the materials under such conditions. Moreover, time is an important factor, and our experiments give but little indication of what may happen under stresses acting for thousands of millions of years. It is not surprising that there is no general agreement as to the causes that have produced the present distribution of land and sea."

The well-known Cambridge geographer, **Dr. J. A. Steers**,

also strikes a note of caution: "Facts, and still more facts, must be accumulated. We are only at the beginning of things. A thousand years hence, our theories will probably be as fantastic as those of Werner are to us. Means will sooner or later be devised by which we can probe more deeply down into the earth's interior and understand something of the conditions therein existing. Our knowledge has increased enormously during the last decade and will go on increasing; new theories will be put forward, discussed, discredited, and discarded. The interpretation must vary with the equipment of the investigator or of the theorist—geologist, biologist, mathematician, physicist, or whatever he may be. Nor does it follow that the truth is contained in any synthesis of these theories. All that can be said is that the conflict of ideas may eventually lead us to a better understanding of the structure of the earth."

3. The Age of the Earth

Astronomers, geologists, physicists, and even chemists have all helped to devise methods of estimating the age of the earth. Every one of the methods is based on a substratum of fact, but most of them are strongly tinged with speculative hypotheses. All of them display ingenuity on the part of their originators. Some of them are weighty and have received general acceptance. We may briefly refer to the most important.

(1) **The eccentricity of the orbit of Mercury.** This method is due to Professor Jeffreys and is based on the tidal hypothesis of the origin of the earth. Not all the matter ejected from the sun would be included in the planets and their satellites. Much of it would be lost, would be dispersed throughout the system, and would form a resisting medium largely or entirely gaseous, the whole revolving round the sun but the parts revolving in very different periods. "The fast-moving interior [of the medium] will tend to drag forward the slower-moving interior, and thus will increase its energy and



Spiral Nebula in Ursa Major (N. G. C. 3031; M. 81)
Mount Wilson Observatory

make it recede from the sun. Thus the outer parts will slowly be expelled from the system. The inner parts, on the other hand, will have their motion delayed, and will gradually fall into the sun. In time, therefore, the resisting medium will cease to exist."

It is a principle of the tidal hypothesis that the newly born planets must have moved in highly eccentric orbits in this resisting but constantly changing medium. The resistance of the medium must, according to Jeffreys, have so affected the orbits as to make them more and more circular. The most eccentric orbit of all was that of Mercury, and it was this orbit to which Jeffreys directed special attention. The available data for estimating the original distribution of the mass of the medium are scanty and doubtful, but the density of the Zodiacal light, presumably the last relic of the medium, may be estimated from its luminosity, and is, according to Jeffreys, 10^{-18} gm. per cubic centimetre. Jeffreys was thus able to estimate that the age of the solar system was of the order 1000 million to 10,000 million, perhaps about 5000 million, years. Considering the uncertainty of some of the data, it is remarkable that the age of the earth as thus estimated is of the same order of magnitude as that inferred from the phenomena of radioactivity.

(2) **From the phenomena of radioactivity.** Radium occurs in the presence of uranium, which itself never occurs without radium. The ratio of the masses of the two elements present in a sample of ore is almost always the same, viz. 3.4×10^{-7} parts of radium to one of uranium. This constancy of ratio seemed to point to a chemical combination, but it was inconceivable that one atom of radium could unite with some three million atoms of uranium, and the hypothesis of chemical union was rejected. Eventually an adequate explanation was forthcoming. Radium was found to undergo a gradual change. A mass of radium compound enclosed in a sealed vessel was found to liberate a gas since called *radon*, the rate of liberation being proportional to the amount of radium present and such that a gram of radium would be reduced

to half a gram in 1500 years. The rest would be transformed into radon and then into further disintegration products of the radon. Why then has all radium not broken up long ago? The explanation suggested by its invariable association with uranium is that, as fast as it breaks up, new radium is formed by the break-up of the uranium itself. The suggestion was experimentally verified by Professor Soddy, who prepared a specimen of uranium quite free from radium, kept it for some years, and was then able to demonstrate the presence of radium in the specimen. But radon is not the final disintegration product of radium; there is a long series of such products. During the process of disintegration, helium is expelled, and the final product is *lead*. It is the uranium-lead ratio that is used for estimating the age of minerals. By this means Professor Holmes has determined the ages of minerals over a wide range of geological time. The results naturally vary greatly, but the general inference is that the age of the earth's crust is, again, of the order of 5000 million years.

(3) **The accumulation of sediments.** Professor Holmes shows clearly that there is no longer any hope of estimating geological time from assumed rates of deposition and the so-called maximum thicknesses of sediments. The conclusion is inevitable that the age of the earth is many times as great as those usually deduced from this class of evidence. The *rates* of deposition must have varied greatly.

(4) **The accumulation of salt in the oceans.** This method was first suggested by Halley, but was worked out by Professor J. Joly. At best it gives an estimate of the age of the ocean, and the estimates are, as Holmes conclusively shows, far too low.

(5) **The tidal theory of the origin of the moon.** The earth's rotation is very gradually slowing down owing to the friction set up by the ocean tides which are mainly due, of course, to the moon's attraction. The moon is therefore slowly retreating from the earth. Going backwards in time, we may picture the moon as approaching the earth more and more closely until the two bodies were nearly in contact. It

therefore seems probable that the moon was ejected from the original earth at a time when our planet was newly born and still fluid. On this assumption, the time of separation can be roughly estimated. Jeffreys' estimate is 4000 million years.

(6) **The movement of the solar system in the Milky Way.** It is estimated that the sun has travelled a distance of

Rough Estimates of Time in Years	Era	Period	Age	Rocks
1,000,000	Post-Tertiary	Pleistocene, &c	Man	Mainly sedimentary
50,000,000	Cainozoic	Pliocene	Mammals	
500,000,000	Mesozoic	Cretaceous Jurassic Triassic	Reptiles	
2,000,000,000	Palæozoic	Permian Carboniferous Devonian Silurian Ordovician Cambrian	Amphibians Fishes Invertebrates	
		Proterozoic	Evolution of Invertebrates	
2,500,000,000	Pre-Cambrian	Archeozoic	Evolution of unicellular Life	Mainly metamorphosed; igneous predominant

10^{18} miles from its own birthplace in the closely packed star region in the Milky Way, and his present rate of movement suggests that some 3000 million years would be required for the journey. It is very doubtful if this affords any real index to the age of the earth.

Professor Holmes's conclusion from these and other estimates is that the age of the earth is between 1600 and 3000 million years. Other authorities, believing that the relativity estimate far outweighs in importance all other estimates, would put the age as high as 5000 million years.

There is general agreement that the age is more than 10^9 (one thousand million) and less than 10^{10} (ten thousand million) years, and it is a little rash to try to fix the age more exactly.

The evidence which enables us to divide up the (say) 5000 million years into geological eras and periods is slight and not very reliable, and the estimates of different authorities vary greatly. *The table on p. 683 will serve to give some idea of the relative lengths of the time subdivisions most commonly accepted, but the figures must not be taken to represent more than extremely rough approximations.*

4. Earthquakes

Within living memory great earthquakes have occurred at Charleston, Mont Pelée, San Francisco, Messina, Tokyo and Yokohama, Naples, Nicaragua, and in New Zealand, and most people will associate them with enormous destruction and great loss of life. It is, however, important to note that the serious damage is usually confined to a very small area, and that even within this area the ratio of damaged to undamaged houses is usually small. The buildings that are badly damaged have nearly always been of weak and inferior construction. Well-built structures of brick or stone, or buildings of reinforced concrete round well-designed steel skeletons, have usually withstood an earthquake shock, though it is true that many good houses have sometimes been injured by earthquakes.

Science is less concerned with the destructiveness of earthquakes—it is at present quite powerless to put up a fight against them—than with their usefulness as an index to tell us something of the structure of the earth. Fundamentally an earthquake is just what its name denotes: it is a trembling or shaking of some part of the earth. The intensity of the associated phenomena may vary from a slight tremor only perceptible with the aid of delicate instruments to great convulsions accompanied by considerable changes

in the surface structure of the earth. A great earthquake may be heralded by preliminary tremors, followed by a shock or a series of shocks lasting for minutes, and then by a series of minor disturbances. The seismometer record in Plate 37 shows this succession clearly. The record is obviously a record of *waves*.

Broadly speaking, earthquakes are caused by the contraction of the earth's crust, due to cooling of the earth's interior. Subsidences are bound to occur, and these are necessarily accompanied by fractures or folding movements which set up waves, and these waves travel outwards in all directions from the centre of disturbance. Even a surface disturbance may perhaps cause an earthquake. For instance, a huge mass of rock two or three cubic kilometres in volume fell through a height of something like a third of a mile in the Pamir region in 1911, and converted a river valley into a lake. Seismographic records in various parts of the world showed that a great earthquake had occurred at exactly the same time, and pointed almost unmistakably to the Pamir landslip as the origin, so that a dynamic connexion seemed almost certain. The blow to the ground caused by the fall might have been the cause of the seismic disturbance that travelled out from the place, the kinetic energy of the falling mass being converted into energy of internal vibration in the earth. Alternatively, the earthquake may have originated at some depth, the mass of rocks being loosened by the shock. We do not know.

It is with the *waves* that we are chiefly concerned here.

When a homogeneous medium is disturbed, the compressional and distortional waves that travel through it follow a simple law; but in the case of a heterogeneous medium like the earth, reflections and refractions of the waves will be set up at bounding surfaces separating materials of different densities. The problem thus becomes more complex. Expert analysis of seismographic records enable us, however, to draw valuable inferences as to the build of the heterogeneous earth structure.

An earthquake commonly originates a few miles below the surface, and a seismogram for a place near the origin of the earthquake shows that *three* kinds of waves are sent out. The first to arrive are small tremors known as "push" or compression waves; they travel through the earth. The second set to appear, also small, due to vibrations at right angles to the path of the earthquake, are known as "shake" or distortion waves. (Compare with the longitudinal and transverse waves of Chap. XXXVI.) These are followed by the large destructive waves which travel along the surface, known

as Rayleigh or Love waves (after the late Lord **Rayleigh** and Professor **A. E. H. Love**): they need not be considered here.

The small push and shake waves are secondary effects of the large destructive surface waves.

A seismogram for places farther from the origin is usually very complex; there may be three sets of push waves and

three of shake waves. At places very remote from the origin, only the third sets, together with the large waves may be recorded. These third sets may make themselves felt to a depth of 1800 miles. A wave going to that depth emerges at the surface 103° from the origin O (fig. 141). Thus records may be made over an area of half the globe having its "pole" at O, as well as over a belt extending to 13° ($= 103^\circ - 90^\circ$) beyond the great circle which determines that half.

Push waves are also recorded within an area of 36° from the point antipodal to O, but not shake waves. Between the two areas (in the figure, between the two shaded areas) no records of any kind are made.

Thus there are two fundamentally important facts: (1) only the push waves reach the antipodes of the place of origin; (2) the shake waves are unfelt beyond 103° .

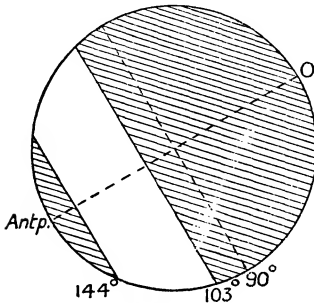

Fig. 141

From the seismograms, and from the times the waves are recorded at the various seismographic stations, it is possible to determine the path followed by the waves through the materials of the earth and to calculate the wave velocities.

The velocities of the first, second, and third sets of *push* waves are $3\frac{1}{4}$, 4, and $4\frac{3}{4}$ miles a second, and these are the velocities with which such waves travel through granite, diorite, and highly basic rocks, respectively. The inference is that below the surface there is a layer of rock like granite; beneath that, diorite, and beneath that again, highly basic rocks.

The crust of the earth thus seems to transmit push waves at an average velocity of 4 miles a second, to a depth of perhaps 40 or 50 or even 100 miles or more. Below this depth the waves undergo a marked acceleration, and they must therefore be travelling through a much more elastic material. The velocity increases to even 8 or 9 miles a second, until about the half-way point of the earth's radius is reached, when the rate begins to *decrease*, and *at the same time the material ceases to transmit the shake waves*; again, therefore, the material must be of a different character. Since this innermost material is unable to transmit *shake* waves it must be devoid of rigidity. Presumably therefore it is a liquid, an hypothesis which is confirmed by the fact that the earth yields to tidal strains.

There is general agreement as to the inference to be drawn from the facts: that the earth consists of a rocky crust which covers a very heavy, very thick, solid shell which in its turn encloses a very heavy liquid. The rocky crust is called the *lithosphere* and consists of lower layers of very dense rocks and upper layers of lighter rocks, of a total thickness of roughly 100 miles. The heavy solid nickel-iron shell is called the *barysphere* *, and the nickel-iron liquid core the *thermosphere*, the solid shell being 2000 miles in thickness and the liquid core about 4000 miles in diameter (see fig. 142)

* An ugly word derived from Greek βάρος, weight.

The separation of the lithosphere from the barysphere is the natural result of the specific gravity difference of rock and metal, the rocky crust being the equivalent of a slag which has exuded from the metallic mass and has floated to the top, like the slag in a blast furnace. Since we may reasonably assume that the earth consists of the same materials as the other members of the solar system, and that therefore it represents a fair average of the material of meteorites, it follows that the barysphere must consist largely of nickel-

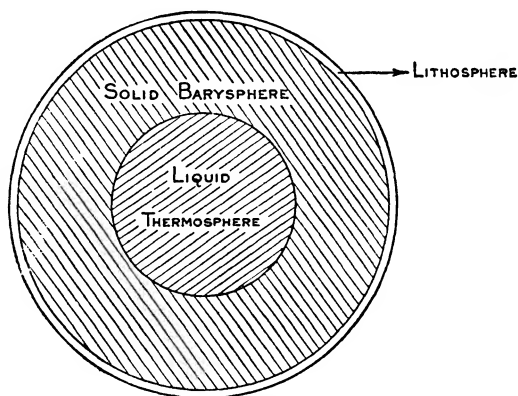

Fig. 142.—Barysphere, &c.

iron. This is confirmed from specific gravity considerations, for we know that the specific gravity of the whole earth is 5.5, and that the specific gravity of rocks is 2.5, and it therefore follows that the specific gravity of the barysphere is somewhere about 8 to 10, probably rather more than that of ordinary nickel or iron.

The nickel-iron barysphere must not be thought of as if the liquid core were distinctly differentiated from the solid shell. There can be no distinct boundary between the two. The liquid core must be so compressed that although it is not rigid it approaches a solid in some of its properties. True rigidity sets in at about 2000 miles from the centre,

and thus we speak of the outer part of the barysphere as a "solid" shell.

The increase in temperature of 1° F. for every 60 feet of descent, as determined from deep mines and hot springs, cannot continue indefinitely, as that would mean 400,000° F. at the centre, and there is no evidence that the thermosphere has a temperature higher than a few thousand degrees. The internal heat was not so high as to prevent the formation of a non-conducting crust which soon became so thick as to prevent the barysphere having any material influence on the climate. There is ample evidence of climatic uniformity since Cambrian times, and this indicates that the earth's crust had by then acquired its present thickness and strength. That before Cambrian times the crust must have been thinner and weaker is shown by the tilted condition of all the primeval rocks. As the crust contracted, the lateral pressure must have been general. The sedimentary rocks were afterwards deposited in horizontal layers, and most of these have also been tilted.

5. Applied Geophysics: Prospecting

As recently as twenty years ago most of the oil magnates classed the geologist with "oil witches" and "oil smellers" and called him a "pebble pup". They now regard him as their adviser-in-chief and look upon his services as invaluable. The term "prospecting" denotes search for minerals, including oil. Most modern mines owe their origin to professional prospectors, who have frequently made important discoveries in regions not easily accessible, where they are often carried by airplanes. The geologist aids the prospector by using the full resources of geology, mineralogy, physics, and chemistry. The four main groups of prospecting methods available (generally called geophysical) are (1) gravitational; (2) seismic; (3) magnetic; and (4) electrical. These four methods are based on the differentiation, usually abrupt, of some physical property between one type of rock and another.

The differences are those, respectively, of density, of velocity in elastic wave propagation, of magnetic susceptibility, and of electrical conductivity. Associated with these variations of natural physical properties, other physical effects which are capable of measurement by geophysical apparatus may be artificially produced at or near the earth's surface.

1. **The gravitational method.** This method is based on the use of the *torsion balance*.

The Fourth Wrangler of the year 1749 was **John Michell** (*d.* 1793), who became Fellow of Queens' College, Cambridge, and Woodwardian Professor of Geology. He was elected F.R.S. in the same year as **Cavendish**. He is best known as the inventor of the torsion balance which he intended to use for the measurement of the density of the earth, but he died before the method was put into practice. The experiment was, however, performed by Cavendish to whom the balance had been bequeathed.

Just as the earth attracts the moon with a force which follows the same law as the attraction exerted by the earth on bodies at its surface, so small bodies which we can handle attract *one another*, and in accordance with the same law. This can be shown experimentally, but the experiment is exceedingly difficult to carry out, since the mass of the largest body which we can employ is so excessively small compared with the mass of the earth, and hence the attraction between any two bodies we can use is only a very small fraction of the weight of either.

The Michell-Cavendish torsion balance was of the simplest character, though it had to be made with great precision. Two small equal spheres of lead m and m' , each 2 inches in diameter, were attached to the end of a slender horizontal rod 6 feet long, suspended at its mid-point by a long, exceedingly fine, elastic wire. If this rod is acted on by a couple in the horizontal plane, it will turn, the wire becoming twisted. But since the wire is elastic it resists the strain (twist) and tends to untwist itself. The force with

which the wire tends to untwist is, within certain limits, proportional to the angle through which it is twisted. By reversing the couple we may reverse the twist. Hence by observing the angles through which the two given couples twist the wire, we have a means of comparing the couples. Since the couples are necessarily very small in any case, an appreciable twist can be ensured only by having a suspending wire of very small diameter.

Figure 143 shows a plan of the essentials: m and m' are the two small spheres at the end of the slender rod which is free to rotate in a horizontal plane at its midpoint s where it is suspended by the fine wire. M_1 and M_2 , are two fixed

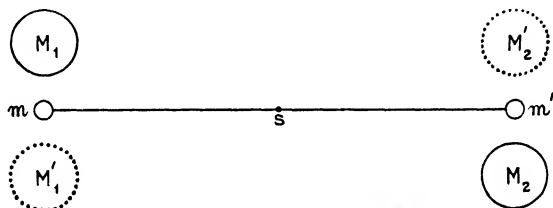

Fig. 143.—Plan of Torsion Balance

large spheres of lead each 12 inches in diameter. They are so supported that they can be fixed in the position M_1 and M_2 , or M'_1 and M'_2 . The initial distance between each big sphere and its neighbouring small sphere is 9 inches. In the first position the gravitational attraction between the fixed heavy mass M_1 and the movable light mass m , and between M_2 and m' , tends to turn the beam (the rod) clockwise: in the second position, the attractions tend to turn the beam anticlockwise. The suspended small weights, the rod, and the wire, are kept within a well-made glass case; the big fixed balls are outside; and the position of the beam is read from a scale by means of a telescope, the graduations being reflected in a small vertical mirror attached to the centre of the rod. The masses of the fixed and movable spheres, the distances, and the angles of twist, all being known, the gravitational constant, and the density of the earth, may be easily calculated.

The experiment has since been repeated by Professor C. V. Boys * whose suspension "wire" consisted of an amazingly fine thread of fused quartz. He was thus able to reduce his movable spheres to the weight of a gram each. He carried out his experiments in a constant-temperature cellar. His results were the admiration of all physicists.

To see in a Boys balance a small sphere of gold swinging round in obedience to the pull of a large sphere of lead is, for a moment, almost uncanny.

The man who made the torsion balance robust and portable enough for prospecting was Baron Roland Eötvös (1848-1919), the Hungarian physicist. For measuring gravitational variation the Eötvös balance method is incomparably superior to the older pendulum methods. The earth's gravitational field is not, of course, spherically symmetrical, and the apparent value of gravitational intensity increases in passing from equator to pole. At latitude 45° the change of g for a single step of one metre northwards is about one-thousand millionth (10^{-9}), and this the Eötvös balance shows readily; in fact the instrument would respond to a very much smaller amount.

Evidently the balance is eminently useful for showing gravitational *variations*, and this is its great use in prospecting. In particular, it measures *gravity gradient*, or the rate of change of the vertical gravitational intensity with horizontal distance in the direction in which the change is greatest. The interpretation of results is, however, usually difficult, for the problem is to ascertain to what extent the gravitational irregularities measured are due to density differences in some

* In the eighties and nineties Boys' wonderful experimental skill at the Royal College of Science caused him to be looked upon as a sort of magician. I remember his showing on the screen a photograph of a quartz fibre side by side with a spider thread. The latter looked like a band of ribbon, the former like a fine hair. Some water falling in scattered drops from a nozzle over the demonstration-table promptly coalesced into a single stream as he passed by; the stream was really a sensitive electroscope, and when he passed by he slyly rubbed against his coat sleeve a bit of amber concealed in his hand. As for his tricks with soap-bubbles, his book on the subject has been a joy for nearly half a century to boys throughout the English-speaking world.

buried rock-structure, and to assign to the latter a position and extent consistent with the observations. The most important example of successful application of gravity surveying is in the detection of salt domes, and in the determination of their extent and depth. But limestone anticlines and synclines, rock faults, and deposits of hæmatite, produce, if not too deeply buried or masked by irregularities, gravitational disturbances large enough to lead to their delineation by means of the torsion balance. Actual measuring is normally carried out by observing the changes of torsion accompanying changes of azimuth of the instrument as a whole. Present-day instruments differ in form according to the particular circumstances of their use.

2. **The seismic method.** This method of prospecting was introduced in 1919. The basis of the method is the same as that underlying the investigations of the propagation of earthquake shocks in relation to the determination of the structure of the earth's crust. The difference is only one of degree. Artificial and controlled explosions replace the sporadic natural shocks, and although the detonation of perhaps a ton of gelignite may be dangerous enough, it is trivial compared with natural earthquake disturbances. In trying to determine the depth of an underground stratum, the most direct method of attack would be to measure, if possible, the time of the to and fro journey of a particular disturbance from the surface to the interface and back again after reflection. A knowledge of the velocity of propagation in the intervening medium would then give the depth required. The method has been of great success in determining the depth of the ocean by means of the Admiralty echo-sounding machine. In applying the method to the solid earth, violent explosions have to be used, because of the attenuation of vibrations with distance.

3. **The magnetic method.** This consists of measuring with suitable portable magnetometers, local variations of components of the earth's magnetic field. In this way much information may be obtained regarding certain underground

rock-structures. The basis of magnetic surveying is the differentiation of rocks in respect of magnetic susceptibility. Highly ferruginous rocks are easily located, and, with modern forms of magnetic variometers, sedimentary formations only slightly ferruginous may be detected. When more sensitive instruments become available, the method is likely to prove of the highest value.

4. **Electrical methods.** The basis of electrical methods is the difference of electrical conduction of underground bodies. For instance, ores with metallic lustre, such as pyrites and galena, conduct much better than the rocks around them. In this form of prospecting, parallel bare copper wires 1000 feet long and 1000 feet apart, are pegged to the earth. Current is sent through them and, if no conducting ore is under the earth between them, it flows from wire to wire through the earth in symmetrical fashion. But if conducting ore is present, the lines of current-flow converge towards it: the equipotential lines are no longer parallel to the earthed wires but are distorted round the ore. A null method will determine the equipotentials. Comparatively little, however, is known about the methods. The Report of the Sub-Committee of the Committee on Civil Research on Geophysical Surveying (H.M. Stationery Office, 1927) says: "The electrical method has throughout been treated, by the companies employing it, as a jealously-guarded secret trade-process. In the result, little information is available to the general scientific world regarding the methods employed, the apparatus required, the field operations, or the interpretation of results. We believe that a full disclosure of the scientific facts would tend, more than anything else, to stimulate the natural development of this method of geophysical surveying, by placing it on a scientific footing, similar to that of the gravimetric method." Until the work of the Imperial Geophysical Experimental Survey, which operated in Australia from 1928-30, began, the details of the methods employed were shrouded in mystery, and even now not a great deal about the methods is generally known.

Professor **A. O. Rankine** points out that, until quite recently, practically all the work was being done by German investigators, both in the construction and in the improvements of instruments, and in their use in the field. But some interest has now been awakened in this country, and we are now taking an increasingly active part in the investigations. Much, however, remains to be done in all branches of geophysical surveying to put it on a secure and permanent basis.

Water divining and the hazel twig bring us to very controversial ground, and scientific opinion is much divided as to the honesty of those who practise this form of prospecting. One thing is certain, and that is that the mode of action of the hazel twig has not yet been revealed, and has not been proved dependent on known physical laws. This does not, however, prove that those who use it as a prospecting instrument are impostors.

Meteorology and Anthropology

These subjects are sometimes brought within the ambit of geology, but we shall reserve them for separate chapters.

BOOKS OF REFERENCE:

1. *The Earth*, Harold Jeffreys.
2. *The Unstable Earth*, J. A. Steers.
3. *The Making of the Earth*, J. W. Gregory.
4. *Birth-time of the World*, J. Joly.
5. *Surface History of the Earth*, J. Joly.
6. *The Origin of the Earth*, T. C. Chamberlin.
7. *Evolution of the Solar System*, F. R. Moulton.
8. *The Age of the Earth*, Arthur Holmes.
9. *From Meteorites to Man*, J. W. Gregory and others.
10. *Size of the Universe*, L. Silberstein.
11. *Astronomy and Cosmogony*, J. H. Jeans.

12. *Some Aspects of Applied Geophysics* (B. A. Address, 1932), A. O. Rankine.
13. *The Contacts of Geology* (B. A. Address, 1932), P. G. H. Boswell.
14. *Elements of Geophysics*, R. Ambronn (trans. M. C. Cobb).
15. *Applied Geophysics*, Eve and Keys.
16. *Petrographic Methods and Calculations*, A. Holmes.
17. *Outlines of Palæontology*, H. H. Swinnerton.
18. *Text-book of Geology*, A. Geikie (or some similar established Work).
- 19-20. American readers in particular should consult the *Works* of their two eminent palæontologists Othiel Charles Marsh (1831-99), a Yale professor famous for the accuracy of his records; and Edward Drinker Cope (1840-1897), a Pennsylvania professor who was a staunch supporter of Lamarck.



Aeroplane View of Mount Wilson Observatory

Photo. G. R. Hoge

CHAPTER XLII

Meteorology

Geology is concerned with the formation of both the solid, the liquid, and the gaseous portions of the earth's crust, and therefore looks upon meteorology as its foster-child, which, however, we have brought into a separate chapter.

Like most other branches of science, meteorology has become a subject which is rapidly increasing in extent and importance. At the end of the last century it was stretching a compliment to speak of meteorology as "science" at all. Unchallenged facts were few; hypotheses were many, most of them supported by evidence of a questionable character. Masses of unassailable facts are now accumulating, and far greater caution is being exercised in framing hypotheses to explain their inter-relations.

It is reasonable to infer that the complex and variable thing we refer to when we speak of "climate" enjoyed a very placid infancy. Before the shrinkage of the newly-formed earth-crust, weather conditions were presumably fairly uniform and altogether unexciting. If we imagine the earth's surface, as we now know it, to be converted into a uniform sea, or into a uniform land-plain, how deadly dull the weather would become. The two great weather-making forces would still be at work, it is true: the sun, and the earth-spin. But the many things which now conduce to virtually unpredictable weather variation, for instance, the irregularly distributed continents, mountains and ocean-basins, would be absent.

It is these irregularities of the earth surface that are responsible for all our climatic variations and vagaries, and yet relatively to the general surface these irregularities are so insignificant that they are far less than the wrinkles on the skin of an apple cooled after half an hour in the oven. Indeed, a fairer comparison are the scratches and bruises on the surface of a common rubber ball after a few games on a fives court. Such scratches and bruises on the larger earth-scale are responsible for American tornadoes, Chinese typhoons, Rhodesian thunderstorms, and all other weather excitements, great and small; and, incidentally, they provide the whole world with an everyday topic of conversation.

Weather lore certainly goes back to the time of the Greeks, who themselves coined the word meteorology (*τα μετέωρα* = "the things above"), though they referred chiefly to such things as comets and meteors rather than to the atmosphere. As might be expected, Aristotle wrote a book on the subject, but his observations were not of great importance. It was not until some 2000 years later that the subject was taken up seriously.

At the end of the sixteenth century, Galileo and other Florentine physicists constructed the first *thermometer*, an instrument which was afterwards greatly improved by G. D. Fahrenheit (1686-1736), a German physicist. In 1643, an Italian physicist, E. Torricelli (1608-1647), discovered the principle of the *barometer*; and the work of Boyle on gases, and that of his assistant Hooke, on the barometer, advanced the physical basis of meteorology. The first European *rain gauge* is said to have been invented by an Italian, Castelli, in 1639. The English astronomer Edmund Halley (1656-1742) wrote an important treatise on the Trade Winds and Monsoons, and John Hadley (1682-1744), an English mathematician, demonstrated the effect of the rotation of the earth on the direction of the Trade Winds. Neither Hadley nor Halley had many facts to go upon, and their views were largely speculative and hypothetical. They knew nothing of the upper atmosphere, for the first investi-

gator who succeeded in raising thermometers into the air by means of a kite was **Wilson** of Glasgow in 1749.

In the early years of the nineteenth century, a chain of meteorological stations was established in France, and weather maps were constructed from the data collected. In 1854, the Meteorological Office was established in London as a department of the Board of Trade, and was placed under the direction of Admiral **Fitzroy**, who at once arranged for daily observations to be made over a large area. Rapidly increasing information now made it possible to test many of the old hypotheses, some of which then had to be discarded. The invention of the telegraph helped enormously in the prompt collection of records in those early days, and, since the introduction of "wireless", the advance in meteorology has been extremely rapid. The central department in London is now a department of the Air Ministry, and here not only are the daily meteorological observations from a network of about 600 stations in Europe collected, but weather reports are received twice daily by wireless from the U.S.A. weather bureau; observations are also received from ships at sea.

Four times every day the observers at most of the different European stations record and transmit by code to the Central Office the following details: temperatures (the wet and dry bulb and maximum and minimum thermometers are read), barometric pressure (and variation during the last three hours), rainfall, force and direction of the wind, and state of the atmosphere. From these the Daily Weather Chart is completed, isobars, &c., being drawn in. The weather prevailing at the time the records were made may thus be seen at a glance over a very big area.

The student of meteorology can make no headway in the subject unless he is well versed in elementary physics, especially in such topics as fluid pressure and heat. If he wishes to master the leading works on the subject, he must have more than a nodding acquaintance with mathematics. If his knowledge of the subject was acquired in pre-war days, he must be prepared almost to begin the subject anew. Here we can

afford space only for short sections on the following topics:

1. The modern meteorologist's equipment.
2. Atmospheric pressure.
3. Temperature: the stratosphere.
4. Weather maps.
5. Radio-geophysics: the ionosphere.
6. Matters of special interest.

1. The Modern Meteorologist's Equipment

Most people are familiar with the small enclosure, sacred to the local meteorological observer, to be seen in some fairly exposed position at nearly every seaside resort of importance.

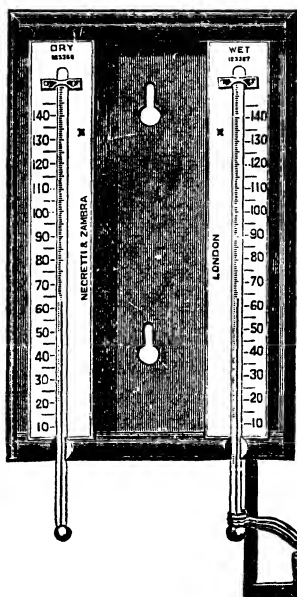

Fig. 144

The most conspicuous object in the enclosure is the *Stevenson screen*, a cubical box $3\frac{1}{2}$ feet above the ground, with internal dimensions 18 inches long, 11 inches wide, and 15 inches high.

Double louvered sides and a double roof ensure free circulation of the air. The screen contains four thermometers, which are thus protected from direct sunshine. Two of the four are ordinary thermometers and are kept in a vertical position, the only difference between them being that the bulb of one is kept wet: the two together thus constitute a useful form of hygrometer, by which the relative humidity of the atmosphere may be determined (fig. 144); the other two are

the other two are

maximum and minimum thermometers, respectively, and are kept in a horizontal position. A *rain-gauge* is usually found in the same enclosure as the Stevenson screen.

The meteorological observer's usual mercury barometer is the Kew pattern, so made that no adjustment of the mercury column is required before reading. But a continuous record of barometric pressure is also required, and this is easily obtained by means of a barograph. The barograph commonly used is really a sensitive multiple aneroid, consisting of eight of the usual corrugated German-silver vacuum boxes (each $1\frac{1}{2}$ inches in diameter and $\frac{1}{4}$ inch thick). The thin metal of the box immediately responds to pressure variation, but the box is kept from collapsing by means of a spring, and the flexure of the spring is an index of the variations. By means of a system of levers, the delicate motions are magnified and communicated to a recording pen which leaves its trail on a revolving chart.

Continuous mechanical registration of temperature is effected by a *thermograph* (fig. 145), in which the thermometer is constructed on an entirely different principle from the ordinary thermometer. It consists essentially of a closed metal tube of elliptical cross-section—a Bourdon tube—filled with alcohol. Expansion of the liquid compels expansion of the tube, and this tends to change the ellipse into a circle. If therefore the tube be fixed at one end, the free end will tend to twist, and a pointer attached to this free end may be made to leave a trail of temperature changes on a revolving drum, much the same as in the case of the barograph. The unequal expansion of the two sides of a bimetallic strip may also be utilized for obtaining temperature registration.

A *wind-vane* for indicating the direction of the wind is familiar to everybody. It should move with a minimum of friction and must be accurately balanced.

Anemometers are instruments for measuring the velocity of the wind. In the *pressure-tube* form, a horizontal nozzle at the top of a vertical tube is free to rotate and is kept facing

the wind by the action of the vane forming its tail. The wind-pressure down the tube is a measure of wind velocity. In the *cup* form, a horizontal arm at right angles to an upright shaft free to rotate carries two hemispherical cups, and these are driven round by the wind. The bottom of the rotating shaft is geared up with a recording mechanism, and thus a measure of the wind velocity is obtained.

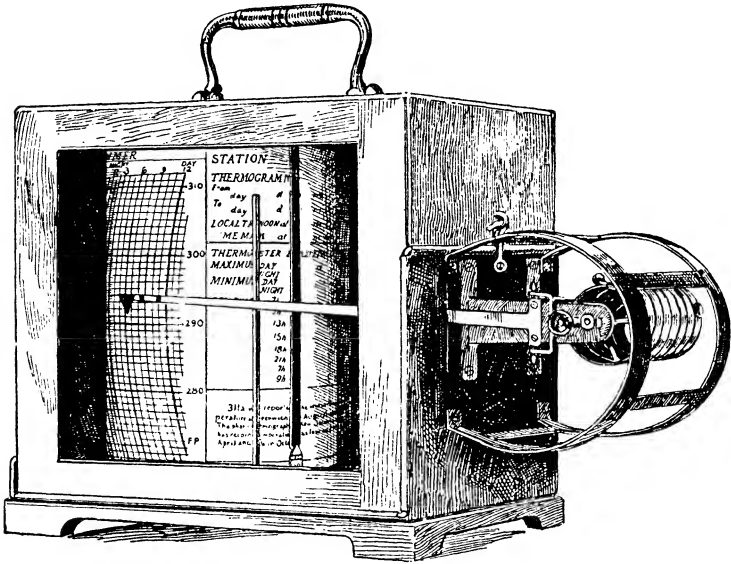

Fig. 145.—Thermograph

Such instruments as we have referred to have long been in use for making atmospheric records near the earth's surface, but it is only during the last thirty or forty years that serious attempts have been made to obtain records of the upper or "free" atmosphere. In these investigations, kites, free manned balloons, captive balloons, "ballons-sondes", pilot balloons, and more recently, aeroplanes, have all been pressed into service.

In the latter half of the last century, it had been definitely established from kite and balloon ascents that the temperature

of the free atmosphere decreased with height at the rate of about 1° F. for every 300 feet up.

Systematic observations of the upper atmosphere were made by Professor **Lawrence Rotch** in 1894; he sent up self-recording instruments attached to kites, a steam-winch being employed to wind the kites in. A kite station was equipped in 1898 by **L. P. Teisserenc de Bort** (1855-1913), the noted French meteorologist, at Trappes. In 1902 **W. H. Dines** carried out a series of observations on the west coast of Scotland. From 1898 to 1902, **de Bort** arranged a large number of ascents with small free balloons or *ballons-sondes*, the number of balloons released being 258.

It was soon discovered that ordinary barometers and thermometers could not withstand the shocks and jars to which they were subjected when attached to kites and balloons. Special light self-recording instruments (aneroid barometers, Bourdon tube-thermometers, and hair-hygrometers) were therefore designed and were used instead. Methods were also devised whereby the instruments might be shielded from the direct rays of the sun and at the same time might be properly ventilated.

The combined instrument is known as a *meteorograph*, and is usually some form of baro-thermo-hygro-anemograph. It is carried up either by a kite (box-form), or by a balloon. Well-known forms have been constructed by **de Bort** in France and **Assmann** in Germany, but the one in common use in this country was designed by **W. H. Dines**.

The Dines meteorograph is wonderfully simple, compact, and light. The barometer is a partially exhausted aneroid, and the thermometer is an expansible strip of German silver with a parallel rod of the nickel-steel alloy, invar. (This alloy is characterized by its extremely small coefficient of expansion). The horizontal movements of the aneroid, and the vertical expansion movements of the thermometer are recorded on a strip of copper by a scratching-point. The whole instrument is protected in a thin aluminium cylinder and is placed in a bamboo "spider frame". The frame is

carried by a balloon, the suspension line being some 40 metres in length; and an attached label gives instruction to the finder. The 40-metre line is useful: the angle that it subtends enables an observer at his theodolite on the ground to calculate the distance of the balloon; he can therefore estimate the rate of ascent and the velocity of the wind.

The wind velocity in the upper atmosphere may be recorded by an anemometer included in a meteorograph, but the range is limited, and a preferable method of obtaining wind data above 4 or 5 kilometres up is to observe the ascent of either a *ballon-sonde* or a pilot balloon by means of theodolites. Two theodolites may be employed, one at each end of a measured base-line, the observers being in telephonic communication with each other. Simultaneous observations are made at minute intervals. The balloons commonly used are about 18 inches or 20 inches in diameter, are about 12 grams in weight, and are inflated with hydrogen.

Sounding balloons carrying apparatus may ascend to about 22 or 23 miles, and pilot balloons to 25 miles. Aeroplanes are constantly breaking "records", but their present limit is not much above 7 or 8 miles. Beyond 25 miles our information of the upper atmosphere is limited at present to such deductions as many be drawn from the height of the twilight arch (say 50 miles), the paths of shooting stars (perhaps 125 miles), and aurora phenomena (perhaps up to 200 miles or 300 miles). Only up to about 25 miles is our knowledge at all certain, and even then it is very fragmentary. But as we shall see in a later section, the geophysicist and the wireless engineer are beginning to make important discoveries at high altitudes.

2. Atmospheric Pressure

From the standpoint of meteorology, pressure is the most fundamental property of the atmosphere.

If a series of books be placed on the pan of a spring balance, the dial at once shows increased pressure with every

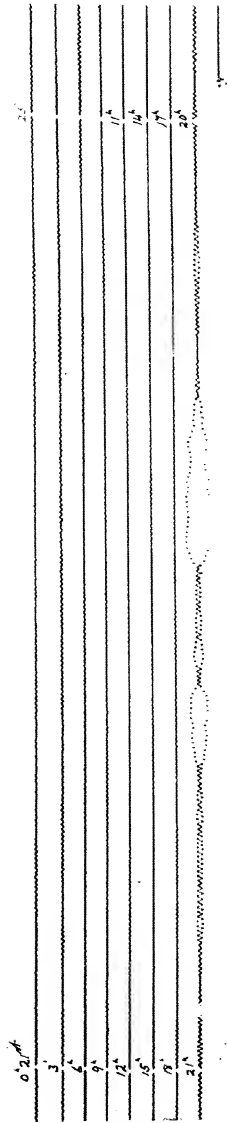

Seismogram or Record of an Earthquake

The earthquake took place in the Pacific Ocean and the seismogram was made at the Coats Observatory, Faisley

Reproduced direct from the original photographic record, by permission of the Faisley Philosophical Institution

additional book. The bottom book has to withstand the pressure of all the books above it: so with any other book in the pile. Similarly with a pail containing water; an increase of water increases the weight, and therefore the pressure on the bottom of the pail. In both cases the pressure increases from above downwards. But there is this difference: the pressure of the books manifests itself in a downward direction only, while the pressure of the water manifests itself on the sides as well as on the bottom of the pail. If there are holes in the sides of the pail, the lateral pressure is shown by the water squirting out, and the lower the hole the greater the pressure, as indicated by the violence of the squirting. In some respects the pressure of the atmosphere is like the pressure both of the water and of the books: the lower layers of the atmosphere have to support all the layers above, and the atmospheric pressure near the earth's surface is therefore great. As we ascend, the pressure diminishes, a fact which is clearly shown by the barometer.

The air is just a mixture of gases, and the ordinary physical properties of gases apply to it. It is, for instance, easily compressible, and, provided the temperature is constant, the volume varies inversely as the pressure upon it (a law discovered by Boyle). Again, it possesses the property of adiabatic heating and cooling; that is, a given quantity of air when expanded without addition of heat becomes cooled; and conversely, when compressed without heat being subtracted, it becomes heated.

Air in an open vessel, as a jug or a tumbler, may be regarded as part of the atmosphere. But air in a closed vessel acts peculiarly. No matter how much may be pumped out, that which is left in spreads itself out uniformly into every part of the vessel, and not only so but it exerts a pressure which is equal in all directions, upwards, downwards, and sideways. Again, if two gases of different densities are brought together, they diffuse into each other and rapidly form a homogeneous mixture. Even if a jar of a very light gas, like hydrogen, is brought into communication with a

jar of heavy gas, like carbon dioxide, the former with its mouth downwards and the latter with its mouth upwards, the two gases rapidly commingle, and no one part of the mixture can be distinguished from any other part.

The diffusion of the various gases into the uniform mixture we call the atmosphere certainly extends for a good many miles upwards, but, as we shall see later, there comes a time when diffusion ceases and the different gases settle according to their specific gravities. It should be borne in mind that gravity acts on the atmosphere exactly as it acts

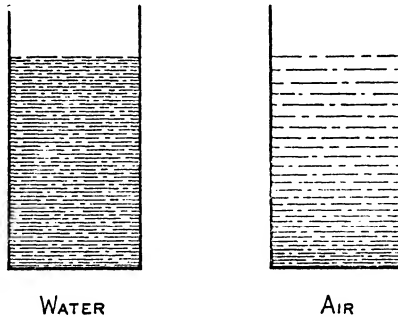

Fig. 146.—Diagrammatic representation of layers of water and air

on everything else, and holds it down to the earth's surface. When any part of the atmosphere ascends, it ascends not because of any inherent quality of its own but because it is being displaced by some heavier part which has gravitated downwards. Throw a stone into water; the stone sinks and the displaced water rises. Gravity acts upon both the water and the stone all the time, but the "pull" on the stone is greater than the "pull" on the water; the stone therefore takes the "lower" position and in doing so pushes the water out of the way.

The variation of pressure with height is totally different in the two cases of water and air. Water is an *incompressible* fluid, and, on any horizontal plane area within it, the pressure is equal to the weight of the water vertically above the area. The pressure on a plane at any depth is therefore *directly*

proportional to the depth of the plane. The pressure of the *atmosphere* on any horizontal area of the earth's surface is likewise always equal to the weight of the column of air vertically over that area, extending to the upper limit of the atmosphere. Obviously, however, the pressure is *not* directly proportional to the height of the column: for as pressure decreases with height, so does the density of the air, according to Boyle's law. The density of a column of water remains the same throughout; that of a column of air continuously diminishes upwards. Fig. 146 shows this difference diagrammatically. Laplace deduced a law for this diminution of pressure with height in the case of still air: *the pressure decreases in geometrical progression as the height increases in arithmetical progression*. It is easily calculated that at $3\frac{1}{2}$ miles up the pressure is equal to about one-half the surface value.

The airman's altimeter is calibrated in accordance with this law of pressure diminution. In practice it is placed alongside a mercurial barometer in a receiver from which the air is gradually pumped out. The equivalent of the air removed can then be found in feet, and the dial of the instrument calibrated accordingly. Temperature corrections have, of course, to be applied.

Until recently, atmospheric pressure heights were recorded in terms of the lengths of the barometer mercury column, the standard value of 760 mm. (= 29.925 inches) at 0° C. and lat. 45° having been adopted. But pressure is not a length, and the meteorologist has now adopted a new unit which he calls a **millibar**. The metric system unit of pressure is the dyne per square centimetre, and the pressure due to the barometric column of 76 centimetres of mercury is $76 \times 13.6 \times 981$ (= 1,013,200, or approximately one million) dynes per square centimetre. The name **bar** has been coined to denote this pressure of a million dynes per square centimetre, and the millibar is $1/1000$ of the bar. Thus the normal pressure of the atmosphere, represented by a mercury column 760 millimetres long under standard conditions of temperature and gravity, is 1013.2 millibars.

3. Temperature: The Stratosphere

It is sometimes said that heat is transmitted in three different ways: by *conduction*, by *convection*, by *radiation*.

When a poker is thrust into the fire, the movements of the molecules of iron are violently increased, and this energy passes along from molecule to molecule until the distant end of the poker becomes warm. There is no forward bodily movement of the molecules, only a violent agitation which is passed on from one to another. The molecular disturbance is *conducted* through the poker.

When the lower part of a liquid or a gas is heated, it expands and becomes less dense, and the result is the formation of upward and downward currents. Such currents are called *convection* currents. In this case there is a bodily movement of the molecules. The currents are easily seen in a flask of water heated over a bunsen flame, to which a little oak sawdust or a crystal of potassium permanganate has been added.

If we are exposed to the sun or to an ordinary fire, some of the heat is obviously transmitted to us. But the transmission is not effected by the intervening air molecules, which neither pass on the heat energy from one to another as in conduction, nor carry it bodily forward as in convection. The transmission is effected by *radiation*. Like light, radiant heat is transmitted in waves, by the same wave-carrying medium (which we may still conveniently call the æther), and with the same velocity.

A certain amount of heat energy comes from the interior of the earth, but practically the whole of the energy which is the prime cause of all meteorological phenomena is radiated from the sun. The intensity of solar radiation is commonly known as *insolation*.*

Insolation depends on (1) the solar output of radiation; (2) the distance from the sun; (3) the inclination of the sun's rays; (4) transmission through and absorption by the atmo-

* Lat. *sol* = sun. Do not confuse with *insulation*: Lat. *insula* = island.

sphere. The last is by no means unimportant, for a good deal of the radiation is lost by absorption through the air, by reflection from cloud surfaces, and by scattering by dust particles. The greater part is, however, transmitted to the earth's surface, for most of the comparatively short solar rays stab their way fairly readily through the air, without warming it, to the surface of the earth. Then two things happen: a smaller part of the solar radiation, especially over the sea, is reflected back at once and for the most part lost; the greater part is absorbed by the earth's surface which it warms, and the earth's surface in its turn warms the atmosphere in contact with it. After warming the earth the sun's rays are radiated back in the form of much weaker terrestrial long waves, and these, unlike the incoming short solar rays, are readily absorbed by the atmosphere which therefore they help to warm. Hence it is not surprising to find that the temperature of the air diminishes with altitude, the rate of fall being, as we have said, about 1° F. for every 300 feet.

It must not be overlooked that heating and cooling of the air are also caused by adiabatic compression and expansion, respectively. The principle is exemplified by a bicycle pump, which quickly becomes warm by the compression of the air inside. If a mass of air is forced to descend, then the pressure on it will be increased, and its temperature will rise. If the mass is forced to rise, its temperature, conversely, will decrease as the result of expansion.

Figure 147 shows the unequal distribution of heat received by the earth. If the earth was flat, equal widths would receive equal amounts of heat, but as the earth's surface is curved, the amount of heat received by the width a at the equator is spread over the much greater width e at the poles.

The insolation naturally varies with latitude and with the time of year. The three-dimensional graph, shown in fig. 148, taken from Geddes' *Meteorology*, usefully shows these variations together.

Until recent years it was believed that the fall of temperature with altitude was regular and would go on until absolute

zero of temperature was reached,* and as long as manned balloons were used to investigate the upper atmosphere the rule was found to hold good. But when self-recording instruments on *ballons-sondes* were used, the fall of temperature was found to cease at a height of about 7 miles. This higher atmosphere in which diminution in temperature ceases with

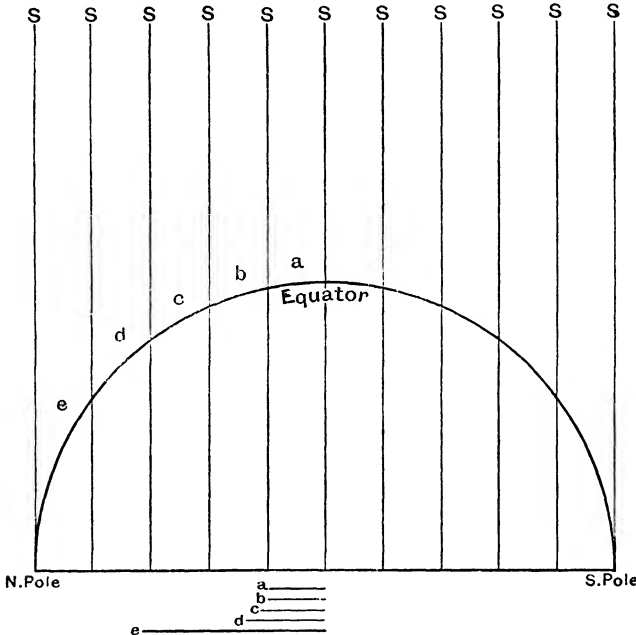

Fig. 147.—Diagram illustrating the unequal distribution of heat received from the sun

height is called the *stratosphere*. That part of the atmosphere below the stratosphere is often called the *troposphere*, and the boundary between the stratosphere and the troposphere is called the *tropopause*. The troposphere is the *inner shell* of the atmosphere, the part of the atmosphere we know, the

* Meteorologists generally refer their temperatures to the *absolute* scale, in order to avoid negative quantities. The actual degrees are of the same value as in the centigrade thermometer, but the freezing-point of water is marked 273° A. As is well known, the coefficient of expansion of gases is approximately $1/273$; hence the selection of the number. To convert temperatures referred to 0° C to the corresponding temperatures referred to the absolute zero, add 273.

turbulent part, the weather-varying part. The overlying stratosphere is not reached until a height of about 5 miles over the poles and about 10 or 11 miles over the Equator. Thus the temperature of the stratosphere over the equator is much lower than of that over the poles—a surprising fact. Below the tropopause the isothermal layers are more or less horizontal; above they are more or less vertical.

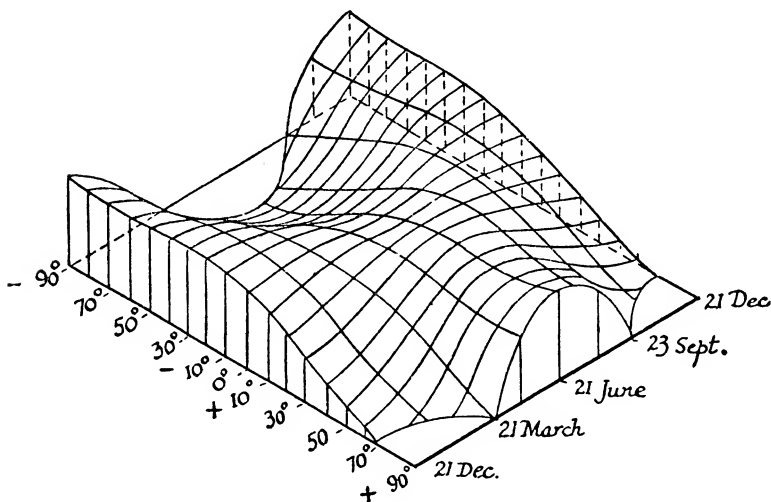

Fig. 148.—Three-dimensional graph showing varying insolation.

From what has been already said, it should be clear *why* there is a gradual diminution of temperature for the first few miles up. We may repeat and summarize. It is known from observation that the atmosphere transmits directly to the surface of the earth the greater part of the effective radiation received from the sun. It is therefore the earth's surface, where the energy absorption is concentrated, and not the atmosphere, that is chiefly heated by insolation. The heated surface in turn warms the air above it, partly by contact and partly by the long wave-length radiation which it emits and which is readily absorbed by the atmo-

sphere. But although there is this warming of the atmosphere from below, there must also be a cooling from above, where heat must be lost by radiation. This warming below and cooling above together establish and maintain the vertical convection currents of the atmosphere; and since the descending portions grow warmer through compression and the ascending colder through expansion, the whole of the convection region necessarily decreases in temperature with increase of height. The upper limit of this convection region is not, as formerly supposed, the outermost limit of the atmosphere, but is at a height (in our latitude) of about 7 miles, where the temperature is such that, in the convection region below, the loss of heat by radiation is equal to the gain by absorption.

Both the height at which the stratosphere begins, and the temperature of the stratosphere, depend on the season, on latitude, and on storm conditions. The fact of such an isothermal region has been definitely established by observation; the explanation (equality of absorption and radiation) was put forward by Colonel E. Gold and others, and is, of course, only an hypothesis, though it is based on the acceptable inference that, since the average yearly temperature of the atmosphere does not greatly change, the absorption of solar radiation by the earth as a whole is substantially equal to the total earth radiation emitted. Gold found mathematical expressions for the radiation and absorption in the atmosphere, which enabled him to reason about the "radiation balance-sheet" at different levels. He calculated that the approximate limit of the level below which convection can occur is 10,500 metres, a value ($6\frac{1}{2}$ miles) which agrees with the average height of the tropopause in temperate latitudes as revealed by observation.

Fig. 149 shows the distribution of temperature in the troposphere and in the stratosphere. It was prepared by A. E. M. Geddes from data quoted by W. H. Dines.

The coloured Plate (2) was also prepared by Geddes. It gives a diagrammatic representation of the vertical dis-

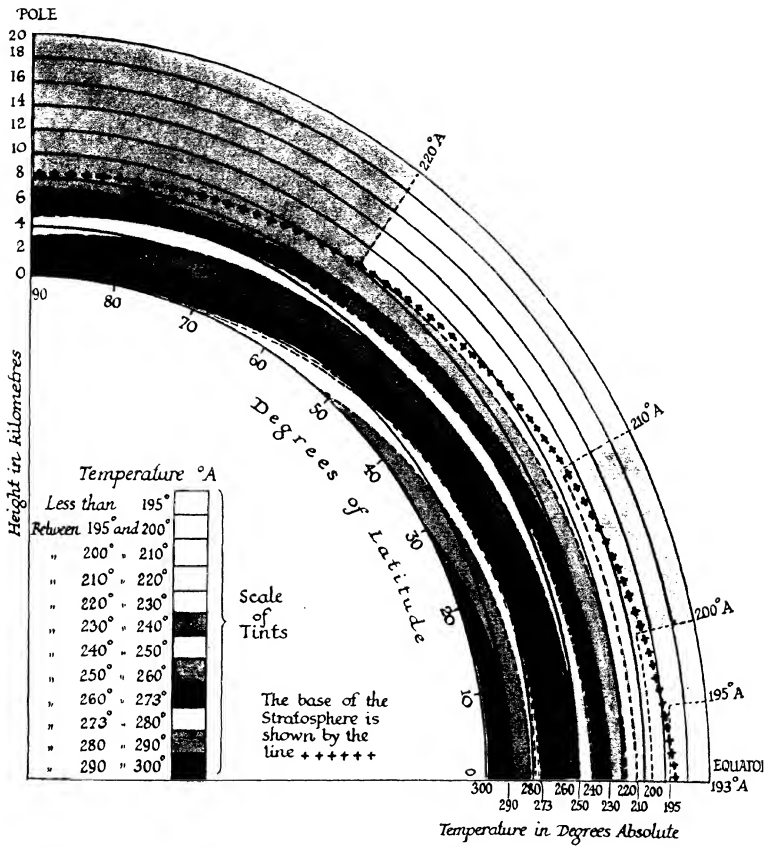

Diagrammatic Representation of the vertical distribution of air temperature

The Diagram shows the relatively small layer of air with a temperature above freezing-point (273° A.) that surrounds the earth in a belt

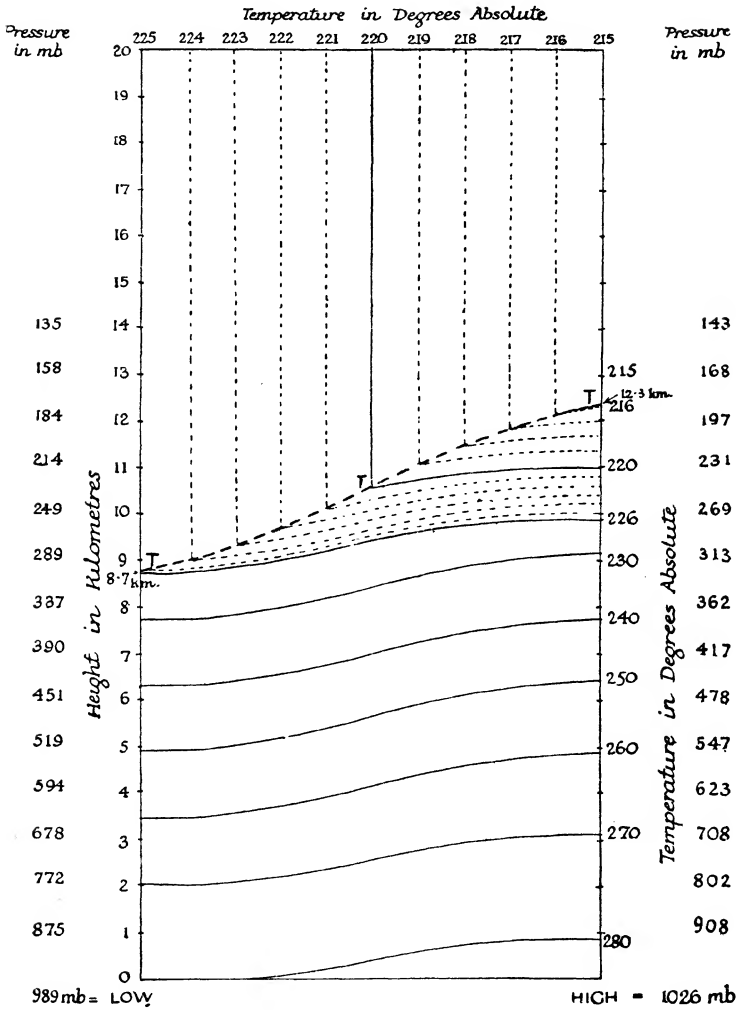

Fig. 149.—Tropopause and Stratopause

tribution of air temperature from the equator to the pole.

The problem is by no means so simple as it appears in this outline. For instance, water vapour plays a very important part in fixing the limits of convection, for it is a much better absorber and radiator of heat than oxygen or nitrogen, and its pressure exerts a marked influence on the balance of radiation.

The region of uniform temperature—the stratosphere—is at least 30 miles in thickness. Above, the temperature seems to rise again, but very little is yet known about this very inaccessible region. The stratosphere seems to act as a sort of roof to the troposphere, in the air movements of which it probably plays a predominantly controlling part.

The meteorologist's chief interest is in the convection region of the atmosphere—the troposphere—which he looks upon as the fly-wheel of a gigantic heat-engine, an engine for converting solar energy into the energy of the winds. It is in a state of perpetual motion. But how does the engine work?

It is commonly said that thermal convection consists of the rising of warm air and the sinking or flowing in of cold air to take its place. But this description implies the false notion that warm air has some inherent ascensional power, whereas, in reality, *thermal convection is only a gravitational phenomenon, consisting in the sinking of relatively heavy air and the consequent forcing up of other air which, volume for volume and under the same pressure, is less dense and relatively light. Any atmospheric circulation is simply a gravitational effect induced and maintained by temperature differences.*

Let the vessels M and N (fig 150) be filled with cold water to the same level AB, CD, slightly above the upper connecting pipe P; obviously there will be no flow of water from one vessel to the other, either through P or through the lower connecting pipe Q. Now let P and Q be closed and let the water in M be uniformly warmed. This water will expand and will reach the new level XY. If Q be opened, no circulation takes place, as the pressure on the bottom of both

vessels is the same as before. On the other hand if, instead of Q, P be opened, water flows from M to N, since the level XY is higher than the level CD. But this will increase the pressure on the bottom of N and reduce that on the bottom of M, so that if Q be now opened water will flow from N to M. Thus by warming M, a circulation can be set up. So it is with adjacent columns of air at different temperatures. The heated column will expand and become less dense, and there will be an overflow at the top on to the colder. There will thus be a reduced pressure of the heated column and an

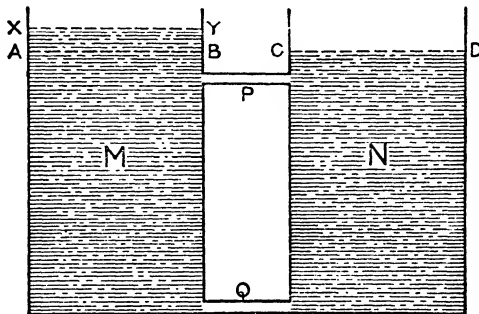

Fig. 150.—Connected vessels of water

increased pressure of the colder column. The latter tends to sink under gravity and it thus displaces and drives up the former. This is typical of, for instance, all chimneys. It is ordinary thermal convection.

We do not yet know much about the part that the stratosphere plays in the economy of nature, though facts concerning it are gradually accumulating. The part of the atmosphere we are familiar with, the troposphere, is a uniform mechanical mixture mainly of nitrogen (78.03 per cent) and oxygen (20.99 per cent) with small amounts of argon, carbon dioxide, hydrogen, neon, and helium. (A variable amount of water vapour is also generally present). The composition at the earth's surface is remarkably constant, but this constancy does not seem to extend into the stratosphere. Beyond the region of convection, where there is no longer any vertical tempera-

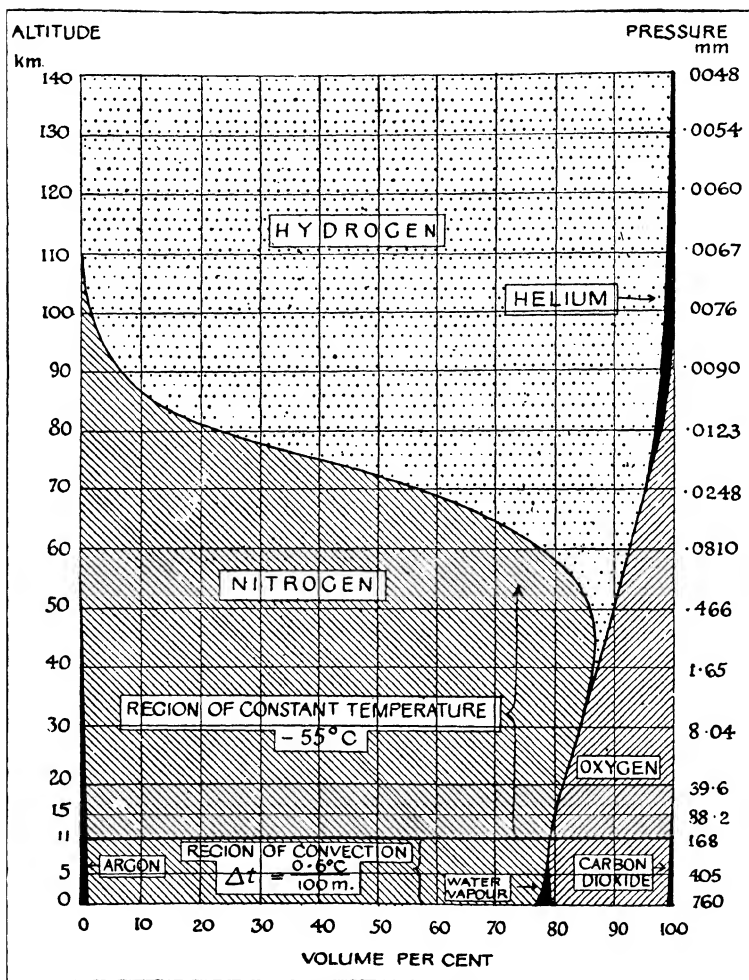

Fig. 151.—Distribution of the gases in the atmosphere (after Humphreys in the *Mount Weather Bulletin*, Vol. II)

ture gradient, the gases seem to arrange themselves in layers, according to their densities. Fig. 151 shows the estimated varying quantitative distribution to a height of 140 kilometres (87 miles). Above 110 kilometres (70 miles) there would thus seem to be nothing but hydrogen and helium. The distribution is according to **Humphreys**, but other investigators assert that the upper atmosphere consists almost entirely of helium, hydrogen being absent. The spectrum of the aurora, however, makes both hypotheses equally improbable. There is a very great deal of doubt about the whole question, especially since the discovery of the Appleton layer (p. 727), and any hypothesis is bound to be highly speculative. Historically, however, fig. 151 is full of interest.

4. Weather Maps

Fig. 152 is a typical map as prepared by the Meteorological Office every day from records made by observers at different stations. Immediately on receipt of each telegram, the information which it contains is plotted on a large-scale outline map of Europe on which the positions of the stations have been marked in advance. Against each station is written the appropriate barometer reading, temperature, wind direction and strength (the last by an arrow and the number of "fleches" in its tail). The weather is indicated by letters or by conventional symbols, a notation originally suggested by Admiral **Beaufort** in 1805. On every such map the most interesting features are the continuous lines drawn through all stations having the same barometric pressure at the time of recording. Such lines are called *isobars*, and the barometric readings are systematically shown in millibars.

The general interpretation of such a map is simple. The first thing to be noticed is the obviously intimate relation between the spacing of the isobars and the distribution of the wind. Where the isobars are close together, then the wind tends to be strong, and *vice versa*.

(the wind) from high to low will be gentle (fig. 152); a steep gradient of barometric pressure is shown by isobars close together, and the air-flow from high to low will be rapid (fig. 153).

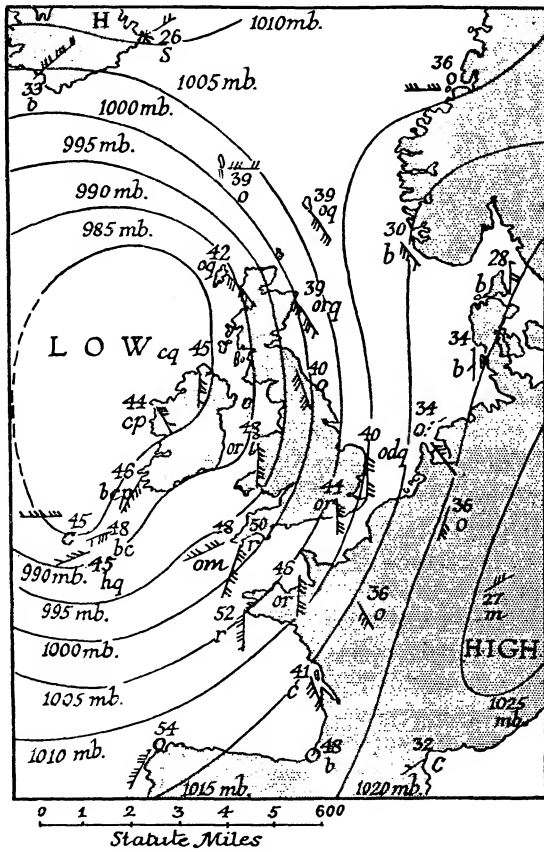

Fig. 153.—Wednesday, 17th Feb., 1915

We should expect the air-flow (the wind) to be at right angles to the isobars, but a glance at the arrows in figs. 152 and 153 shows that these are usually more or less *inclined* to the isobars. The actual relation is neatly summed up in the law of **Buys Ballot**: "Stand with your back to the wind;

the region of lowest barometer will then be on your left, but slightly in front of you." In the southern hemisphere the relation is reversed, the lowest barometer being on the observer's right, while at the equator the law does not apply.

Buys Ballot's law has nothing to do with meteorological theory; it is not an hypothesis; it is simply a generalization of facts actually observed. The expected normal direction of the wind from high to low—the direction perpendicular to isobars—is not followed because of a permanent disturbing factor, namely, the rotation of the earth. The earth rotates from *west to east*; at the equator its speed is about 1000 miles an hour, and this diminishes to nothing at the poles. Because of this rotation, the superincumbent air tends to lag behind and thus a wind from *east to west* at the equator is set up, a wind which is quite independent of all local barometric disturbances. The diminishing velocity of the earth-spin from the equator to the poles tends to cause this wind to slew round towards the poles and to impose a circular motion on any air current travelling in the opposite direction.

The simplest cases of isobars are those where the pressure decreases or increases around some central point, i.e. where the isobars form a series of closed curves, more or less like concentric circles. When the pressure *decreases* towards the centre, we have a *cyclonic* system; when the pressure increases towards the centre, we have an *anticyclonic* system. Fig. 152 represents an anticyclone; fig. 153 represents a cyclone.

In the case of a cyclone, instead of the air-flow travelling directly from high to low, that is, directly inwards *towards* the centre as if along the spokes of a wheel, it is deflected by the earth's rotation in such a way as to travel round *spirally*, in the northern hemisphere, in an *anti-clockwise* direction, and in the southern hemisphere in a *clockwise* direction. In the case of an anticyclone, instead of the air-flow travelling directly from high to low, that is, directly outwards *from* the centre as if along the spokes of a wheel, it is deflected by the earth's rotation in such a way as to travel round spirally in a

clockwise direction in the northern hemisphere, and in an *anti-clockwise* direction in the southern hemisphere.

The cyclone, depression, or "low", as it is sometimes called, is usually accompanied by a definite series of weather changes depending on its rate of travel. Its coming is heralded by rain which begins in a drizzle and develops into a down-pour as the centre of the depression approaches and passes, and then showers with gusts or squalls of wind are experienced. The counter-clockwise direction of the wind, as the disturbance passes over, is readily observable. If the isobars are close together, the winds are certain to be strong. The map * (fig. 153) should be examined for wind (force and direction), rain, &c., and the consequential relations of the isobars noted. The average duration of a cyclonic disturbance is usually about 24 hours. We might almost pick up from a weather chart the whole isobaric system of a cyclone and drop it again 300 or 400 miles to the east (the general forward movement is usually more or less to the east) to indicate the changed weather conditions 24 hours later. Unfortunately, however, meteorological conditions are never quite so simple as this. Unexpected and incalculable factors are apt to creep in and spoil the forecasts of even our leading experts. Still, we may legitimately allow our imaginations to run riot so far as to picture a cyclone—a deep depression, as Broadcasting House delights to call it—as a huge, whirling, disc-shaped, vortex-ring of air, travelling across country at 20 or 30 or more miles an hour.

An anti-cyclone or "high" is generally indicative of favourable settled weather. In a map (fig. 152) its isobars are seen to be rather widely spaced, from which we may correctly infer that the winds are light. On the fringe of an anti-cyclone the isobars may be closer together, and then we should expect stronger winds; in the map many-feathered arrows may be observed in Ireland, the Hebrides, and in Norway. An anti-cyclonic system tends to travel very slowly

* *b* = blue sky; *c* = cloud; *d* = drizzle; *h* = hail; *m* = mist; *p* = passing showers; *s* = squalls; *r* = rain.

across a country, and may indeed be almost stationary for several days.

No very satisfactory hypothesis of the origin of the cyclone has been agreed upon. The hypothesis which prevailed to about 1915 was that a cyclone was initiated by thermal convection and was maintained largely by the liberated heat of condensation. This hypothesis has now definitely broken down. The hypothesis which is now favoured but which has not yet been mathematically worked out is that cyclones are due to collisions between: (1) cold air from the polar regions which obviously flows off equatorward and thereby acquires, if not checked, an increasingly westward direction; (2) warm air from equatorial latitudes which, of course, moves poleward and thereby acquires, if not checked, an increasingly eastward direction. On meeting there is a struggle for the mastery, and it is perhaps in this way that a cyclone is born.

The weather forecaster's task is rather a thankless one. With his daily chart completed, and with the probabilities weighed as to the alterations of pressure systems on the chart during the next 24 hours, he hazards an opinion. His proportion of correct forecasts is slowly increasing, for his empirical studies are gradually being worked up into a subject of exact science. But the row he has still to hoe is a long one.

It is becoming clearer every day that if we are to understand our weather, we must trace back to their origin the polar and equatorial air masses which meet in our latitudes. At present we know very little of the meteorology of the polar regions, though the year 1883 was a landmark in polar investigation when twelve countries sent out fourteen expeditions to make a concerted attack on the problems connected with the meteorology and terrestrial magnetism of those regions. The year was known as the First International Polar Year. A second international undertaking was organized during the summer of 1933; it was a sort of jubilee celebration, and results of the highest importance were obtained. The new undertaking was due to Admiral **Dominik** of the Deutsche

Seewarte, and, as shown in fig. 154, stations were set up and equipped all round the Arctic Circle. Even Austria and Poland helped. The new station established by the Danes at Thule was a particularly important one, for it is situated quite close to the magnetic axis of the earth and it was specially well equipped, instruments for wireless observations and

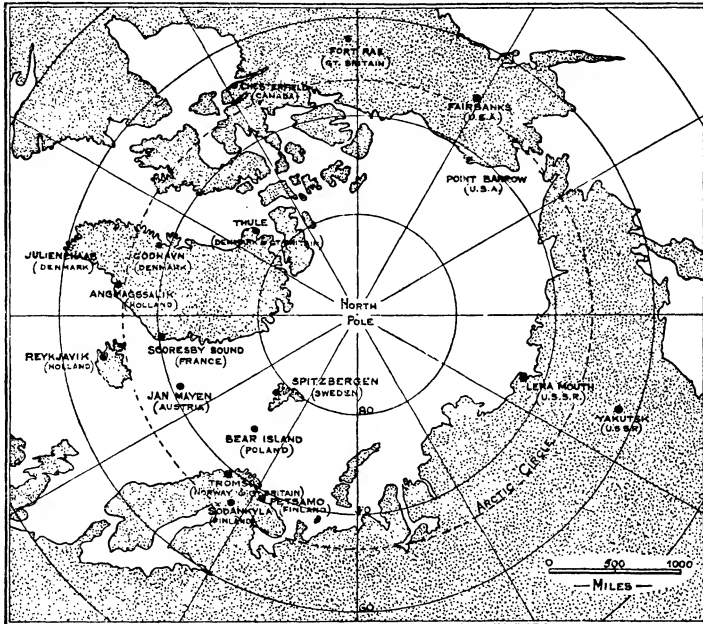

Fig. 154.—Jubilee polar year expeditions, 1933

observations of the cosmic radiation being included. The Dutch expedition at Angmagssalik made a complete set of observations on the Heaviside-Kennelly layer. The Swedish party at Spitzbergen included the veteran Professor **Carlheim Gyllenskiöld** who took part in the 1883 expedition. Professor **Störmer** of Norway made himself responsible for organizing the aurora observations and the measurements to be taken by all parties. The place selected by the second party sent out by Great Britain, under the leadership of Professor **Appleton**,

was Tromsø. Over forty of the specially rapid photographic instruments invented by Dr. **la Cour** of Denmark were used by the different expeditions.

5. Radio Geophysics. The Ionosphere

During the last few years we have obtained a considerable number of facts concerning the upper atmosphere, as the result of special investigations made on behalf of wireless workers.

How do the wireless waves travel? Since they are virtually identical with light waves, they were expected to travel in straight lines, save for such deviation as might result from refraction and diffraction effects. The first radio-telegraphist of all was **Clerk Maxwell**, from whose well-known equations the simplest conceivable method of wave-travel, viz. in straight lines, followed; but **Marconi's** successful effort to signal across the Atlantic clearly showed that there was a departure from straight-line propagation. It was already known that a ray of light, if transmitted tangentially to the earth's surface, would follow a path slightly curved towards the earth, but this seemed to be satisfactorily explained by atmospheric refraction. Professor **Ambrose Fleming** showed conclusively, however, that the effect of atmospheric refraction on wireless waves was negligible.

Certain experimental investigations intensified the difficulty rather than cleared it up. For instance, the results obtained by wireless amateurs using very short waves gave theorists a great shock. Amateurs were allowed to transmit and receive rays up to 100 metres in length, the authorities assuming that the small power used and the rapid absorption of short waves by the earth would not seriously interfere with commercial wireless. But amateurs soon found out how to transmit to England signals from America, and even from New Zealand, using less energy than is represented by an ordinary incandescent lamp. Theory was altogether flouted.

How did the waves travel? They had certainly not been absorbed by the earth; they had certainly not been lost in the depths of space; they had certainly not followed a straight path; and the curved path which they did seem to have followed had certainly not been imposed on them by an ordinary action of the atmosphere.

The need for a "deflecting" region in the upper atmosphere had been anticipated by two different workers as far back as 1902, Professor A. E. Kennelly of Harvard, and Oliver Heaviside (1850-1925) of London. In 1912, W. H. Eccles directed attention to the possible influence of the ionization of the upper atmosphere on the propagation of electromagnetic waves through it. Wireless workers began to think that these suggestions might prove fruitful, and they asked the geophysicists to provide them with further knowledge of the properties of the higher regions of the atmosphere.

We have already seen that the geophysicist has, by the help of direct measuring instruments, learnt a good deal about the lower part of the stratosphere, but it is not until a height of 30 miles is reached that he is able to obtain much information that is of special interest to the radiotelegraphist. At this height *ozone* is found, some of the oxygen of the atmosphere being dissociated by ultra-violet light, and this action is accompanied by *ionization*, which naturally suffers a rapid reduction after sunset as a result of recombination. Further knowledge of such ionization in the higher regions of the atmosphere has been obtained from (1) the study of the *aurora*, (2) investigations in *terrestrial magnetism*.

As a result of experimental work of this kind, the geophysicist was able to inform the wireless worker that, concentric with the earth, there is a spherical wave-conducting layer, which he had called the **ionosphere**; that the conductivity is due to ions; that the probable ionizing agents are: (1) ultra-violet light, and (2) perhaps charged or neutral particles projected from the sun, so that the layer is likely

to be much more highly conducting on the side of the earth exposed to the sun than on the side in darkness. The geophysicist was not able to determine heights very accurately, but he discovered that ozone is most dense at about 30 miles, and that the electron streams produce aurora at heights of from 60 to above 300 miles.

The wireless worker was now able to understand more clearly many of the phenomena which he encountered in his experimental investigations of the results of emitting waves from a radio station. For general broadcasting services, he commonly uses moderately long waves (200 to 2000 metres) which travel *along the ground*, and he knows that the distance to which they travel before their field intensity falls to some specific value increases as the wave-length is increased. But the waves he sends skywards (we may call them *sky waves*) will be refracted by the ionized portions of the upper atmosphere, and on reaching a height at which the density of ionization is great enough, the deviation will be such as to return the waves to the earth's surface.

Sky waves of 50 metres from an antenna power of 5 kilowatts are returned to the earth and affect a receiver at a minimum distance of 2500 miles. Under the same conditions *ground waves* will be detectable at distances only up to about 90 miles. There will thus be an annular space around the emitting station, between the radii of 90 and 2500 miles, where no signals will be detectable. As the wave-length is increased, this "skipped distance" will be decreased owing to (1) the greater refraction effects of the ionization layer, and (2) the greater range of the ground waves. Finally, the sky waves and ground waves overlap, and the wireless worker's skipped distance is closed.

A great deal of additional work has been done during the last two or three years, much of it by the wireless workers themselves, who have obtained valuable hints of procedure from other branches of physics. In acoustics, for instance, if we wish to determine the distance of a wall by observation of the time interval between the transmission of a sound

impulse and the reception of its echo, there is no difficulty, sound travelling relatively slowly. In the case of wireless waves, the corresponding echo-times are to be measured in thousandths of a second; nevertheless, such measurements can readily be carried out by that ingenious instrument, the cathode ray oscillograph. A packet of waves may be shot up skywards, reflected by the ionization layer, returned to the earth, and the time of the return journey noted. This evidently gives us the height of the layer. Again, if two notes which are not quite in unison are sounded together ("deep" next-door neighbours on the piano will do fairly well) a peculiar palpitating effect is produced; we hear a series of bursts of sound with intervals of comparative silence between them. These bursts of sound are called *beats*, and are a simple wave-interference effect. In general, the frequency of beats is the difference of the frequencies of vibration of the beating notes. In 1924 Professor **Appleton** and other workers associated with the British Radio-Research Board devised an elegant beat method for measuring the height of the ionization layer; it was really a determination of interference effects between the ground and the sky waves.

Radio workers have now conclusively proved the existence of the Kennelly-Heaviside layer in the ionosphere at an average height of about 60 miles. The height usually increases at night, the maximum value being reached an hour before sunrise. With wave-lengths less than 400 metres, the height of the deflecting layer sometimes suddenly changes from 60 miles to 150 miles. On such occasions the density of ionization in the Kennelly-Heaviside layer is insufficient for the deflection of the shorter waves which thus penetrate this layer, but are deflected by a second and higher layer. This second layer has become known as the **Appleton** layer.

The density of ionization in the two layers has been found by ascertaining the limiting wave-length or frequency of the waves which will just penetrate each of them. It has been definitely established that there is very little ionization between the Kennelly-Heaviside and the **Appleton** layers, and that for

wave-lengths less than about 8 metres, the waves penetrate both layers, and as yet there is no evidence of their return to earth from the upper atmosphere. Fig. 155 shows the various layers diagrammatically. The heights and thicknesses shown are necessarily only very rough approximations.

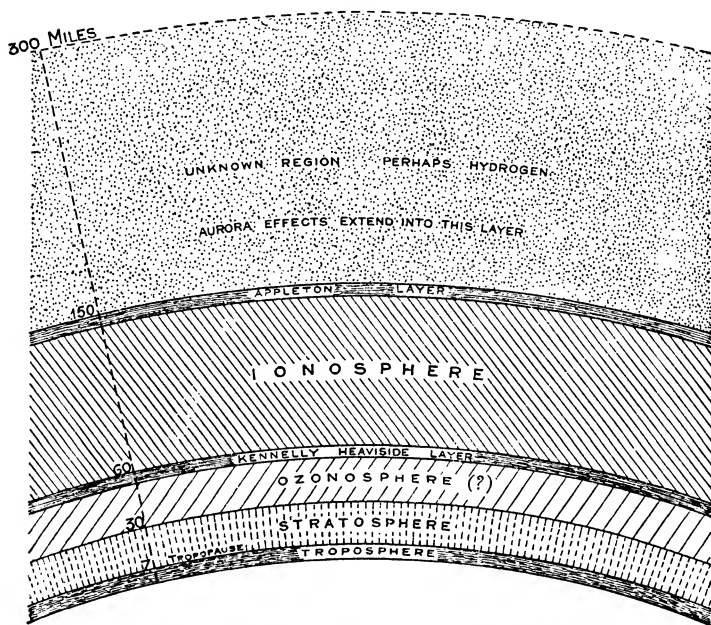

Fig. 155.—Diagram showing succession of atmospheric layers. Heights are rough approximations

As to the cause of the ionization, some data obtained during the solar eclipse of 31st August, 1932, appeared to establish the fact that the principal ionizing agent for the two layers is ultra-violet light. The possible bombardment of the earth by neutral particles is not yet wholly excluded.

Professor **Appleton**, summarizing his work at Tromsø in 1933, said: "Our results as a whole show that to account for wireless phenomena in high latitudes, we must take into account both the normal influence of ultra-violet light and the abnormal influence of ionizing charged particles.

The term "layer" is probably too definite, and the alternative term "region" is now being applied to both the Kennelly-Heaviside and the Appleton layer.

Many puzzling wireless irregularities remain to be explained; many secrets of the upper atmosphere remain unrevealed; but at the new Halley Stewart laboratory at Hampstead, opened by Lord **Rutherford** in May, 1933, Professor **Appleton** and his staff may confidently be expected to solve many of the difficult problems still outstanding.

The Marchese **Marconi** is now engaged in research on "micro-waves" (those of under 1 metre), and he hopes that when he has succeeded in applying great power to such waves, further discoveries of importance may be made, especially in the field of television.

6. Meteorological Matters of Special Interest

Meteorology is too frequently associated merely with weather reports and forecasts. Comparatively few people seem to have trained themselves to become systematic observers of sky effects. We can afford space only to mention a few topics which may profitably be read up and if possible investigated. Atmospheric colour effects may be wonderfully interesting.

1. **Clouds.** Classification into four principal types, *nimbus*, *stratus*, *cumulus*, *cirrus*. Combinations of these. Heights of clouds and how measured. The nephoscope. Formation of clouds. Fog, mist, rain, snow, hail.

2. **Thunder and Lightning.** Kinds of lightning; colour; destructive and other effects. Conductors. Old and modern theories of atmospheric electricity. Estimation of distance of the discharge.

3. **Rainbows.** Colours. Primary and secondary bows. Supernumerary bows. Cause of the rainbow and how it is formed. Geometrical theory of the rainbow.

4. **The Mirage; the Fata Morgana.** Formation.

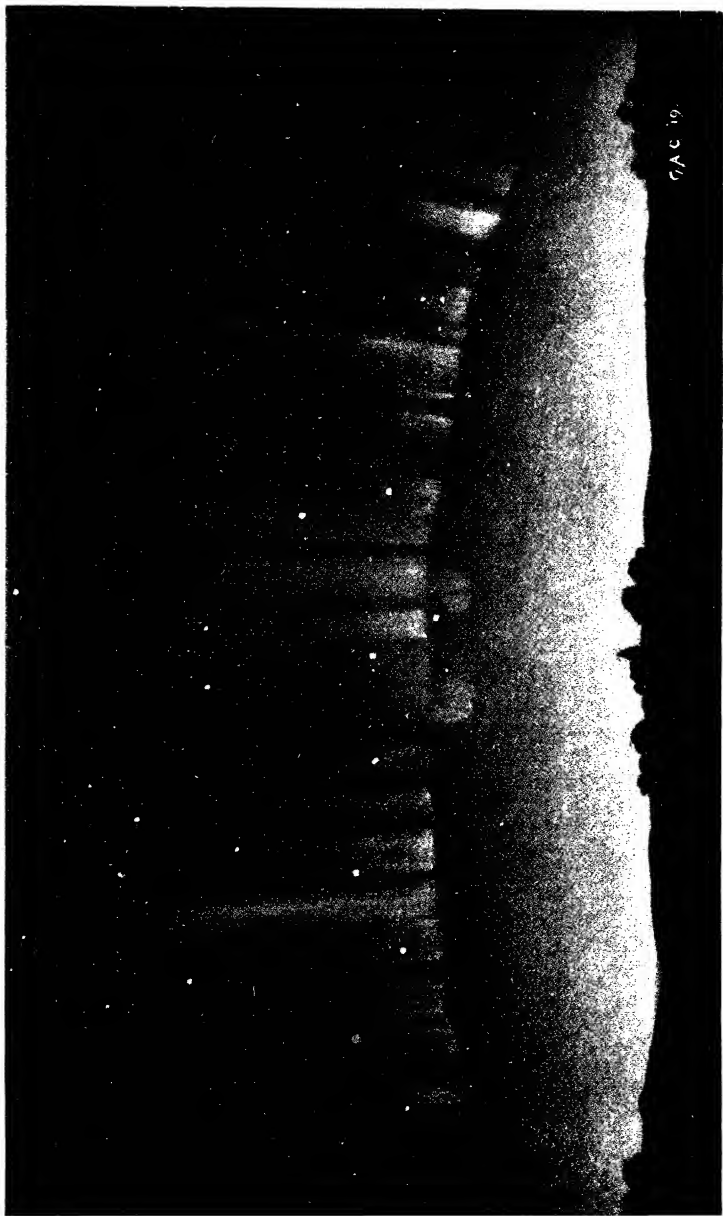

7AC 19

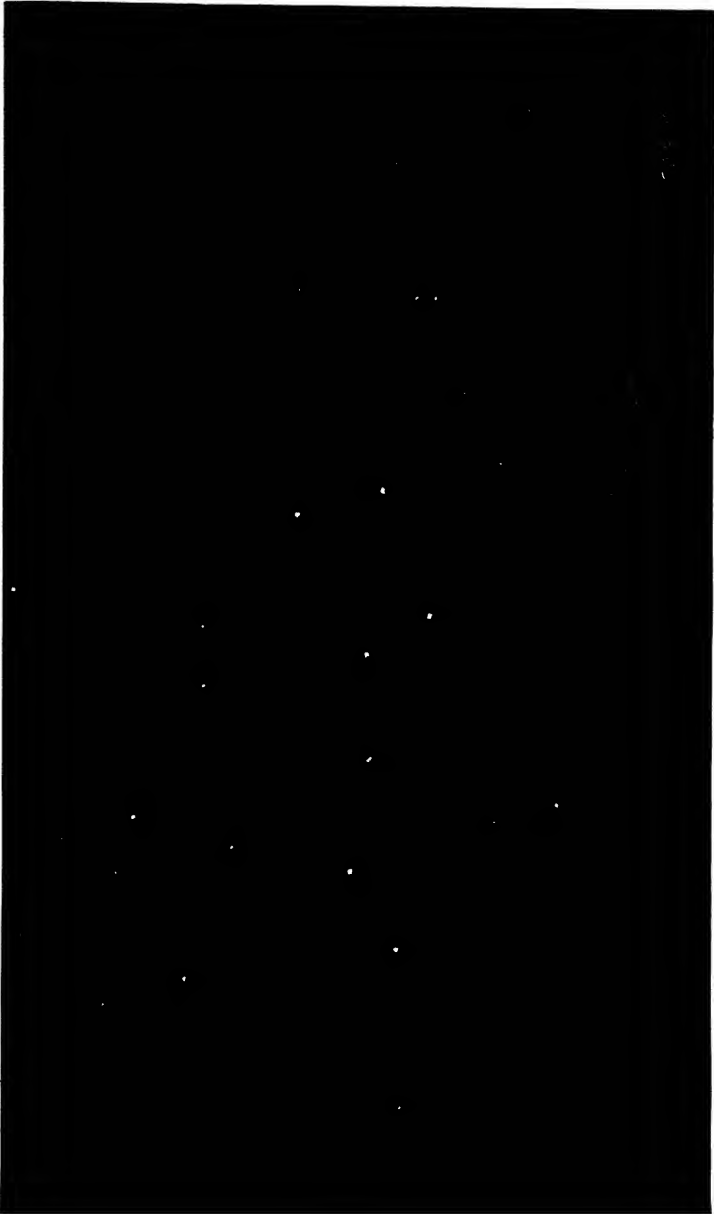

AURORA BOREALIS. SHOWING STREAMER CURTAIN

CHAPTER XLIII

Biology

The average educated man is profoundly ignorant of the fundamental principles of biology, a fact which is due in no small measure to the past general neglect of biological teaching in all types of secondary schools. It has probably never occurred to him what an extremely important part biological science plays in the modern civilized state. It will suffice here to mention just two points: (1) the provision of food for the community—crop-raising, stock-breeding, dairy products, fisheries, and the preservation of food by canning and freezing; (2) the maintenance of the health of the community—the prevention of disease, the war on parasitic microbes, and the cure of disease by the modern methods of medicine and surgery. Obviously all these things are immensely complicated applications of biological science.

The student of biology should always bear in mind three guiding principles: (1) *the great fact of evolution* (it is *probably* a fact) and its far-reaching implications, especially nature's struggle for existence and the elimination of the unfit; (2) *the great fact of inheritance*—the fact that the child repeats the characteristics of the parent, physical, mental, and moral, but that this repetition is never so complete as to amount to identity of such characteristics; (3) *the great fact of the biology of communal life*, not only as presented by cell communities of social insects, such as bees and ants, but also (which is of far greater importance) as presented by cell communities constituting the bodies of all animals and plants, except the few single-celled organisms at the very

bottom of the scale. A living animal or plant is an amazingly well-organized community of vast numbers of cells, every cell a perfect physical and chemical laboratory, every cell doing specialized work, the whole directed and co-ordinated in some unknown way but with such perfection that human society can never hope to emulate it. There are some people who regard the living thing as a self-regulating automaton; there are others who cannot bring themselves to believe that such a marvellous machine can work without a directing Agent. All admit the wonderful complexity, the wonderful organization, and the wonderful co-operation and co-ordination.

Although a living organism (i) has the power of self-maintenance and of preserving its individuality, (ii) takes nutriment, and (iii) grows and reproduces itself, we are bound, when investigating it, to treat it as a physico-chemical mechanism: how else could we proceed? But the organism certainly seems to be something more than the sum of all its parts and their physico-chemical relations; it is a unified and purposeful individual. How the physical and psychical are related we do not know, but that they *are* related is certain. For instance, the change in the moral character of a man is sometimes the effect of a brain lesion due to a blow on the head; or bad news may bring about a psychical disturbance which results in a marked physical disturbance of the body, temporary or permanent. The relationship is, however, an unsolved mystery.

As far as we can tell, an animal which has just died is chemically identical with what it was when alive. It serves no good purpose to "explain" things by dogmatically asserting the presence in a living organism of a "vital force", of an "entelechy", or some other elusive, hypothetical, responsible working principle. It is more honest to admit that we know nothing at all about any kind of inner directing agent, and that we know nothing at all about the nature of life. The wise biologist does not proclaim to the housetop that he is a materialist, a vitalist, or any other -ist, but he gets on with his job. He

collects facts and ever more facts. He is content to explain *how*, and admits—a little ruefully perhaps—that he cannot discover *why*.

The Subdivisions of Biology

The connotation of the word “Biology” (Gk. *βίος*, life, *λόγος*, discourse) is a little vague, but the term may well be interpreted literally, viz. that branch of science which deals with living things. It was first used in the early part of last century but it was Lamarck who popularized it, and at first it was used as the rough equivalent of the much older term “Natural History”. It is now used as an all-embracing term for several specialized branches of study.

The first and most obvious division of biology is into the two studies of plants and animals, **Botany** and **Zoology**, respectively. The broad distinction between plants and animals is that plants contain chlorophyll and cellulose, and make their own starch and sugar, while most animals have to depend, directly or indirectly, upon plants for their food. But both plants and animals may be considered from two points of view: (1) that of the *anatomist*, who dissects out the large-scale organs, and the *histologist* who examines the minute tissues; both are interested in the structural *forms* of plants and animals as wholes. The anatomist's subject is thus **Morphology** (Gk. *μορφή*, form); it is the *static* side of biology. The morphologist studies shapes, positions, and connexions; (2) that of the *physiologist*, who deals with the *dynamic* side of biology, the aspect expressed by the term *function*, that is, the study of the activity of the various organs and tissues, the active life of individual cells, the metabolism of the protoplasm. Thus morphology is contrasted with **Physiology**.

To the study of morphology belongs the study of anatomy and histology of extinct species, termed **Palæontology** (Gk. *παλαιός*, old).

The study of the early stages in the growth of the organism, its organs, and its tissues, is called **Embryology** (Gk. *ἔμβρυον*, embryo, fetus), which includes both the morphology and the physiology of the developing organism.

Although life is limited to the individual, it is continued in the race, and this suggests the studies of **Evolution** and **Heredity**. **Genetics** is intimately connected with the study of Heredity; the term was suggested in 1906 by Bateson. Its problems are those of the ways in which offspring inherit certain characteristics and yet at the same time have individual differences. **Eugenics** has for its aim the perpetuation of those inherent and hereditary qualities which aid in the development of the human race.

The study of the diseases of organisms has for its basis the study of **Bacteriology**.

Ecology (Gk. *οἶκος*, an abode) is the study of living things in their own environment, among their friends, competitors, and enemies.

The biologist's term for "classification" is **Taxonomy** (Gk. *τάξις*, a classified scheme), and his successive grades from below, upwards, are *individual*, *variety*, *species*, *genus*, *family*, *order*, *class*, and *phylum* (Gk. *φῦλον*, a tribe), terms implying wider and wider circles of relationship. As we shall see, the biological term *species* has great significance. The *phylum* is a primary division, a main trunk.

Biology in the Eighteenth and Nineteenth Centuries

Before we can profitably deal with twentieth-century developments of biology, we must refer to the advances made by earlier workers. Although it is not until comparatively recent times that biology has become so big a subject as to be beyond the mastery of any single individual, yet almost from the first it has been the custom of biological workers to confine their main interests to some particular corner

of their field. Thus some have worked at classification, some at cell structure, some at embryology, some at physiology, and so on. We must confine our references to the most distinguished workers, and will do so mainly in chronological order.

No branch of science can make any headway until it is reduced to some sort of system, and one of the earliest tasks of biologists was to devise some logical scheme of classification of plants and animals. **John Ray** (1627-1705), a mathematical lecturer at Trinity College, Cambridge, and his friend **Francis Willughby** (1635-72) together planned out a scheme for a description of the whole organic world, Ray taking up plants and Willughby, animals. Willughby died early, and it is Ray's name that is usually associated with the founding of biology as a systematized branch of science. The Swiss naturalist, **Charles de Bonnet** (1720-93), a great authority on insects, unified into one system the different branches of biology which, up to that time, had been developing independently. The French naturalist, **Comte de Buffon** (1708-88) was of opinion that the facts of zoological classification supported the hypothesis of animal evolution; his *Natural History* appeared in 45 volumes and its publication occupied 55 years.

But it is **Carl Linnæus** (1707-78), the Swedish botanist, who has always been recognized as "the greatest of the systematists". As a boy "he had a perfect mania for classifying things", and instead of going into the Church as his father had intended, he became curator of Professor Rudbeck's botanical garden, and afterwards himself became Professor of Botany at the University of Upsala. Linnæus succeeded in assigning to every known animal and plant a position in his system. This involved placing any specimen first in a *class*, then in an *order*, then in a *genus*, then in a *species*. Our greatest debt to him is his device of "binomial nomenclature": to every animal and plant he gave a double name. The first name was the name of the *genus* (a capital

initial letter is always used); the second name was the name of the *species*. Thus he wrote:

Canis familiaris, for the domestic dog.
Acer rubrum, for the red maple.

It is just as if we wrote our own name, *Smith john, Robinson mary*. The name of a variety is added as a third name, e.g. *Acer rubrum drummondii* (Drummond's red maple). These names are in universal use, and are found in the textbooks of all the nations.

Linnæus's great system of classification, the *Systema Naturæ*, has, in fact, been accepted by all naturalists. Its significance should be fully grasped, for it indicates how different kinds of animals may be quite distinct and yet be nearly related to one another—how different *species* are members of the same *genus*. Thus:

<i>Corvus corax</i> , the raven.	<i>Corvus cornix</i> , the hooded
<i>Corvus corone</i> , the carrion	crow.
crow.	<i>Corvus frugilegus</i> , the rook.
<i>Corvus monedula</i> , the jackdaw.	

The five species all belong to the single genus *Corvus*. They are all "crows" of sorts, but the differences are "specific", and definitely divide one "kind" from another.

Linnæus was not always quite correct. For instance, in flowering plants he attached far too much importance to the *numbers* of parts, such as stamens. In some respects, therefore, his system has been superseded, in order that deeper resemblances may be stressed.

It seemed to Linnæus that each of his different species (kinds) was worthy of a name of its own, for it was marked by a number of constant characters which were faithfully reproduced in the offspring. Thus ravens and rooks are quite distinct kinds (species) though belonging to the same genus; so are dogs and foxes. This was the *pre-evolution idea of the fixity of species*. "There are as many species as issued in



CHARLES R. DARWIN

From the portrait by the Hon. John Collier in the National Portrait Gallery

pairs from the Creator's hands," Linnæus said. But towards the end of his life he admitted that facts were too strong for him, and that new species may sometimes be produced by the crossing of old.

Gilbert White (1720-93) was a country parson who was born at the Hampshire village of Selborne where, later in life, he held a curacy. His life has been well described as a round of tranquil observation of nature. He was essentially a naturalist, or as we nowadays usually say, an ecologist. He studied the habits of living creatures and the relations of the creatures to one another. He made mistakes, but his mistakes were few, and not many field-observers have reached so high a standard of accuracy. Indeed most of his observations are worth following up carefully even now. For instance, he was probably the first to direct attention to the value of protective coloration, which he studied in young stone-curlews, practically invisible on the flinty fields. He noticed that on the cast slough of a grass snake the eye scales have the convexity inwards, for these creatures "crawl out of the mouth of their own slough and quit the tail part first". He mentions that "the water wagtail is the smallest English bird that walks with one leg at a time; the rest of that size and under hop two legs together." Such observations are typical of his *Natural History of Selborne*, a little book still valued for its high literary qualities. White was a collector of facts; he was in no sense a theorist.

Marie François Xavier Bichat (1771-1802) was a brilliant French physiologist who died at the early age of thirty-one. He is regarded as the founder of general anatomy. He observed that the different organs and parts of the organs of a body, for instance, bone, cartilage, muscle, and nerve, may be analysed into certain elements of specific appearance and texture. He likened the structure to a woven fabric, and introduced the term *tissu*, an old term for a kind of rich cloth. But his analysis of the body into "tissues", of which he claimed to have identified twenty-one, has survived only in name. Essentially his idea was that the life of the whole

body is the resultant of the combined and adjusted lives of the various body tissues. He held to the conception of a definite "vital force". After his death the special study of the minute structure of the tissues came to be called *histology* (Gk. *ἵστός*, a tissue), a term introduced by Owen.

Georges Cuvier (1769-1832) was the son of a Swiss officer in the French army and was born at Belfort. He was pre-eminently an anatomist, and was really the founder of Comparative Anatomy. He might also be called the founder of Palæontology, for he demonstrated the value of studying living forms alongside fossil forms. The conception that guided his work was *the principle of the correlation of parts*. He rightly insisted that the organs of the body do not function as separate entities but as parts of living wholes. In these living wholes, certain relations are observed which are fundamental to their mode of life. We infer from a feather that its owner had a particular form of collar-bone; we infer from a particular form of collar-bone that its owner was feathered. Cuvier opposed the evolutionary ideas which were beginning to insinuate themselves in zoology. He wanted *facts*, and had little patience with speculation.

Visitors to the Natural History Museum at South Kensington will remember the imposing statue on the staircase leading up from the great hall, that of Sir **Richard Owen** (1804-92), a worthy successor of Cuvier. Born at Lancaster, he was educated at the local grammar school, and became a medical student at Edinburgh, and afterwards at Bart's in London. In due course he was appointed Curator of the museum at the Royal College of Surgeons; then he became Hunterian Professor, a post he held for twenty years, when he resigned in order to become the Head of the Natural History Museum, where he remained for thirty years: such was Owen's career. His official duties were never very arduous and practically he was engaged in research all his life. He was "throughout an investigator of the mysteries of organic structure in minute worm or huge cetacean, in sponge and bird, in the creatures of to-day and in those

whose relics are buried in the rocky graveyards of an immense past." His vast knowledge of animal forms easily made him the world's greatest authority on comparative anatomy during the greater part of his life.—When the present writer was at school, "Richard Owen" was a common nickname to give to boys who earned high marks for specially accurate knowledge of facts. There was a legend amongst us that if Owen were given a tiny fragment of bone, or a bit of skin, or a feather he would immediately identify it and name, describe, and sketch the animal to which it belonged. Absurd as such a legend naturally is, it serves to show the sort of man he was known to be.

In the eighteenth century qualified naturalists were usually appointed as technical advisers on voyages of exploration. **Joseph Banks** (1743–1820) accompanied Captain James Cook on an expedition to the Pacific. When at Oxford, Banks had devoted himself to botany, and being a wealthy man was able to provide a special staff and equipment for the Pacific expedition. Great additions were made to the existing knowledge of plants, birds, and fish, and the herbarium which Banks put together formed the nucleus of the great collection at the Natural History Museum, South Kensington. In due course (Sir) Joseph Banks became President of the Royal Society, and was recognized as a great patron of science. Amongst those he befriended was a young army medical man, **Robert Brown** (1773–1858), who was already a keen botanist. Through Banks's influence, Brown was appointed naturalist to a new expedition that sailed under Captain Matthew Flinders to Australia and Tasmania. Again a huge collection of new plants was made. Brown returned to England and devoted his life to botanical research. His name is associated with four subjects: (1) the cell nucleus; (2) the nature of the sexual process in higher plants; (3) the "Brownian movement" (see p. 486); (4) the microscopical examination of fossil plants.

Like Cuvier and Owen, Banks and Brown devoted their lives to the discovery of new *facts*.

Buffon finally accepted the hypothesis that species alter in type from time to time, but that at each alteration they retain definite marks of their previous type; in short, he gradually moved away from Linnæus's idea of the fixity of species. Erasmus Darwin (1731-1802), the grandfather of Charles Darwin, held views similar to those of Buffon, maintaining that species change in course of time, and that these changes are due to influences that bear upon the individual from without. These changes he held to be passed on to the offspring, so that he was a believer in the inheritance of acquired characters. This conception was further developed by his younger contemporary Jean Baptiste Pierre Antoine de Monet Lamarck (1744-1829), a native of Normandy, who, when a young soldier in the French army, became excited by the beautiful flora of the Mediterranean region, and eventually made the study of plants and animals his life work. Influenced by Buffon, Lamarck became an evolutionist. He believed that if all species of animals, existing and extinct, were known, they might be arranged in a long chain, any one link of which would be virtually indistinguishable from its immediate neighbours on either side. The oyster would be there, so would the bee, so would the frog, so would the eagle, so would the whale, so would the fox-terrier, so would man himself though right at the very end. The gaps actually existing in such a chain he ascribed to the destruction of the intermediate links, and he hoped that these gaps would eventually be filled in by palæontological discovery. It was part of Lamarck's scheme that the animal and plant world must be continuous with each other at some stage or stages. To Lamarck it seemed impossible that species should be permanently fixed. He thought that there must be some agent acting to produce variations from the original type, and this agent he believed to be *environment*. The essence of Lamarckism is the idea of a new *need* leading to a new *effort* which results in *individual modification*; the need originates and sustains a new movement, and eventually there is a modification of structure. The new need is the

result of changed surroundings, a changed "environment". This term "need" implies a recognition of *mind* or *sentience* in the creature, which therefore must be the basic cause of evolution. The new character thus acquired by the parent is transmitted to the offspring.

Acquired characters (they are better called "somatic modifications") are common enough: the blacksmith's muscular arm is an instance; and they may persist after the inducing conditions have ceased to operate. *But are they transmitted to the offspring?* The experimental facts which seem to suggest that they are transmitted do not convince all biologists: Professor E. W. MacBride vigorously maintains the affirmative; Professor T. H. Morgan the negative. — We shall return to this question in a later chapter.

Karl Ernst von Baer (1792-1876) was the son of a German landowner in Esthonia. He gave up medicine for comparative anatomy and eventually became a professor at Königsberg, where he did remarkable work in embryology. His discovery of the actual mammalian ovum enabled him to follow out in detail the successive stages of embryological development. A fertilized egg-cell divides, and divides again and again, into many cells, and these undergo a kind of stratification into layers, the ectoderm, mesoderm, and endoderm: and for many years after the publication of von Baer's great work, *Development of Animals*, embryologists busied themselves with descriptions of these embryonic layers, and with tracing the various organs of the body back to their origin in them. Von Baer showed that the embryos of mammals, birds, lizards, and snakes, are, in their earlier stages, practically indistinguishable from one another, either as a whole or in their mode of development. The same fundamental plan underlies them all. But von Baer never became an evolutionist. It was left to his successors to discern that any given embryo may perhaps be simply *recapitulating* its racial history.

The great Harvey had dealt with the *organs* of the body; Bichat had analysed these into their *tissues*; it still remained to reduce the tissues to *cells*. Some advance had already been made in the knowledge of uni-cellular organisms. *Vorticella* had been described in 1667, forms of *Bacteria* in 1683, *Paramecium* in 1702, and *Amæba* in 1755. In 1833 Robert Brown, in his investigations on plant fertilization, discovered that the nucleus was the normal accompaniment of the cell, but he had no clear idea either of cell or of nucleus. The modern doctrine of the cell theory was placed on a secure footing by the work of two Germans, **M. J. Schleiden** (1804-81), and **Theodor Schwann** (1810-82). Schleiden, who began life as a lawyer, became professor of Botany at Jena. He was an able and original man, but his arrogance often led him into error. In 1838 he made the momentous announcement that a plant was made of cells and modifications of cells, and that the embryo of a plant arose from a single cell. In the next year Schwann, as able and original as Schleiden but personally much more modest and likeable, made a similar announcement concerning animals, and thus the "cell-theory" was formulated. The theory gave a new unity to the whole range of animate nature. Schwann recognized that in all organisms there is one universal principle of development, namely, the formation of cells. He saw clearly that every animal originated in an ovum or egg: the egg may be very large as in the case of the hen, being distended with food-substance, the yolk, and surrounded by a layer of protective albumin; or much smaller as in the case of the frog, where the amount of yolk and albumin is much less; or microscopic as in the case of mammals. Yet in all cases the egg was essentially a cell, and the cell was the animal-to-be. Schwann became professor at Louvain and later on at Liège.

Claude Bernard (1813-78) came of French peasant stock. His great natural ability eventually won for him a professorship at the Sorbonne, and caused Louis Napoleon to build him a special physiological laboratory in the Jardin

des Plantes. He has been described as a thinker with an "Olympian intellectual aloofness"; he was certainly a very great physiologist, and "a master of physiological experimentation". "His work on the pancreas and liver left hardly anything to be done by anybody else". Bernard's great working idea was the functional integration of the living creature: "the bodily activities are all interdependent". He was convinced that physics and chemistry alone do not give an adequate account of life: there was a unity in development and a harmony in functioning which compelled us to regard the living creature as something much more than an automaton, something altogether different from everything non-living.

Charles Robert Darwin (1809-82) is the man above all others whose name is associated with that view of the succession of living things which is summed up in the words, *Organic Evolution*. His father and his grandfather were medical men, and his mother was the daughter of Josiah Wedgwood of pottery fame. His father was disappointed with him as a boy: "You care for nothing but shooting, dogs, and rat-catching, and you will be a disgrace to yourself and all your family." At Eton he was quite undistinguished, and he did little at either Edinburgh or Cambridge. But at Cambridge he made friends with **John Henslow**, Professor of Botany, and **Adam Sedgwick**, Professor of Geology. The latter took him on a geological tour, and then the former secured for him the position of naturalist on the *Beagle*, which set sail under Captain Fitzroy to survey South America. During the voyage Darwin made important observations on the very peculiar fauna and flora of various isolated oceanic islands, including the Galapagos islands. He accumulated great stores of facts, and a comparison of these caused him to ponder over theories of evolution. The immediate results of this scientific mission are to be found in his first published work, *The Voyage of the Beagle*. When he returned to England, he married his cousin, Emma Wedgwood, and settled

at Down in Kent, and preparation for his great constructive theories began. His industry, despite very poor health, was remarkable and continued throughout his life. In 1859 his great work, *The Origin of Species*, was published; it expounded the doctrine of what is now commonly called "Darwinism". Twelve years later *The Descent of Man* appeared, which in some respects excited still more attention than the earlier and greater work by reason of its searching inquiry into man's ancestry.

Darwin had a veritable passion for facts: "It is a golden rule," he said, "which I try to follow, to put every fact which is opposed to one's preconceived opinion in the strongest light." "I have steadily endeavoured to keep my mind free, so as to give up any hypothesis, however much beloved, as soon as facts are shown to be opposed to it." He attributed the success of his work to "the love of science, unbounded patience in long reflecting over any subject, industry in observing and collecting facts, and a fair share of invention as well as of common sense."

The Darwinian theory accepted the Lamarckian view that all species, including man, are descended from other species, but it also enunciated, in the light of a vast number of biological facts, *the law of natural selection*. Those organic beings which vary, however slightly, in a manner profitable to themselves have the best chance of surviving, and therefore of being "naturally selected". The less improved forms of life become extinct, for natural selection leads to "the survival of the fittest".

All biologists accept the general theory of evolution, but they are divided in opinion as to the means by which it has been brought about. Some follow Darwin, and stress natural selection; others follow Lamarck who emphasized the effect of use and disuse or habit in species-formation and its hereditary transmission.

Darwin was born at Shrewsbury, died at Down, and was buried a few feet away from Newton's tomb in Westminster Abbey. His portrait appears in Plate 38.

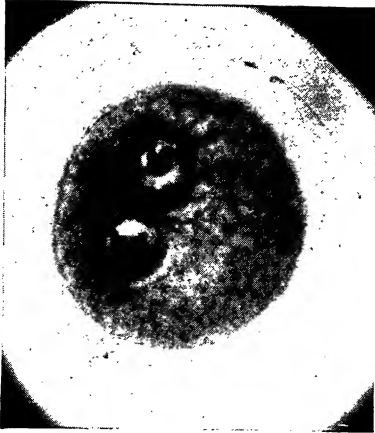

1

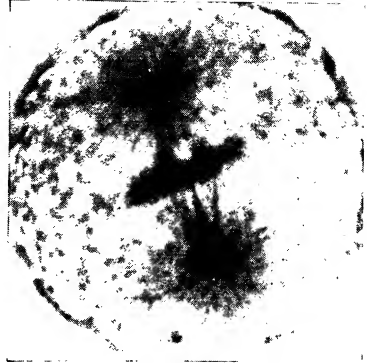

2

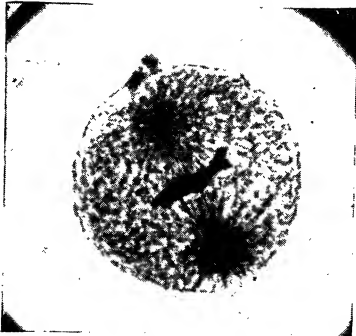

3



4

From untouched micro-photographs by D. A. Kempson

Mitosis, beginning with an egg just fertilized. That of *Ascaris megalocephala* (the round worm from the intestine of the horse), which possesses two pairs of chromosomes.

1. Fertilization has just occurred. The nuclei of spermatozoa and ovum have just met. The chromosomes have begun to appear.
2. Side view of the equatorial plate stage of the first division of the fertilized egg. The spindle is seen with the centrosomes at the ends.
3. The chromosomes have split longitudinally.
4. The two sets of chromosomes have now moved apart to the two asters; the cell is deeply constricted and has almost reached the first cleavage stage.

From Animal Biology, Haldane and Huxley (The Clarendon Press)

Alfred Russel Wallace (1823–1913) was another world-famous naturalist who enunciated a theory of natural selection in terms almost identical with those of Darwin and at about the same time. There was no doubt whatever that the two men had arrived at the same conclusion independently, and there was not only no sign of jealousy between them but a good deal of friendly co-operation. A joint paper was read before the Linnæan Society in 1858. In certain respects Wallace's views differed from Darwin's: Wallace insisted on a spiritual influence in man's development.

Thomas Henry Huxley (1825–95) graduated in medicine at the age of twenty-one and for the next four years was Assistant Surgeon on H.M.S. *Rattlesnake*. By this time he was already a great authority on comparative anatomy, and though he was an unsuccessful candidate for biological chairs at Toronto, Aberdeen, Cork, and King's College, London, he was appointed to two lectureships at the School of Mines in 1854 (he was then twenty-nine), and soon rose to a fame that was world-wide. But master of his subject though he was, his real reputation is due to his life-long fight on behalf of scientific truth, and especially of the theory of evolution, which he supported with a great wealth of anatomical and embryological knowledge. He was by far the most capable verbal swordsman of his day. He could lay about him with the broadsword when necessary, but the rapier was his favourite weapon, and ill fared the man who dared to stand up to him. "It is doubtful if any man ever had a greater passion for veracity, a greater reverence for the facts." *

* As a teacher of science Huxley stood alone. I have spent the greater part of my life in close association with science teachers and I have never known Huxley's equal. How well I remember the ease with which he transferred to the minds of his students any picture he had formed in his own. He always used the right word, his thoughts were crystal-clear, he visualized with great vividness, his logic was faultless, he compelled attention, and he kept the minds of his students tense. Tyndall, Huxley's great friend and himself an extraordinarily brilliant teacher, told me that Huxley's clear and clever way of putting things always made him despair. Wallace (then over 80) told me he had never met Huxley's equal as a

Huxley brings us down almost to the present century. Recent and present-day workers we shall mention in future chapters, but a few may be conveniently mentioned here also.

Sir Francis Galton (1822–1911) was an anthropologist and an authority on eugenics. He was a cousin of Charles Darwin. **Herbert Spencer** (1820–1903), an English philosopher and a friend of Huxley and Tyndall, did much to advance the theory of evolution; so did **Ernst Haeckel** (1834–1919), Professor of Zoology at Jena. **Jean Henri Fabre** (1823–1915), a French entomologist who wrote wonderfully fascinating books on insects, was an opponent of evolution. **August Weismann** (1834–1914), who was Professor of Zoology at Freiburg, was the leader of the neo-Darwinians; he denied the transmissibility of characters acquired in an animal's lifetime. **Gregor Mendel** (1822–84), an Austrian monk, cultivated the edible and the sweet-pea, kept exact records of various features of about 10,000 plants, and formulated a theory of heredity. But the theory was unappreciated and overlooked until 1900, when **Hugo de Vries** (*b.* 1848), Professor of Botany at Amsterdam, called attention to it, and Professor **William Bateson** (1861–1926) of Cambridge, translated Mendel's monograph into English. **Sir Edwin Ray Lankester** (1847–1929) was one of the foremost English zoologists of recent times, and **Sir Peter Chalmers Mitchell** (*b.* 1864) has long been recognized as another. Two more foreigners may be mentioned: **Louis Pasteur** (1822–95), an eminent French pathologist; and **Robert Koch** (1843–1910), a German physician, who became the founder of modern bacteriology.

lecturer. Huxley's lectures were full of aphorisms and wise saws, "The conclusion that outstrips the evidence is not only a mistake, it is a crime." "Never make an assertion which is not warranted by the facts." "I despise the man who is afraid to say, 'I don't know'." It was he who coined the useful word agnosticism, a term which some people always confuse with atheism!

I cannot help thinking that Professor H. E. Armstrong, that well-known iconoclastic critic, failed in his Huxley's Memorial Lecture, 1933, to do complete justice to Huxley's eminence as a teacher.

Out of the Nineteenth Century into the Twentieth

Before the close of the last century, biologists had definitely established certain main principles concerning animals and plants jointly: the mode of reproduction was essentially the same; the living substance was essentially the same; the methods of nutrition and respiration were essentially the same; the hypothesis of organic evolution applied equally to both; all living processes were reducible to terms of the cell; all living things were derived from living things, so far as our actual experience extended. These conclusions, separately and together, have tended during the present century to drive biologists along many entirely new paths of inquiry. For instance, a great deal of attention has been concentrated on genetics and heredity, and the subject of variation in both animals and plants has been studied intensively. It has been well said that the great problem now to be solved is why the offspring resembles, not why it differs from, its parents.

The neo-Lamarckians and the neo-Darwinians form two rather hostile camps. Each is striving to convert the other, and there are certain rather impatient individuals who sigh for the good old days of the Spanish inquisition. Meanwhile the search for more facts continues, and the undisputed truth may therefore emerge some day.

Zoology: Classification

The man in the street does not hesitate to put into a single class all the varieties of dogs he knows and to distinguish them clearly from cats, though he may not be able to say that the main *specific* differences between dogs and cats concern teeth and claws. Similarly he can distinguish between horses and asses, though he may not know that the main specific differences concern callosities and tails. The first thing for learners to understand in biological classification

is *specific differences*, in order that they may obtain a clear idea of a species.

But they must also learn that occasionally the amount of difference between parent and offspring is so strongly marked that the offspring may receive the name of *variety*; that it is often difficult to decide whether groups of similar forms should be ranked as species or as varieties, and that intermediate forms give rise to doubt; and that when a new animal is discovered, there is often a difficulty about coming to a decision concerning the species in which to place him, and that he may even have to be regarded as a member of a hitherto unknown species.

The next thing for learners to grasp is that the basis of specific differences is *homological*, not analogical. Homology expresses morphological, structural, architectural, developmental, similarities; analogy, merely the functional resemblances between the parts of different animals. Homologous structures reveal a deep-seated resemblance in build and in the manner of development. Zoological classification seeks to show the *blood-relationship* of animals, because it is believed that all groups showing homological similarities really had, in some remote age, the same common ancestor, and such classification is therefore based on comparative anatomy, though much help is also obtained from embryology and palæontology. It is soon obvious that, for instance, whales must not be classed with fishes, or bats with birds.

Fig. 156 should be carefully studied.

The biologist no longer believes in the *fixity* of a species; he believes that one form has given rise to another. The specific characters show a considerable degree of constancy from one generation to another, and no very great difference is likely to be seen in a hundred generations, or even in a thousand unless by special breeding.

The successive grades of classification are based on degrees of resemblance. Thus species are grouped into genera, genera into families, and then into orders, classes, and phyla. Each *main* division is called a *phylum* and includes

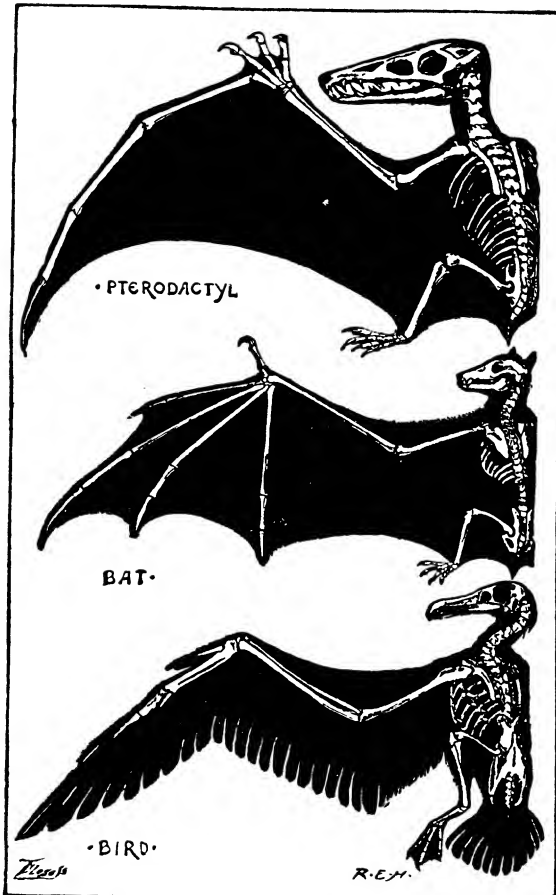

Fig. 156.—Homology and Convergence

In members of the three classes, Reptiles, Mammals, and Birds, efficient flying-organs have independently evolved (convergence). The fore-limb is always utilized as the main part of the wing, and its general plan is retained throughout (homology). But the details are different in each case. The main support (apart from the upper and lower arm-bones) is, in the Pterodactyl, the 5th or "little" finger; in the Bat, the 2nd to 5th fingers; in the Bird, the quills of the feathers. Accordingly, only in the Bird is the hind-limb not required as part of the support of the wing, and is left free for other functions.

animals built on the same fundamental plan and believed to be descended from one ancestral stock. Here is an example from the phylum Vertebrata:

Individual—my dog Peter.

Variety—fox-terrier.

Species—domestic dog (*Canis familiaris*).

Genus—Canis.

Family—Canidæ (dog-like carnivora).

Order—Carnivora (flesh-eating animals).

Class—Mammalia (vertebrates that suckle young).

Phylum—Vertebrata (animals with bony skeletons).

The main characteristics of the principal *phyla* (Protozoa, Porifera, Cœlenterata, "Worms", Echinodermata, Arthropoda, Mollusca, Vertebrata) should be familiar to everybody; so should those of the five *classes* of the vertebrates (fish, amphibians, reptiles, birds, mammals); also those of a few of the best-known *orders* of *families* of each of these five classes, more especially of the mammals. Only with such preliminary knowledge can evolution be made an intelligent study.

The biologist's genealogical tree may be a snare. The one we have selected for inclusion here purports to show in the main vertical column the descent of man from a Protist. It is probably safe to say that it shows a generally correct succession in evolutionary development, but there are such tremendous gaps in our biological positive knowledge that it is extremely rash to regard such a table as correctly exhibiting our actual ancestry. Back to "mammals", probably yes; back to "vertebrata", possibly yes; but the origin of the vertebrata, and the true relations of the vertebrata to the invertebrata, are extremely doubtful. What sort of an animal was the common ancestor of the man and the ape, or of the cat and the dog, or of the mouse and the elephant, or of the sparrow and the crocodile, or even of all these animals? *We do not know.*

On page 752 are useful auxiliary tables, though again they must be accepted with caution.

There are many difficult problems still to be solved before the biologist's genealogical tree becomes finally acceptable.

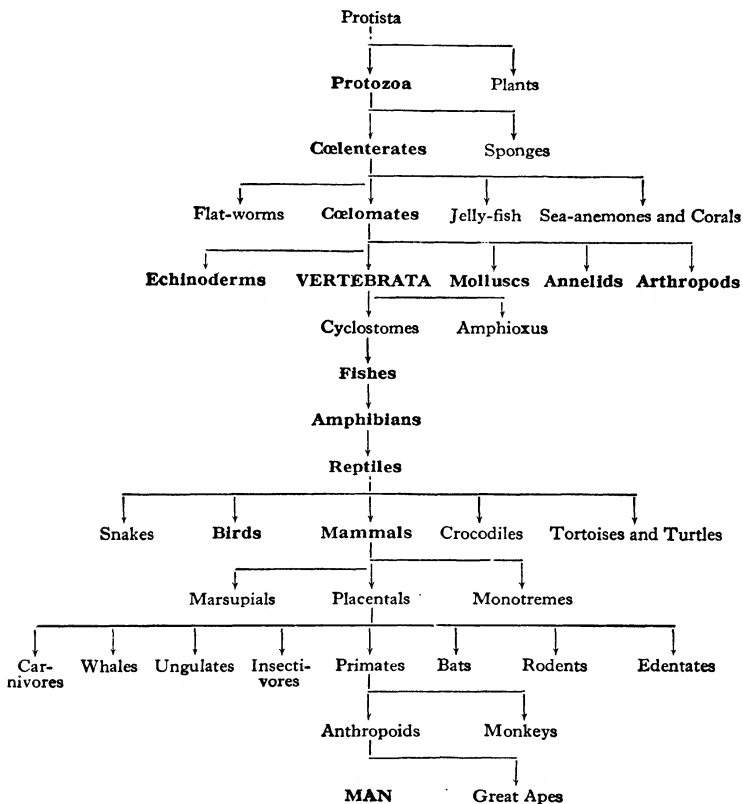

Consider, for instance, the transition of mammals from reptiles. Until recent years the evidence of such transition was of the flimsiest, but the remarkable discoveries of fossil reptiles in the Karroo rock of South Africa have excited great interest because they seem to show conclusively how some of the early reptiles may have passed into mammals.

Evolutionary Stages.	Representative Animals.
No formed nucleus.	Bacteria.
Nucleated cell.	Amœba.
Cell organs.	Vorticella.
Mouth.	Hydra, sea-anemone, corals.
Nerve-ring.	Jelly-fish, siphonophora.
Central nervous system.	Flat-worm, tape-worm.
Cœlome, elaboration of heart.	Echinoderms, bivalve molluscs, earth-worms.
Primitive head.	Primitive molluscs, lower arthropods.
Elaboration of brain and head.	Molluscs, fish, higher crustacea.
Terrestrial life in moist places.	Land molluscs, amphibia.
Terrestrial life fully developed.	Many insects and arachnids, reptiles.
Elaboration of instincts.	Higher insects, spiders.
Associative memory; warm blood.	Birds, mammals, higher reptiles.
Evolution of intelligence.	Higher primates.
Reason, speech, use of tools and fire.	Man.

Phylum.	Nu- cleated Cells.	Diges- tive Cavity.	Body Cavity.	Back- bone and Head.	Jaws and Paired Limbs.	Bone.	Ter- restrial Life.	Am- nion.	Tem- perature Regu- lation.
Protozoa ..	×								
Cœlenterata	×	×							
Cœlomata ..	×	×	×						
Cyclostomes	×	×	×	×					
Cartilaginous fish }	×	×	×	×	×				
Bony fish ..	×	×	×	×	×	×			
Amphibians	×	×	×	×	×	×	×		
Reptiles ..	×	×	×	×	×	×	×	×	
Birds and Mammals }	×	×	×	×	×	×	×	×	×

The remains date back to the Permian and Triassic periods, when mammals and birds must have had their beginning,

and many of them are in such a remarkable state of preservation as to show whole skeletons. The discoverers and chief collectors of the reptiles have been amateurs, all busy men in their own professional work. **Andrew Geddes Bain**, the pioneer in South African geology, was a civil engineer. He was followed by his son and **J. M. Orpen**, some medical men, a clergyman, a farmer, a gardener, and a blacksmith. Under the auspices of the Carnegie Corporation of New York and the South African Research Board, Dr. **Robert Broom** has prepared a summary of our present knowledge of the subject, to which he himself has contributed a very large share during the past thirty years.

The Karroo rocks seem to have been formed at the mouth of a great river which for many millions of years spread its mud over what is now South Africa. The area was sinking so that an immense thickness of deposits accumulated, and great changes in the reptile life are observable in the successive layers or zones. Dr. Broom enumerates these changes, and shows how some of the latest Karroo reptiles are the most mammal-like, while some of the earliest are most similar to the amphibians which were presumably their ancestors. In his highly interesting summary, Dr. Broom notes the long time-range of the Anomodonts (Gk. *ἄνομος*, irregular, *ὀδούς* (*ὀδοντ-*), tooth), which had a horny beak replacing teeth; and referring also to the Chelonians and the birds, he expresses the view that the horny beak is one of the "most successful adaptations ever accomplished". He adds that "all the steps by which the mammals have arisen from the reptiles seem to be connected with change of habit and change of diet; comparatively slow forms have given place to others with greater and greater power of active movement". The little Ictidosaurians of the Upper Karroo seem to be scarcely distinguishable from mammals.

In one way or another the gaps in our knowledge of animal ancestry are gradually being filled up, but biology has become such a big subject that most of its devotees are necessarily specialists in some particular department, and very

few make the attempt to range over the whole field. Perhaps the biggest task of all falls to the systematist, and of the few systematists amongst us, the President of the Zoological Section of the British Association in 1932, Lord **Rothschild**, stands in the very front rank. His presidential address on that occasion dealt with some of the outstanding difficulties of zoological classification. He stressed the fact that a natural classification is based on blood-relationship and therefore entails an inquiry into the evolution of the species classified.

At the time of Linnæus, whose *Systema Naturæ* contained altogether less than 4300 species, it was a comparatively simple achievement for one man to have enumerated all the animals then known. Nowadays that task is a hundred times as difficult, not only on account of the vast number of species which have since become known but also because research in systematics requires a much deeper knowledge of the morphology and bionomics of the animals classified. At the time of Linnæus, individual specimens showing marked differences were as a rule diagnosed as representing distinct species, the unit called species being looked upon as essentially a constant. But, as Lord Rothschild pointed out, the gradual discovery of the great range of variability exhibited by many organisms compelled the systematist to change his attitude. The modern systematist regards morphologically similar specimens, whatever their outward appearance, as specifically alike until their specific distinguishing difference is established by convincing evidence. Experience clearly shows (1) that similarity does not necessarily mean relationship of the forms under observation, and (2) that dissimilarity is not necessarily evidence of specific distinctness, and that variability obtains in every species and every organ. *Variability is an essential character of everything alive.* For instance, examine, say, the thumbs of 1000 people: no two will be found absolutely alike. Or examine the finger-prints of even a million people: all will be found to differ, and the differences are so easily classified that they may be systematically recorded, dictionary fashion, and any one turned up almost as quickly

as a word. The old concept of fixed species is replaced by the concept of flexible species, and the old saying that "like breeds like" is replaced by the statement "a population breeds a population with the same extent of variability". Strictly speaking, individuals are never alike, whatever their relationship to each other. Despite all this variability, the apparently chaotic mass of living organisms is cut up by specific barriers into unit populations of numerous individuals, each population living its own life alongside other populations. The rose lives in the same garden as the poppy and the dog in the same house as the cat.

Lord Rothschild gave an interesting illustration of the extent of our present-day knowledge of species. Bubonic plague is now known to be a rat disease transmitted to human beings through the agency of a particular species of rat-flea. An outbreak of plague in north India is invariably serious; in Madras or Colombo it lasts but a short time, although rats and rat fleas abound there. Investigation showed that the flea ordinarily infesting rats in Madras and Colombo is not the plague-flea *Xenopsylla cheopis*, but *Xenopsylla astia*, a *very similar*, but *really different*, species, and now proved to be an inefficient carrier of the disease. For some reason or other, Madras and Colombo do not suit *X. cheopis*; it dies out, and the plague disappears. The two species of fleas are remarkably alike, but there is a difference and that difference is specific.

But the systematist is not concerned merely with the study of species and their variations. The species have to be grouped into genera and then into higher categories, all according to relationship, that is, according to descent. The systematist's knowledge of minute detail has to be profound.

Botany: Plant Physiology

Of the many unsolved problems in plant physiology the two most important are the mode of transpiration and the mode of photosynthesis.

Water transpires in large quantities from the leaf surfaces of even the tallest trees. How does the water ascend from the roots? Atmospheric pressure must be ruled out: it could account for only about 30 feet of ascent. Root pressure and osmotic pressure are also demonstrably inadequate. The evidence that the living parenchyma cells may exert a pumping action is quite unconvincing. If the water is not pushed up from below, it must be pulled up from above, and a plausible hypothesis of a pulling-up action has been put forward. An air-free column of water enclosed in a rigid tube to which the water adheres can transmit a very considerable tension owing to the cohesion of the water molecules, and is therefore able to transmit a pull like a steel wire. This tensile strength or cohesion in a water column is very great, and it requires probably 300 atmospheres to rupture it. As the water transpires at the leaf surfaces, the water columns in the wood channels from leaves to roots necessarily remain unbroken and therefore "pull up" renewed supplies of water from the ground. The hypothesis affords a reasonably satisfactory explanation of the transpiration stream, though it is not without its difficulties. **H. H. Dixon**, Professor of Botany at Dublin, is the present leading authority on the whole subject of transpiration.

The process of *photosynthesis* is a still harder biological nut to crack, though it is a common thing to find sixteen-year old girls giving an account of it which obviously seems to them to be adequate and to admit of no question. As the term "photosynthesis" implies, the process is a light-action process. The process is really a manufacture of organic substances from *carbon dioxide* (CO_2) and *water* (OH_2). The schoolgirl is taught that other factors besides the CO_2 and OH_2 , are concerned with the process, viz. *chlorophyll*, *light* of appropriate wave-length, a suitable temperature, and the presence of living protoplasm. She is usually ready to perform a series of experiments to show that in the absence of any one of these factors the process cannot go on, and

she explains that the chlorophyll and the light are the *agents* which effect the process, viz. the manufacture of sugar and starch from CO_2 and OH_2 . She will probably be familiar with the usual photosynthetic equation:

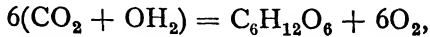

and will know that the sugar ($\text{C}_6\text{H}_{12}\text{O}_6$) deprived of a molecule of water gives starch ($\text{C}_6\text{H}_{10}\text{O}_5$):



and she will be able to demonstrate the evolution of the oxygen and the presence of starch. Quite probably she will refer to formaldehyde (CH_2O), which is sometimes found in the leaf, as an intermediate product in the sugar formation and show the reactions this way:

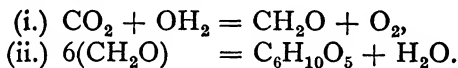

but sometimes she may be cautious enough to suggest that the formaldehyde may be a mere by-product rather than an intermediate product. All this is commonplace work in fifth-form botany teaching.

Certain it is that carbohydrates (sugars and starch: we ignore sugar differentiation here) are, under the conditions named, rapidly formed in the green leaf. In *Spirogyra*, starch has been found within five minutes of illumination. It is also probable that protein and other compounds are elaborated in the leaf, the nitrogen being brought there from the soil as nitrate.

It must not be thought that the various factors—the CO_2 , the OH_2 , the intensity and the wave-length of light, the chlorophyll, and the rest—work independently. **F. F. Blackman** of Cambridge has shown that they are closely interrelated. Blackman's hypothesis of "limiting factors" is of the utmost importance.

The green leaf has been described as a chemist which alone of living things has mastered the secrets of converting

the sun's rays into food material. The pigments of the green leaf absorb the incident light; the energy so obtained is employed in the building up of complex organic substances from CO_2 and OH_2 . **Richard Willstätter**, Professor of Chemistry in the University of Berlin, and his collaborators, have shown that the pigments are four in number. *Chlorophyll a* ($\text{C}_{55}\text{H}_{72}\text{O}_5\text{N}_4\text{Mg}$); *chlorophyll b* ($\text{C}_{55}\text{H}_{70}\text{O}_6\text{N}_4\text{Mg}$); *Carotin*; and *Xanthophyll*. Note the complexity of the chlorophyll molecules (137 and 136 atoms, respectively). The pigments are not usually dissolved in the cell but are associated with denser portions of the protoplasm of definite form, known as plastids, and it is apparently in these plastids that the special physical and chemical processes occur. One function of the green pigments is clearly that of absorbing the necessary energy for the decomposition of CO_2 ; their solutions show very characteristic absorption bands.

But the inner nature of photosynthesis is still obscure. If we liken the process to a machine, we may say that we know what we put into the machine and what we get out of it, but of how the machine actually works we know practically nothing at all.

Professor **E. C. C. Baly**, Grant Professor of Inorganic Chemistry of the University of Liverpool, and his co-workers claim that the reaction

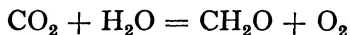

can be effected, (*a*) by ultra-violet rays at 2060 Å.U., (*b*) by sunlight in the presence of dyes such as Malachite Green; and they also believe that they have synthesized carbohydrates directly from CO_2 as the result of exposing water, through which CO_2 is bubbled, to *visible* light. The water contained suspended cobalt carbonate, and the hypothesis is that the CO_2 becomes concentrated (adsorbed) on the surfaces of the suspended particles, and is then photo-synthesized to carbohydrate. Professor Baly's experimental skill is well known, and we may assume that his claims will ulti-

mately be fully justified. But what then? What inference are we to draw? That we have found a clue to Nature's original method of initiating a life-process?

As far as we can tell, every new living thing is derived from pre-existent living things. And yet there must have been a time when the condition of this planet was such that life on it was impossible. How then did life first make its appearance? It is no answer to say that the chemist is now able to synthesize many organic compounds; he has not come anywhere near synthesizing a compound that contains *life*. It will be many a long day before a living creature will be synthesized in a biochemical laboratory. Professor **J. B. S. Haldane** hopes to live long enough to see a pure enzyme made artificially, though (he says) "I do not think I shall behold the synthesis of anything so nearly alive as a bacteriophage or a virus, and I do not suppose that a self-contained organism will be made for centuries".

Perhaps then we may allow a thousand centuries before the biochemist is able to perfect his process of artificial man-making. Would Professor Haldane fashion his first man as an enlarged edition or as a reduced edition of his friend Professor MacBride? * And would he feed him on Mr. **H. G. Wells's** "Food of the Gods?" Or would he make him a giant in brawn rather than in brain?

It is just *possible* that if ever the secret of the beginning of life upon the earth is discovered, it will be traceable to the chlorophyll of the green plant. A plant feeds and grows, digests and breathes, as truly as an animal, and in regard to those main functions there is no essential difference between them. Both, too, are so far structurally alike that they are made of cells and both originate in a fertilized egg-cell. Chlorophyll is the great transformer of the energy of sunlight into the energy of the organic colloids; and, directly or indirectly, the energy of all living things is traceable to this single source. Chlorophyll is itself a colloid and is far too complex to have arisen as a first step in the evolution of

* See *Nature*, Vol. 129, pp. 817, 856, 900 (June, 1932).

organic life. Of its actual origin we have no positive knowledge. As for living creatures there probably exist a whole world of them, far below the limits of the microscope, creatures originating from very complex protein molecules down among the colloids, leading up to the bacteria and protozoa which, comparatively speaking, are really highly developed organisms.

How did life originate? *We do not know.* All hypotheses concerning it are simply airy speculations.

(Portrait of Huxley, Plate 46.)

BOOKS OF REFERENCE:

1. *A Short History of Biology*, C. Singer.
2. *Essentials of Biology*, J. Johnstone.
3. *Mechanism of Life*, J. Johnstone.
4. *Organism and Environment*, J. S. Haldane.
5. *Animal Biology*, J. B. S. Haldane and J. S. Huxley.
6. *Growth*, G. R. De Beer.
7. *Extinct Plants and Problems of Evolution*, D. H. Scott.
8. *Animal Biology*, L. L. Woodruff.
9. *Invertebrate Zoology*, H. Jones van Cleave.
10. *Origin of Mammals*, Robert Broom.
11. *The Stream of Life*, J. S. Huxley.
12. *Origin of Species*, C. R. Darwin.
13. *Darwinism and What it Implies*, Sir A. Keith.
14. *Huxley Memorial Lectures*, E. B. Poulton, and others.
15. *Essay on Classification* and other papers, Jean Louis Rudolph Agassiz, a Swiss naturalist who became professor at Harvard, and whose hardly less distinguished son, Alexander, became Curator of the Harvard Museum.

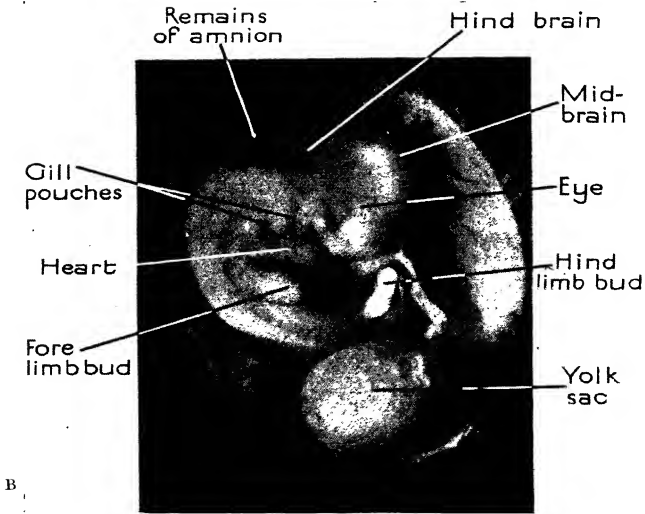
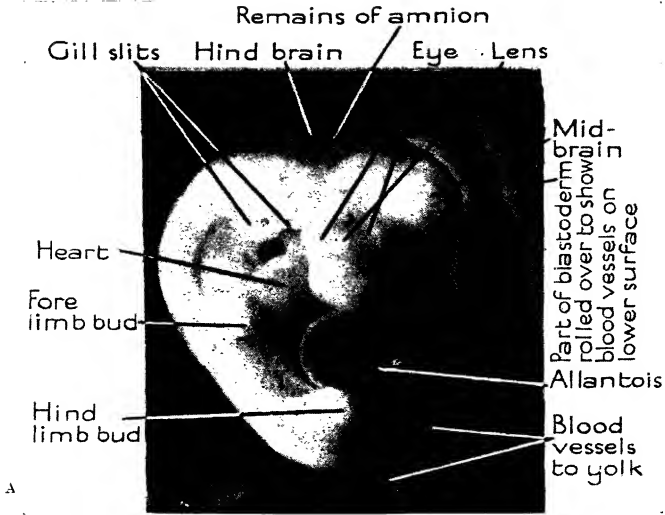

A. Embryo of a Chick after four days' incubation, two-fifths of an inch long (here $\times 8$), compared with that of a human embryo, B, to show the remarkable similarity of young animals whose adults are so different.

From "Embryology and Evolution", De Beers (The Clarendon Press)

CHAPTER XLIV

Cytology and Embryology

Without some knowledge of cytology (Gk. κύτος, a hollow, a cell), and embryology (Gk. ἔμβρυον, a pre-natal animal), it is impossible to understand modern theories of heredity. We therefore make some brief reference to both subjects.

The technique of the microscopist has now made such great advances that it is possible to cut sections of some biological material a good deal less than one ten-thousandth of an inch in thickness and to obtain magnification up to 1500 diameters.* The reader may therefore feel confidence in the general accuracy of the results of the methods of histology.

Structurally, both animals and plants are essentially *cellular*. This was enunciated as a general notion by **Schleiden** and **Schwann** independently in 1839, but, like **Hooke** before them, these writers were more impressed by the external membrane forming the cell *wall* than by its viscous contents called by **Von Mohl** (1847) *protoplasm*, a very complex organic compound of a colloidal nature. Plant cells differ

* Some idea of the advance in the technique of the microscopist may be gauged from the statement made by Dr. C. J. Chamberlain in his Introduction to *Methods in Plant Histology*:

“The pollen grain of a lily, placed on a dark background, is barely visible to the naked eye; but with modern technique, such a pollen grain can be cut into fifty sections, the sections can be mounted and stained without getting them out of order, a photomicrograph can be made from the preparation and a lantern slide from the photomicrograph, and finally there appears upon the screen a pollen grain 10 feet long, with nuclei a foot in diameter, nucleoli like baseballs, and starch grains as large as walnuts. With such preparations, botanists are now showing clearly the nature of structures which, only a few years ago, were good subjects for philosophical speculation.”

from animal cells in that they possess an external coat of cellulose.

The protoplasm of most cells is differentiated into (1) a colourless translucent, viscous, fluid, the *cytoplasm*, in which is embedded, (2) a more granular body, the *nucleus*, and (3) a sort of attendant satellite to the nucleus, the *centrosome* (fig. 157). When during the development of an organism the cell attains a certain size, which varies for different cells, and may be from $1/250$ to $1/12$ of an inch in diameter, it divides into *two* cells, each complete with its own nucleus and centrosome. In the process of cell division, certain nuclear changes take place, and these are of the most impressive character. They must be clearly understood.

Mitosis

“Mitosis” (Gk. *μίτος*, a thread) is the term now used for the general process of cell-division, and it has almost displaced the older and rather clumsy term “karyokinesis” (Gk. *κάρυον*, nucleus, *κίνησις*, change).

The nucleus of the cell has an enclosing membrane of its own, and within its fluid contents is a delicate *network*, on which during the resting phase of the cell there may be seen, under a high power, numerous *granules* (fig. 157). These are the *chromatin* granules (Gk. *χρῶμα*, colour), so called because they are easily and usefully coloured by stains: they play a fundamental part in cell-division. In the figure the minute star-like body called the *centrosome* (Gk. *σῶμα*, a body) is seen to the top of and outside the nucleus which it adjoins.

Where the growing cell has reached a maximum size for the particular organism, remarkable changes take place in the nucleus. The changes are perfectly regular, always similar in character, and always exactly the same for the same species, animal or plant. The successive changes are these:

1. The star-like centrosome divides into two, and the two halves, connected by radiating fibrils, move away from each other (fig. 158). At the same time,

2. The chromatin granules arrange themselves in a single long thread, twisted round and about like a tangled skein (fig. 158).

3. The tangled chromatin thread breaks up into a definite number of short rods or loops (eight in the figure) called chromosomes (literally, "coloured bodies") (fig. 159). Simultaneously,

4. The two centrosomes continue to separate until they reach polar positions at opposite ends of a diameter of the nucleus; they are still connected by the radiating fibrils, which are now more or less semicircular (fig. 159).

5. The membrane of the nucleus disappears, each chromosome splits longitudinally and forms a kind of twin pair, and the various pairs arrange themselves, equatorial fashion, half-way between the "poles", the two centrosomes and their connecting fibres presenting the appearance of a spindle (fig. 160). (In the figure, for the sake of clearness, only five of the eight pairs are shown.)

6. Each equatorial set of chromosomes now moves off towards its nearer polar centrosome, and the stretching fibrils seem to part (fig. 161).

7. The two sets of chromosomes become quite separated, and each set forms a daughter nucleus; the cell as a whole begins to divide into two (fig. 162).

8. The chromosomes lose their rod and thread-like appearance and break up again into granules; a network is again formed and each new nucleus becomes surrounded with a new membrane.

9. The cell-substance has also meanwhile divided, and we have at last two complete daughter cells, each exactly the same as the mother cell from which they were derived (figs. 157, 163).

Such is the process of mitosis. The process of division effects the *exact halving* of the chromatin substance, and

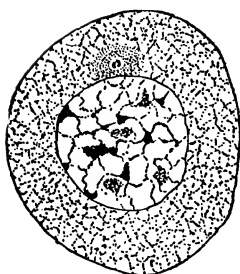

Fig. 157

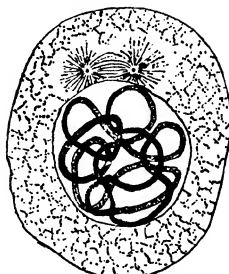

Fig. 158



Fig. 159

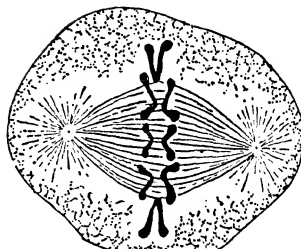

Fig. 160

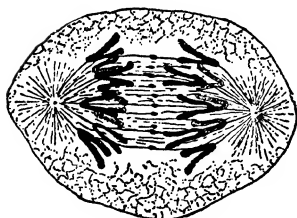

Fig. 161

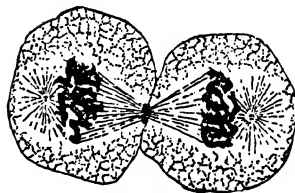

Fig. 162

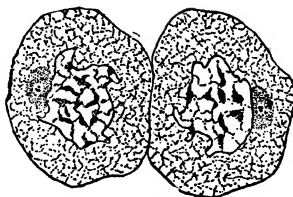

Fig. 163

results in each daughter cell having *the same number* of chromosomes as the original mother cell. The number of chromosomes in a cell is constant for every species of animal, although extremely variable for different species. Thus in the round worm of the horse (*ascaris megalocephala*), there are four; in man there are forty-eight. But in all animals, man included, there is a sexual difference in chromosome numbers.

From Gametes to Zygote

We shall consider the simple case of embryological development that applies normally to the vast majority of animals.

The bulk of the cells forming the body of an animal are ordinary *somatic* cells, that is, body cells. A minority are, as the result of a peculiar variety of mitotic division, more specific than the somatic cells: they are the *germ* cells. Germ cells possess cell bodies and nuclei like somatic cells, and grow like them for a length of time, but ultimately they undergo a special kind of nuclear division which alters their nuclear constitution profoundly and renders them "mature". This special process is called *maturation*.* When mature, but not before, the germ cells, male and female, are ready for conjugation.

In maturation, there is a succession of two cell divisions. The first division is the important one, for each daughter cell has only *half the number of chromosomes* of the parent. The second division is so far normal that the four cells of the second generation are exactly like the two cells of the first, that is, they all have *half the number of chromosomes* normal and peculiar to the species. Thus the reduction (halving) of the chromosome number takes place in the first maturation division; the second division merely increases the number of cells.

* *Spermatogenesis* is the more correct term for the maturation of the male primordial cell to the spermatozoan.

From each of the immature primordial germ cells, male and female alike, four mature cells are thus formed. But there is this difference: from the male immature germ cell, four mature germ cells (*spermatozoa*) are formed and *all* survive; from the female immature germ cell, four mature cells (*ova*)

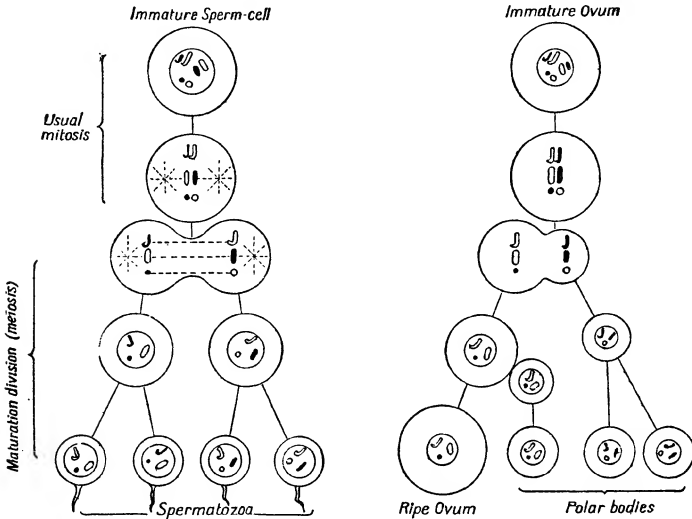

Fig. 164.—Diagram to illustrate the maturation of the male and female gametes and the reduction of the chromosomes. The first maturation division is also the reduction division, the $2n$ (or *diploid* number) of chromosomes (here taken as six) found in the body cells being reduced to n (the *haploid* number). Only one of the four resulting female cells survives; the other three (polar bodies) die. All four of the resulting male cells survive.

The chromosomes shown in the two original immature germ cells are half black and half white. The black are derived from the animal's father, the white from the animal's mother. Note the varying distribution of threes in the eight final cells.

are formed but only *one* survives; the other three, known as polar bodies, degenerate and disappear.

In both ovum and spermatozoon, the process of maturation *halves the number of chromosomes and makes the cells ready for conjugation*. The process of chromosome halving is sometimes spoken of as *meiosis*. Fig. 164 should be carefully examined.

The two kinds of mature germ cells, the *ovum* and the *spermatozoon*, derived respectively from the ovary and testis, are technically known as *gametes* (Gk. γάμος, a marriage) and the fusion of an ovum and a spermatozoon into a compound cell called a *zygote* (Gk. ζυγόν, yoke, junction) is the essence of the sex-process termed fertilization. The ovum (the egg) varies enormously in size, but this is due entirely

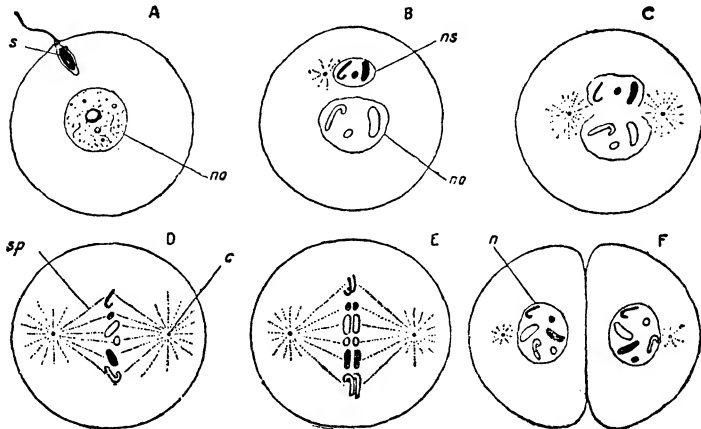

Fig. 165.—Diagram showing fertilization (following on Fig. 164)

A. The spermatozoon's head has entered the ovum. B. The nucleus of the spermatozoon is swelling up and the chromosomes are appearing in both nuclei (haploid number = three). The spermatozoon is producing a spindle. C. Fusion of the two nuclei. D. The spindle is fully formed and all six ($2n$) chromosomes are arranged on its equator. E. Mitosis sets in; all the chromosomes have split longitudinally. F. The fertilized egg (zygote) has divided into two cells, each with the diploid ($2n$) number of chromosomes, one set of three (n) derived from the father in the spermatozoon, and the other set of three from the mother in the ovum.

to the amount of food material termed *yolk* which is packed away in its protoplasm. The egg of the ostrich is one of the largest; the egg of a woman is one of the smallest: it is only about $1/125$ inch in diameter. Compared with the ovum however, the spermatozoon is an exceedingly small thing; its length is only about $1/250$ inch, and $9/10$ of this length is simply a vibratile tail; the head-containing nucleus is thus only about $1/2500$ inch in diameter. The spermatozoon is propelled by the screw-like motion of its tail (fig. 165 A), and

as soon as its head is completely plunged into the protoplasm of the ovum (fig. A) the ovum secretes an enveloping thin flexible membrane called the *vitelline* membrane which, as a rule, at once cuts off the tail of the spermatozoon and generally prevents any more spermatozoa from entering, although quite possibly many hundreds of thousands of spermatozoa will have been emitted in the seminal secretion. The head of the spermatozoon now swells up by absorbing water from the protoplasm of the egg and takes on the form of an ordinary nucleus, (B). It then moves towards the nucleus of the egg and takes up a position beside it, (C). The two nuclei then unite; the ovum is "fertilized", and the zygote is formed, (D). Even after the union, the chromosomes of male and female origin may be distinguished from one another. The important part of the whole process is that the zygote forms the first body cell of the new animal, and that it *contains the normal number of chromosomes*, half of which has been derived from the male parent and half from the female parent. The process of *meiosis* (Gk. reduction) has resulted in the offspring receiving the total number of chromosomes possessed by each of the parents: thus the *species* is maintained.

The zygote (fertilized egg) once formed, mitosis begins in the usual way, (E). The new cell divides into two, (F), each of these into two and each of these again into two; and so the new animal is gradually built up.

Plate 39 shows untouched photo-micrographs of four stages of mitosis in *ascaris megalcephala*.

The Embryo and its Development

When the sculptor makes his preliminary model, perhaps of a future marble statue of a man, he takes a lump of clay, moulds it gradually to shape—lengthening, constricting, narrowing, rounding, hollowing; he first shapes the model in the rough and then moulds the details with greater and greater refinement. When nature sets out to model a future

man, she does much the same thing: she first provides herself with material and then begins work as a modeller. Her material to begin with is just a new zygote (fertilized cell). This cell she causes to multiply until she has a great mass of cells, and, when she begins to model, she constantly adds more and more cells until her model is completed. She is thus doubly engaged; she is making cells, and she is moulding the masses of cells in accordance with a definite plan. No matter whether she is moulding a man or a dog or a bird or a fish or a fly, she begins in exactly the same way. So far as we can see, the fertilized cell with which she starts is always the same, save for its contained number of chromosomes. And to provide the necessary material she always seems to multiply that cell in precisely the same fashion. But there comes a time when she decides to give a specific individuality to the model she is making, and that individuality is always that of the parents of the particular fertilized cell. Exactly how she sets to work to differentiate, we do not know. So far she has succeeded in keeping her secret, but that secret *probably* lies in the chromosomes.

The newly fertilized egg, a minute more or less spherical object, bears no sort of resemblance either to the animal that laid it or to the animal that fertilized it, or to the animal into which it will develop. The process of "development" is therefore concerned with the transformation of the egg into that form which we recognize as "the animal". The shape of the spherical egg is modified little by little, shape after shape succeeding one another until the adult shape is reached. During its development, therefore, the animal passes through a series of successive stages, and it is this sequence of stages that is generally referred to as the animal's *ontogeny* (Gk. *ὄν*, *ὄντ*-, a being; *γένεσις*, generation, producing). With a few of such ontogenetic stages, everybody is familiar; for instance, caterpillar to moth, and tadpole to frog. But the layman necessarily knows very little of the successive stages of animal development, and for the necessary facts he has to rely on the embryologist.

We may briefly trace the early stages of development from the zygote (fertilized egg). The early cell division is known as "segmentation". In a typical case the first cleavage takes place about an hour after fertilization, and occupies half an hour. The two new cells are similar and remain attached. Within another hour each of these new cells has divided and then we have a 4-celled embryo, the 4 cells lying in a ring, and in contact with one another. A third

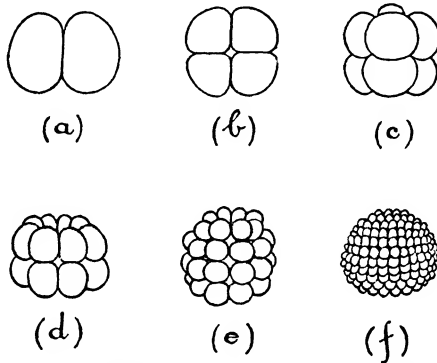

Fig. 166.—Cleavage of the zygote by continual mitosis

(a) 2-celled stage (from the side). (b) 4-celled stage (from above). (c) 8-celled stage. (d) 16-celled stage. (e) 32-celled stage. (f) 128-celled stage (early morula).

The segmentation cavity begins at (c). The morula is a hollow sphere consisting of a single layer of cells.

cleavage divides the 4 into 8, the plane of division being at right angles to the previous planes; all 4 cells are divided simultaneously. So the division proceeds, a doubling taking place at every stage: 16 cells, 32, 64, 128, and so on. The result is a ball-shaped mass of cells called a *morula* (Lat. mulberry). See fig. 166.

But the cells do not quite meet in the centre: there is a segmentation *cavity*, and as the morula grows, the cells arrange themselves in a single spherical layer round this cavity. The embryo at this stage is called a *blastula* (Gk. βλαστός, a germ). It is, of course, much larger than the original zygote because during its formation it has absorbed

water and other materials from its surroundings. Fig. 167 (a) shows a transverse section of the blastula.

The larger cells on one side of the blastula will tend to sink into the cavity (fig. 167, b)—the blastula will be invaginated—and eventually a double-walled two-layered cup will

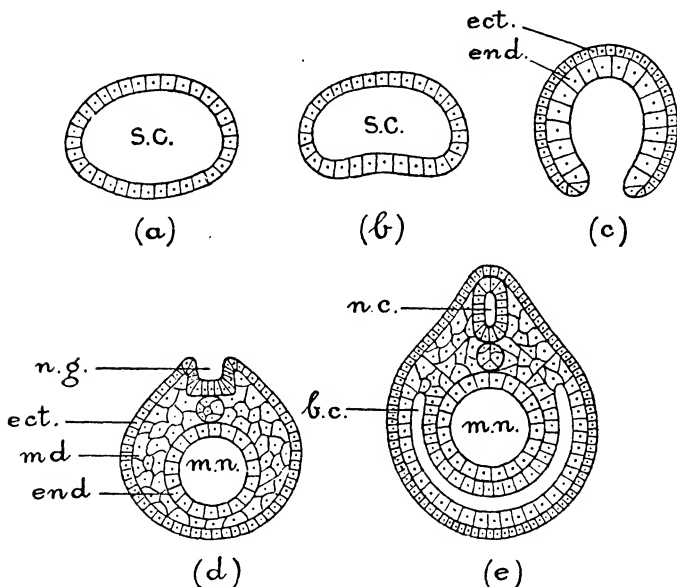

Fig. 167.—Diagrams to show early stages of Embryological Development

- (a) Blastula, showing segmentation cavity. (b) Blastula, beginning of invagination. (c) Gastrula, showing primitive layers, ectoderm and endoderm. (d) Establishment of mesenteron (digestive cavity) and neural groove. (e) Formation of neural canal and body cavity.

ect., ectoderm; end., endoderm; md., mesoderm; n.g., neural groove; n.c., neural canal; mn., mesenteron; b.c., body cavity; s.c., segmentation cavity.

be formed, with an outer layer of small cells (the *ectoderm*), and an inner layer of larger cells (the *endoderm*). This cup-shaped embryo is called a *gastrula* (Gk. γαστήρ, stomach) (fig. 167, c). The ectoderm and endoderm form the two primitive *germinal layers*.

The cup closes, and the primitive food cavity, the *mesenteron*, is thus formed. On the dorsal surface the ectoderm

thickens, and the edges of the thickened surface rise up on either side to form a median groove, the *neural groove* (*d*), and then close over above the groove to convert it into the *neural canal* (*e*). This is the first indication of the nervous system. Meanwhile a third germinal layer, the *mesoderm*, has been formed between the other two. Its cells are plainly seen in the transverse sections (*d*) and (*e*); in (*d*) they are irregular; in (*e*) the greater part has divided into two sheets, to form the future *body cavity* between them.

The endoderm gives rise to the epithelial layer of the alimentary canal and of the glands connected with it. The ectoderm forms the epidermic layer of the skin and gives rise to the central nervous system and certain important structures connected with the sense organs. The mesoderm gives rise to the heart and blood-vessels, muscles, cartilages, and bones. External openings arise, often comparatively late in embryonic life, by the formation of external depressions meeting hollow outgrowths from the mesoderm, and from one of these the lungs, and the glands of the alimentary canal, arise, again as hollow outgrowths.

It should now be understood that all the organs are "roughed out" or "blocked out" by cell-divisions which take place in such a fashion that as the cells are formed they are marshalled into place much as a builder would assemble his materials preparatory to building a house. The food supply of the cells comes from the nutritive substances at the disposal of the embryo.

The successive stages of the early embryonic development we have described are rather arbitrary ones. The number of small formative blastomere cells composing the morula is perhaps 128, but exactly when the formation of the germ layers begins we do not know. The whole process is continuous, but the blastula and gastrula stages are easily visible landmarks.

It should be clearly realized that the gastrula and the rather later stages shown in the sectional diagrams represent the embryo before its organs show any sort of specific develop-

ment. The figures are greatly exaggerated in size. The last figure, for instance, represents an embryo aged about one month, and $1/10$ inch in length. At the sixth week, the human embryo measures about $2/5$ inch in greatest diameter, and by that time there are developed at the head end, the mouth, eyes, ears, and nasal cavities; and from each side two flattened buds have grown outwards—the rudiments of the upper and lower limbs. The marvel of it! a new organism tucked away in a spherical sac $2/5$ inch in diameter, yet already easily recognizable as a human being. It is about this time (the 6th week of intra-uterine life) that deposition of calcium salts to form the bones begins, and is accompanied by the formation of muscles and joints. Development now proceeds apace, and, about the middle of the 4th month of pregnancy, movements of the child, now almost fully formed, can be felt. From this time onwards, development consists almost entirely of mere increase in size. During the later months of pregnancy the pulsations of the fetal heart may be heard with the stethoscope.

The embryos of the chick and the human being in Plate 40 should be carefully compared.

If the reader can obtain a little help from a biological friend, he may obtain a clear insight into embryology by examining hens' eggs taken from an incubator and studying the contained chick embryos. The embryo may be studied whole, and most of the main structures may be easily identified during the first two or three days of incubation. Eggs may be opened every 6 or 8 hours during the first 4 or 5 days. The best stages for early examination are those at the end of the 24th, 33rd, 48th, and 72nd hours. The gradual formation of the several organs may be easily observed. The eggs should be opened in normal saline solution at 40° C. It is a simple matter to cut round, with scissors, the germinal disc, to float the embryo off the yolk, to remove the vitelline membrane, and thus to float the embryo, dorsal side up, on to a glass slide. It should be remembered that the egg is normally laid in the gastrula stage.

Frogs' eggs are also suitable material for study. They may be observed in cleavage under a low power; sections of the blastula may be made and sketched; also sections of the gastrula, and at successive later stages, sections of the embryo proper. The eggs of the starfish also afford excellent material. But the process of embryonic development as a whole cannot be clearly shown in the case of any single animal. Different animals have to be selected, and the results of examinations compared. The complete picture of the development from egg to adult, in the case of any particular animal, human or other, is hardly likely to be clearly visualized except by the experienced embryologist.

The Recapitulation Theory

The embryologists of the earlier half of the nineteenth century expressed the view that every animal, in its growth from the egg to the adult condition, passes in turn through stages which *recapitulate its evolution from a primitive form*, or in other words that *ontogeny* (the individual development) repeats *phylogeny* (the development of the race). The theory appeals strongly to the schoolboy whose biological examination paper regularly contains the statement (so it is said), "during its life history an animal climbs up the family tree". When the biologist explains how the tadpole becomes the frog, he is an embryologist; when he explains the origin of the frog-race (amphibians), he is a palæontologist. In other words, embryology deals with individual development (ontology); palæontology deals with racial evolution (phylogeny).

The study of phylogeny (Gk. *φύλον*, a tribe, a race) is the study of blood-relationships consequent upon the evolutionary process; it demands a knowledge of rational classifications. The ways in which systematists arrange animals into species, genera, families, classes, and *phyla* depend upon structure. Phylogenies are "family trees". Rational classi-

fications *suggest* phylogenies. In short, a phylogeny is a formal statement which shows the lineages or blood-relationships of large groups of organisms. We make up a phylogenetic or family tree by comparing the fully grown or *adult* shapes of one kind of animal with those of other kinds, and finding that they can be arranged in an order of increasing or decreasing complexity.

It is almost natural for the beginner in biology to compare the two series (1) the sequence of ontogenetic stages from zygote to adult in the case of some particular animal, and (2) the different adult forms of the succession of animals shown in that particular animal's family tree. Almost inevitably he draws the same inference as the earlier embryologist did, namely, that *if* evolution be a fact, *if* the family tree correctly indicates descent, each set of animals named in the tree must have "evolved" from the preceding set, and that therefore they must have followed exactly the same embryological route as the preceding set, and then have taken a sort of final evolutionary leap forward in order to obtain the new characteristics which distinguish them from the preceding set. Such an inference is perfectly logical, though of course it is based on certain unverified assumptions, not the least of them being that ontogeny is entirely controlled by phylogeny; in other words, nature always follows the old road. If nature wishes to introduce a *variation*, she simply deviates from the road she has already constructed. She never goes back to her starting-point (the zygote) and constructs an entirely new road. It is as if a traveller who knew nothing of Scotland north of Edinburgh but who was thoroughly familiar with the route to Edinburgh from London via Peterborough, York, and Newcastle, suddenly decided to explore the Highlands but flatly refused to proceed via Rugby, Carlisle, and Glasgow, or from any starting-point or by any other route, except the familiar one from London via York.

But *does* nature always work in this fashion and follow the old familiar road?

It was long ago observed that the very young embryonic forms of creatures so widely different as worms, sea-urchins, frogs, and mammals seemed to be scarcely distinguishable, and even the later embryos of, say, sharks, birds, and dogs, undoubtedly resemble one another to an extraordinary degree. Thus development does seem to proceed in strictly parallel lines at any rate up to the point where specific deviations begin to occur. Hence the recapitulation theory certainly does at first sight seem to provide us with a satisfactory explanation of evolution.

It was the German zoologist **Karl Ernst von Baer** (1792–1876) whose researches in embryology enabled him to enunciate these four laws:

1. In development from the egg, the general characters appear before the special characters, and

2. From the more general characters, the less general, and finally, the special, characters are developed.

Thus in the development of, say, the chick, there is a stage at which it may be recognized as a vertebrate but not what kind of vertebrate; there is a later stage when it may be recognized as a bird but not what kind of a bird.

3. During the development, the animal departs more and more from the form of other animals, and

4. The young stages in the development of an animal are not like the adult stages of the other animals lower down in the scale but are like the young stages of those animals.

Thus animals are more similar at early stages of their development from the egg than when they are fully grown, and this resemblance between early stages becomes progressively diminished as they grow older.

According to von Baer, therefore, a developing animal during its ontogeny does not pass through the *adult* stages of other animals but moves away from them.

How then are ontogeny and phylogeny related?

Fritz Müller suggested that ontogeny could follow one of two methods. The developing animal might either (1) pass through all the ontogenetic stages, and then *overstep* the final adult stage, of its ancestor; or (2) *progressively deviate* from the ontogenetic stages of the ancestor. The latter is confirmatory of von Baer's third and fourth laws. It should be noted that Müller bases phylogeny on ontogeny, for it is the changes in ontogeny that make the adult descendants differ from their ancestors and so add a new link to the phylogenetic chain.

Ernst Heinrich Haeckel (1834-1919), Professor of Zoology at Jena for nearly fifty years, famous for his zoological researches and biological generalizations, expressed his view of the relation of ontogeny to phylogeny in the form of "an hypothesis of *biogenetic law*". This was just an hypothesis of recapitulation: *ontogeny was regarded as a short recapitulation of phylogeny*, phylogeny being considered as the mechanical cause of ontogeny. Haeckel's view was that the adult stages of the ancestors are repeated during the development of the descendants, but they are crowded back into the earlier stages of ontogeny, therefore making the latter an accelerated repetition of phylogeny. For instance, in the unhatched bird and unborn mammal there is a stage in which gill-slits or pouches are present. Haeckel urged that these gill-slits represented the gill-slits of the adult stage of the ancestral fish, which in birds and mammals has been pressed back into early stages of development.

Haeckel's biogenetic law thus abandons von Baer's principle of progressive deviation, and really reverts to Müller's "overstepping". The law logically leads to the inference that the new variations by means of which evolution was brought about occurred at the end of the ontogeny of the ancestor; in other words, the evolutionary novelty first appeared in the adult.

But the biogenetic law is open to criticism. In the first place, the order in which characters appeared in phylogeny

is not always faithfully reproduced in ontogeny. For instance, teeth were evolved before tongues, but in mammals tongues now develop before teeth. How could such a reversal of order come about during the accelerated repetition? In the second place, our rapidly increasing knowledge of the details of early stages of development tends to show more and more clearly that the early stages of quite closely related animals, such as the hen and the duck, may be distinguished. **Wilhelm His**, Professor of Pathology at Berlin, concludes that, even at these early stages, developing animals possess the characters of the class, order, species, and sex to which they belong. **Oskar Wertwig**, Professor of Comparative Anatomy at Berlin, maintains that the very zygote itself must have specific characters, although they may be invisible, and that the zygotes of different animals are really as distinct from one another as are their adults. Professor **Garstang** maintains that there has been evolution along the line of zygotes, in consequence of which animals have modified their ontogenies and have therefore changed the shape of the final stage of development, the adult. From this it follows that phylogeny is not the cause but the *result* of ontogeny. Dr. **C. C. Hurst** also denies that "phylogeny can so control ontogeny as to make the latter a record of the former".

Evidently, then, there is a fundamental difference of opinion concerning the relation of ontogeny and phylogeny.

Embryology is making great advances and our knowledge of ontogeny is therefore rapidly increasing. But our knowledge of phylogeny is scrappy and is likely to remain so. If all animals had been preserved as fossils, and if all these fossil remains had been discovered, we should be able to trace an unbroken series of adult ancestral forms which would represent the phylogeny of the race under consideration. But the fossil record is very imperfect, and we have only a few isolated forms to indicate the road by which phylogeny has travelled.

It is, however, a fact that the view rapidly gaining ground is that evolution is not the alteration of the characters of the

ancestral adults but a modification of the ontogenics of the descendants. Haeckel's recapitulation hypothesis is losing favour.

In the development of any organism we have to distinguish between the internal factors which are at work inside it and the external factors which constitute its environment. Since the internal factors are present in the fertilized egg, they may be regarded as the transmitted factors, the passage of which from parent to offspring constitutes heredity. These internal factors are now called Mendelian factors or *genes*, and they are regarded as discrete units situated in the chromosomes of the cell nuclei. A change induced in one of these genes is called a *mutation*.

The study of mutation is the study of the principal problem of heredity.

BOOKS FOR REFERENCE:

1. *Embryology of the Invertebrates*, E. W. MacBride.
2. *Embryology and Evolution*, G. R. De Beer.
3. *Experimental Embryology*, J. W. Jenkinson.
4. *Vertebrate Embryology*, J. W. Jenkinson.
5. *Manual of Embryology*, J. E. Frazer.
6. *Text-book of Embryology*, M. T. Harman.
7. *Animal Biology*, Haldane and Huxley.
8. *Growth*, G. R. De Beer.
9. *The Mechanism of Creative Evolution*, C. C. Hurst.
10. *Essentials of Biology*, J. Johnstone.
11. *Animal Biology*, L. L. Woodruff.
12. *Organism and Environment*, J. S. Haldane.

CHAPTER XLV

Evolution and Heredity

In the early part of the eighteenth century, an hypothesis of animal development was put forward, according to which the whole of the organs of adult animals were already present in the "egg" but were so small as to be invisible; and the process of development consisted in their "unrolling" (evolving) and growing. The head of the spermatozoon was often actually pictured as a minute, already perfectly formed adult animal. To this was opposed the hypothesis of "epigenesis", according to which the embryo consisted of layers of undifferentiated tissues out of which the adult organs were developed by growth of different degrees in different parts. A lively controversial war was waged between the two schools until the improvement of microscopic methods decided in favour of the epigeneticists.

The term "evolution" is by no means confined to biology. We sometimes speak of the evolution of the bicycle, or the evolution of the battleship. Picture the different types of bicycle of the last sixty years, arranged in a row from the old "boneshaker" to the present "safety"; or the different types of warships from those used at Trafalgar to those of the present day. The difference between any two next-door neighbours would be trifling; the difference between the end specimens in the row would be great indeed. At every stage, a *variation* in construction was introduced; the variation was an *improvement*; the improvement led to the *extinction* of the older type and the *survival* of the newer, until the newer was in turn itself superseded. There was

always "a survival of the fittest". "Variation" and "survival" are two terms which form the current coin of evolution. Rather loosely, perhaps, we talk about the evolution of surgery, of architecture, of educational ideals, and of a hundred other things. The term is not inappropriate, inasmuch as it definitely connotes "development" of some kind. Be it noted, however, that "development" does not necessarily always connote "progress".

Evidence of Animal Evolution

Since organic evolution is a process which requires for even its partial accomplishment many millions of years, *direct* evidence is unobtainable. All the evidence is indirect. The main facts may be placed under three heads:

1. *Facts from Systematic Biology.*—Morphological comparisons have been made of existing allied *species*, and the accumulated facts are now so overwhelming that it seems almost irrational to question the main principle of evolution any longer. Like species are grouped into a *genus*, like genera into a *family*, like families into an *order*, like orders into a *class*, and like classes into a *phylum*. A **phylum** includes all the organisms with a recognizable similarity in their general plan of structure, a similarity which on the theory of evolution indicates that all the organisms within the phylum are descended from a common ancestor. Thus all animals, man included, with segmented backbones belong to the phylum *vertebrata*. A **species** consists of a series of individuals resembling each other closely, apart from distinctions of age and sex. The animals of any species freely interbreed with one another and produce fertile offspring. Animals of different species breed with difficulty if at all, and only produce sterile hybrids. The question of evolution really resolves itself into the inquiry *how the distinct species came into being*. The intermediate grades of classification—genera, families,

orders, and classes—are little more than convenient arbitrary collections of species, with limits varying according to the predilections of different naturalists. When Darwin called his book, *The Origin of Species*, he went to the root of the matter. The **species** and the **phylum** are the two groups of fundamental importance.

It is, however, common knowledge that every large and wide-ranging species is divided into local *races* or *varieties*, differing from one another in such minor points as colour of skin, hair or feathers, size, density of fur, or length of limbs. Different varieties of dogs, for instance, are familiar to everybody. The varieties or races of a species interbreed freely. But it is often virtually impossible to decide whether two different animals belong to the same or to different species. Fig. 168 shows 17 existing forms of the fresh-water snail, *Paludina*. Compare Nos. 1 and 17; most observers would regard them as distinct species. Now compare any two next-door neighbours; the difference is so slight that we do not hesitate to say they are merely varieties belonging to the same species. Then what are we to decide about 1 and 17? The limits of species are mostly matters of surmise. Sterility is a rather uncertain factor on which to base a decision, as sterility is probably a by-product of increasing difference of constitution. There seems to be every gradation between a race and a species, and as races owe their differences to the different effects of their surroundings, the distinction of species may perhaps be assumed to be due to the long-continued and deeply ingrained influence of different surroundings.

2. *Facts from Embryology*.—The main facts appear in connexion with considerations of ontogeny and phylogeny in the last chapter.

3. *Facts from Palæontology*.—In order to have been entombed and to have become a fossil, an animal or plant must have (1) possessed a skeleton, and (2) been covered up by a deposit. Sometimes the entire original organism is found, e.g. the woolly rhinoceros and the mammoth, frozen in mud

and ice; whole insects have been found in fossil resin (amber). Sometimes the skeleton alone is found, the organic matter being lost, as in certain shells in the pliocene beds. Sometimes the original matter has been carbonized, as in some animals and plants with chitinous skeletons, such as grap-

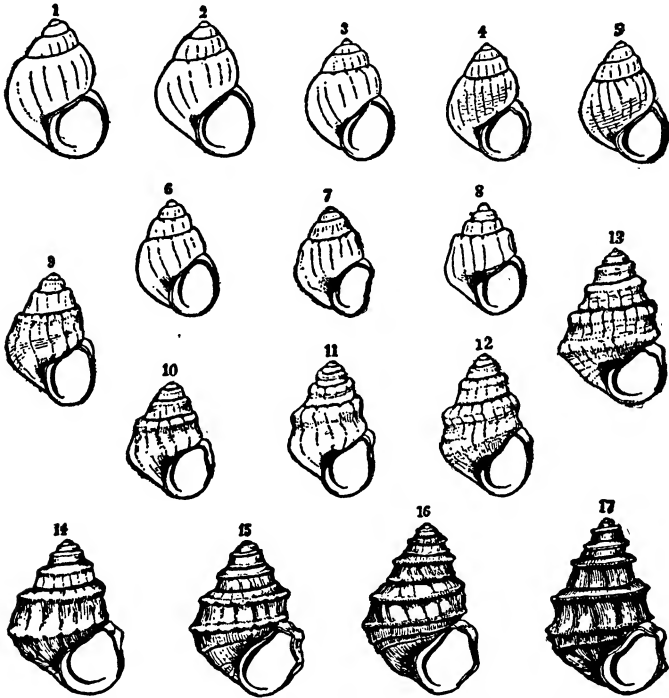

Fig. 168.—To show Intergrading Variation in 17 existing forms of the fresh-water snail *Paludina*, from various localities. The extremes would be regarded as distinct species, if they were not connected by a complete series of intermediate forms.

tolites. Sometimes only a mould of the skeleton remains, the skeleton having been carried off by water charged with carbon dioxide. Sometimes there has been petrification; the original material has been replaced by another material. Sometimes mere imprints alone survive.

By the study of the stratigraphical succession of fossil forms the phylogeny (race-history) of many animals can be

traced with considerable certainty. Progress from one geological system to another from below is obvious. It is often easy to note the time of appearance of each great group; the mesozoic mammals, for instance, are all marsupials, and not until Tertiary times do Placentals appear; none but animals without a backbone have ever been found in the oldest fossiliferous rocks; fishes obviously flourished long before any lung-breathing backboned animals; the cold-blooded amphibians and reptiles appear, successively, before the warm-blooded birds and mammals; man appears at the end. Linkage forms may often be noted: reptile-like birds, bird-like reptiles, amphibians with affinities to fish, fish with affinities to the amphibians, tapirs with affinities to horses, forms intermediate between camels and llamas; and so on. The palæontologist is thus able to "rough out" ancestral lines. He cannot do more, for palæontological records are very incomplete. Only in a few cases has he been able to discover something like a perfect record of the evolutionary changes that have taken place. The camel, the elephant, and the horse are the three best known. The story of the evolution of the horse has been plainly told in the famous Canyon of Colorado, where a remarkable series of fossils has been discovered in the successive great layers of rock. Thanks to the work of **Osborn** and his colleagues, we now know of over 260 fossil species lying on or near the line of descent of the modern horse and its living relatives from four-toed and short-toothed ancestors. We may mention a few of the evolutionary types. At the bottom is found a tiny animal with four toes (*Eohippus*), not much larger than a fox-terrier; above and later is a larger animal with only three toes (*Mesohippus*); higher up and still later is a still larger animal, with the two side toes reduced (*Merychippus*); later again, the *Pliohippus*, with the two side toes little more than splints; finally we come to the modern horse (*Equus*) with only one toe, though the remains of the other two are still just visible when we examine the bones of the foot in a skeleton. There are also numerous other intermediate types. At each step

there are gains and losses of characters. The evolution has taken some 50,000,000 years from the Eohippus to the present day. It is reasonable to infer that this particular line of evolu-

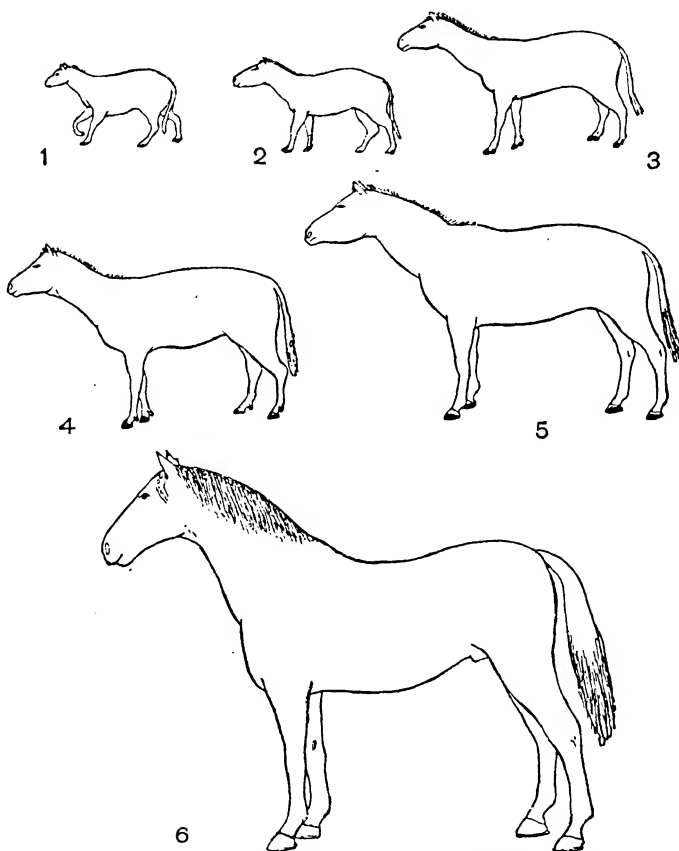

[By permission of the Trustees of the British Museum of Natural History

Fig. 169

tion resulted from the environment demanding from the horse increased running power: the legs were lengthened, the number of toes was reduced, and serviceable well-formed hoofs were developed. Parallel modifications of the teeth were also

effected. The horse developed means (1) to *run away* from his enemies (man was the chief one: he was developing at the same time), and (2) to *browse* over vast plains. The study of such a series of related types seems to compel us not only to adopt the hypothesis of evolution but also to feel that any other hypothesis would be unreasonable. See fig. 169. Notice specially the evolution of the hoof.

The visitor to New York who actually sees in the museum there the collection of fossil specimens will possibly be driven to accept the hypothesis of the evolution of the horse forthwith. The evidence seems to be overwhelming.

The accumulated facts of animal ancestry enable the biologist to construct a hypothetical genealogical tree. We have already given one on p. 751; that was a purely diagrammatic representation of one possible line from protist to man. We now reproduce a much more elaborate, if less direct, line, due to Professors Haldane and Huxley. Its reversed direction shows ascent rather than descent. Every deviation from the main stem tells an interesting story, and the whole table should be carefully studied in connexion with the text of the book in which the original table appears. The first part, fig. 170A, shows the evolution of animals before the period of the Vertebrates. The **Protozoa** are single-celled, and the earliest animals: the *amæba* is a familiar type to the schoolboy. The **Metozoa** which followed them are many-celled animals. Literally a *Protozoon* is a "first animal" (Gk. *πρῶτος*, first; *ζῶον*, animal), and a *Metazoon* is an animal that comes *after* (Gk. *μετά*) a Protozoon. All metazoa pass through the *gastrula* stage (p. 771).

The simplest representatives of the Metazoa are put into the phylum **Cœlenterata** (Gk. *κοίλος*, hollow; *έντερον*, intestine). A primitive cœlenterate is essentially a small bag or tube which fulfils the functions both of the cœlom (body cavity) and of the enteron (intestinal tract) of higher forms. The fresh-water *Hydra* is a familiar type.

The next great advance was to the phylum **Cœlomata** (Gk. *κοίλωμα*, body-cavity), in which the body-cavity proper

is differentiated from the alimentary tract. The opened body cavity, from which the alimentary canal (stomach and intestine), liver, heart, lungs, and other organs have been removed, is a familiar sight in the butcher's shop when freshly killed animals are hung up. The Cœlomates include the Echinoderms (e.g. star-fish and sea-urchins), the Molluscs (e.g. shellfish and snails), the annelids (segmented worms), and the arthropods (e.g. lobsters and crabs, spiders, insects, &c.).

Fig. 171, page 791, taken from Wells, Huxley and Wells' *The Science of Life*, will repay careful study.

The second part of the table (fig. 170B) shows the next great advance—and a tremendous advance it was—that to the **Vertebrata**. The characteristic of the cœlomates, viz. the body tube and the separate intestinal tract, is continued, but the addition of a jointed vertebral column or backbone is a new feature. That the vertebrates were descended from the cœlomates there is little room for doubt, but did they come through the Arthropods (Gk. ἄρθρον, joint; πούς, ποδ-, foot), or through the Annelids, or through a common ancestor? The Arthropoda, with their jointed legs, contain more than 200,000 species (crustaceans, insects, spiders, &c.) and vertebrates *may* have come through them. But we really do not know, and Professor Haldane and Huxley's caution is revealed when they abstain from saying that fig. 170B should be placed on the top of fig. 170A.

Once we have arrived at the vertebrates, there is greater room for certainty, for the palæontological record is more complete. The earliest vertebrate which has so far been found belongs to a primitive type of fish, and occurs in the Ordovician, the next geological division above, and therefore more recent than, the Cambrian. It is a matter of verifiable fact that the sea was already swarming with highly-developed fish before the first amphibians appeared on land. The beautiful and efficient "stream-lines" of such fish as mac-kerel and trout are the envy of all shipbuilders. Owing to the great competition among the vertebrates in the sea, it

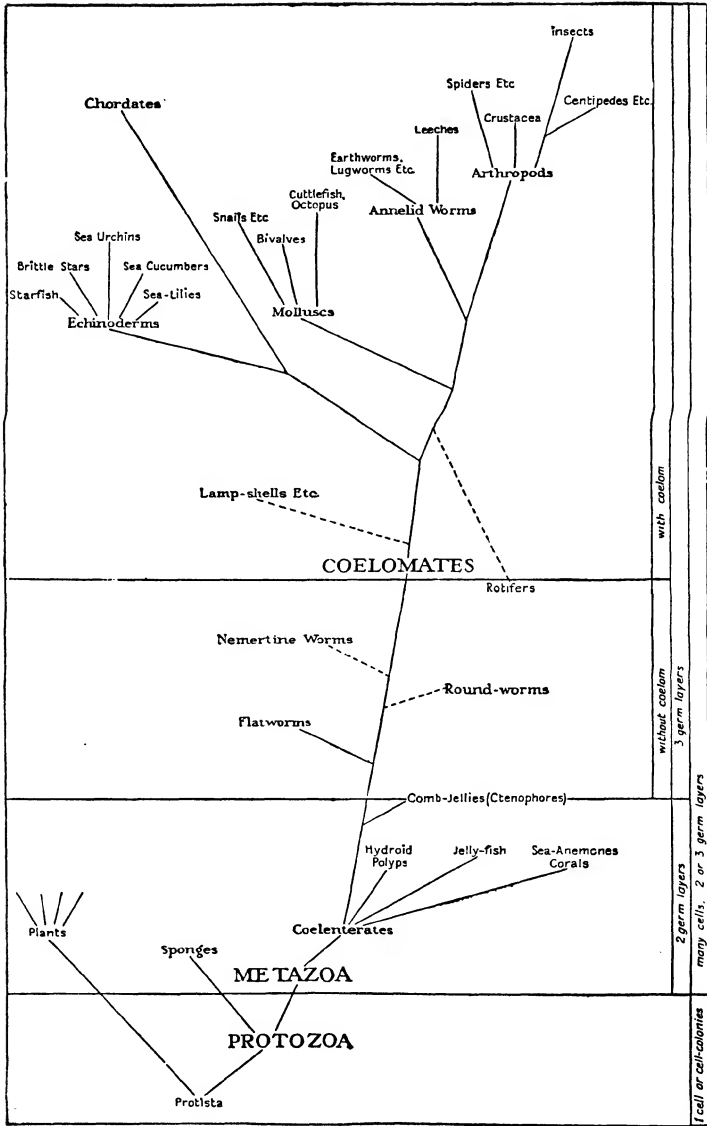

Fig. 170A.—A diagram of the probable relationships of the main groups of the animal kingdom

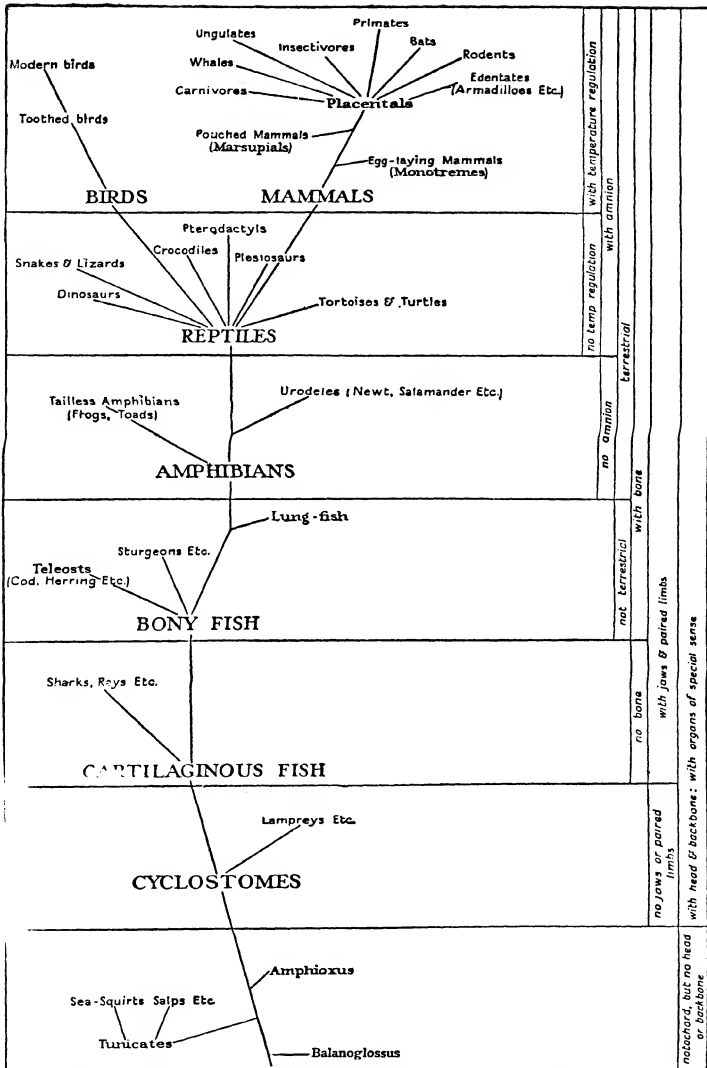

Fig. 170B.—Diagram of the probable relationships of the main groups of the vertebrates (Chordata)

The diagrams are arranged in the form of a genealogical tree, with a few of the main steps in evolutionary advance at the side. A dotted line leading to a group indicates that the position assigned to the group is doubtful. Descending lines indicate evolutionary degeneration. Some of the smaller and less important groups are omitted.

would be a great biological advantage to any species if it were to vary in such a way as to enable it to live on land, for it would have fewer enemies. Gradually the step forward was made, and **Amphibia** (Gk. ἀμφί, both; βίος, life), (e.g. salamanders and frogs) were evolved, probably in marsh and swamp. The Amphibians were the first vertebrates able to produce vocal sounds voluntarily. But the conquest of the land by the Amphibians was only partial, though it did involve the transformation of swim-bladder to lungs, and of paired fins to true limbs with fingers and toes. The territory between water and land was conquered, but not the dry land as a whole. For millions of years Amphibia remained the highest vertebrate type, but by slow degrees animals appeared with heritable variations which made it possible for them to live farther away from water. Eventually Amphibia gave way to **Reptiles**, and the conquest of the land was complete. In higher reptiles, now mostly extinct, the body was for the first time raised off the ground and supported by the limbs. Meanwhile the heart became more or less completely divided into separate parts.

From the reptiles, two separate lines sprang, the **Birds** and the **Mammals**. Both had developed not only a mechanism for securing a constant temperature-environment for the tissues of the body, but also a completely divided heart. **Birds** acquired feathers and wings, and conquered the air. **Mammals** acquired hair, and the female mammals developed *mammæ* or glands for secreting milk, and a placenta for ensuring an interchange of food, respiratory gases, &c., between the mother and the embryo within the uterus (womb). Of course all these advances took vast periods of time, even thousands of millions of years. Eventually man was evolved, perhaps a single million years back.

This very brief outline must suffice. If the reader will but refer to special works on the subject and ponder over the masses of facts that have now been accumulated, he will be in a position to judge for himself. If he is fortunate enough to have been at school where biology is taught, and to have

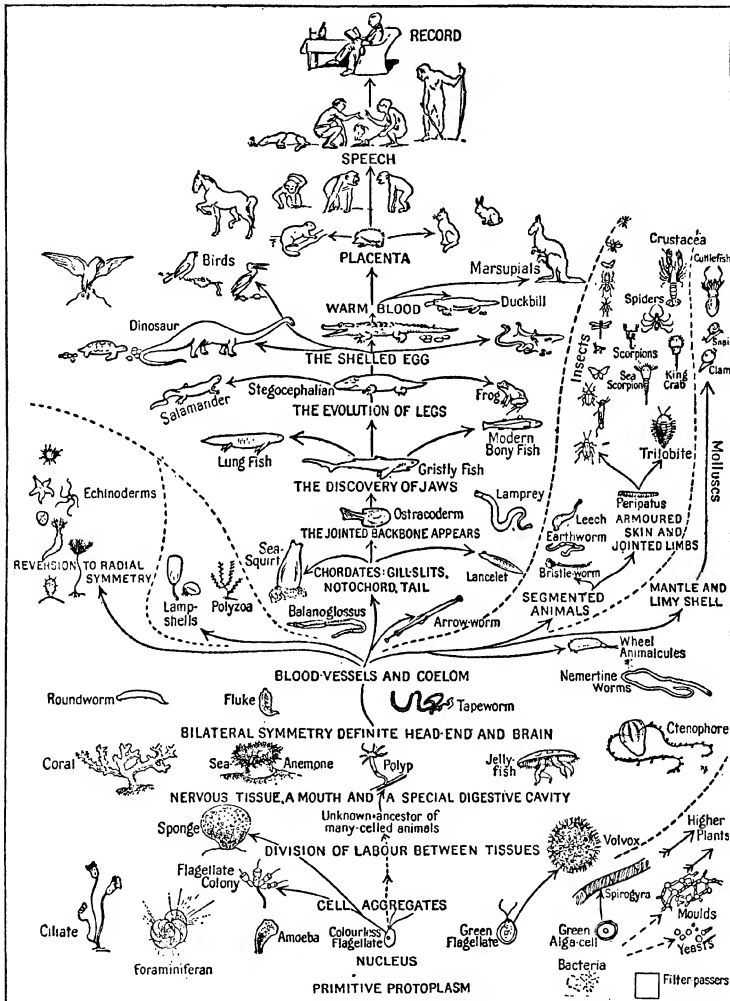

Fig. 171.—The ascent of life

dissected a few types of animals selected from the various phyla, he will be in a position to weigh the evidence for evolution judicially. It is exceedingly difficult to weigh evidence obtained exclusively from books, though such a lucidly-written book as that by Haldane and Huxley will help the amateur greatly.

Whenever some new great type has evolved, especially a great phylum, adaptive specialization set in; there was a common general ground-plan, but variations occurred for adaptations to different and usually incompatible modes of life. Moreover, among the later evolved types there is to be found greater complexity of organization, greater control and independence of environment. Whenever two races of animals came into competition, the issue was decided by the qualities which each happened to possess. "Natural Selection" is a general name for the effect wrought upon the animals by the whole of the environment with which they come into relation, an effect which acts like an automatic sieve, letting some through to perpetuate themselves, and keeping back and so extinguishing others. "Struggle" and "competition" are, however, largely metaphorical terms. When the British sparrow was introduced into America, he did not secure his dominance by actually making war on the native sparrows. He lived on the same food and occupied the same sites, but he was endowed with qualities which gave him an advantage. There was thus an indirect kind of struggle; the native sparrows rapidly decreased, and the invader became supreme. It is just the same with the most highly developed of all animals, *homo sapiens*. All down through history, the "fittest" nation has "survived", whether by actual war or by more peaceful means. And will not this inevitably apply to the future? How is a nation that has become "slack" to survive when it has to compete with nations still virile?

The evolutionary hypothesis is not without its difficulties. For instance, time does not *always* bring about change. The general characters of dragon-flies have persisted

ever since the Carboniferous period; the common lamp-shell (*Lingula*) possesses almost the identical shell now that its ancestors did in Cambrian times, say, 500,000,000 years ago. The limpet (*Patella*), so familiar on our shores, has been the silent changeless watcher of the evolution of other animals ever since Silurian times, say, 300,000,000 years ago. Again: there is hardly any evidence of the actual origin of the great Phyla: most of them seem to have appeared very suddenly. As for plants, there is a general absence of transitional forms; ferns, equisetums, and lycopods appear as far back as Old Red Sandstone times, structurally even more complex than their living descendants. The oldest known dicotyledons are those of Cretaceous formation; in the same deposit, representatives of the three great divisions, apetalous, monopetalous, and polypetalous are found together. Even if we make due allowance for the imperfection of palæontological records we feel almost driven to admit that the resulting difficulties tend to weigh down rather ominously the scale adverse to the hypothesis of evolution. The difficulties are not to be dissolved by shallow hypotheses.

The hypotheses of the actual *methods* of evolution we shall come to in a later section.

Heredity

The term Heredity implies that living organisms can produce their like. The resemblance, though never absolutely perfect, may extend to the most minute details of structure and function. It may be predicted confidently that a new zygote, formed by the fusion of ovum and spermatozoon, will sooner or later exhibit those details of form and of function which characterize the species, the race, even the family to which it and its relatives belong. On the other hand it has long been recognized that no son is the exact replica—the carbon copy, as Dr. Crew expressively puts it—

of his father. *Variation*, or deviation from the average of the stock, is universal.

To be acceptable, any hypothesis of heredity must account for all the main facts of the general likeness of parent and offspring.

In particular:

1. *Variations* occur in the offspring, i.e. characters that are not exhibited in the same degree by the parent.

2. *Specific similarities* occur in the offspring, i.e. characters that occur in one or both parents.

3. Characters may occur in the offspring that do not occur in either parent, but that did occur in a grandparent, or in some more remote progenitor.

4. Characters acquired by a parent in the course of his or her life, as the result of apparent interaction with the environment, *seem in some cases* to reappear in any offspring subsequently born. (This has given rise to great controversy.)

For at least two centuries the zygote (the fertilized ovum) has been looked upon as containing in *some way* the physical basis of the new organism, and during the last fifty years it has become more and more certain that in the zygote there must be something which predetermines the future individual's structural, functional, and even mental, characteristics. There is now, in fact, a complete consensus of opinion that in the zygote is to be found the whole secret of heredity. Although each of the two parents contributes only a single cell so minute as to be far beyond the limits of the unaided eye, yet it is now universally believed that the two cells united in the zygote is *the only material link between the two generations*, and that across this extraordinarily narrow bridge everything organic which any generation can receive from its predecessor must pass. In some form or another the zygote must contain the innumerable factors—whatever physical form these may happen to have—which bring about the build of the child on the model of the parent. Is the child to have blue eyes? then the determining factor must

already be in the zygote. Is the child to have curly hair? then the determining factor must already be in the zygote. And so generally.

As the result of countless experiments, the *chromosomes* are now regarded as the only identifiable cell-organs which, by their observed behaviour, can possibly satisfy the conditions of hereditary transmission.

Since there are equal chromosome contributions from the two parents, since there is a random assortment at maturation, since there is a random recombination in fertilization, since, as we shall see later, there is a possibility of an inner reorganization of each chromosome through its most intimate association with another of identical structure but different content, it must logically follow that an almost infinite range of new combinations of characteristics is possible. The chromosome mechanism can apparently supply all the variations upon which the forces of selection can operate.

But the inner structure of the chromosome is really beyond the limits of the microscope, and the various hypotheses concerning it are necessarily extremely speculative. We shall come to them presently.

Twentieth Century Workers

We referred in Chap. XLIII to some of the earlier workers in the fields of evolution and heredity, two fields with a barely tangible boundary line between them. There are various other workers to whom it becomes necessary to refer now.

All workers in these fields necessarily have to think in terms of the three categories, organism, function, and environment. To some it has always seemed that emphasis should be laid on the living *organism*, an agent selecting its environment, adjusting itself to it, self-differentiating, and self-adaptive. To others it has always seemed that the emphasis should be laid on *function*, on use and disuse, on doing and not doing.

This is one of the fundamental ideas of Lamarckism, and to some extent it met with Darwin's approval. To others it has always seemed that the emphasis should be laid on the *environment*, which awakens the organism to action, prompts it to change, moulds it, prunes it, and finally, perhaps, kills it.

Of the old guard, as they are sometimes called, **Buffon**, **Erasmus Darwin**, and **Lamarck**, only the last calls for further mention. The central idea of Lamarck's hypothesis was the cumulative inheritance of functional modification. "Changes in environment bring about changes in the habits of animals. Changes in their wants necessarily bring about parallel changes in their habits. If new wants become constant or very lasting, they form new habits; the new habits involve the use of new parts, or a different use of old parts, and this results finally in the production of new organs and the modification of old ones." Lamarck maintained that "acquired" modifications are being continually produced and perfected by every organism during its life, and that they are at least partially transmitted to its offspring, so that each generation is rather better adapted to its surroundings than its predecessor. In this way, the great length of the neck of the giraffe would be explained by the continual striving through many generations to reach higher branches in the trees; and the limbless condition of snakes would be explained by the gradual loss of limbs through disuse. Lamarck's present-day followers are known as "Neo-Lamarckians", of whom Professor **E. W. Macbride** is the recognized protagonist; but they do not follow Lamarck unreservedly.

Charles Darwin himself not only overtowered his predecessors but he has secured the willing admiration of all biologists who have succeeded him. He was the Newton of the theory of evolution. His vast masses of accumulated facts, and his rigorous inductive reasoning, simply overwhelmed his opponents and eventually carried conviction in every quarter, though not all modern biologists accept his views in every detail. His main hypothesis was that of

“ natural selection ”, with the consequential “ survival of the fittest ” in the universal “ struggle for existence ”. A subsidiary hypothesis was that of sexual selection. He assigned some weight to the environment and to the effects of use and disuse, and thus far was in agreement with Lamarck—that change in environment induces a tendency in organisms to vary slightly in all directions, and that those variations which happen to suit the environment are preserved and affect subsequent generations. He regarded the facts of heredity as fundamental facts, and he believed that natural selection is sufficient to account for the evolution of the most complicated organs, even though he always admitted the existence of other contributory factors. Thus, since in the course of secular time, conditions changed substantially, new species evolved and became established.

The term “ natural selection ” is a rather unhappy term, since it seems to imply a positive causative action of some kind. But natural selection is essentially “ non-energetic ”. The term “ struggle for existence ”, though disliked by certain schools of political thought, best connotes what natural selection really means. The power of living things to multiply is so great that, if they all lived, the food supply would soon fail. In the inevitable food hunt, the less capable go under, and die. There is a never-ending struggle between eater and eaten. But there is rarely a conscious effort; usually it is an unconscious competition, some competitors being automatically crowded out. Without variation, however, the struggle would not alter the characteristics of the species. If all individuals of a species were exactly alike, it would be a mere question of luck which of them failed. But since many variations of an advantageous or disadvantageous sort exist and are inherited, the struggle for existence acts on the species like a sieve; it seems to select successful types and therefore to set a premium on advantageous variations. It was this sifting and variation which Darwin meant by natural selection. A variation in the germ plasm, however brought about, either qualifies, or becomes disqualified, for success and

survival. While the environment remains stable, selection will be a stabilizing force. But the environment may change, and may offer inducements to responsive change. This tends to revolutionize the selective action.

The younger school of present-day biologists are mostly "neo-Darwinians" though they do not accept Darwin's views in their entirety.

Darwin believed that the inheritance of acquired characters might be a *subsidiary* cause of evolution, and he suggested an explanatory hypothesis of *pangenesis*. He assumed that minute particles which he called "gemmules" were formed in every part of the body—in every organ and in every tissue—and that these particles swarmed into the germ cells and so into the gametes. The zygote was thus a highly organized thing, and the gemmules supervised the growth and development of the embryo, each gemmule making its way to the appropriate organ or tissue, corresponding to the one whence it had originally come. On such a basis the inheritance of acquired characters could be explained. For instance, an injury to an arm would affect the arm gemmules, and would therefore affect the arms of unborn and unbegotten children. But it was **August Weismann** (1834–1914), the German zoologist, "the leader of the neo-Darwinians", who first worked out something like a definite architecture of the cell. Weismann taught that the germ-cells (which give rise to the gametes forming the zygote) are to be regarded merely as parts of an unbroken line of *germ-plasm* that passed on from generation to generation, and that the germ-plasm is the bearer of the heritable qualities. It has, however, since been discovered that there is no absolute distinction between body-plasm and germ-plasm. But Weismann advanced the striking hypothesis (i) that since the chromosomes contained material derived from father and mother and therefore from earlier ancestors on both sides, each chromosome must be definitely organized into *ids*, each id containing within itself, in some way, all the generic, specific, and individual characters of a new organism, in short, a complete in-

heritance; (ii) that the ids are similar, but not exactly the same; (iii) that each id is itself organized into *determinants*, every one of which is concerned with the formation of some special organ in the embryo; and (iv) that each determinant is organized into *biophors*, the minutest vital units, but each an integrate of numerous chemical molecules and representing some definite "character". It was argued that the biophors must have an actual existence, since every phenomenon in the living organism must originate in a material unit of some kind.

Of course Weismann had never seen an id, much less a determinant or a biophor; and it is doubtful if he had ever seen a chromosome very clearly. Thus his hypothesis was purely speculative. Had he been fortunate enough to unearth the records of Mendel's forgotten work (Bateson did this in 1900), he might have placed his hypothesis on a firm basis of observed facts. As it was, his hypothesis was the result of a guess, and the guess very nearly hit the mark.

Mendel's experimental work has since given rise to the new subject, *Genetics*: we shall refer to it in the next section. At bottom, Mendel's method is a *statistical* method, and is wholly different from the methods of Lamarck and Weismann.

Statistical methods are usually based on direct observation of the *frequency of occurrence* of a certain character or group of characters in a large number of individuals of a particular species, compared with the occurrence of the same characters, or group of characters, or related characters in the parents or in the remoter ancestors. The purely statistical facts are then analysed by mathematical methods: it is largely a method of numbers and graphs. The method requires no hypothesis, though the *results* may suggest one.

Sir **Francis Galton** (1822-1911), who was followed up by **Karl Pearson** (b. 1857, until recently Galton Professor of Eugenics in the University of London), investigated characters which vary continuously and can be measured, e.g. stature, colour of the eyes, disease, the artistic faculty, and so forth. Galton's law of ancestral inheritance has a

foundation which is firm thus far—that it is based on systematic observations: the two parents between them contribute *on the average one half* of the child's inherited faculty; each contributes $\frac{1}{4}$. The four grandparents contribute **one quarter**, or each $\frac{1}{16}$. And so on. The sum of $\frac{1}{2} + \frac{1}{4} + \frac{1}{8} + \frac{1}{16} + \dots$ is equal to 1, as the law would lead us to expect. The law is *statistical*, dealing only with large averages. It is merely a summarized record of actual observations. Pearson has been the chief exponent of this biometrical study which was founded by Galton.

Mendel's method was adapted to characters which vary *discontinuously* and can be sharply separated out into classes. His investigations related to the laws of inheritance in *hybrid varieties*. He hit upon the device of selecting one at a time out of the many thousands of characteristics of an individual, and finding out how that one is transmitted through several generations. He experimented in 1866, chiefly on varieties of peas. He kept accurate pedigree records of the 10,000 plants he grew, showing the ancestry and the characterization of each individual. He counted the number of dissimilar kinds, and was thus able to give an exact mathematical statement of his results. Mendelism, considerably modified, provides the foundation of Genetics.

Hugo de Vries (b. 1848), Professor of Botany at Amsterdam, was greatly influenced by Mendel's work, and himself originated the hypothesis of mutation. **E. B. Poulton** (b. 1856), Hope Professor of Zoology at Oxford, is a recognized authority on Darwinism; the results of his experiments on butterflies are of the utmost value, and his contribution to *Darwin and Modern Science*, viz. "The Value of Colour in the Struggle of Life", is highly suggestive.

William Bateson (1861-1926) is no longer with us, but he was one of the most distinguished of British biologists. He championed the idea of "saltatory" or "discontinuous" variations. These have undoubtedly occurred when domesticated animals have been bred and crossed for long periods, but we cannot assume that they have ever led to forms which

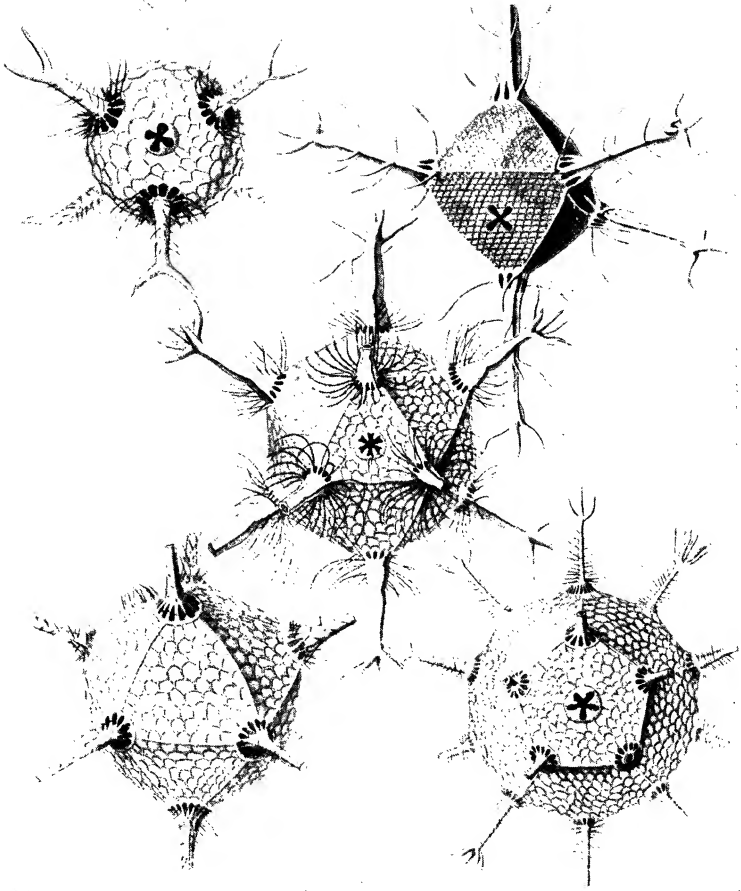

Skeletons of Various Radiolarians—After Haeckel

From "On Growth and Form", D'Arcy W. Thompson (Cambridge University Press)

are capable of survival under the conditions of wild life. Eventually Bateson expressed the opinion that the experimental methods which Mendel inaugurated provide us with the means of reaching a considerable degree of certainty in regard to the physiological basis of heredity. It was Bateson who coined the term "genetics".

Of the various university professors whose views on evolution and heredity are weighty and command respect, we may mention four: **E. S. Goodrich** (b. 1868), Linacre Professor of Zoology at Oxford; **Julian S. Huxley** (b. 1887), grandson of T. H. Huxley, until 1927 Professor of Zoology at King's College, London; **E. W. MacBride** (b. 1866), Professor of Zoology at the Imperial College, South Kensington; and **J. W. Heslop-Harrison** (b. 1881), Professor of Botany in the University of Durham. Three eminent members of the Human Genetics Committee which was organized under the auspices of the British Medical Research Council, are **J. B. S. Haldane** (b. 1892), Professor of Genetics in the University of London; **R. A. Fisher** (b. 1890), Professor of Eugenics in the same university; and **Lancelot Hogben** (b. 1895), Professor of Social Biology, also in the University of London. With three such collaborators, all in the prime of life, the new subject of Genetics should progress rapidly. Haldane and Fisher have struck out on a new line.

Until **D'Arcy W. Thompson** (b. 1860), Professor of Natural History at St. Andrews, produced his remarkable book, *On Growth and Form*, not all biologists had paid much attention to the mathematical side of their subject. Few of them knew, for instance, that the permanent curves of the horns of ruminants, of molluscan shells, of the arrangement of the florets of the sun-flower, and the transitory curves in the coil of an elephant's trunk, in the coils of a cuttle-fish's arm, or of a monkey's tail, are all mathematically true Archimedean spirals. Examine the beautiful section of the Nautilus in fig. 172.

Biology is simply full of extraordinarily interesting mathematical relations. Plate 41 shows five figures selected by

Professor D'Arcy Thompson from Haeckel's Monograph of the "Challenger" *Radiolaria*, representing the skeletons of various Radiolarians. Look at the beautiful octahedron, dodecahedron, and icosahedron. In Haeckel's book of 140 plates there are many thousands of figures depicting elegant geometrical configurations. And this is but one tiny corner of nature's mathematical bounty.

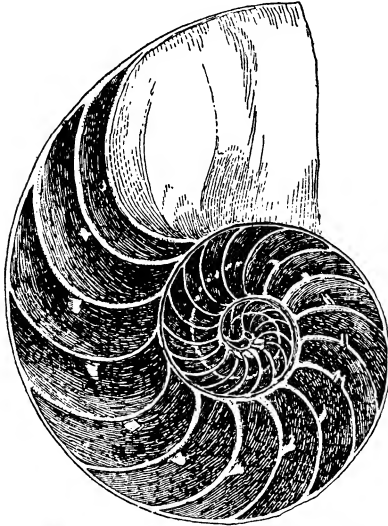

Fig. 172.—Section of nautilus showing the contour of the repla in the median plane, the repla being (in the plane) logarithmic spirals of which the shell spiral is the evolute.

It is therefore particularly satisfactory to find that Haldane and Fisher are attempting to put the whole subject of Genetics on mathematical foundations. Fisher's book on *The Genetical Theory of Natural Selection*, with its new views on the origin of dominance and the natural selection of genotypes, "has already become a classic". Haldane's *Mathematical Theory of Natural Selection* seems to show conclusively that, in evolution, neither mutation nor Lamarckian's

transformation can prevail against natural selection of even moderate intensity. A third worker, on similar mathematical lines, is **Sewall Wright**, in America.

Two other notable Americans call for mention, both of the Columbia University, New York: **H. F. Osborn** (b. 1857) the veteran palæontologist, Research Professor of Zoology; he has been well-known to British men of science for forty years; and **T. Hunt Morgan**, Professor of Experimental Zoology, of whom it is said that he can make any sort of fly to order! Though of course he cannot do anything like

that, his remarkable experiments with the fruit-fly, *Drosophila melanogaster*, have impressed the whole zoological world.

Hans A. E. Driesch (b. 1867), Professor of Philosophy of Berlin and equally well known as a biologist, began as a disciple of Haeckel, but through the influence of **G. Wolff** and **W. Roux**, came to support a dynamic vitalism. His doctrine that the functions of protoplasm cannot be explained mechanically was the outcome of experiments on the blastula of the sea-urchin. He concluded that the organism must be a harmonious equipotential system, possessing a vital individualizing *entelechy*. An equally famous Frenchman, **Henri L. Bergson** (b. 1859), Professor of Philosophy at the Collège de France, also assumes a mystical principle, the *élan vital*, or the urge of life to creative evolution. The identification of such mystical principles is of course beyond the scope of science, and their discussion belongs to the realm of metaphysical philosophy.

Mendel's Experiments and his Conclusions

If a white-flowered and a red-flowered snapdragon be crossed (two individuals of the same species differing in the one contrasting character of *colour*), their progeny will have pink flowers, unlike those of either of the parents. If two of these pink-flowered "hybrids" (F_1 generation) are interbred, they will produce offspring (F_2 generation) of three kinds, with white, pink, and red flowers, and in the proportion of 1 : 2 : 1, respectively. The white-flowered individuals will breed true and continue to breed true if interbred, and similarly with the red-flowered individuals; *but the pink flowers will never breed true*. If the pink are interbred, they will, at every generation, give rise again to the three kinds, *and in the same proportion*. Exactly the same thing happens if a certain breed of black fowl is crossed with another strain which is white. The offspring are of a bluish colour, unlike either parent, a type known as "Blue Andalusian". If the

Blue Andalusians are mated with each other, 25 per cent of their offspring are blacks, 50 per cent are Andalusians again, and 25 per cent are white. The blacks breed true when mated with each other and continue to breed true, generation after generation; so do the whites; but the Andalusians

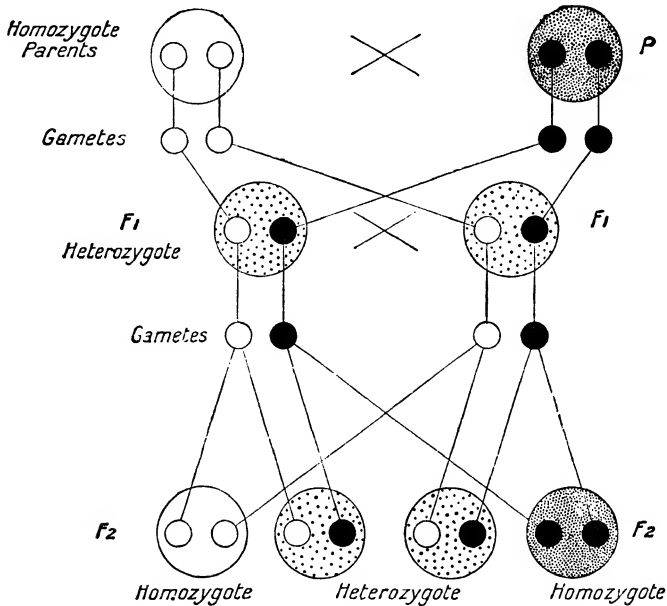

Fig. 173.—Diagram to show the Mendelian conception of hereditary units (factors, genes). The organisms are represented by large circles and small circles within them. In the gametes, only the genes are represented. Unshaded represents splashed-white; black represents the gene for black, and close dotting visible blue.

always give the same proportion of blacks, Andalusians and whites, viz. 1 : 2 : 1. The Mendelian diagram in fig. 173 is instructive. We shall refer to "Genes" in the next section.

Mendel's first experiment of this kind was with the common pea, the contrasted character being tallness and shortness. Then he tried other contrasted characters, e.g. yellow seeds and green seeds; seeds with smooth surfaces

and seeds with crinkled surfaces. The same results were always obtained, the proportion being invariably 1 : 2 : 1. Innumerable similar experiments with animals and plants have since been carried out, and practically always with the same results. When very large numbers are in question, they are not always *exactly* 25 per cent, 50 per cent, and 25 per cent, but they are such close approximations that the significance of the round numbers is never questioned.

It is a logical inference that the parents must somehow carry special factors which bring about such results. Every spermatozoon of a black cock presumably contains a factor of some kind that determines blackness; every ovum of a white hen presumably contains a factor of some kind that determines whiteness. It is assumed that the factors in a zygote are in contrasting pairs, one received from each parent; that in the formation of the gametes only one kind of each of the pair of contrasting or alternative factors can pass into each gamete, and that therefore the factors as a whole are *segregated* (separated) and thus distributed to the individual gametes. If the black cock and the white hen are crossed, their zygote will have one of each colour factor, and the interaction of these will bring about the Andalusian colour. If two Andalusians are crossed, their gametes, whether male or female, will contain *either* a factor for black, *or* a factor for white, but not both. The zygote carrying the pair of similar factors is called a homozygote; that carrying the pair of dissimilar factors is called a heterozygote. Let the factor for black be called *B*, and that for white *W*. A *B*-carrying female gamete may be fertilized equally well by a *B*-carrying or by a *W*-carrying spermatozoon; and similarly for a *W*-carrying female gamete. Hence at fertilization there may occur four possible combinations of gametes:

- (1) *B*-carrying, fertilized by *B*-carrying, yielding black chick.
- (2) *B*-carrying, ,, *W*-carrying, ,, Andalusian chick.
- (3) *W*-carrying, ,, *B*-carrying, ,, Andalusian chick.
- (4) *W*-carrying, ,, *W*-carrying, ,, white chick.

Sometimes the heterozygote resembles one or other of the parents more or less completely; then the factor which is expressed clearly in development is called the *dominant* factor, and that factor which is expressed feebly or is masked is called *recessive*.

A contrasted pair of factors are called **allelomorphs** (Gk. ἀλλήλων, one another, μορφή, form); they are best looked upon as different forms of *one* factor or character. So far we have considered one pair alone, but naturally there will be always many pairs together. For instance, a boy may be blue-eyed or brown-eyed, *A, a*; dark-haired or fair-haired, *B, b*; Roman-nosed or snub-nosed, *C, c*; broad-browed or narrow-browed, *D, d*. We may combine either member of each pair with either member of every other pair. The various combinations may be set out thus:

1. First, consider the two pairs *A, a, B, b*. Either from one pair can combine with either from the other pair, and we have

$$AB, Ab, aB, ab \text{ (4).}$$

2. Secondly, consider these four combinations with the next pair of characters, *C, c*. All four can be combined with *C*, and all four with *c*.

$$\left. \begin{array}{l} ABC, AbC, aBC, abC \\ ABc, Abc, aBc, abc \end{array} \right\} (8).$$

3. Thirdly, consider these eight combinations with the next pair of characters, *D, d*. All eight can be combined with *D*, and all eight with *d*.

$$\left. \begin{array}{l} ABCD, AbCD, aBCD, abCD \\ ABcD, AbcD, aBcD, abcD \\ ABCd, AbCd, aBCd, abCd \\ ABcd, Abcd, aBcd, abcd \end{array} \right\} (16).$$

Thus we should have,

1. A brown-eyed, dark-haired, Roman-nosed, broad-browed boy.
2. A brown-eyed, fair-haired, Roman-nosed, broad-browed boy.

And so on, 16 different combinations in all.

[With 5 pairs of characters we should have 32 combinations ($=2^5$); with 6 pairs, 64 ($=2^6$); and so on].

We cannot, of course, actually experiment with human hybrids, but it is easy enough to experiment with, say, pea-plants that have several obvious pairs of allelomorphic characters. This Mendel did, and his results led to his *law of free assortment*, i.e. factors for different characters are inherited independently of one another. The Mendelian characters all retain their individualities, although they may be assorted and reassorted in the course of the matings of the parents and among the progenies.

This independent segregation of factors is of great practical as well as theoretical importance, for it enables us to take some particular Mendelian character which happens to be desirable in an otherwise undesirable strain or breed, and to combine it with other desirable characters in another breed. This has already been done with great success in wheat, at the experimental plant-breeding station at Cambridge.

Over ten million fruit-flies (*Drosophila*) have been bred in pedigreed cultures by Hunt Morgan in America. Fig. 174 illustrates Mendel's second law, by means of a cross between two strains of the fruit-fly.

Mendelism is a very large subject, and we cannot afford space for more than this brief introductory outline. Its main "principles" seem to be fairly established though some of them may have to be modified as time goes on. The most interesting aspect of Mendelism is the hypothesis which has been put forward in explanation of the action of the

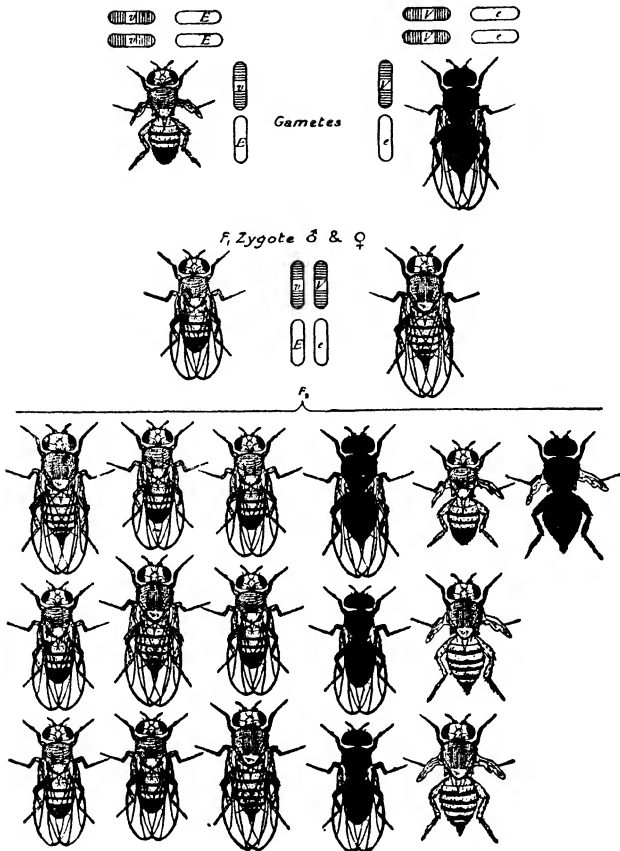

Fig. 174.—To illustrate Mendel's Second Law, by means of a Cross between two Strains of the Fruit-fly, *Drosophila melanogaster*, one pure for the recessive gene *v*, determining vestigial wings, the other pure for another recessive gene *e*, determining ebony body-colour. The corresponding genes for the dominant wild-type characters are styled *V* and *E* respectively. The two genes are lodged in different chromosomes. The chromosomes, together with their contained genes, are represented diagrammatically. The F_1 contain both *V* and *E*, and therefore show a reversion to wild-type. In the formation of the gametes of F_1 , segregation of *V-v* and *E-e* take place independently. Thus four kinds of gametes are produced, *VE*, *Ve*, *vE*, and *ve*. These, uniting at random, give, out of every 16 individuals in F_2 , 9 wild-type, 3 long-winged ebony, 3 vestigial grey, and 1 vestigial ebony: one of each type will breed true. The vestigial ebony is a new combination. Either character taken separately shows a 3 : 1 ratio.

individual factors within the zygote. The hypothesis assigns to every chromosome a definite architecture. In some of its fundamentals it is not unlike the atomic hypothesis, but instead of atoms we have to consider *genes*. Genes are the genetic architect's bricks.

Genes

We reproduce a diagram (fig. 175) prepared (after Wilson) by that well-known Cambridge investigator, Dr. C. C. Hurst (*b.* 1870), showing the life-cycle in animals. Four chromosomes A, B, C, D, coloured white, are shown in the original ovum (female gamete), and four *a, b, c, d*, coloured black are shown in the original spermatozoon (male gamete). Then follow (*a*) the zygote, and (*b*) the processes of mitosis and meiosis. The different chromosomes are shown, for purposes of distinction, of different lengths. In the bottom row of diagrammatic cells, seven possible recombinations of the black-and-white chromosomes are shown, but these are only seven of a possible total of 256! as can be easily verified. Observe that every combination has its four contrasted pairs of chromosomes, in every pair a male and a female derivative. Although the homologous pairs may thus be derived from the parents in so many different ways, there is in all the 256 cases a complete ensemble of agencies for determining characters. Thus an embryo may come from *AbCD*, *abCD*, *aBcD*, and so on. When the chromosomes are very numerous, as in the case of the human being, the possible combination of derived paternal and maternal chromosomes within the zygote is enormous, and apparently it is purely a matter of *chance* which combination may be effected. No wonder that children of the same parents may be so different. An *ABCD* child (so to speak) will necessarily strongly resemble the mother; an *abcd* child, the father; an *aBCD* child will resemble the mother much more than the father; an *abCD* child will be a sort of average between mother and father.

Union of the Haploid Groups. Fertilization.

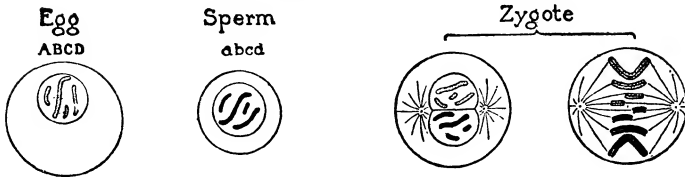

Division of the Diploid Group. Mitosis

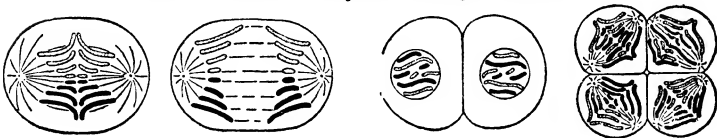

Reduction of the Diploid Groups to Haploid. Meiosis.

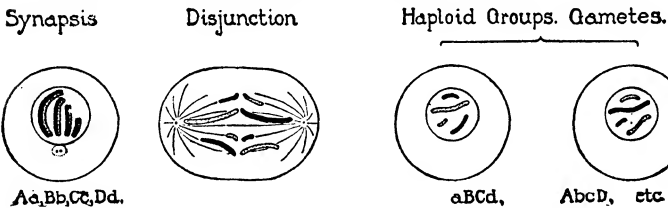

Recombinations in Fertilization.

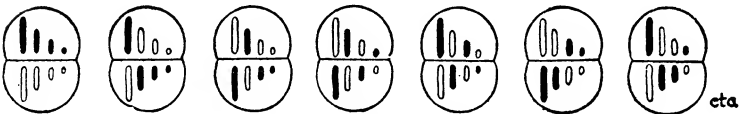

Fig. 175.—Diagram of Life Cycle in Animals

First row, the union of a sperm and egg-cell each with half the number of chromosomes giving the embryo or zygote with full number of chromosomes. Second row, the longest division of the chromosomes giving new body cells, each with the same number of chromosomes. Third row, the pairing of the chromosomes and their reduction to form gametes, again with half the chromosomes number. Bottom row, showing some of the combinations possible with four chromosomes pairs of different lengths, the chromosomes of each pair being heterozygous for certain genes representing characters (depicted by black or white blocks). Sixteen combinations are thus possible in the gametes, of which only two are shown, and 256 in the zygotes, of which only 7 are shown.

But the number of *chromosomes* in an animal (or plant) is invariably very much smaller than the number of *characters* or *characteristics* possessed by the organism. If then the chromosomes are the mechanism of transmission, each chromosome must, in some way, carry the determining factors of several characteristics, and all those present in any single chromosome will be transmitted as a group. This seems to be borne out by experimental evidence, and the characteristics forming such a group are described as *linked*. The separation of two units will be quite independent only when they lie in different chromosomes.

Each chromosome, then, seems to be a group of elementary units, and these units have been named *genes*. The chromosomes may be looked upon merely as convenient strings of genes.

It is an essential part of the Mendelian hypothesis that genes are arranged linearly. Let $a b c d e f g h$ be a row of genes in one chromosome, and let $A B C D E F G H$ be an analogous row in another. When the zygote is formed from the two gametes, homologous chromosomes seem to pair, so that the conjoined structure may be represented as shown in Fig. 176 (i). But *disjunction* always occurs in reducing division, and the two rows of genes come apart again, but before this occurs it may happen (and there is said to be evidence that it does happen) that the two mating chromosomes become partially twisted round each other (fig. 176, ii, iv). When they do disjoin, they may break at the point where they cross, so that the result will be as in figs. 176, iii and v. It will be seen that, as the result of such crossings over (and it is said that twisting may involve crossings at several different points), the number of possible reassortments of Mendelian characters may be greatly increased. The evidence, such as it is, for all this has been mainly derived from extensive *Drosophila* observation.

Genes are so extremely small as to be far beyond the reach of the microscope, though some workers claim to have detected some kind of linear dotted structure in the chromo-

somes. Hence the correlation which geneticists make between (1) events that occur in the nuclei of the germ cells, and (2) events that occur when organisms belonging to different races of the same species are crossed by sexual mating, is of an extremely hypothetical character. But *if the existence of genes be granted*, the complete Mendelian hypothesis of hereditary factors admittedly covers all the known facts. The genes are supposed to be the causal agencies in the

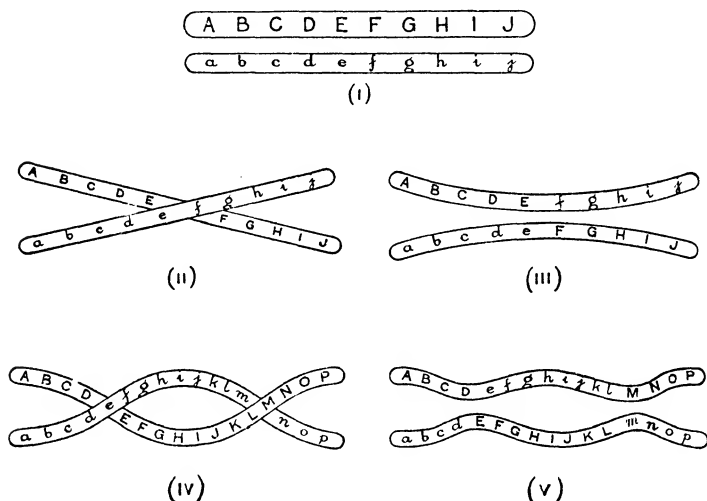

Fig. 176.—“ The junction and disjunction of chromosomes ”

development of the characters which are represented by small differences in the morphologies of the mating parents.

An enormous amount of observational work has been done in connexion with the fruit-fly *Drosophila*. Generation after generation of flies have been bred, and a careful watch made for mutations. When these occur (it may be in the eyes, or in the wings, or elsewhere, though they occur but seldom), skilful crossings are effected, and a new strain is built up. Observation is then directed to the points of intersection where the chromosomes seem to become attached

and detached (fig. 176). From a careful examination of these varying combinations and by a comparison of the characters selected from the controlled breedings, it has become possible to construct maps showing the actual positions of the genes on the chromosomes. It has been extremely laborious work, for it has necessitated the making of thousands of different controlled matings, and the rearing and examination of all the progenies. Such crossing-over experiments have also been carried out with other animals and with plants. Fig. 177 shows one such gene map, after T. H. Morgan. Not all biologists accept the maps.

Greatly simplified, the necessary observations and the subsequent reasoning is something of this kind. Amongst a large number of fruit-flies we find, say, three "sports" (mutants), in eye-colour, body-colour, and wing-length. We cross-breed for eye-colour and for body-colour, and we note that the chromosomes cross and then disjoin at the allelomorphous pairing points Dd and Mm (compare fig. 176 iv, v). Are the allelomorphous genes Dd or genes Mm representative of eye-colour? We are uncertain. We cross-breed again, this time for eye-colour and for wing-length, and note that the chromosomes cross and then disjoin at points Dd and Pp . Since Dd are the genes common to both experiments, we assume that gene D in the chromosome is the gene concerned with eye-colour. And since this eye-colour gene occupies just the same position in all experiments, we insert its position on the map.

In practice, it is nothing like so simple as this: the work is exceedingly difficult, and nearly all the evidence is inferential. The facts (so far as they are facts) constantly clash, and the evidence is full of uncertainty. There are, of course, no visible points corresponding to the letters, A, B, &c. We have to depend on shapes and relative lengths of chromosome parts and fragments.

It has been estimated that the diameter of a gene is one-tenth the diameter of the smallest particle we can see under the most powerful microscope. If we multiplied the diameter

by half a million, the diameter of the gene would be about half an inch.

In a paper read on 12th Sept., 1933, at a joint discussion of Section D (Zoology), I (Physiology), and K (Botany), at the Leicester meeting of the British Association, Professor **R. Ruggles Gates** dealt with "The General Nature of the Gene Concept". To append a few short quotations:

"The conception of the gene has resulted from two lines of biological evidence: (1) the amazing stability of the germ-plasm, as expressed in the facts of heredity; (2) its occasional instability, as shown by the occurrence of mutations. That external forces, such as X-rays, impinging on the germinal material should produce changes, is not surprising but inevitable. That the resulting effects are inherited, however, shows that the organism is incapable of regulating against changes in this particular part of its cell-structure."

"It appears that these phenomena of stability and inherited change can only be understood by recognizing that some substances or structures in the chromosomes must maintain in general their spatial relationships and chemical nature, not only from one generation of organizers to another, but also with only minor changes through thousands, and in some cases even millions, of years."

"The chromosome is a thread-shaped structure and is believed to be differentiated only along its length."

"Our actual knowledge of genes, apart from speculation, is derived entirely from their differential effects in development and from the phenomena of linkage and crossing-over. . . . The imagination of many genetical investigators has been caught by the idea of discreteness both in the gene and within the visible chromosome."

"The current view of genes tacitly assumes that all genes are of the same kind. . . . It seems more reasonable to suppose that a portion of an original chromosome, not necessarily of minimum size, underwent a mutation. Later, a portion of this would undergo a different change, and so on until a series of genes or chemically different segments of various

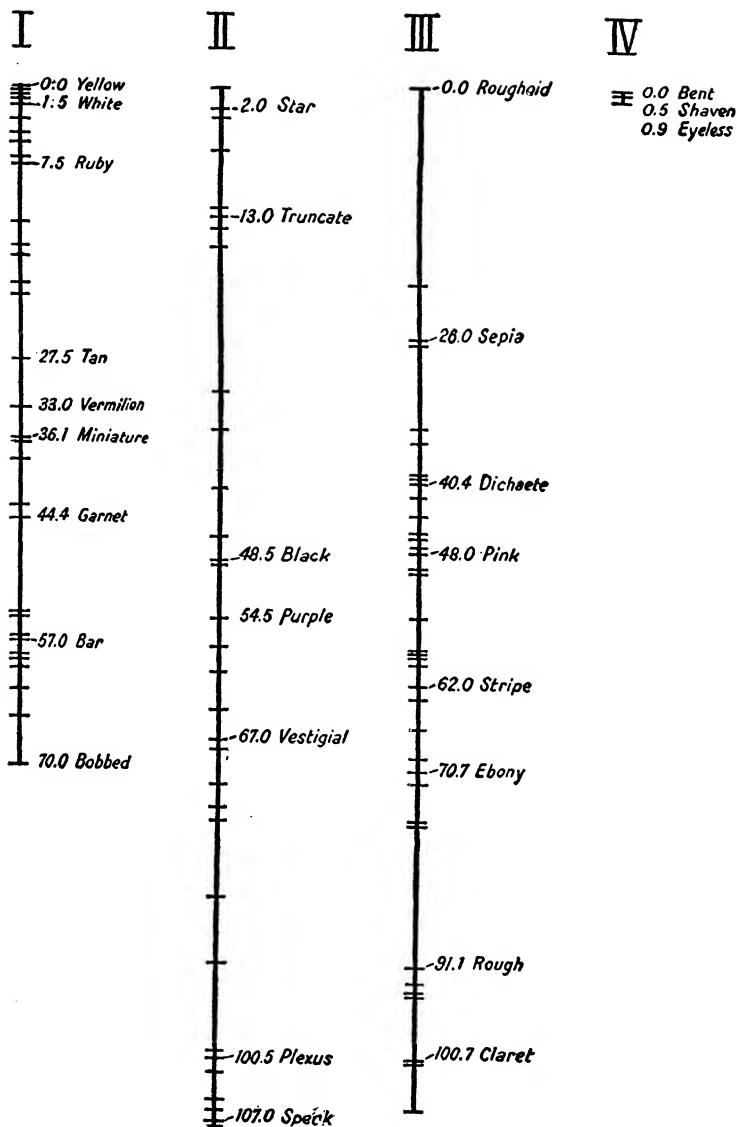

Fig. 177.—Map of the four kinds of Chromosomes

Drosophila melanogaster showing by cross-lines the position of a few of the genes in the different chromosomes, and the names of some of the more important ones

sizes would result. This would lead ultimately to some genes of minimum dimensions, although others might be larger."

"Some workers have taken an entirely different view of the origin and history of genes, regarding them as the primordial bodies from and by which protoplasm has since been constructed . . . The view of the genes as differentiated at a later stage of evolution within the originally homogeneous chromosomes seemed on the whole more probable."

"Various estimates of gene size have been made. One of the latest, by Gowen and Gay (1933) arrives at a minimum size of 10^{-18} c.c., the number of loci in the nucleus being estimated at more than 18,000. This minimum size would allow space for about 15 protein molecules. There is at present a large margin of error in such estimates."

"The idea that each gene is a single molecule, while avoiding the possibility of divisibility, appears to add difficulties of another kind. It is difficult to see why a tenuous chain of single unlike molecules should persist in the core of the chromosome, as it would be necessary to assume. Chemical forces alone could scarcely be expected to hold such a chain together."

"On the assumption that genes are indivisible in all circumstances, it has been necessary to make them smaller and smaller, until the limit is now reached in the single molecule. But surely if the atom itself can be disrupted by suitable forces, it is not unreasonable to suppose that something of a similar kind may happen to a group of molecules constituting a gene."

We come back to the question, *Do genes exist?* The answer is, *We do not know.* For the present we must look upon them merely as useful but entirely hypothetical discrete units.



Above, Silvery Gibbon.

Below, Orang-Outan



Above, Gorilla

Below, Chimpanzees

Photos by Mr. F. W. Bond, by courtesy of the Zoological Society

Some Disputed Questions

How was evolution brought about? By natural selection, as the Darwinians think? or by the inheritance of acquired characters, as the Lamarckians think? The two schools of thought are respectively represented by: (1) Professor **J. B. S. Haldane** and Professor **Hunt Morgan**; and (2) Professor **MacBride**, and Professor **Heslop Harrison**. With precisely the same objective facts to go upon, the rival schools have come to different conclusions.

An acquired character is one appearing as the result of the action of the environment, and persisting after the removal of the factors inducing it. Numerous experiments have been carried out in an endeavour to discover whether acquired characters are transmitted, and those of Professor Heslop Harrison have certainly produced very striking results, but many biologists are very doubtful if such experiments have extended through a large enough number of generations to justify the conclusions drawn from them. The main question is, are such acquisitions *permanent*? or would they be lost after a time, and would the animals revert to their previous forms?

Here is one of Professor Harrison's experiments, described in his own words: "By removing a number of individuals of a gall-making sawfly attached to the dusky sallow (*Salix Andersoniana*) to a locality in which only the Red Osier (*S. rubra*) was available, the species was compelled to adopt *S. rubra* as food, i.e. it had to acquire a new habit of laying its eggs on that plant. Later, when its original food plant was planted among the Red Osier bushes, the insect retained the instinct of laying on *S. rubra*, and rejected the *S. Andersoniana*; in other words the acquired habit had been inherited."

Professor J. B. S. Haldane disagreed with Professor Harrison's conclusion.

It should be observed that this is an entirely different

type of experiment from Mendelian experiments. The animal is subjected to a modified environment. There is no cross-breeding for the production of hybrids.

Another interesting experiment of Professor Harrison's is this. He had been struck by the coincidence between the distribution of black moths and industrial smoke. He knew, of course, that all green things in industrial districts are coated with a grime that is rich in poisonous metallic salts, and he thought that this might be the cause of the change from white to black in the moths. Accordingly he made the caterpillars of various moths eat tiny quantities of lead and manganese with their food. His suspicion was justified; in the metal-fed cultures a few mutants with black wings appeared. Moreover, the colour, once it had been produced, bred true, even without further metal feeding.—What inference are we to draw from the experiment? that a *permanent* change had been produced in the germ-plasm? that *entirely new genes* had appeared? How do we know that after a time there will not be a reversion to type? What *certainty* is there of a permanent change?

Analogous questions arise concerning domesticated animals. For instance, if the different varieties of pigeons were left entirely uncontrolled, would they, in their newly recovered wild state, all revert to the ancestral form from which all types of the domestic pigeons have been bred? Or if all dogs were freed from human control, ran wild, and interbred promiscuously, would there be any differentiated varieties left after, say, 1000 generations? Are the acquired characters of different varieties permanent, or only transitory?

If only transitory, how does it come about that there seem to be circumscribed limits between species?

In short, if we deny the transmissibility of acquired characters, it is exceedingly difficult to account for evolution.

The term *gene* was invented by the Danish botanist, **Johannsen**, who later publicly expressed his regret that he had ever done so, and defined mutations (or genes) as “superficial disturbances of the chromosomes”. Apparently,

therefore, we have to question the existence of the gene as a separate physical entity.

Professor **MacBride** refers to "the crude conception of the Morgan school as to the 'genes' being in the chromosomes", and he reminds us how Lamarck insisted that "the environment exercised no direct influence on the organism whatever; it caused, however, the animal to adopt new habits, and it was the exercise of these habits which modified structure." "To the invocation of 'mutations' as explanations of radical differences, we are fundamentally opposed, because this method of dealing with difficulties seems to us mere indolence of thought." "All the mutations that I am acquainted with are weaklings as compared with the typical wild animal; they owe their origin to definite injuries to the germ-plasm, and the idea that they could be 'naturally selected' is untenable." "Evolution has been brought about by slow changes of habit in response to a slowly changing environment."

Some years ago the term "sport" was in common use to denote an animal or plant or any part of one that varied suddenly or singularly from the normal type. A man 6 feet 6 inches in height, in a family all of average size would be called a sport. A sport was looked upon as a variation of apparently spontaneous origin. Usually the difference from type was slight, but definitely marked, and its tendency was to disappear with the animal in which it arose, though it was observed that sports sometimes repeated themselves and could be preserved by careful selection. If perpetual, sports become a breed, a strain, or a variety. Sports are common amongst domesticated animals and cultivated plants, but they have been mostly developed by crossing, and have been encouraged by human control though, of course, they always live under unnatural conditions. Sports were often described as "saltatory" variations (Lat. *salto*, leap), and they are now commonly called "mutations". A pronounced "leap" from type often seems to result in

a diminution of vital energy and therefore of resistance. Consequently it is not easy to feel confident that mutations may lead to new forms which are capable of survival under conditions of wild life.

The neo-Darwinians maintain that it is owing to these mutations that *new genes* from time to time arise. From a genetical analysis of "intraspecific differences" Professor Haldane finds it is "quite certain that Mendelian gene differences, presumably due to mutation, have played a certain part in the origin of species." "One important point is that mutation is a sudden process. A single gene alters, and the alteration takes place at once, and not by successive steps." "The majority of new genes are recessive to the wild type, but some at least are dominant." "In *Drosophila melanogaster* (1925), when about 15,000,000 individuals had been bred from known parents, the principal gene determining eye-colour had been observed to mutate twenty-five times, no other gene having mutated so often." "Gregory, de Winton, and Bateson have grown over 200,000 *Primula sinensis* under close observation. No mutation has occurred more than once, so far as is known, though about one visible mutation of one kind or another occurs in 20,000 plants." Professor Haldane states that the *rate* of mutation can be enormously increased by X-rays (Muller), by β -rays from radium, or by so heating the eggs of *Drosophila* as to kill most of them (Goldschmidt).

The main causes of variation *within a species* are due, then, in the opinion of Professor Haldane, to Mendelian inheritance closely associated with the formation of new genes due to mutation. "The amount of variation can in general only be altered by selection on the one hand, and changes in the system of mating on the other."

Haldane's reasoning is unexceptionable, and if the experimental evidence may be accepted, a good case seems to be made out for Mendelian inheritance being the cause of intraspecific (i.e. intervarietal) variations.* When Haldane

* N.B.—Lat. *inter* = between; *intra* = within.

comes to interspecific variations (i.e. variation between species and species) he is hardly so convincing. He brings forward the well-known fact that there is a very simple relationship between the chromosome numbers in groups of closely related species, e.g. 9, 18, 27, 36, 45, all multiples of 9, in nineteen species of the genus *Chrysanthemum*. So in *Rosa* there are multiples of 7, in *Prunus* of 8, in *Salix* of 19. "Clearly the process of species formation in these cases must have been sudden." Haldane concludes that interspecific differences are of the same nature as intervarietal. Any circumscribed boundary line to a species is thus entirely artificial. Intervarietal differences are generally due to a few genes with relatively large effects; interspecific differences are generally due to differences involving whole chromosomes or at any rate large parts of them. "The number of genes involved is often great, and cytologically observable differences common. It is largely these latter which are the causes of interspecific sterility."

If whole chromosomes can be transformed at one fell swoop, if a whole series of linked characters can all take a flying leap together, assuredly we have a complete and simple explanation of evolution, and all opposition to it must yield. But can natural selection bring about such sudden changes? If so, we need no longer shrink from explaining how, e.g. a vertebrate evolves from an arthropod.*

Opinions differ strongly concerning genes. Some eminent authorities deny their objective existence altogether. Certainly the evidence for their existence is largely inferential; in my opinion entirely so. If they do exist, they serve to explain the facts of *heredity* admirably. But of *evolution*?

How are we to account for the fundamental difference of opinion between two such eminent men as Professor MacBride and Professor Haldane? They are both familiar with all the ascertained facts, and they are both quite capable of weighing up the facts and reasoning from them with logical rigour. Why then such different conclusions?—in

* Do not confuse *arthro-* and *anthro-*.

the one case that evolution has been brought about by the inheritance of acquired characters, in the other, by gene-transformation due to natural selection? Professor MacBride is eminent as a zoologist and embryologist, Professor Haldane as a physiologist, bio-chemist, mathematician, and geneticist. Does not every man's own knowledge and personal experience unconsciously cause him to attach greater weight to classes of facts that seem best to square with that knowledge and experience, and less weight to facts which seem to be in opposition? Is not human nature built this way?

But how do species originate? *We do not know.* The secret yet remains to be discovered. How can we ever experiment adequately? If we could experiment on an existing species for 100,000 generations, we might produce a new species and in the doing of it discover exactly how nature has worked in the past. What is the use of pretending that we know already?

Although, however, we do not yet know how evolution works, we may feel, quite consistently with the opposed opinions of experts, a confidence, which really does not brook questioning, that some form of evolution contains the truth.

BOOKS OF REFERENCE:

1. *Evolution in the Light of Modern Knowledge*, Jeans, Bower, MacBride, Jeffreys, Soddy, &c. A work of great weight.
2. *Darwin and Modern Science*. Another authoritative joint work.
3. *Evolution*, E. W. MacBride (a lucidly written little book of 80 pages).
4. *The Causes of Evolution*, J. B. S. Haldane.
5. *Mechanism of Creative Evolution*, C. C. Hurst.
6. *Scientific Basis of Evolution*, T. H. Morgan.
7. *Difficulties of Evolutionary Theory*, D. Dewar.
8. *Extinct Plants and Problems of Evolution*, D. H. Scott.
9. *Evolution* (book for beginners), J. Graham Kerr.
10. *The History of Creation*, E. Haeckel.

11. *The Science of Life*, Wells,* Huxley, and Wells.
12. *The Stream of Life*, Julian S. Huxley.
13. *Mechanism of Life*, J. Johnstone.
14. *The Inheritance of Acquired Characters*, P. Kammerer.
15. *Zoological Philosophy* (Trs. H. Elliott), J. B. Lamarck.
16. *The Germ Plasm*, A. Weismann.
17. *The Mutation Theory* (Trs. J. B. Farmer), H. de Vries.
18. *The Science and Philosophy of the Organism*, H. Driesch.
19. *Heredity*, F. A. E. Crew (another lucid account, in 80 pages).
20. *Heredity and Eugenics*, R. R. Gates.
21. *Genetics and Eugenics*, W. E. Castle.
22. *Mendelism*, R. C. Punnett.
23. *Animal Genetics*, F. A. E. Crew.
24. *Animal Biology*, Haldane and Huxley.
25. *Essentials of Biology*, J. Johnstone.
26. *Evolution of the Mind*, G. Elliot Smith (Royal Institution discourse, 19th Jan., 1934).—See Supplement to *Nature*, 17th Feb., 1934.

* The present generation may not know that Mr. H. G. Wells is a highly trained zoologist. I have seen a good many skilful zoologists at work, but never one more certain and expeditious than Mr. Wells. At one time his skill with the scalpel was admired as much as his skill now is with the pen. It has been said more than once that Mr. Wells would have made a great surgeon.

CHAPTER XLVI

Anthropology and Archæology

Anthropology is that branch of science which is concerned with *man* (Gk. ἄνθρωπος, man), and includes, among other things, the special study of man's agreement with and divergence from other animals. It concerns itself particularly with *fossil* man, and therefore has some claim to be included as a branch of geology as well as of biology. Archæology (Gk. ἀρχαῖος, ancient) takes cognizance of past civilizations and investigates their history in all fields, by means of the remains of art, architecture, monuments, inscriptions, literature, language, implements, customs, and survivals of all kinds. Archæology is therefore conveniently regarded as a branch of anthropology.

That "Order" of mammals which includes man, the apes, the monkeys, the tarsiers, and the lemurs, is known as the **Primates** (Lat. *primus*, first), a term coined by Linnæus to connote the "first" position on the animal family tree. The second group of Primates, the *apes*, is distinguished from the third, fourth, and fifth groups by its far closer resemblance to man, a resemblance recognized in the name "anthropoid" (man-like) commonly given to them. The anthropoids include the *Gibbon*, and the *Orang* from S.E. Asia, and the *Chimpanzee* and the *Gorilla* from tropical Africa. The Gibbon is much smaller than the others and is sometimes put into a separate family.

Man himself is characterized by the complete withdrawal of the fore limbs from the office of locomotion, and conse-

quently by an habitually erect attitude, except in infancy; by the perfection of the hand as a prehensile organ, and the specialization of the foot as an organ of locomotion; by the regular curvature of the line of the teeth which are of the same length and in uninterrupted series; by the nakedness of most of the body; and by the large facial angle.

An hour or two spent round the cages of the chimpanzee, the gorilla, and the orang-utan at the Zoological Gardens will do more than the reading of a dozen books to bring about conviction that there is some sort of real cousinship between the anthropoids and ourselves. Watch the mothers feeding their babies at the breast, dandling them, stroking them, apparently even kissing them. In particular, watch the very friendly chimpanzee, and note some of the main structural bodily resemblances to, and the differences from, those of man. The differences are nearly all of *degree*, not of kind. Man has short arms and long legs, the anthropoids long arms and short legs, but bone for bone throughout the body, the strong resemblances are really startling. Look carefully at the four skeletons in fig. 178. Better still, examine the actual skeletons in the Natural History Museum at South Kensington. Compare the thumbs, and compare the great toes; compare the jaws; compare the curvatures of the spines; compare the capacities of the skulls. In the photographs of the anthropoids, Plates 42 and 43, (if possible, in the live animals themselves) compare the hands and the feet, the noses, the ears, the foreheads, the set of the eyes. There are differences everywhere, but the remarkable resemblances cannot but impress even the casual observer. Note the absence of a tail. Note the presence of finger-nails and toe-nails instead of claws. In all cases the females, like women, have but a single pair of breasts (like women they also have menstrual periods).

The chimpanzee is most like man in his skull, in his weight, and in his limb proportions; the gorilla, in his hands, feet, and pelvis, and in size of brain; the orang-utan, in the possession of the same number of pairs of ribs and in his

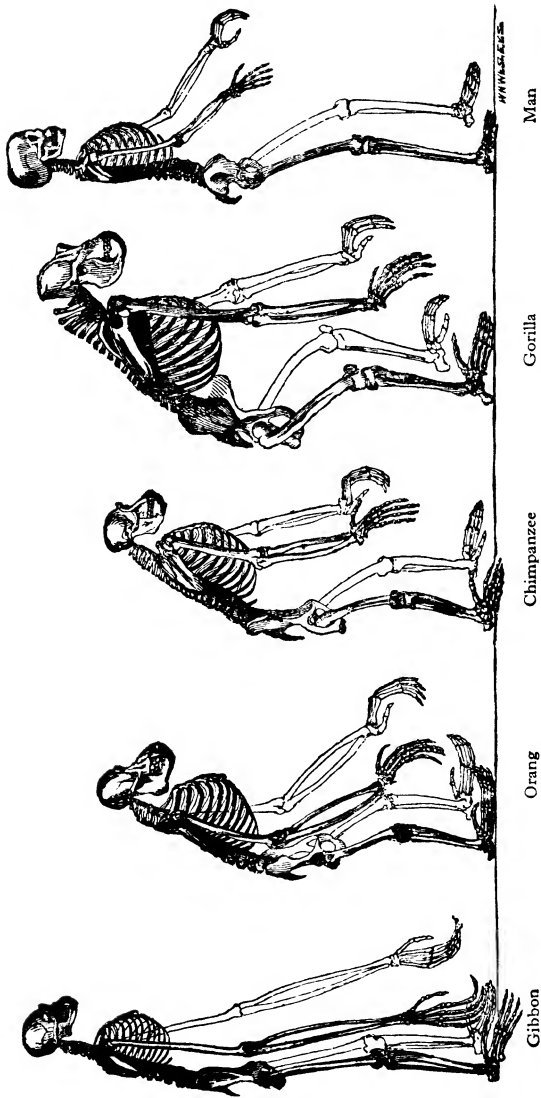

Fig. 178.—Comparative skeletons of man, apes, &c.
Drawn from specimens in the museum of the Royal College of Surgeons

high forehead. The gorilla has enormous jaws. The African apes (gorilla and chimpanzee) possess air sinuses in their frontal bones, like those of men. The gorilla has cartilaginous plates supporting the openings of the nostrils, and the form of his external ear is wonderfully like man's. Both the gorilla and the chimpanzee sometimes have a *peroneus tertius* muscle, which until recently was assumed to be the one muscular distinction of man. The sole of the mountain gorilla's foot is extraordinarily like that of the human foot, and the likeness is not only superficial; dissections show that there is actual structural agreement, muscle for muscle and bone for bone. Sir Arthur Keith, in an analysis of man's anatomical relations to other Primates has found that man shares 98 characters with the chimpanzee, 87 with the gorilla, 56 with the orang, and 84 with the gibbon. Thus in gross anatomical characters man seems to be nearest the chimpanzee. On pp. 40, 41 of his book, Professor Hooton gives a comparative summary of resemblances and differences in about 40 characters. The reader is urged to pay special attention to these resemblances and differences, and then weigh carefully the evidence, pro and con, of our supposed kinship to the anthropoids. The evidence seems to be irresistible.

But there is also striking evidence of other kinds. For instance, the process by which the placenta is formed, for establishing a means of supplying the unborn child with nourishment while in the womb, is exactly the same in the chimpanzee, gorilla, orang, and gibbon as in woman, and this applies to no other animal. And in all the embryos, that of man included, an external jointed tail is produced in the fifth week of development, but by the end of the eighth week it has shrivelled and become submerged. Then, again, blood reactions of the anthropoids are almost identical with those of man. Further, anthropoids are susceptible to many human diseases. In short, the evidence supplied by vital tests bears out the conclusions forced on anatomists by similarity of structure, namely, that the great anthropoid apes, in an evolutionary sense, are closely akin to man.

Fossil Remains of Man

Anthropologists are still not without hope that they may sometime discover the remains of a form of animal which may reasonably be supposed to represent the *common ancestor* of man and the anthropoids. At various times, human or semi-human remains have been discovered which bear an ape-like appearance. The discoveries have given rise to much discussion amongst anthropologists, for, as a rule, the fossil remains have been so fragmentary and incomplete that unanimity of opinion concerning them has hardly been possible. Sir **Arthur Keith** (*b.* 1866), for many years Hunterian Professor at the Royal College of Surgeons, has long been recognized as the chief authority on the whole subject of anthropology, and his lead is generally followed both in Europe and in America.

We will give a few details of the chief fossil forms so far discovered.

1. **Pithecanthropus Erectus** (Gk. *πίθηκος*, ape, *ἄνθρωπος*, man), commonly called the ape-man of Java. The remains were discovered in 1891-2 by Professor **Eugène Dubois**, then a surgeon in the colonial military service and later Professor of Geology in the University of Amsterdam. The remains consisted of five fragments, viz. a skull-cap, a left thigh bone, and three teeth; a sixth fragment was afterwards found some distance away, viz. part of a lower jaw showing the rudiment of a chin. Dubois regarded the fragments as belonging to a transitional form between an ape and a man: hence the name "ape-man". The skull-cap was flat and low and showed great eye-brow ridges, and its characters were more simian than human, but a cast of the interior showed a convoluntary brain-pattern that was distinctly human. But the brain must have been smaller and much simpler than of the most primitive man now living; its estimated volume was 900 c.c. as compared with 600 c.c. of a large gorilla and a minimum of 1000 c.c. for the lowest-brained of existing human beings. The jaw showed a socket

of a canine tooth, but a human tooth, not anthropoid. The owner had probably lived either in the later Pliocene period or in the early Pleistocene, i.e. several hundreds of thousands of years ago. It may have been an archaic survival into later Pliocene times of an early human form belonging to a Miocene stage of evolution. We may look upon it as a being *approaching the threshold* of humanity.

2. **Eoanthropus** (Gk. *ἠώς*, dawn), sometimes referred to as the "dawn-man". (Actually, however, the fossil remains were those of a woman.) The remains were discovered by Mr. **Charles Dawson**, a well-known solicitor and amateur anthropologist, at Piltdown, Sussex, in the years 1911-15. The remains consisted of the greater part of the left half of a deeply mineralized human skull and part of the right half, the right half of the lower jaw carrying, in the region beneath the chin, the bar of bone known as the "simian shelf"; and an upper canine tooth. Fragments of other skulls of the same kind were found in neighbouring fields, and helped in effecting a reconstruction. There was also found a remarkable bone implement, hewn from the thigh bone of an extinct kind of elephant. The stratum of gravel where the remains were found belonged to the early Pleistocene period. From the fossil remains thus found, Sir **Arthur Smith Woodward** (b. 1864) reconstructed an extinct genus of mankind, sometimes called Piltdown man.

A cast of the interior of the skull showed that the brain had been not only human in all its characters but many stages beyond *Pithecanthropus*. The bone implement showed evidence of manual skill and inventive ability. In fact, the Piltdown discovery showed fairly conclusively that at about the beginning of the Pleistocene period a race of beings had come by a brain that had almost reached human estate, but that this race still retained certain definite simian characteristics in its jaws, teeth, and face.

3. **Neanderthal man**. As far back as 1857, some workmen found in the Neanderthal cave near Dusseldorf in Germany the vault of a fossilized skull and the limb-bones of a man

which proved to be, in the light of further discoveries, a representative of a distinct species of man, *Homo neanderthalensis*. A fossil skull of the same type had been dug up at Gibraltar nine years before. In 1926, Miss Dorothy Garrod, while excavating the floor of a recently discovered cave at Gibraltar, unearthed the greater part of the skull of a Neanderthal child, aged about five years. The stratum in which it was embedded contained flint implements worked in the Mousterian style (see fig. 180). The skull is as capacious as that of a modern child of the same age. Other fossil remains of the same species have been found at Spy in Belgium, but it is the Dordogne valley of France which has proved to be the richest source of Neanderthal remains. The evidence found at Le Moustier and numerous neighbouring places makes it quite clear that Neanderthal man, marked as he was by many simian traits of body, buried his dead with signs of respect. He worked flint implements with great skill, in the style or culture known as Mousterian. He was a hunter, and he lived in caves and rock shelters. His culture has been found in England, but no trace of his body. Only once have the fossil remains of Neanderthal man been found outside the limits of Europe, in a cave on the western shores of the Sea of Galilee (1925).

Neanderthal man seems to have been the sole occupant of Europe during the middle of the Pleistocene period, i.e. throughout the time in which the Mousterian culture prevailed. Remains of Neanderthal man of a rather more primitive type have been discovered at Taubach and Ehringsdorf near Weimar in Germany. In 1907 a human mandible was found at Mauer near Heidelberg, in a stratum of the older Pleistocene, and represents a race which lived long before the men who practised the Mousterian culture, but we may quite safely regard the Heidelberg man, as he is called, as an ancestral representative of the Neanderthal species. Further fragments of Heidelberg man discovered in 1927 are even more anthropoid in character than those of Neanderthal man.

At one time it was believed that Neanderthal man represented an ancestral phase of modern man. But archaeological evidence is now complete that he was replaced in Europe by the arrival of men of the modern kind, represented by people of the Cro-Magnon type. Nevertheless modern man and Neanderthal man must have had a common ancestry.

4. **Rhodesian man.** In 1921, fossil remains were discovered in the Broken Hill mine, Northern Rhodesia. They were the remains of a man who was probably alive in Africa when Neanderthal man dominated Europe. He is perhaps an ancestral type of modern man.

5. **Cro-Magnon man.** This is a fully developed man of modern type who appeared in Europe after the disappearance of Neanderthal man. Whence did modern Europeans appear, and what was their lineage? With his present general appearance we are all familiar, but controversy still rages concerning his precise ancestral line.

Brief reference must also be made to the recent work of Dr. **L. S. B. Leakey** in East Africa. In the spring of 1932, Dr. Leakey conducted an archaeological expedition in Kenya, and found at two sites only two miles apart (i) at Kanjera, a series of skull fragments of human beings who lived during the Middle Pleistocene period coincident with the withdrawal of the first great ice-cap from Europe; and (ii) at Kanam, a fragment of jaw, complete with several teeth, belonging to a man who lived during the still earlier ages which formed part of the Lower Pleistocene or even the Pliocene period.

At a meeting convened at the Anthropological Institute in October, 1933, Dr. Leakey announced that, as the result of a careful examination and comparison with other known skulls, both fossil and modern, and more particularly in view of the results of an X-ray examination of the roots of the molars and pre-molars of the Kanam jaw, he had come to the definite conclusion that both Kanjera man and his pre-

decessor Kanam man formed part of our own genus. He regarded the Kanjera skulls as specimens of true primitive *Homo sapiens*, and antedating by some tens of thousands of years the earliest authenticated remains of modern man from any other site. But the Kanam jaw was of vastly greater antiquity, and although in many characters it does not differ from that of primitive *Homo sapiens*, Dr. Leakey considered that it should be separated from the species *Homo sapiens* and rank as a new species of the genus *Homo*, for which he proposed the name of *Homo kanamensis*.

The reader may be referred to Sir Arthur Keith's *New Discoveries relating to the Antiquity of Man*, more especially to the chapters on The Taungs Skull (Australopithecus), The Galilee Skull, The Neanderthal Child (Miss Garrod's discovery is of rare interest), The Peking Man (*Sinanthropus* from the early Pleistocene, contemporary with the Piltown type, and a probable ancestor of modern man), and The London Skull. The whole book is notable for the scrupulous impartiality shown in the weighing of the evidence. Fig. 179 shows Sir A. Keith's "diagrammatic synopsis of human evolution".

The controversial nature of a good deal of the evidence derived from fossil man will best be gauged by reading the books of several recognized authorities, e.g. Sir **Arthur Keith**; Professor **G. Elliot Smith**, "an anatomist of the highest standing"; Professor **E. A. Hooton**; Professor **J. Reid Moir**; Professor **Fairfield Osborn**; Professor **W. K. Gregory**; Professor **A. Smith Woodward**; Professor **Davidson Black** (on the Peking Skull); and Professor **A. C. Haddon**. Amongst other front-rank workers the names of Miss **Dorothy Garrod**, Mr. **F. Turville-Petre**; Dr. **J. G. Anderson** (a Swedish geologist attached to the Geological Survey of China); and the young French priest, Father **Teilhard de Chardin**.

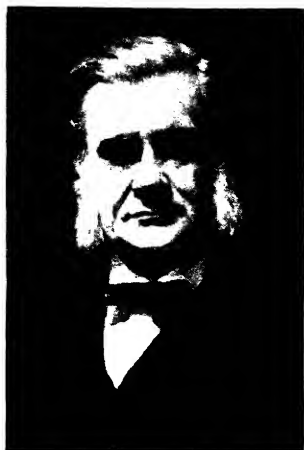

T. H. HUXLEY
*From Portrait by Hon. John Collier
in the National Portrait Gallery*



MISS DOROTHY GARROD
Photo. Lafayette



LOUIS PASTEUR
From a painting by R. Lehmann



PROFESSOR KOCH

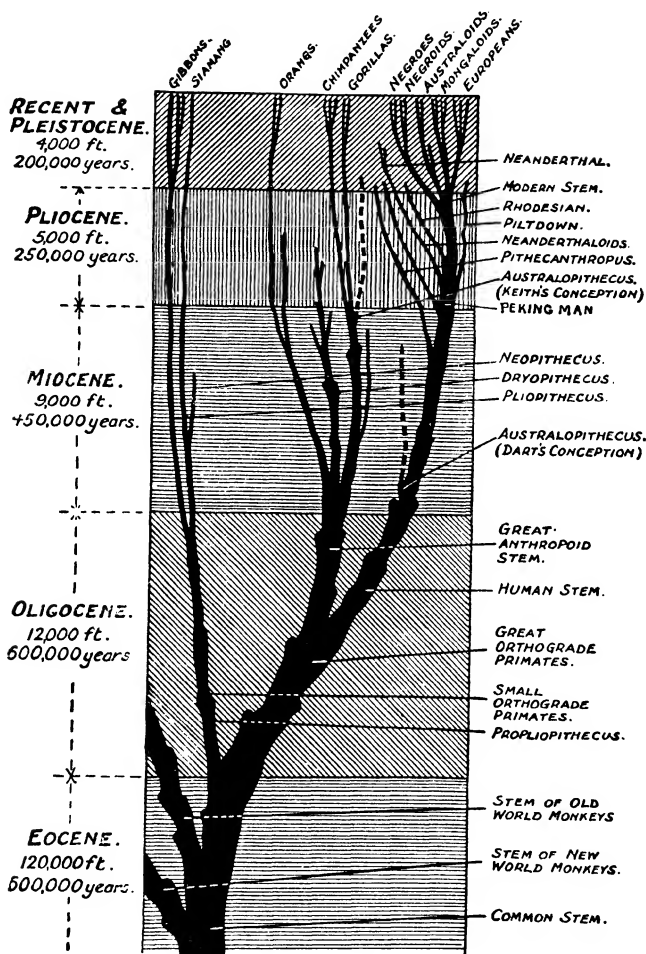

Fig. 179.—Diagrammatic Synopsis of Human Evolution

An evolutionary tree of man and ape is represented against a background of geological time. The separation of human and anthropoid stems is represented as having taken place in the oligocene period, while the breaking up of the human stem to form species and races—known to us by fossil remains—is depicted as having occurred in the pliocene and early pleistocene periods.

The divergence of the human stem towards the right is intended to indicate a steady man-ward movement.

Professor J. H. McGregor's Restorations

In the "Hall of the Age of Man", in the American Museum of Natural History, New York, are to be seen a remarkable series of portrait busts modelled from skulls of prehistoric races of man. These have been prepared by Professor **J. H. McGregor**, Professor of Zoology, Columbia University, and Research Associate in Human Anatomy, American Museum of Natural History. Professor McGregor's reputation as a zoologist and anatomist is world wide, and his knowledge of minute detail of bone and muscle in animals and man has rarely been equalled. By Professor McGregor's courtesy, we are able to show photographs of four of these busts (1) *Pithecanthropus* (the ape man); (2) *Eoanthropus* (the Dawn man of Piltdown); (3) Neanderthal man; (4) Cro-Magnon man, Plate 45. The photographs should be very carefully compared with one another: the gradual advance in humanity is unmistakable. They should also be compared with those of the great apes in Plates 42 and 43; the relationship thrusts itself upon us, even if we feel some natural prejudice against it.

Owing to the further kindness of Professor McGregor we are able to give a few details of the process he employed for constructing the busts.* The particular example described is Neanderthal man. The portrait is not, of course, that of an *individual*; rather it is a *racial* portrait, or type model. Naturally such racial portraits are all that can be attained in reconstructing the soft tissues on skulls of extinct races, where the bones are the only data. In the reconstruction of Neanderthal man, Professor McGregor had this great advantage—that there were several examples of known skulls, though the skull mainly used was that of the man of La Chapelle-aux-Saints, the finest of the race discovered at the time, in the department of Corrèze in France.

* Full details will be found in *Natural History*, Vol. XXVI, No. 3, 1926, pp. 288-293.

The skull, which was broken into a number of fragments, was admirably reconstructed by Professor Marcellin Boule of Paris, and it was so nearly complete that restoration of the missing parts was not difficult. The teeth were modelled from numerous casts and photographs of other Neanderthal remains, and when the post-mortem distortion of the lower jaw had been remedied, the lower teeth were modelled to conform to the upper, casts and photographs of other Neanderthal teeth and skulls again being used.

The fleshy parts of the head were modelled in plastic material on the restored skull. The skull was first fixed in position on the so-called Frankfort horizontal or "eye-ear plane", so that a plane passing through the lower margin of the orbits and the upper margin of the auditory meatus would be horizontal. This plan poses the head in a natural position, and a correct comparison of slope of forehead, chin, etc. in different models is greatly facilitated. The building up, in plastic material, of the muscles and ligaments of the neck was evidently a very laborious process, and naturally the nose, eyes, and ears were features requiring meticulous attention. The width of the nasal aperture and that of the external nose; the normal-sized eye-balls but the exceptionally capacious orbits, the eyelids, the wide interpupillary distance; the relations of the external ear to the bony meatus in the skull; the lips, not thick and everted as in the negro; the local depths of the flesh over the different parts of the skull; these and scores of other details were worked out with the most scrupulous care, and checked and counter-checked with every scrap of evidence available. The four figures on Plate 45 will make clear the whole process of reconstruction. Professor McGregor's guide throughout was ascertained anatomical *fact*, and it is for this reason that his work has won the approval of the best-known experts all over the world.

Archæology

In his British Association Address, 1932, Dr. **D. Randall-MacIver** reminded us that archæology, as a branch of science, is less than a century old. **Layard** was excavating at Nineveh in 1845; **Boucher de Perthes** published his first work on stone implements in 1841; **Keller's** work on lake-dwellings appeared in 1854. **Schliemann's** excavations at Troy began in 1870.

Anthropology is wider than archæology, for it treats not only of man's material works but also of his mental, moral, and sociological development. Anthropology studies primitive man wherever and whenever he is found, and primitive man not only existed hundreds of thousands of years ago, he exists now. The principal subject of archæology is the *material output* of man, the facts concerning which it sets itself out to discover. For the interpretation of the inner meaning of man's life, we have to depend mainly either on anthropology or on history. Documentary history is, however, very limited in its range, and of the life of ancient times it gives only a few glimpses, though it performs the valuable function of providing a time-scale which cannot be obtained from any other source. This time-scale covers but a few thousand years, the merest fraction of the time covered by archæology, which goes right back to the Tertiary period in geology.

Archæology is commonly supposed to be less trustworthy than history. But is this true? Consider the very simple case of two independent eye-witnesses giving evidence in a law-court: how often are their accounts really consistent? How many historians of the past have confined themselves to recording objective facts, wholly free from personal bias and from a propagandist character, whether of politics, religion, or what not? "Herodotus writes an epic, and Thucydides composes a tragedy; Gibbon displays a pageant, and Macaulay delivers an oration." Our admiration for these historians is due to our recognition of them as great

artists, not as men of science. Twentieth century historians are, however, infinitely more careful.

The archæologist is above all things an explorer and a digger, and such work is well exemplified in the recent excavations in Egypt, Mesopotamia, Greece and India. The archæologist hopes to discover treasures that have been deliberately hidden in tombs and treasuries, or accidentally hidden by the accumulation of sand and soil over the deserted ruins of ancient buildings. He seems to have a nose for all "recent" geological accumulations, and with pick and spade often hits on a valuable find. Chipped flints, spear heads, ancient ornaments, pottery, and scores of other things rescued from ancient days, quickly tell him something of their story. He finds his way into caves and discovers pictures painted scores of thousands of years ago. By chance he hits upon a specimen of fossil man, and then his satisfaction is great indeed. The books and the work of the great pioneers he knows by heart: Sir Edward Tylor, Sir John Evans, and Lord Avebury, and others of a generation or two ago; and Sir Flinders Petrie (*b.* 1853), Sir Arthur Evans (*b.* 1851), and many another leader of distinction of the present day.

The kind of task the archæologist has to face largely depends on the terrain he chooses. When, as in prehistoric Europe and America, there are no ancient languages to be known, the work is naturally much lightened. But workers in Minoan Greece or in Italy must be sound classical scholars, or they could make no headway. In Egypt and Mesopotamia, the scholarly archæologist must know a great deal about complicated and difficult scripts of various types and in various languages. In the field, every archæologist has to be a resourceful man. He has to know something about elementary engineering, and about photography; he must have an eye for diagnosing his terrain; he must know how to manage men, especially Orientals. A classical example of archæological method was the digging out and rebuilding of the grand staircase, corridors, and halls, on the east slope of the palace hill at Cnossus by Sir Arthur Evans. The building, three or four storeys high,

when dug out was found to have collapsed, though its original planning and construction were still recognizable. It was re-erected exactly on its original lines. The charred beams were carefully replaced by iron girders, and its calcined pillars were replaced by new copies.

The only topic of archæology for which we can afford space are the Cultures of the Stone Age: those are closely associated with prehistoric man.

Stone Age Cultures

The term "Stone Age" hardly fixes a chronological epoch in world history; rather it denotes the condition of a people prior to the working of metal. The material from which cutting implements and weapons were made was *stone*. In his appreciation and use of the materials by which early man found himself surrounded, there would naturally be differences of degree, and some of the peoples of the stone age were greatly in advance of some of their contemporaries. Even now there are people to be found in the world who have barely emerged from the Stone Age. The Australian aboriginal is an example.

The Stone Age is divided into two quite distinct parts, (1) *Palæolithic* (Gk. *παλαιός*, ancient, *λίθος*, stone); (2) *Neolithic* (Gk. *νέος*, new). Between the two there was a long stretch of time, the *Mesolithic* age, about which we know very little, but during that time we do know that a tremendous advance was made. Palæolithic man was a primitive man indeed; Neolithic man was really "getting on".

The term *culture* so frequently used in connexion with the Stone Age connotes the sum of the activities of a people as shown by their industries and other discoverable characteristics. The name *artefact* is given to any object fashioned by ancient man, whether in stone, bone, horn, or what not. Excavation and typological study have shown that the Palæolithic period can be subdivided into a chronological sequence

of cultures which show clearly the succession of phases through which early man passed. This sequence has been obtained mainly by studying the stratigraphy found in a large number of cave and rock shelter habitations. The cultures naturally do not occur universally. The best-known sequence is that found in Western Europe, especially in France.

The last great geological "era" is known as the Tertiary or Cainozoic, and extends backwards for about 60 million years. It is divided into four definite "periods," viz. the Eocene (the lowest stratigraphically and the oldest), the Oligocene, the Miocene, and the Pliocene.* At the very top of all these Tertiary deposits are deposits extending in time over less than a single million years. Sometimes this is referred to as the Post-Tertiary "era", including the Pleistocene and Recent "periods". Mammals are found throughout the whole of the Tertiary (Cainozoic) era; man is essentially a product of the Pleistocene period, though there is little doubt that he began to emerge towards the end of the Tertiary era, in the Pliocene period if not in the Miocene.

The divisions of the "Pleistocene and Recent" period are roughly chronologically arranged in figure 180. The thin strip at the top indicates the Iron and Bronze Ages. The second part of each of the four compound words in the last column is the really significant term; the first part is merely descriptive.

The six Palæolithic cultures may, as shown in the figure, be classified thus:

- | | | |
|----------------|---|---------------------|
| 1. Magdalenian | } | Upper Palæolithic. |
| 2. Solutrean | | |
| 3. Aurignacian | | |
| 4. Mousterian | } | Middle Palæolithic. |
| 5. Acheulean | | |
| 6. Chellean | } | Lower Palæolithic. |

* Cainozoic, Gk. *καινός*, new, recent; *ζωή*, life; Pliocene, Gk. *πλείων*, more, and *καινός*; Pleistocene, Gk. *πλείστος*, most; Miocene, Gk. *μείων*, less; Oligocene, Gk. *ὀλίγος*, little.

The names of 1, 2, and 4 are derived from the names of rock-shelters, of 3 from the name of a cave, and of 5 and 6 from the names of the sites of gravel pits, all in France. (The

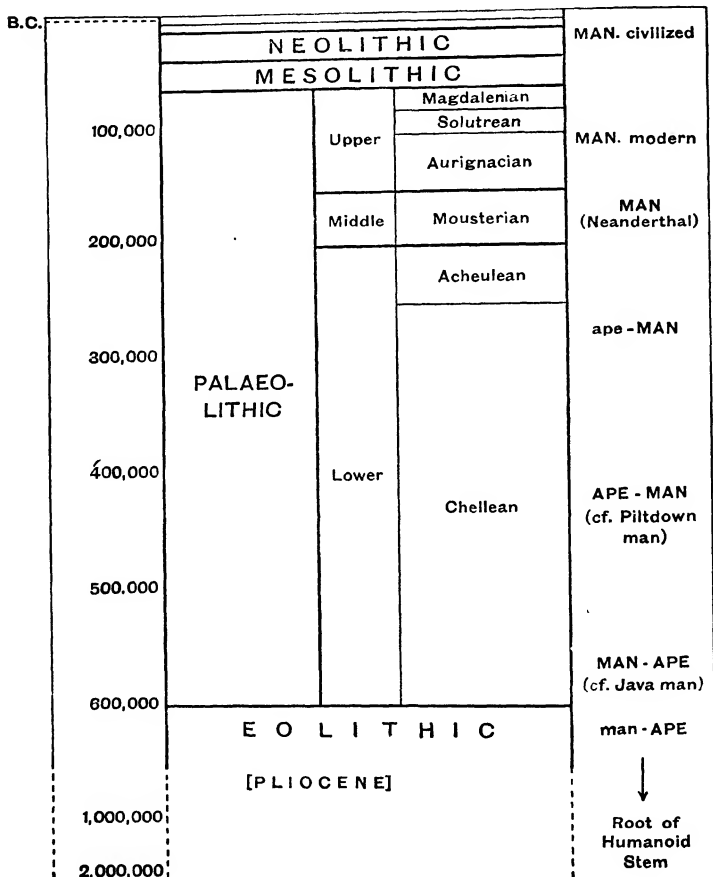

Fig. 180

original French spellings, *Magdalénien*, &c., have here been anglicized).

The climatic conditions of Pleistocene times must have had a profound influence on the development of early man.



Pithecanthropus Erectus modelled on McGregor's restoration (1917) of the skull



Neanderthal Man modelled on (restored) skull from La Chapelle-aux-Saints



Eoanthropus dawsoni modelled on McGregor's restoration of the skull.



Cro-Magnon Man modelled on Skull from Les Gyzies.

From photographs by J. D. McGregor, Columbia University, New York

Towards the end of the Tertiary era, the circumpolar ice extended towards the equator, and a glacial period set in. It was not a single great wave of cold; there was a succession of glacial maxima with long interglacial periods of warmth. The actual number of glacial maxima is a little doubtful. Commonly, three are named after little rivers in the Alps.* The difficulties of this problem of ancient glaciation are so great that all chronological records of Palæolithic cultures must be accepted with great reserve.

It may be one million, it may be two million years, since the first signs of humanity dawned in some form of ape-like creatures, but for vast periods of time his progress must have been extraordinarily slow. He probably learnt to throw a stone scores of thousands of years before he made any attempt to shape one. The beast side of him was probably in the ascendant even when he could do this, but as soon as he learnt to put up some sort of *reasoned* defence against his enemies—if we can justly apply such a term as “reason” to such a low scale of intelligence—his ultimate dominance became certain. The *ooliths* discovered in such numbers by Mr. Benjamin Harrison, the Kentish grocer, may and probably do represent early man’s first attempts to make a rough stone more handy for his use, but not all geologists agree. When we come definitely to Chellean culture, we are dealing with beings who had by that time acquired a considerable measure of rationality.

Lower Palæolithic cultures. The *Chellean* flint tools were big and clumsy. They were probably used for holding in the fist when fighting, and for digging up roots. The *Acheulean* stage shows a substantial step in advance; the *coups de poing* were much better shaped. But these flint tools were hardly ever found in caves; both Chellean and Acheulean people apparently lived in the open and we do not look in caves for remnants of their existence but in the terraces and deposits laid down by rivers and streams in the valleys. Chellean culture extended over a vast period of time, probably well

over a quarter of a million years. Progress was almost insignificant, just as it had been during the half million years previously.

Middle Palæolithic culture. This *Mousterian* culture was first recognized in French caves. It was no gradual transition from the Acheulean, but a substantial jump. The Mousterian man was of the Neanderthal type, an unprepossessing savage, and still ape-like, but much more intelligent than his predecessors. His flint tools were beautifully shaped, and one of them was cunningly tipped with a hard point. He lived in caves. Apparently he was given to thinking about death, for he certainly arranged ceremonial burial. Mousterian culture lasted for some tens of thousands of years.

Upper Palæolithic. Again there was a great general advance, but the cultures now succeed each other much more quickly; each lasts but a few thousand years, the Solutrean being the shortest. Neanderthal man disappears and men of the Cro-Magnon and other modern types take his place. A further great headway is made in the manufacture of flint tools, and in some cases there was craftsmanship of a high order. Some of the *Aurignacian* personal ornaments were really beautiful, and many examples of painting and sculpture have been found. The *Solutrean* lancet-leaf shaped implement made an excellent javelin head. *Magdalenian* man more or less abandoned tools of flint, and made tools from bone, ivory, horn, and antler. His fine-eyed bone needles are remarkable. Most remarkable of all, however, were his cave engravings and paintings. For painting materials he used mineral oxides and carbonates, his raw colours being pounded and mixed with fat. Some of the caves are of great length, and the paintings often occur a long way underground; Magdalenian man must therefore have improvised a very serviceable lamp. The reindeer was particularly common in Magdalenian times, so that the culture is sometimes spoken of as that of the reindeer age. The mammoth, the woolly rhinoceros, the bison, and the bear, were other animals common in upper Palæolithic times.

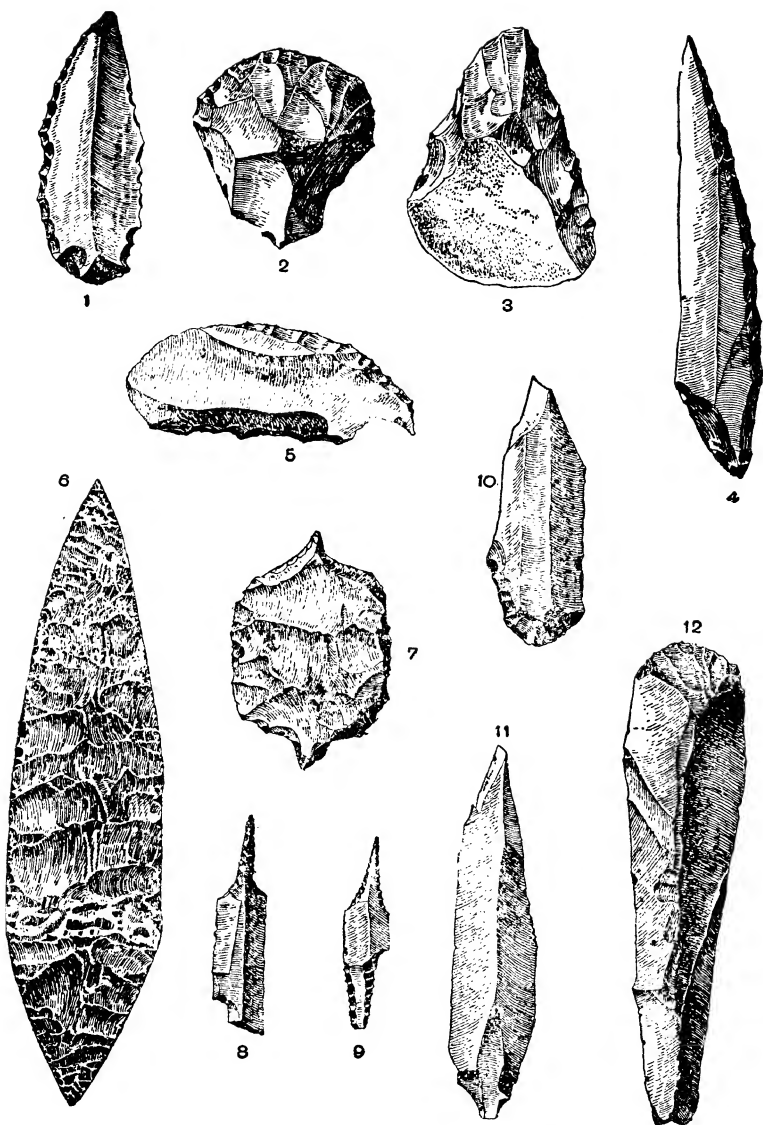

Fig. 181.—Upper Palæolithic Implements

1, Aurignacian (Chatelperron point). 2, 3, Aurignacian (keeled scrapers). 4, Aurignacian point. 5, Magdalenian ("parrot-beak" graving tool). 6, Solutrean (laurel-leaf point). 7, 8, 9, Solutrean (drill, awl, and "shouldered" point). 10, 11, 12, Magdalenian.

The Upper Palæolithic implements shown in fig. 181 are worthy of careful examination for their craftsmanship.

These six cultures probably extended over nearly half a million years. But it was the long, long dawn that emerged from the black night about which we are so uncertain. We have hardly any knowledge of what man was like during the period 1,000,000 B.C. to 500,000 B.C. About his actual beginnings we know nothing at all.

When did he first throw a stone? use a stick as a weapon? clothe himself with skins? light a fire? cook his food? *We do not know.*

Between Palæolithic times and Neolithic times there was a long period, commonly called the **Mesolithic** period, about which we know little. The close of the Palæolithic period coincided with a sudden change of climate. Arctic conditions disappeared; so did Magdalenian man and his wonderful art, and we know very little of the people who took their places during the next several thousand years.

Neolithic.—"Civilization" is the right word to use for this stage of man's history, for the mode of life and the general outlook of the people of the "New Stone" age was profoundly different from that of their Palæolithic ancestors. For this change four new discoveries or practices were mainly responsible, viz.: (1) agriculture; (2) domestication of animals; (3) manufacture of pottery; (4) tool-making by a grinding and polishing technique. Men now led a far less precarious existence than formerly; they were able to store food. They ceased to be roving hunters, and settled down into communities, living in huts grouped together in villages. Not infrequently these villages were fortified and on the tops of hills. Sometimes villages were built on piles driven into the beds of lakes. In short, the "ape" side of man had entirely disappeared, and he had become a being much as we know him now. With the discovery of metals, the Neolithic age passed insensibly into the Bronze Age, and the Bronze Age

into the Iron Age; an Age which brings us right down to the Christian era.

It will thus be seen that the great problem of man's evolution is concerned with the Palæolithic portion of the Pleistocene period, though we must look for his origin in the

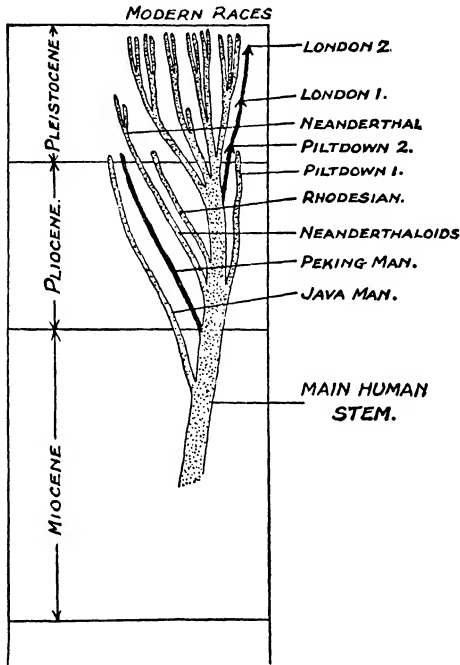

Fig. 182.—Phylogenetic tree of man's evolution showing the position formerly attributed to the Piltdown type and the position Sir A. Keith would now give to that type, and to the newly discovered London type. Compare this figure with the right-hand upper corner of fig 179.

Pliocene. At the very beginning of Palæolithic times, man was little more than a brutal ape-man; in mid-Palæolithic times he was still brutal but he was definitely a man; at the end of Palæolithic times he was a man much as we know him now, and when he had crossed the bridge into Neolithic times, he was a responsible member of a civilized community. We saw him at work in Chap. II.

Fig. 182 shows the Phylogenetic Tree of man's evolution as prepared by Sir Arthur Keith. Observe the suggested new position for Piltdown man, and of his possible descendant "London" man, a recent fossil discovery in the city of London.

Present-day Archæological Workers

When Sir **Arthur Evans** was engaged, during pre-war days, in his epoch-making investigations in Minoan Crete, or when his even more famous father, Sir **John Evans**, was engaged in the pioneer work of a generation before, the public imagination was scarcely stirred at all. But during the last fifteen years, archæological workers have caught the attention of the Press, and the interest of the educated section of the public has been roused. The photographs that have appeared in *The Times* of the wonderful results of recent "digging" have tended to create a general interest in the subject, and the present widespread, if elementary, knowledge of geology and geography has helped towards a rational understanding of what archæologists are doing. We can afford space to refer to only a few of the more prominent workers.

Archæologists from the University of Chicago have made great discoveries at Persepolis, the ancient capital of Persia. The field director is Dr. **Ernest Herzfeld**. Under 26 feet of rubbish from the Persepolis palaces which were burned by Alexander the Great in 330 B.C., the excavators have found an extensive area of magnificent sculpture dating back to Cyrus. The wall sculptures, if set together, would form a panel of relief 5 feet or 6 feet high and nearly 1000 feet long. The magnificence and the perfection of these sculptures are said to be most impressive. Two miles away the excavators unearthed a Stone Age village in a fine state of preservation, dating back to 4000 B.C. It was found beneath a mound 600 feet by 300 feet and only 10 feet in height. The walls of its adobe houses are preserved in places to a height of 6 feet

or 7 feet. There is an alley extending through the length of the village, and through the windows the visitor can see mural decorations of red ochre water-colour on the walls. In some of the dishes lay the flint knives with which people had last eaten some 6000 years ago.

Professor **J. Garstang** has made some remarkable discoveries at Jericho, and his excavation of the royal palace is expected to produce results of exceptional interest. The historical accuracy of the Biblical account of the siege and capture of the city has been confirmed in striking fashion; traces of a terrific fire have been discovered; and a large number of interesting scarabs have come to light. Professor Garstang hopes to find inscribed tablets from Egypt: the Tell el Amarna tablets are all letters from Palestine, written mostly by the Egyptian envoys or by the kings of the cities of Palestine to their suzerain the Pharaoh of Egypt. If the answers can be found, they may make clear some exceptionally interesting matters in the Amarna letters, which contain urgent appeals for aid from Egypt against the Israelites, appeals which, however, fell on unheeding ears.

The British School of Archæology in Jerusalem and the American School of Prehistoric Research have collaborated in the excavation of the caves of the Wady al-Mughara which lie at the foot of the western slope of Mount Carmel in Palestine, and a new Mesolithic culture has been identified, dating back to 5000-6000 B.C., and distinguished by remarkable craftsmanship in the working of bone. Evidence of the Mousterian industry, already known from excavations in Galilee by Mr. **Turville-Petre** and from those in western Judæa by Miss **Dorothy Garrod**, was found at the base of the cave deposits; and between the two, bridging the gap of 15,000 or 20,000 years, was a series of Upper Palæolithic hearths, containing an industry new to Palestine. In the smallest of the caves, fossil remains of man were found, apparently differing substantially from Neanderthal man: this man of Palestine has been labelled *Palæanthropus Palestinus*.

Of the excavations that have taken place in our country,

perhaps those of Dr. and Mrs. **R. E. Mortimer Wheeler** at St. Albans are the most interesting, and a good deal of light has been thrown on the conditions which prevailed in Britain prior to the Roman invasion. A dyke 100 ft. broad, 30-40 ft. deep, and some 5 miles long, runs across country from the north of the city, and it has been proved that this was a British defensive work extending from the pre-Roman city at the S.W. of St. Albans to prehistoric works at Wheat-hampstead where the remains are still to be seen. Recent excavations here have shown this to be a prehistoric "city" about a hundred acres in extent.

Charles Leonard Woolley is another well-known archæologist, whose main scene of activities has been at Ur ("Ur of the Chaldees"), an ancient city of South Babylonia. The joint expedition of the British Museum and the Museum of the University of Pennsylvania have succeeded in tracing the walls of the ancient city, the circuit of which is about $2\frac{1}{2}$ miles. The most surprising discovery of all is that, during the third millennium B.C., the city was largely a city of canals. Many interesting ancient temples and tombs have also been discovered. During the last two or three years, Professor **J. H. Breasted**, of the University of Chicago, has been excavating in the desert 50 miles east of Babylon, on the site of ancient Eshnunna. Houses of the Akkadian period have been excavated (Sargon of Akkad reigned about 2500 B.C.), and particularly striking are the old arrangements for sanitation. The lavatories are of modern European type, with a high seat, not the usual oriental kind of seat level with the floor. The lavatories were built of baked bricks and connected with drains which ran into a colossal vaulted main sewer underneath the pavements of the outside street. Remarkable discoveries of many other kinds are also being made.

The famous discoveries by Lord **Carnarvon** and Mr. **Howard Carter** in the Egyptian "Valley of the Kings", especially King Tutankhamen's funeral paraphernalia, are too well known to call for repetition here, though it may be mentioned that the discovered objects, beautiful as they are, will

not bear comparison with those of the Middle Kingdom, 500 years earlier, as a visit to the Old Jewel Room at Cairo will show at once. Mr. Carter has proved that King Tutankhamen was only eighteen when he died.

The two Italian cities, Pompeii and Herculaneum, were overwhelmed in the eruption of Vesuvius in A.D. 79. Pompeii was buried under a deluge of hot ashes and pumice, Herculaneum under a torrent of mud 40 ft. deep which solidified and protected the city like a fly in amber. Excavations at Herculaneum have been extraordinarily difficult, but Professor **Amedeo Maiuri**, by the use of modern methods, has recently done much to lay the old city bare, and the results are really extraordinary. The original wood, carbonized indeed but preserved, is still to be seen in the houses of the ancient city. A wooden staircase, a wooden bed, a wooden partition, a wooden clothes press—all used 2000 years ago, there they are to-day still in their old positions. The old houses of patrician type reveal something of the lives that the luxurious owners lived.

Vinča, a town in Yugo-Slavia, on the right bank of the Danube and 12 miles from Belgrade, has long been known as a centre of prehistoric culture. For the last twenty years, Professor **Vasič** has been working there, and his recently published and admirably illustrated book on the working of Cinnabarite and its use in the making of cosmetics will throw much light on the ancient Danubian culture.

Another well-known Yugo-Slavian archæologist is Professor **Brodar**. We may refer to his work in rather greater detail: it is typical of expert excavation and will give the reader some idea of actual procedure.

Palæolithic Culture in the High Alps

The north-west province of Yugo-Slavia is Dravska, the home of the Slovenes and corresponding roughly to old Slovenia, a name by which the province is still often known.

The largest town is the university town of Ljubljana (Ger. Laibach) on the river Sava, some 40 or 50 miles north-east of Trieste; and some 40 or 50 miles east of Ljubljana is the town Celje. If the waters of the Sava be traced to its upper reaches in the extreme north-west corner of Slovenia, we come to an Alpine region known as the Solčava region, one of the beauty spots of the world. Roughly square in shape, and about 5 miles each way, it is surrounded on all sides by lofty Alpine mountains, the west-east range forming the southern border being the Kamnick Alps. Two lofty spurs projecting northwards from these Alps cut up the region into three beautiful valleys. The only roadway into and out of the whole region is through the very deep river gorge on the eastern border. At the junction of the three valleys, the finest of which is the Logar, is the considerable village of Solčava. The Alpine range to the immediate north of Solčava, forming the Austrian frontier, is about 6500 ft. high. A three-mile mountain walk from Solčava to the north, up the Olseva ridge, brings us to the Potock prehistoric limestone cave (5500 feet up). From the entrance there is a gorgeous view southwards, down the Logar valley and beyond to the Kamnick Alps.

The entrance to the cave which is partly blocked by a huge rock is some 56 feet wide and 30 feet high. The plan of the cave is roughly that of a long, slightly twisted, rectangle with rounded ends; its length is about 120 yards, its maximum breadth 45 yards, and its floor area rather less than one acre. At first it is fairly level; then it abruptly climbs, and again falls gently.

The cave has been under exploration, during the summer months of each year since 1928, by Professor **Srečko Brodar** of Celje and of the University of Ljubljana, who soon discovered that it was a Palæolithic cave likely to be rich with evidence of early man. Excavation so far has been carried out in and around the entrance and at the extreme back. All the rest remains to be done. During the winter the cold is so extreme (the hundreds of remarkable ice stalactites and stalagmites at the cave entrance may readily be photographed

from the interior; they show up clearly against the outside sky) that no progress can be made. Moreover the cave is so high up that operations are expensive, and Slovenia is poor.

Already many striking discoveries have been made. In the more recent diluvial strata, great numbers of bones of the bear *Ursus spelæus* have been unearthed. At the far end of the cave, 83 artefacts, viz. bone implements, tools, awls, daggers and other weapons, have been found at depths of from 2 feet to 3 feet; here exploration so far has been limited to a depth of about a yard, though one experimental trench about 13 feet deep has been excavated. In and around the entrance, four prehistoric fireplaces have been found, and new discoveries are being made every summer.

Considering his limited resources, Professor Brodar has already done remarkable work. He has definitely established the fact that the cave was the abode of Palæolithic man; the culture may have been Aurignacian, but is probably earlier, perhaps 50,000, perhaps 100,000 years back. The actual cultures can only be determined by further evidence. Will Professor Brodar eventually discover actual remains of primitive man himself? If he does, all the archæological world will rush to see them. The archæological world might, in the meantime, spend a holiday in the Solčava region. The Slovenians are the most kindly and hospitable of people, and already the Potock cave will richly reward the interested visitor.

The cave has now been bought by the Museum Society of Celje, and the excavations have been entrusted entirely to Professor Brodar.

A Cartesian Transformation

Mathematical readers will be interested in Professor D'Arcy W. Thompson's Cartesian comparison of the human skull and the skull of the chimpanzee. On the outline of the human skull Professor Thompson drew the usual framework

of Cartesian co-ordinates. On the outline of the chimpanzee's skull he placed points corresponding, anatomically, exactly to the points where the co-ordinates cut the outline of the human skull. Through these new points he drew smooth curves, i.e. he projected the human skull on to a "chimpanzee plane". Fig. 183 shows the result. Look at the harmonious transformation! Look at the reduced brain cavity and the

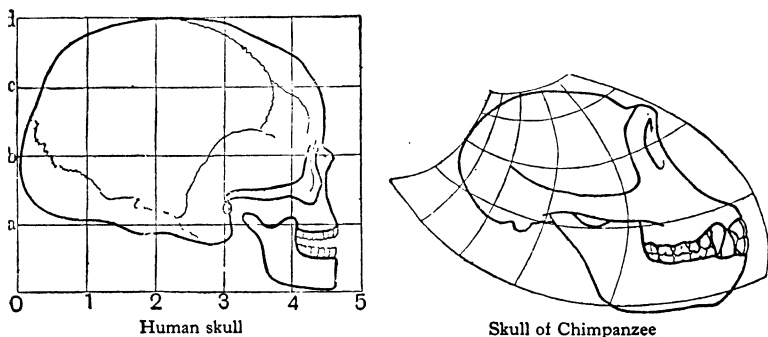

Fig. 183

enlarged jaws. As we pass from above downwards and from behind forwards, the corresponding areas of the network are seen to increase in a gradual and approximately *logarithmic order* as compared with the higher type of skull! Every mathematician should read at least this one chapter of Professor D'Arcy Thompson's book. He will probably at once pronounce the evolution of man to be a fact.

Training in Anthropology

The University of London is contemplating the foundation of an Institute in archæology in order to provide a centre of teaching, training, and research. The fact that the new university buildings will be so close to the British Museum will be of great advantage to students. It may be hoped that

the work of the Institute will ultimately be extended to include the larger discipline of anthropology. It is less the study of fossil man than the study of existing primitive man that is now of such great practical importance. Gone is the time when the administration of native peoples in our colonies can be entrusted to a man untrained in ethnography, primitive institutions, and primitive economics. A present-day administrator ought above all things to be trained in what may be called "human biology". Our policy towards natives in a rapidly changing native society cannot rest on a knowledge of present conditions alone. It must have direction, and this, at least in part, must be based on a diagnosis of the probable trend, range, and intensity of change, in native institutions, modes of life, and ways of thought, a diagnosis which only a trained anthropologist of wide experience would be justified in making. An Institute of Anthropology is badly needed; such teaching as is now attempted is too scrappy and is unorganized. If London or one of the other universities can establish such an institution, it may be assured of the deep gratitude of future generations of primitive peoples. And we shall then probably be less ready to lay violent hands on what we are pleased to call the "superstitions" of such peoples, and be more willing to examine the superstitions that still cling to ourselves.

(Portrait of Miss Dorothy Garrod, Plate 46.)

BOOKS FOR REFERENCE:

1. *Antiquity of Man*, Sir Arthur Keith.
2. *New Discoveries relating to the Antiquity of Man*, Sir Arthur Keith.
3. *Concerning Man's Origin*, Sir Arthur Keith.
4. *The Descent of Man*, C. Darwin.
5. *Man's Place in Nature*, T. H. Huxley.
6. *Anthropology*, Sir E. B. Tylor.
7. *Evolution of Man*, Ernst Haeckel.
8. *Evolution of Man*, G. Elliot Smith.
9. *Men of the Old Stone Age*, H. Fairfield Osborn.

10. *The Origin and Evolution of Human Dentition*, W. K. Gregory.
11. *A Guide to the Fossil Remains of Man*, Sir A. Smith Woodward.
12. *Study of Man*, A. C. Haddon.
13. *Ethnology*, A. H. Keane.
14. *Man, the Primeval Savage*, W. G. Smith.
15. *Up from the Ape*, E. A. Hooton.
16. *Growth and Form*, D'Arcy W. Thompson.
17. *The Golden Bough*, J. G. Frazer. (Twelve volumes dealing with primitive superstitions, &c., &c. Very useful for reference).
18. *Lectures on the Science of Language*, Max Müller.

CHAPTER XLVII

Economic Biology and Agriculture

This is such a big subject and touches life and human interests at so many points that we can only give a few indications of its general scope and character.

The Ministry of Agriculture and Fisheries

The Board of Agriculture for Great Britain was established in 1889, itself originating from the old "veterinary department" of the Privy Council; and four years later the duties of the Fisheries department of the Board of Trade were transferred to it. It was superseded in 1919 by the Ministry of Agriculture and Fisheries. The term "Agriculture" is defined to include "Horticulture". Similar Departments exist in Scotland and in Northern Ireland.

The Royal Botanic Gardens at Kew are under the control of the Ministry. So is the *Ordnance Survey* at Southampton, although several of the leading men of the Survey are highly trained army engineering officers, whose special technical knowledge admirably qualifies them for the work they have to do.

Among the omnibus duties of the Ministry are the execution of the statutes relating to the diseases of animals, the weighing of cattle, the redemption of tithe, the enclosure of commons, and the drainage and improvement of land. But its main business is agricultural research, and it has published at popular prices, a large number of bulletins, separate leaflets,

and other publications, for the assistance of farmers, small-holders, poultry-keepers, horticulturists, and others.

The hundreds of leaflets issued by the Ministry are full of practical expert advice, and if our farmers would only follow it they might easily be amongst the best in the world. The stupidity — perhaps stolid conservatism would be a fairer term—of some of the older English farmers is almost incredible. Said one to the present writer: "Ministry of Agriculture? why, those fellows are mere amateurs. I am a practical farmer, and I represent the fifth generation of my family who have held this farm; we have all been successful, and why should we change our methods? Put one of your precious Ministry fellows behind a plough, or put him on to thatch a rick, and then see what he would do." And that farmer's buildings, his fences, his cattle, his crops, and his fields were so uncared for as to be almost a blot on the countryside.*

The Bulletins or grouped leaflets (there are sixty-eight) include such subjects as Diseases of Farm Animals, Fruit Production, Bee-keeping, The Culture of Fish in Ponds, Inbreeding Poultry for Egg Production, Practical Soil Sterilization, Rats and how to Exterminate them, Pig-keeping, Ensilage, Fertility and Animal Breeding, Cheese-making, Celery Growing, Modern Milk Production, Salad Crops, Asparagus, Vegetable Diseases, and Rations for Live Stock.

The separate Leaflets deal with such subjects as the following:

1. *Farm animals and poultry*, e.g. swine-fever, anthrax, sheep scab, ringworm in cattle, pig-breeding, poultry feeding, calf-rearing, sheep-dipping, pig-sty construction.

2. *Farm and garden crops*, e.g. fertilizers, weeds and their suppression, fences and hedges, apple culture, planting of fruit trees, threshing of barley, the uses of lime, bare fallows.

* The ministry's leaflets have been on sale since pre-war days. In the summer of 1933 I questioned seven farmers about them. Only three had ever heard of them, and only one had obtained copies.



Neanderthal Skull

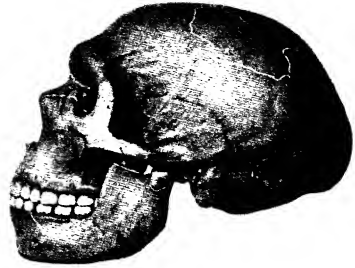

Plaster Cast of Neanderthal Skull



Restoration of Neanderthal Skull in progress

From Photos by Professor McGregor, Columbia University, New York

3. *Insects and pests injurious to crops*, e.g. plant lice, cabbage moth, asparagus fly, Hessian fly, turnip mud beetle, pea and bean beetle, mangold fly, wire worm, onion fly, slugs and snails.

4. *Insects and pests injurious to fruit and other trees*, e.g. pine saw-fly, mussel scale, pine weevils, vapourer moth, gooseberry sawfly, pear midge, pear and cherry saw-fly, frit fly, currant aphides, birds.

5. *Fungi injurious to crops and trees*, e.g. black scab in potatoes, peach-leaf curl, apple and pear scab, mushroom disease, tree root-rot, onion mildew, bean-pod canker.

And so on, and so on. The great feature about the Leaflets is the remarkably clear practical instructions given, e.g. for eradicating the different pests. The illustrated descriptions and life-histories of the scores of insects dealt with are alone almost a gold-mine of information to the practical farmer. It is quite obvious that every writer of the Leaflets knew his subject through and through. Since even the Bulletins and sectional volumes of the Leaflets cost but a few pence, and since the Leaflets give the very best advice the farmer can obtain, there is no longer any excuse at all why the English farmer should be so much behind his Continental brother. It is probably safe to say that not one English farmer in a hundred possesses his own chemical laboratory and that not one in ten could analyse his own soil. Agriculture is probably as well *taught* as in any other country in the world, but our farmers as a whole are sadly lacking in a scientific knowledge of biological principles.

Not every farmer by any means is familiar with the monthly *Journal* of the Ministry of Agriculture. It is full of up-to-date information on agricultural and horticultural matters. Recent issues have included such subjects as The Control of the Raspberry Beetle, The Use of Sodium Chlorate in the Eradication of Weeds of Arable Land, The British Breeds of Milch Goats, The Spotted Wilt Disease of Tomatoes, Experiments in Soil Heating, The Best Sheep-

branding Fluids, The National Mark Schemes. "The Month on the Farm" is a regular feature of all issues. The *Journal* is fully illustrated, and its price is 6/- a year.

Economic Entomology

This is the name given to that branch of biology which deals with the study of insects in their relations to man, his domestic animals and crops, and with the practical methods by which the activities of the injurious species may be counteracted. The subject also takes into account those insects which are beneficial to man, either with respect to certain economic products which they yield, such as silk, wax, and lac, or as agents in controlling other insects which have injurious propensities. All governments are alive to the enormous losses due to insect ravages, and the English Ministry of Agriculture is now doing its full share towards helping farmers to combat the evil.

Injurious insects include numbers of almost all "orders", and comprise (i) species which destroy cultivated plants and forest trees; (ii) species which injure grain and stored products, manufactured goods, and raw materials; and (iii) species which infest domestic animals as well as those which molest or harm man himself. The losses occasioned by insect pests are enormous. For instance, the cotton-boll weevil costs the United States cotton-growers from twenty to thirty millions sterling annually; the codling moth costs the United States fruit-growers nearly three millions; rice leaf-hoppers cost India several millions. We in this country do not escape by any means; for instance the frit-fly costs us eight bushels of oats in every acre grown. Two of the worst pests known are the Colorado beetle and the locust. Even such drugs as aconite and opium are infested by a beetle (*Sitodrepa paniceum*). The various pests known to entomologists number many hundreds.

Modern methods of controlling noxious insects are very diverse:—

1. *Cultural methods* generally necessitate some change in the normal course of agricultural operations and they are often preventive rather than remedial; e.g. the time of sowing or the type of manuring may be changed. The only satisfactory method of dealing with the frit-fly consists in sowing early, so that by the time the insect appears the crop has reached a stage when it is not liable to attack.

2. *Physico-chemical methods* are remedial rather than preventive, and the most important involve the application of chemical substances termed insecticides. These may be divided into “stomach” poisons, contact poisons, fumigants, and winter washes. Most of them may be applied either in the form of wet sprays or as dust. Knapsack sprayers which can be carried on the back of the operator are in common use. On a field scale, mechanically driven machines are necessary; and, in Africa, aeroplanes have been impressed into service.

3. *Biological methods* involve the use of parasites, predators, or disease organisms, for the purpose of ensuring a high rate of mortality to the particular pest concerned. For instance, the Australian lady-bird was introduced into California to destroy the cushiony scale (*Icerya purchasi*) of citrus fruits, with highly successful results; a wasp and a bug from Queensland and Fiji have controlled the sugarcane leaf-hopper in the Hawaiian Islands; a tiny Chalcid from the United States has been introduced into New Zealand, where it is effectually destroying the woolly aphid of apple. It is a case of the “survival of the fittest”. Entomologists are constantly searching the world over to find some little beastie that will willingly feed on some other little beastie which is causing trouble, though there is always the risk that the exterminator will prove as troublesome as the exterminated.

Much the same kind of measures is sometimes adopted for weed eradication. For instance, the prickly pear (several

species of *Opuntia*) was introduced into Australia and South Africa as a source of succulent stock feed, and it spread so rapidly as to become a very serious menace to agriculture generally. However, it has now been brought under control by the introduction from America of types of insects which feed on various parts of the plant.

For many years economic entomology was not officially recognized in Great Britain, and the subject was left to the good will of two public-spirited private individuals, **John Curtis** (1791-1862), who began life as a lawyer's clerk, and **Eleanor A. Ormerod** (1828-1901), who from childhood was almost as keen an entomologist as **Joan B. Procter*** was at a later date a lover of reptiles. Eleanor Ormerod, who carried forward and greatly extended the work of Curtis, has been called the patron saint of British economic entomology. When the Board of Agriculture was formed in 1889, Sir **Charles Whitehead** became its technical adviser on crop pests, but from 1894 to 1909, when the Development Fund Act was passed, very little was done. Funds were now forthcoming, and a plant-pathology laboratory was established at Harpenden, Herts, under a highly qualified director, though the Ministry of Agriculture remained in administrative control.

Mosquitoes and their Control

All mosquitoes (or "gnats") are regarded as a nuisance because of their painful bites; but some of them are disease-carriers as well, and are therefore positively dangerous.

A mosquito is easily distinguished from other insects by the conspicuous beak or *proboscis* projecting forward from its head. This proboscis is a sheathed bundle of pointed

* The recent death of Dr. Procter, when still in the prime of life, is to be deplored. She was an old St. Paul's girl, and became Keeper of the Reptile House at the Zoological Gardens, London. She designed the whole of the internal arrangements of the new Reptile House, as well as Monkey Hill. She had not the slightest fear of the most venomous of her charges. A marble bust of her may be seen in the frog-room of the Reptile House.

instruments. Other appendages of the head are a pair of maxillary *palps* and a pair of 15-segment *antennæ*.

There are many hundreds of species of mosquitoes, but they mostly belong to the two great tribes of Anophelines and Culicines. In Great Britain there are four of the former and twenty-four of the latter.

In the development of the mosquito, there are the four usual insect stages of: (1) *egg*, 1/32-inch long; (2) *larva* (or "wiggler"), 1/16-inch long when hatched, 1/2 to 5/8 inch when fully grown: during growth it changes its skin four times, the successive "moult" being called *instars*; (3) *pupa*, a comma-shaped object; (4) the *adult* winged insect.

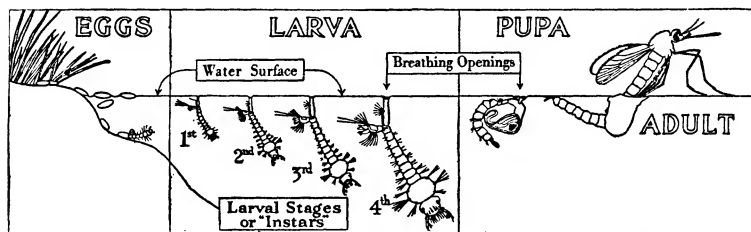

[By permission of the Mosquito Control Institute, Hauss.

Fig. 184.—Stages in the development of a Mosquito

The larva is in many ways the most interesting of the four stages. It lives in water but breathes atmospheric air through a pair of *spiracles* situated near its hinder end, in the eighth abdominal segment. The spiracles of the Anopheline larva open directly on the segment, those of a Culicine larva at the end of a tube projecting from the segment, called the siphon. Fig. 184 shows the life-history of a Culicine mosquito; the siphons of the four larval instars are seen with their extremities at the water surface, the larvæ hanging with their heads downwards. The Anopheline larva, on the other hand, has to lie, when breathing, parallel to the water surface in order that its spiracles may be in communication with the atmosphere above. The spiracles of both types are surrounded by hinged flaps, which close and prevent the water from entering when the larva has occasion to dive.

The adults of the two types may easily be distinguished from each other from the attitudes they assume when resting. The proboscis and abdomen of *Anophelines* lie in a straight line inclined to the supporting surface; the proboscis and abdomen of *Culicines* form an obtuse angle with each other, the abdomen remaining parallel to the supporting surface.

The male mosquito is harmless; he uses his proboscis for sucking out the juices of flowers and fruits. The female mosquito is a vicious, blood-sucking, creature; her proboscis

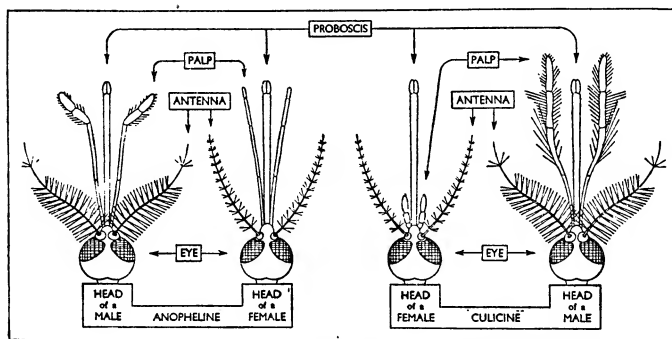

[By permission of the Mosquito Control Institute, Hants.

Fig. 185.—Head Appendages of Adult Mosquitoes

contains six pointed instruments, viz. two pairs of lancets, and one pair of other weapons which when pressed together during the "bite" form a highly efficient blood-sucking tube. During the act of biting, the sheath of the proboscis is drawn up out of the way. Should the mosquito be a disease-carrier, it ejects germ-charged saliva through its salivary duct into the blood of the person it is biting; it takes human blood but gives in return the poisoned fluid of its salivary glands. And its perfect case of instruments seems almost to be diabolically designed for the purpose. Fig. 185 shows the head appendages of adult mosquitoes. Fig. 186 shows the mouth parts of the female mosquito.

Malaria is carried by *Anophelines*, yellow fever by *Culicines*. It was Sir **Ronald Ross** who, in 1897-8, discovered

the life-history of malaria parasites in mosquitoes, and since then an enormous amount of successful work has been done in the direction of stamping out some of the worst mosquito-carrying diseases. Mosquitoes are quite easily controlled by attacking them in the larval stage, and if mosquito-infested districts would only follow the advice of Mr. **John Marshall**, the Founder and Director of the British Mosquito Control Institute, Hayling Island, they could obtain im-

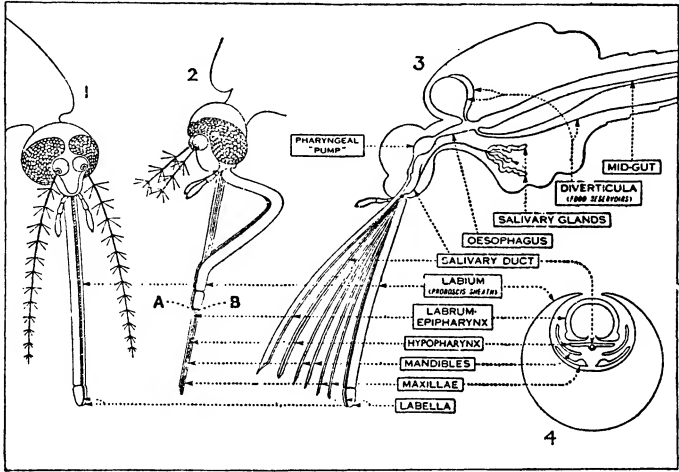

[By permission of the Mosquito Control Institute, Hants.
 Fig. 186.—Mouth Parts of a Female Mosquito

munity at an expenditure which is really trifling. It is merely a question of abolishing standing water, by either draining or "filling in"; or by setting the water in motion, and removing surface weeds. If this is impossible, the larvæ must be killed. This is easily done by spraying the surface of the water with oil, which enters their breathing tube and suffocates them. Or chemicals may be added to the water.

All Local Authorities should obtain Mr. Marshall's pamphlet, *A Mosquito Summary*, from which they will learn about mosquitoes nearly everything that is necessary. Science has completely conquered this particular pest, and there is

no reason whatever why mosquitoes should be tolerated any longer.

But the world has not been freed from malaria by a very long way. A co-ordinated frontal attack upon the mosquito is hardly to be expected: most governments are too indifferent, and the cost would be great.

Agricultural Education

Chairs of Agriculture and Rural Economy were founded at Edinburgh in 1790, and at Oxford in 1796, and the Royal Agricultural College at Cirencester was established in 1840, but until nearly the end of the last century the agricultural education provided was beyond the reach of the ordinary agricultural population. A beginning was made in 1890 when Parliament assigned to the County Councils a sum of £750,000 for the purpose of promoting technical instruction including agriculture, and from then until the outbreak of the war in 1914, some little advance was made by university departments of agriculture, by agricultural colleges, and by the county councils.

The present system, though it follows pre-war lines in its organization, is largely the creation of the years since 1918. It falls into two main parts: (1) advanced work extending over at least two years, in university departments of agriculture or at agricultural colleges, leading to a degree or a diploma; (2) elementary work provided by the county councils, consisting essentially of short courses intended for the boy already working on the land and proposing to return to it.

Higher agricultural education in England and Wales is provided at fourteen centres, of which seven are departments or schools of universities, and the other seven are agricultural colleges, each possessing its own governing body and not forming an integral part of a university. With the exception of three (the two women's colleges at Swanley and Studley,

and the Royal Agricultural College at Cirencester), the various institutions discharge an important function outside the actual teaching of students. Each is an "Advisory Centre" for a group of counties forming its "Province"; it is provided with specialists for the more important branches of science bearing on agriculture, such as chemistry and entomology, who supplement the more general advice provided for farmers by the technical staffs of County Councils. All the fourteen institutions are recognized and aided by the State. The cost to the student varies considerably; at the one end of the scale are the two Welsh colleges, Aberystwyth and Bangor, at the other end Oxford and Cambridge.

The education provided by the County Councils is much simpler, mostly by means of organized classes. There are, however, sixteen Farm Institutes, four of them in Wales (a type of agricultural college, but simpler and smaller), all save one supported and governed by County Councils. Normally an institute provides a six months' course of instruction during the winter, primarily for young people over sixteen, who have been working on the land and are going straight back to it. During the summer months, the institutes provide courses of instruction in dairying, poultry-keeping, and other special subjects. Inasmuch as the Government has said to County Councils "you may" rather than "you must", only a small minority have provided farm institutes, the others being content to provide agricultural instruction of a much less solid character.

In Scotland the universities and colleges control the whole system, and the organization of agricultural education is less "patchy" than in England and Wales.

The main defect of the system in England and Wales is that the County Councils are allowed to do as they please, and many of them are pleased to do very little.

Another great obstacle to progress is the conservatism of the British farmer. Still, progress has been made. Some of the younger farmers have been highly-trained and are "making hay" of many of the old-fashioned ideas inherited from

patriarchal times. The increasing number of advisory biological and other experts, either on the staffs of the universities and colleges or acting as peripatetic instructors, must inevitably soon let a bright light into even the darkest corners of British agriculture. If Parliament would make a grant to enable a thousand of our farmers to undertake a tour of investigation on the Continent and thus to learn something of the secret of Continental farmers' success, our experts would henceforth probably find their work more rapidly fruitful. Our present want of success in agriculture is not due either to any imperfection in our knowledge or to any serious want of well-trained biologists; it is due to the indifference and the passive resistance of so many of our older farmers.

Agricultural Research

Up to the nineteenth century, all the improvements in the art of cultivation had been made by intelligent observers of the processes of nature, working empirically by the method of trial and error. **Jethro Tull** (1674-1741) experimented on his father's land in Berkshire, and insisted on the importance of pulverizing the soil and the proper use of manure, and he wrote on the tillage of the land and the growth of crops. **Robert Bakewell** (1725-95), a Leicestershire man, wrote on the breeding of livestock. The experiments of both these pioneers were made in the true scientific spirit, but of true scientific knowledge, in the modern sense, they had none. In 1803 Sir **Humphry Davy** was engaged to lecture on "The connexion of chemistry with vegetable physiology". Davy was the pioneer of the application of science to agriculture, and he was followed by **Liebig, Johnston, Gilbert**, and others. But the intimate association of science and practical farming was really first recognized by (Sir) **John Lawes** (1816-1900), who established, at Rothamsted in Hertfordshire, the first agricultural experimental station.

Lawes succeeded to the Rothamsted estate in 1834, and

soon afterwards began that series of agricultural experiments which have become famous throughout the world. In 1843 Sir **J. H. Gilbert** (1817-1901) became associated with him, and their partnership lasted for fifty-seven years, until 1900 in fact, when Lawes died. Gilbert took charge of the chemical laboratory which was first set up and equipped in a barn.

Lawes' first experiments were directed to trying the effects of various substances on plant growth. Among other substances he used bone meal, but, finding it inactive on turnips, he treated it with sulphuric acid, to obtain the soluble substance then known as superphosphate of lime. Discovering that the same valuable product could be obtained by treating with sulphuric acid naturally occurring calcium phosphate, he found a use for the vast deposits of phosphate then becoming known, and in 1843 he set up a factory near London to produce these "artificial fertilizers". Field plots were laid out at Rothamsted to study the effects of the new fertilizers. In these a uniform system of cropping was, and still is, followed year after year. For instance, nearly ninety successive crops of wheat have been raised in one field; on another, barley, for nearly the same long period. The general purpose of the experiments was to grow the more important farm crops year after year on the same land, (i) without manure, (ii) with farmyard manure, and (iii) with various kinds of artificial manure.

Lawes and Gilbert also made experiments on the feeding of animals, adopting the original and then somewhat startling plan of killing the animals at the end of the trial and, by analysis, ascertaining the fate of the food.

Both Lawes and Gilbert were masters of scientific method.

In 1900 Lawes died, having previously set up a trust and endowed it with £100,000 for the continuance of the experiments. Gilbert died the next year. Sir **Alfred Daniel Hall** (*b.* 1864), now Director of the John Innes Horticultural Institution at Merton and Chief Scientific Adviser to the Ministry of Agriculture, was thereupon appointed Director, and at once he proceeded to bring the work into line with

the needs of modern farming. He gradually gathered around him a highly competent staff, and developed agricultural research in many new directions. He left Rothamsted in 1912, in order to organize agricultural research and education on national lines. He was succeeded by his equally well-known colleague Sir Edward John Russell (*b.* 1872), the present Director, and further important developments have since taken place. For instance, new departments have been set up for studying the microbiology and the physical and chemical properties of the soil; and laboratories for the study of plant pathology have been added. The electrical equipment now installed is almost unique. The staff are a body of distinguished men, and include entomologists, mycologists, and recognized experts in other departments. Rothamsted is, in fact, the envy of research workers throughout the agricultural world, and its remarkable success is due to its good fortune in securing the services of two such distinguished Directors as Hall and Russell. Rothamsted research aims at the unearthing of new knowledge; it does not waste its time in airing airy theories.

Nearly all countries are engaged in agricultural research of some kind, and in this connexion Russia, with all its troubles, must certainly not be overlooked. We can, however, afford space to touch upon only one other aspect of it, and in our own country.

In 1912, Parliament provided a fund of two millions for rural development, to include agricultural education and research. The responsible commissioners did not, as might have been expected, set up one or two large stations to deal with the whole body of agricultural science; instead, they made grants to certain existing institutions, each of which was to become responsible for one or more sections of agriculture. Of these institutions we may mention the chief, and the subjects assigned to them:

1. Soils, plant nutrition and plant physiology: (a) Rothamsted; (b) Cambridge University.
2. Animal nutrition: Aberdeen, Rowett Research Institute.

3. Plant physiology: Imperial College of Science and Technology, London.
4. Plant breeding: (a) Cambridge University; (b) Aberystwyth, University College; (c) Edinburgh, Scottish plant breeding station.
5. Fruit: (a) Bristol, Long Ashton; (b) Kent, East Malling.
6. Glasshouse industry: Cheshunt, Herts.
7. Animal breeding: Edinburgh University.
8. Dairying: Reading University.
9. Animal pathology: (a) Cambridge University; (b) Royal Veterinary College, London; (c) Scottish Animal Diseases Research Association.
10. Agricultural parasitology: London School of Hygiene and Tropical Medicine.
11. Agricultural economics: Oxford University.
12. Agricultural engineering: Oxford University.

This novel method of organization seems to have been fully justified, for expert opinion is unanimously favourable, though it need hardly be added that the various institutions do not confine themselves to the special work for which they have thus become responsible. The Government funds available have substantially increased since 1918, and grants are periodically made to institutions by the Agricultural Societies.

Space does not permit of a detailed description of the work in progress at all these institutions, and it must suffice to refer briefly to the few which at present command the greatest public interest.

At the School of Agriculture, Cambridge, Sir Rowland Biffen has for several years been engaged in researches on wheat. At bottom, his work has been an application of the principles of Mendelism. If these are well-founded, it ought to be possible to build up new varieties of plants and animals by purposeful crossings instead of following the plan of slow selection; much as the modern chemist makes new compounds, not by mixing things haphazard in a test-tube but by applying the principles of the atomic theory. This is what

Biffen set himself to do with wheat. The best known example of his work was his scheme of combining (i) resistance to rust disease which he found in an otherwise poor strain, with (ii) the high yield of one of the best cropping strains. He therefore crossed the two, but the offspring were all susceptible to disease. Biffen being a Mendelian was not discouraged, for he well knew that although characters may be masked for a generation, they may be bred out pure. He also introduced into his crosses the characters of "hard" grain rich in gluten, which the millers asked for; and strong straw to prevent the plants from being too easily laid by storms.

The two main strains he produced in this way were called Little Joss and Yeoman. Although not put on the market till 1912 and 1917, respectively, by 1927 they occupied about a third of all the world's wheat lands! Yeoman does not, however, suit all soils, especially clays and light sands, and Biffen is now trying to produce new types of Yeoman, by breeding in new features from other strains, which will suit every kind of wheat land in Britain.

At Edinburgh, Professor **F. A. E. Crew** (*b.* 1888), Director of the Institute of Animal Genetics, is doing for the breeding of animals what Sir Rowland Biffen seems to be doing for the breeding of plants. One of the most important results he has so far obtained is connected with the inheritance of milk-production in cattle. The research began with an examination of all the herd-books which the Department could get from breeders. The milk-records and the pedigrees of thousands of cows were examined and compared. The result clearly showed that the tendency to high milk production is due largely to "sex-linked" inheritance, which is a special case of Mendelian inheritance. A sex-linked factor means something which a father transmits to all his daughters but to none of his sons. A male, on the other hand, can only receive the factor from his mother. If a sex-linked factor enters into milk-production, breeders must use quite a

different system of breeding from the ordinary. For instance, if a particular bull sires a large number of high-yielding cows, his sons should, presumably, all be rejected for breeding purposes, for none of them will have inherited from the father the specific good qualities.

To test all this out by actual experiment would take many years and be very costly. But it seems clear that Professor Crew is on the track of something which could put up the average milk-yield of the cows of this country by anything from 20 to 80 per cent.

At the Rowett Institute, Aberdeen, **Dr. John Boyd** (*b.* 1880) is the Director of research in animal nutrition. The main purpose of the work now in progress has been to discover the relation between diet and disease, both in animals and in man. One important piece of research has concerned the nature of the diet afforded by different pastures to the live stock of Great Britain. Samples of herbage from some 400 different localities were taken and carefully analysed chemically, and the best methods of improving such pastures were worked out. It was also discovered that low mineral content of the pastures went hand in hand with a high incidence of disease in the stock which grazed them.

At Aberystwyth, Professor **R. G. Stapleton** (*b.* 1882) is the Director of the Welsh Plant Breeding Station. He is recognized as a foremost authority on grasses and clovers. He has recently acquired two tracts of rough mountain pasture, one between 900 and 1300 feet up, and the other above the 1500 feet level. The tracts yield but scanty nourishment for sheep even in summer, and in winter the flocks have to be sent down to the lowland farms and there boarded out. Professor Stapleton has now discovered that practically any hillside, at least up to the 2000 feet level, can be turned into pasture of lowland type (1) by getting rid of the existing vegetation and breaking up the soil; (2) by sowing with the right mixture of grass and clover seeds; and (3) by supplying

the right blend of mineral fertilizers. The first would have been impossible without the development of the caterpillar tractor to pull agricultural implements over otherwise inaccessible hillsides. Inasmuch as nearly a quarter of the area of Great Britain consists of mountains and rough hill grazing, the research will probably make an enormous difference to our future animal food-products.

The research work we are doing, with the resulting knowledge we are providing, is not less than that of other leading countries of the world, but we still have to induce many of our farmers to abandon their rule-of-thumb methods, and to substitute for them the methods of science.

Agricultural Research Abroad

Of foreign countries, Denmark and Canada have long been in the front rank in all agricultural matters. Within the next few years, however, Russia will not improbably take the foremost place of all. Whatever science can teach her, she is more than willing to lay to heart, and her recent progress has been astonishing. Our natural dislike of autocratic forms of government should not blind us to the material progress that may sometimes be made under them.

BOOKS FOR REFERENCE:

1. *The Soil—Manures and Manuring*, A. D. Hall.
2. *The Book of the Rothamsted Experiments*, A. D. Hall.
3. *Agricultural Education, 1890-1926*, A. D. Hall.
4. *Plant Nutrition and Crop Production*, E. J. Russell.
5. *Ministry of Agriculture*, Publications.
6. *Hayling Island Mosquito Control Station*, Publications.
7. *Agricultural Botany*, Percival.
8. *Education and Research in Agriculture*, A. C. True.
9. *Pioneers and Progress of English Farming*, R. E. Prothero.
10. *The Land and its People*, Lord Ernle (R. E. Prothero).
11. *Introduction to Agricultural Economics*, L. C. Gray.
12. *Agricultural Mechanics*, R. H. Smith.

CHAPTER XLVIII

Hygiene and Medicine*

Hygiene down the Ages

There is a startling contrast between the personal habits of the ancient peoples and those of the Dark and Middle Ages. Down to the time when the Romans were overwhelmed by their northern neighbours, civilized man tended to keep his person and his environment *clean*. The semi-barbarian peoples who then seized upon European power and gradually developed the European states as we know them now, took well over a thousand years to learn the necessity for cleanliness, and it was even less than a century ago when cleanliness was once more understood to be the most fundamental of all things for the preservation of health.

The sanitation of Egypt and the personal cleanliness of the Egyptians were features of the national life at least as far back as 2000 or 3000 B.C. They even knew enough about

* Readers interested in medicine and kindred subjects should familiarize themselves with certain well-known technical terms. A small number of Greek words will throw much light on them. For instance: (1) *pathology* (Gk. πάθος, disease) is that branch of medical science which deals with disease. A *pathologist* is one who is versed in the nature and diagnosis of disease; a *pathogene* is a disease producer (a germ). (2) *Therapeutics* is that branch of medical science which is concerned with the remedies for diseases; it includes the administration of medicine, hygiene, dietetics, etc. (Gk. θεραπευτικός, the art of medicine; literally, the art of attending and helping); the term therapy is used chiefly in compounds; *radium-therapy* = radium treatment. (3) *Sepsis* = putrefaction (Gk. σηψίς); septic = characterized by putrefaction (Gk. σηπτικός.); opposed to *antiseptic*, which refers to anything which *destroys* putrefaction, fermentation, and the micro-organisms of disease; an *aseptic* wound is *free from* putrefaction and micro-organisms of disease; it is without "sepsis" and is therefore clean (Gk. ἀ- = without). (4) *Prophylactic* = preventive of disease (Gk. προφυλακτικός, precautionary). (5) *Clinical* (Gk. κλινικός, a sick-bed) medicine = instruction given to students at the bedside of the patient.

medicine to be able to differentiate 250 diseases, and there was a vast code of rules for therapeutic and surgical treatment. The operation of circumcision is depicted on the Sakkarah pyramid, 4000-3000 B.C. Minoan Crete extended to least from 3400 B.C. to 1100 B.C., that is, right through the Bronze Age, and we have referred in a previous chapter to her wonderful sanitary engineering, drainage, baths, and lavatories. The sanitation of Ancient Babylon and Assyria was equally remarkable; there was probably little to choose in this respect between the Euphrates and Nile valleys. Probably the Hindus were even more noteworthy still. As far back as 1500 B.C. they had definite rules for daily washing, cleaning the teeth, rinsing the mouth, and trimming the hair and nails; for meals, two daily, with a walk after each; for massage, baths, and gymnastics; for simple prophylactic measures, e.g. a weekly emetic and a monthly laxative; and so forth. The patriarch Moses was brought up in Egypt, and we need not therefore be surprised that his series of sanitary rules for the Jews were elevated into a code. In ancient Greece the development and preservation of physical fitness became a cult. In ancient Rome, the sanitary system and the water supply were almost as perfect as human ingenuity could make them, and as Rome extended her sway she carried her hygienic systems with her—at least in some measure. Examine, for instance, the plan of the recovered ancient English city of Silchester, and note the street-planning and the houses. But the Romans were called home, and the Britons, left to themselves, fell an easy prey to the rovers from oversea. The Roman civilization in this country was wiped out, and the hands of the clock were put back for a thousand years.

The glamour of the few salient events of that long period as recorded in our school history books, gives the ordinary boy a totally false impression of the men of those days. The collection of ruffians whom Duke William of Normandy brought over to invade England in 1066, or those who, luckily for the country, played the game of mutual exter-

mination in the Wars of the Roses four centuries later, are generally thought of by the schoolboy as "noblemen", men of gentle birth, normally living in refinement and discussing art and literature! About the well-being of the ordinary people the boy knows practically nothing. For centuries before Hastings and for centuries after, the majority of the people living in the squalid little towns of England were miserable, half fed, and disease ridden. Picture a principal street of a town, very narrow, probably with overhanging upper stories and therefore dark, with a common open sewer, or rather open ditch, running down the middle, into which sewage and foul rubbish of all kinds were cast. Think of the nature of the sodden ground as century succeeded century, and the effect on the local water supply, almost always, be it noted, a local surface supply. Think of the Black Death of 1348, or of the Great Plague, as late as 1665. What glorious breeding-grounds for the invading germs! The wonder of it is, not that millions of people died but that any at all survived. Diseases of the worst kind were rife for centuries: plague, cholera, leprosy, typhus, small-pox, and many another; and at such times the credulity of the people was astonishing, exorcisms, incantations and charms being remedies frequently administered and greedily accepted.

When Erasmus visited England during the reign of Henry VIII, he was struck by "the filthiness of the streets and the sluttishness within doors"; also with the beastliness of the inns, "with their rush-strewn floors so seldom renewed that the substratum may be unmolested for twenty years, with an ancient collection of beer, grease, fragments, bones, and everything that is nasty." The inns were indeed past praying for. "Of bed-linen there was none; blankets were never washed and remained on a bed till they rotted; the beds were packed full without regard to age or sex." Of ordinary decency or cleanliness there was none at all. The verminous condition of the inns is simply indescribable, and the same thing really applies to the private houses. For hundreds of years body vermin seems to have been accepted as a necessary evil;

the lofty head-dresses of Plantagenet ladies were simply vast nests of vermin, and only a whispered reference may be made to the ladies' "leather stays", which were never cleansed. Night garments were not worn until Elizabethan times. Even worse than the inns were the prisons, and their shocking condition lasted right down to the eighteenth century, when **John Howard** (1726-90), High Sheriff of Bedfordshire, did much to bring about a reform. Dickens's nineteenth-century description of the Marshalsea prison in *Little Dorrit* is not one whit overdrawn. At this same prison, the century before, between thirty and forty persons "slept" in one room 16 feet by 14 feet by 18 feet, being locked in from 9.0 p.m. to 5.0 a.m.; regardless of age and sex, people were huddled together indiscriminately. In the spring, eight or ten deaths a day at this prison were the usual thing.

Mediæval hospitals were places where charitable relief rather than medical attention was given. By the time of the Renaissance things had improved a little. Fig. 187 shows a ward in a sixteenth-century Paris hospital. It will be observed that patients are placed two in a bed! There were not trained nurses, of course, but the nuns did what they could. Observe that some nuns are acting as attendants, some are sewing, some are engaged in religious exercises.

A ray or two of light broke through in the time of Queen Elizabeth, and a few people began to pay more attention to personal hygiene. The Queen "doth now bathe herself once a month, whether she require it or not." Now and then a distinguished medical man arose and got something done, but the ordinary practitioners were too grossly incompetent to back him up, even if they had been willing to do so. An interesting instance of medical incompetence is recorded in connexion with the last illness of Charles II in 1685, when he was attended by twelve to fourteen physicians, all selected presumably, for their professional efficiency. The king was taken ill suddenly: an embolism may have been the cause, or perhaps some kidney disorder: the physicians could not tell. One of them was a Dr. Scarburgh, who has left a written

record of their procedure.—The king was bled in the arm and at the shoulder, he was given strong purgatives and enemas, he was blistered, he was plastered (the plaster consisted of Burgundy pitch and pigeon dung), and he was given a long succession of powerful and noxious drugs (over forty, including a human skull preparation) and an enormous amount



Fig. 187.—A Hospital Ward in sixteenth-century Paris. In the left aisle, a nun folds the hands of a dying patient, while a priest gives the Sacrament to another in the same bed. In front, nuns sew shrouds. The right aisle is more cheerful. Nuns minister to two patients in one bed, while a convalescent, fortunate in having a bed to himself, vigorously takes nourishment. In the centre, nuns receive postulants and a royal founder kneels in prayer.

of herbs. Assuredly he must have envied the last hours of his own father! And yet these medical men were not indicted for regicide!

Infant mortality was amazing. Dean Colet (*d.* 1519) was the only one of twenty-three children to reach maturity. Queen Anne (*d.* 1714) had seventeen children, and all save one died in infancy, the one surviving to the age of twelve. Medical practitioners, such as they were, were rarely called in for cases of childbirth. Utterly incompetent midwives were often employed, even in the nineteenth century,

as may be seen from Dickens's attack on them in *Martin Chuzzlewit*. It is said that his Sarah Gamp was a true picture drawn from life.

As for surgery, the grave problem of wound infection was not solved until Lister took it in hand, and the vast majority of surgical operations led to fatal results. It is amusing nowadays to read of the anxiety of surgeons even when they had to perform quite trivial operations. George IV had a small sebaceous cyst in the scalp, and the regular Court surgeons were only too pleased to hand over the necessary operation to a younger man, Sir Astley Cooper, who, however, himself records that he "felt giddy at the idea of my fate hanging upon such an event;" if the operation were followed by erysipelas, "it would destroy all my happiness and blast my reputation."

By the middle of the eighteenth century the hygienic conditions of the country were beginning to improve. Many of the noisome streams, which were hardly anything but open drains, were covered in, but for nearly another hundred years cess-pools were common even in London. The methods of sewage disposal will hardly bear describing. In London the sewage polluted all the smaller rivers and finally passed wholesale into the Thames. In the towns, including London, a continuous water supply was simply unknown. Moreover the water was derived from polluted rivers and surface wells, and there was not always that clear distinction between a water-main and a sewer that we now consider necessary.

By the middle of the nineteenth century, there was an all-round improvement. Parliament had become alive to the pressing need of sanitary reform, and in 1875 the Public Health Act was passed. The Act made provision for, amongst other things, the construction and maintenance of sewers, the enforcement of the draining of houses, the supply of water, dealing with infected persons, and the appointment of medical officers of health and inspectors of nuisances. It

is almost incredible, therefore, that now, sixty years later, villages and even small towns in England may still be found without a sewerage system.

Great Figures in the History of Medicine

We referred in Chap. X to the two outstanding figures in medical science during classical times, **Hippocrates** and **Galen**.

The pre-eminence of Hippocrates is in no small measure due to the fact that he separated medicine from theology, priestcraft, and philosophy, and freed himself from the mystical atmosphere of the semi-religious medical schools of his youth. He was essentially a man of science, and as a medical practitioner he overtowered all his contemporaries by his skill as a clinician and diagnostician. At the side of his patient, he made careful note of every sign and symptom. "The elaborate case-records filed at a modern hospital, with appended reports from bacteriologist, hæmatologist, radiologist, and serum therapist, are the logical outcome of the work of Hippocrates." Hippocrates was essentially an observer; he searched for facts, and he never enunciated a principle until satisfied that the discovered facts justified it.

Galen was a man of a totally different type. Hippocrates had scarcely a thought for himself, but was devoted to his patients. Galen was a money-making, fashionable physician, witty and courtly, arrogant and plausible, highly efficient, with an almost uncanny insight into the foibles of his patients. His methods were altogether different from those of Hippocrates. Facts did not worry him over much. He was a pragmatist. He accepted the general principles which Hippocrates had so firmly established by generalizing facts, and from those principles he drew deductions that would meet the needs of his own cases. And shrewd indeed those deductions usually were. When appointed court physician, he was called in to attend to the Emperor Marcus Aurelius for acute gastric

discomfort. He knew from Hippocratean principles that this malady commonly results from incorrect feeding, and made the simple deduction that the Emperor had been over-indulging in some favourite food. One or two innocent questions elicited that this was cheese. He did not say to the Emperor, "My dear fellow, you've got what children call the tummy-ache." Not he. He probably assumed a grave face and proceeded somewhat in this way: "I understand your Majesty's case perfectly; there is a functional derangement arising from imperfect metabolism, easily traceable to caseic fermentation. Eat no more cheese for a month, and then eat it sparingly: in the meantime take ten drops of this elixir three times a day, not one drop more, not one drop less. Then I can guarantee a perfect recovery." Galen was quite unscrupulous enough to put a little bitter extract into some prettily coloured water and to refer to it as an elixir of great potency and rarity. Be that as it may, his wonderful cure made his fortune, for all fashionable Rome flocked to him.

In his Romanes Lectures delivered in the Sheldonian Theatre in June, 1932, the President of the Royal College of Surgeons, Lord **Moynihan**, remarked: "To Hippocrates, more than to any other, we may attribute the method of *induction*, the method by which a general law is formulated after observation of a multitude of single examples. As observer, correlator, generalizer, the diligence of Hippocrates has in medicine surely never been surpassed. To Galen we owe in medicine the method of deduction, to exposure of those isolated facts from which generalizations are at last constructed."

"Armed with these two indispensable methods, the practitioners of medicine were nevertheless for more than 1000 years almost impotent. This millennium was given over to the reign of incorrigible authority. No Holy Writ was ever so indisputable, never was its sway so tyrannical, its acceptance so complacent, so witheringly destructive of original thought, as were the writings of Hippocrates. Tyrannous indeed was the control which Hippocrates and Galen

exercised for so many centuries. In all that sterile period no new thought is found, no new method, no new experiment. To deny the authority of Hippocrates and Galen, or to dissent from their teaching, was not merely heterodox, it was heresy, punishable by death itself."

During that dark millennium, one bright star certainly did appear, though not quite of the first magnitude. This was **Avicenna** (980-1037), the son of a Persian, born near Bokhara, a gifted man and a great scholar. He owes his reputation chiefly to a treatise called the *Canon of Medicine*, which was a complete codification of Greco-Roman medicine. It contained little that was new, though it showed some advance in pharmacy, chemistry, and clinical methods. It became a sort of medical bible, and was in general use as an authoritative reference book for some 600 years.

The greatest name in medical history between Galen and Harvey was the Flemish anatomist, **Andreas Vesalius** (1514-64), son of the Emperor Maximilian's apothecary. We have already referred to him in Chap. XXVIII. Vesalius was the creator of anatomy as an experimental science. At the age of twenty-four he was elected to the chair of Anatomy and Surgery at the University of Padua, and he set himself the task of describing in accurate detail all the parts of the human body and of illustrating his descriptions with drawings, drawings which have ever since been the admiration of the medical world. Like all his contemporaries he had been brought up as a disciple of Galen, but he abandoned the scholastic method of following ancient authority, and resorted to practical dissection and demonstration, lecturing to crowds of students and dissecting as he lectured.

Eventually (in 1543) he published his famous and beautifully illustrated work in seven volumes, *De Fabrica Humani Corporis*, in every part of which he corrected Galen and criticized him in language which was sometimes almost violent. The masses of new and unassailable facts which Vesalius obtained from his own dissections led to the utter rout of the followers of Galen. Galen had been a good prac-

tising physician a thousand years before, but his knowledge of the human body was necessarily slight, and he had to work largely in the dark; it was now definitely shown that he had often been at fault, that his "facts" were often seriously inaccurate, and that his medical knowledge was woefully incomplete.—Vesalius lived in dangerous times, and as he made great fun of his professional opponents (they included nearly every one of mark in the medical world) he was lucky to escape the fate that overtook many eminent men who in those days forsook authority and sought the truth for themselves.

The *Fabrica* volume on osteology might be used as a textbook to-day; so might the volumes on mycology and neurology; the latter was illustrated by a series of very accurate dissections and cross-sections of the brain. All the *Fabrica* illustrations are wonderfully realistic; they do not give the impression of the dissected cadaver but rather of vivisections of a living man.

We referred in Chap. XXVIII not only to Vesalius but also to Servetus, Columbus, Fallopius, Fabricius, William Clowes, **William Harvey**, Thomas Sydenham, John Mayow, and Christopher Wren, all of whom made notable advances, though Harvey was by far the most outstanding figure amongst them. Of Harvey, Sir **George Newman** (*b.* 1870), now chief medical officer to the Ministry of Health, writes:

"Harvey's demonstration of the circulation of the blood possesses much more than its face value; it is much more than a true explanation of the special purpose of the heart and blood-vessels. Harvey's work did much more than explain a mechanical fact: it introduced the scientific method into a fundamental problem. He showed the necessity of patient and accurate examination of the anatomical morphology in man and animals; he explained the function of these structural facts, as suggested by the particular features of the structure; and he devised experiments, by vivisection or otherwise, for proving the validity of his explanation and interpretation of the function. It was the death-blow to all

fancies, theories, and notions about 'spirits' and 'tides'."

Harvey's work was revolutionary, seeing that it led to such rapid advances in our knowledge of physiology. A succession of subsequent workers made discovery after discovery. In 1622 the lacteals and lymphatic system by which nutriment reaches the blood were discovered, and in 1642 the ducts of the salivary glands, the pancreas, and the kidneys; the exploration of the chemistry of digestion began in 1648; the blood-corpuscles were discovered in 1658, and the capillaries in 1661; by 1668 a good deal had been found out about the mechanics of respiration; in the eighteenth century there were many discoveries in connexion with the nervous system; and during the last 200 years many further advances of a far-reaching kind have been made, e.g. the development of the cellular theory; the chemistry and the metabolism of the blood; the biochemistry of nutrition, digestion, and assimilation; nervous regulation and integration; the nervous control of muscle; and discoveries in endocrinology. Many of these great discoveries in physiology were being made even when the majority of the people were living under unhygienic, even sordid, conditions.

The man who changed surgery from a crude barbarism to a science, and the practice of its craft to a rational procedure, was **John Hunter** (1728-93), a Lanarkshire man, universally recognized as one of the greatest surgeons of all time. "He combined the painstaking dissections of a Vesalius, the experimental genius of a Harvey, the thoughtful physiology of a Heller, with the pathological investigations of a Morgagni." Though taciturn, quick-tempered, and scornful, in his professional work he was unrivalled. The gross morbid changes occurring in the bodies of men, and the structural changes responsible for the symptoms of disease, were at last and for the first time adequately recorded and studied. Symptoms could now with confidence be ascribed to their material causes. Henceforth the examination of dead bodies for the purpose of revealing organs affected by disease, and of discovering the causes of symptoms, was

regularly practised. To the physician this meant physical defilement, and the grossly incompetent barber surgeons simply could not understand the necessity for it. Hunter scoffed at the written word. "I believe nothing I have not seen and observed for myself." To his pupil Jenner he said, "Don't think; try the experiment." The whole spirit of surgical practice he completely changed. The Royal College of Surgeons recorded on his coffin, "The Founder of Scientific Surgery".

And yet the benefits derived by the ordinary patient from the great advances in physiology and in the practice of surgery were almost negligible. The far-reaching changes in *general* medical practice were still to come.

In spite of Hunter's work, surgery remained handicapped by two things: (i), the lack of anæsthesia, which made speed of operating even more important than sound technique; and (ii), the lack of any antiseptic principle to check the ravage of septic infections which rendered every operation dangerous and every hospital liable to epidemics of erysipelas and gangrene.

In 1799 Sir **Humphry Davy** gave "fair trial" to the effect of nitrous oxide on himself and small animals, and in a paper published in 1800 he suggested that the gas might be used during surgical operations. In 1824, Dr. **H. H. Hickman**, a west country practitioner, performed minor operations on dogs and mice which had been rendered unconscious by the inhalation of carbonic acid gas, but he failed to get his work approved by the Royal Society. In 1842, Dr. **Long** used ether for minor surgery in America; in 1844, **Horace Wells**, a Connecticut dentist, used nitrous oxide; and in 1846 **William Morton** used sulphuric ether at Massachusetts. Finally in 1847 Sir **James Young Simpson**, Professor of Obstetrics at Edinburgh, first used ether for midwifery purposes, but in the same year he substituted chloroform. Anæsthesia made surgery safer and more popular. Deliberate and careful surgery now replaced the old, necessarily very quick, type of operation, and practitioners were

able to explore regions of the body hitherto closed to them.

In his Romanes lecture, Lord Moynihan said that in his judgment "the greatest material benefactor of mankind the world has ever known" was **Joseph Lister** (Lord Lister) (1827-1912), a British surgeon, born in Essex, of Quaker stock, who became Professor of Surgery at Glasgow in 1860, and afterwards at King's College, London. He became President of the Royal Society in 1895. "His training in the methods of the laboratory, his saturation with the ideal of unbiased inquiry, his devotion to truth, his faith in the religion of research, together with his clinical knowledge of surgery, and of those most perplexing and revolting catastrophes which daily resulted from wound infection, gave him both power and incentive for that arduous investigation which culminated in the enunciation of the principle that wound infections are due to living particles." He had pondered much on the suppuration of wounds as he saw it at the Glasgow Infirmary, and he was led to conclude (1), that decomposition caused suppuration; (2), that wound infection did not occur without suppuration; (3), that decomposition was in some unexplained way set up by air; yet (4), air alone did not give rise to the decomposition. At this juncture he heard of Pasteur's work, and learned that putrefaction was a fermentation set up by microbes carried in the air, and that it was possible to free the air of these minute organisms. Lister saw at once that this might have an important bearing upon the question of suppuration and wound infection, and to his four former conclusions he added another, (5), that micro-organisms cause putrefaction and reach the wound through the air. He saw that he must exclude the micro-organisms around the wound or destroy them in the wound; whence came his use of the carbolic spray and the carbolic dressing. He was soon able to control the sepsis of his patients' wounds, but for the perfection of his work prolonged further investigation into the bacteriology of fermentation and of wound infection was called for.

During Lister's early career in London, his work was

ridiculed, and he had to put up with much personal abuse, but before the end of the eighties his principles were universally accepted. Listerian surgery cleaned up the hospitals throughout the world, and it immensely enlarged the scope of abdominal, uterine, and brain surgery. It was a master example of scientific method.

Louis Pasteur (1822-1895), the famous French chemist, pathologist, and bacteriologist, the son of an observant father (a tanner) and a clever mother, was born at Dôle, Jura. He was sent to the *École Normale* in Paris, and became a teacher first of mathematics, then of physics, but when, in 1843, he attended lectures by Dumas at the Sorbonne, he decided to devote himself to chemistry, and at once became an ardent research worker. Isomerism and stereo-chemistry specially attracted him. In 1852 he was appointed Professor of Chemistry at Strasburg, and married the daughter of the rector of the university. He now turned his attention to different types of tartaric acid, and the crystallization and fermentation associated with it. Appointed Professor of Chemistry at Lille in 1854, he was consulted by a local brewer about the souring of his beer, and this was the beginning of Pasteur's fruitful studies into the causation of fermentation. Examining the "diseases" of the beer, wine, and vinegar in the breweries of the town, he proved that all fermentation is produced by the growth of germs, each fermentation having a particular germ. He thus killed for all time the growing theory of "spontaneous generation", conclusively proving not only the presence of micro-organisms in the atmosphere but also the healthiness of injured living matter when protected from them.

His work on acetous, lactic, and vinous fermentations proved an enormous advantage to some of the leading French industries. In 1865 he carried out a masterly research on silkworm disease, isolating the bacilli of two distinct diseases, and providing a method of preventing contagion. Following up Jenner's vaccine treatment, he studied chicken cholera and reduced the mortality in fowls from ten to less than one

per cent. Pasteur next isolated the bacillus of anthrax, and, by cultivating it, a degenerate and weakened form was obtained (a vaccine) which, when inoculated as a prophylactic, produced a slight attack of the disease and rendered the subject immune. Perhaps the most interesting of Pasteur's investigations concerned the curative and preventive treatment of hydrophobia in man and of rabies in dogs. The Pasteur Institute at Paris was founded in 1885, and thousands of people suffering from hydrophobia have since been treated there. Similar institutes have since been established in many countries. Pasteur's methods have been followed up by pathologists ever since, and many diseases have already betrayed their special micro-organisms. His wonderful scientific acumen and profound sagacity enabled him to solve "the problems of the world of the infinitely small", as he called it. As an eminent pathologist he gained the honours of the whole scientific world, and the whole scientific world seemed to be at his funeral to do him homage. His body was laid in the new mausoleum built at the Pasteur Institute. On the marble walls is an inscription summarizing Pasteur's discoveries:

1848, Dissymétrie Moléculaire; 1857, Fermentations; 1862, Générations dites Spontanées; 1863, Études sur le Vin; 1865, Maladies des Vers à Soie; 1871, Études sur la Bière; 1877, Maladies Virulentes; 1880, Virus Vaccins; 1885, Prophylaxie de la Rage.

Then follows a sentence from one of his own orations:

"Heureux celui qui porte en soi un Dieu, un idéal de beauté, et qui lui obéit—idéal de l'art, idéal de la science, idéal de la patrie, idéal des vertus de l'Évangile."

Robert Koch (1843-1910) was born in Hanover and in 1866 graduated in medicine at the University of Göttingen. He became a country medical practitioner but spent his evenings with the microscope. In 1876 he isolated the bacillus of anthrax, and later proposed a preventive inoculation against the disease. This work made him known, and with financial

help from friends he entered the Imperial Health Department to study traumatic infectious disease. It was here that he formulated his "postulates" for the isolation of pathogenic germs: (1), find the germ in the diseased animal; (2), separate the germ and cultivate it outside the animal body; (3), prove its inoculability into susceptible animals; (4), isolate it from the inoculated animal and recultivate it. It was here, too, that he not only discovered, in 1882, the bacillus of tuberculosis, but also the cholera bacillus and the proof of its transmission by water. As the result of this work he was appointed Professor of Bacteriology at Berlin. He prepared "tuberculin", a lymph by which he hoped to effect a cure for phthisis, but it has failed to prove a remedy, though valuable as a diagnostic agent. From the accurate use of Koch's methods, by himself or by his successors, a dozen new pathogenic germs were discovered between 1882 and 1900, including the causal bacilli of six great world-wide diseases: tuberculosis, cholera, diphtheria, typhoid, tetanus, and plague.

Sir **George Newman** is of opinion that the main contribution of Koch and his school was the introduction of "a novel and superb technique"—the staining, cultivation, and sterilization of micro-organisms. In order to study the structure of tissues and cells, and still more of micro-organisms, it was necessary to *stain* them and make them clearly visible. Koch and his helpers were master-stainers, and they worked out ingenious ways of displaying the bacillus, its shape, its internal protoplasm, its capsule, its cilia. Even more contributory to the separation of different organisms was the invention of culture media which would solidify. Koch's method of pure cultivation, completed in 1881, yielded within a few years a rich harvest of discovery, in which the work of German bacteriologists played a very large part.

The Englishman **Lister**, the Frenchman **Pasteur**, and the German **Koch**, may be described as having been the world's greatest figures in preventive medicine. The three met in 1881 at a demonstration given by Koch at King's College,



VON LIEBIG



JENNER

National Portrait Gallery

London, during the International Medical Congress. Dr. **Charlton Bastian** (1837-1915) was also there, a well-known London professor of medicine who obstinately defended, till his death, the exploded theory of spontaneous generation. Pasteur warmly complimented Koch (they had not previously met) on the work the famous German was doing. But when, at the same Congress, Bastian was rash enough to get up, aggressively as usual, to air his views on spontaneous generation, Pasteur almost boiled over with indignation. Dramatically raising his hands above his head, he exclaimed: "Mon Dieu, mon Dieu! est-ce que nous sommes encore là? Mais, mon Dieu! Ce n'est pas possible!"

Preventive Medicine

Even from ancient times medical practitioners have striven not only to cure but to *prevent* disease. Until recent times, however, the actual causation of disease was unknown, and "Preventive Medicine" could make comparatively little headway. With his present-day knowledge the practitioner is first of all an immunizator; his *practice* is, as far as he can make it, a practice of prevention, a practice scarcely dreamed of a century ago. He resorts to nature's own methods of healing—rest, fresh air, dietary, exercise. He has less and less use for drugs. He has modes of treatment and prevention derived from the resources of modern science: heliotherapy, actinotherapy, chemotherapy, psychotherapy, endocrinology. He uses bacteriology as an aid to diagnosis, prognosis, and treatment. He watches the channels of infection. He swabs throat and nose, and checks incidence and progress by bacteriological findings. He builds up the natural immunity of the body by increasing its powers of resistance. He uses the many vaccines now at his disposal: e.g. those against anthrax, small-pox, cholera, plague, typhoid, diphtheria, and rabies, to say nothing of autogenous vaccines in any process which he may find to be infective. For purposes of diagnosis

he uses instruments of precision, illumination, and measurement (e.g. the clinical thermometer, the laryngoscope, the ophthalmoscope, the electro-cardiograph, the sphygmomanometer, the spectrum, X-rays, photography, the hypodermic needle), and laboratory tests at every turn (blood, urine, sputum, pus, cerebrospinal fluid, &c.). There are now available fine optical instruments which can be inserted into the lungs, stomach, bowel, or bladder, and thus enable the medical man to get a good view of the lining membrane. Endoscopic instruments work somewhat on the principle of the telescope, with very small lenses and prisms; and the bulb which supplies the light, though surprisingly powerful, is only about one-third of an inch long and one-sixth wide.

Preventive medicine has now brought under its control such channels of infection as water and milk. It has done an immense amount for the factory worker, reducing his hours of employment, enhancing his personal well-being, improving the factory environment, and dealing effectively with the special diseases incidental to particular employments.

Sir George Newman, the great exponent of preventive medicine, writes: "The primary health need of a community must always remain *environmental*—housing, water, air, food, workshop, drainage, sewage treatment, and the removal of refuse and nuisances. The secondary need must also be the *personal nurture*, education, and health, of the people themselves, a nurture which begins nine months before birth and is continued to the end of life. But *we cannot often do what is best*. Only an educated people is an effective people, and discipline is necessary to education. We must be content with what is practicable, remembering that magic, superstition, and empiricism are still with us and are deep-rooted; habit remains second nature; practice is held to be better than theory."

Preventive medicine has not yet abolished the three-times-a-day bottle, but such abolition can be only a question of time.

Medical Research

It was vaccination which broke down the evil spell of helplessness that for so many centuries had possessed people in the face of disease. As soon as its beneficent power became known, a wave of new hope spread right over Europe. Vaccination was the great medical achievement of the eighteenth century.

No doubt it had long been well known to the Turks that an attack of small-pox rendered the subject immune from the disease afterwards, and a report from Constantinople in 1713 that small-pox inoculation was practised there created great interest in London medical circles, especially when it became known that Lady Mary Wortley Montagu, the wife of the British ambassador to the Porte, had had her own child so inoculated, and afterwards her daughter. Thus it came about that in 1721 inoculation by slight puncture and insertion of the fluid matter from a small-pox sore was tried tentatively in London. All the cases recovered, and for a time the practice then became fairly common. In 1743, a large number of arm-to-arm inoculations were carried out, artificial small-pox being thus derived from previous artificial small-pox. The practice soon spread and in 1768 Baron Dimsdale inoculated the Empress of Russia. But it did not, by any means, always prove a preventive of the disease.

Edward Jenner (1749-1823), a west country physician who had been a pupil of John Hunter, became interested in a popular Gloucestershire belief that persons who contracted *cow-pox*, a comparatively harmless disease, were thenceforth immune from small-pox. He had actually overheard in 1768 or 1769 a young woman say, "I could not take small-pox, for I have had cow-pox."

On a tombstone in Worth Matravers churchyard, Dorset, is an inscription recording that a Dorset farmer, named Benjamin Jesty, inoculated his wife and two sons with cow-pox in 1774: "an upright and honest man particularly noted for having been the first person (known) that introduced the

Cow Pox by inoculation, and who from his great strength of mind made the Experiment from the Cow on his Wife and and two Sons." The next tombstone is that of Jesty's wife who died in 1824, fifty years after the experiment.

In 1780 Jenner expressed to a fellow-practitioner the opinion that cow-pox might prove a preventive of small-pox, and in 1789 he made the great venture and inoculated his own child, a few months old, with swine-pox matter. Later he inoculated the child on three occasions with small-pox matter, but *none of these infections gave the child the disease*. In 1796 he inoculated a child with cow-pox matter from the hand of a dairywoman who had contracted the cow-pox from her master's cows. Later he inoculated the child with small-pox virus but *the child did not get the disease*. This was the origin of "vaccination", which gradually became a practically universal method of preventing small-pox. It should be noted that Jenner did not "discover" vaccination. He *showed* that cow-pox was inoculable in man and that it could be transferred from man to man; and he *proved* that vaccination in man protected against small-pox. All the facts were already known as isolated facts but Jenner brought them together and *proved their validity*. Since his day the whole procedure in vaccination has been revised, and in place of crude vaccinia, glycerinated calf lymph has been adopted.

Jenner did not describe the micro-organism which, presumably, produces small-pox; indeed it is doubtful if that has been discovered even now. And it is rather stretching the term "research" to say that he had been engaged in it. But his work was scientifically experimental and was subsequently wonderfully fruitful, for there is no doubt that it inspired Pasteur. Vaccination may be said to have ushered in scientific experimental medicine. It spurred the workers on, and great have been the triumphs of the pioneers and masters of modern medicine during the last hundred years.

Typhus fever has been abolished; typhoid fever has become rare; tubercle is declining; potent remedies for diph-

theria, tetanus, diabetes, myxedema, and pernicious anæmia are available; and there are effective methods against rickets, dental caries, beri-beri, and scurvy. Surgery is safe and painless. In the tropics, progress is not less encouraging: the great fevers are now passing under control; plague and cholera are no longer wild beasts free to roam the world; malaria is yielding ground every year; yellow fever has been abolished in immense areas. To the medical practitioner at the patient's bedside are available the services of the masters of chemistry, physics, biology, botany, physiology, anatomy, pathology, bacteriology, biochemistry, psychology; also the services of the masters of special methods of diagnosis and treatment—surgeons, radiologists, bacteriologists, physiologists, and physiotherapists. There are also the administrators of preventive methods—public health officers, school medical officers, industrial medical officers, and medical officers of the mental hospitals. Then there are the institutions devoted to medical research, such as the Medical Research Council. The record of the last century, and more especially of the last half-century, is indeed remarkable.

There still remain to be conquered cancer, diseases of the heart and blood vessels, respiratory diseases, and rheumatism in its various forms. All of these are still baffling, and perhaps the common cold is the most baffling of all.

The *Ministry of Health* was established in 1919 and took over the powers and duties of the old Local Government Board and the Insurance Commission, and certain powers of the Board of Education. It has a large and competent medical staff, Sir George Newman being the chief medical officer. Its principal duties are, of course, administrative. The Ministry must not be confused with the *Medical Research Council*, formerly the Medical Research Committee established in 1913, incorporated under its present title by Royal Charter in 1920, and now under the administrative direction of a Committee of the Privy Council. This Council includes the leading men of the medical profession, men who, besides being practitioners of great professional distinction, are all

Fellows of the Royal Society. The Council apply, to medical research, monies specially voted by Parliament or received from private sources. In the Privy Council Committee's Report for 1931-2, it is stated that £8500 was allocated to administration expenses; £51,500 to the National Institute for Medical Research at Hampstead and the associated farm laboratories at Mill Hill; and £79,000 for research grants to scientific workers and for the expenses of their researches at the universities and at other centres, for research work in clinical medicine, and for certain other matters. In the Research Council's own Report for the same year, details are given of the year's work in Clinical Research, in Research on Disorders of the Nervous System, on Malaria, Dog Distemper, Maternal Mortality and the Study of Puerperal Fever, Iodine in Foodstuffs and the incidence of goitre, Vitamins, Virus Diseases, Bacteriophages, Malignant Diseases, minute non-Pathogenic organisms, the Chemistry of Bacteria, the Physiology of Reproduction, the Chemical Control of the Circulation, Chemotherapy, and a multitude of other subjects. The Council have over twenty Investigation Committees for special subjects, the Committees consisting of well-known specialists from the various departments of medicine and allied science. In short, the annual output of the Council's work is remarkable, as may be seen from the bare facts recorded in their successive Annual Reports.

The opposition to certain forms of laboratory research work has seriously tended to impede the advance of medicine. Unless experiments on living animals were allowed, further serious advance simply could not be made, but there are certain gifted and large-hearted men and women who oppose such experiments on the ground that they inflict suffering on the rodents and other small animals used for the purpose. But the suffering inflicted is certainly less than that of the careful, kind, and competent surgeon on his patients. As Lord Moynihan says: "Every one who has had experience of laboratory work knows how little pain is inflicted and what steps are taken to minimize or abolish it. *The experi-*

menter who excites suffering defeats his own aims, for pain changes the issue he seeks to discover. The whole vivisection campaign, though a great testimony to the tenderness of heart of its supporters, has no slightest foundation in truth, and is a witness to their shut-mindedness and credulity." Happily the Research Defence Society has done much to save scientific men from the cruelty of misrepresentation and of injustice.

With such distinguished leaders as Lord Dawson of Penn, Lord Moynihan, Sir Charles Sherrington, O.M., famous, respectively, as a physician, a surgeon, and a physiologist, the medical profession may be assured of wise guidance and the public may feel certain that inefficiency will be heavily frowned upon.

We can afford space to touch upon only two or three of the many special subjects in which medicine is now making great advances and to which all practitioners attach the highest importance.

Bacteriology

"Bacteria", "microbes", "germs", or "micro-organisms", as these creatures are variously called, are so small that it is impossible to see them except with a microscope, and even the most powerful microscopes will not enable us to see some of them. Yet as long as they are alive they (1), are using up food material; (2), are multiplying; and (3), may be producing poison. They are all single-celled creatures. A special unit of measurement has been adopted to indicate their size, viz. the *micron* (Gk. μ) which is 0.001 of a millimetre or about one twenty-five-thousandth of an inch. Many germs are 3-5 μ long; the smallest are about 0.25 μ (i.e. a hundred thousand lying side by side in a straight line would measure one inch).

It is now generally accepted that microbes arise only from previously existing microbes, and it is possible to prepare

fluids containing all that is necessary for bacterial life and keep them uncontaminated for an indefinite time. If, however, a single germ be left alive in such a fluid, or be allowed to enter it, microbic growth will at once begin and proceed at a rate that is amazing. The more common organisms grow at such a rate that they become, in the mass, clearly visible in 24 hours. A bacillus will divide into two bacilli in about 20 minutes; each new organism will at once begin to grow and, in another 20 minutes, division will begin again. If the conditions are suitable, the number of bacilli that will have been produced in any given time may be calculated thus:

After 20 minutes	the number is 2.
„ twice 20 minutes	„ „ $2 \times 2 = 2^2 = 4.$
„ three times 20 minutes (1 hr.)	„ „ $2 \times 2 \times 2 = 2^3 = 8.$
„ four „ „	„ „ $2 \times 2 \times 2 \times 2 = 2^4 = 16.$
„ six „ „ (2 hours)	„ „ $2^6 = 64.$
„ 8 hours	„ „ $2^{24} = 16 \text{ million (abt.)}$
„ 24 hours	„ „ $2^{72} = 4000 \text{ trillion „}$

Thus, although the weight of a single organism is so absolutely insignificant, it would, *if allowed complete growth*, produce in a single day 500 tons of descendants. Such a tremendous rate of multiplication has a great significance in connexion with the spread of disease, though, of course, in practice the rate could not continue very long; the food supply would soon run short, or the environmental conditions would make further growth impossible. There is the further fact that many organisms multiply more slowly, though some more quickly, than the one considered.

In any medium where bacteria flourish there is almost always an admixture of different species, spherical, cylindrical, and spiral, and it is impossible to study their specific structure until the different species are *separated*. This may be done by sterilizing a solution of agar-agar (obtained from a Japanese seaweed) to which has been added a solution of materials similar to those on which bacteria grow naturally. The solution is poured into a test-tube sloped to expose a long slant surface of the agar. When it is set, it is inoculated from a looped platinum wire which has been dipped into the fluid

containing the germs to be examined, the wire being gently rubbed over the agar surface. The organisms thus deposited will be invisible, but the growth which will have taken place in 24 hours will result in the development of visible masses or "colonies" of bacteria, each colony having developed from a single organism. By subculturing a particular colony, perhaps several times in succession, we eventually obtain a "pure" culture of a particular organism, the specific examination of which may now be proceeded with. Thus *classification* of bacteria is possible, but such classification requires much knowledge and great skill. Here we must be content to refer to the general *shapes* of the chief kinds.

The basic shapes of bacteria follow three typical models. (1) The spherical or *coccus* form (Gk. κόκκος, a berry), (2) the rod or cylindrical or *bacillus* form (Lat. *bacillus*, a rod), (3) the spirally twisted or *spirillum* form (Lat. *spira*, a spiral). Many bacteria are provided with thin whip-like appendages, projections from the protoplasm, called *flagellæ*, which, by lashing in the surrounding fluid, propel the organisms with considerable rapidity (see fig. 188).

In fission (dividing), every *coccus* passes through a *diplococcus* phase (Gk. διπλός, double), but the later stages vary. The diplococcus may develop into (1) a *Streptococcus* (Gk. στρεπτός, twisted), in which the division occurs only in one plane and the cells are held together in a row or chain by their gelatinous investments; or (2) a *Staphylococcus* (Gk. σταφυλή, a bunch of grapes), in which divisions may occur in any plane, and so will result in the formation of irregular clusters of cells; or (3) a *micrococcus* (Gk. μικρός, small), in which division occurs in two planes at right angles, and groups of four or multiples of four cocci are formed. Then there are numerous special coccus-compound terms, usually special cases of one of the three groups above mentioned, indicative of specific diseases, e.g. the *Pneumococcus* and the *Meningococcus*. A coccus, in whatever compound term it occurs always refers to some kind of *spherical* or *berry-shaped* bacterium.

Koch's "postulates" we have already referred to. Before we can safely say that a particular germ causes a disease, the germ must, according to the postulates, (1), be constantly found in the diseased parts of the body; (2), be capable of living outside the body; (3), be capable of exactly reproducing the disease if introduced into the bodies of animals or man. The fact admits of no doubt that germs do pass from one person to another and must therefore be capable of living outside the body, at least for a time. The skin itself is very resistant to the entry of germs, and normally it is only when

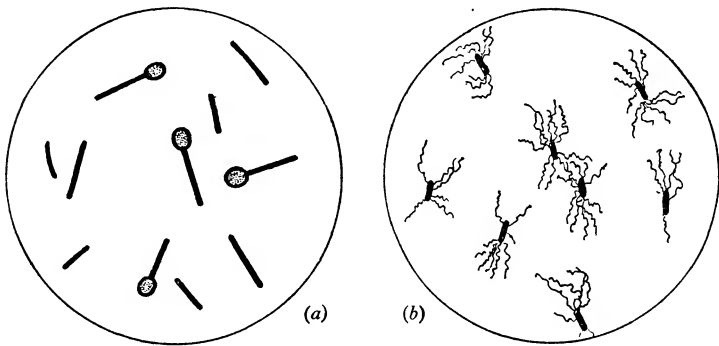

Fig. 189.—(a) Tetanus bacilli; (b) Typhoid bacilli

there is a cut, a scratch, or an abrasion that they can get through. The germ may, however, enter by a more vulnerable route, e.g. the respiratory tract (the nose, throat, the bronchi, and the lungs), the alimentary tract, and the genito-urinary tract. Moist warm conditions are highly favourable to bacteria of all kinds.

If a culture be made from a little "pus" of an ordinary "boil" and a few of the living germs be rubbed into the scratched skin of a healthy person, an abscess will be formed exactly like the original boil. The disease has been exactly reproduced, in accordance with the requirements of Koch's third postulate.

Some germs invade the body and spread throughout the

tissues, causing disease or death by their actual presence in the body. Others produce a poison—a “toxin”—which enters the blood-stream and conveys it to all the tissues; disease or death is thus due to the action of the toxin.

But man has developed a strong natural resistance to germ invaders, and he always puts up a serious defence when they attack him. The blood consists not only of fluid serum but of red and white corpuscles, and it is the white corpuscles that are the great enemy of invading bacteria. These white corpuscles or “leucocytes” have now been given the special name, “poly-morpho-nuclears”, because the nucleus is multilobed. Their ordinary function is to act as blood-scavengers—to engulf and digest small particles of waste and foreign matters in the blood. They are capable of penetrating the walls of the blood-vessels into the spaces in the tissues. When bacteria enter a wound, the white corpuscles make their way thither, and act as rudimentary cannibals (their technical name while thus acting is *phagocytes*, Gk. φαγεῖν, eat; κύτος, cell), seizing upon and eating up the bacteria within their reach; but if the bacteria multiply more rapidly than the phagocytes can ingest them, they may penetrate to other parts of the body and cause, e.g., abscesses. If the phagocytes gain the upper hand, they help to form new tissue to heal the wound, from which the dead corpuscles and bacteria are discharged as a yellowish mass known as “pus”.

But there are some diseases in which the invading bacteria are not attacked by the white corpuscles. Even so, the sufferer often recovers by producing special “anti-bodies”, substances which destroy the invading bacteria; and medicine has now learnt how to promote the production of these anti-bodies and so to hasten recovery.

We have seen that there are two factors involved in the production of disease by micro-organisms: (1), the multiplication of the organisms themselves; (2), the production by the organisms of poisonous substances called toxins. Toxins have now been specially prepared from disease organisms by

filtering the bacteria away from their fluid cultures and thus obtaining a bacterium-free liquid containing the poisonous bacterial products. This was the starting-point of the scientific study of toxins.

It has long been known that organisms thus cultivated outside the body may lose their virulence. Pasteur found this for chicken cholera, and he also found that such "attenuated" cultures, when inoculated, protect against the disease. It has since been found that the same kind of immunity which is produced by administering attenuated cultures is sometimes given even by *dead* cultures. Nearly all active immunization is therefore effected by inoculating with such killed cultures. These are usually called *Vaccines*, from the analogy which they bear to vaccination (Lat. *vacca*, a cow).

Artificial immunity is of two kinds, active and passive. *Active immunity* is produced directly by the injection of disease organisms or their products. But it is found that if a high degree of immunity be obtained, the blood-serum of the immunized animal when injected into a second animal may itself produce a state of immunity. This indirectly produced state is described as *passive immunity*. The fact that immunity can thus be transferred by the serum proves that the immunizing serum contains substances antagonistic to the bacterium or toxin against which immunity is desired. These antagonistic substances are the *Antibodies* already referred to. Antibodies are now receiving much attention, and with further knowledge of them our views of the nature of disease may become profoundly modified.

An *antitoxin* is a kind of antibody, produced as a reaction against certain types of poison. One of the best known of the bacilli is that which causes diphtheria. Its growth is generally confined to the throat, but it liberates into the blood a toxin which is particularly dangerous to the heart. If a man has had diphtheria, this toxin is no longer poisonous to him, and, what is more, if some of his blood-serum is mixed with the toxin it renders the toxin harmless when injected into someone else. In practice, dead diphtheria

bacilli are injected into a horse, so that the horse develops antitoxin without having had a sore throat. The antitoxin now contained in the horse's blood will protect human beings against the toxin. In some way which we do not fully understand the antitoxin puts the toxin out of action. Few bacteria, however, kill in the simple way that the diphtheria bacillus does, and thus few diseases can be cured by antitoxins.

Readers specially interested in the subject of immunity should make themselves acquainted with the work of *Emil von Behring* (1854-1917), the Prussian army surgeon; the Japanese *Shibasaburo Kitasato* (b. 1860), a pupil of Koch; *Alexandre Yersin* (b. 1863), a pupil of Pasteur; *B. Shick*, of Vienna; *Waldemar Haffkine* (b. 1860), a pupil of Pasteur; *Paul Ehrlich* (1854-1915), of Frankfurt; *August von Wassermann* (b. 1866), Ehrlich's pupil; and *Fernand Widal* (b. 1862), the French investigator.

There are certain diseases caused by agents too small to be seen even by the most powerful microscope. Objects less than 0.1μ in size cannot be "seen" by a microscope because they are shorter than the wave-length of visible light. The small bodies in question are collectively known as "viruses". They are "filter passers", i.e. they will pass through the pores of even such a fine wave filter as that made by Chamberland. It is only when the very finest collodion filters are used that any viruses show they possess "size", since they cannot pass through such a medium. And yet they do not appear to grow in culture media. About 100 infections are believed to be due to them, including influenza, foot and mouth disease, dog distemper, and perhaps cancer. Are any of them particulate? i.e. have they some sort of individuality? May they not be merely unorganized infective toxic material, compelling the cells attacked to create the agents of their own infection?

A mysterious agent which has the power of attacking the larger bacteria is the *Bacteriophage*. It seems to have some of the characters of a filterable virus. When introduced into

a culture, it causes the bacteria to liquefy and disappear! But whither? The bacteriophage probably has a future!

Notable workers in connexion with the bacteriophage are **d'Herelle** and **F. W. Twort**. For d'Herelle, the bacteriophage is a particulate living organism, a parasite of the bacteria, for which he coins the term *protobe*, against whose living nature he will hear nothing. As Professor **J. H. Dible** puts into d'Herelle's mouth:

“ Great fleas have little fleas
Upon their backs to bite 'em,
And little fleas have lesser fleas,
And so *ad infinitum*.” *

Chemotherapy, or the destruction of bacteria within the body by chemicals, also seems to have a future. To **Ehrlich** is due the credit of the idea that it might be possible to discover a drug fatal to a micro-organism but harmless to the tissues of the body. It was he who after 606 trials discovered that remarkable arsenical compound “salvarsan” which is so very effective against spirochætal diseases, such as syphilis and yaws.† The search for other drugs is being pursued.

Estimates of the sizes of certain particles have been made by various authorities ($1 \mu\mu = .001 \mu$; $1 \mu = .001 \text{ mm}$; hence $1 \mu\mu =$ one twenty-five-millionth of an inch).

Hydrogen molecule	$0.16 \mu\mu$.
Starch molecule	$5 \mu\mu$.
Albumin molecule	$4-10 \mu\mu$.
Bacteriophage corpuscle	$20-30 \mu\mu$.
Virus units	$25 \mu\mu$.
M. prodigiosus	$500 \mu\mu (=0.5 \mu)$

* Dible quotes this from De Morgan's *Budget of Paradoxes*. But long before De Morgan's time, Swift had said (Poetry: A Rhapsody):

“ So naturalists observe a flea
Has smaller fleas that on him prey,
And these have smaller still to bite 'em,
And so proceed *ad infinitum*.”

† The chemist's name for salvarsan is, dioxy-diamino-arseno-benzol-dihydrochloride, and he generally writes the name without hyphens!

The diameter of the smallest particle visible under a good oil-immersion lens at full aperture is about 0.074μ when it is illuminated by white light. Although the ultramicroscope permits us to recognize particles as small as 0.005μ ($=5\mu\mu$) it only shows diffraction images, all small particles appearing indifferently as illuminated granules, and no information being conveyed as to their structure and form. The estimates of the sizes of viruses are usually based on filtrability.

A substantial advance has been made in our knowledge of bacteriology during the last few years, especially in connexion with rheumatism and scarlet fever, pneumonia, diphtheria, and tuberculosis, but most of the virus diseases still remain defiant, especially the common cold, influenza, measles, and cancer. The discovery of the causation of the last named seems to be as far away as ever, despite the intense and highly intelligent research of the last few years.

The most noteworthy recent advance is in connexion with dog distemper. Definite proof was obtained that the disease is due to a filter-passing virus, and it was found possible to produce (1) *Virus*, containing the living organisms of the disease and capable of severely infecting a susceptible animal; (2) *Vaccine*, containing the killed organisms of the disease; and (3) *Anti-serum*, from the blood of an animal that had itself been made strongly immune by repeated administrations of virus. It was found that a healthy dog could be given lasting protection against distemper infection by the introduction of vaccine followed by inoculation of virus a fortnight later; and it was also found that the anti-serum was of value in lessening the severity of an attack.

Tropical Medicine

The increase in the inhabitability of the Tropics may be traced to two main causes: (1), the application of the ordinary laws of hygiene; (2), our increasingly exact knowledge of the microbic origin of tropical diseases. Certain diseases have

now receded from settled temperate countries, e.g. malaria, plague, typhus, leprosy, and dysentery, and have come to be regarded as more or less distinctively "tropical" diseases. But there are other diseases which are tropical in the sense that they have never visited temperate countries, e.g. yellow fever, sleeping sickness (trypanosomiasis), beri-beri, dengue, kala-azar, and a host of others. In recent years, not only have the actual causes of many of these diseases been discovered, but also the ways in which they are transmitted, methods of prevention, and drugs which will effect cures.

The head-quarters of the Royal Society of Tropical Medicine and Hygiene is Manson House, named after Sir **Patrick Manson** (1844-1922), whose early researches really led to the first discoveries in tropical disease. He began working in China on filariasis, and it was he who first definitely associated a human disease with the mosquito. Returning to England, Manson was greatly perturbed that there was no sort of place where medical men who wished to practise in the Tropics could be specially trained in tropical diseases. He approached Mr. **Joseph Chamberlain**, the well-known statesman of the 'nineties, who helped him in his project to set up the necessary institution. The result was the founding of the Liverpool School of Tropical Medicine and shortly afterwards the London School of Tropical Medicine.

Two names are always associated with this early research work, Manson, and Sir **Ronald Ross** (1857-1932). It was at this time that Manson met Ross and explained to him his view that malaria was probably transmitted by mosquitoes. Ross had previously been working in India, and when he returned there he found definite proof that malaria was thus transmitted. Figure 190 shows the life-cycle of the micro-organism which acts as a parasite in the mosquito and is ultimately responsible for malarial disease. The whole discovery, "the greatest piece of individual observation in the history of medicine", was made by Ross,

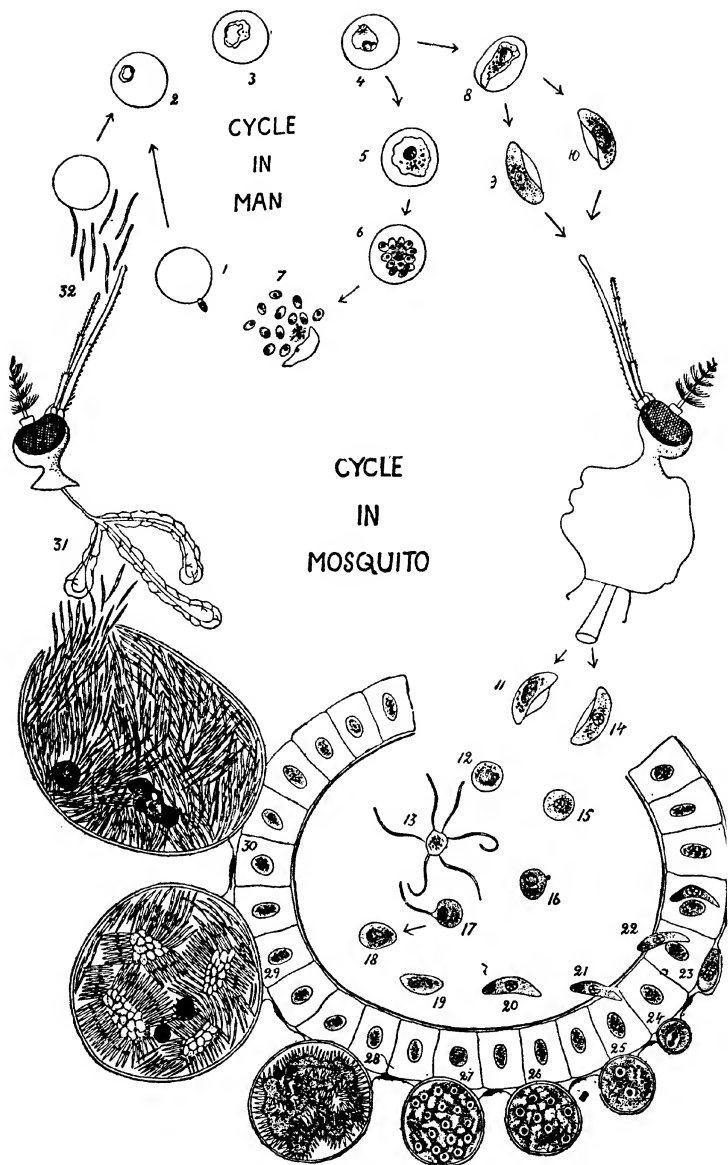

Fig. 190.—The Life-History of the Parasite of Malaria (for description, see opposite page)

and it was for this that he received the Nobel prize. His toil had been unremitting. He had examined, microscopically, so many types of mosquito that his eyesight threatened to fail; yet he had achieved nothing. None of these insects showed in their tissues or organs the parasite of malaria for which he was seeking. When he was quite worn out, a mosquito of a type quite new to him by chance alighted on his bench, and others of the same type were then obtained. A few days later Ross's microscope showed him in the bodies of these new flies the organism for which he had searched so long, and the subsequent tracing of its life-cycle was only a matter of time.

The next advance was made by Sir **David Bruce** (1855-1931), an English military surgeon who discovered that *nagana* was due to a trypanosome which was carried by the tsetse fly. It was then discovered that *sleeping sickness* was also due to a trypanosome carried by the tsetse fly.

Fig. 190.—The life-histories of the parasites of the malarial diseases of man have been completely traced. The parasites run through a double cycle, one in man and the other in the mosquito. In the diagram the cycles of only one species are represented; there are, however, two other special malarial parasites in man.

On either side the head of the mosquito involved is diagrammatically shown, just below the "cycle in man".

In man the parasites conveyed by the bite of the mosquito (32) or formed by a division of a parasite already in the blood (7) make their way into the red blood corpuscles (1 and 2), develop there (3 and 4). Some of them ultimately divide to go through the same cycle (5, 6, 7 and back to 1, 2). The process of division corresponds to the period of fever. Others develop into crescent-shaped bodies (8, 9, and 10), which can be differentiated into two slightly different forms corresponding to two sexes (9 male, 10 female). These, if sucked up by a biting mosquito of the right species, pass into the animal's stomach where they develop further (11, 12, 13 male; 14, 15, 16 female), and end by dividing into forms which conjugate (17). The resultant of this conjugation or union of the two sexes (17) develops into a lanceolate form (18, 19, 20) which passes into the cells of the mosquito's stomach (21, 22) and finally penetrates these cells (23). The parasite then secretes a cell-wall and forms a "cyst" (24), which enlarges (25). The enlargement continues while the nucleus breaks up (26, 27, 28). In the cyst, which is still growing, a large number of needle-like forms develop, each of which contains a fragment of the nucleus (29). Finally the cyst bursts (30), the needle-like forms are cast forth into the body of the mosquito, and ultimately lodge in her salivary glands (31). When the mosquito bites another man, she injects some of her saliva into him through her proboscis. Thus she infects his blood with some of the needle-shaped parasites that lurk in her salivary glands (32). So the cycle is re-enacted again and again. We may note that to prevent this process of repeated reinfection it is only necessary to break either cycle at one point. Thus destruction of mosquitoes or of their breeding-places will suffice, or, again, protection of human hosts from bites of mosquitoes will be sufficient. Either process, if persisted in, will lead to the extinction of the parasite in the region under supervision. In England both methods have been in operation, and the disease is almost extinct there so long as any of the malarial mosquitoes remain in one district. However, the disease can always be reintroduced by the introduction of subjects of malaria from without.

(From C. M. Wenyon's *Protozoology*, Vol. II, by kind permission of Messrs. Baillière, Tindall and Cox. Slightly reduced in size.)

Millions of people in India have died from *kala-azar* (black fever), but it is now known that the disease is carried by the sand-fly. Antimony treatment has proved highly beneficial. A previous mortality of 95 per cent has been converted into a recovery rate of 95 per cent. The story of the suppression of *yellow fever* in the Panama zone and in the West Indies is well known; the disease has been proved to be invariably due to the bite of a domestic mosquito which carries the disease-producing parasite. In the case of *plague*, the rat-flea is known to be the carrier of the infection; an anti-plague serum has now been prepared. *Cholera* is a water-borne disease: no less than two million doses of cholera vaccine were issued in Bengal in 1928. *Leprosy* is due to *Bacillus lepræ*; hydnocarpus oil has now been found to effect a cure in the early stages, and a large number of advanced cases have apparently also been cured.

Many workers are now concentrating on discovering methods of exterminating the various vectors. Exterminate the rat, you exterminate the rat-flea and therefore the plague. Exterminate the mosquito, you exterminate both yellow fever and malaria. Unfortunately, backward peoples cannot be induced to co-operate with peoples more advanced. It will be a very long time before, say, the last mosquito bids his final good-bye.

Radiology

It is nearly forty years since **Röntgen** first obtained (in 1895) a radiogram showing the bones of his hand by interposing the hand between an X-ray tube and a sensitized plate. Almost at once X-rays were used as an adjunct to medical practice, though even now the subject of radiology has barely reached adolescence. A vast amount of research has still to be done.

There are two main divisions of the subject: (1) radio-diagnostics; and (2) X-ray and radium therapy.

In the early days the radiologist had to be a good tech-

nician, able to produce good negatives with apparatus of limited power, and able to interpret the series of superimposed and over-lapping shadows on the X-ray plate. But during the last ten years progress has been so rapid that practically all technical difficulties have been overcome and excellent X-ray negatives are easily produced. At the same time, all danger to both operator and patient has been minimized. The tragedies of the past can hardly recur if the suggestions made by the X-ray and Radium Protection Committee are duly observed. But the problem of interpreting the shadows on the fluorescent screen and X-ray film still remain difficult. A sound training is necessary if the radiologist is accurately to correlate the shadows with the clinical and pathological findings. We may give a brief summary of the contribution made to *Recent Progress in Radiology*, by Dr. J. M. Woodburn Morison, Director of the Radiological Department of the Cancer Hospital and Professor of Radiology in the University of London.

Radio-diagnostics. This is merely a study of contrasting shadows; a metal ring on a finger gives a denser X-ray shadow than the bones within; the bones give a denser shadow than the surrounding flesh. Shadows of bones imprint themselves on the sensitized plate readily enough, but when we want to obtain a shadowgraph of the softer tissues we have to introduce into the body a substance which will give them a relative opacity. The radiological study of bone lesions and of *ostitis fibrosa* has now been placed on a firm basis, and attempts have been made to study the joints by contrast methods, gas being injected for the purpose. The bismuth or barium meal for the diagnosis of the gastrointestinal tract has been an established principle for several years, and more recently methods have been devised by means of which mucosal surfaces can be coated with a small quantity of opaque solution, relief pictures of the mucous membrane being thus obtained. It is now possible to obtain a radiogram of the gall-bladder, success being due to the

discovered pharmacological action of some of the phthalein salts; a correct diagnosis has been made in 95 per cent of cases of gall-bladder inflammation, with or without gallstones. The urinary tract may now be outlined by the intravenous injection of an iodine compound, a method due (in 1928) to von Lichtenberg of Berlin. Arteriography has not made much progress, though sodium iodide and iodized oils have been used for the purpose; there are certain dangers associated with these substances. A substance which has met with considerable success as an opaque contrast medium in radiographic diagnosis is *lipiodol*, a true chemical compound of iodine and poppy-seed oil containing 40 per cent of iodine by weight, the high iodine content making it particularly serviceable. It has been used to explore many different regions of the body, especially the nervous system and the respiratory tract. In the radiographic examination of the bronchi, it now has an established place. *Thorotrast*, a thorium salt, is another substance sometimes used; it gives a very dense shadow. It is, however, one thing to introduce chemical substances into the body; it is quite another to get them eliminated.

X-ray and radium therapy. X-ray treatment and radium treatment have the same physical basis, and it is illogical to separate them. Many cases of disease, both malignant and non-malignant, can be treated equally well by either X-rays or radium, and in some cases a combination is advisable. Great improvements in X-radiation apparatus have made it possible to produce higher voltages and to treat patients with greater intensities. Few patients can stand a "massive" dose at once, and the dose is commonly split up and administered daily or at longer intervals. The aim, of course, is the destruction of malignant activating cells, and it has been found that prolonged irradiation on such cells is more effective than the massive single dose. Recently X-rays have been produced at very high voltages, and it is now possible to produce a beam with an average wave-length comparable to

the gamma radiations of radium. Whether X-rays and gamma rays produce exactly the same biological effect is uncertain.

In the early days, radium therapy began with surface applicators. This was followed by the introduction of tubes into the tissues. Then followed screened needles, then small capillary tubes of radon, and finally the radium "bomb". The day of radium needles is virtually over: continental radiologists dislike them. The radium bomb is limited to regions which are fairly accessible, chiefly cancer of the tongue, larynx, and pharynx; but such bombs are very costly, and few are available; and with one 5-gram bomb only about 200 cases could be treated in a year.

X-ray and radium therapy extends far beyond the treatment of malignant disease, e.g. to exophthalmic goitre, to enlarged thymus in children, to the septic tonsil, to some chronic inflammatory skin disorders, to chronic arthritis, and to the production of an artificial menopause—a simple and easy method of sterilization.

The deep-seated malignant tumour is the most difficult problem, for it seems impossible to irradiate it, either by X-rays, or by radium, or by both, in such a way as to destroy every malignant cell.

Biochemistry

Biochemistry is that section of chemistry which investigates the chemical changes and the products evolved in the life processes of plants and animals. It includes the investigation of living matter and the chemical processes of life and death. It is concerned not only with the composition of the substances found in the organism, but also with their method of manufacture.

The founder of biochemistry was really **Lavoisier**, who showed for the first time that the life-processes of the animal body can be investigated by chemical means; but it was the great German chemist, Baron **Justus Liebig** (1803-73), who put the subject on firm foundations, for, "amongst the

ever-varying manifestations of life, he traced the operation of a few laws, physical and chemical, affording, by their combination, the precise and proved conditions of vital development, nutrition and growth." In 1828, **Friedrich Wöhler** (1800-82) announced the synthesis of the typical animal product, urea, from inorganic materials. Soon afterwards **Claude Bernard** is supposed to have slain the "vital principle" by his brilliant researches in experimental physiology, and **Pasteur** revealed some of the chemical changes that occurred in fermentation, putrefaction, and disease. Other valuable researches in plant and animal chemistry were prosecuted in the latter half of the nineteenth century, and in 1912 the Biochemical Club, now the Biochemical Society, was founded.

Progress in biochemistry has been dependent to a large extent on the rate of advance of our knowledge in organic and physical chemistry. For instance, a large proportion of the solid material of cellular contents is composed of complex nitrogenous substances known as proteins, and no satisfactory theory regarding their significance in living cells could be advanced until information concerning both the molecular structure of proteins and their physical properties as colloids had been obtained. It was the German chemist **Emil Fischer** (1852-1919), Professor of Chemistry at Berlin, who revealed the nature and structure of the very complex protein molecule, and since then Biochemists have been attacking, with very substantial success, the major question concerning the rôle of the proteins in the living cell. It is generally considered that 1910 marks the beginning of the second phase of biochemistry, i.e. its entry on the stage as a definitely systematized branch of science. It takes account of such processes as assimilation, respiration, reproduction, growth and development, movement, secretion and excretion.

The study of *assimilation* by the animal is largely a study of the break-down, or *metabolism*, as it is called, of the food-stuffs that are ingested by the organism to supply the mole-

cular units required to construct or maintain its tissues. It entails an examination of the mode of action of the remarkable catalytic agents possessed by certain living cells and termed *enzymes* or *ferments*, by means of which the complex molecules of the proteins, polysaccharides, and fats, are broken down, so that the simpler molecules of amino-acids and sugars can pass through the absorbing membranes of the alimentary canal.

There are many ordinary chemical reactions which, alone, proceed at a very slow rate. By the addition of minute quantities of certain inorganic substances, termed "catalysts", the rate of such reactions may be tremendously increased. *Enzymes* may be regarded as catalysts of biological origin which are formed in all living cells. They enable the cell to carry out at a sufficient speed the chemical processes necessary for its existence. In many cases the enzymes act within the cell, but in others they are discharged from the cells which form them and carry out their particular changes outside the cell. For instance the enzyme *ptyalin*, elaborated in the salivary gland cells, is discharged into the mouth where it commences its action on the starch of the food. Enzymes show great specificity; a given enzyme will act on one substance only and has no effect on any other. They are active in extremely small amount; e.g. the enzyme *invertase* can hydrolyse one million times its weight of cane sugar, without appreciable loss of activity.

The process termed "digestion" consists essentially in changing colloid food substances into crystalloid bodies, since in the latter condition they can dissolve in the fluid of the alimentary canal and then diffuse through the mucous coat into the blood vessels or lymphatics. The change is brought about by the digestive juices which are elaborated in the digestive glands, e.g. saliva in the salivary glands, gastric juice in the gastric glands, pancreatic juice in the pancreas. Each digestive juice is activated by its contained enzyme: saliva by *ptyalin*, gastric juice by *pepsin*, pancreatic juice by *trypsin*; and so forth.

The actual chemical structure of enzymes is doubtful, though Professor **Willstätter** of Munich and Professor **Waldschmidt-Leitz** of Prague have recently been working out methods for extracting them from biological material. But the amount present in such material is almost vanishingly small. And yet the efficiency of an enzyme is almost unbelievably great!

As far back as 1912, the present distinguished President of the Royal Society, Sir **Frederick Gowland Hopkins** (*b.* 1861), suggested, after a long series of experiments, that in addition to the ordinary components of a regulation diet, viz. proteins, carbohydrates, fats, salts, and water, which up to that time had been accepted as the complete admixture for the perfect nutrition of the body, some other material was required, and he termed the unknown substance or substances *accessory food factors*. Further research by numerous workers has shown that disease and premature death occur unless such accessory substances, now called **vitamins**, are included in the normal diet. These are found in living organisms but in such minute quantities and are so readily destroyed that their isolation is extremely difficult if not impossible. As they have not yet been isolated and analysed, they have been provisionally called A, B, C, D, and E, a nomenclature suggested by the American biochemist, **Collum**.

Apart from the recent work of **Rosenheim** and **Webster**, **Windaus**, and **Hess**, on vitamin D, and of the Hungarian, **Szent-Györgyi**, on vitamin C, little or nothing is known of the chemical nature of these elusive accessory factors. Moreover, apart from D and B, no such material of a high degree of potency has ever been isolated even by the finest of chemical technique. Hence the activity and even the existence of the substance can only be postulated when they are absent. If, however, we can discover a food which will definitely not only prevent but also cure a particular disease, we may be quite certain that in that food there is a specific substance of *some* kind, even if we cannot isolate it. And by comparing

different foods that will produce the same positive result we can form a fairly shrewd guess as to the general nature of the substance which is thus functioning.

The main facts about the vitamins may be summarized:

1. *Vitamin A*. Necessary to prevent rickets, a disease in which calcification of the bones is deficient. It is present in butter, milk, cheese, beef and mutton fat, eggs, water-cress, maize, carrots, bananas, and tomatoes.

2. *Vitamin B*. An anti-neuritic vitamin. It is present in the husks of cereals and therefore in oatmeal and brown bread; also in white bread made with yeast.

3. *Vitamin C*. An anti-scorbutic vitamin. It is abundant in the tomato, and is present in oranges, lemons, grape-fruit, water-cress, lettuce, etc.

4. *Vitamin D*. The anti-rachitic vitamin. It often accompanies A and is thus found in animal fats, butter, milk, fish, oils, etc. Exposure to light compensates for a reduced amount of the vitamin. Rays of short wave-length seem to act by producing a synthesis of the lacking substance. The substance called ergosterol is a powerful absorbent of ultra-violet waves, and by adding irradiated ergosterol to such foods as margarine, the nutritive quality is greatly enhanced.

5. *Vitamin E*. Essential to fertility. It is present in oil of the wheat germ, and perhaps in milk products.

A great deal of important work has recently been done on Vitamin D. For instance, Dr. Leslie J. Harris of the Nutritional Laboratory at Cambridge has shown that the mode of action of this vitamin is not by promoting calcification in the bones but by maintaining the constant level of calcification and phosphorus in the blood. Again, although calciferol, a substance of intense biological activity, obtained by the action of ultra-violet rays on the inert substance ergosterol, shows very intensely the specific anti-rickets activity of the natural vitamin D, it has been obtained in pure form *only* by the artificial irradiation of ergosterol, and there is no chemical evidence directly identifying it with the natural

vitamin, which, however, Dr. Callow and Mr. Webster are now trying to isolate by using material in which the vitamin has been concentrated from cod-liver oil.

Professor Albert Szent-Györgyi of Szeged in Hungary, who has long been specially interested in the oxygen-reduction systems of animal tissues, was led, while working at Cambridge, to attempt the isolation of the substance responsible for the highly reducing properties of the adrenal cortex. He successfully obtained it from the gland in crystalline form, and afterwards separated it from orange juice. Its presence in the latter, and certain of its properties made him suspect from the first that it might be related to vitamin C, but the amount available at the time was too small for successful biological tests. Going to America he was able to prepare it in larger amounts, and returning to Hungary he soon became convinced that the substance possessed strong anti-scorbutic properties, and it is now called *ascorbic acid*. Believing that it was related to carbohydrate, he wisely sought the help of Professor W. N. Haworth of Birmingham, and it was found that ascorbic acid is a relatively simple derivative of a sugar; it is the lactone of a six-carbon acid with a five-numbered ring. It now seems certain that the exact nature of vitamin C will soon be discovered.

We still have much to learn about vitamins, and "we are in danger at the present time of ascribing properties and functions to an increasing series of unknown factors, and of postulating the presence of such factors before we have exhausted the potentialities of the known."

The Bio-chemist and "Life"

We have already referred to the Presidential address delivered at the Leicester meeting of the British Association in 1933. In the course of that address, Professor Gowland Hopkins reminded his listeners that during the century of the Association's existence the pendulum had swung back-

wards and forwards between frank physico-chemical conceptions of life and various modifications of vitalism, though it was true that, just at present, sounds of the long conflict between materialists and vitalists were seldom heard. For himself he claimed that a description of the chemical aspects of life must contribute to any *adequate* description, though by that he did not imply that a living organism is *no more* than a physico-chemical system; what it did imply was that an organism, at a definite and recognizable level of its dynamic organization, can be logically described in physico-chemical terms alone. But "before we assume that there is a level of organization at which chemical controlling agencies must necessarily cease to function, we should respect the intellectual parsimony taught by Occam,* and be sure of their limitations before we seek for super-chemical entities as organizers. There is no orderly succession of events which would seem less likely to be controlled by the mere chemical properties of a substance than the cell divisions and cell differentiation which intervene between the fertilized ovum and the finished embryo. Yet it would seem that a transmitted substance, a hormone in essence, may play an unmistakable part in that remarkable drama." The President admitted that the psychophysical problem is often in our thoughts, but its existence did not justify any pre-judgments as to the value of any knowledge of a consistent sort which the material systems may yield to experiment.

The study of hormones when they are produced by the living organism itself, and of vitamins when they are absorbed from an extrinsic source, has undoubtedly reformed our conceptions of vital processes. Hormones and vitamins—the distinction between them is one of place of origin rather than of chemical nature—act as catalysts, and each hormone and each vitamin are highly specific in structure, serving only a single function, each "fitting its duties as a key fits a lock."

* William of Occam (d. 1349) was an English Franciscan, a pupil of Duns Scotus. His maxim, known as Occam's razor, is well known: "*Entia non sunt multiplicanda praeter necessitatem.*" (Occam or Ockham is in Surrey.)

Collectively they determine the direction and the sequence of events in the normal processes of growth and development. They behave in the living tissues exactly as their artificially synthesized models behave in the laboratory. So far there has been no trace of any modification due to an unknown principle of life.

Not all bio-chemists are so cautious as Sir Gowland Hopkins. Some of them seem to think that the secret of life will ultimately be traced back to the expanding, contracting, palpitating, individual protein molecules themselves. Let it be granted that hormones are the organizers of all bodily activities: but what is the organizer of the organizers? Are the hormones controlled by hormones of their own? And are these hormones, in their turn, themselves organized? and so on indefinitely. Is not this elusive, final chemical organizer, which the bio-chemist believes he will some day run to earth, as much a "super" chemical organizer as any "entelechy" yet invented by a vitalist? and just as likely to be badly cut by Occam's razor? It is a curious fact that the most far-reaching mechanistic views are now being put forward by biologists. According to Professor **Lancelot Hogben**, for instance, "we may look for a complete solution to the nature of life within a mechanistic framework," though most people find it very difficult to grasp the associated concept of a "co-ordinated series of self-regulating and self-propagating chemical reactions."

Much more cautious views are advanced by most physicists and chemists, and even by some prominent biologists. The Cambridge zoologist, Dr. **James Gray**, for instance, in his British Association address at Leicester, 1933, considered it more logical to accept the existence of matter in two states, the animate and the inanimate, as an initial assumption. Some properties are naturally common to matter in either state, and it is therefore legitimate to study the so-called physical properties of living matter; but just as the fundamental properties of physics are based on observational facts, so those of biology must conform to the same conditions."

"I am inclined to think that the intrinsic properties of living matter are as mysterious and fundamental as the intrinsic properties of the molecule of a radio-active substance; when the physicist can tell us why one particular molecule explodes and why another goes on existing, we can begin to consider the possibility of defining the fundamental properties of living protoplasm in physical terms. . . . The existence of life must be considered as an elementary fact that cannot be explained but must be taken as a starting-point in biology." Such an attitude is eminently logical and reasonable, and, at all events at present, the bio-chemist has no alternative but to adopt it.

Endocrinology

Endocrinology (Gk. ἔνδον, within, κρῖνειν, to separate), is sometimes regarded as a part of biochemistry, though it is becoming so highly specialized that it is now often looked upon as an independent subject. It is concerned with the secretions of the ductless glands.

Certain glands of the body deliver their secretions by means of a duct, e.g. the salivary glands, the liver, and the pancreas. Others have no duct and they discharge their secretions directly into the blood stream: such glands are known as the ductless or endocrine glands, or glands of internal secretion, and they include the *thyroid* gland, the *parathyroid* glands, the *pituitary* gland, the *suprarenal* glands, *Langerhans' islets* of the pancreas, and some others. From these ductless glands of internal secretion, various potent chemical substances have been isolated, *thyroxin* from the thyroid gland, *pituitrin* from the pituitary gland, *adrenalin* from the suprarenal glands, and *insulin* from the islets of the pancreas. These substances are characterized by the property of serving as chemical *messengers*, produced in one organ and carried by the blood to another, where their effect is manifested. They thus bring about by means of the blood a chemical correlation of the activities of the organism, a correlation not entirely dissimilar from the function of the

nervous system. To substances of this nature, **Bayliss** and **Starling** gave the name "Hormones" (Gk. ὁρμῶν, excite, stir into activity). This kind of chemical correlation is more primitive than that of the central nervous system and in the lowest animals it was the first to appear.

The evidence for assigning endocrine function to a particular organ is obtained by two methods: (1) the observation of changes resulting from the partial or complete removal of the organ, either experimentally or by disease; (2) the observation of the effects produced by administration of various extracts of the gland. Information of the first kind dates from the introduction of castration, probably as a religious rite, millennia ago; that of the second type from the work of **Schäfer** and **Oliver** in 1894.

The principal endocrine disturbances manifested as Graves' disease, myxœdema, tetany, acromegaly, Addison's disease, diabetes mellitus, and others, are far better understood now than ever before. The effects of thyroid extract or thyroxin in myxœdema, of iodine in the prevention of colloid goitre, of surgical removal of part of the thyroid gland in exophthalmic goitre, of insulin in diabetes, are brilliant examples of therapeutic successes in endocrine domains. But the administration, by unskilled practitioners, of endocrine products, either singly or in the form of different "polyglandular formulæ", encouraged perhaps by ignorant and unscrupulous vendors of such products, is strongly to be deprecated. Endocrine therapy is above all things a subject for the skilful specialist.

Of the many recent advances made in endocrinology, not the least interesting are those in our knowledge of the *pituitary*, "the leader of the endocrine orchestra", a very small well-concealed body in the base of the brain, "the very mainspring of primitive existence". Acromegaly has long been known to be somehow associated with disease of the pituitary; it is now known to be due to the eosinophil cells in its anterior lobe. If the overgrowth occurs early in life, it leads to gigantism. But lack of eosinophil secretion will lead to failure

of growth, and in some cases to an extraordinary degree of premature senility. In his contribution on endocrinology, to "Recent Progress in Medicine and Surgery", the Regius Professor of Physic in the University of Cambridge, Dr. **W. Langdon Brown**, deals at length with numerous features of great interest to all medical practitioners.

The body is a vast machine, or rather a vast assemblage of different machines, every cell a perfect physical, chemical, and biological laboratory, all working together with a perfection that no man-made machinery can ever hope to equal. The healthy body receives food from outside, takes it to pieces, reassembles it in scores of different ways, manufactures just enough but no more of all these new products, sends one here, one there, another somewhere else, all to do its allotted work; and all these factories and machines co-operate together, help one another, reinforce one another, and constantly call for one another's help and receive instant response. How is this amazing co-operation and integration brought about? The brain and its telegraphic system of nerves do much; the enzymes also do something; so do the hormones. But *how*? The knowledge we have so far gained of all these things is of the most superficial and fragmentary character, and to the question "how?" we are bound to answer that *we do not know*.

British Medical Training

For centuries the leaders in British medicine and surgery have been the envy of the world. By their foreign confrères they have always been adjudged to be men of great knowledge, to be highly skilful professionally, to be gifted with a keen insight into human nature, and to be foremost in research. But the rank and file have never been adjudged so favourably. In the Middle Ages, the ordinary medical practitioner was notoriously incompetent, and even now he does not seem to have "caught up" with his continental brother. It is, however, hardly to be questioned that the

training given in the best of our hospitals is, considering the short time available, unexceptionable. The real trouble is that the training is nothing like long enough. This is the essence of the common reproach of our continental friends who maintain that the greater skill of their ordinary practitioners is the result of a training two or three years longer than is customary in this country.

In his Romanes lecture, 1932, Lord Moynihan described the early training of the medical student as "notoriously defective"; "We train the powers of observation in our students; we neglect to teach the value of reason and relevant experiment." We can hardly expect the ordinary practitioner to be trained to become an expert either in bacteriology or in radiology, or in endocrinology, or in neurology, or in oto-rhino-laryngology, or in ophthalmology, or in specialist surgery: these subjects are admittedly subjects for specialists. But we do expect him to have had a sound laboratory training in physical science, to have been trained to reason logically, to have been trained to analyse the infinitely complex picture presented to him as a clinician. He will, of course, be trained to become a physician and surgeon, but if in these things he is not to become a mere empiricist, a rule of thumb worker, if his mind is not to be sterilized by monotonous exercise within a narrow province of static knowledge, he must be a sound physicist, chemist, and physiologist, a skilled clinician and diagnostician, an irreproachable logician, and must be for ever thirsting for new knowledge of a professional kind. Is it too much to ask that his training shall be extended to eight, or at the very least to seven, years? Can it be said that he is adequately equipped in physical and biological science unless his preliminary training has covered ground equivalent to, say, the requirements in three subjects for the London Pass B.Sc. degree, or for the first part of the Cambridge Natural Science Tripos? The *leaders* of the profession are essentially men of *science*, and masters of scientific method, expert in at least *one* branch of medicine and surgery. Is not the gap between the heads of the profession and the rank

and file too wide? If the present system must continue, would not mistakes in diagnosis be far fewer if the newly qualified medical man were compelled to work under the supervision of an experienced colleague for a few years? Would it not be wise if he returned to a hospital, say, every fifth year? Would it be unreasonable to expect him to take a Doctor's degree or a Fellow's diploma by the age of 35 or 40?

Eugenics

Very brief reference to this subject must suffice. It is that branch of science which has for its aim the perpetuation of those inherent and hereditary qualities which aid in the development of the human race. The subject owes much to Sir **Francis Galton**, whose researches added greatly to our previous knowledge of the subject and whose generosity made it possible to found the Galton Chair of Eugenics at the University of London. The President of the Eugenic Society is the fourth son of the great Charles Darwin, viz. Major **Leonard Darwin** (*b.* 1850), whose able advocacy and eminently logical reasoning have so far failed to break down the incurable sentimentality of many people in high places. Eugenics considers such subjects as inferior stocks; the elimination of defectives; insanity, and epilepsy; feeble-mindedness and mental deficiency; the habitual criminal; the unemployable; large families and family allowances; contraception; marriage with good stock; sterilization. Needless to say, Major Darwin's society has a long, stiff fight before it. When the Anglo-Saxon or the Celt engages in a war of reason *v.* sentiment, sentiment almost invariably proves the winner. It is the glistening tear, the catch in the voice, that leads to victory.

The distinguished Departmental Committee on Sterilization issued their Report on 18th January, 1934. The Committee rejected the case of sterilization as a compulsory measure, but they recommended that voluntary sterilization should be legalized in respect of mentally defective persons. The Report is wholly admirable in its outlook and in the

moderation of its recommendations. But how many years will it take to fight down the tearful opposition which the Report will inevitably provoke?

(Portraits of Liebig, Jenner, Pasteur, Koch, Plates 47, 44.)

BOOKS FOR REFERENCE:

1. *The Rise of Preventive Medicine*, Sir G. Newman.
2. *Preventive Medicine*, M. F. Boyd.
3. *Towards National Health*, J. A. Delmege.
4. *Devils, Drugs, and Doctors*, H. W. Haggard.
5. *The Health of England*, F. W. Hill.
6. *A Short History of Medicine*, C. Singer.
7. *History of Medicine*, a short synopsis, B. Dawson.
8. *Annual Reports of the Medical Research Council*.
9. *Recent Progress in Medicine and Surgery*, ed. Sir J. Collie.
10. *The Advance of Medicine*, Lord Moynihan.
11. *Symptom Diagnosis*, Barton and Yates.
12. *Recent Advances in Preventive Medicine*, J. F. C. Haslam.
13. *Groundwork of Biophysics*, G. M. Wishart.
14. *Nutrition and Dietetics*, E. P. Cathcart.
15. *Vitamins, Survey of Present Knowledge*, Medical Research Council's Report, 167.
16. *Food, Health, and Vitamins*. R. H. A. and V. G. Plimmer.
17. *Practical Food Inspection*, C. R. A. Martin.
18. *Radiology*, J. M. Woodburn Morison.
19. *Radiography and Radio-therapeutics*, R. Knox.
20. *Light Therapy*, F. H. Krusen.
21. *Foundation of Nutrition*, M. S. Rose.
22. *The Physiological Effects of Radiant Energy*, H. Laurens.
23. *Practical Endocrinology*: H. R. Harrower.
24. *The Technique of Ultra-violet Radiology*, D. T. Harris.
25. *Manual of Bacteriology*, Hewlett and Macintosh.
26. *Man's Microbic Enemies*, D. Stark Murray.
27. *Recent Advances in Bacteriology*, J. H. Dible.
28. *An Introduction to Laboratory Technique in Bacteriology*, M. Levine.
29. *What is Eugenics?*, Major Leonard Darwin.
30. *Prehistoric and Primitive Surgery*, L. W. G. Malcolm.
(Vicary Lecture, December, 1933).

CHAPTER XLIX

Philosophy and Science

Unlike philosophers of former times, present-day philosophers are less constructors of comprehensive systems than they are friendly counsellors and kindly critics. Not always kindly, however: of specious reasoning of all kinds they are the sworn enemies. One of the most generally respected of the modern school is the Cambridge philosopher, Professor C. D. Broad, who has a sound and extensive knowledge of natural science, and on the philosophical implications of science he therefore speaks with authority. We may usefully quote from his *Scientific Thought*.

“ An intelligent scientist would put his case against philosophy somewhat as follows. He would say: ‘ Philosophers discuss such subjects as the existence of God, the immortality of the soul, and the freedom of the will. They spin out of their minds fanciful theories, which can neither be supported nor refuted by experiment. No two philosophers agree, and no progress is made. Philosophers are still discussing with great heat the same questions that they discussed in Greece thousands of years ago. What a poor show does this make when compared with mathematics or any of the natural sciences! Here there is continual steady progress; the discoveries of one age are accepted by the next, and become the basis for further advances in knowledge. There is controversy indeed, but it is fruitful controversy which advances the science and ends in definite agreement; it is not the aimless wandering in a circle to which philosophy

is condemned. Does this not very strongly suggest that philosophy is either a mere playing with words, or that, if it has a genuine subject-matter, this is beyond the reach of human intelligence?’

“Should our scientist talk to students of philosophy and ask what happens at their lectures, his objections will most likely be strengthened. The answer may take the classical form: ‘He tells us what everyone knows, in language that no one can understand.’ But, even if the answer be not so unfavourable as this, it is not unlikely to take the form: ‘We hear about the views of Plato and Kant and Berkeley on such subjects as the reality of the external world and the immortality of the soul.’ Now the scientist will at once contrast this with the method of teaching in his own subject, and will be inclined to say, if e.g. he be a chemist: We learn what *are* the laws of chemical combination and the structure of the benzene nucleus, we do not worry our heads as to what exactly Dalton thought or Kekulé said. If philosophers really know anything about the reality of the external world, why do they not say straightforwardly that it is real or unreal, and prove it? The fact that they apparently prefer to discuss the divergent views of a collection of eminent ‘back-numbers’ on the question strongly suggests that they know that there is no means of answering it, and that nothing better than groundless personal opinions can be offered.

“I have put these objections strongly, and I now propose to see just how much there is in them. First, as to the alleged unprogressive character of philosophy. This is, I think, an illusion; but it is a very natural one. Let us take the question of the reality of the external world as an example. Common sense says that chairs and tables exist independently of whether anyone happens to perceive them or not. We study Berkeley and find him claiming to prove that such things can only exist so long as they are perceived by someone. Later on we read some modern realist, like Alexander, and we are told that Berkeley was wrong, and that chairs and tables can and do exist unperceived. We seem merely to have got back to

where we started from, and to have wasted our time. But this is not really so, for two reasons. (i) What we believe at the end of the process and what we believed at the beginning are by no means the same, although we express the two beliefs by the same form of words. The original belief of common sense was vague, crude and unanalysed. Berkeley's arguments have forced us to recognize a number of distinctions and to define much more clearly what we mean by the statement that chairs and tables exist unperceived. What we find is that the original crude belief of common sense consisted of a number of different beliefs, mixed up with each other. Some of these may be true and others false. Berkeley's arguments really do refute or throw grave doubt on some of them, but they leave others standing. Now it may be that those which are left are enough to constitute a belief in the independent reality of external objects. If so this final belief in the reality of the external world is much clearer and subtler than the verbally similar belief with which we began. It has been purified of irrelevant factors, and is no longer a vague mass of different beliefs mixed up with each other.

“ Not only will our final belief differ in content from our original one, it will also differ in certainty. Our original belief was merely instinctive, and was at the mercy of any sceptical critic who chose to cast doubts on it. Berkeley has played this part. Our final belief is that part or that modification of our original one that has managed to survive his criticisms. This does not of course *prove* that it is true; there may be other objections to it. But, at any rate, a belief that has stood the criticisms of an acute and subtle thinker, like Berkeley, is much more likely to be true than a merely instinctive belief which has never been criticised by ourselves or anyone else. Thus the process which at first sight seemed to be merely circular has certainly not been useless; for it has enabled us to replace a vague belief by a clear and analysed one, and a merely instinctive belief by one that has passed through the fire of criticism.

“Common sense constantly makes use of a number of such concepts or categories as thinghood, space, time, change, cause, &c. Science takes over these concepts from common sense with but slight modification, and uses them in its work. Now we can and do *use* concepts without having any very clear idea of their meaning or their mutual relations. I do not of course suggest that to the ordinary man the words *substance, cause, change, &c.*, are mere meaningless noises like *Jabberwock* or *Snark*. It is clear that we mean something by such words. But it is possible to apply concepts more or less successfully when one has only a very confused idea as to their meaning.

“Now the most fundamental task of philosophy is to take the concepts that we daily use in common life and science, to analyse them, and thus to determine their precise meanings and their mutual relations. Evidently this is an important duty. Clear and accurate knowledge of anything is an advance on a mere hazy general familiarity with it.

“Philosophy has another and closely connected task. We not only make continual use of vague and unanalysed concepts. We have also a number of uncriticized beliefs, which we constantly assume in ordinary life and in the sciences. We constantly assume, e.g. that every event has a cause, that nature obeys uniform laws, that we live in a world of objects whose existence and behaviour are independent of our knowledge of them, and so on. Now science takes over these beliefs without criticism from common sense, and simply works with them. We know by experience, however, that beliefs which are very strongly held may be mere prejudices. Negroes find it very hard to believe that water can become solid, because they have always lived in a warm climate. Is it not possible that we believe that nature as a whole will always act uniformly simply because the part of nature in which the human race has lived has happened to act so up to the present? All such beliefs then, however deeply rooted, call for criticism. The first duty of philosophy

is to state them clearly; and this can only be done when we have analysed and defined the concepts that they involve. Until you know exactly what you mean by *change* and *cause* you cannot know what is meant by the statement that *every change has a cause*. And not much weight can be attached to a person's most passionate beliefs if he does not know what precisely he is passionately believing. The next duty of philosophy is to test such beliefs; and this can only be done by resolutely and honestly exposing them to every objection that one can think of oneself or find in the writings of others. We ought only to go on believing a proposition if, at the end of this process, we still find it impossible to doubt it. Even then of course it may not be true, but we have at least done our best."

Professor Broad's book should be read carefully through and pondered over.

Philosophy is something which is intensely personal. Its aim is to convince, and it therefore takes the form of reasoning. Nothing is easier than to reason about the convictions of others, but the man who thinks that by doing this he will become a philosopher makes the same mistake as an imitative artist. The real philosopher reasons because he has a conviction, arising out of his own experience, which he longs to communicate and he can only communicate it by reasoning. But this reasoning process, by itself, will not make a philosopher any more than versifying by itself will make a poet. The philosopher only becomes one completely when he reasons, as the poet only becomes one when he writes poetry; but in each case there must be an impulse, arising out of experience, which fulfils itself in the work of philosophy or in the work of art. The impulse cannot be created by reasoning or by versifying. Something must happen to the mind of the philosopher as of the poet, something must be conceived in it through its contact with the outside world, which is only born with the labour of reasoning.

Reasoning is "a kind of experiment that does not make discoveries but only tests them." The reasoning in which a philosopher engages when he examines the basic assumptions of science is essentially critical; it does not aim at making discoveries, except discoveries of lurking fallacies and of inconsistencies. A man of science who himself turns philosopher seldom achieves great success, inasmuch as he is apt to remain unsuspecting of the natural bias with which his earlier professional training has inevitably affected him.

Psychology is sometimes looked upon as a branch of philosophy, but it is now making a claim to stand outside and to be regarded as a branch of science. The claim is difficult to justify at present, as psychology cannot yet provide us with anything like an unassailable corpus of doctrine. Despite a quarter of a century's labour by a large number of brilliant research workers, it is still a thing of shreds and patches. It is significant that Oxford allowed its scholarly Reader in Mental Philosophy, **William McDougall**, to escape to Harvard, and even now the university remains without a professor. We may quote from Dr. F. C. S. Schiller, whose rare gifts as a logician will be remembered by all Oxford men of the last forty years:

"As a good example of a science hung up for ages, in a manner strongly suggestive of a lack of appropriate conceptions, we may consider the sad case of psychology. Here we have a science of apparently enormous potentialities and pretensions, of universal interest, of great antiquity, upon which many generations of thinkers have lavished much time, ingenuity, and enthusiasm. Yet disappointingly little has been made of it. After more than 2000 years of strenuous cultivation it still has no laws but only technical terminologies, no consensus about methods and principles but a swarm of discordant 'schools', no definite limits and no assured territory but far-reaching claims and perpetual borderwars with all its scientific neighbours. It has 'descriptions', but none adequate to the subtleties and shades of the processes

they describe. . . . The conceptions, schemes and technicalities of psychology *do not work.*"

The facts of psychology are admittedly very hard to come by. It has been well said that the hunting down of facts in physical and biological science is like hunting for a needle in a hay-field, but that the hunting down of facts in psychology is like hunting for a needle in a hay-field *on a dark night*. Certain it is that the getting at the facts of psychology is incomparably more difficult than getting at the facts of physical and biological science.

The psychologist is often attacked because of the "jargon" he uses, and even Dr. **Aveling**, Professor of Psychology at the University of London, was criticized for his supposed lack of lucidity in his presidential address at the 1933 meeting of the British Association. In the course of that address he referred to the visual impression conveyed by an object such as a book, and he said:

"The visual impression, however, is not the tactile one, and neither nor both together is the book. Sensorially I do not apprehend the book at all, but only 'properties' of the book? Why then do I think that there is a book? I interpret the phenomena analogically with my immediate awareness of myself as affected by states, and posit a physical book with physical properties to account for the phenomena. Only later do I refine my notions of physical 'properties' and conceive them together with the book not as like, but as very unlike, the original sensory."

Of course, to a layman, this is unintelligible, but it was addressed to a meeting versed in the terminology of psychology, and the various terms used were presumably understood readily enough. After all, any branch of science is bound to have a terminology of its own. The real danger lies less in the mere terms than in the ideas which the terms are made to clothe. The trouble with psychology at present is that its devotees (perhaps we should say apologists) cannot agree about their foundations. They are still waiting for their Copernicus.

On the other hand, *psycho-therapy* as a branch of medicine is making great headway, and in this connexion the names of three distinguished physicians may be mentioned: (1) Sir **Maurice Craig** (*b.* 1866), consulting physician in psychological medicine at Guy's Hospital; (2) Dr. **William Brown** (*b.* 1881), Wilde Reader in Mental Philosophy at Oxford; (3) Dr. **W. Langdon Brown** (*b.* 1870), Regius Professor of Physic in the University of Cambridge. Suggestive treatment for psycho-neurotic patients seems to have met with great success, and (it is understood) perseverance in the practice of auto-suggestion has transformed self-tormenting hypochondriacs into men of calm tenacity of purpose and serene self-confidence. In this direction psychology is likely to prove increasingly valuable.

In a recent address at Westminster, the Regius Professor said: "Medicine is a department of biology, and unless we consider the patient as a whole, as a living organism reacting to changes in either the internal or external environment, we shall miss an essential part of his case. Ordinary materialistic medicine is apt to forget the fact that the patient's emotional and mental outlook will inevitably influence and be influenced by his disease; the psycho-therapist is apt to forget that the patient has a body which may be suffering from some physical distress. To-day there is still a craving for magical cures. It is by a combined attack on the physical and psychological side that medicine in the future will make advance."

We have no space to deal with the subjects of **Psycho-analysis** and **Psychical Research**, except to say that the former in the hands of the inexpert practitioner is a very dangerous weapon; and that the latter is likely to benefit greatly from the extended use of infra-red photography—the evils inherent in "dark séances" ought soon to vanish completely.

(For Books of Reference see end of Chapter LV.)

CHAPTER L

Causation and Indeterminacy

Causation in Dynamic and in Static Systems *

A violent ring of the bell startles the servant; the servant treads on the dog's tail; the dog jumps against my chair; I drop the sugar-tongs into my coffee; the dropping of the sugar-tongs is followed by a splash; the splash is followed by a coffee-stain in the table-cloth. It is common to say that the stain is "caused" by the splash, the splash by the dropping of the sugar-tongs, the dropping of the sugar-tongs by the movement of the dog, and so on, until we get back to the cause of the ringing of the bell. Any one of the sequence of actions might be selected as being the cause of the coffee-stain, but as it is customary to select that action which seems to be most immediately followed by the particular change to which attention is drawn, we say that the coffee-stain was caused by the splash. At every stage there is *action*, and there is a *change*; and the action is *followed* by the change.

The coffee-stain is the layer of coffee in contact with the table-cloth. This layer of coffee does not appear simultaneously with the splashing of the coffee; it *follows* the splashing. The *action* of the splashing is the *cause*; the *change* from a clean table-cloth to a stained table-cloth is the *effect*. Briefly, the splashing is the cause, the stain is the effect.

Dense white fumes of ammonium chloride are formed by mixing the two colourless gases hydrochloric acid gas and ammonia. The *cause* of the formation is an action, viz.

* Cf. *Science and Theology*, Chapter XI.

the mixing, but the formation is not simultaneous with the mixing, it *follows* the mixing. The effect is the change from the invisible gaseous particles to visible solid particles. If the action could be slowed down and we could actually witness the procedure of the molecular combinations, the intermediate stages would be identified; but these being unknown we have to be content with saying that the action of the mixing is the cause of the combination. As science advances, we may become familiar with a more proximate cause of the formation. If we are asked to say why we conclude that the mixing is the cause of the formation, we say it is because of the *immediate sequence* of the appearance of the white fumes. The immediate sequence seems to compel us to recognize a *necessary connexion* between the action and the effect.

Cancer of a certain kind is never found except among chimney-sweeps. We therefore conclude that chimney-sweeping is the sole cause of that kind of cancer. We do not know how the effect is brought about by the action, or what intermediate stages there may be between the action and the effect. The constant association seems to compel us to infer causation. We feel sure we know the ultimate cause, though presumably not the intermediate causes.

It is wrong to say that the cause of the surprise of the army was the sentry's *being* off his post. The sentry's being off his post is not an action, and therefore not a cause. It is right to say that the sentry's *deserting* his post was the cause of the surprise, for this implies action; and for the same reason the bribery of the sentry may properly be called a cause of the surprise.

In all these cases we have been dealing with the relations within a dynamic, successive system. But there are other cases within an entirely different system, viz. a static simultaneous system.

To say that the weight of the atmosphere is the *cause* of the height of the mercury in the barometer is not strictly correct, for the height of the mercury is not a change. The

fact here to be accounted for is not a change but the absence of change—the non-sinking of the mercury despite its tendency to sink under the action of gravity. In other words, the fact to be accounted for is the relations within a static simultaneous system.

The *rise* and *fall* of the mercury are caused by the increase and decrease of the air-pressure; each variation of pressure is immediately followed by a *change* of level of the mercury. But when the mercury remains stationary at a particular level, the *reason* is the constant pressure of the atmosphere. In the former case we have action within a dynamic successive system; in the latter there is no apparent action; the system is static and simultaneous. It is, of course, true that, even in the case of the static system, the system is maintained by the action of the pressure of the air, but whereas in the dynamic system the action always precedes the change, in the static system the action is always contemporaneous with the maintenance of the absence of change.

It is thus incorrect to say that there is no causation unless the cause is always followed by the effect and the effect is always preceded by the cause. In all static systems, for instance in the maintenance of the motion of the locomotive, in the suspension of a weight by a cord, in the prolonged boiling of water, cause and effect are simultaneous, though, of course, every such system had its origin in a dynamic system where the effect followed the cause; and this being so, it is the dynamic successive system that claims our chief attention.

Cause and Effect. Reason, Result, Conditions

Cause and effect comprise something more than a dual whole, for there is a link which unites them together. With this link they form a triple whole. The link which thus unites cause and effect is *causation* or *effectuation*, according to the point of view from which we regard it.

Any change to which we are well accustomed, for instance,

a change from day to night, or from rain to sunshine, we contemplate as a change merely; it rarely occurs to us to look behind the change for the cause, or to regard the change as an effect. Such changes are part of a changing routine whose changes, being customary, rarely impress us. But if the routine should cease to change in its customary manner, the break in the routine would form a change that would impress us at once, especially if it were rapid or sudden. Such a change would impress us as an *effect*, and the mind would inevitably be driven to seek for a *cause*. In such a case the change is identified with the effect, or is at least inevitably associated with it, for in occurrence they are inseparable. An unaccustomed noise is a noteworthy example of this. On hearing a sudden noise the mind instantly passes from change to cause, unconsciously regarding the change as an effect. The element of change that impresses us is unusualness.

But when we are dealing with a static simultaneous system, that is, when there is an action tending to produce a change which yet does not take place, we inevitably assume, if our attention is drawn to the case, that the absence of change is due to some counteraction, and we regard this want of change as an effect. If we pull a drawer and it does not move, then the want of change despite our action tending to produce change is an effect, and drives the mind to seek for a cause: the drawer is locked, or the wood has become damp and swollen. It is that which actually produces a change that is properly called the *cause* of the change, and the term cause is therefore best applied only to a dynamic successive system. To that which is the cause of a want of change, it is preferable to apply the term *reason*. The pull we exert on the handle of the drawer is the *cause* of the drawer opening; the drawer being locked is the *reason* why it does not yield to the pull. In the latter case we have a static simultaneous system. Either a change, or an absence of change if regarded as an effect, is always associated in our minds with cause and causation.

The cause of a change must be sought in some action which precedes the change. But causation and antecedence are not the same thing. In a dynamic successive system, antecedence always goes with causation, but in a static simultaneous system the cause does not precede the effect. A drawer may be locked long before and long after it is pulled upon to open it; its being locked is the *reason* why it does not yield to the pull; the *cause* of the want of change is the resistance of the tongue of the lock, and this resistance is an action which effectually counters the action of the pull. The resistance begins with the pull and ends with the pull, but as long as the pull lasts the resistance lasts; the system is static.

We may therefore describe an effect as a change connected with a preceding action in a dynamic system, or an absence of change connected with an accompanying action in a static system, on the thing changed or not changed, respectively. When iron rusts, the rusting is an *effect*, for it is a *change* from metallic iron to oxide. It remains rusty, but it is not correct to say that the effect continues. What persists is not the effect, not the change, but the *changed state*, the new state that has resulted from the change. The changed state is the *result*. A result is the changed state of a thing on which an effect has been produced.

It is sometimes denied that a change is produced by the action of some agent. But can we imagine a change to be produced without the action of an agent any more than we can imagine resistance without extension, or solid without surface? True, our notion of the action must be vague, but a change in a thing *without* action on the thing seems to be inconceivable. Cause always seems to carry with it the notion not merely of action but of the transference of action from the acting agent to the thing acted on.

Thus in a dynamic system we may apparently define cause as an action connected with a following change in the thing acted on; and in a static system, as the cessation of action connected with the accompanying absence of change

in the thing acted on. But in the latter case it would perhaps be more correct to speak of the cessation of action not as a cause but as the removal of the cause.

Medical men sometimes speak of "predisposing" causes of a disease, such as the age and sex of the patient, the climate and locality of his residence, and the like. But these are neither actions nor cessations of action, and are therefore not causes. Yet they undoubtedly have an influence on the effect; they are, in fact, *conditions* of the effect.

The distinction between a cause and a condition is that a cause is an action and a condition is a state; not necessarily a permanent passive state, though a state having passive endurance, however brief. Like the cause, the condition must be connected with the change in the thing acted on. The pulling of the trigger is the *cause* of the discharge of a gun; the presence of a cartridge in the barrel is a necessary *condition* of the discharge. The *cause* of the sound of a piano is the action of the hammer on the wires, but the effect could not be produced except for the air around the piano; the existence of the air is therefore a *condition* of the sound. Many necessary conditions are concerned not with the thing itself acted on, but with something around or near that thing.

But there are many things around or near the thing acted on that are in no way concerned with the effect produced by the action. The piano may be in a room containing furniture and a dog, but the presence of the furniture and of the dog are not conditions of the emission of the sound. A condition must be *material* to the effect.

The Mark of Causation

It is sometimes said that *immediate sequence* is a mark of causation, but this cannot be admitted without qualification. If a man is stabbed to-day and in consequence dies twenty-four hours later, it is clear that, in the consideration of the cause of his death, time is an element that cannot be

disregarded. It is true that the action of the stabbing probably starts off a long series of other actions which ultimately end in death; it is conceivable that this series is almost indefinitely great. Nevertheless at each step there is a *change*, and every change requires time, however short. Of course there is no time *gap*: that is inconceivable. The first cause A, the stabbing, produces the effect B, which then becomes an intermediate cause to produce a further effect C; and so on to the end. Although only a few intermediate stages are usually recognizable in such a series, we are certain there can be no time interval; the series is continuous, but every one of the changes must take time. The time element is essential; every action must endure for *some* time however short. Even the formation of water when a spark is passed through a mixture of hydrogen and oxygen, even the lightning flash, takes time. It is easy to imagine any process slowed down, so that all the intermediate stages may be clearly seen. A change necessarily takes place *in* time, and *consumes* time. The very term change implies duration. Absolute immediacy is out of the question, though we may sometimes find it difficult to imagine even an indefinitely small fraction of a second between the initiation of the action and the change which becomes manifest to our senses.

The cause of a cause is the cause of the effect. The universe is a continuous series of changes. In this continuous series we may take any section we please and call the first change in this isolated section the cause of all or any that follow; the last, the effect of all or any that have gone before; and we can call the first the cause of the last, and the last the effect of the first.

It is sometimes said that the most characteristic mark of causation is *unconditionalness*, and yet those who make this assertion define cause as the sum of the conditions, or the totality of the conditions. Obviously that which depends upon conditions cannot be unconditional. A cause must not be confused with its conditions.

It is also sometimes said that the most characteristic mark

of causation is *antecedence*. This does seem to apply to the relations that obtain within a dynamic successive system. The cause has a certain duration, and during every instant of that duration it is in action and is causing more and more of the effect. The effect also has a certain duration. As the cause begins to act, the change begins to occur; as the cause continues, the change increases; when the cause ceases to act the effect has reached its maximum, but the effect as an effect, that is, as a progressing change, now also ceases, and becomes a *result*. The total effect is not reached until the cause ceases to act, and it is only in this sense that the effect succeeds the cause, and that cause and effect are antecedent and consequent. In the case of a static simultaneous system, antecedence is not applicable. Here cause and effect are simultaneous.

Can, then, a specifically characteristic mark of causation be found? Night always follows day and the two are connected, but yet night is not the effect of day. Mere connexion in sequence does not *constitute* causation even when the sequence is constant; yet it is clear that the connexion in sequence does *depend on* causation. The connexion between day and night is that they have a common cause, the rotation of the earth with reference to the sun. Thus the connexion between antecedent and consequent is indispensable to causation.

Night follows day and is connected with it, but night is not the effect of day because, although there is a connexion between them, the connexion is not between an action of the day and a change in the thing acted on. Day does not act on anything to cause night. What, then, is the *nature* of the connexion between cause and effect? The action is so connected with the change that if the action had not taken place the change would not have occurred; and the action taking place under the conditions it did, the change connected with it was unavoidable and unpreventable. Thus the specifically characteristic mark of causation seems to be the *necessary connexion* between cause and effect.

Regression of Causes

There is a sense in which every event has many causes. The splashing of the coffee was caused by the dropping of the sugar-tongs; the dropping of the sugar-tongs was caused by the movement of the dog; the movement of the dog was caused by the action of the servant; the action of the servant by the violent ring of the bell; the violent ring of the bell was an action due to the impatience of the visiting tradesman; the impatience of the tradesman was due to the peremptory orders of his financially embarrassed master; the financial embarrassment was due to the torpedoing of a cargo by a submarine; and so we can continue the series backwards as far as we like to go. There is a continuous regression of causes from the first effect to the last action, and a continuous progression of effects from the first action to the last effect. It is the same with every case of cause and effect. The actions stretch backwards in series as far as we like to trace them; and the effects proceed forwards down to the present moment, in which, as actions, they are carrying on the chain of effects into a futurity of indefinite duration.

The line of causes may bifurcate at almost any point. The torpedoing of the cargo, for instance, was partly due to the action of the enemy, but partly to the captain and owners of the cargo-boat, or the boat would not have been where she was when the torpedoing took place. Obviously the causes ramify as we go backward from the effect. The conditions may be many, and each may have many causes, depending on other conditions, which again may be many; and so on.

Out of all these different series of innumerable causes, it is usual to select *one* and to call it *the* cause. *The* cause is, of course, as nearly *immediate* as we can ascertain it to be, though oftentimes there will be many intermediate causes of which we have no knowledge. Speaking generally, the direct cause we select depends on the purpose in view, upon the aspect of the matter, in which we are interested.

During rifle practice a wayfarer gets into the line of fire and is killed by a bullet. What is the cause of his death? To the physiologist, it was the arrest of the heart's action; to the student of ballistics, it was the low trajectory of the bullet; to the marksman, it was the force of the wind which deflected the bullet from the line of aim; to the squad-instructor, it was the failure of the marksman to respond promptly enough to the order, cease fire; to one leader-writer, it was the deplorable carelessness of the soldier; to another, the stupidity of the civilian in crossing the line of fire; and so on. Every one of these may legitimately be considered as a cause, but if we are asked for *the* cause, we must know for what purpose the question is asked.

Not all philosophers, by any means, agree that some sort of action or enforcement is concerned with causation. They maintain that cause and effect is a simple affair of sequence, and nothing more. But it is difficult to see how, without action, an effect can be produced, and that seems to indicate some sort of transfer or liberation of energy. It is quite true that when we use such a term as energy or action we seem to attribute to objects a feeling corresponding to our own feelings of muscular exertion. But all we really mean is that the energy, enforcement, or whatever it may be, belongs not to the thing's feeling but to the thing's activity, though of the nature of this activity we are still absolutely in the dark.

But though causation is concerned equally with human action and with the action of inanimate nature (we neglect other living things) the two actions are entirely distinct. Human action is determined by the will. Any particular action of inanimate nature that may attract our attention is but a momentarily and artificially isolated, and relatively infinitesimal, amount of nature's store of energy being transferred from one place to another. In pursuing her relentless course, nature has her own method of consuming her stores of energy, and though human effort may, in some slight measure, increase or retard that consumption, we can

almost imagine her treating with contempt the puny efforts of her own creatures to thwart her will.

We may quote the opinions of well-known authorities on the general subject of causation. It is interesting to note how radically opinions differ.

1. **Hume.** "We can never by our utmost scrutiny discover anything but one object following another, without being able to comprehend any force or power by which the cause operates, or any connexion between it and the supposed effect. All events seem entirely loose and separate. One event follows another, but we never can observe any tie between them. They seem *conjoined* but never *connected*. But as we can have no idea of anything which never appeared to our outward sense or inward sentiment, the necessary conclusion seems to be that we have no idea of connexion or power at all, and that these words are absolutely without any meaning when employed either in philosophical reasonings or common life."

2. **G. H. Lewes.** "Hume's theory is neither a complete expression of the facts nor a correct analysis of the origin of our belief. When he says that invariable succession of antecedent and consequent is *all* that is given us in our experience of causation, he asserts that which every man who examines the matter attentively may contradict. Ask yourself whether you have not a sense of *power* also given in the experience of causation. You cannot hesitate. You believe that fire has the *power* to burn your finger, that one billiard ball has the *power* of moving another when impinging on it. The idea of power may be vague if by idea we understand anything like an *image*, but it is precise enough if we understand by it merely a conception formed by the mind. We cannot, indeed, frame an image of power any more than we can frame an image of mind or of substance; but we have a strong conviction of the existence of them all."

3. **J. S. Mill.** "The Law of Causation, the recognition

of which is the main pillar of inductive science, is but the familiar truth that invariability of succession is found by observation to obtain between every fact in nature and some other fact, which has preceded it, independently to all considerations respecting the nature of 'things in themselves'.

"To certain facts, certain facts always do, and, as we believe, will continue to succeed. The invariable antecedent is termed the cause; the invariable consequent the effect.

"Philosophically speaking, the cause is the sum total of the conditions, positive and negative, taken together; the whole of the contingencies of every description, which being realized, the consequent invariably follows. It is the antecedent, or the concurrence of antecedents, on which the phenomenon is (1) *invariably*, and (2) *unconditionally*, consequent."

4. Professor **W. Knight**. "We are told that, in imagining efficiency, or causality, or productiveness (name it as you will) to be lodged within an antecedent, or even within a group of antecedents, as co-operative con-causes, we are the dupes of custom. But we know the cause as *productive* of the effect, or we do not know it at all; and we know the effect as *produced by* the cause, or we do not know *it* at all; and since all phenomena are, alternatively, both causes and effects, according as we regard them—the cause being just the effect concealed and the effect being merely the cause revealed—we find an interior power or causality *within every link of the chain*. The special point to be noted is that while the *senses* take note of phenomenal succession only, the intellect strikes through the phenomenal chain, and it discerns the inner vinculum, the tie of causality binding antecedent to sequent in the grip of an *a priori* necessity."

5. Professor **Ernst Mach**. "In speaking of cause and effect, we arbitrarily give relief to those elements to whose connexion we have to attend in the reproduction of a fact in the respect in which it is important to us. There is no cause or effect in nature; nature simply *is*. Recurrences of like cases in which A is always connected with B, that is, like

results under like circumstances, that is again, the essence of the connexion between cause and effect, exist but in the abstraction which we perform for the purpose of mentally reproducing the facts. Let a fact become familiar, and we no longer require this putting into relief of its connecting marks, our attention is no longer attracted to the new and surprising, and we cease to speak of cause and effect. A person of experience regards an event with different eyes from a novice. The new experience is illuminated by a mass of old experience. The notion of the *necessity* of a causal connexion is probably created by our voluntary movements in the world, and by the changes which these indirectly produce, as Hume supposed. Cause and effect are things of thought, having an economical office. It cannot be said *why* they arise."

6. **W. K. Clifford.** "The word represented by 'cause' has sixty-four meanings in Plato and forty-eight in Aristotle. These were men who liked to know as near as might be what they meant, and it would only be the height of presumption in me to attempt to fix the meaning of a word which has been used by so grave authority in so many and various senses; and I shall evade the difficulty by telling you Mr. Grote's opinion. You come to a scarecrow and ask, what is the cause of this? You find that a man made it to frighten the birds. You go away and say to yourself, 'Everything resembles this scarecrow; everything has a purpose.' And from that day the word 'cause' means for you what Aristotle meant by 'final cause'. Or you go into a hairdresser's shop, and wonder what turns the wheel to which the rotatory brush is attached. On investigating other parts of the premises, you find a man working away at a handle. Then you go away and say, 'Everything is like that wheel. If I investigated enough I should always find a man at a handle.' And the man at the handle, or whatever corresponds to him, is from henceforth known to you as 'cause'."

"When we say that every effect has a cause, we mean that every event is connected with something in a way that

might make somebody call that the cause of it. But I, at least, have never yet seen any single meaning of the word that could be fairly applied to the *whole* order of nature."

7. Professor **Carveth Read**. "There is not in nature one set of things called causes and another called effects, but everything is both cause of the future and effect of the past; and whether we consider an event as the one or the other, depends upon the direction of our curiosity or interest. Still, taking the event as effect, its cause is the antecedent process; or, taking it as a cause, its effect is the consequent process. This follows from the conception of causation as essentially motion; for that motion takes time is an ultimate intuition. But, for the same reason, there is no interval of time between cause and effect, since all the time is filled up with motion."

8. Professor **Karl Pearson**. "That a certain sequence has occurred and recurred in the past is a matter of experience to which we give expression in the concept *causation*; that it will continue to recur in the future is a matter of belief to which we give expression the concept *probability*. Science in no case can demonstrate any inherent *necessity* in a sequence nor prove with absolute certainty that it must be repeated. Science for the past is a description; for the future a belief.

"The whole tendency of modern physics has been to describe natural phenomena by reducing them to conceptual motions. From these motions we construct the more complex motions by aid of which we describe actual sequences of sense-impressions. But in no single case have we discovered *why* it is that these motions are taking place. Science describes *how* they take place, but the *why* remains a mystery. Science knows nothing of first causes."

9. Professor **E. W. Hobson**. "When a physical event takes place, it is usually regarded by common sense as determined by preceding events or processes which are deemed to have caused it to take place. Very frequently, some one preceding event is singled out as the cause of the event in question. It is assumed that the particular event, the effect,

would not have taken place in the absence of the cause, and that cause is regarded as affording an explanation of the occurrence of the effect. In scientific thought, the notion of causation is expanded so as to embrace a whole complex of conditions, some preceding in time, and others simultaneous with, the particular event in question. That every event has a cause, formulates the conception of the *determination* of the event by a complex of preceding and present conditions. . . . The principle of causation, taken in the only sense in which it can now be retained in natural science, is not a logically necessary principle, but merely the working hypothesis, that it is possible to predict the happening of particular events when certain complexes of antecedent conditions are known."

Clearly, then, there is great difference of opinion about the nature of causation, mainly as to the existence of any sort of enforcing action. All that we *know* is the invariable *sequence* of cause and effect. Of the "how" we are ignorant. But there is unanimity of opinion that in the physical world events are in some way or other always *determined*, and that there is no randomness or chance about their happenings; in other words the principle of causation is accepted as axiomatic.

And yet there are those who are doing their best to dig up this principle and throw it on the rubbish heap. This brings us to the subject of indeterminacy.

" Indeterminacy "

It was **Heisenberg** who originated this particular notion, though he did it quite unwittingly. In Chapter XXXVII we gave a short explanation of his famous "Principle of Uncertainty", which states that we cannot at the same time know with absolute accuracy both the position and the momentum of a particle; the more accurately the one is measured, the greater error is there necessarily introduced

into the measurement of the other. This is a mere consequence of a fundamental crudeness in our measuring apparatus. A perfect piece of apparatus has yet to be devised; even our best pointer-readings are only approximations. Thus there can be no objection to the acceptance of the principle in question. But if instead of the term "uncertainty" we use the term "indeterminacy" we use a term which is misleading, for it is ambiguous. To some minds "indeterminacy" suggests more than "uncertainty", more than "undetermined"; it connotes "cannot be determined", "is not determined", "is not caused", or even "comes about by chance".

If we assert that cause and effect are anything more than a mere sequence, that causation connotes an enforcement of some kind, and "determines" the effect, it is quite legitimate for an opponent to call for the demonstration and proof of the existence of the determining factor. This, of course, cannot be done. But when the opponent goes on to say that, since such a factor cannot be demonstrated, it of necessity does not exist, he is clearly taking up a position which is altogether indefensible.

Sir Arthur Eddington is the formidable chief of the new Indeterminist School, and Sir James Jeans is his equally formidable lieutenant. We will let Sir Arthur speak for himself: the extracts are from his address to the Mathematical Association, January, 1932, and from his article in *Philosophy*, Vol. VIII, No. 29.

"Determinism has faded out of theoretical physics. Its exit has been commented on in various ways. Some writers are incredulous, and cannot be persuaded that determinism has really been eliminated. Some think that it is only a domestic change in physics, having no reactions on general philosophic thought. Some imagine that it is a justification for miracles. Some decide cynically to wait and see if determinism fades in again."

"Ten years ago, practically every physicist of repute was, or believed himself to be, a determinist, at any rate so far

as inorganic phenomena are concerned. He believed that he had come across a scheme of strictly causal law, and that it was the primary aim of science to fit as much of our experience as possible into such a scheme. The methods, definitions, and conceptions of physical science were so much bound up with this assumption of determinism that the limits (if any) of the scheme of causal law were looked upon as the ultimate limits of physical science."

"It is commonly objected that our uncertainty as to what the electron will do in the future is due not to indeterminism but to ignorance. It is asserted that some character exists in the electron or its surroundings which decides its future, only physicists have not yet learned how to detect it. But if the physicist is to take any part in the wider discussion on determinism as affecting the significance of our lives and the responsibility of our decisions, he must do so on the basis of what he has discovered, not on the basis of what it is conjectured he might discover."

"Alleged causes must be challenged to produce their birth certificates so that we may know whether they really were pre-existing."

"The time of break-up of a radioactive atom is an example of extreme indeterminism; but it must be understood that, according to current theory, all future events are indeterminate in greater or lesser degree, and differ only in the margin of uncertainty."

"The persistent critic continues: 'You are evading the point. I contend that there are characteristics unknown to you which completely predetermine not only the time of break-up of the radioactive atom but also all physical phenomena. How do you know there are not? You are not omniscient.' The curious thing is that the determinist who takes this line is under the illusion that he is adopting a more modest attitude in regard to our scientific knowledge than the indeterminist."

"Determinism is a positive assertion about the behaviour of the universe."

“Indeterminism is not a positive assertion. I am an indeterminist in the same way that I am an anti-moon-is-made-of-green-cheese-ist. That does not mean that I especially identify myself with the doctrine that the moon is *not* made of green cheese. Whether or not the green cheese lunar theory can be reconciled with modern astronomy is scarcely worth inquiring; the main point is that green-cheeseism, like determinism, is a conjecture that we have no reason for entertaining. Undisprovable hypotheses of that kind can be invented *ad lib.*”

“If the whole physical universe is deterministic, mental decisions (or at least *effective* mental decisions) must also be predetermined.” “If the atom has indeterminacy, surely the human mind will have an equal indeterminacy; for we can scarcely accept a theory which makes out the mind to be more mechanistic than the atom.”

“The result of our analysis of physical phenomena up to the present is that we have nowhere found any evidence of the existence of deterministic law.”

“By *no evidence* I do not merely mean *no conclusive proof*. If there were any phenomena which seemed more adequately explained by a proposed deterministic law, I should count that as evidence, although it might fall a long way short of proof. But that is not the case. It often seems to be overlooked in these discussions that a scientist does not verify law in the abstract; he verifies or disproves *particular laws*. Scientific evidence (however feeble) for deterministic law would necessarily be evidence for a particular deterministic law. It is significant that physicists like Einstein, who urge that deterministic law will ultimately have to be reintroduced into physics, have not got so far as to suggest a particular law, so that they have not reached a stage at which the claim to be supported by scientific evidence could be put forward. Determinism has dropped out of physics.”

“It is often suggested that physics has been too hasty

in abandoning deterministic law. That, I think, is misleading. Physics, as I have said, is not concerned with law in the abstract, but with *particular laws*. It is *the particular laws that have been thrown over*; and I do not think anyone who has grasped the recent progress in quantum theory would say that we have been too hasty in adopting specific indeterministic laws instead of the specific deterministic laws which were the basis of physics twenty years ago. They would have barred the way to the progress that has been made. But we cannot drop all the deterministic laws, and still retain deterministic law in the abstract. If you have spent every pound you possess, the obvious thing is to admit yourself broke, however fondly you may cling to the comforting thought of money in the abstract."

"Now let me turn to the way in which this change in the attitude of physics has been received by those who are philosophically minded. . . . Writer after writer proceeds to show that neither Heisenberg's Principle of Indeterminacy nor anything else in modern physics *disproves* determinism. That, I think, is universally agreed; so is it too much to hope that determinists, being reassured on this point, may spare a little attention to the situation which has actually arisen?"

"I accept the label 'indeterminist' as descriptive of the ordinary attitude of unbelief (not disbelief) which one accords to a hypothesis put forward without evidence."

We will now usefully quote from a few other writers on the subject:

1. The President of the British Institute of Philosophy, Sir **Herbert Samuel** (*Philosophy*, No. 29):

"It seemed to me clear that the first principle which philosophy might receive, *as established by science*, was the Law of Causality. Instead of 'as established by science', we must now write, 'as a principle which science has found no trace of, but which may be true for all that'."

2. Professor **Herbert Dingle** (in *Science and Human Experience*):

“ Let us consider what we mean by ‘indeterminacy’. There are two meanings of the word, which we must clearly distinguish. First, when we say that a system is indeterminate, we may mean that its state cannot be described in terms involving only what has happened in the past. When we say that an eclipse of the sun is determined for a certain date, we predict it entirely in terms of the positions and movements of the Earth and Moon before the eclipse takes place. We could not predict it if knowledge of events *after* the eclipse were required: in that case we should say that eclipses were not determined, for they would always come on us unexpectedly. To characterize this meaning of the word, I will call an event (such as an eclipse) which can be fixed entirely in terms of past events, a *predetermined* event.

“ But there is a second meaning of indeterminacy; namely, the quality of an event which is not describable at all in terms of other events, whether past, present, future, or timeless. Events indeterminate in this sense would be capricious, unrelated to one another, and therefore, to the extent to which the indeterminacy exists, intractable to Science.”

“ I do not believe that either kind of indeterminacy exists in Nature; whatever indeterminacy there might be is in the conceptual world of atomic physics. But letting that pass for the moment, I think there has been a confusion of these two kinds of indeterminacy even in our view of what is happening in physics. It seems to me that all that has been introduced is the first kind, whereas it is sometimes assumed that there has been an introduction of the second kind. Thus, when Sir James Jeans writes: ‘ Heisenberg now makes it appear that Nature abhors accuracy and precision above all things,’ I think he is not only attributing to Nature a characteristic meant to apply to our own conceptions, but also that he is not justified in describing that characteristic in those terms at all. What Heisenberg has done is to

transcend *pre*-determinacy in atomic physics; he has not questioned the supremacy of accuracy and precision.

“ Jeans’s reference is, of course, to the principle of uncertainty. Heisenberg’s principle presents us with two alternatives: we can either persist in trying to fit the electron into a space-time framework and accept the unavoidable looseness of the fit, or release the electron from this bondage and retain the principle of strict causality intact. From our point of view the second alternative is clearly the one to be adopted. Apart from the principle of uncertainty altogether, we have seen that there is no *a priori* justification at all for requiring the electron to be describable in terms of space and time: the electron is not a potential phenomenon, and therefore is under no obligation to submit to the abstractions from phenomena. When we try, Procrustes-like, to force it to fit a time-scale, it retaliates by lying partly in the future, and *the reason why it does so is that its actions are determined and it can do no other*. Heisenberg’s principle not only reveals the inappropriateness of our action, but, by making that inappropriateness precise, gives us a clue to the conceptions, not yet formed, which would be appropriate. We have no right to condemn a sphere as an undetermined figure because a plane cloth will not fit over it without creasing. What we must do is, by studying the nature of the creases, to determine the precise figure of the sphere.”

“ This indeterminacy, however we interpret it, pertains only to the conceptual world of atomic physics and not to the world of observation—because after all, that is the most important aspect of the matter for the non-physicist. No amount of theorizing can alter the observed fact that there is a determinism in Nature. We predict an eclipse, and the eclipse happens; we apply heat to water, and the water boils; we throw a stone into the air, and it falls to the ground—all these things, and millions of others like them, happen with absolute regularity. Observations such as these are the parents of our theories, and the theories, however far they may wander, must finally return to sit again at the feet of the

observations. In the latest developments of physics, of course, this is acknowledged. The obvious determinism of Nature is attributed to the mutual cancellation of the individual uncertainties of atoms, for we can observe atoms only in very large numbers. It is a statistical effect, and the eclipse happens when we expect it, not because it must do so, but because it is too improbable that it will fail."

3. Professor H. Levy (in *The Universe of Science*):

"The only test we can apply of the validity of determinism is that involved in the possibility of framing laws that provide accurate explanations and predictions of facts discovered independently of those upon which the laws are based. To the scientific man, then, prediction, explanation, and determinism must go hand in hand. To science the test of determinism rests purely on the success of its forecasts. Whatever else scientific men may say to the contrary, concerning what they believe in their private capacities, as scientists they give the lie to it by proceeding on the assumption that the material that science selects, fashions a determinism in the sense outlined."

"Whatever further may develop, *the form of determinism already separated out by science, stands.* That rests on inescapable evidence."

"'So far as we have yet gone in our probing of the material universe,' said Professor Eddington in a broadcast address on Science and Religion, 'we cannot find a particle of evidence in favour of determinism. There is no need any longer to doubt our intuition of Free Will. When from the human heart, perplexed with the mystery of existence, the cry goes up, What is it all about? it is no true answer to look only at that part of experience which comes to us through certain sensory organs and reply, it is about atoms and chaos: it is about a universe of fiery globes rolling on to impending doom; it is about tensors and non-commutative algebra.'

"Eddington is clearly a genuine single-minded person.

The atmosphere of the quotation itself breathes this. To judge from his scientific work, I should hazard a guess that one of his greatest joys is to carry through a mathematical investigation that is finally verified as physically true, to contribute his quota to the vast number of scientific predictions that have been finally verified, to determine in advance what Nature will do, to use successfully the deterministic method, and to find it valid. The material success of the scientific age is based on precisely this form of prediction, this form of large-scale determinism. No amount of further analysis can destroy this fact, and Eddington himself has spent the greater part of his scientific life in enlarging its sphere of validity. Yet in the face of these obvious facts he asserts that there is not a particle of evidence in favour of Determinism! It is a sweeping statement, which, taken at its face value, could mean nothing less than that the whole of scientific prediction in the past has been an illusion and that the greater part of his life's work is groundless. Eddington does not of course mean this, but when we come to examine what he does mean, we shall see that it is only in a very specialized and limited sense that his statement has to be understood. We have seen how the experimental scientist, restricting the field of his study from the larger universe to smaller fragments of it, has passed from matter through the conceptions of particles and atoms to electrons. We have seen how, when this process is carried through, the possibility of forming isolated systems in neutral environments becomes, as we would expect, more and more difficult. For at each stage in this descent we have either to ignore part of the environment, if experiment shows it can be ignored, or to fasten more *inherent* (immanent) properties on to the smaller isolated system. At these lower ranges the difficulties of finding the appropriate isolated system, if it can be found at all, increase in gathering intensity, for the difficulties of a sufficiently delicate experimental technique at the limits of visibility are colossal. Indeed, at a certain stage they become definitely insuperable. It is, therefore, not unnatural that

the form of prediction capable of comparatively easy application to large-scale operations where isolated systems are the subject of easy study, should break down at some stage. That is really all that Eddington can mean."

"How is it that Eddington can see a form of indeterminacy so fundamental in nature that he is prepared to sweep aside all previous prediction and apparent determinism on the larger scale and assert, 'We cannot find a particle of evidence in favour of Determinism'? The truth is, I think, that he approaches the problem primarily from the standpoint of mathematical explanation . . . a method that has had a tremendous success so long as it has operated within the range of knowledge verifiable at both extremities. Its very success, however, has led some of its adherents to confuse mathematics, the mere handmaiden of experiment, with science, the master himself. The mathematical method is admittedly an invaluable weapon of search, but the validity of its final conclusions is severely circumscribed both by the nature of the initial assumptions and the process itself. Ascending as it does, the process must act as a checking system to examine whether, in fact, the elements into which a larger isolated system has broken down, suffice."

"'There is no need any longer to doubt our intuition of Free Will,' Professor Eddington concludes from his interpretation of the meaning of quantum theory, while Sir James Jeans on the same subject likewise asserts, but with slightly less assurance, 'Science has no longer any unanswerable arguments to bring against our innate conviction of Free Will.' It is a strange conclusion, for it has in fact scarcely the remotest connexion with the grounds on which it is presumably based. No one, of course, doubts our intuition of Free Will. What one is certainly entitled to question is the grounds for that intuition, or that Free Will in this sense has any scientific meaning."

Professor Levy's book is crystal-clear in its searching criticisms.

4. Mr. Bertrand Russell (in *The Scientific Outlook*):

" The Principle of Indeterminacy states that it is impossible to determine with precision both the position and the momentum of a particle; there will be a margin of error in each, and the product of the two errors is constant. That is to say, the more accurately we determine the one, the less accurately we shall be determining the other, and *vice versa*. The margin of error involved is, of course, very small. I am surprised that Eddington should have appealed to this principle in connexion with the question of Free Will, for the principle does nothing whatever to show that the course of nature is not determined. It shows merely that the old space-time apparatus is not quite adequate to the needs of modern physics, which, in any case, is known on other grounds. Space and time were invented by the Greeks, and served their purpose admirably until the present century. Einstein replaced them by a kind of centaur which he called 'space-time', and this did well enough for a couple of decades, but modern quantum mechanics has made it evident that a more fundamental reconstruction is necessary. The Principle of Indeterminacy is merely an illustration of this necessity, not of the failure of physical laws to determine the course of nature.

" As J. E. Turner has pointed out (*Nature*, 27th December, 1930), ' The use to which the Principle of Indeterminacy has been put is largely due to an ambiguity in the word Determined.' In one sense a quantity is determined when it is measured, in the other sense an event is determined when it is caused. The Principle of Indeterminacy has to do *with measurement*, not with causation. The velocity and position of a particle are declared by the Principle to be undetermined in the sense that they cannot be accurately measured. This is a physical fact causally connected with the fact that the measuring is a physical process which has a physical effect upon what is measured. There is nothing whatever in the Principle of Indeterminacy to show that any physical event is uncaused. As Turner says: ' Every argument that, since

some change cannot be *determined* in the sense of *ascertained*, it is therefore not *determined* in the absolutely different sense of *caused*, is a fallacy of equivocation.' ”

5. Professor Max Planck (in *The Universe in the Light of Modern Physics*):

“ It is essential for the healthy development of Physics that among the postulates of this science we reckon, not merely the existence of law in general, but also the strictly causal character of this law. This has in fact almost universally been the case. Further, I consider it necessary to hold that the goal of investigation has not been reached until each instance of a statistical law has been analysed into one or more dynamic laws. I do not deny that the study of statistical laws is of great practical importance: Physics, no less than meteorology, geography, and social science, is frequently compelled to make use of statistical laws. At the same time, however, no one will doubt that the alleged accidental variations of the climatological curves, of population statistics, and mortality tables, are in each instance subject to strict causality; similarly, physicists will always admit that such questions are strictly relevant as that which asks why one of two neighbouring atoms of uranium exploded many millions of years before the other.

“ All studies dealing with the behaviour of the human mind are equally compelled to assume the existence of strict causality. The opponents of this view have frequently brought forward against it the existence of free will. In fact, however, there is no contradiction here; human free will is perfectly compatible with the universal rule of strict causality.”

“ The existence of strict causality implies that the actions, the mental processes, and especially the will of every individual are completely determined at any given moment by the state of his mind, taken as a whole, in the previous moment, and by any influences acting upon him coming from the external world. We have no reason whatever for

doubting the truth of this assertion. But the question of free will is not concerned with the question whether there is such a definite connexion, but whether the person in question is aware of this connexion. This, and this alone, determines whether a person can or cannot feel free. If a man were able to forecast his own future solely on the ground of causality, then and then only we should have to deny this consciousness of freedom of the will. Such a contingency is, however, impossible, since it contains a logical contradiction. Complete knowledge implies that the object apprehended is not altered by any events taking place in the knowing subject; and if subject and object are identical this assumption does not apply."

Professor Planck, alive to the fact that in the absence of exact definitions most controversies tend to degenerate into logomachies, seeks for an exact definition of the causal condition, and finds it in the statement that *an event is causally conditioned if it can be predicted with certainty*. The possibility of making a correct prediction forms an infallible criterion for the agency of a causal connexion, but the two do not mean one and the same thing. In the day-time, Planck remarks, we can predict with certainty the advent of night; but day is not the cause of night.

Planck holds with great firmness the balance between the determinists and the indeterminists, but his sympathies are obviously with the former (the advocates of causality). He holds that nature is bound by the inexorable law of cause and effect, while Man remains a free-willed creature, the master of his fate.

6. Professor **Albert Einstein** holds views of much the same kind. He condemns as "objectionable nonsense" the attribution of "something like free will even to the routine processes of inorganic nature." The indeterminism which belongs to modern physics, he says, is a subjective indeterminism. It simply means that the physicist is unable to follow the course of individual atoms and forecast their activities, not that those activities are undetermined.

7. Dr. **Ludwik Silberstein**, the mathematical physicist of the University of Rome, gives in his *Causality* (a lecture delivered in Toronto in 1932) the following very useful illustration:

“Imagine a thousand male slaves placed by their master on some island and through their steady toil producing for him cotton or maize, or what not. They are picked so as to be, like the radium atoms, perceptibly equal in all relevant respects, from the master’s angle of course: same weight (mass), same height and chest, same strength and efficiency. This being granted, assume that their ‘mortality’ or annual death-rate is invariable and as high as 0.040. (The death-rate in England and Wales for 1876 touched 0.021, and fifty years later dropped a little below 0.012.) This means that our master will lose in the first year of his enterprise forty, in the second year about thirty-eight men, and so on, with the familiar probable errors. Being a good business man and an equally heartless slave-driver, the master will not evince the slightest interest as to the individuality of the ‘souls’ who thus drop out inexorably from his working phalanx. Whether it is Paul or Peter who dies within the year is utterly indifferent to him. The only relevant thing about their passing away, which in fact must be carefully weighed in his commercial plans, is that death-rate itself, the numerical value of the ‘probability’ of *any* slave to die within a year. Our cotton-planter, being neither a naturalist thirsting for knowledge of the natural history of biped mammals, nor a sentimentalist, will be far from feeling pledged to the deterministic principle (with regard to individuals) which for his business in hand is certainly deprived of all heuristic, lucrative virtue. He will be content to adopt the exceedingly practical scheme of probabilities and statistics.

“Suppose, however, that this blessed island is visited by a traveller who happens to know a good deal about medicine and hygiene, and carries also in his breast a keenly sympathetic interest in the life of humans, not just as a mass or social group, but individually. Such a visitor will soon discover

a number of specific differences amongst the slaves yet surviving at the time being, and in the conditions of their environment, and will be able to single out, if not all, at least some, of those who are pretty sure to die within the year. Nay, if some are stricken by an infective disease, he can even render a practical service to our planter, namely by isolating them, in housing and intercourse, from the remaining ones, and thus reducing the death-rate of the phalanx of workers. In fine, he will be far from accepting the summary, indeterministic attitude of the planter, he will find determinism delightful and valuable as well. The simple reason is that this knowledge of and interest in the individual goes much deeper than that of the master, the planter.

" Now, it is true that the individual being is in this case a highly complicated organism when compared with a radium atom, and so also is the manner of its reactions to the environment. But can our modern physicists boast of knowing the structure of the radium atoms, or only of their nuclei, well enough to deny a host of individual differences between them, favourable to disintegration or stability? Far from it. All are unanimous in declaring the *nucleus* of the atom to be alone responsible for radioactivity (while some of the choir of eighty-eight planetary, extra-nuclear electrons take care of its ordinary chemical properties). But the nucleus of, say, a radium atom is itself a highly complicated affair and the exploration of its structure is a problem of possibly a very distant future. Why, not even the structure of an α -particle, the nucleus of helium, is satisfactorily settled, and the nucleus of a radium atom consists of some fifty and odd α -particles, a maze of electrons, and some protons. Nor has anybody dared, thus far, so much as to sketch roughly the grouping of this large number of positive and negative bricklets. In these circumstances, then, a deliberate denial of determinism as regards the breaking up of individual atoms seems as unjustified, and—one might almost say—impertinent, as in the case of decease of those luckless slaves. For what we know, determinism, strict causality, may yet turn out to be

of enormous heuristic value in this field of radioactive disintegration. The attitude of bare probabilities and indeterminacy, a comfortably lazy one, can in the best of cases be considered as temporary and provisional, as something equivalent, in fact, to a veiled confession of man's ignorance of a host of possible details. But a resolute denial or abrogation of the deterministic principle with regard to the 'spontaneous' breaking up of atoms would certainly be premature. The whole question of radioactive disintegration, in fact, is barely in its infancy."

And here we must leave the subject. The balance of opinion is at present heavily on the side of causality, though the precise nature of causality yet remains to be discovered. It is an interesting fact that four mathematicians of such eminence as Eddington and Jeans, Russell and Levy, should pair off in opposite camps. Physicists we almost *expect* to be determinists; they spend their lives up against hard facts and are therefore mostly realists. The majority of eminent mathematicians also are determinists.

(For list of Books of Reference see end of Chapter LV.)

CHAPTER LI

Hypotheses

The nature of Hypotheses, like the nature of Causation, has been the subject of discussion among philosophers for a very long time, and even now opinions differ fundamentally.

The process of tracing any regularity in any complex set of appearances is necessarily tentative; we begin by making any supposition, even a false one, to see what consequences will follow from it; and by observing how these differ from the real phenomena, we learn what corrections to make in our assumption. The simplest supposition which accords with the more obvious facts is the best to begin with, because its consequences are the most easily traced. This rude hypothesis is then corrected, and the consequences deducible from the corrected hypothesis again compared with the observed facts; this may suggest still further correction, until, at last the deductive results actually tally with the phenomenon.

In any hypothesis, we assume a sort of secret inner organization of real things and processes, but it is quite impossible to lay down any rules for the actual construction of hypotheses. Analogy with other phenomena will often lead to suggestions, but success will depend on previous knowledge and on all those qualities which may be summed up in the expression, "inventiveness and resource".

It is, however, important to note that an hypothesis is nothing more than a *mentally constructed and quite imaginary* mechanism, accounting for the facts. We must be under no illusion—to say nothing of a delusion—that our pictorial

conception is representative of the actual machinery of nature. An hypothesis is only one conception amongst many alternative possibilities, and must never be thought of as if it were a real fact.

The conditions of a good hypothesis may be summarized as follows:

1. A good hypothesis must allow both of the application of deductive reasoning and of the inference of consequences capable of comparison with the results of observation.

2. A good hypothesis must not conflict with any laws of nature which are held to be true.

3. In a good hypothesis, the consequences inferred must agree with facts of observation.

A single absolute conflict between fact and hypothesis is fatal to the hypothesis. Descartes's system of vortices was abandoned, not because it was intrinsically absurd and inconceivable, but because it could not give results in accordance with the actual motions of the heavenly bodies.

We may cite a few authorities on the subject:

1. **J. S. Mill.** "An hypothesis is any supposition which we may make (either without actual evidence or on evidence avowedly insufficient) in order to endeavour to deduce from it conclusions in accordance with facts which are known to be real; the supposition being made under the idea that if the conclusions to which the hypothesis leads are known truths, the hypothesis itself either is, or at least is likely to be, true. If the hypothesis relates to the cause or mode of production of a phenomenon, it will serve, if admitted, to *explain* such facts as are found capable of being deduced from it. And this explanation is the purpose of many, if not most, hypotheses."

2. **Dr. W. Whewell**, a former famous Master of Trinity, stressed the "colligation of facts", by a new conception, as the really creative act in scientific induction; the discovery of

the right conception demands "sagacity" and "commonly succeeds by guessing; and this success seems to consist in framing several tentative hypotheses and selecting the right one."

3. Dr. J. Venn distinguished hypotheses from guesses by the seriousness and importance of their subject; in framing an hypothesis we put forward a mental picture tentatively and doubtfully, in the hope that it may turn out to be true.

4. Professor Carveth Read held that no hypothesis is of any use that does not admit of verification (proof or disproof) by comparing the results deduced from it with facts or laws.

5. Professor B. Bosanquet. "An hypothesis is any conception by which the mind establishes relations between data of testimony, of perception or of sense, so long as that conception is one among alternative possibilities and is not referred as a fact to reality. The stress here plainly falls on the *conception*, and the *relations* the conception establishes, rather than on the mind's activity in forming its conceptions and establishing the relations by applying them."

6. Dr. F. C. S. Schiller urges that the function of an hypothesis in the service of science is "to think the new". "The sole essential of a scientific hypothesis is that it should work." "A scientific hypothesis must have a definite meaning, which will permit of deductions being drawn from it;" and "it must be such as to admit of definite tests". The hypothesis accepted from alternatives "should be the one that works best". Discussion of alternative hypotheses is to be encouraged, for "inquiry demands an abundance of hypotheses." "The facts themselves will display a charming ambiguity, and fit into several hypotheses with (approximately) the same facility."—Undeniably all this is admirable advice.

7. **Henri Poincaré.** "Every generalization is an hypothesis. Hypothesis therefore plays a necessary rôle, which no one has ever contested. Only, it should always be as soon as possible submitted to verification. It goes without saying that, if it cannot stand this test, it must be abandoned without any hesitation. This is, indeed, what is generally done; but sometimes with a certain impatience. However, this impatience is not justified. The physicist who has just given up one of his hypotheses should, on the contrary, rejoice, for he has found an unexpected opportunity of discovery. His hypothesis, I imagine, had not been lightly adopted. It took into account all the known factors which seemed capable of intervention in the phenomenon. If it is not verified, it is because there is something unexpected and extraordinary about it, because the physicist is on the point of finding something unknown and new. Has the hypothesis thus rejected been sterile? Far from it. It may be even said that it has rendered more service than a true hypothesis. Not only has it been the occasion of a decisive experiment, but if this experiment had been made by chance, without the hypothesis, no conclusion could have been drawn; nothing extraordinary would have been seen; and only one fact the more would have been catalogued, without deducing from it the remotest consequence."

8. **Newton.** Newton's views are well known: "I frame no hypotheses. For whatever is not deduced from the phenomena is to be called an hypothesis; and hypotheses, whether metaphysical or physical, whether of occult qualities or mechanical, have no place in experimental philosophy."

What Newton really meant was that he never indulged in hypotheses of a wildly speculative sort. He had to make assumptions, of course, or he would have made no progress. And some of his assumptions have proved to be wrong, e.g. that the velocity of light is infinite. But he was an extraordinarily cautious man.

Professor **E. A. Burt**, in his illuminating book, *The*

Metaphysical Foundations of Modern Science, gives an interesting summary of Newton's methods:

"We should expect in Newton a strong insistence on the necessity of experiment, and small patience with ideas about the world which were not deductions, through experiment, from sensible phenomena, or exactly verifiable in experience. His works are filled with a constant polemic against 'hypotheses', by which he usually meant ideas of this character. In the days of his early optical experiments this polemic takes the mild form of declaring for the postponement of hypotheses till accurate experimental laws are established by a study of the available facts.

"Newton's absorbing interest lay in the properties and experimental laws immediately demonstrable from the facts, and these he insisted on absolutely distinguishing from hypotheses. Nothing angered him more than to have his doctrine of the refrangibility of light called an hypothesis; in answer to the charge he affirms with emphasis that his theory 'seemed to contain nothing else than certain properties of light, which I have discovered and regard it not difficult to prove; and if I had not perceived them to be true I would have preferred to reject them as futile and inane speculation, rather than to acknowledge them as my hypothesis.'"

"Newton was involved in squabble after squabble about the nature and validity of his doctrines—with the result, that as the years passed, he felt himself forced to the conviction that the only safe method was to ban hypotheses entirely from experimental philosophy, confining himself rigorously to the discovered and exactly verifiable properties and laws alone. This position is decisively taken in the *Principia* and in all subsequent works; in the *Opticks*, to be sure, he could not avoid some lengthy speculations, but conscientiously excluded them from the main body of the work, proposing them merely as queries to guide further experimental inquiry. The classic pronouncement on the rejection of hypothesis occurs at the end of the *Principia*. 'Whatever is not deduced

from the phenomena is to be called an hypothesis; and hypotheses, whether metaphysical or physical, whether of occult qualities or mechanical, have no place in experimental philosophy. In this philosophy particular propositions are inferred from the phenomena, and afterwards rendered general by induction.’”

“Newton’s first rule of reasoning in philosophy is the principle of simplicity: ‘We are to admit no more causes of natural things than such as are both true and sufficient to explain their appearances. To this purpose, the philosophers say, that nature does nothing in vain, and more is in vain when less will serve; for nature is pleased with simplicity, and affects not the pomp of superfluous causes.’ The second rule is, that ‘to the same natural effects we must, as far as possible, assign the same causes.’”

In the construction of all hypotheses, imagination admittedly plays a highly important part, and on this matter Professor M. R. Cohen’s remarks in his *Reason and Nature* are peculiarly apposite:

“Consider what a poor insignificant fragment of our world we can actually experience at any one time. Not only is it impossible for past and future events to be directly present to us, but only an infinitesimal part of the contemporary world spread in space can be directly reached by optical or other sensory contact. We can, of course, speak of past, future, and distant events as ideally present to the mind on the occasion when we think of them. But assuredly this is not what we ordinarily mean by experiencing things. Having an idea about typhoid is fortunately not the same as experiencing it.

“If imagination, then, denotes the power to see beyond what is actually or materially present, it is the fundamental basis of our whole mental outlook. For even of things physically present, what we mentally see is not the same as what is sensibly experienced. Thus, when I see a friend crossing the street, or when I read about him in a letter, all that is

impressed on me through my sense organs is some patch of diverse colours. On the other hand, what I actually see is also often much less than what is sensibly present. Of the innumerable objects about us, only a few attract our attention. When those in whom we are vitally concerned change their features, how often do we continue to see them according to their past image! Imagination thus seems to build up our conscious world by adding to and subtracting from the world of actual sensible experience.

“Yet as in the case of other rivals of reason, only a certain duplicity in the use of the term imagination makes it possible to oppose it sharply to reason. The term imagination does often denote something fanciful as contrasted with what is real or natural. Thus, to Bacon, imagination ‘being unrestricted by laws, may make whatever unnatural mixtures and separation it pleases.’ To be imaginative in this sense is to be preoccupied with daydreams. In this sense we often attribute to a lively imagination the habitual lying of children who are not sufficiently developed to distinguish clearly between what has and what has not happened. On the other hand, the term *creative* or *constructive imagination* also denotes the process whereby a great scientist or historian grasps new possibilities involved in old principles, or reconstructs a comprehensive picture of past life on the basis of fragmentary remains. In these cases there is certainly no inherent opposition between imagination and reason.

“Sober history shows that, in the field of scientific discovery, authenticated cases of inspiration—of flashes of truth coming suddenly upon us—are all preceded by a period of rational, systematic preparation and searching efforts.”

Professor Cohen’s book is of a kind which will have a sobering effect on those men of science whose preoccupation with daydreams is so apt to dull the edge of their reason.

(For list of Books of Reference, see end of Chapter LV.)

CHAPTER LII

Mathematics and Mathematicians

The Supposed Aloofness of the Mathematician

In 1846,* the French astronomer **U. J. J. Le Verrier** (1811-77) determined the position of the planet Neptune by calculations based on data derived from certain perturbations of Uranus, and **Galle**, receiving the necessary instructions from Le Verrier, within half an hour found the planet in the sky. Le Verrier, though an astronomer, was first and foremost a mathematician, and when some years afterwards he was in the observatory of the still more famous French astronomer, **Camille Flammarion** (1842-1925), Flammarion, who had his telescope turned on Neptune, asked him if he would like to see the planet. "No, no," was the answer; "as a matter of fact I have never seen it; and I do not want to see it."

Now Le Verrier was not devoid of curiosity, for he had been curious enough to determine the position of an unknown perturbing agent. But sometimes it is suggested that a mathematician's curiosity is almost always limited to his own subject? Is this true?

It cannot always be the case. One well-known exception is that of a leading English mathematician who has taken a special interest in the academic qualifications of the Author of the Universe, as well as many other matters of general interest. Doubtless, however, there is a suspicion of truth

* **John Couch Adams**, the Cambridge astronomer, had made similar calculations in 1845.

in the old gibe that the ordinary mathematician is merely a walking problem. On the general subject of "Mathematics and Culture", we may quote from the Presidential address of Mr. J. W. N. Sullivan, the well-known *Times* leader-writer and authority on the history of mathematics, to the London Branch of the Mathematical Association in 1932:

"Culture is chiefly, I think, the refinement and education of all our sensibilities, including our intellectual and animal sensibilities, and not only of those that are concerned with the arts. On what grounds can it be asserted that mathematics has a cultural influence? I gather, from various remarks that I have come across in the writings of various authors, that mathematicians have sometimes been regarded as almost the least cultured of human beings. Mathematicians have sometimes been presented to us as being of so dry a nature and so warped a mind that almost every human interest is alien to them. Even James Clerk Maxwell, when a student at Cambridge, complained that some of the men there saw the whole universe in terms of quintics and quantities and seemed incapable of realizing that the universe had any other aspects. And we have all heard of the mathematician who, on being persuaded to read Milton's *Paradise Lost*, said at the end that he didn't see what the man was trying to prove. Now it must be admitted that there are a good many mathematicians who lend colour to this assertion of insensitiveness. It seems to be possible for a man to have great mathematical ability and yet to be, in other respects, practically a barbarian. It would seem, in fact, that mathematics is a curiously isolated activity. It seems to be able to flourish in almost complete isolation from the rest of the elements of a man's nature. But we shall do well to distrust this conclusion. Psychologists are not disposed, nowadays, to talk about isolated mental faculties. Indeed, some of them have gone to the other extreme, and deny the existence of any special abilities at all. A genius, according to them, is simply a man with an abnormal amount of general ability. What line his genius takes is dependent on his circumstances.

I find it difficult to go as far as this. I find it difficult to believe that, if their circumstances had been interchanged, Napoleon would have composed the Ninth Symphony and Beethoven would have won the Battle of Austerlitz. But although I am disposed to believe that there is a special mathematical ability I am not disposed to believe that it exists in complete independence of everything else. I think we must admit, however, that it is more isolated than some other special abilities.

“Nevertheless, can we claim for mathematics any general cultural influence?

“One of the chief functions of an art is to give æsthetic pleasure, and before we decide that the cultural value of mathematics is that of an art, we must ask whether mathematics gives æsthetic pleasure. I do not think there is much difficulty about maintaining this. We all know, as a matter of fact, that mathematics has a very strong æsthetic aspect. Every mathematician feels the difference between an ‘elegant’ proof and a proof which, as Lord Rayleigh said, ‘merely commands assent.’ Everyone realizes the difference between the mathematician who is an artist and the mathematician who is merely a workman. Many mathematicians have written about mathematics in a kind of prose poetry. Sylvester, who apparently saw all the colours of a sunset in a page of algebra, is a celebrated example, but I cannot forbear to quote a perhaps lesser known example from Boltzmann, quoted by Max Planck in the recent Maxwell Commemoration Volume. Boltzmann is describing a paper by Maxwell on the Kinetic Theory of Gases. He says:

“‘At first are developed majestically the Variations of the Velocities, then from one side enter the Equations of State, from the other the Equations of Motion in a Central Field; ever higher sweeps the chaos of Formulæ; suddenly are heard the four words: put $n = 5$. The evil spirit V (the relative velocity of two molecules) vanishes, and the dominating figure in the bass is suddenly silent; that which had seemed insuperable being overcome as if by a magic stroke.

There is no time to say why this or that substitution was made; who cannot sense this should lay the book aside, for Maxwell is no writer of programme music, who is obliged to set the explanation over the score. Result after result is given by the pliant formulæ till, as unexpected climax, comes the Heat Equilibrium of a heavy gas; the curtain then drops.'

"We must admit, I think, that, whatever we may think of Boltzmann's analogy, he is certainly expressing a strong æsthetic reaction. And it was Henri Poincaré, I think, who is reported to have said that in all his researches he had never been interested in finding the value of x , but solely in the beauty of the methods by which he found that value. There is no need to multiply examples. Every mathematician knows that one of the chief charms, perhaps the chief charm, of mathematics, resides in its æsthetic aspect."

Mathematics and Probability

The mathematical theory of probability is essentially a subject for the trained mathematician, and here we can refer to it in only its very general aspects.

It has been truly said that, as a rule, intolerance arises from inability to see how differently different persons are affected by real *probabilities*. Different minds may regard the very same event at the same time, with widely different degrees of probability. It was De Morgan who said that by degree of probability we really mean or ought to mean *degree of belief*, but later writers have tended to avoid the term "belief" as being obscure, and to regard the theory of probability as dealing with the available *quantity of knowledge*. An event is only probable when our knowledge of it is diluted with ignorance, and mathematical calculation is needed to discriminate how much we do and do not know. The whole business of insurance of all kinds is based upon this theory.

We may quote instructively from Dr. **Harold Jeffreys'** *Scientific Inference*:

“ Probability expresses a relation between a proposition and a set of data. When the data imply that the proposition is true, the probability is said to amount to certainty; when they imply that it is false, the probability becomes impossibility. All intermediate degrees of probability can arise.

“ The relation of the laws of science to the data of observation is one of probability. The more that facts are in agreement with the inferences from a law, the higher the probability of the law becomes; but a single fact not in agreement may reduce a law, previously practically certain, to the status of an impossible one. Newton’s inverse square law of gravitation first became probable when it was shown to give the correct ratio of gravity at the earth’s surface to the acceleration of the moon in its orbit. Its probability increased as it was shown to fit the motions of the planets, satellites, and comets, and those of double stars, with an astonishing degree of accuracy. Le Verrier’s discovery of the excess motion of the perihelion of Mercury scarcely changed this situation, for the phenomenon was qualitatively explicable by the attraction of the visible matter within Mercury’s orbit. When it was found that such matter could not actually be present in sufficient quantity to account for the anomalous motion of Mercury, Newton’s law, as a universal proposition, was first shown to be wrong.

“ The fundamental notion of probability is intelligible *a priori* to everybody, and is regularly used in everyday life. Whenever a man says ‘ I think so ’ or ‘ I think not ’ or ‘ I am nearly sure of that ’ he is speaking in terms of this concept; but an addition has crept in. If three persons are present with the same set of facts, one may assert that he is nearly certain of a result, another that he believes it probable, while the third will express no opinion at all. This might suggest that probability is a matter of differences between individuals. But an analogous situation arises with regard to purely logical inference. One person, reading the proof of Euclid’s fifth proposition, is completely convinced; another is entirely unable to grasp it; while there is at any rate one

case on record when a student said that the author had rendered the result highly probable. Nobody says on this account that logical demonstration is a matter for personal opinion. We say that the proposition is either proved or not proved, and that such differences of opinion are the result of not understanding the proof, either through inherent incapacity or through not having taken the necessary trouble. The logical demonstration is right or wrong as a matter of the logic itself, and is not a matter for personal judgment. We say the same about probability. On a given set of data p , we say that a proposition q has in relation to these data one and only one probability. If any person assigns a different probability, he is simply wrong, and for the same reasons as we assign in the case of logical judgments. Personal differences in assigning probabilities in everyday life are not due to any ambiguity in the notion of probability itself, but to mental differences between individuals, to differences in the data available to them, and to differences in the amount of care taken to evaluate the probability."

The reader may feel quite confident, even though the mathematical theory of probability is quite beyond him, that the general *notion* of probability, as it enters into the interpretation of mathematical equations, is essentially non-mathematical and may be easily understood. For it then signifies something which is akin to an intellectual *bias*, a bias which sways the mind in a particular direction, and gives a colour, sometimes a brilliant and very fast colour, to the mind's interpretation. It is partly for this reason that it is doubtful if a mathematician ought to attempt to give a physical interpretation to the equations which he himself has worked out.*

* For some elementary notions of the mathematical theory of probability, see the author's *Craftsmanship in the Teaching of Mathematics*, pp. 544-60.

The Limitations of Mathematics

In the course of a striking address to a distinguished audience, one of the sanest and most eminent of English mathematicians recently said:

“ A mathematician is not concerned with physical reality at all. It is impossible to prove by mathematical reasoning any proposition whatsoever concerning the physical world. It is the business of mathematics to supply physicists with a collection of abstract schemes which it is for them to select from and to adopt or discard at their pleasure. A large number of different schemes of geometry have been constructed, Euclidean or non-Euclidean, of one, two, three, or any number of dimensions. All these are of complete and equal validity. They embody the results of the mathematicians' observations of their reality, a reality far more intense and far more rigid than the dubious and elusive reality of physics. The old-fashioned geometry of Euclid, the entertaining seven-point geometry of Veblen, the space-times of Minkowski and Einstein, are all absolutely and equally real. When a mathematician has observed them, his professional interest in the matter ends. It may be the seven-point geometry that fits the facts best. There may be three dimensions in this room and five next door. The function of the mathematician is simply to observe the facts about his own hard and intricate system of reality, that astonishingly beautiful complex of logical relations which forms the subject-matter of his science.”

Commenting on the address, an able leader-writer in *The Times* wrote:

“ This is a high doctrine, the more alluring at a time when the very difficult mathematics of Einstein and Minkowski are alleged to comprehend the universe more completely than was done by Euclid and Newton. But does it not contain a subtle evasion of the difficulty, or at the least a partial definition of the word “ reality ”? We may admit freely

that the mathematical mill grinds out a logical and consistent meal; but, however it may employ refined and ingenious machinery, the produce cannot be more real than the grist. The mathematical grist consists of numbers, which in themselves are abstractions. Two and two certainly make four, but in the world that 'common-sense' calls real the units are not figures, but apples, eggs, atoms, molecules, and so forth. It is a question of observation and not of logical theory whether four apples are four times one apple. Observation of such a kind often brings surprises. The realness of reality rests, in the common-sense view, and possibly also in the philosophical view, on the circumstance that it is apt to be a well of surprises, to reveal things that quite certainly neither common sense nor philosophy put there."

In "The Place of Mathematics in the Interpretation of the Universe", a searching article in *Philosophy* (Vol. VII, 25), Dr. F. A. Lindemann, Professor of Experimental Philosophy at Oxford, also makes use of the analogy of a mill. He says:

"It is sometimes forgotten that mathematics is really only a form of symbolic logic. It is a technique which we have invented to render possible in complicated cases quick and accurate quantitative thought. But its function is to compare and measure, to redistribute and rearrange, to combine or analyse, or symbolize, not to create or discover. Starting with a given number of physical assumptions, we can twist and turn them in the mathematical mill until the result is as different from the initial material as the sausage is from the quadruped that walks into the machine. But the validity of the final product is no greater and no less than the validity of the primary hypotheses. A competent mathematician can undertake to pass his initial premises through the most elaborate and complicated logical processes with infallible accuracy. But in the end he can only guarantee that the result follows from the premises no more and no less."

This passage should be laid to heart by all interpreters

of mathematical equations. We may make just one comment. The sausage that comes out of the machine is different in *form* and exhibits new *combinations* compared with the quadruped that walked into it, *but there are no additions*. It is exactly the same with mathematical symbols in an equation. If we put into the equation one symbol for space and another for time, and if when those symbols emerge from the equation they are in combination, and the new combination suggests, say, curvature of some kind, some interpreters may be inclined to infer that space and time are necessarily combined in nature and that the combination space-time is necessarily curved. On the basis of such an assumption we may proceed to create a finite universe and do all sorts of other wonderful things. Of course the real relativity problem is nothing like so simple as this elementary analogy; nevertheless the construction of space-time is just a personal interpretation of mathematical symbolism. "Your particular interpretation of an equation will almost inevitably depend on your personal philosophical leanings. There can be nothing objective about your interpretation. At best the truth of the interpretation can be nothing more than an affair of probability, and perhaps probability so slight as to amount to impossibility."

Naturally, equations must be interpreted, but the interpretations are nothing more than hypotheses until they are verified. To put forward an hypothesis as if it represented "reality", "objective truth" (call it what you will), is something like loading the dice.

Professor Lindemann usefully remarks:

"There are, it is true, people who are content to find salvation in a system of symbols without feeling any need to seek any physical substratum for their operations. They are satisfied with a Physical World composed of little black marks on a white sheet of paper. Such an outlook seems unlikely to be fruitful. Kepler's laws subsumed in simple symbols the motions of the planets. Nobody would claim that Newton should have been content with these elegant

generalizations. Progress usually comes when a physical meaning is given to the arid formalism of mathematics. It is when mathematics is employed to clarify one's thoughts rather than to escape from them that advances in the interpretation of the universe are made."

With all this we must agree. Nevertheless, an imagination which is uncontrolled must inevitably lead the worker astray.

No less a man than Mr. **Bertrand Russell** has said, "Mathematics is the science in which we do not know whether the things we talk about exist, nor whether the conclusions are true." The reader should try to realize that this is not a piece of cheap cynicism but sober fact. If there is one mathematician who would shrink from dogmatic interpretation, it is assuredly Mr. Russell.

We may conclude the chapter with a quotation from *Mysticism in Modern Mathematics*, by Mr. **Hastings Berkeley**:

"It has long been a common-place of observation, that many men of great intellectual ability, capable in general of handling abstract subjects of thought with uncommon ease, are nevertheless apparently quite unable to learn mathematics. There is something in the subject, or in the manner of teaching it, which revolts them. I am reminded of a friend who, having taken up and dropped the study of pure mathematics, explained to me that he had abandoned the subject because, as he expressed it (with an obviously intentional touch of humour), he found that it required a kind of low cunning which he was destitute of. Expressed seriously, without whimsical exaggeration, there is in the orthodox exposition of mathematical symbolism much which, to many people, seems to be mere sophistry, paradox, and word-play. They know, indeed, that it cannot in fact be so, since contact with the practical soon makes an end of all conclusions founded upon sophistry, paradox, and word-play; and the conclusions of mathematics are in general of eminent practical

application. They conclude therefore that they have essentially "unmathematical" minds. This really means no more than that they are unable to learn mathematics, and leaves us quite in the dark as to why people with logical heads should suppose themselves incompetent to reason logically about the very few, definite, and stable concepts which are the subject-matter of the science."

That there are such people must of course be admitted, and more than one has been made Chancellor of the Exchequer. But it is very puzzling.

(For List of Reference Books see end of Chapter LV.)

CHAPTER LIII

Idealism and Other Mysteries in Physics

The British Leaders of the New School

All the world knows that Sir Arthur Eddington and Sir James Jeans are eminent mathematicians, and that at least the former is a particularly able astronomical observer as well. And both evidently have a good working knowledge of physics. Their mathematical work commands respect and assent throughout the mathematical world, but as interpreters of mathematical results they are not always followed, and sometimes they are opposed. The reasons for this opposition seem to be: (1) their interpretations are put forward a little dogmatically, and as if these were inevitable interpretations; (2) they have adopted a philosophic attitude which it is exceedingly difficult to justify so far as its basic relations to mathematics and physics are concerned; (3) they have attempted (in books for which we certainly all feel admiration) to give popular accounts of extremely technical work in mathematics and physics. These books have admittedly excited a tremendous amount of public interest and have helped the plain man to understand much about modern physical science. But much of the technical evidence on which some of the opinions were based is, necessarily, omitted, and thus the views of readers of the books are, almost inevitably, likely to be tinged with the personal philosophic prepossessions of the authors. We refer, in the main, to Eddington's *Expanding Universe* and Jeans's *Mysterious Universe*; these lighter

works are in marked contrast with such standard works as Jeans's *Astronomy and Cosmogony*, Eddington's different works on *Relativity*; and certain others. It is not for a moment suggested that the books are in the slightest degree superficial. Their fault is, if fault it be, that they attempt to explain in popular language certain matters which simply cannot be so explained.

We will quote one or two passages, taken quite at random, from different works of both authors, not for the purpose of summarizing the author's general views, but rather for the purpose of illustrating their methods of exposition. We will then quote from some of their commentators.

1. From Sir Arthur Eddington's *Physics and Philosophy*:

"The man who, on receiving a telegram, imagines that the handwriting is that of the sender, betrays complete ignorance of the nature of the transmission. We often make equally absurd mistakes with regard to the messages received by our minds from the external world. The messages as we receive them are dressed up with conceptions such as colour, substance, spatioussness. This dress is no part of the external world; it is put on when the message arrives, for the transmitting mechanism by its very nature is incapable of conveying such characteristics. I am inclined to treat *time* as an exception—the one conceptual characteristic of the physical world with which we may have direct acquaintance. I do not know how direct is the contact of the mind with physical time when we experience in our consciousness the going on of time, but at least there is no evident intervention of a long chain of physical transmission. Mind is the first and most direct thing in our experience, all else is remote inference."

"There is often a tendency to divide our assertions about the physical universe into 'hard facts' and 'theoretical conjectures'. There is no such separation. For example, in my own subject, astronomy, there are no hard facts about the celestial bodies. The only phenomena an astronomer can observe and measure are phenomena occurring in his observatory. This has been translated into knowledge of an

extra-terrestrial universe by giving to the observational results a theoretical interpretation."

"An electron is no more (and no less) hypothetical than a star. Nowadays we can count the electrons one by one in a Geiger counter, as we count the stars one by one on a photographic plate. In what sense can an electron be called more unobservable than a star? I am not sure whether I ought to say that I have seen an electron, but I have the same doubt as to whether I have seen a star; if I have seen one, I have seen the other. I have seen a disc of light surrounded by diffraction rings, which has not the least resemblance to what a star is supposed to be; but I give the name star to the object which some hundred years ago started the chain of causation which has resulted in this curious light-pattern. Similarly, I have seen a wavy trail not in the least resembling what an electron is supposed to be; but I give the name electron to the object which has caused this trail to appear. How can it possibly be maintained that I am making an hypothesis in one case and not in the other?

"I do not think that either the star or the electron should be called a hypothetical entity. We make no hypothesis by merely giving a name to that which is the origin of certain impressions which reach our senses. But it is difficult to separate the name from the hypothetical images that are commonly associated with it. No doubt hypothetical properties and characteristics have often been attributed to electrons, and some of these have turned out to be erroneous. But I rather think that the same thing has sometimes happened to the stars." (*Philosophy*, VIII, No. 29.)

A star is able "to start a chain of causation"; presumably, therefore, it is exempt from the new law of indeterminacy!

2. From Sir Arthur Eddington's *The Nature of the Physical World*, chapter on "Science and Mysticism":

"There are waters blown by changing winds to laughter
And lit by the rich skies, all day. And after,
Frost, with a gesture, stays the waves that dance

And wandering loveliness. He leaves a white
Unbroken glory, a gathered radiance,
A width, a shining peace, under the night."

"The magic words bring back the scene. Again we feel Nature drawing close to us, uniting with us, till we are filled with the gladness of the waves dancing in the sunshine, with the awe of the moonlight on the frozen lake. These were not moments when we fell below ourselves. We do not look back on them and say, 'It was disgraceful for a man with six sober senses and a scientific understanding to let himself be deluded in that way. I will take Lamb's *Hydrodynamics* with me next time.' It is good that there should be such moments for us. Life would be stunted and narrow if we could feel no significance in the world around us beyond that which can be weighed and measured with the tools of the physicist or described by the metrical symbols of the mathematician.

"Of course it was an illusion. We can easily expose the rather clumsy trick that was played on us. Æthereal vibrations of various wave-lengths, reflected at different angles from the disturbed interface between air and water, reached our eyes, and by photoelectric action caused appropriate stimuli to travel along the optic nerves to a brain-centre. Here the mind set to work to weave an impression out of the stimuli. The incoming material was somewhat meagre; but the mind is a great storehouse of associations that could be used to clothe the skeleton. Having woven an impression, the mind surveyed all that it had made and decided that it was very good. The critical faculty was lulled. We ceased to analyse and were conscious only of the impression as a whole. The warmth of the air, the scent of the grass, the gentle stir of the breeze, combined with the visual scene in one transcendent impression, around us and within us. Associations emerging from their storehouse grew bolder. Perhaps we recalled the phrase 'rippling laughter'. Waves—ripples—laughter—gladness—the ideas jostled one another. Quite illogically we were glad; though what there can possibly

be to be glad about in a set of æthereal vibrations no sensible person can explain. A mood of quiet joy suffused the whole impression. The gladness in ourselves was in Nature, in the waves, everywhere. That's how it was.

“It was an illusion. Then why toy with it longer? These airy fancies which the mind, when we do not keep it severely in order, projects into the external world should be of no concern to the earnest seeker after truth. Get back to the solid substance of things, to the material of the water moving under the pressure of the wind and the force of gravitation in obedience to the laws of hydrodynamics. But the solid substance of things is another illusion. It too is a fancy projected by the mind into the external world. We have chased the solid substance from the continuous liquid to the atom, from the atom to the electron, and there we have lost it. But at least, it will be said, we have reached something real at the end of the chase—the protons and electrons. Or if the new quantum theory condemns these images as too concrete and leaves us with no coherent images at all, at least we have symbolic co-ordinates and momenta and Hamiltonian functions devoting themselves with single-minded purpose to ensuring that $qp - pq$ shall be equal to $i\hbar/2\pi$.

“By following this course we reach a cyclic scheme which from its very nature can only be a partial expression of our environment. It is not reality but the skeleton of reality. ‘Actuality’ has been lost in the exigencies of the chase. Having first rejected the mind as a worker of illusion we have in the end to return to the mind and say, ‘Here are worlds well and truly built on a basis more secure than your fanciful illusions. But there is nothing to make any one of them an actual world. Please choose one and weave your fanciful images into it. That alone can make it actual.’ We have torn away the mental fancies to get at the reality beneath, only to find that the reality of that which is beneath is bound up with its potentiality of awakening these fancies. It is because the mind, the weaver of illusion, is also the only

guarantor of reality that reality is always to be sought at the base of illusion. Illusion is to reality as the smoke to the fire."

Not all philosophers will accept Sir Arthur's philosophy, but most men of science will envy the obvious glow with which Sir Arthur quotes Rupert Brooke.

3. From Sir James Jeans's *The Mathematical Aspect of the Universe*:

"When we arrange the general phenomena of nature in the new four-dimensional space-time framework provided by the theory of relativity—when we project them on to such a background—they become consistent and make sense; if we refuse to do this, they become mere nonsense and compel us to abandon our belief in the uniformity of nature. Thus we must give up our old belief in space and time as objective realities, and replace them by a new framework, in which it is meaningless to speak of a point of space or an instant of time. Points in the framework represent events; the distance from one event to another is called the 'interval', and involves a blend of space with time. Our old principles of 'shortest length' and 'least time' cannot even be expressed in this new framework; the only principle which can possibly have any consistent or logical meaning is one of 'least interval'.*

"And in actual fact this principle is found to govern and to predict the whole motion of the universe, except possibly for the internal motions of the atom. It equally governs the motion of a ray of light and of a moving body, and it remains valid—or so we suspect, although this is not fully confirmed yet—whatever physical agencies are in action, whether gravitation, electricity, or what not. The presence of a gravitating mass such as our earth does not 'Draw a body off from its rectilinear path', as Newton thought, by exerting forces; it twists up the framework so that the path of 'least interval' itself becomes curved." (*Philosophy*, VII, No. 25.)

* See Mathematical Note, page 1008.

There are certain points in this passage which seem really baffling. We have to procure from the "theory of relativity" a nebulous thing called "the new space-time framework"; into that framework we have to "arrange" "the general phenomenon of nature", which seems to be the same thing as "projecting them on a background". Does "arrange" mean "project mathematically" or does "project" mean merely "arrange"? When we have done this, the phenomena "become consistent" and "make sense". Apparently therefore the phenomena of nature were inconsistent and did not make sense before they were "arranged" and "projected". If we "refuse" to "arrange" and "project", the phenomena "become" mere nonsense. The present writer did "not refuse" to select various "phenomena of nature", and did not refuse to try to arrange and project them in a space-time framework and background borrowed from the theory of relativity, so the phenomena *ought* not to have "become mere nonsense", but they did, and sadly he confesses it. Then, again, Sir James talks about physical "agencies" being in "action", but assuredly determinacy and causation have been "kicked out of physics." Once more: the "presence" of a gravitating mass (not the gravitating mass itself, be it noted) does not exert a force, but "it twists up the framework". The present writer vainly strove to picture the "twisting up" of that abstraction, not by a "force", which is forbidden, but by a "physical agency in action". But he takes comfort in Sir James's words: the principle of least interval "remains valid—or so we suspect, although this is not fully confirmed yet." *

And so we await, with what patience we can, the confirmation of that suspicion.

"A framework which curves back on itself and closes up does not necessarily resemble the earth or a sphere in its geometry. At first Einstein thought that the closing up of the universe was more like what we obtain when we roll

* See Mathematical Note, p. 1008.

a sheet of paper into a cylinder, so that in one direction there was no closing up at all. This one direction he identified with time, so that space became finite while time remained infinite, extending from an eternity back in the past, through the present, to an eternity in the future. Recent work by Lemaître and others suggests that this cylinder must be replaced by a cone or horn-shaped surface—again with time for the open axis. Space, which is the cross-section of the horn, is still finite, but it for ever expands as we move outwards from the mouthpiece of the horn, i.e. as time advances. Time itself has a beginning in the past, although not very clearly defined, represented by the mouthpiece of the horn. But there is no end in the future, time running steadily on from some instant not very long ago to eternity, with the spatial universe expanding all the time.

“At first sight this may look like a mere phantasy—mathematics run amok. Yet we seem to be driven to it not only by theory, but also by what appear to be well-established facts of observation; the expansion of space obtains direct observational support in the apparent recessions of the great extra-galactic nebulæ. If the observations are taken at their face value, these nebulæ are running away from us and from one another at terrific speeds, ranging up to 12,300 miles a second, and the details of their motions are just about what we should expect if space were actually expanding.” (*Philosophy, ib.*)

Sir James thus creates a first New Year's day for us. Time seems to have made a start “not very long ago” at the apex of the cone forming that wonderful horn. And before that? There *wasn't* a before that: time hadn't started then. And at the dawn of that First New Year's day, space, though even then apparently blended with the newly-born time, was obviously an infinitely small thing, also at the extremity of the cone. Then time and space began to grow, time running down the axis of the cone, and space, “which is the cross-section of the horn”, running along with it and

ever expanding as (presumably) a two-dimensional circular cross-section. The reader will ask, what about the space outside the cone? Such a question is a rude one, and must be disallowed. Indeed, how can there be anything outside the cone, since there is nothing in the equation to suggest it?

Sir James refers to the expansion of space as having "direct observational support". But in what way? the recession of the nebulae certainly tells us nothing about the expansion of *space*.

Sir James will probably reply, "You don't understand it." It would be a well-deserved gibe, for some of us frankly do not.

Honestly, would it not be preferable to let the equations remain uninterpreted until we have a few more facts of observation from which interpretations can be verified?

4. From Sir James Jeans's latest book, *The New Background of Science*:

"We shall see the fundamental contrast between the old science and the new very clearly if we compare the beginning of Newton's *Principia* in which the mechanistic view of nature was first put in perfect logical form, with the beginning of Dirac's *Quantum Mechanics*, which represents the most complete exposition of the new theory of Quanta at present in existence.

"Newton wrote in 1687:

"'Every body perseveres in its state of rest, or of uniform motion in a straight line, unless it is compelled to change that state by forces impressed thereon. The alteration of motion is ever proportional to the motive force impressed . . . ;'

"and Dirac in 1930:

"'When an observation is made on any atomic system that has been prepared in a given way, and is thus in a given state, the result will not in general be determinate, i.e. if the experiment be repeated several times under identical

conditions, several different results may be obtained. If the experiment be repeated a large number of times, it will be found that each particular result will be obtained a definite fraction of the total number of times, so that one can say there is a definite probability of its being obtained any time the experiment is performed.' ” (p. 44.)

Assuredly these two extracts do not show “the fundamental contrast between the old science and the new”, between the sober and the speculative. Professor Dirac’s statement is unexceptionable in its moderation; it is wholly free from speculation and is soberly representative of actual experimental results. Had Newton been acquainted with modern atomic physics, he would unquestionably have accepted Dirac’s statement wholeheartedly.

Has the “new science” many followers? Sir James Jeans is a distinguished Fellow of the Royal Society. If he will take a ballot of all the other Fellows of that society, I venture to think that there will be a large majority who are still followers of Newton, Faraday, and Maxwell, but who are patiently awaiting the results of present researches in quantum mechanics; a minority who are “unadulterated Relativists”; and a few who support (warmly?) Sir James Jeans’s own new science of shadowland.

We quote one more extract from the same book, in which Sir James makes his personal position quite clear:

“The two conjectures are those of the idealist and realist—or, if we prefer, the mentalist and materialist—views of nature. So far, the pendulum shows no signs of swinging back, and the law and order which we find in the universe are most easily described—and also, I think, most easily explained—in the language of idealism. Thus, subject to the reservations already mentioned, we may say that present-day science is favourable to idealism. In brief, idealism has always maintained that, as the beginning of the road by which we explore nature is mental, the chances are that the end also will be mental. To this, present-day science adds

that, at the farthest point she has so far reached, much, and possibly all, that was not mental has disappeared, and nothing new has come in that is not mental. Yet who shall say what we may find awaiting us round the next corner?" (p. 298.)

I hope Sir James will allow this paragraph to be amended thus: for "the pendulum", read "my pendulum"; for "present-day science" (twice), read "my science".—What will Sir James himself find round that next corner?

Numerous distinguished men have interested themselves in the works of Sir Arthur Eddington and Sir James Jeans. The following quotations will be found of special interest:

1. Dr. W. R. Inge, Dean of St. Paul's, "than whom at present there is no sounder living philosopher", writes in "The New Götterdämmerung" (*Philosophy*, Vol. VII, 26):

"Jeans and Eddington speak of the 'annihilation' of matter. They probably use the word very incorrectly, since radiation is not 'nothing'. But taking them at their word, they say that a time will come when space will be entirely empty. At the same moment, time will be empty too. I defy anyone to think of empty time. The end, therefore, is absolute acosmism or pannihilism. And this, it must be remembered, will occur at a definite date in the future, after which nothing can happen any more.

"This misuse of 'annihilation' is not the only instance in which the astronomers seem to throw unnecessary difficulties in our way. When they speak of 'the expansion of space' or 'the expansion of the universe', they are surely using both words in an unfamiliar sense. What they seem to mean is that the circumference of the sphere which encloses all the ponderable matter of the universe is moving farther from its centre; in other words, that matter is encroaching upon the surrounding vacuum."

"Can we really overcome this difficulty by speaking of the 'space-time continuum'? I turn to the article by Sir

James Jeans in the January number of this Review. 'At first Einstein thought that the closing up of the universe was like a cylinder, so that in one direction there was no closing up at all. This one direction he identified with time, so that space became finite while time remained infinite. Recent work by Lemaître and others suggests that the cylinder must be replaced by a cone or horn-shaped surface, with time for the open axis. Space is still finite, but it for ever expands as time advances. Time has a beginning in the past, but there is no end in the future, time running steadily on to eternity, with the spatial universe expanding all the time.'

"Is it not clear that in order to bring time into the 'horn' it has been completely spatialized? In this guise it is a string with only one end, an utterly impossible conception. Moreover, since the matter in the universe is finite, how can it go on expanding 'to eternity'?"

"Within the last few days I have learned from Professor Piaggio of Nottingham, to whose kindness I am much indebted, that Einstein last year abandoned this theory of a 'universe' expanding to all eternity, and substituted for it the theory that the ponderable matter in the universe alternately expands and contracts. Our astronomers tell us that it is utterly impossible; but henceforth I shall take refuge behind Einstein."

"A common-sense layman may suggest that if the universe is running down like a clock, the clock must have been wound up, and that whatever power wound it up once may presumably wind it up again. However that may be, this new theory of Einstein belongs to a different type of philosophy from his earlier one. Nothing could illustrate more clearly the bewildering state of cosmology as interpreted by the latest science.

"How difficult the problem is may be gathered from the fact that Sir Arthur Eddington, with most commendable frankness, gives it up. He confesses that he can see no way out of the impasse. The Second Law of Thermodynamics is for him the most certain and fundamental of all the laws of

nature, and yet it 'labours under the disadvantage that it is incredible'. He is unwilling to call in an external Creator, which to him and many others seems an *asylum ignorantiae*, and yet he can see no other solution."

"But Sir Arthur Eddington is not quite content to give it up, and he inclines to the same expedient which has been worked out by Sir James Jeans—namely, the resort to a philosophical theory of pure mentalism. Sir James Jeans says that 'the secret of nature has yielded to the mathematical line of attack'. It has won a success 'such as is not shown by the æsthetic, poetic, or moral pictures of the universe'. If he means that the way to make a true picture of the universe is to abstract from all the higher values, and treat them as non-existent, we can only regret that he accepts such a fatal impoverishment of experience; but I can hardly think that this is his meaning. However, he leaves us in no doubt of his acceptance of pure mentalism. 'The picture is one from which everything has dropped out except purely mental concepts. One physical concept after another has been abandoned, until nothing is left but an array of events in the four-dimensional continuum. Nothing seems to possess any reality different from that of a mere mental concept.'

"My contention is that though pure mathematics is gloriously independent of concrete fact, physics and astronomy are not and cannot be. Further, that when the contradictions are in the mind itself, as when the properties peculiar to space and to time are confounded, and when a theory like Entropy, which postulates real time, is introduced into a mathematical scheme in which real time has no place, mentalism is no refuge.

"But mainly I wish to deny that any investigation of the facts of nature, as they are given to us by perception, can logically end in pure mentalism. I maintain that science is fundamentally ontological. It starts with naïve realism or common-sense philosophy. It assumes that the objects which it studies are real. Very soon it is carried far away from naïve realism. It analyses, let us say, a drop of water into

hydrogen and oxygen. Then it further analyses the atoms of these two elements into electrons and protons, and finally contemplates the possibility that the positive and negative units of electricity may cancel each other. Matter has certainly been defecated to a transparency; there is next to nothing left of it. Next to nothing—but ‘the little more and how much it is’. First of all, the dog wags his tail; then the tail wags the dog; then the dog is removed; then the tail; only the wag is left. This last step, I maintain, is illegitimate. From a concrete object, however attenuated, to a purely mental concept, there is no road. If the mathematical scientist adopts the opposite course, and tries to reconstruct a world of concrete fact out of pure concepts, he is taking the same *salto mortale* in the reverse direction.”

“The essentially ontological character of science, which it can never shake off, has been maintained, I think with great cogency, by Meyerson, in his admirable *L'Explication dans les Sciences*. This septuagenarian philosopher lays great stress on what he calls ‘the irrational’ in science. By this word he means only the irreducible, brute fact which must be accepted as given. That there are many such facts in nature seems to me indisputable, and I do not see how room can be found for them in a universe of pure mathematical concepts.”

“I prefer to believe that there never was a time when the world was not, and that there never will be when the world will not be. Empty time is unthinkable. Time and space are as real as the world in which we live.”

2. Mr. **Bertrand Russell** in a review (*Philosophy*, VIII, 30) of Sir Arthur Eddington's *The Expanding Universe*, says:

“As everyone knows, the original Einsteinian law of gravitation was

$$G_{\mu\nu} = 0,$$

but this was subsequently amended to

$$G_{\mu\nu} = \lambda g_{\mu\nu}.$$

The constant λ is called the cosmical constant, and turns out to be capable of giving an astonishing amount of information. It tells us how big the universe was when it was created, and also tells us a great deal about the structure of the atom; it tells us how the universe grows, but does not tell us how long it has been growing.

“The universe is to be conceived as a bubble growing continually bigger until it bursts. Sir Arthur thinks that it has not burst yet, but that it will do so before very long.”

“I am left at the end with an uncomfortable feeling that we cannot possibly know as much concerning the universe as a whole as is implied by some of the developments of the relativity theory. The observational basis is so very much narrower than the inferential superstructure that one's capacity for credulity in the end gives way.”

3. In his book, *The Scientific Outlook*, Mr. **Bertrand Russell** also writes:

“It seems that the world was created at some not infinitely remote date, and was then far more full of inequalities than it is now, but from the moment of creation it has been continually running down, and will ultimately stop for all practical purposes unless it is again wound up. Professor Eddington for some reason does not like the idea that it can be wound up again, but prefers to think that the world drama is only to be performed once, in spite of the fact that it must end in æons of boredom, in the course of which the whole audience will gradually go to sleep.

“Quantum theory in the hands of Heisenberg, Schrödinger and Co. has become more disturbing and more revolutionary than the theory of relativity ever was. Professor Eddington expounds its recent development. It is profoundly disturbing to the prejudices which have governed physics since the time of Newton. The most painful thing about it from this point of view is that it throws doubt upon the universality of causality; the view at present is that perhaps atoms have a

certain amount of free will, so that their behaviour, even in theory, is not wholly subject to law."

"Professor Eddington proceeds to base optimistic and pleasant conclusions upon the scientific nescience which he has expounded in previous pages. This optimism is based upon the time-honoured principle that anything which cannot be proved untrue may be assumed to be true, a principle whose falsehood is proved by the fortunes of bookmakers."

"From a pragmatic point of view, probably the most important thing about such a theory of physics is that it will destroy, if it becomes widespread, that faith in science which had been the only constructive creed of modern times."

"Physicists have been so pained by the conclusions to which logic would have led them that they have been abandoning logic for theology in shoals. Every day some new physicist publishes a new pious volume to conceal from himself and others the fact that in his scientific capacity he has plunged the world into unreason and unreality. To take an illustration: What are we to think of the sun? The sun is nothing but waves of probability. If you ask what it is that is probable, or in what ocean the waves travel, the physicist, like the Mad Hatter, replies: 'I have had enough of this; suppose we change the subject.' If, however, you press him, he will say that the waves are in his formulæ, and his formulæ are in his head, from which however, you must not infer that the waves are in his head. To speak seriously: such orderliness as we appear to find in the external world is held by many to be due to our own passion for pigeon-holes, and they maintain that it is quite doubtful whether there are such things as laws of nature."*

"I will quote Professor Jeans's own summary:

"'To sum up, a soap-bubble with irregularities and corrugations on its surface is perhaps the best representation, in terms of simple and familiar materials, of the new universe revealed to us by the theory of relativity. The universe is not the interior of the soap-bubble but its surface, and we must

* A view that is by no means new. See J. T. Merz, *Religion and Science*.

always remember that, while the surface of the soap-bubble has only two dimensions, the universe-bubble has four—three dimensions of space and one of time. And the substance out of which this bubble is blown, the soap-film, is empty space welded on to empty time.’

“The last chapter of the book [*The Mysterious Universe*] is concerned to argue that this soap-bubble has been blown by a mathematical deity because of His interest in its mathematical properties. Sir James Jeans’s God, like Plato’s, is one who has a passion for doing sums, but being a pure mathematician, is quite indifferent as to what the sums are about. By prefacing his argument by a lot of difficult and recent physics, the eminent author manages to give it an air of profundity which it would not otherwise possess. In essence the argument is as follows: since two apples and two apples together make four apples, it follows that the Creator must have known that two and two are four. To speak seriously: Sir James Jeans reverts explicitly to the theory of Bishop Berkeley, according to which the only things that exist are thoughts, and the quasi-permanence which we observe in the external world is due to the fact that God keeps on thinking about things for quite a long time. The universe, he says, ‘can best be pictured, although still very imperfectly and inadequately, as consisting of pure thought, the thought of what, for want of a wider word, we must describe as a mathematical thinker.’

“The argument is, of course, not set out with the formal precision which Sir James would demand in a subject not involving his emotions. Apart from all detail, he has been guilty of a fundamental fallacy in confusing the realms of pure and applied mathematics. Pure mathematics at no point depends upon observation; it is concerned with symbols, and with proving that different collections of symbols have the same meaning. Physics, on the contrary, however mathematical it may become, depends throughout on observation and experiment, that is to say, ultimately upon sense perception. The physicist asserts that the mathematical symbols

which he is employing can be used for the interpretation, colligation, and prediction of sense impressions. However abstract his work may become, it never loses its relation to experience. It is found that mathematical formulæ can express certain laws governing the world that we observe. Jeans argues that the world must have been created by a mathematician for the pleasure of seeing these laws in operation. If God were as pure a pure mathematician as His knightly champion supposes, He would have no wish to give a gross external existence to His thoughts. The desire to trace curves and make geometrical models belongs to the schoolboy stage, and would be considered *infra dig.* by a professor. Nevertheless it is this desire that Sir James Jeans imputes to his Maker."

4. In his book on *Science and Human Experience*, Professor **Herbert Dingle** of the Imperial College of Science and Technology, asks the question, "What do we mean by Science?" and he replies:

"I take it to be *the recording, augmentation, and rational correlation of those elements of our experience which are actually or potentially common to all normal people.*"

In the course of the book he writes:

"According to Eddington nothing that is not metrical in character can be treated scientifically. Jeans goes still further in the same direction. To him, not only Science, but the whole external universe, is metrical. 'The final truth about a phenomenon,' he writes, 'resides in the mathematical description of it; so long as there is no imperfection in this, our knowledge of the phenomenon is complete.' This conclusion seems to me to be contrary not only to reason but to actual fact."

"It is of course obvious that a large part of the data of Science is non-metrical in character. The schoolboy's name for chemistry is 'stinks', not 'balances', and a very appro-

priate name it is. Biologists observe the flight of birds very closely, but they do not trouble to apply the Fitzgerald-Lorentz contraction, not because it is too small to be important, but because it has no relation to the *kind* of observation they are interested in. It is clear, therefore, that much of the recording and augmentation of our experiences, which is essentially scientific, is not metrical. This is in itself sufficient to refute the doctrine in question: we need look no further in order to disillusion non-scientific thinkers."

"Even in the metrical part of our experiences there are phenomena which lie outside it. Take motion, for example. The system includes the motion of a comet, but it does not include the motion of a fly. We need consider none of the non-metrical aspects of the fly, but only its motion as a piece of matter. The matter is made up of protons and electrons, formed into atoms indistinguishable from those of the comet, and its motion can be described completely in terms of space and time. Nevertheless, the motion of the fly is essentially of a different character from that of the comet; it cannot be included within the closed system of metrical physics. Although itself metrical, we can make nothing intelligible out of it unless we associate it with something non-metrical, which we call 'life'."

"Eddington gives an admirable example of the limitation of Science to measurement which it is worth while to quote, because it shows, as it seems to me, both the strength and the weakness of his position. He says (*The Nature of the Physical World*, pp. 251-2): 'If we search the examination papers in physics and natural philosophy for the more intelligible questions, we may come across one beginning something like this: "An elephant slides down a grassy hillside. . . ." The experienced candidate knows that he need not pay much attention to this; it is only put in to give an impression of realism. He reads on: "The mass of the elephant is two tons." Now we are getting down to business; the elephant fades out of the problem and a mass of two tons takes its place. What exactly is this two tons, the real subject-matter

of the problem? It refers to some property or condition which we vaguely describe as "ponderosity" occurring in a particular region of the external world. But we shall not get much further that way; the nature of the external world is inscrutable, and we shall only plunge into a quagmire of indescribables. Never mind what two tons *refers* to; what *is* it? How has it actually entered in so definite a way into our experience? Two tons *is* the reading of the pointer when the elephant was placed on a weighing-machine. Let us pass on. "The slope of the hill is 60° ." Now the hillside fades out of the problem and an angle of 60° takes its place. What is 60° ? There is no need to struggle with mystical conceptions of direction; 60° *is* the reading of a plumb-line against the divisions of a protractor. Similarly for the other data of the problem. The softly yielding turf on which the elephant slid is replaced by a coefficient of friction, which though perhaps not directly a pointer reading is of kindred nature. No doubt there are more roundabout ways used in practice for determining the weights of elephants and the slopes of hills, but these are justified because it is known that they give the same results as direct pointer readings.

" 'And so we see that the poetry fades out of the problem, and by the time the serious application of exact science begins we are left with only pointer readings. If then only pointer readings or their equivalents are put into the machine of scientific calculation, how can we grind out anything but pointer readings? But that is just what we do grind out. The question presumably was to find the time of descent of the elephant, and the answer is a pointer reading on the seconds' dial of our watch.'

" Now the whole secret of the matter is in the last sentence, which is added as a sort of after-thought. 'The question presumably was to find the time of descent of the elephant.' Naturally, since the time of descent is essentially a metrical quality we should expect the relevant parts of the data to be metrical in character. But suppose the further question is put: 'To find the damage done to the elephant.'

'Two tons' is of no use now; the living, struggling, trumpeting animal must be reckoned with. We can do without the knowledge of the slope of the hill, and the coefficient of friction 'leaves us cold'. As before, the poetry fades out of the problem, and this time it takes the metrical elements with it; but there is still something left, and that something is scientific in character. It involves such things as abrasions and broken limbs; it is approachable with chloroform and X-rays; the problem requires a knowledge of the anatomical structure and physiological processes of elephants—that is, scientific knowledge; and the answer can be stated in scientific terms conveying the same meaning to all normal people.

"The division of common experience into metrical and non-metrical parts, of which only the former can be dealt with scientifically, therefore appears too simple. The *whole* of common experience is open to scientific treatment; part of that which is metrical is included in the physical scheme, and the remainder, together with the non-metrical elements, must be placed in a different scientific category."

5. Professor J. B. S. Haldane, in his work *The Inequality of Man*, writes:

"I have made a rough calculation from data put forward by Jeans of the time which would be needed before a run-down universe got back to a distribution as improbable as the present as the result of mere chance fluctuation. The time is about $10^{10^{100}}$ years. Perhaps this is an exaggeration, for recent work on stellar and nebular velocities suggests that the universe is not so large as I then assumed. It can, however, hardly be less than $10^{10^{83}}$ years. The number in question is altogether inconceivably vast, although a good Christian would feel himself insulted by the suggestion that his life was limited to such a period. If we wanted to write it down in decimal notation, we should require a great many times more figures than there are atoms in the universe, according to Jeans. But that number of years is just the same fraction

of eternity as a second or a century. If an event occurs, on an average, every $10^{10^{100}}$ years, it has already happened an infinite number of times, and will happen an infinite number more. During all but a fraction of eternity of this order of magnitude nothing definite occurs."

The non-mathematician will not be able to form any sort of conception of the number Professor Haldane refers to. The condensed expression stands for

$$10^{1000\text{.....}00}$$

the number of 0's in the index being 100. Even 10^{100} is almost beyond our conception: the number of electrons in the whole universe is said to be only 10^{79} . When people speak of "eternity" they should ponder over such a fragment of it as the vast number of years referred to,* though "fragment", quite wrongly of course, suggests a definite part of eternity. As Professor Haldane says, that number of years is just the same fraction of eternity as is a second or a century.

Professor Haldane also writes:

"Nothing is commoner in physics than to find an equation which fits a set of facts extremely well over a limited range, but then leads to an absurd result. For example, the equation for the density of the air in terms of its height leads to the conclusion that this density suddenly becomes zero at a finite height. Actually the equation works very well for the first five to eight miles, and then ceases to work. A similar situation is not perhaps impossible as concerns entropy. At least two physical alternatives are open. One is the possibility, discussed by Poincaré and others, and persistently ignored by Sir James Jeans, that the universe is a 'fluctuation', i.e. that it has run down in the past and built itself up again by random processes. Another is suggested by a recent paper of Mos-

* 10^{52} years = 10^{50} centuries, or 100 octillions of centuries. But the index here is only 52, whereas the index in the number in question is 1 followed by 100 noughts! One hundred octillions of centuries are, of course, as *nothing* compared with the vast period of time referred to by Professor Haldane. Even the highly trained mathematician has great difficulty in conceiving such a number.

haraffa on the duality of matter and radiation. According to Mosharaffa's views it seems plausible that a universe where the matter had mainly dissolved into chaotic radiation would proceed once more towards aggregation, as did the world of chaotic gas which Sir James Jeans believes was the initial state of our present universe.

"But if such alternatives are ultimately shown to be impossible, why 'creation'? We work back, by means of mathematical physics, to a time when our equations must in some way be modified, and we are then to desert reasoning for the conjectures of certain ancient Semitic races, whose cosmogony, where it can be tested, is more often wrong than right. It is difficult to put down Sir James's liking for the creation hypothesis to anything but the historical accident that that particular myth has been incorporated in our prevailing religion."

6. Dr. H. Levy, Professor of Mathematics at the Imperial College of Science, University of London, "one of the most ruthless logicians in the country", is the author of *The Universe of Science*. In it, he thus refers to Subjective Idealism:

"Subjective Idealism asserts that the individual is aware only of the activities of his senses, his sense data, what is given to his mind by his senses, and of no reality beyond these. The seeming objectivity of the world is then merely a construct, a piecing together of these promptings of his senses. This attitude has been referred to already as a species of human vanity, but of course that does not dismiss it. We who commence at the opposite end of the scale, can recognize that here is an individual reacting to the universe in which man is, but, by an effort of the imagination, separating himself off completely from it. In his thought he is the creator of the greatest works of genius and the most blatant follies of mankind. Has he not constructed them all in his own mind? If there still exists anyone who actually adheres to this theory and follows it, he has isolated himself from the rest of

humanity. It is a brave gesture, but it is the supreme futility. In practice there are no subjective idealists of this type. Even Bishop Berkeley was driven to postulate a God, an objective external entity, in order that he himself might exist as a thought in His mind.

“ Idealism of this type shows itself in the manner in which scientists and laymen alike frequently assume that what is cogent and inescapable to their minds *must* correspond to an inevitable state of affairs in the physical world. The world processes must proceed and must have proceeded according to their logical scheme, as if this consisted of a set of absolute propositions which the mind could set down for all time. This view is the elevation *a priori* of what appears as a mental and logical necessity, above experimental evidence. ‘ As we trace the stream of Time backwards,’ says Sir James Jeans in *The Mysterious Universe*, ‘ we encounter many indications that, after a long enough journey, we *must* come to its source, a time before which the present universe did not exist. Nature frowns upon perpetual-motion machines, and it is *a priori* very unlikely that her universe will provide an example on the grand scale of the mechanism she abhors;’ and again: ‘ It (Entropy) is still increasing rapidly, and so *must* have had a beginning; there *must* have been what we may describe as a “ creation ” at a time not infinitely remote.’ (*The Mysterious Universe*, p. 144.)

“ Sir James Jeans is not here concerned with directly ascertainable evidence, for he discusses events prior to an epoch of possible observation. He takes the evidence he has *now* regarding the physical and mechanical laws of operation. He takes his brain and his rational necessities *now* as a static picture, as he has emerged biologically and socially, and he tells us what his ‘ must ’ is. Having thus stated something about his state of mind *now*, we are left to infer that it is evidence for a past act of creation. He has indulged a purely mental exercise on matters outside the range of possible physical verification; his ‘ must ’ is then singularly inadequate.

“ Here we see the belief expressed that the human mind stands above the mere requirements of the physical world, that its reasoning and its logical proofs are sufficient in themselves to ensure that its findings must be verified. It is a disguised form of subjective idealism, although its exponents may not explicitly avow the philosophical attitude which it mirrors.”

“ Sir Arthur Eddington adopts a view not very different from this. His contention is that, since mathematics deals with abstractions of the common-sense world, representing these as symbols and relations between symbols, the world of science, the scientific picture of the universe, is yet another unreal world, one which in some way violates the common sense of the world of appearance. With the implied claim in both these attitudes that the mathematician’s picture of the universe is also that of the scientist, a claim that has been allowed to stand without challenge, principally because of the dominance that the mathematician has established in our generation over the experimentalist, I shall deal in the sequel. The view of the world familiar to common sense is being assailed on all sides, not alone by direct scientific discovery and the new ranges of experience this has opened up, but by the interpretations that are being placed by scientists themselves on the significance of their work. The ever-growing fashion for purely mathematical explanation in science is raising an issue that may have serious repercussions in the domain of the experimentalist. The time has now arrived when scientists themselves will require to examine carefully the path they are treading.”

Professor Levy also makes some pertinent remarks on *time*:

“ To suggest that the direction of Time, or, as Eddington prefers to call it, the arrow of Time, may be uncertain, or is reversible, is to imply that Time is something completely independent of the unfolding process in nature from which the notion has been abstracted. The direction of time is involved in the sequence of events that constitute our universe,

and unidirectional time is drawn with time by us from that process. They are inseparable. In his *Nature of the Physical World*, Eddington toys at some length with the notion that the time series may be reversible and that we may remain unaware of this. The idea seems to acquire a specious validity as a real problem from the fact that the mathematical equations that describe the ordinary mechanical processes of nature, excluding heat processes, could be interpreted equally well if time were reversed. As far as these equations are concerned, they describe the successive motions of the world machine running forwards or running backwards. They make no distinction between them. The earth, for example, circling around a lone sun might run in either direction. The equations are the same whether time be increasing positively or negatively. To overcome this apparent indeterminacy, Eddington deems it necessary to bring into operation an additional physical factor as a criterion of direction, what is known as the Law of Entropy. In effect this law states that, as Time increases in any system, the amount of heat-energy available for the performance of useful work diminishes. It is, in fact, by an extrapolation of this law over vast ranges of Space and Time that the death of the universe by heat uniformity has been predicted. *Before* and *after* would correspond to greater and smaller capacity of a system to perform work in virtue of its irregular heat distribution. According to Eddington, if there is a doubt whether two stages of the universe correspond respectively to *Earlier* and *Later*, or vice versa, all that is necessary is to measure the Entropy, and its relative magnitudes at the two stages will resolve for us the puzzle that the ordinary mathematical equations are unable to meet.

“Discussion along these lines, it seems to me, betrays an extraordinary confusion between the physics of the real world and the form in which mathematicians attempt to describe it. Time and Time’s arrow indissolubly associated are given to us in the unfolding processes we encounter. They represent the recognition by mankind that these pro-

cesses occur and the process involves order. The intervals between events may be different for onlookers in different circumstances. That is a matter for experimental study, for a comparison of individual methods of measurement, but the *order* of the events is imposed on us and is common to us all. It is truly impersonal; and without this identity in order we could not use the conception of Time in science at all. That is a feature mankind has found and has to accept. If the ordinary mathematical equations as they are usually formulated fail to embody this feature of the time sequence, that is a weakness of the mathematics, and has nothing whatever to do with the fact that man is directly aware of the order in the time series. The Law of Entropy is, of course, a very valuable generalization of experimental fact, but its validity rests not on any *a priori* knowledge, but on a certain broad basis of experiment. The fact is that the mathematicians' equations are merely attempts to formulate the changing processes of the universe in concise form, in a form suitable for predictions. In so far as the direction of Time's arrow is absent from his equations, the mathematician may require, and he does require, to supplement them by associating them with some such experimental law as that of Entropy. The difficulty is of purely mathematical origin. Presented as a problem of the physical universe it is a suitable fantasy for a Wellsian novel. If the mathematical equations are unable to state for us in which direction the earth rotates around the sun, that is simply because the equations necessarily treat the sun and earth as isolated practically from the rest of the system, and definitely and completely isolated in time from their earlier history that involves the stages leading up to the present situation."

The various passages cited above scarcely do the various distinguished authors justice, and the whole of each book and article quoted should be read right through. Not only are they all valuable contributions to a difficult and highly controversial subject, but they provide particularly entertaining

reading. Sir Arthur Eddington's and Sir James Jeans's defences all seem to be hopelessly down, but the two defenders are bonny fighters and doubtless are feverishly busy with repairs.

Mathematical Note (see p. 987).—Sir James Jeans's "least interval" will doubtless make a strong appeal to simple-minded folk who like to think of nature doing everything in the easiest and smoothest way. But the interval is concerned with events in *space-time*, not with space alone or with time alone, and the natural paths from one event to another in space-time frameworks are along geodesics of *greatest* interval, not of least interval. This is a point over which Sir Arthur Eddington himself admitted he had been caught napping, Dr. A. A. Robb having pointed out that "it is not the shortest track but the longest track which is unique." (Eddington, *Space, Time, and Gravitation*, p. 79). Careful writers safeguard themselves over this point, but there are some who still speak of *least* interval, and in such a way as to suggest that it is their corner-stone. The key to the matter is, of course, the difference of sign for space and time in the expression for the interval.

I am indebted to Dr. John Dougall for the following simple and convincing proof of the principle in question.

Let a particle move in space-time from one given event to another. We suppose the motion to be in one dimension, the initial event being $(x = 0, t = 0)$, and the final event $(x = a, t = b)$.

The *interval* taken up in passing from the one event to the other will depend on the relation between x and t during the motion.

By definition:

$$ds^2 = dt^2 - dx^2 \text{ (taking } c = 1\text{).}$$

To a given relation between x and t , there will correspond a definite relation between x and s . Plot the relation *between* x and s in a graph, say OP. Since $dt^2 = dx^2 + ds^2$, the *time* taken between P_1 and P_2 in the particular motion OP_1P_2P is equal to the *length of the arc* P_1P_2 . (Fig. 192.)

We now consider all possible motions subject to the conditions that $(x = 0, t = 0)$ and $(x = a, t = b)$, the initial and final events, are *given*.

Since $x = a$ at the final point, the curve representing the motion, which begins at O, must end somewhere on the ordinate through

A. Also, since the time taken is given, viz. $t = b$, the length of the curve is given, viz. b .

We wish to compare the various intervals consumed in the various motions which may take place subject to these two conditions.

We assert that when the graph is a straight line, the interval is greater than for any other neighbouring curve satisfying the conditions.

The proof is immediate. Let OB be the straight line of length b . (Fig. 193.) Then:

1. If the end point P is above B, the length OP is too great, so that the time condition is not satisfied.

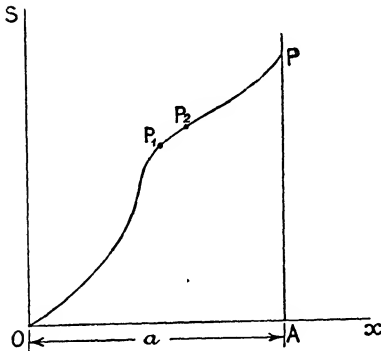

Fig. 192

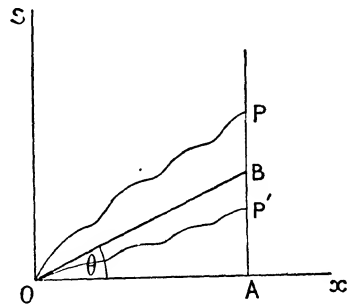

Fig. 193

2. If the end point P' gives the correct length of arc, i.e. the correct time, then obviously P' must fall below B.

3. The interval taken up is the ordinate of the end point. We have shown that $AB > AP'$. Hence, for the path in which the relation between x and t is linear (along OB clearly $\frac{dx}{dt} = \cos\theta$, a constant),

the total interval consumed, i.e. $\int ds$, is a maximum, not a minimum.

It must not of course be thought that space-time intervals are in general immediately apprehended as objective realities.

Mathematical readers may consult Dr. Dougall's article on Relativity in the *Philosophical Magazine* for July, 1930, pp. 81-100.

CHAPTER LIV

The Nobel Prizes: the O.M.

The Nobel Prizes are awarded from the income of a fund bequeathed to trustees by the Swedish chemist, Alfred Nobel, the inventor of dynamite, who died in 1896, leaving a fortune of £1,750,000. The first awards were distributed in 1901. The subjects and the respective awarding authorities are:

1. *Physics*: the Swedish Academy of Science.
2. *Chemistry*: the Swedish Academy of Science.
3. *Medicine* or *Physiology*: the Stockholm Faculty of Medicine.
4. *Literature*: the Swedish Academy of Literature.
5. *Peace*: five persons elected by the Norwegian Storting.

The prizes are open to the whole world, and so impartial are the awards that not one of them ever seems to have been questioned. A very high standard is expected, and the prizes are by no means always given. There was a time when Fellowship of the Royal Society was looked upon as the blue ribbon in the world of science, but it is probably the secret wish of every Fellow of the Royal Society who is a physicist or a chemist or a biologist to become a Nobel Laureate.

Great Britain has been exceptionally successful in *physics*, as the following list shows:

- 1904. the late Lord Rayleigh, O.M.
- 1906. Sir J. J. Thomson, O.M.
- 1915. Sir W. H. Bragg, O.M., and Professor W. L. Bragg.

- 1917. Professor C. G. Barkla.
- 1927. Professor C. T. R. Wilson (and A. H. Compton).
- 1928. Professor O. W. Richardson.
- 1930. Sir C. V. Raman (India).
- 1933. Professor P. A. M. Dirac (and E. Schrödinger).

In *Chemistry*:

- 1904. Sir W. Ramsay.
- 1908. Lord Rutherford, O.M.
- 1921. Professor F. Soddy.
- 1922. F. W. Aston.

In *Medicine* or *Physiology*:

- 1902. Sir R. Ross.
- 1922. Dr. A. V. Hill.
- 1929. Sir F. G. Hopkins.
- 1932. Sir Charles Sherrington, O.M.

As might be expected, our friends across the Atlantic are exceedingly well represented. So also are those in Germany. With the very modest scientific equipment we possess in this country, it is surprising that we have done so well.

British Nobel Laureates for Literature are very few (unless our Irish friends will allow us to claim W. B. Yeats and G. B. Shaw). The most distinguished of our representatives in the Peace list is Sir Austen Chamberlain.

Though it confers no title and no social precedence, the "Order of Merit" is the highest distinction conferred by the King on "eminent men and women". Of the present holders of the distinction, four are men of science—Sir J. J. Thomson, Lord Rutherford, Sir W. H. Bragg, and Sir Charles Sherrington. The others are distinguished in other walks of life, e.g. Literature, History, Philosophy, and Music.

CHAPTER LV

Further Opinions and Some Reflections

Is Science Still Advancing? or is it Declining?

In his little book, *The Revolutions of Civilization*, Professor Sir W. M. Flinders Petrie has pointed out that civilization is essentially a *recurrent* phenomenon, and he shows that during the last 10,000 years there have been eight successive civilization "periods", every one preceded by an age of barbarism and followed by an age of decline. It will suffice here to refer to the two last of these civilizations, the Classical and the Mediæval, as they have been called. Like each of the first six, the Classical period rose from a low plane of barbarism, gradually ascended to a peak, and then slowly declined; in its turn, the still surviving "Mediæval" period rose, reached its peak, and is now declining rapidly. Flinders Petrie considers separately the Sculpture, Painting, Literature, Mechanics, Science and Wealth of each period, and establishes the fact that these characteristics of civilization have always reached their peaks in the same order, Sculpture rising first, then Painting, then Literature, and so on to the last, Wealth, after which a general decline has always set in. The table on the opposite page shows his selected approximate dates for the turning points in the last two great civilization waves. The necessary foundation of every new period of civilization has been the successful invasion of a new and energetic people. The subjection of the invaded, and the strife during the fusion of invaded and invaders, have demanded strong personal rule, and some form of autocracy has always lasted for from four to six centuries. The next stage has been an

oligarchy when leadership has still been essential but when the unity of the civilization could be maintained by law instead of autocracy. This stage lasted for four centuries in Greece and Rome, and for five to six centuries in mediæval Europe. Then a gradual transformation to democracy took place, beginning at about the great peak of literature in both Greece and Rome and in modern Europe. During this time, of about four centuries, wealth at first continued to increase, but when democracy obtained full power, the majority without capital have gradually eaten up the capital of the minority. In this way civilization has always thus

	Classical	Mediæval
Sculpture	450 B.C.	A.D. 1240
Painting	350 "	" 1400
Literature	200 "	" 1600
Mechanics	0 "	" 1790
Science	A.D. 150	" 1910
Wealth	" 200	" 1910

steadily decayed until the enfeebled population has been invaded and conquered by a new people, and the fused admixture gradually rose to a new civilization. History seems definitely to teach that democracy is inevitably the last phase of every civilization. Flinders Petrie merely states historical facts, and he does not suggest that, for instance, it will be Asia which will swarm into and conquer Europe when the latter's decline is sufficiently advanced, its capital gone, and its energy sapped, perhaps 200 or 300 years hence. But if the teaching of history has any significance, some such inference as this does not seem to be illogical. Flinders Petrie uses the term "mediæval" to cover the civilization extending down to the present time and beyond. It will readily be admitted that the famous sixteenth century was the "peak" of *that* civilization—the century of Bacon, Harvey, Kepler, Galileo, Descartes, Pascal, Huygens, Boyle,

Newton, Locke, Spinoza, Leibnitz, of Shakespeare and Cervantes, and many a score of other famous men. What sculpture have we had since the thirteenth century, or painting since the fourteenth? Does present-day literature bear any sort of comparison with that of the sixteenth century? As for Science and Wealth, Flinders Petrie assigns the year 1910 as the peak. That certainly does seem to apply to wealth. But Science?

Are there any signs that science is beginning to decline? Such great figures as Faraday, Maxwell, Darwin and Pasteur of the nineteenth century are sure of a niche in history as long as history lasts. So are such men as Lord Rutherford, Sir Charles S. Sherrington and Sir Frederick Gowland Hopkins of our own country, and Einstein and others from abroad, of the twentieth. The one rather ominous sign is that of a present-day tendency here and there to indulge in highly speculative hypotheses. Astronomy and atomic physics, for instance, are in that way running a little wild. On the other hand, biology, chemistry, and engineering are all going from strength to strength. That European civilization has crossed its peak and is definitely declining seems to be probably true, for its wealth is being slowly squandered away, and the craving for leisure and pleasure by some of its peoples is vividly reminiscent of decadent ancient Rome. It is, however, very doubtful if the peak of *science* has yet been reached. After all, Flinders Petrie's estimated periods are only rough approximations, though the successive civilizations he has analysed are wonderfully alike when time-graphed mathematically, except that each period tends to be rather longer than the last.

It is, of course, undeniably true that predictions based even on a regularly repetitional graph extending over 10,000 years may prove false. Although it cannot be gainsaid that the present civilization of Western Europe is declining much as the Roman Empire declined, there are now important new factors to be considered, factors that did not operate at all during the decline of 1400 or 1500 years ago. One is

the greater intelligence, or at least the greater general knowledge, of the masses of the people. A second is that all the peoples of the world are now in close contact with one another; already we can travel to any part of the world in a very few days, and oral communication by wireless is an affair of only a few minutes. A third factor is the new knowledge and the new resources which science is giving us almost every day. All such factors *may* lead to a turn of the tide, and history may thus for once be falsified. On the other hand, the whole of modern civilization, and not merely western civilization, may go down together. On the whole, there is some reason to fear. But on the whole there is greater reason to hope. Democracy is selfish, but it is teachable.

That eminent philosopher-mathematician, Professor A. N. Whitehead is no fatalist. Though a severe critic he is an optimist and a comforter. He says: "Every epoch has its character determined by the way its peoples react to the material events which they encounter. This reaction is determined by their basic beliefs—by their hopes, their fears, their judgments of what is worth while. They may rise to the greatness of an opportunity, seizing its drama, perfecting its art, exploiting its adventure, mastering intellectually and physically the network of relations that constitutes the very being of the epoch. On the other hand, they may collapse before the perplexities confronting them. How they act depends partly on their courage, partly on their intellectual grasp.

"Mankind is now in one of its rare moods of shifting its outlook. The mere compulsion of tradition has lost its force. It is our business not only to re-create and re-enact a vision of the world, including those elements of reverence and order without which society lapses into riot, but to be penetrated through and through with unflinching rationality. Such a vision is the knowledge which Plato identified with virtue. Epochs for which, within the limits of their development, this vision has been widespread, are the epochs unfading in the memory of mankind."

The Spirit of Science

“Pure” science is just a passionless seeker after truth, and that is *all* she is. She is scornful of those who “apply” her principles and spend their lives in making money out of them.

Every branch of science gradually builds up a body of doctrine—provisional hypotheses and a later crystallized theory based on such of the hypotheses as survive. But that body of doctrine is never more than provisional, ever liable to be modified in the light of a new discovery. The greatest generalization science has ever known was Newton’s, and Professor Whitehead gives us a vivid description of the dramatic five minutes at that meeting of the Royal Society a few years ago when Sir **Frank Dyson**, then Astronomer Royal, announced that the lines on the photographic plates of the famous eclipse, as measured by his colleagues at Greenwich, had verified Einstein’s prediction that stellar rays of light are bent as they pass near the sun. For well over 200 years Newton’s portrait in that same room had looked down on hundreds of meetings of the most famous scientific society in the world, and his great generalization had never before been questioned. Now at last a new fact had emerged, calling for a modification. The actual modification demanded was almost insignificant, it is true; nevertheless it *was* a modification. The old law did not cover the new fact, but only the facts that had been available to Newton. Nobody doubts that had Newton been aware of the new fact, he would have constructed a law which would have included it. But the available instruments in Newton’s time were poor indeed compared with those of the present day, and science had to wait.

“It is of the very essence of the scientific spirit,” says Professor **Julian Huxley**, “to refuse admittance to desire and emotion in the quest for knowledge—save only the one desire of discovering more truth. The most important characteristic of scientific method is its constant reference back to

experience in the search for knowledge. This rules out the idea that pure deductive reason and abstract principles can tell us anything about the nature of things."

In his recent Herbert Spencer lecture at Oxford, Professor Einstein, speaking on "The Method of Theoretical Physics", said: "Pure logical thinking can give us no knowledge whatsoever of the world of experience. All knowledge about reality begins with experience and terminates with it, but if experience is the beginning and end of all our knowledge about reality, what rôle is there left for reason in science? Reason gives the *structure* to the system. The data of experience and their mutual relations must correspond exactly to consequences in the theory."

The evidence provided by science is sometimes compared with the sifted evidence of the law-court, not always to the former's advantage. But a court of law is by no means the passionless and scientific laboratory it is popularly supposed to be. The atmosphere of a court of law is probably never quite unemotional, and is certainly never free from fog. The successful lawyer is not he who exposes naked truth, and it was because the late Lord Oxford was so scientifically logical, lucid, austere, and honest, and openly despised the artifices by which the path of forensic success is smoothed, that he was such an indifferent success during his early days at the Bar. The successful lawyer never rejects the cuttle-fish's strategy of darkening the waters. The lawyer has to win his case, and a well thought-out strategy, supported by useful minor tactics as the case develops, is his ordinary stock-in-trade. I doubt if science has anything at all to learn from the practice of the law, save perhaps from certain types of cross-examination.

A thoughtful writer in *Nature* remarked (16th Sept., 1933): "The great benefits which science has conferred on humanity have, in the main, been commensurate with the loyalty and devotion of the scientific worker to the service of truth. The more indomitable his devotion to that quest, the more important the truths which have been revealed to him.

The history of science reveals her as a mistress who permits no divided allegiance. It is this unswerving loyalty to truth than links science to art and religion as among the supreme human values."

After drawing a striking parallel between ancient Greek dramatic literature as exemplified by Æschylus, Sophocles and Euripides, and the working of modern science, Professor **Whitehead** says (*Science and the Modern World*): "The essence of dramatic tragedy is not unhappiness. It resides in the solemnity of the remorseless working of things. This inevitableness of destiny can only be illustrated in terms of human life by incidents which in fact involve unhappiness. For it is only by them that the futility of escape can be made evident in the drama. This remorseless inevitableness is what pervades scientific thought. The laws of physics are the decrees of fate."

The President of the Royal Society, Sir **Frederick Gowland Hopkins**, closed his Presidential Address to the British Association in 1933 with the following sentence: "I believe that for those who cultivate it in a right and humble spirit, science is one of the humanities; no less." It was a fitting close to a remarkable address.

It is often said that the difference between science and poetry is that the former is concerned with facts and the latter with values. A great poem or a great tragedy does not profess to record historical facts but it does enshrine intellectual and emotional values, and therefore enshrines truth as well as beauty, though not truth in the sense of scientific facts. But science is also concerned with beauty as well as facts; the beauty in the remarkable workings, relationships, and laws, of nature impresses itself upon all but the very dullest. The emotion which surges up in a research worker when he has hit upon a great discovery betrays an intensity of humanism that probably never arises on any other occasion. Science rightly claims to belong to the humanities.

The Debit and Credit Sides of Science

Not a few people have become timid, and some have become really alarmed, at the rapid progress science is making. Is it for good or is it for evil, they ask?

Science applied to the art of war has probably, on balance, retarded the progress of civilization. Applied to the arts of peace it has immeasurably increased creature comforts and extended their area. It has shortened the hours of toil, but, on the other hand, it has diminished the joy of work, and it has added to the magnitude of the unemployment problem. The balance is not easy to strike in terms of human happiness.

In his Presidential address to the British Association in 1932, Sir **Alfred Ewing** insisted that there was now a changed spirit in the thinkers' attitude to mechanical progress. "Admiration is tempered by criticism; complacency has given way to doubt; doubt is passing into alarm." He admitted to something of disillusion as he watched the "sweeping pageant of discovery and invention in which he used to take unbounded delight". In his view, man was ethically unprepared for so great a bounty; the command of Nature had been put in his hands before he knew how to command himself.

The stern fact remains that we have let the genie out of the bottle, and we cannot put him back.

Although Economics does not yet by a very long way rank as a branch of science and although there are very deep cleavages of opinion about even its fundamentals, a small number of men are recognized as authorities in the subject, and of these Sir **Josiah Stamp** is a leader. In the course of an address to the British Association at Leicester in 1933, Sir Josiah said (we quote briefly from the summary in *Nature*):

"It is being commonly stated that scientific changes are coming so thick and fast, or are so radical in their nature and implications, that the other factors of social life—the intangibles of credit, the improvements in political and inter-

national organizations and ideas—are unequal to the task of absorbing and accommodating them, or else they present new problems.

“If changes in social forms and human nature or behaviour cannot possibly be made rapidly enough for the task, then in that sense science may ‘ruin’ economic progress, and the world might be better served in the end if scientific innovation were retarded to the maximum rate of social and economic change.

“Where the innovation is absorbed most easily for offensive purposes in a military or naval sense, it may create rivalries and changes of balance of power inimical to economic security, and compel new economic sacrifices outweighing the direct economic advantages of peaceful uses. It is open to question whether the innovation of aircraft has yet become on net balance economic progress.”

“It used to be said of British machinery,” said Sir Josiah, “that it was made good enough to last for ever, and long after it became old-fashioned, whereas American machines were made to be worn out much earlier, and were thus cheaper, and could be immediately replaced by other machines containing the latest devices.

“Suppose the giant Cunarder attracts a profitable contingent for two years only, when a lucky invention in a new and rival vessel attracts all her passengers at a slightly lower fare. Here is progress in one typical sense, but the small net advantage to be secured by individuals as free-lance consumers may be dearly purchased by large dislocations or loss of capital reacting even upon those same individuals as producers.

“Economic life must in this generation pay a heavy price for the ultimate gains of science, unless all classes become economically and socially minded, and unless large infusions of social direction and internationalism are carefully introduced.

“This does not mean government by scientific technique, technocracy, or any other transferred technique. For human

wills in the aggregate are behind distribution and consumption, and they can never be regulated by the principles which are so potent in mathematics, chemistry, physics, or even biology.”

Sir Josiah's address left on the mind the impression that the difficulties of the present economic position are almost insuperable. Doubtless the problem of distribution of our choked markets will ultimately be solved, but the successful solution of this economic riddle will probably leave a more momentous human problem behind. How are we to replace what Sir Alfred Ewing called that “inestimable blessing, the necessity of toil”? At least up to the age of thirty-five, life is always clamant for activity of some kind, and pent-up energy is invariably a potential source of danger. There has already been a vast extension of popular leisure, and its most ominous feature is the way in which it drifts into passive recreations of watching and listening, dependent on mechanical devices that evoke no counterplay in the individual himself. “As man acquires the mastery of nature, it means that he enters into increasing control of his own time. Is he going to do something more with that time than merely to kill it? That may be the most searching of all the tests to which science summons us with her double-edged gifts.”

Much has been written about chemical warfare, for the introduction of which science has been blamed. But, as we have pointed out in Chap. XXXIX, this is hardly fair. Poisonous gases have long been used for all sorts of peaceful processes in industry, and it has always been the custom of the war-maker to use any lethal weapon he can lay his hands on. Even so, it has been officially stated that “gas is probably the most humane weapon existing to-day in actual warfare.”* Statistics from the last war seem to prove that the proportion of deaths from gas was far below the general proportion. In any case gas does not mutilate. And of course the horrors of the battlefields of the present day, dreadful as they are, bear

* See article on chemical warfare in *Foreign Affairs* for April, 1932, a review published by the American Council for Foreign Relations.

no comparison with the wholesale butchery that took place on many battlefields of olden times.

If some maniacal nation should decide to attack the civilian population of its enemy, gas will no doubt be one of the weapons used. And Professor **Langevin** has tried to make our flesh creep by telling us that 100 aeroplanes, each carrying a ton of gas, could in an hour cover Paris with a gas-cloud 20 metres thick, so that if there were no wind Paris would be annihilated!

But in an address delivered on 26th January, 1934, by that distinguished chemist **Dr. F. A. Freeth**, F.R.S., Adviser to Imperial Chemical Industries, and one of the greatest living authorities on gases and explosives, said that more nonsense had been talked about chemical warfare than about any other subject in the world. He showed why it is impossible to use either hydro-cyanic gas or carbon monoxide gas, two of the deadliest known to science. He pointed out what large amounts of extremely poisonous gas, including carbon monoxide, given off by omnibuses and cars, accumulated in a narrow street like Bond Street during the crowded hours of the day, and yet there were never any casualties: the remarkable diffusive powers of the atmosphere made casualties virtually impossible. The perfect atmospheric conditions necessary for effective poisoning in a war-zone could happen only rarely, and with troops on the alert and always prepared with masks, as in future they would be, casualties would probably be very few indeed. The only really useful military gas, **Dr. Freeth** said, was mustard gas, and this was really a heavy oil, made of alcohol, sulphur, and chlorine. The main danger of chemical warfare, **Dr. Freeth** added, was psychological, for many nonsensical notions had now got hold of the civilian population. Gas would have its perils, of course, but its scope in warfare is extraordinarily limited.

Far, far greater destruction will be wrought, as heretofore, by high explosives. An explosion which results from the firing of a high explosive like T.N.T. is almost instantaneous: six cubic inches of a solid would be changed into a cubic

yard of gas in *one forty-thousandth of a second*, and the newly made gas has to make room for itself in that minute fraction of time. Think of its violent "push" in all directions. If the high explosive were enclosed in a shell, the damage from shell fragments blown out at almost unimaginable velocities, and from falling shattered buildings, would be great indeed, for the violence of an ordinary gale, blowing at 100 miles an hour, would be as nothing compared with the violence of the explosion. But even greater would be the damage to human beings even well beyond the reach of the shell-fragments. The violent push-wave, carried onwards by the atmosphere, would act on brain and heart, to say nothing of other parts of the body, with dire effects of the very worst kind.

Gas-war in the popular sense is not to be greatly feared. Gas-war in the more technical sense of newly-formed gas being suddenly liberated with enormous velocity, is still the soldier's most dreaded enemy.

Are the British Illogical and Unscientific?

All the world seems to answer this question in the affirmative. It is probably indisputable that no other leading nation is so illogical, so unmathematical, and so unwilling to search for bed-rock facts. It is hardly incorrect, therefore, to add that we are unscientific. To foreigners our national characteristics have always been a source of puzzlement.

We may quote two opinions, both, it so happens, from friendly Germans.

The first is from the famous Liebig to our own Faraday, in a letter nearly 100 years ago. Liebig had been staying with Faraday in England and the letter was written after his return. We quote one or two paragraphs:

" GIESSEN, 19th December, 1844.

" Dear faraday,

" I intended to have written you long ago of my safe arrival and that I had found my wife and children well.

“ Nature has bestowed on you a wonderfully active mind which takes a lively share in everything that relates to Science. Many years ago your works imparted to me the highest regard for you, which has continually increased as I grew up in years and ripened in judgment, and now that I have had the pleasure of making your personal acquaintance and seeing that in your character as a man you stand as high as you do in Science, a feeling of the greatest affection and esteem has been added to my admiration. You may then conceive how grateful I am for the proof of friendship you have given me.

“ What struck me most in England was the perception that only those works which had a practical tendency awake attention and command respect, while the purely scientific works which possess far greater merit are almost unknown. And yet the latter are the proper and true source from which the others flow. Practice alone can never lead to the discovery of a truth or a principle. In Germany it is quite the contrary. Here, in the eyes of scientific men, no value, or at least, but a trifling one, is placed on the practical results. The enrichment of Science is alone considered worthy of attention. I do not mean to say that this is better; for both nations the golden medium would certainly be a real good fortune.

“ The meeting at York which was very interesting to me from the acquaintance of so many celebrated men, did not satisfy me in a scientific point of view. It was properly a feast given to the geologists; the other sciences serving only to decorate the table. The direction, too, taken by the geologists appeared to me singular, for in most of them, even the greatest, I found only an empirical knowledge of Stones and Rocks, of some petrefacts and few plants, but no Science. Without a thorough knowledge of Physics, and Chemistry, even without Mineralogy, a man can be a great geologist in England. I saw great value laid on the presence of petrefactions and plants in fossils, whilst they either do not know or consider at all the chemical elements of the fossils, those very elements which make them what they are.



THE PROBLEM

"You realise what this means. It is you and your young companions who will use it. What are we to do?"

Reproduced by permission of the Proprietors of "Punch"

“ Farewell, dear Faraday. Preserve to me your friendly favour and believe me with all sincerity to be,

“ Your very truly,

“ Dr. Justus von Liebig.”

The second is from a recently issued (1933) book *England: Fall or Rise?* by Adolph Halfeld. The opinions this author expresses are certainly candid, but they are on the whole, friendly, and they are undeniably fair. For instance, he quotes the saying that “ England has lost many battles but never the decisive one.”

“ Figures mean little to him [the Englishman], not only because he is weak at mental arithmetic, as every London waiter of long practice knows. . . .”

“ Where else do office hours begin so late as in London? Where else would anyone scoff at his neighbour for getting up at six o'clock in the morning? Where else would afternoon tea be served to employees during office hours?

“ The Englishman's mental laziness is world-famed. His mistrust of the use of intellect on occasions when he vainly and self-consciously gesticulates, knows no bounds. And in his development as personality and nation he never takes two steps at a time, never reaches out towards the stars.”

This and very much more appear in the eminently readable book referred to. Dare we deny the truth of it all?

Why is it that in character we are so different from the Germans, seeing that racially we are so closely akin to them? Is it to be accounted for by the Norman dilution? The Normans themselves were not undiluted Latins, but an admixture of Franks and Norsemen. The Norsemen invaded northern France about the same time that they invaded Saxon England. If we had absorbed a greater proportion of a Latin race, might we not now be endowed with a greater share of Latin logic and rationality, as represented by, say, the modern French and the modern Italians. And yet with

all our racial faults we are strangely like the ancient Romans, practical-minded, haters of abstract thought. "We are laughter-lovers, but we are not mockers; we are not intellectual, but we are rich in men of genius; we are grumblers, but we are cheerful when things are bad; we are individualists, but in the service of social causes we are keen workers in voluntary combination; we are fighters, but we are not soldiers." We are a mass of contradictions. We are as we are, and we shall remain as we are—unless perhaps by chance Professor J. B. S. Haldane discovers a means of coaxing British genes to transform themselves!

Anthropologists ask what racial characteristics will emerge in the United States when complete fusion of its many contributing races has taken place in another 300 or 400 years. America is large enough for two or three times, and Australia for twenty times, its present population. Friendly agreements for the large-scale admission and fusion of Asiatics is almost inconceivable in either case at present, but anthropologists cannot help wondering what will be the main characteristics of the new white-yellow races which the future is bound to give us. And how long before the whole world is racially a fused unit? Already the East and West are only a few days apart. But the time is not yet.

Biologists and anthropologists are making headway, and on such a difficult problem as race-blending and race improvement they may be able to offer valuable advice in the coming years, though national sentimentality, to say nothing of national sentiment, will oppose them strongly for a long time to come.

The Passing of Dogmatism

Almost down to the end of the last century, most men of science had adopted a materialist philosophy. Even now materialism is not quite dead, though it is dying rapidly. Materialists presented us with a universe in which the reality was made up of unconscious, lifeless, material atoms moving

in space and time in obedience to laws which physicists had partially discerned. "Man is the product of causes which had no prevision of the end they were achieving; his origin, his growth, his hopes, his fears, his loves and beliefs are but the outcome of accidental collocations of atoms." "Man is but the puny and local spectator, nay irrelevant product, of an infinite self-moving engine, which existed eternally before him and will exist eternally after him, enshrining the rigour of mathematical relationships while banishing into impotence all ideal imaginations; an engine which consists of raw masses wandering to no purpose in an undiscoverable time and space, and is in general wholly devoid of any qualities that might spell satisfaction for the major interest of human nature, save only the central aim of the mathematical physicist."

The only substantial reason for such a materialistic philosophy was that physics as a branch of science had proved an immense success. It was perhaps natural to suppose that so extremely successful a description of the universe must be true. From that it is an easy step to the assumption that the fundamental entities postulated by physics, in terms of which it gives so satisfactory an explanation of phenomena, must not only represent reality but actually be the only reality.

But why should we suppose that what is mathematically describable is ultimately real, and the only ultimate reality? How can we rationally say that our ideals, our purposes, and our wishes are not ultimate facts, simply because we have chosen to give a description of the universe in terms which *deliberately leave out* our ideals, our purposes, and our wishes? Indeed the materialistic position has become so unintelligible that very few men of science any longer cling to it. Materialistic philosophy is now merely a matter of historic interest.

It is a sign of intellectual health that most men of science are not only ceasing to be materialists but are now rather shy of proclaiming aloud their allegiance to any form of dog-

matic philosophy, though we have to remember that fashions come and fashions go, and mathematical idealism is the fashion of the moment. More and more eminent men of science are nowadays increasingly willing to admit that *they do not know*. It is doubtful if, for instance, any biologist of distinction would now claim to know the secret of the living cell. It seems to be an established fact that the living body is controlled and directed by the hormones, but, as we have asked before, *what controls and directs the hormones?* Is there an infinite regress here? We may rationally postulate a "vital principle" or an "entelechy", but, if we do, we are postulating something which is utterly incomprehensible. Let us be honest, and frankly admit that *we do not know*.

Despite the few surviving dogmatists, there is a refreshing humility about modern science. Omniscience now seldom finds a claimant. Intellectual integrity now much more willingly admits that, in the light of newly discovered facts, many old theories and creeds have ceased to be useful and must be abandoned. The same thing applies to the sphere of religion.

The great T. H. Huxley (1825-95) coined the word "agnostic", a term signifying simply, "one who doesn't know", and there were people of his day who thereupon assumed that he was an irreligious man. Doubtless he was impatient with worn-out creeds, but he was a passionate moralist and was filled with a deep piety towards the universe. We may quote from one of his letters:

"As I stood behind the coffin of my little son the other day, with my mind bent on anything but disputation, the officiating minister read, as part of his duty, the words: 'If the dead rise not again, let us eat and drink, for to-morrow we die.' I cannot tell you how inexpressibly they shocked me. Paul had neither wife nor child, or he must have known that his alternative involved a blasphemy against all that was best and noblest in human nature. I could have laughed with scorn. What! Because I am face to face with irreparable

loss, because I have given back to the source from whence it came the cause of a great happiness, still retaining through all my life the blessings which have sprung and will spring from that cause, I am to renounce my manhood, and, howling, grovel in bestiality? Why, the very apes know better, and if you shoot their young the poor brutes grieve their grief out, and do not immediately seek distraction in a gorge."

We may add a quotation from *What Dare I Think?*, a recent work by Huxley's well-known grandson, Professor **Julian Huxley**:

"By showing the baselessness of traditional theologies, advancing science seemed at one time to be giving religion itself a mortal blow. But, when we come to look deeper, we find the unescapable fact of religious experience, which no scientific analysis can remove. Thus, by forcing religious thought to distinguish between theological scaffolding and religious core, science has actually encouraged the growth of a truer and more purely religious spirit. If science has robbed religion of many of its certitudes, those certitudes were in a sphere improper to religion. . . . If progress itself be looked upon as a sacred duty, progress becomes an element in religion, and religious change will no longer alarm and shock religious minds."

We close the book with quotations from recent utterances by two of our best-known Bishops.

1. From a sermon by Dr. Barnes, Bishop of Birmingham, before the University of Cambridge, "a man of rare intellectual power, an earnest Christian, a bishop who is intolerant of the surviving idolatrous practices of the Christian Church." He took his text from 1 *Timothy*, iv, 7: "Refuse profane and old wives' fables, and exercise thyself rather unto godliness."

Surveying the present religious situation throughout the Christian world, the Bishop said: "I see a world eager to assimilate new knowledge, anxious to repudiate past mis-

takes, making bold and sometimes wild experiments that the Kingdom of God may be established upon earth. I see Churches with intellectual interests limited by prejudices, sometimes opposing, sometimes giving but feeble support to causes worthy of active Christian zeal. In England the difficulties of the Churches are largely of their own making. They are still afraid of new truth. Present knowledge has rendered obsolete much traditional theology. Yet the Churches, when possible, repudiate or minimize the need of change.

“If we actually believe that goodness and truth are of God, we need not fear that the teaching which results from scientific research will harm religion. The so-called tyranny of science is friendly guidance, which theologians ought gladly to accept. The best way to destroy superstition is to examine religious beliefs by the dry light of reason. Faith is both purified and strengthened when it is united to intellectual progress. Increasingly those who unreservedly accept the standpoint created by modern science, and reflect upon it in the light of man’s development and aspirations, find in Christian theism a reasonable explanation of the control of the universe. If all the evidence yielded by man’s knowledge, emotions, and intuitions is co-ordinated, I believe that Christ’s teaching as to God is seen to be more, and not less, reasonable than it was half a century ago. The inadequacies of any purely mechanical scheme of the universe has become increasingly apparent during the last fifty years. Moreover, the need of assigning a due place in any theoretical scheme to man’s spiritual aspirations has forced men to recognize that the creative process to which they owe their origin still continues. Deism, with its idea of God as an absentee landlord, must be abandoned. The difficulties arising from the problem of evil are formidable; but they do not force us to doubt Christ’s revelation of God as alike Creator and indwelling Spirit.

“The more fully the Churches accept and welcome new truth, the sounder will be their influence. There is nothing

in the present growth of man's ordered knowledge of the world to make us fear for the future of our faith. Yet in current presentations of Christianity there is much that conflicts with modern knowledge, much that alienates intelligent men and women from organized religion."

2. In his recent Gifford Lectures (published as *Scientific Theory and Religion*), Dr. Barnes says:

"Will the advance of knowledge continue to be as rapid in the next century as in the last hundred years? My instinct is to return a negative answer to this question. We, who are heirs of the European Renaissance, have lately passed through a second revolution of outlook and now need a period of quiet assimilation and of general readjustment. Of late the pace of scientific discovery has been disquietingly fast. The intellectual gulf between the leaders of science and the educated citizen is dangerously wide. But if one may judge by the past, periods of quiescence and rapid advance alternate.

"I imagine that, as the pace of discovery slackens, the twentieth century will see the gradual creation, or consolidation, of a new scientific orthodoxy which will be used as a background to religious belief. The result in Great Britain will be a conflict concerning the reformulation of Christianity similar to that which was waged after the Renaissance. There will, as formerly, be a struggle between new knowledge and old sympathies, the recurring opposition of progress and reaction. The outcome of the struggle will be indecisive, for such warfare of the spirit never ends; but it will mark a stage in the advance of that slowly flowing tide of religious understanding which will, as we believe, in due time cover the earth."

3. From a sermon by Dr. Williams, Bishop of Carlisle, "a wise, learned, and broad-minded prelate," before the British Association at Leicester, 1933.

"In a world crying out for order and authority, the standards which are proffered are too frequently purely

relative; the guidance offered, true perhaps for those who wish to move in this direction or in that, is rarely guidance for humanity. Whether in art, in science, or in morals, or even in religion, we miss in the present world that clear outstanding unity of truth and aspiration which because of its manifest authority has power to command allegiance from all.

“To be ready to listen to truths and discoveries belonging to an unfamiliar mode of experience, to be as willing to admit in one’s own field the inadequacy of present achievement as to discover the flaws in the confident dogmatisms put forward by a fellow-worker, to find all the time a chief bond of fellowship in a common patience and a common humility—these capacities are rightly expected, not only in each and every society of true religion; they belong also to the scientific outlook and are the moral necessities within the world of thought.

“Am I wrong in thinking that, far more than any positive approach towards the discovery of a common spiritual object of apprehension, more surely than by any deliberate invasion of each other’s special sphere of interest, the new note of deep and disciplined humility, which alike is appearing in the best science and the truest religion, removes ancient prejudice and is creating the conditions under which conscious unity may be developed in the future?

“There is evidence enough discernible in the New Testament that our bewilderment is part of our probation and that the separateness of interest which accompanies all serious efforts in pursuit of knowledge is a necessary accompaniment of progress to a deeper truth. The sciences have their mysteries; they speak in a private language; they have their devotees, their extremists equally with the Churches. Yet they depend for their success on moral qualities which are common also to the religions—self-sacrifice, a spirit of adventure, a willingness to surrender or subordinate whatever conflicts with the pursuit of an infinite ideal.

“Truth can never be the private possession of a few. The

opposition so fiercely proclaimed between secular interests and religious is more than half unreal. It is real enough if by secularism is meant that spirit of selfishness and present ease which accepts the material results of discovery and misuses the increased freedom and power which every advance in insight into Nature's forces brings to the human spirit. It is unreal if it ignores the hope and faith and love which are needed for the discovery of truth and beauty, no less than for the attainment of goodness.

“ Religion and science are alike in being easily degraded to become the ministers of temporary and selfish ends. Yet never perhaps in history was there greater need for the assertion of, and insistence on, eternal values. Some, at least, of those values are shared by science and religion—a common interest in truth which transcends all frontiers, uniting in equal fellowship all who share it; a determination to face facts however unwelcome, and ultimate issues however destructive they may be of present theory; an unswerving equity of judgment which is the only security for any just and lasting social order.”

BOOKS OF REFERENCE (Chapters XLIX onwards):

1. *The Universe in the Light of Modern Physics*, Max Planck.
2. *Where is Science Going?*, Max Planck.
3. *The Domain of Natural Science*, E. W. Hobson.
4. *The Universe of Science*, H. Levy.
5. *Metaphysical Foundations of Modern Science*, E. A. Burt.
6. *Reason and Nature*, M. R. Cohen.
7. *Scientific Inference*, Harold Jeffreys.
8. *L'Explication dans les Sciences*, E. Meyerson.
9. *Science and Hypothesis*, H. Poincaré.
10. *The New Conceptions of Matter*, C. G. Darwin.
11. *Scientific Thought*, C. D. Broad.
12. *Scientific Method: Its Philosophical Basis and its Modes of Application*, F. W. Westaway.

13. *Common Sense of the Exact Sciences*, W. K. Clifford. (Still well worth reading.)
14. *Mysticism in Modern Mathematics*, Hastings Berkeley.
15. *The Scientific Outlook*, B. Russell.
16. *Our Knowledge of the External World*, B. Russell.
17. *Science and Human Experience*, H. Dingle.
18. *Causality*, G. P. Adams and others.
19. *Causality*, L. Silberstein.
20. *Formal Logic*, F. C. S. Schiller.
21. *Logic*, J. S. Mill.
22. *Adventures of Ideas*, A. N. Whitehead.
23. *Science and the Modern World*, A. N. Whitehead.
24. *The Anatomy of Modern Science*, B. Bavink.
25. *The Spirit of Research*, T. B. Robertson.
26. *Contemporary Schools of Psychology*, R. S. Woodworth.
27. *The Eternal Values*, W. R. Inge.
28. *God and the Astronomers*, W. R. Inge.
29. *Scientific Theory and Religion*, E. W. Barnes.
30. *Science and Theology*, F. W. Westaway.
31. *Philosophical Aspects of Modern Science*, C. E. M. Joad.
32. *Prejudice and Impartialities*, G. C. Field.
33. *The Inequality of Man*, J. B. Sanderson Haldane.
34. *What Dare I Think?*, J. Huxley.
35. *The Foundations of Belief*, Arthur J. Balfour.
36. *The Revolutions of Civilizations*, W. M. Flinders Petrie.
37. *The Psychology of Persuasion*, W. Macpherson.
38. *Mind and Matter*, G. F. Stout.
39. *Limitations of Science*, J. W. N. Sullivan.
40. *The Shape of Things to Come*, H. G. Wells.
41. *Discovery, or the Spirit and Service of Science*, Sir R. Gregory, Bart.
42. *Britain's Heritage of Science*, Schuster and Shipley.
43. *Mechanism, Life, and Personality*, J. Scott Haldane.
44. *The Logic of Modern Physics*, P. W. Bridgman.
45. *The Living Universe*, Sir F. Younghusband.
46. *A History of Science and its Relations with Philosophy and Religion*, Sir W. Dampier.

47. *A History of European Thought in the 19th Century*, J. T. Merz.

48. *Leçons sur les ensembles analytiques et leurs applications*, N. Lusin. (For mathematical readers only.)

Also:

49. *Nature*, for the last ten years, and

50. *Philosophy*, for the last three years.

APPENDIX

SOME QUESTIONS FOR READERS

1. In their *Animal Biology*, Professors Haldane and Huxley point out that "a man, hit by a car going at 80 miles an hour, will probably feel nothing, because his brain is destroyed before any nervous impulses from his skin reach it." How could such a fact as this be determined?

2. How are the distances of the nebulae measured?

3. Are filter-passing viruses to be regarded as living organisms? Why? If you say they are "semi-living", exactly what do you mean by the term?

4. What is an explosion? How long does it take a high explosive like T.N.T. to be converted into a gas? Explain why such a gas is so remarkably destructive, why its downward action is so violent, and why it does not expend its force upwards into the atmosphere.

5. What is there about Lord Rutherford's work and Sir William Bragg's work of so fundamental a nature as to enlist the interest of scientific men in every part of the world?

6. "The truth of an hypothesis is merely an affair of greater or less probability." Since all theories of science are based upon and embody hypotheses, and since therefore a theory must also be an affair of probability, to what extent can any theory of science be truly said to represent nature?

7. It has been said (by a man who certainly ought to know) that the four greatest men of science the world has so far produced are the Greek, Archimedes; the Italian, Galileo; the Englishman, Newton; and the Frenchman, Pasteur. Put yourself in the place of a German who strongly opposed such a view. How would you be inclined to modify it?

8. Ray Lankester elaborated a series of intermediate steps whereby the first type of living organism was evolved from inorganic matter; and many other zoologists have adopted the same main view, viz. that a dynamic machine has spontaneously come into existence. An alternative hypothesis is to accept the existence of life as an elementary fact that cannot be explained, but must be taken as a starting-point in biology. Which view appeals to you? Marshal the evidence in support of that view.

9. What are your views concerning (i) the respective values of, and (ii) the true relations between, (a) experimental physics, and (b) theoretical physics? Discuss the appropriateness of the term "mathematical physics".

10. After referring to Einstein, Dr. Barnes says: "The law of gravitation is, it would seem, a mere consequence of our mode of measurement. The law is of human origin, made by our minds, just in so far as we make the way in which we measure intervals." Does this striking statement in any way weaken (i) Newton's law, or (ii) Einstein's law? If so, how?

11. When you watch under the microscope a living cell dividing, what do you consider to be the prime *cause* of the division? If you ascribe it to some sort of physical or chemical activity, what do you consider to be the prime cause of that activity. If you ascribe it to some vital force or entelechy, have you any real comprehension of such a postulated factor?

12. Among the insects, reproduction from unfertilized egg-cells is common. Such parthenogenesis can co-exist, or alternate, with reproduction as a result of sexual union. The inference almost seems to be, therefore, that biological research will in due course prove a virgin-birth to be possible. Have you any prejudice for or against the possibility of such a discovery? Why?

13. Do you consider "genes" to be wholly hypothetical, or to be compulsorily inferential? Is the confidence of biologists that genes have an actual physical existence justified? If not, can it be said that the confidence of chemists as to the actual physical existence of atoms is any more justified?

14. At the British Association Meeting at Leicester, 1933, four distinguished mathematicians discussed the origin of the universe, viz. Professor Sir Arthur Eddington of Cambridge, Professor E. A. Milne of Oxford, L'Abbé Lemaître of Belgium, and Professor de Sitter of Holland. It will be remembered that Sir Arthur

Eddington is an ardent Relativist and Expansionist, that Professor Milne consistently refuses to be led into quicksands, that L'Abbé Lemaître "discovered" Einstein's universe to be unstable, and that Professor de Sitter created, purely as a mathematical toy, a universe to which the only objection was that it made no provision for the existence of matter.

The general comment of certain very able critics was that one of the four views put forward was eminently acceptable, that another was a little cynical, and was hardly intended to be taken seriously, that a third was a pure fantasy, and that the fourth was a masterpiece of deductive reasoning which, however, was open to the fatal objection that it wholly contradicted experience.

Read the original reports carefully, and then try to assign correctly to them the respective critical comments.

15. Discuss the solid advances made by natural science as to the result of twentieth century improvements in the method and technique of exact observation. What substantial bearing (if any) have these on the current speculative hypotheses of science?

16. In his Presidential British Association address, 1931, General Smuts pointed out that all down the ages the world picture of science has constantly changed. There had been the world of magic and animism, then the world of the early Nature gods, then the geocentric world, then the engineers' or mechanical world. Lastly, a world had been invented in which no mechanical model is possible, a world of mathematical symbols which defied any sort of consistent interpretation. Assuming that history will repeat itself once more, what kind of world is likely, do you think, to replace the present algebraic world? Do you consider that the biologist has a good chance of being the next to take the helm? Why? It has recently been seriously suggested by an eminent writer that the Deity is a mathematician, apparently mainly on the ground that mathematical ability represents the highest type of intellectual power. Discuss this from the point of view of an engineer, a chemist, a physicist, a biologist, and a philosopher. What is your own view of the Deity's principal academic distinction?

17. It has been said that the highest reach of the creative process is seen in that realm of values which is the product of the human mind, and that science, in its selfless pursuit of truth, in its vision of order and beauty, takes equal rank with art and religion. Attack this thesis; then defend it.

18. The Second Law of Thermodynamics is the best account available, *for the time being*, of certain limited and measurable facts. It is this law which is supposed to "prove, without the shadow of a doubt" that the universe is in a state of decay and is marching on to annihilation. Discuss the ethics of the dogmatism that puts forward such an assertion. In your view, is endless progress thus "proved" to be impossible?

19. On being established in 1899, the Board of Education adopted the traditional views of the Science and Art Department of the Privy Council, which the Board succeeded, that physics and chemistry were the most suitable subjects of science for teaching in schools, views which still generally survive. To what extent do you consider this to be the cause of (i) the ignorance of, and (ii) the lack of interest in, science by the average educated Englishman? If it is the cause, what is the remedy? If not the cause, what *is* the cause?

20. Any form of emotion tends to spread, not only in a mob but even in a dignified deliberative assembly like the House of Commons. It therefore interferes seriously with right thinking and sound judgment. Admittedly a right judgment can only be reached by those who, with all the facts before them, can weigh the relative values with a calm mind. Should the emotion be suppressed? If so, how? Obviously physical science cannot help. Can biological science? Can psychology? or psycho-therapy? If not, would you bar from such an assembly any man who could not control his emotion? Can a tearful judge be a just judge?

NAME INDEX

- Abney, Sir William, and infra-red photography, 587.
- Adams, John Couch, determines position of Neptune, 970.
- Adams, Dr. W. S., astronomer, 617.
- discovers method of spectroscopic parallaxes, 630.
- Agassiz, J. L. R., on classification, 760.
- Ahmes, papyrus of, 27.
- Albertus Magnus, 96, 104.
- defence of the Church, 108.
- philosophy of, 105.
- Alcmæon of Croton, 71.
- Alcuin, director of monastery schools, 94.
- Alexander the Great, 11, 12, 17.
- Alexander VI, Pope, 111.
- Alfred the Great founds Oxford Academy, 233.
- Al-Hazen, Arabian astronomer, 101.
- Alhazen on the velocity of light, 417.
- Alkarismi, Arabian mathematician, 100.
- Al Mamum, algebra of, 100, 101.
- Ampère, André Marie, physicist, 339-43.
- Anaxagoras of Clazomenæ, 39.
- on the moon, 60.
- theory of the atom, 77.
- Anaximander, views of, on the earth, 59.
- Anaximenes, conception of the stars, 59.
- Anderson, Dr. J. G., 832.
- Ångström, A. J., 634.
- Anne, Queen, children of, 877.
- Apollonius of Perga, 43.
- contrasted with Euclid, 53.
- treatise on conic section, 57.
- Appleton, Prof., polar observations of, 723.
- on wireless phenomena, 727-8.
- Aquinas, Thomas, 96, 104, 110.
- Arago, D. F. J., astronomer, 339.
- opinion of Newton, 218.
- Archimedes, 31, 33, 43.
- achievements in physics, 76.
- contrasted with Apollonius, Euclid and Newton, 53.
- Archimedes, exhaustion method of, 55-6.
- practical methods of, 54.
- statics of, 75.
- writings of, 53.
- Archytas, 38, 42.
- treatise on mechanics, 75.
- Argelander, F. W. A., astronomer, 619.
- Aristarchus, astronomer, 43.
- conception of the solar system, 60.
- heliocentric theory of, 60, 67.
- Aristotle, "elements" of, 265.
- Galileo's attitude towards, 154.
- influence on zoology, 69.
- on light, 417.
- on meteorology, 698.
- scientific methods of, 42, 68.
- theory on circulation of blood, 257.
- Armstrong, Prof. H. E., 746.
- Arnold, Matthew, 237.
- Arrhenius, Svante A., theory of electrolytic dissociation, 491.
- Arya-Bhata, 99.
- Assmann, meteorograph of, 703.
- Aston, F. W., awarded Nobel Prize, 1011.
- mass spectrograph of, 468-70.
- Augustine, St., 87.
- Avebury, Lord, 837. [931.
- Aveling, Prof. F. A. P., psychologist, Avicenna, medical works of, 267, 881.
- Avogadro, Prof. L. R. Amadeo, hypotheses of, 326.
- Bacon, Francis, 176.
- method of, contrasted with Descartes', 181.
- philosophy of, 177, 227.
- *Works*, 118.
- Bacon, Roger, 104, 115.
- experimental investigations of, 108.
- writings of, 106.
- Bain, A. Geddes, geologist, 753.
- Baird, J. L., invents the television, 588.
- Baker, Prof. Noel, on bombs in warfare, 579.

- Bakewell, Robert, work on livestock breeding, 866.
- Ballot, Buys, on air-flow, 719.
— on frequency of vibration, 633.
- Baly, Prof. E. C. C., work on photosynthesis, 758.
- Bank, Joseph, botanist, 739.
- Barkla, Prof. C. G., awarded Nobel Prize, 1011.
— work on X-ray irradiation, 465.
- Barnard, Sarah, marries Faraday, 350.
- Barnes, Bishop, on religion in relation to science, 1029, 1031.
- Barrow, Isaac, 189.
- Bastian, Dr. Charlton, and spontaneous generation, 899.
- Bateson, Prof. Wm., theory of heredity, 746, 800, 820.
- Bayliss, work on hormones, 920.
- Beaufort, Admiral, conventional weather symbols of, 717.
- Becher, J. J., views on combustion, 271.
- Becquerel, A. H., experiments on fluorescence, 449.
- Bell, Alexander Graham, inventor of modern telephone, 592.
- Bergius, F., process for hydrogenation of coal, 575.
- Bergson, Prof. H. L., principle of *élan vital*, 803.
- Berkeley, Bp., philosophy, 562, 926, 927.
- Berkeley, Hastings, 926, 927.
— mathematical theory of, 562.
— on limitations of mathematics, 979.
- Bernard, Claude, as physiologist, 743.
— biochemical work of, 912.
- Bernouilli, Daniel, 191.
- Bernouilli, James, 191.
- Bernouilli, John, 191.
— mathematical problems set by, 216.
- Berzelius, J. J., chemical notation of, 320.
— dualistic system of molecules, 491.
— on chemical affinity and electricity, 491.
- Bessemer, inventor of process for steel, 586.
- Bhaskara, mathematician, 99.
- Bichat, M. F. X., founder of general anatomy, 737.
- Biffen, Sir Rowland, work on agricultural research, 869.
- Birge, discovery of heavy hydrogen, 508.
- Bisacre, F. F. P., 394.
- Black, Prof. Davidson, 832.
- Black, Joseph, and the phlogiston theory, 275.
— career of, 293.
— experiments on caustic alkalis, 294 *et seq.*
- Blackett, Prof. P. M. S., discovery of the "positron", 507.
- Blackett, Prof. P. M. S., bombardment of nitrogen nuclei, 503.
— on history of cosmic rays, 654.
— photography of bombarded atoms, 463.
- Blackman, F. F., hypothesis of photosynthesis, 757.
- Bode, astronomer, 141.
- Boerhaave, Hermann, and chemistry of carbon compounds, 275.
- Boethius, writings of, 88.
- Bohr, Niels, atomic theory of, 472 *et seq.*
— on electronic energy, 513.
- Boltzmann, L., musical interpretation of mathematics, 972.
— on molecular motion, 438.
- Boniface VIII, Pope, 92, 94.
- Bonnet, Charles, systematization of biology, 735.
- Born, Max, 530.
- Bosanquet, Prof. B., on hypotheses, 965.
- Boswell, Prof. P. G. H., on early history of the earth, 673.
- Bothe, bombardment of beryllium, 504.
- Boule, Prof. Marcellin, model of Neanderthal man, 835.
- Boyd, Dr. John, research in animal nutrition, 871.
- Boyle, Robert, 277.
— and alchemy, 115.
— as a physicist, 277 *et seq.*
— books for reference on, 292.
— books of, 284, 286.
— early years of, 277.
— estimation of value of work of, 292.
— evidence against Aristotelians and Paracelsus, 290.
— law of, 279, 705, 707.
— on the elements, 286, 291.
— work on the barometer, 698.
- Boys, Prof. C. V., experimental skill of, 692.
- Bradley, measures velocity of light, 417-18.
- Bragg, Sir W. H., awarded Nobel Prize, 1010.
— awarded Order of Merit, 1011.
— model of structure of diamond, 497.
— on structure of crystals, 494, 498.
— on waves or particles, 534.
- Bragg, Prof. W. Lawrence, awarded Nobel Prize, 1010.
— on structure of crystals, 494.
- Brahmagupta, mathematical work of, 99, 100.
- Brande, Professor, 349.
- Breasted, Prof. J. H., archæological work of, 848.
- Brickwedde, isolation of heavy hydrogen, 508.
- Brillouin, on wave mechanics, 530.

- Broad, Prof. C. D., on philosophical implications of science, 925.
- Brodar, Prof. Srecko, archæological work of, 849 *et seq.*
- Broom, Dr. Robert, geologist, 753.
- Brown, Robert, botanical research of, 739.
- on movement of particles, 486.
- Brown, Dr. Wm., psychologist, 932.
- Brown, Dr. W. Langdown, on endocrinology, 921.
- on psychotherapy, 932.
- Bruce, Sir David, research on tropical disease, 907.
- Bruno, martyrdom of, 159, 180.
- Bunsen, R. H., 335.
- Burnet, Bishop, appreciation of Newton, 217.
- Burt, Prof. E. A., on hypotheses, 307.
- Bury, C. R., on the stational atom, 483.
- Busby, Dr., 221.
- Callow, Dr. R. K., work on vitamin D, 916.
- Calvin, plea for individual liberty, 180.
- Carnarvon, Lord, archæological work of, 848.
- Carnegie, Andrew, 604.
- Carter, Howard, archæological work of, 848.
- Castelli, invention of the rain gauge, 698.
- Cavalieri, Bonaventura, 187.
- on volume enclosed by surface, 213.
- Caven, Prof., graph of elements, 444.
- Cavendish, Henry, 302 *et seq.*, 598.
- and the phlogiston theory, 275, 306.
- anticipates Ohm's law, 331.
- discovers composition of water, 303 *et seq.*
- discovers hydrogen, 303.
- electrical researches, 302, 331.
- electrostatic measurements of, 331.
- inflammable air of, 303.
- Caxton, William, printing press of, 114.
- Celsus, Aurelius, medical work of, 74, 84.
- Cesalpino, theory of blood circulation, 257.
- Chadwick, transformation of elements, 504.
- Chamberlain, Sir Austen, awarded Nobel Prize, 1011.
- Chamberlain, Dr. C. J., plant histologist, 761.
- Chamberlain, Joseph, 905.
- Chamberland, wave filter of, 902.
- Chamberlin, Prof. T. C., tidal hypothesis of origin of earth, 663.
- Chapman, astronomer, 620.
- Charlemagne as Emperor, 93.
- England in the time of, 93.
- Charles II and the Royal Society, 235.
- Charles II, last illness of, 876.
- Christoffel, and relativity, 536.
- Church, Major Archibald, on advances in television, 588.
- Cicero, 82.
- philosophy of, 233.
- Civita, Levi, and relativity, 536.
- mathematical work of, 554.
- on Dirac's equations, 532.
- on theory of relativity, 565.
- Claudius Ptolemæus, map of, 7.
- Clausius, on the entropy of the universe, 437.
- on transference of heat, 437.
- Clement of Alexandria, 87.
- Clifford, W. K., on causation, 945.
- Clowes, William, surgeon, 240, 882.
- Cockcroft, Dr. J. W., 598.
- on disintegration of elements, 505.
- Coleridge, Samuel Taylor, 228.
- Coleridge, Hon. Stephen, on expansion of the universe, 558.
- Colet, Dean, 111, 877.
- Collinson, Peter, 330.
- Collum, work on vitamins, 914.
- Columbus, 113, 247, 882.
- Compton, Prof. A. H., awarded Nobel Prize, 1011.
- on cosmic rays, 654.
- on scattering of X-rays, 522.
- Constantine, Emperor, 90.
- Cooper, Sir Astley, 878.
- Cope, E. D., palæontologist, 696.
- Copernicus, 119, 127 *et seq.*
- and the heliocentric hypothesis of Aristarchus, 66.
- books for reference on, 131.
- heliocentric hypothesis of, 129, 130.
- Coster, printer, 114.
- Cotes, Roger, mathematician, 219.
- Coulomb, C. A., torsion balance of, 331.
- Couper, A. S., on "bonds" in molecules, 488.
- Cowen, Prof. M. R., on imagination in hypothesis, 968.
- Craig, Sir Maurice, psychologist, 932.
- Cranston, J. A., 463.
- Crew, Prof. F. A. E., research in animal breeding, 870.
- on heredity, 793.
- Crookes, Sir William, discovers cathode rays, 446.
- Cruikshank, George, imaginary sketch of Newton, 217.
- Ctesibius, engineer, 43.
- Cuneus, electrician, 329.
- Curie, Madame, work on radioactivity, 450, 451.
- Curie, Pierre, researches on radioactivity, 450.
- Curie-Joliot, F. and I., 504, 509.

- Curtis, John, work on economic entomology, 860.
- Cuvier, Georges, founder of comparative anatomy, 738.
- d'Alembert, Jean le Rond, mathematician, 219.
- Dalton, John, 312, 321.
— atomic theory of, 77, 319.
— on chemical philosophy, 312.
— on chemical synthesis, 313 *et seq.*
— on Davy's discoveries, 318.
— on Gay-Lussac's law, 325.
— postulates for chemical synthesis, 314.
— symbols for chemical elements, 316.
— theory of chemical compounds, 317.
- Daly, R. A., hypothesis of surface structure of the earth, 678.
- Daniell, J. F., battery of, 334.
- Darwin, Prof. C. G., conception of section of electron orbit, 526.
— on diffraction of electrons, 521.
- Darwin, Charles Robert, 743, 923.
— and Lamarckism, 744.
— hypothesis of evolution and heredity, 743, 797.
— immortality of work of, 1014.
— *Origin of Species* of, 657, 782.
- Darwin, Erasmus, biological views of, 740, 796.
- Darwin, Major Leonard, 923.
- da Vinci, Leonardo, 116, 117.
— anatomy studies of, 239.
- Davy, Sir Humphry, at the Royal Institution, 321.
— character of, 323.
— Dalton on discoveries of, 318.
— discovers nitrous oxide, 321.
— electric battery of, 336.
— establishes elementary nature of chlorine, 322.
— European tour of, 349.
— experiments in anæsthesia, 884.
— — on development of heat, 433.
— invents miner's lamp, 321.
— isolation of potassium and sodium, 322, 491.
— jealousy of Faraday, 351.
— pioneer of application of science to agriculture, 866.
— temperament of, 351.
- Dawson, Charles, discovery of Piltdown man, 829.
- Dawson of Penn, Lord, 895.
- de Bort, L. Teisserenc, meteorological work of, 703.
- de Broglie, Prince Louis Victor, wave mechanics of, 528, 530.
- de Buffon, Comte, 735, 796.
- de Chardin, Father Teilhard, 832.
- de Laplace, Marquis, 219, 339.
de Laplace, Marquis, hypothesis of origin of earth, 661 *et seq.*
— law of diminution of atmospheric pressure, 707.
- de l'Hôpital, Marquis, on Newton, 218.
- de' Medici, Cosmo, 234.
- Democritus, and the volume of a pyramid, 31.
— atomic theory of, 43, 77.
- Demoivre, Abraham, arbitrates between Newton and Leibnitz, 219.
- de Morgan, Augustus, *Budget of Paradoxes*, 903.
— on probability, 973.
- de Perthes, Boucher, archaeologist, 836.
- Descartes, René, 179 *et seq.*
— algebraic geometry of, 540.
— and Kepler's laws, 182.
— and the solar system, 182.
— on transmission of light, 417.
— philosophy of, 180.
— — contrasted with Bacon's, 181.
— system of geometry, 183, 185.
— vortices of, 182, 946.
- de Sitter, Prof. W., estimate of size of universe, 642.
— of curvature of space, 561.
- de Vries, Hugo, 746.
— hypothesis of mutation, 800.
- Dewar, Sir James, work on liquefaction of gases, 576.
- de Winton, 820.
- d'Herelle, work on the bacteriophage, 903.
- Diaz, Bartholomew, 113.
- Dible, Prof. J. H., 903.
- Dimsdale, Baron, 891.
- Dines, W. H., meteorograph of, 703.
— meteorological observations of, 703, 712.
- Dingle, Prof. Herbert, on indeterminacy, 952.
— on the meaning of science, 998.
- Diophantus, mathematician, 44.
- Dirac, Prof. P. A. M., awarded Nobel Prize, 1011.
— exposition of theory of quanta, 989.
— on mathematical symbols, 534.
— on quantum mechanics, 531.
— symbolism of, 532.
- Dixon, Prof. H. H., on transpiration of plants, 756.
- Döbereiner, Prof. J. W., on triad elements, 441.
- Dominik, St., 103.
- Dominik, Admiral, Polar expedition of, 723.
- Dominis, Archbishop, 159.
- Doppler, C. J., principle of, 633.
- Dougall, Dr. J., on space-time intervals, 1008.
- Driesch, Prof. Hans A. E., 803.
- Drumm, Dr. J. J., electric cell of, 581.

- Dubois, Prof. Eugène, anthropological discovery of, 828.
- du Fay, C. F. de C., theory of electricity, 331. [491.]
- Dumas, unitary system of molecules, Duns Scotus, scholar, 109.
- Dürer, Albrecht, 239.
- Dyson, Sir Frank, confirms Einstein's theory on stellar rays of light, 1016.
- Eccles, W. H., on ionization of upper atmosphere, 725.
- Eddington, Sir Arthur, books of, 981, 982.
- conception of the universe, 643.
- estimation of number of nebulae, 628.
- interpretation of mathematical results, 981.
- methods of exposition of, 982 *et seq.*
- on annihilation of the universe, 652.
- on indeterminacy, 948.
- on number of stars, 622.
- on recession of the nebulae, 640.
- on simultaneity, 551.
- on the universe and the atom, 650.
- Edison, Thomas Alva, inventions of, 592.
- Ehrlich, Paul, 902.
- discovery of salvarsan, 903.
- Einstein, Prof. Albert, corpuscular theory of light, 518.
- earlier view on framework of the universe, 988.
- equivalence hypothesis of, 553.
- geometric law of gravitation, 554.
- gravitation theory, 556, 557.
- immortality of work of, 1014.
- later theory of a universe, 992.
- light quantum of, 518, 522.
- modified views of, 562.
- on curvature of space, 561.
- on experience, 1017.
- on indeterminacy, 959.
- space-time of, 976.
- theory of cosmical repulsion, 643.
- theory of relativity, 548.
- theory of stellar rays of light confirmed, 1016.
- universe of, 643.
- Elizabeth, Queen, hygiene in reign of, 876.
- Empedocles, theory of, on light, 75.
- views on function of heart, 71.
- Eötvös, Baron Roland, torsion balance of, 692.
- Epicurus, Stoic philosophy of, 39.
- Erasistratus, medical discoveries of, 74.
- Erasmus of Holland, 111.
- on lack of cleanliness, 875.
- Eratosthenes, measures diameter of the earth, 60.
- Euclid, mathematician, 43.
- Euclid and logical inference, 974.
- as logician, 52.
- contrasted with Archimedes, 53.
- elements of, 51.
- geometry of, 976.
- — applicability of, 542.
- postulate of parallel lines, 543.
- Eudoxus, 42.
- treatise on astronomy, 60.
- Euler, Leonard, mathematician, 219.
- Eustachius, anatomist, 116.
- Evans, Sir Arthur, archæological work of, 13, 837, 846.
- Evans, Sir John, 837, 846.
- Everett, "C.G.S. system of units", 381.
- Ewing, Sir Alfred, 1019, 1021.
- Fabre, G. H., opponent of evolution, 746.
- Fabricius, 239, 240.
- Fahrenheit, G. D., thermometer of, 698.
- Fallopium, 240, 882.
- Faraday, Michael, 196, 344 *et seq.*
- accompanies Davy on European tour, 349.
- appointed assistant at Royal Institution, 348.
- — Fullerian Professor, 351.
- books for reference on, 359, 375.
- character of, 357, 358.
- chemical researches of, 351, 352.
- Clerk Maxwell's support of, 354.
- contrasted with Newton, 344.
- Davy's jealousy of, 351.
- death of, 359.
- diary of, 363.
- early years of, 344.
- electrical researches of, 351, 365.
- experiments on magneto-electric induction, 368 *et seq.*
- famous experiments of 1821 and 1831, 361 *et seq.*
- friendship with Clerk Maxwell, 357.
- geometrical representation of forces, 354.
- immortality of work of, 1014.
- infant motor of, 362.
- invention of the dynamo, 373.
- isolation of benzene, 490.
- Liebig's letter to, 1023.
- marriage of, 350.
- method of measuring thickness of gold-leaf, 385.
- on electricity and combining force, 354.
- on unity of forces, 353.
- originality of scientific methods of, 353.
- Tyndall as colleague of, 358.
- Feather, on transformations effected by neutrons, 505.

- Fermat, Pierre de, 188, 190.
 Finsen, Niels R., invention of phototherapy, 592.
 Fischer, Emil, work on proteins, 912.
 Fisher, Bishop, 111.
 Fisher, Prof., work on genetics, 801, 802.
 Fitzgerald, G. F., 548.
 Fitzroy, Admiral, 699.
 Fizeau, on elasticity of magnetic medium, 356.
 Flammarion, Camille, 970.
 Flamsteed, John, first Astronomer Royal, 191, 207.
 — observations of path of comet, 212.
 Fleming, Prof. A., on wireless waves and atmospheric refraction, 724.
 Fleming, Sir J. Ambrose, thermionic valve of, 592.
 Flinders Petrie, Sir W. M., 29, 837.
 — on periods of civilization, 1012, 1014.
 Fordney, ascent into high atmosphere, 654.
 Foucault, J. B. L., measures velocity of light, 418, 419.
 Fouqué, petrological researches of, 659.
 Francis, St., 103.
 Franklin, Benjamin, theory of electricity, 329 *et seq.*
 Fresnel, A. J., 189.
- Galen, Claudius, physician, 43.
 — anatomy of, 240.
 — as medical practitioner, 879.
 — on valves of the heart, 254.
 — trachea experiment of, 249.
 — works burned by Paracelsus, 267.
 — writings of, 74.
 Galileo, astronomer, 119, 150 *et seq.*
 — and laws of motion, 201.
 — appreciation of work of, 161.
 — attitude toward Aristotle, 154.
 — becomes professor at Padua, 155.
 — books for reference on, 162.
 — books of, 159, 161, 163.
 — construction of thermometer by, 698.
 — discovers the phases of Venus, 156.
 — experimental methods of, 154.
 — forbidden to teach motion of the earth, 159.
 — imprisoned by Inquisition, 159.
 — invents telescope, 150, 156.
 — investigations on falling bodies, 169 *et seq.*
 — invited to Rome, 159.
 — last years of, 161.
 — letter to Kepler, 157.
 — on the velocity of light, 417.
 — opposition of Aristotelians to, 155, 157.
 — propositions on motion, 167.
 — recants his views as false doctrine, 160.
- Galileo settles in Florence, 158.
 — supports Copernican theory, 155.
 — trial of, by the Church, 160, 162.
 — works out formulæ for motion, 164 *et seq.*
 Galle, discovers Neptune, 970.
 Galton, Sir Francis, anthropologist, 746.
 — law of ancestral inheritance, 799.
 — research in eugenics, 923.
 Galvani, Aloisio, electrician, 332.
 Gama, Vasco da, 113.
 Garrod, Miss Dorothy, discovers remains of Neanderthal child, 830.
 — excavations in Judæa, 847.
 Garstang, Prof. J., archæological work of, 847.
 Gates, Prof. R. Ruggles, on gene concept, 814.
 Gauss, C. F., on Euclid's postulate of parallel lines, 543.
 Gay-Lussac, J. L., 324, 325.
 Geddes, A. E. M., on temperature in troposphere and stratosphere, 713.
 — three-dimensional graph of insolation, 709, 711.
 George I dismisses Wren, 262.
 George IV, operation on, 878.
 Gerbert of Aquitania, 103.
 Gibbs, J. W., thermodynamics, 440.
 Gilbert, Sir J. H., work on agricultural science, 866, 867.
 Gilbert, William, work on magnetism, 117, 241. [559.]
 Giles, Sir R., on curvature of space, Glazebrook, Sir R., 594.
 Gockel, observations on cosmic rays, 653.
 Gold, Col. E., on the tropopause, 712.
 Goldschmidt, work on the β -rays in evolution, 820.
 Goldstein, E., on "canal" rays, 447.
 Goodrich, E. S., 801.
 Gray, Dr. James, 918.
 Gray, Stephen, electrician, 328.
 Green, Lotthian, tetrahedral hypothesis of, 676.
 Gregory VII, Pope, 94.
 Gregory, David, mathematician, 219.
 Gregory, James, suggests reflecting telescope, 195.
 Gregory, Prof. J. W., on surface structure of earth, 678.
 Gregory, Prof. W. K., 820, 832.
 Grimaldi, experiments on light, 419.
 Grove, Sir W. R., battery of, 335.
 Guericke, invents the air-pump, 176.
 Gutenberg, John, 114.
 Gyllenskiöld, Prof. C., Polar exploration of, 723.
- Haddon, Prof. A. C., 832.
 Hadfield, Sir Robert, 352.

- Hadley, John, on trade winds, 698.
 Haeckel, Ernst H., biologist, 746.
 — biogenetic law of, 777.
 Haffkine, Waldemar, 902.
 Hagenbach, measurement of wave-length of hydrogen lines, 385.
 Haldane, Lord, 230.
 Haldane, Prof. J. B. S., 801, 1026.
 — diagram of animal evolution, 786, 788-9.
 — evolutionary theories of, 817, 820, 821.
 — on significance of eternity, 1002.
 — on synthesis of enzymes, 759.
 — work on genetics, 802.
 Hale, Prof. G. E., astronomer, 613, 616.
 Hales, Stephen, experiments on gases, 275.
 Halfeld, Adolph, 1025.
 Hall, Sir Alfred Daniel, work on agricultural research, 868.
 Hall, James, synthetic work on rocks, 659.
 Hallett, Prof. H. F., on "physical" space-time, 560.
 Halley, Edmund, Astronomer-Royal, 191.
 — on salt in the oceans, 682.
 — on the orbits of the planets, 207.
 — on trade winds and monsoons, 698.
 Hardy, Prof. G. H., on limitations of mathematics, 976.
 Harkins, on transformations effected by neutrons, 505.
 Haroun-al-Raschid, Caliph, 101.
 Harris, Dr. L. S., work on vitamin D, 915.
 Harvey, William, 241 *et seq.*
 — anatomy lectures of, 242.
 — and his contemporaries, 239 *et seq.*
 — application of measurement to biology, 260.
 — books for reference on, 263.
 — early years of, 241.
 — extracts from essay of, 248 *et seq.*
 — letters of, 260.
 — on the circulation of the blood, 248.
 — patients of, 260.
 — Sir George Newman on, 882.
 — views of blood-circulation prior to, 247.
 — work on embryology, 260.
 Haworth, Prof. W. N., 916.
 Heath, Sir T. L., 39.
 Heaviside, Oliver, on wireless waves, 725.
 Heisenberg, W., and matrix mechanics, 530.
 — principle of uncertainty, 523, 528.
 — the originator of "indeterminacy", 947, 952.
 Henry VIII, quarrel with the Pope, 112.
 Henry VIII, sanitation in reign of, 875.
 Henry, Joseph, physicist, 375.
 Henslow, John, botanist, 743.
 Heraclides, and the rotation of the earth, 60.
 Hero, Alexandrian engineer, 43, 76.
 Herodotus, history based on, 20.
 Herophilus, medical discoveries of, 74.
 Herschel, Sir John, astronomer, 618.
 Hertz measures velocity of electromagnetic waves, 418.
 — proves existence of electrical waves, 356.
 Hertzprung, Prof. E., on cepheid variables, 631.
 Herzfeld, Dr. Ernest, archæological work of, 846.
 Heslop-Harrison, Prof., evolutionary theories of, 801, 817.
 Hess, A. F., work on vitamins, 914.
 Hickman, Dr. H. H., and anæsthesia, 884.
 Hill, Dr. A. V., awarded Nobel Prize, 1011.
 Hipparchus, astronomer, 43.
 — achievements of, 61, 62.
 Hippias of Elis, 39.
 — invention of the quadratrix, 47.
 Hippocrates of Chios, geometrician, 40.
 Hippocrates of Cos, physician, 40, 43.
 — as medical practitioner, 879.
 — father of Greek medicine, 71.
 His, Wilhelm, embryologist, 778.
 Hobson, Prof. E. W., on causation, 946.
 Hogben, Prof. Lancelot, 801.
 — on nature of life, 918.
 Holmes, Prof. Arthur, hypothesis of surface structure of earth, 678.
 — on rates of deposition of sediments, 682.
 — on salt in the oceans, 682.
 Hooke, botanist, 761.
 Hooke, Robert, 190.
 — becomes Secretary of Royal Society, 206.
 — on orbits of the planets, 207.
 — wave theory of light, 189, 198.
 Hooker, John D., 615.
 Hooton, Prof. E. A., on likeness of man to apes, 827, 832.
 Hopkins, Sir Frank Gowland, awarded Nobel Prize, 1011.
 — biochemical work of, 914.
 — immortality of work of, 1014.
 — on chemical aspects of life, 916.
 — on science as a humanity, 1018.
 — on the molecule, 500.
 Howard, John, and prison reform, 876.
 Hubble, Dr. E. P., astronomer, 617.
 — estimate of size of universe, 642.
 — of weight of nebula in Andromeda, 628.
 — on cepheid variables, 632.

- Hubble, Dr. E. P., on extra-galactic nebulae, 625.
 — on velocity of nebulae, 637.
 — work of, on nebulae, 635.
- Humason, Dr. M. L., astronomer, 617.
 — work of, on nebulae, 635.
- Hume, David, 228, 230.
 — books for reference on, 231.
 — on causation, 943.
 — philosophy of, 231.
- Humphreys, W. J., diagram of distribution of gases in the atmosphere, 717.
- Hunter, John, surgeon, 883, 891.
- Hurst, C. C., embryologist, 778.
 — diagram of life-cycle in animals, 809, 810.
- Hussey, Prof. W. J., astronomer, 613.
 — on origin of igneous rocks, 656.
 — theory of the earth, 657.
- Huxley, Prof. Julian, diagrams of animal evolution, 786-9.
 — on religion in relation to science, 1029.
 — on the scientific spirit, 1016.
 — work on evolution, 801.
- Huxley, T. H., and religious expression, 1028.
 — as teacher of science, 745.
- Huygens, Christian, 175, 189.
 — formula for motion in a circle, 204-5.
 — observation of a nebula, 624.
 — on the emission theory of light, 419.
 — principle of wave spreading, 413.
 — wave theory of light, 199.
- Hyder Ali, 298.
- Hypatia, murder of, 88.
- Inge, Dean W. R., on annihilation of matter, 991.
- Innocent XII, Pope, 261.
- Isidore of Seville, 87.
- Jean, Sir James, and indeterminacy, 948, 952.
 — interpretation of mathematical results, 981.
 — "least interval" of, 987, 1008.
 — mathematical interpretation of the universe, 986-7.
 — on condensation of gaseous filament from the sun, 672.
 — on creation of the cosmos, 645.
 — on curvature of space, 558.
 — on expansion of the universe, 557.
 — on origin of solar system, 663.
 — on space and time, 563.
 — on the great nebulae, 626.
 — philosophy of, 562-3.
 — popular books of, 981.
- Jeffreys, Prof. H., estimate of age of the earth, 680.
- Jeffreys, Prof. H., hypothesis of surface structure of earth, 678.
 — on nebular hypothesis of origin of earth, 663.
 — on probability, 974.
 — on tidal hypothesis of solar system, 669.
- Jenner, Edward, experiments in inoculation, 891.
 — vaccine treatment of, 886.
- Jesty, Benjamin, 891.
- Johannsen, Danish botanist, 818.
- Johnston, Prof. J. F. W., work on agricultural science, 866.
- Joly, Prof. J., drift hypothesis of surface structure of the earth, 678.
 — on salt in the oceans, 682.
- Jones, Bence, life of Faraday, 338.
- Jordan, collaborator of Heisenberg, 530.
- Joseph, H. W. B., on space relations, 560.
- Joule, J. P., and conservation of energy, 354, 433.
 — first law of thermodynamics, 433.
- Julius II, Pope, 111.
- Julius Cæsar, 82, 83.
- Justin Martyr on Greek philosophy, 87.
- Kant, Emmanuel, philosopher, 228, 926.
- Kapitza, Peter, 600.
- Kapteyn, J. C., astronomer, 619.
 — work on galactic plane, 621.
- Kaye, Dr. G. W. C., work on noise abatement, 570.
- Keith, Sir Arthur, as anthropologist, 828.
 — diagrammatic synopsis of human evolution, 832-3.
 — on likeness of man to apes, 827.
 — on the antiquity of man, 832.
 — phylogenetic tree of man's evolution, 845-6.
- Kekulé, F. A., hypothesis of carbon atoms, 489.
- Keller, archæologist, 836.
- Kelvin, Lord, on physical explanations, 394.
 — on solidification of the earth, 674.
 — on transference of heat, 437.
- Kennelly, Prof. A. E., on wireless waves, 725.
- Kepler, Johann, astronomer, 119, 140.
 — and Descartes' theory, 182.
 — appreciation of work of, 148-9.
 — books for reference on, 149.
 — discovers law of planetary speed, 145.
 — hypothesis of planetary distances, 141 *et seq.*
 — laws of motion, 200.
 — letter from Galileo, 157.

- Kepler, Johann, methods of reasoning, 147.
 — on celestial harmonies, 147.
 — on shape of planetary orbit, 145.
 — tests Tycho's observations, 143.
 — three laws of, 146.
- Kircher, Athanasius, microscopist, 260.
- Kitasato, Shibasabura, 902.
- Kneller, Sir Godfrey, portrait of Wren, 262.
- Knight, Prof. W., on causation, 944.
- Knox-Shaw, Dr., diagram of velocity of nebulae, 638.
- Kober, L., geosynclinal hypothesis of surface structure of earth, 678.
- Koch, Robert, at International Medical Congress, 888.
 — founder of modern bacteriology, 746.
 — postulates for isolation of pathogenic germs, 887, 899.
- Kohlrusch, magnetic experiments of, 356.
- Kohlörster, Prof. W., observations on cosmic rays, 654.
- Kramers, on structure of radium atom, 478.
- la Cour, Dr., instruments for polar exploration, 724.
- Lactantius on a spherical earth, 87.
- Lagrange, J. L., mathematician, 219, 339.
- Lake, Philip, on origin of continents and oceans, 679.
- Lamarck, J. B. P., evolutionary theory of, 740.
 — theory of heredity, 796.
- Lanfrey, M., on academies, 237.
- Langevin, Prof., on chemical warfare, 1022.
- Langmuir, Prof. Irving, 480.
 — on static atom, 483.
- Lankester, Prof. Ray, zoologist, 746.
- Larmor, Sir J., discoveries of, 536.
 — on relativity, 537.
- Lavoisier, Antoine Laurent, 307 *et seq.*
 — and the phlogiston theory, 275.
 — founder of biochemistry, 911.
 — guillotined, 310.
 — investigation of atmospheric air, 308.
 — names oxygen, 309.
 — onslaught on phlogiston, 309.
- Lawes, Sir John, experiments in animal feeding, 867.
 — work on agricultural science, 866.
- Lawrence, Prof. E. O., bombardment with heavy hydrogen, 505.
 — on transformation of elements, 507.
- Layard, archaeologist, 836.
- Leakey, Dr. L. S. B., discovers fossil remains, 831.
- Leavitt, Miss, astronomer, 631.
- Le Bel, J. A., 492.
- Legendre, Adrien Marie, mathematician, 219.
- Leibnitz, Gottfried Wilhelm, 190.
 — accused of plagiarism, 216.
 — accuses Newton of plagiarism, 215.
 — claims invention of calculus, 214.
 — compared with Newton, 216.
 — controversy with Newton, 191.
 — idealism of philosophy of, 228.
 — notation of, 214, 216.
 — philosophy of, 227-8.
 — reputation as mathematician, 216.
- Lemaître, Abbé G., conception of universe, 642.
 — view of framework of the universe, 988.
- Lenard, P., on penetration of cathode rays, 447.
- Lennard-Jones, Prof., 603.
- Leo X, Pope, 111.
- Leucippus, atomic theory of, 77.
- Le Verrier, U. J. J., determines position of Neptune, 970.
 — discovers excess motion of perihelion of Mercury, 974.
- Levy, Prof. H., on indeterminacy, 954.
- Lévy, Michel, synthesis of minerals, 659.
- Lewes, G. H., on causation, 943.
- Lewis, Prof. G. N., on heavy water, 508.
 — on stability of the atom, 480.
- Lewis-Langmuir, static atom of, 479 *et seq.*
- Libavius opposes Paracelsus, 268.
- Liebig, Baron Justus, biochemical work of, 911.
 — letter to Faraday, 1023.
 — work on agricultural science, 866.
- Lindemann, Prof. F. A., on expansion of the universe, 649.
 — helium liquefaction plant of, 577.
 — on limitations of mathematics, 977.
- Linnaeus, Carl, system of biological classification, 735-6, 754.
- Lister, Lord, and wound infection, 878.
 — at International Medical Congress, 888.
 — Lord Moynihan on, 885.
 — pioneer of antiseptic surgery, 885.
- Lobachevsky, non-Euclidean geometry of, 543.
- Locke, John, 221 *et seq.*
 — as student of chemistry, 222.
 — assessment of value of philosophy of, 226 *et seq.*
 — at Oxford, 221.
 — books for reference on, 231.
 — early years of, 221.
 — fundamentals of philosophy of, 223.
 — on education, 230.
 — on ideas of reflection, 225.

- Locke, John, on ideas of sensation, 225.
 — on innate ideas, 224.
 — on the nature of perception, 225.
 — practice of medicine, 230.
 — sympathy with naturalism, 228.
 Lodge, Sir Oliver, 211.
 Long, Dr., and anaesthesia, 884.
 Lorentz, H. A., discoveries of, 536.
 — on contraction factor for course of light, 548.
 Louis XIV and floral academy, 234.
 Love, Prof. A. E. H., on earthquake waves, 686.
 Lucretius, Titus Caius, 82.
 Luther, Martin, 112 *et seq.*
 Lyell, Sir Charles, 657.
- Macbride, Prof. E. W., 796, 801.
 — evolutionary theories of, 817, 819.
 Macdonald, on heavy water, 508.
 McDougall, William, 930.
 McGregor, Prof. J. H., models of prehistoric man, 834.
 Mach, Prof. Ernst, on causation, 944.
 Machiavelli, 234.
 McKie, D., on Priestley, 299.
 MacLaurin, Colin, mathematician, 219.
 Macmillan, Prof. W. D., hypothesis of loss of energy of light, 639.
 Maiuri, Prof. Amedeo, archaeological work of, 849.
 Malpighi, founder of histology, 261.
 Manson, Sir Patrick, research on tropical disease, 905.
 Marconi, Marchese, invention of "wireless", 592.
 — radio-telegraphy of, 724.
 Marcus Aurelius, Emperor, 879.
 Marsh, O. T., palaeontologist, 696.
 Marshall, John, research on mosquitoes, 863.
 Martin, Thomas, 363.
 Maxwell, James Clerk, 971.
 — friendship with Faraday, 357.
 — immortality of work of, 1014.
 — mathematical inferences on light, 392.
 — on Ampère's theory, 340.
 — on average effects, 437.
 — on kinetic theory of gases, 972.
 — on relativity, 536.
 — radio-telegraphy by, 724.
 — Sir J. J. Thomson on the equations of, 356.
 — supports Faraday, 354.
 — theory of heat, 438.
 — wave theory of, 356. [624.
 Mayer, Simon, rediscovers Andromeda, — discovers conservation of energy, 354.
 Mayow, John, physician, 261, 882.
 — on combustion, 274.
 Melotte, astronomer, 620.
- Mendel, G., law of free assortment, 807.
 — theory of heredity, 746, 799, 800, 803.
 Mendeléeff, periodic law of elements, 442.
 — periodic table of, 443.
 — prediction of undiscovered elements, 442.
 Mendelssohn, liquefaction of helium by, 577.
 Menzel, discovery of heavy hydrogen, 508.
 Meyer, Julius Lothar, graph of the elements, 442.
 Michelangelo, 111.
 Michell, John, book on earthquakes, 656.
 — inventor of torsion balance, 690.
 Michelson, Prof. A. A., development of interferometer, 629.
 — interferometer experiments of, 547.
 — measures the velocity of light, 418.
 Mill, John Stuart, 229.
 — on causation, 943.
 — on hypotheses, 964.
 Miller, Prof. D. C., interferometer experiments of, 562.
 Millikan, Prof. R. A., on cosmic rays, 652.
 — method of determining charge on electron, 463.
 — on atomic-building process, 653.
 Milne, Prof. E. A., on expansion of the nebulae, 648.
 — on space, 648.
 — on the universe, 647.
 Milton, John, 161.
 Minkowski, and relativity, 536.
 — mathematical work of, 554.
 — space-time of, 976.
 Mitchell, Sir P. Chalmers, zoologist, 746.
 Mohammed, 99.
 Moir, Prof. J. Reid, 832.
 Montague, Lady Mary Wortley, 891.
 More, Sir Thomas, 111, 113.
 Morgan, Prof. G. T., on synthetic resins from coal, 575.
 Morgan, Prof. T. Hunt, 802, 807.
 — evolutionary theories of, 817.
 — map of chromosomes, 813, 815.
 Morison, Dr. J. M. Woodburn, on radiology, 909.
 Morley, mathematician, 546.
 Morton, William, and anaesthesia, 884.
 Moseley, G. J. photographs of X-rays spectra, 466.
 — work of, 465.
 Mott, N. F., 603.
 Moulton, Prof. F. R., tidal hypothesis of origin of the earth, 663.
 Moynihan, Lord, 895.
 — on Lister, 885.
 — on medical training, 922.

- Moynihan, Lord, on vivisection, 894.
 — on work of Hippocrates and Galen, 880.
- Müller, Fritz, effect of X-rays on rate of mutation, 820.
 — on ontogeny, 777.
- Murphy, isolation of heavy hydrogen by, 508.
- Napier, John, invents logarithms, 140.
- Newcomen, Thomas, reciprocating engine of, 583.
- Newlands, J. A. R., law of octaves, 441.
- Newman, Sir George, Chief Medical Officer of Health, 893.
 — on health of the community, 890.
 — on Harvey's work, 882.
 — on Koch's work, 888.
- Newton, Sir Isaac, 192 *et seq.*
 — accused of plagiarism, 215-16.
 — and corpuscular hypothesis of light, 411.
 — and the emission theory of light, 198, 418.
 — and the spectrum of light, 197.
 — appointed Master of the Mint, 217.
 — Arago's opinion of, 218.
 — at Cambridge, 193.
 — birthplace of, 218.
 — books for reference on, 220.
 — — on contemporaries of, 191.
 — Burnet's appreciation of, 217.
 — calculates attraction by earth on the moon, 203.
 — Cartesian opposition to conceptions of, 212.
 — compared with Archimedes, 53.
 — — with Faraday, 344.
 — — with Leibnitz, 216.
 — contemporaries of, 187.
 — Cruikshank's imaginary sketch of, 217.
 — determination of path of comets, 211, 212.
 — discoveries of, 194.
 — — in relation to relativity, 536.
 — early life of, 192.
 — elected President of Royal Society, 217.
 — experimental mind of, 193.
 — experiments on the solar spectrum, 422.
 — generalizations of, challenged, 1016.
 — invention of fluxions by, 215.
 — judgment on his own work, 218.
 — Leibnitz's review of work of, 215.
 — makes reflecting telescope, 195.
 — Marquis de l'Hôpital on, 218.
 — mathematics after, 219.
 — method of limits, 57.
 — monument of, in Westminster Abbey, 219.
- Newton, Sir Isaac, notation of, 214.
 — on æther, 199.
 — on hypotheses, 966-7.
 — on orbits of the planets, 207.
 — optics of, 195, 215.
 — Pope's epigram on, 218.
 — predecessors of, 187 *et seq.*
 — *Principia* of, 206 *et seq.*
 — principle of simplicity, 968.
 — researches on light, 196.
 — "rings" of, 414.
 — standard of morality, 217.
 — statement of laws of motion, 201.
 — telescope of, at Royal Society, 196.
 — theory of the rainbow, 197.
 — treatment of perturbations of the moon, 211.
 — view of quantities, 214.
 — Voltaire attends funeral of, 219.
 — Voltaire's support of, 212.
 — Whewell's view of work of, 217.
- Nicholson, William, electric decomposition of water by, 336.
- Nikolas of Casa, astronomer, 119.
- Occam, William of, "razor", 109 917.
- Oersted, Hans Christian, electrician, 338-9.
 — on electricity and magnetism, 361.
- Ohm, George Simon, law of, anticipated by Cavendish, 331.
- Oliphant, M. L., on disintegration of elements, 505.
- Oliver, work on endocrine glands, 920.
- Omar I, Caliph, destroys library at Alexandria, 44.
- Ormerod, Eleanor A., work on economic entomology, 860.
- Orpen, J. M., geologist, 763.
- Osborn, Prof. H. F., 802, 832.
 — work on evolution of the horse, 784.
- Owen, John, and religious duty of toleration, 222.
- Owen, Sir R., biological researches of, 738.
- Oxford, Lord, as lawyer, 1017.
- Palissy, Bernard, enameller, 117.
- Pappus, mathematician, 44.
- Paracelsus, alchemist, 116, 267.
 — debt of chemistry to, 267.
 — opposed by Libavius, 268.
 — three principles of, 286.
- Parmenides, 39.
- Parsons, Sir C. A., invents the turbine, 582 *et seq.*
- Pascal, Blaise, 176, 188.
 — arithmetical triangle of, 188.
- Pasteur, Louis, pathologist, 746.
 — at International Medical Congress, 889.
 — biochemical work of, 885, 912.

- Pasteur, Louis, immortality of work of, 1014.
 — scientific discoveries of, 885 *et seq.*
- Pearson, Prof. Karl, 799.
 — on causation, 946.
- Pepys, manager of Royal Institution, 347.
- Perot, determination of densities of saturated vapours, 388.
- Perrin, Jean, interpretation of Brownian movement, 486.
- Petavel, Sir Joseph, 594.
- Petrarch, founder of Renaissance in Italy, 110.
- Piaggio, Prof., 992.
- Picard, Jean, measurement of earth's radius, 206.
- Piccard, Prof. A., observations on cosmic rays, 653.
- Planck, Prof. Max, on indeterminacy, 958.
 — quantum theory of, 514.
 — radiation constant of, 473, 515.
- Plaskett, Prof. H. H., on theory in astronomy, 649.
- Plato, 926.
 — Academic school of philosophy, 42, 232.
 — analytical method of, 49, 50.
 — and the Athenian School, 40.
 — conception of the structure of the universe, 79.
 — philosophy of, 41.
 — physical knowledge of, 78.
- Pliny the Elder, natural history of, 83.
- Poincaré, Henri, observations on fluorescence, 449.
 — on hypotheses, 966.
- Pope, Alexander, epigram on Newton, 218.
 — on Demoiivre, 219.
- Poulton, E. B., on colour in struggle for life, 800.
- Priestley, Joseph, 298 *et seq.*
 — and the phlogiston theory, 275, 301.
 — dephlogisticated air of, 301.
 — discovers oxygen, 299.
- Procter, Dr. Joan B., zoologist, 860.
- Proctor, Richard A., astronomer, 619.
 — Saturn's path plotted by, 65.
- Prokofieff, ascent into high atmosphere, 654.
- Proust, J. L., law of constant proportions, 312.
- Ptolemy, Claudius, astronomer, 12, 43.
 — "almagest" of, 61.
 — founds the museum, 233.
- Purbach, George, astronomer, 119.
- Pythagoras, achievements of, 38.
 — conception of the universe, 59.
 — mathematical discoveries of, 46.
 — physical knowledge of, 75.
 — theorem of, and the Egyptians, 31.
- Raman, Sir C. V., awarded Nobel Prize 1011.
- Rameses II, 20.
- Ramsay, Sir William, awarded Nobel Prize, 1011.
 — discovers helium, 576.
- Randall-MacIver, Dr. D., 836.
- Rankine, Prof. A. O., on geophysical surveying, 695.
- Raphael, 111.
- Ray, John, classification of plants, 735.
- Rayleigh, Lord, awarded Nobel Prize, 1010.
 — discovers argon, 507, 576.
 — on earthquake waves, 686.
 — on proof, 972.
- Rayton, Dr. W. B., spectrographic lens of, 635.
- Read, Prof. Carveth, on causation, 946.
 — on hypotheses, 965.
- Réaumur, (René) Antoine, 329.
- Regener, Prof., observations on cosmic rays, 653-4.
- Regiomontanus, astronomer, 119.
- Rey, Jean, views on combustion, 274.
- Ricci, and relativity, 536.
- Richardson, Prof. O. W., awarded Nobel Prize, 1011.
- Riemann, and relativity, 536.
 — non-Euclidean geometry of, 543.
- Ritz, atomic law of, 472.
- Robb, Dr. A. A., 1008.
- Rockefeller, J. D., 604.
- Römer, Olaus, measures velocity of light, 417.
- Röntgen, Karl, discovers X-rays, 448.
 — work on radiology, 908.
- Rosenheim, O., work on vitamins, 914.
- Ross, Sir R., awarded Nobel Prize, 1011.
 — discovers malaria parasites, 862.
 — research on tropical disease, 905.
- Rotch, Prof. L., observations of upper atmosphere, 703.
- Rothschild, Lord, address at British Association, 754.
- Roux, W., 803.
- Rumford, Count, founds Royal Institution, 321, 347.
 — on heat as motion, 433.
- Russell, Bertrand, on Einstein's law of gravitation, 555.
 — on indeterminacy, 957.
 — on limitations of mathematics, 979.
 — on mathematics, 979.
 — on the expanding universe, 995.
 — on the mysterious universe, 995 *et seq.*
- Russell, Sir E. J., work on agricultural research, 868.
- Rutherford, Lord, Director of Cavendish Laboratory, 598.

- Rutherford, Lord, awarded Nobel Prize, and Order of Merit, 1011.
 — bombardment of gas atoms, 462.
 — of nitrogen nuclei, 503.
 — experiments on the atom, 459, 462.
 — immortality of work of, 1014.
 — model atom of, 470.
 — on energy of radium, 451.
 — on heavy hydrogen, 508.
 — on stored atomic energy, 506.
 — on transformation of elements, 504.
- Samuel, Sir Herbert, on indeterminacy, 951.
- Scarburgh, Dr., 876.
- Schäfer, work on endocrine glands, 920.
- Scheele, Karl Wilhelm, and the phlogiston theory, 275.
 — discovers oxygen, 302.
 — "fire-air" of, 302.
- Schick, B., 902.
- Schiller, Dr. F. C. S., 930.
 — on hypotheses, 965.
- Schleiden, M. J., contributions to cell theory, 742.
 — discovers cellular structure of plants, 761.
- Schliemann, archaeologist, 836.
 — explorations of, 13.
- Schrödinger, E., awarded Nobel Prize, 1011.
 — "momentum" of, 532.
 — wave mechanics of, 529.
- Schuster, on mathematical interpretations, 393.
 — on numerical relationships, 379.
- Schwann, discovers cellular structure of animals, 761.
- Schweigger, invents galvanometer, 339, 342.
- Scribonius, "receipt" book of, 84.
- Seares, Prof. F. H., astronomer, 617, 620, 622.
- Sedgwick, Adam, geologist, 743.
- Seeliger, astronomer, 620.
- Seneca, 83.
- Servetus, 240, 247, 882.
- Settle, ascent into high atmosphere, 654.
- Shakespeare, William, 176.
- Shapley, Dr. Harlow, on cepheid variables, 631.
 — on globular clusters, 623.
- Shaw, G. B., awarded Nobel Prize, 1011.
- Shaw, Dr. H. Knox, on expansion of the universe, 649.
- Sherrington, Sir Charles, 895.
 — awarded Nobel Prize and Order of Merit, 1011.
 — immortality of work of, 1014.
- Silberstein, Dr. Ludwik, on indeterminacy, 960.
- Simon, Prof., liquefaction of helium by, 577.
- Simpson, Sir James Young, and anaesthesia, 884.
- Simpson, Thomas, mathematician, 219.
- Smith, Prof. G. Elliot, 832.
- Smith, Piazzi, 29.
- Smith, William, founder of stratigraphical geology, 657.
- Socrates, 40.
 — philosophy of, 41.
- Soddy, Prof. F., awarded Nobel Prize, 1011.
 — experiment on disintegration of uranium, 682.
 — interpretation of the atom, 468.
 — on energy of radium, 451.
 — on heavy hydrogen, 508.
 — on propagation of solar radiation, 655.
 — on static atom, 483.
- Sommerfeld, Arnold, theory of elliptic orbits, 477.
 — work on X-ray spectra, 465.
- Sorby, H. C., petrographical work of, 657.
 — production of sections of rock by, 660.
- Spencer, Herbert, 229, 746.
- Spenser, Edmund, 176.
- Stahl, G. E., views on combustion, 272.
- Stamp, Sir Josiah, on science in relation to economics, 1019.
- Stapleton, Prof. R. G., research on plant breeding, 871.
- Starling, work on hormones, 920.
- Steers, Dr. J. A., on the structure of the earth, 680.
- Stevinus, 173 *et seq.*
- Störmer, Prof., Polar observations of, 723.
- Struve, F. G. W., astronomer, 618.
- Sullivan, J. W. N., on mathematics and culture, 971.
- Sydenham, Thomas, physician, 261, 882.
 — books for reference on, 263.
- Sylvester, æsthetic attitude to mathematics, 927.
- Szent-Györgyi, Prof. A., work on vitamins, 914, 916.
- Taylor, Brook, mathematician, 219.
- Tertullian, 87.
- Thales founds Ionian school, 37.
 — reputation of, 37.
 — views on the earth, 59.
- Theophrastus, 42.
 — achievements in botany, 70.
- Thompson, Prof. D'Arcy, and mathematical biology, 801.
 — Cartesian comparison of skulls of apes and man, 851.

- Thomson, G. P., on diffraction of electrons, 520.
- Thomson, Sir J. J., awarded Nobel Prize, 1010.
- awarded Order of Merit, 1011.
- determines charge on electron, 463.
- discovers electrons, 458.
- experiments on cathode particles, 460.
- — on the atom, 459.
- investigation of positive rays, 467.
- model atom of, 470.
- on Maxwell's equations, 356.
- Thomson, William, *see* Kelvin, Lord.
- Titian, 111.
- Tizard, H. T., 602.
- Torricelli, E., 161, 176.
- discovers principle of barometer, 698.
- Townsend, J. S., determines charge on electron, 463.
- Tull, Jethro, and agricultural research, 866.
- Turner, J. E., on indeterminacy, 957.
- Turville-Petre, F., 832, 847.
- Tutankhamen, King, tomb of, 12, 848.
- Twort, F. W., work on the bacteriophage, 903.
- Tycho Brahé, astronomer, 119, 132 *et seq.*
- attitude to Copernican system, 133 *et seq.*
- books for reference on, 139.
- Kepler tests observations of, 143.
- planetary system of, 136.
- quadrant of, 137.
- Tylor, Sir Edward, 837.
- Tyndale, Prof. A. M., 603.
- Tyndall, John, appointed Professor at Royal Institution, 359.
- as colleague of Faraday, 358.
- estimate of Huxley, 745.
- experiment on refraction of light, 423.
- Urey, Prof. H. C., isolation of heavy hydrogen, 508, 509.
- Van de Graaff, electrostatic generator of, 506.
- Van Helmont, B., discovery of gases by, 269.
- Van Leeuwenhoek, Antony, microscopist, 260.
- Van Musschenbroek, P., electrician, 329.
- Van Rhijn, P. J., astronomer, 620, 622.
- Van't Hoff, J. H., 492.
- Varro, 83.
- Vasic, Prof., archæological work of, 849.
- Veblen, seven-point geometry of, 976.
- Vegard, Prof. L., on the aurora, 730.
- Venn, Dr. J., on hypotheses, 965.
- Verulam, Lord, *see* Bacon, F.
- Vesalius, Andreas, as anatomist, 116, 240.
- medical work of, 881.
- Vespucci, Amerigo, 114.
- Vitruvius, work on architecture, 83.
- Volta, Alessandro, electrician, 332.
- "pile" of, 333.
- Voltaire's support of Newton, 212.
- von Ardenne, Baron, process of television of, 589.
- von Baer, K. E., discovery of mammalian ovum, 741.
- embryological laws of, 776.
- von Behring, Emil, 902.
- von Laue, M., discovers diffraction of X-rays, 465.
- X-rays analysis of crystals by, 496.
- von Lichtenburg, radiographic method of, 910.
- von Mohl, on protoplasm, 761.
- von Wassermann, August, 902.
- Vyse, Howard, 29.
- Waldschmidt-Leitz, Prof. E., work on enzymes, 914.
- Wallace, Alfred Russel, theory of natural selection, 745.
- Wallis, John, 188.
- method of finding areas of curves, 213.
- Walton, Dr. E. T. S., 598.
- on disintegration of elements, 505.
- Watt, James, steam engine of, 583-4.
- Weber, magnetic experiments of, 356.
- Webster, T. A., work on vitamins, 914, 916.
- Weismann, August, leader of neo-Darwinians, 746.
- theory of heredity, 798.
- Wells, H. G., 759.
- as zoologist, 823.
- Wells, Horace, and anaesthesia, 884.
- Werner, Abraham Gottlob, work on strata in Hartz mountains, 656.
- Wertwig, Oskar, embryologist, 778.
- Wheeler, Dr. and Mrs. R. E. Mortimer, archæological work of, 848.
- Whewell, Dr. W., on hypotheses, 964.
- opinion of Newton's work, 217.
- White, Gilbert, 737.
- Whitehead, Prof. A. N., books of, 563.
- on man's changing outlook on life, 1015.
- on relativity, 564-5.
- on remorseless inevitableness in scientific thought, 1018.
- Whitehead, Sir Charles, 860.
- Widal, Ferdinand, 902.
- William of Normandy, 874.
- William of Occam, 917.
- Williams, Bishop, on religion in relation to science, 1031.

- Wills, H. H., founds physical laboratory in Bristol, 602.
- Willstätter, Prof. R., work on enzymes, 914.
— work on plant pigments, 758.
- Willughby, F., classification of animals, 735.
- Wilson, Prof. C. T. R., awarded Nobel Prize, 1011.
— photographs alpha-ray tracks, 462.
— work on thermometers, 699.
- Wilson, H. A., determines charge on electron, 463.
- Windaus, work on vitamins, 914.
- Wöhler, F., biochemical work of, 912.
- Wolff, G., 803.
- Wollaston, Wm. Hyde, experiments on electrical power, 361.
— optical equipment of, 592.
- Wood, Prof. R. W., and photography by invisible rays, 587.
- Woodward, Prof. A. Smith, 832.
— reconstruction of Piltown man, 829.
- Woolley, C. L., archæological work of, 848.
- Worthington, Prof., 395.
- Wren, Sir Christopher, 882.
— as architect, 262.
— as mathematician, 190.
— as physician, 262.
— books for reference on, 263.
— dismissed by George I, 262.
— Kneller's portrait of, 262.
— on orbits of the planets, 207.
- Wright, Orville, invention of aeroplanes, 569.
- Wright, Sewall, 802.
- Wright, Wilbur, invention of aeroplanes, 569.
- Wurtz, on chemistry, 310.
- Xerxes, route followed by, 6.
- Yapp, W. J., 617.
- Yeats, W. B., awarded Nobel Prize, 1011.
- Yersin, Alexandre, 902.
- Young, Thomas, and the wave theory of light, 189, 419.
- Zeno of Elea, 39.
- Zwicky, Dr., theory of loss of energy of light, 639.

SUBJECT INDEX

- Absolute zero, 577.
 Absorption lines in spectra, 425.
 Académie des Jeux Floraux, 234.
 Academies and Societies, books for
 reference on, 238.
 — Lanfrey on, 237.
 — Matthew Arnold on, 237.
 — modern, 234.
 — Renaissance, 234.
 — rise of, 232.
 Academy, Athenian, 232.
 — Cicero and the, 233.
 — difference from Society, 234.
 — significance of the term, 233.
 Acheulean culture, 839.
 — tools of, 841.
 Actinium, discovery of, 451.
 Actinotherapy, 889.
 Addison's disease, 920.
 Adrenalin, 919.
 Ægean, sketch map of the, 6.
 Aerodynamic Department of National
 Physical Laboratory, 595 *et seq.*
 Aeroplanes, invention of, 569.
 — use of, in meteorology, 704.
 Æther, inference of stationary, 546.
 — modern physicists and the term, 421.
 — Newton on, 199.
 Africa, geography of North East, 1.
 Agricultural Colleges, 864.
 — Institutions, 868.
 — research, advances in, 866 *et seq.*
 — — books for reference of, 872.
 Agriculture, Board of, 855.
 — control of insects injurious to, 859.
 — economic, 885.
 — education in, 864.
 — Ministry of, *see* Ministry of Agri-
 culture and Fisheries.
 Agrigentum School of Medicine, 71.
 Agromegaly, 920.
 Air, atmospheric, Lavoisier's investi-
 gation of, 308.
 — Boyle's experiments on spring of the,
 279 *et seq.*
 — fixed, of Lavoisier, 309.
 — inflammable, of Cavendish, 303.
 — liquefaction of, 577.
- Air Ministry, meteorological department
 of, 699.
 — Priestley's dephlogisticated, 301.
 — temperature of, 709.
 Air-flow and barometric pressure, 718
 et seq.
 Air-pump, invention of, 176.
 Aircraft Establishment, research at,
 594.
 Aix-la-Chapelle, capital of Roman
 Empire, 94.
 Albumin molecule, size of, 903.
 — production of synthetic, 574.
 Alchemists, the, 264 *et seq.*
 Alchemy, "air" in, 266.
 — basic hypothesis of, 114.
 — Boyle and, 115.
 — "earth" in, 266.
 — "ether" in, 266.
 — "fire" in, 266.
 — modern chemists' view of, 267.
 — origin of, 264.
 — relation to chemistry, 116.
 — seven metals in, 266.
 — three principles of, 265.
 — unity of matter in, 265.
 — "water" in, 266.
 Alexandria, 7.
 — alchemy in, 264.
 — decline of learning in, 87.
 — foundation of, 12.
 — library at, 233.
 — — destruction of, 44, 88, 100.
 — medical library at, 74.
 — Mohammedan conquest of, 88.
 — — invasion of, 44.
 — museum at, 43, 233.
 — university at, 34.
 Alexandrian "museum", 232.
 — School, 43 *et seq.*
 — — chronological table of, 45.
 — — of Medicine, 74.
 Alfred Yarrow tank, 597.
Al-gebr, 100.
 Algol, changes in brightness of, 423.
 Alkalis, experiments on caustic, 294 *et*
 seq.
 Allelomorphs, 806.

- Alloys, Faraday's researches on, 352.
 Alpha-particle bombardment, 503 *et seq.*
 Alpha-particles, lithium transformed into, 505.
 Alphabetic writing, 10.
 Alps, Palæolithic culture in, 849.
 Altazimuth, principle of, 139.
 Altimeter of the airman, 707.
 Altitudes measured by barometric pressure, 176.
 Amber, insects in, 783.
 Amœba, 786.
 Ampere, definition of, 573.
 Amphibians, 784.
 — evolution of, 789, 790.
 Anæsthesia, discoveries in, 884.
 Anatomy and theology, 239.
 — Bichat as founder of general, 737.
 — Columbus and, 240.
 — Cuvier as founder of comparative, 738.
 — Owen as authority on comparative, 739.
 — Vesalius and, 240.
 Ancient World, geography of, 1.
 Andromeda, nebula of, 624.
 Anemometers, 701.
 Aneroid barometers, 703.
 Ångström wave-length units, 429, 431, 634.
 Animal breeding, research in, 869, 870.
 — development, hypotheses of, 780.
 — evolution, evidence of, 781.
 — nutrition, research in, 867, 868, 871.
 — ontogeny of, 769.
 Animals, blood-relationship of, 748.
 — distinction from plants, 733.
 — evolution of domesticated, 818.
 — evolutionary stages of, 752.
 — farm, Ministry of Agriculture leaflets on, 856.
 — fossilized, 782.
 — life cycle in, 809, 810.
 — linkage forms between, 784.
 — probable relationships of, 786, 788.
 — race-history of, 783.
 — Willughby's classification of, 735.
 Annelids, 787-8.
 Anode rays, 447.
 Anomodonts, 753.
 Anopheline mosquitoes, 861.
 Antecedence, 937, 940.
 Anthrax bacillus, isolation of, 887.
 Anthropoid apes, 824.
 Anthropologists and race-blending, 1026.
 Anthropology, books of reference on, 832, 853.
 — definition of, 824.
 — training in, 852.
 Anti-bodies, 900, 901.
 Anticyclonic system in meteorology, 720 *et seq.*
 Antimony in treatment of black fever, 908.
 Antineuritic vitamin, 915.
 Antioch, 4.
 Antirachitic vitamins, 915.
 Antiscorbutic vitamin, 915.
 Antiseptic, definition of, 873.
 — surgery introduced by Lister, 885.
 Antitoxins, 901.
 Apes compared with man, 825-6.
 — family of, 824.
 Appleton layer, 727.
 Arab Schools, 101.
 Arabs, 99 *et seq.*
 — books for reference on, 101.
 — contribution to mathematical science, 99.
 Archæological records, 20.
 Archæologist, work of the, 837, 846.
 Archæology, books for reference on, 853.
 — definition of, 824.
 — evidence from, 19.
 — evidence of, 20.
 — main subject of, 836.
 Architecture, modern, 585.
 — of Wren, 262.
 Arctic Circle, exploration of, 723.
 Argon, 458.
 — discovery of, 507, 576.
 — period, 482.
 Aristotelians, Boyle's evidence against, 290.
 — doctrine of the, 285.
 Arithmetic, "index" notation in, 608.
 — systems of notation in, 609.
 — triangle of Pascal, 188.
 Arsenic in treatment of syphilis, 903.
 Art, chief function of, 972.
 Arteriography, 910.
 Arthropods, 787-8, 821.
 Arts, Royal Academy of, 234, 236.
 Ascorbic acid, 916.
 Aseptic, definition of, 873.
 Asia, geographical interest of south-west, 4.
 — sketch map of south-west, 5.
 Asia Minor, Greek colonization of, 6.
 Assyria, 4, 13.
 — sanitation of, 874.
 Astrology as spurious science, 114.
 Astronomical atom, Bohr's, 472 *et seq.*
 — optimism, 652 *et seq.*
 — pessimism, 651.
 — system of arithmetical notation, 609.
 Astronomy, achievements of Hipparchus in, 61.
 — and cosmogony, 605 *et seq.*
 — Babylonian, 23.
 — books for reference on, 655.
 — definition of, 605.
 — Greek, 58 *et seq.*
 — in Ancient Egypt, 12.

- Astronomy**, Plaskett on theory in, 649.
 — progress of Greek, 59.
 — space-curvature and, 644.
 — the new, 119 *et seq.*
 — book for reference on, 126.
 — treatise on, by Eudoxus, 60.
 — units of measurement in, 610.
Athenian "academy", 232.
 — School, 39.
 — and Plato, 40.
 — closure of, 88.
Athens, 7.
 — Lyceum at, 42.
 — Peripatetic School in, 42.
Atmosphere, ascents into the high, 653.
 — diffusion of gases into, 706.
 — distribution of gases in, 716.
 — upper, *see* Upper atmosphere.
 — variation of pressure of, with height, 707.
Atmospheric electricity, old and new theories of, 729.
 — layers, 728, 729.
 — pressure, 704 *et seq.*
 — Laplace's law of diminution of, 707.
 — refraction, wireless waves and, 724.
Atom, Anaxagoras' theory of the, 77.
 — application of quantum theory to structure of, 472 *et seq.*
 — Balmer Law and the, 472.
 — birth of nuclear, 463.
 — Blakett's photographs of bombarded, 465.
 — Bohr's dynamic model of the, 471.
 — Bohr's theory of the, 472.
 — building process, Millikan on, 653.
 — Bury on the statical, 483.
 — components of nucleus of, 502.
 — dynamic model contrasted with static, 483 *et seq.*
 — electronic orbits of, 511.
 — experimental evidence of constitution of, 459 *et seq.*
 — fundamental facts and inferences on, 454 *et seq.*
 — Langmuir on statical, 483.
 — Lewis-Langmuir static, 479 *et seq.*
 — modern theories of the, 470.
 — radium, 478.
 — removal of electrons from, 501.
 — Ritz law and the, 472.
 — Rutherford's bombardment of gas, 462.
 — experiments on the, 459.
 — model, 470.
 — Soddy on statical, 483.
 — static model hypothesis of, and chemical affinity, 482.
 — statistical evidence of constitution of, 459.
 — structure of the, 445.
 — Thomson's experiments on the, 459.
Atom, Thomson's model, 470.
Atomic energy, Rutherford on stored, 506.
 — linking and rotation of light, 493.
 — nuclei, disruption of, 503.
 — nucleus, 456.
 — numbers, 456.
 — and the periodic law, 445.
 — and X-ray spectrum, 465.
 — periodic table according to, 457.
 — solar system, 458.
 — structures, calculus of probability in connexion with, 439.
 — theory, books for reference on, 327.
 — Dalton's, and present-day knowledge, 319.
 — established, 311 *et seq.*
 — of Democritus, 77.
 — of Leucippus, 77.
 — volume, relation to atomic weight, 442.
 — weight, 455.
 — determination of, 323.
 — relation to atomic volume, 442.
Atoms and molecules, 327.
 — carbon, in molecule, 489.
 — linking of, 489.
 — nature of, 311.
 — primitive stuff of, 455.
 — relative masses of, 470.
 — valency of, 488.
Aurignacian culture, 839, 842-3.
Aurora, the, 730.
 — spectrum of the, 730.
 — study of the, 725.
Auroral observatory at Tromsø, 730.
Australopithecus, 832-3.
Autocracy, duration of, 1012.
Aviator, altimeter of the, 707.
Axiom, nature of, 541.
Babylon, 4.
 — sanitation of, 874.
Babylonia, civilization of, 13.
 — records of, 13.
 — science in, as monopoly of the priests 35.
 — summary of events in, 21.
Babylonian astronomy, 23.
 — books for reference on, 26.
 — desert, excavations in, 848.
 — observation of celestial motion, 25.
Babylonians, writing of the, 10.
Bacilli as cause of disease, 898.
 — discovery of, 886 *et seq.*
 — multiplication of, 896, 900.
 — staining of, 888.
 — types of, 898.
Bacillus form of bacteria, 897.
B. coli, 898.
Bacteria, basic shapes of, 897.
 — destruction by chemicals, 903.
 — nature of, 895.

- Bacterial cultures, 896, 899.
 Bacteriologists, Society of American, 898.
 Bacteriology, 734.
 — modern, founded by Koch, 746.
 — study of, 895.
 — use of, 889.
 Bacteriophage, 903.
 Ballon-sonde, use of, in meteorology, 704, 710.
 Balloons, observational ascents of, 703.
 Balmer constant, 385.
 — law and the atom, 472.
 Barbarian tribes in Europe, 89.
 Barium meal, 909.
 Barograph, 701.
 Barometer, discovery of principle of, 698.
 — invention of mercury, 176.
 Barometric pressure and air-flow, 718 *et seq.*
 Barysphere of the earth, 687 *et seq.*
 Benedictines, 103.
 Benzene, Faraday's isolation of, 490.
 — ring-structure of, 490.
 Beri-beri, 905.
 Beryllium, radiation of bombarded, 504.
 Bias, intellectual, 975.
 Bible, chronology of the, 22.
 Binomial theorem, Newton discovers, 194.
 Biochemical discoveries, 578, 883.
 Biochemistry and "life", 916.
 — discoveries in, 578, 883.
 — nature of, 911.
 — progress of, 912.
 Biogenetic law, Haeckel's, 777.
 Biology, 731 *et seq.*
 — and fixity of species, 748.
 — books for reference on, 760.
 — connotation of, 733.
 — economic, 855.
 — evolutionary facts from systematic, 781.
 — Greek, 68 *et seq.*
 — guiding principles of, 731.
 — Harvey's application of measurement to, 260.
 — in the 18th and 19th centuries, 734 *et seq.*
 — in the 20th century, 747.
 — mathematical relations in, 801.
 — of communal life, 731.
 — scope of, 732.
 — subdivisions of, 733.
 Biophors, 799.
 Birds, evolution of, 789, 790.
 Bismuth meal, 909.
 Black Death of 1348, 875.
 — fever, 905, 908.
 Black-body radiation, 513.
 Blastula, 770.
 Blood capillaries, first observation of, 260.
 Blood, chemistry and metabolism of, 883.
 — circulation, 242 *et seq.*
 — Aristotle's theory of, 257.
 — Cesalpino's theory of, 257.
 — Harvey on, 248.
 — views on, prior to Harvey, 247.
 — corpuscles, 900.
 — discovery of, 883.
 Bombs in warfare, 579.
 Books for reference on academies and societies, 238.
 — on advisers on methodical research, 186.
 — on agricultural research, 872.
 — on anthropology, 853.
 — on archæology, 853.
 — on astronomy and cosmogony, 655.
 — on atomic theory, 327.
 — on Babylonian astronomy, 26.
 — on biology, 760.
 — on Boyle, 292.
 — on chemistry from Black to Lavoisier, 310.
 — on contemporaries of Newton, 191.
 — on Copernicus, 131.
 — on cytology, 779.
 — on Dark Ages, 98.
 — on developments in physical science, 603.
 — on early civilizations, 22.
 — on early electrical research, 343.
 — on early rational chemistry, 276.
 — on Egyptian mathematics, 33.
 — on embryology, 779.
 — on evolution and heredity, 822.
 — on Faraday, 359, 375.
 — on fossil man, 832.
 — on foundation of mechanics, 176.
 — on Galileo, 162.
 — on geography of Ancient World, 7.
 — on geology and geophysics, 695.
 — on Greek astronomy, 67.
 — on Greek medicine, 74.
 — on Greek physical science, 80.
 — on Greek Schools, 45.
 — on Harvey, 263.
 — on Hindus and Arabs, 101.
 — on history of medicine, 263.
 — on Hume, 231.
 — on hygiene, 924.
 — on immunity to disease, 902.
 — on Kepler, 149.
 — on learning in the 13th century, 109.
 — on Locke, 231.
 — on medicine, 924.
 — on meteorology, 730.
 — on modern transmutation of elements, 509.
 — on modern science, 1033.
 — on new astronomy, 126.
 — on Newton, 220.
 — on Renaissance, 118.
 — on Roman science, 88.

- Books on Sydenham, 263.
 — on transition to newer physics, 440.
 — on Tycho Brahé, 139.
 Boron, disintegration of, 505.
 Botany, 733, 755 *et seq.*
 — achievements of Theophrastus in, 70.
 Bourdon tube-thermometers, 703.
 Boyle's law, 279, 705.
 Bridge construction, 585-8.
 Bristol, Henry Herbert Wills physical laboratory at, 602.
 British Academy, 236.
 — Medical Association, 238.
 — people, characteristics of the, 1023.
 — difference from Germans, 1025.
 Broadcasting, wireless waves used in, 726.
 Bronze in ancient Egypt, 12.
 Bronze Age, 844.
 — date of, 9.
 — discoveries of, 10.
 Brownian movement, 486, 739.
 — Perrin's interpretation of, 486.
 Building research, 595.
 Bunsen battery, 335.
 — burner, 335.
 Burglar alarm, photo-electric, 591.
 Burning lens, action of, 151.
 Cainozoic era, 839.
 Calciferol, 915.
 Calculus, Bisacre's book on, 394.
 — claim of Leibnitz to invention of, 214, 216.
 — the fluxional, 212 *et seq.*
 Caloric, theory of, 433.
 Cambridge School of Agriculture, 868-9.
 Camel, evolutionary changes in, 784.
 Camera, image formed in, 152.
 Canal rays, 447.
 Cancer, causation of, 902, 904.
 — radium therapy for, 911.
 Capillaries, discovery of, 260, 883.
 Carbon and neon, transformation of, 505.
 — atom, asymmetric, 492.
 — atoms, chains of, 490.
 — — Kekulé's hypothesis of, 489.
 — — linking of, 489.
 — compounds, Boerhaave and the chemistry of, 275.
 — nucleus, transformation of beryllium nucleus into, 504.
 Carbon dioxide, solid, 577.
 Carotin, 758.
 Cartesian comparison of skulls of apes and man, 851.
 — geometry, 185.
 Cartesians, opposition to Newtonian conception, 212.
 Catalysts, 913.
 Cathode particles, mass and velocity of, 460.
 Cathode particles, Thomson's experiments on, 460.
 — rays, 446.
 Causal condition, definition of, 959.
 Causality, existence of strict, 958.
 Causation in dynamic systems, 933, 935, 937.
 — in static systems, 934, 936.
 — mark of, 938.
 Cause and effect, 935.
 — authoritative opinions on, 943.
 — connexion between effect and, 940.
 — distinction from a condition, 938.
 — regression of, 941.
 — synonymous with action, 933.
 — the basis of change, 929, 934.
 Cave drawing of Palæolithic man, 8.
 Cavendish Laboratory, Cambridge, 598.
 — researches at the, 599.
 Cavity radiation, 513.
 Celestial motions, Babylonian observation of, 25.
 Cell, growth of, 762-3.
 — nucleus, 762.
 — organization, 732.
 — photo-electric, 590.
 — theory, 742, 883.
 Cells, blastomere, 772.
 — segmentation of, 770.
 — somatic, 765.
 Central Electricity Board, 580.
 Centrosomes, 762-3.
 Cepheid parallaxes, 630.
 — variables, 627, 630 *et seq.*
 — — period luminosity law applied to, 631.
 Cepheids, measurements of the, 629.
 Chaldæan priests, misuse of knowledge by, 26.
 Chaldæans, determination of solar year by, 25.
 — prediction of eclipses by, 24.
 Chance, discovery by, 391.
 — propagation of, 533.
 Change in relation to effect, 937.
 — the result of a cause, 929, 934.
 Characteristics, inheritance of, 798, 817.
 Chellean culture, 839.
 — tools of, 841.
 Chemical affinity and electricity, Berzelius on, 491.
 — — static model hypothesis of the atom and, 482.
 — compounds, Dalton's theory of, 315 *et seq.*
 — research laboratories, 593.
 — Society, 236.
 — synthesis, Dalton's postulates for, 314.
 Chemicals, fine, 577 *et seq.*
 — laboratory, 578.
 — medicinal, 577.
 — photographic, 578.

- Chemistry and the Greeks, 77.
 — books for reference on, 276, 310.
 — debt of, to Paracelsus, 267.
 — developments in, 574 *et seq.*
 — first attempt at a rational, 264 *et seq.*
 — from Black to Lavoisier, 293 *et seq.*
 — in warfare, 579, 1021.
 — Locke as student of, 222.
 — of carbon compounds, Boerhaave and the, 275.
 — of digestion, 883.
 — relation of alchemy to, 116.
 Chemists, the drug, 267.
 Chemotherapy, 889, 903.
 Chick embryo compared with human, 773.
 Chicken cholera, 886.
 Chimpanzee, Cartesian comparison of skulls of man and, 851.
 — likeness to man, 825-6.
 Chlorine, Davy establishes elementary nature of, 322.
 Chlorophyll, 758.
 — function of, 757, 759.
 Cholera, 888, 908.
 Christianity, attitude towards science, 1030.
 Chromosomes, 763 *et seq.*
 — and hereditary transmission, 795, 809.
 — junction and disjunction of, 811, 812.
 — map of four kinds of, 813, 815.
 Church, condition of Western in 15th century, 111.
 — Roman, condemns Copernican theory, 158.
 — supremacy, intellectual darkness during, 92.
 Churches, difficulties of the, 1030.
 Cinnabarite, working and use of, 849.
 Circle, ratio of circumference to diameter of a, 32.
 Circulation, pulmonary and systemic, 246.
 Circumcision depicted on Pyramid, 874.
 Civilization, decline of European, 1014.
 — recurrent periods of, 1012.
 — 16th century a peak period in, 1013.
 Civilizations, books of reference on early, 22.
 — historical summary of early, 8.
 Classical period of civilization, 1012.
 Clinical medicine, 873.
 — research, 894.
 — thermometer, 890.
 Clouds, classification of, 729.
 — iridescent, 730.
 Cnidus School of Medicine, 71.
 Cnossus, archæological discoveries at, 837.
 — Palace at, 14.
 Coal, hydrogenation of, 575.
 — resinic products from, 575.
 Coal, solar energy stored in, 435.
 — synthetic resins from, 575.
 Coal-tar and its products, 574.
 Coan School of Medicine, 71.
 Coccus form of bacteria, 897.
 Codling moth, 858.
 Coefficient of expansion, 382.
 Coefficients, 381.
 Cœlenterata, 786, 788.
 Cœlomata, 786, 788.
 Colorado beetle, 858.
 Colour, photography in, 587.
 — value of, in struggle for life, 800.
 Combustion, Becher's views on, 271.
 — Mayow on, 274.
 — Rey's views on, 274.
 — Stahl's views on, 272.
 Comet, Flamsteed's observation of path of, 212.
 — Newton's determination of path of, 211.
 Community, health of the, 890.
 Commutator, development of the, 373.
 Concepts, use of, 928.
 Condition, distinction from a cause, 938.
 Conduction, transmission of heat by, 708.
 Constantinople as seat of Roman Empire, 92.
 Constellations, map of main, 619.
 Convection, transmission of heat by, 708.
 Coolidge tube, 448.
 Copernican solar system, 120.
 — — Bacon's opinion on, 178.
 — — later modification of, 131.
 — — Tycho Brahe's attitude to, 133 *et seq.*
 — theory, attitude of Church towards, 161.
 — — Bruno condemned for propounding, 159.
 — — declared a heresy, 158.
 — — Galileo's support of, 155.
 Copper in ancient Egypt, 12.
 Corduba, Academy at, 233.
 Coronæ, formation of, 730.
 Cosmic rays, cloud method study of, 507.
 — in the high atmosphere, 653-4.
 — length of, 431.
 — Millikan on, 652.
 Cosmical repulsion, Einstein's theory of, 643.
 Cosmogony, books for reference on, 655.
 — definition of, 605.
 — hypotheses of, 606.
 Cotton-boll weevil, 858.
 Covalence and electrovalence, 500.
 Cow-pox a preventive of smallpox, 891, 892.

- Craftsmanship in the teaching of mathematics, 214.
- Crete, civilization of, 13.
- Neolithic Age in, 14.
- culture in, 9.
- Cro-Magnon man, 831, 834, 842.
- Crops, insects injurious to, 857.
- Ministry of Agriculture leaflets on, 856.
- scientific experiments on, 867.
- Croton School of Medicine, 71.
- Crystals and X-ray spectrometer, 495.
- ice, Bragg's model of, 498.
- space lattice of, 496.
- X-ray analysis of, 496.
- Culicine mosquitoes, 861.
- Culture, meaning of, 971.
- Cultures of the Stone Age, 838.
- Palæolithic, 839 *et seq.*, 849.
- Curves, areas of, 213.
- Cyclone, origin of, 722.
- Cyclonic system in meteorology, 722 *et seq.*
- Cytology and embryology, 761 *et seq.*
- Cytoplasm, 762.
- Damascus, 2.
- Dark Ages, 94.
- approximate periods in, 97.
- books for reference on, 98.
- Darwinism, 744.
- Dawn-man, discovery of, 829.
- Democracy the last stage of a civilization, 1013.
- Dengue, 905.
- Depression in meteorology, 721.
- Determination of an event, concept of, 947.
- Determinism, Eddington on, 948, 954.
- Levy on, 954.
- Deuterium, *see* Hydrogen, heavy.
- Deuteron, 508.
- Diabetes mellitus, 920.
- Diamond, Bragg's model of structure of, 497.
- Diastole, meaning of, 249.
- Dicotyledons, 933.
- Differential calculus, meaning of, 213.
- coefficient, 213.
- Differentiation, 214.
- Digestion, exploration of chemistry of, 883.
- process of, 913.
- Diphtheria bacillus, 888, 898, 901.
- Diplococci, 897.
- Diplogen, *see* Hydrogen, heavy.
- Diplon, *see* Hydrogen, heavy.
- Discontinuity of substances, 511.
- Discoveries made by chance, 391.
- by mathematical calculation, 392.
- Disease, artificial immunity to, 901.
- Hippocratic treatment of, 73.
- natural resistance to, 900.
- Disease, predisposing causes of, 938.
- Diseases caused by viruses, 902.
- micro-organisms the cause of, 898, 900.
- tropical, 905.
- Dispersion of light, 410.
- Distemper in dogs, 894, 902, 904.
- Dog distemper, 894, 902, 904.
- Dogmatism, passing of, 1026.
- Dominicans, 103.
- Doppler effect in solar spectrum, 634.
- in spectra of nebulae, 636.
- Drug chemistry, 267 *et seq.*
- Dynamic system, causation in, 933.
- vitalism, 803.
- Dynamics of Galileo, 161.
- Dynamo, Faraday's invention of, 373.
- Dysentery, 905.
- Ear, structure of the, 570.
- Earth, age of the, 680 *et seq.*
- estimated from phenomena of radio-activity, 681.
- estimated from recession of the moon, 682.
- methods of estimating, 680 *et seq.*
- Anaximander's views on the, 59.
- barysphere of the, 687 *et seq.*
- cooling of the, 675.
- diameter of the, 607.
- measured by Eratosthenes, 60.
- distance of stars from, 612.
- distribution of land and water on, 676.
- effect of rotation of, on trade winds, 698.
- Galileo forbidden to teach motion of, 159.
- geological eras in history of, 683, 684.
- Heraclides on the rotation of, 60.
- in alchemy, 266.
- infancy of, 673 *et seq.*
- internal heat of, 689.
- Kelvin on solidification of, 674.
- lithosphere of, 687.
- magnetic pole of, 338.
- Newton calculates attraction of, on the moon, 203.
- orbit of the, 608.
- origin of the, 661 *et seq.*
- rings of Saturn and origin of the, 662.
- rotational hypothesis of origin of, 661.
- specific gravity of, 688.
- surface structure of, 678.
- Thales' views on the, 59.
- thermosphere of the, 687-9.
- tidal hypothesis of origin of, 663 *et seq.*
- Earthquakes, 684 *et seq.*
- causes of, 685.

- Earthquakes, Michell's book on, 656.
 — waves in, 685-7.
 Earths, rare, production of, 578.
 Echinoderms, 787-8.
 Eclipses predicted by Chaldeans, 24.
 Ecology, 734.
 Economic biology and agriculture, 855.
 — entomology, 858.
 — problems of to-day, 1021.
 Economics, science in relation to, 1019.
 Ectoderm, 771.
 Education, Locke on, 230.
 Effect in relation to cause, 935, 940.
 — nature of an, 937.
 Egg, fertilization of, 769.
 Egypt, dynasties of, 11.
 — glass-making in, 12.
 — historical periods of, 11.
 — sanitation of, 873.
 — science in, as monopoly of priests, 35.
 — summary of events in, 21.
 Egyptian geometry, character of, 27.
 — hieroglyphics, 10.
 — mathematics, 26.
 — — and the Great Pyramid, 28.
 — — books for reference on, 33.
 — — learned by Greeks, 33.
 Eleatic School, 39.
 Electric battery, Punsen's, 335.
 — — Daniells', 334.
 — — Davy's, 356.
 — — early, 336.
 — — Grove's, 335.
 — — Volta's, 333.
 — current, induction of, 365-6.
 — — magnetic effect of, 364.
 — — measure of strength of, 341.
 — discharge in high vacua, 445.
 — "eye", the, 591.
 — waves, Hertz proves existence of, 356.
 — — interference of, 408.
 — — length of short, 431.
 Electrical methods of prospecting, 694.
 — power, distribution of, 580, 581.
 — research, books for reference on early, 343.
 — — Cavendish's book on, 331.
 — — Faraday's book on, 351.
 — — in early days, 328 *et seq.*
 Electricity and combining force, Faraday on, 354.
 — and magnetism, connexion between, 338.
 — cost of, 581.
 — developments in, 580.
 — du Fay's theory of, 329, 331.
 — evolution of, from magnetism, 367.
 — Franklin's theory of, 331.
 — interplay of magnetism and, 372.
 — positive and negative, 331.
 — resinous, 329.
 Electricity Supply Act, 1926, 580.
 — vitreous, 329.
 Electro-cardiograph, 890.
 Electro-chemistry, 336.
 Electrolytic dissociation, Arrhenius' theory of, 491.
 Electro-magnetic waves, Hertz measures velocity of, 418.
 — range of, in the spectrum, 432.
 Electro-magnetism, early discoveries in, 336.
 Electron, determination of charge on, 463.
 — energy steps of, 512.
 — momentum of, 524.
 — of hydrogen, 481.
 — orbit, conception of section of, 526.
 — position of, 523.
 Electrons, 447, 455.
 — Darwin (C. G.) on, 521.
 — determine chemical properties of elements, 458.
 — diffraction of, 519, 520.
 — discovery of, 458.
 — orbits of, 473.
 — planetary, 456, 458.
 — removal of, from atom, 501.
 — stationary, 480.
 Electrovalence and covalence, 500.
 Element, isotopes and definition of, 470.
 — nucleus of, 456.
 — valency of, 487.
 Elements, books for reference on modern transmutation of, 509.
 — Boyle on the, 286, 291.
 — Caven's graph of, 444.
 — chemical properties of, 458.
 — Dalton's symbols for chemical, 316.
 — disintegration of, 505.
 — discovery of, predicted by Mendeléeff, 442.
 — Döbereiner on triads of, 441.
 — four, in alchemy, 266.
 — in the sun, 426.
 — Lothar Mayer's graph of, 442.
 — Madame Curie discovers radio-active, 451.
 — Mendeléeff's periodic law of, 442.
 — — periodic table of, 443.
 — modern form of periodic law of, 456.
 — — transmutation of, 501 *et seq.*
 — Newlands' law of octaves of, 441.
 — of Aristotle, 265.
 — of Euclid, 51.
 — periodic table of, according to atomic numbers, 457.
 — radioactive, 450.
 — — disintegration of, 452.
 — recurrence of properties of, 442.
 — Rutherford and Chadwick's trans-formation of, 504.
 — spectra of, 425.
 — transformation of, in the sun, 507.

- Elements, undiscovered, 456.
 — wave-length frequencies of, 466.
 Elephant, evolutionary changes in, 784.
 Embryo and its development, 768 *et seq.*
 — human, compared with chick, 773.
 — mesenteron of, 771.
 — mesoderm of, 772.
 Embryological development, 765, 771.
 — laws of von Baer, 776.
 Embryology, 733.
 — books for reference on, 779.
 — evolutionary facts from, 782.
 — Harvey's work on, 260.
 — recapitulation theory of, 774 *et seq.*
 Endocrine therapy, 920.
 Endocrinology, 889, 919.
 — discoveries in, 883.
 Endoderm, 771.
 Endoscopic instruments, 890.
 Energy, conservation of, 354, 433.
 — continuity of, 511.
 — equation in quantum theory, 517.
 — forms of, 436.
 — kinetic, 434.
 — Niels Bohr on electronic, 513.
 — of radium, 451.
 — of the sun, determination of, 434.
 — — dispersal of, 435.
 — potential, 434.
 — spontaneous generation of, in radium, 451.
 — thermal, 437.
 Engine, internal combustion, 584.
 — steam, 584.
 Engineering, developments in, 579 *et seq.*
 — Roman, 85.
 — units in, 572.
 England and renaissance science, 177.
 — in the time of Charlemagne, 95.
 — invasion of, 93.
 — Smith's geological map of, 657.
 Entomology, economic, 858.
 Entropy, 433.
 — and mathematics, 993.
 — as a statistical law, 439.
 — Haldane on the law of, 1007.
 — law of, 434, 440.
 — of the universe, Clausius on, 437.
 Environment and heredity, 796.
 — influence of, on species, 740.
 Enzymes, 913-14.
 Eoanthropus, discovery of, 829.
 — models of, 834.
 Eocene period, 839.
 Eohippus, 784.
 Eoliths, 841.
 Eosinophil cells, 920.
 Epigenesis, hypothesis of, 780.
 Equinoxes, Babylonian knowledge of, 24.
 Equisetums, 793.
 Equus (modern horse), 784.
 Erg seconds, 516.
 Ergosterol, 915.
 Essences and perfumes, synthetic, 578.
 Ether in alchemy, 266.
 Eugenics, 734, 923.
 Euphrates, geography of, 4.
 Evolution, 734.
 — and heredity, 780 *et seq.*
 — books of reference on, 822.
 — Darwin's theory of, 743.
 — diagrammatic synopsis of human, 832-3.
 — difficulties of hypotheses of, 792.
 — Huxley's fight for theory of, 746.
 — implications of, in biology, 731.
 — of man, 752.
 — phylogenetic tree of human, 845-6.
 — process of, 780.
 — racial, 774.
 — two schools of thought on, 817.
 — urge of life to creative, 803.
 — views on, 744.
 Exhaustion, method of, 55, 213.
 Existence, struggle for, 797.
 Expansion, coefficient of, 382.
 Experience, scientific treatment of, 1001.
 Explosives in warfare, 1022.
 Extra-galactic system, 623 *et seq.*
 Eye, electric, 591.
 — response of, to spectrum scale, 432.
 Factory welfare work, 890.
 Facts, "collegation of", 964.
 — distinction from hypotheses, 963-4.
 Falling bodies, Galileo's investigation of, 169 *et seq.*
 Farm animals and crops, Ministry of Agriculture leaflets on, 856.
 — Institutes, 865.
 Farmers, indifference to modern knowledge, 856, 866.
 Fata morgana, 729.
 Fermentation, causation of, 886.
 Ferments, 913.
 Ferns, 793.
 Fertility, vitamin *E* essential to, 915.
 Fertilizers, artificial, 867.
 Filariasis, 905.
 Filter passers, 902.
 Finger-prints, variations in, 754.
 Fire in alchemy, 266.
 Flagellæ of bacteria, 897.
 Floral Games at Toulouse, 234.
 Florence, Galileo settles in, 158.
 — Platonic Academy at, 234.
 Fluorescence, Becquerel's experiments on, 449.
 — distinguished from phosphorescence, 449.
 — of uranium compounds, 449.
 — Poincaré's observations on, 449.
 — X-rays and, 449.

- Fluorine, disintegration of, 505.
 Fluxion, meaning of, 213.
 Fluxional calculus, 212 *et seq.*
 Focus, meaning of, 151.
 Food research, 593.
 Foot and mouth disease, 902.
 Foot-pounds, meaning of, 572.
 Force, gravitational, 552 *et seq.*
 — vital, 732.
 Forces, geometrical representation of, 354.
 — unity of, 353.
 Forest products research, 593.
 Formulæ, function of structural, 489.
 — isomerism and structural, 492.
 — molecular, and reactions of solids, 494.
 — of structure of molecules, 488.
 Fossil remains of man, 828.
 — reptiles, 753.
 — resin, 783.
 Fossils, early interpretations of, 656.
 Four-dimensional space, 556.
 Franciscans, 103.
 Fraunhofer lines, 427.
 Free will, intuition of, 954, 956.
 French Academy, 236 *et seq.*
 Frit-fly, damage by, 858-9.
 Frogs' eggs, 774.
 Fruit-fly, biological work on, 803, 807-8, 812.
 Fruit-trees, insects injurious to, 857.
 Fuel research, 593.
 Fungi injurious to crops and trees, 857.
- Galactic plane, 620.
 — — Kapteyn's work on, 621.
 — system, 617 *et seq.*
 — — constellations in, 623.
 — — globular clusters in, 623.
 Galilee, excavations in, 847.
 — skull, 832.
 Gall-bladder, radiography of, 909.
 Galvanometer, invention of, 339.
 Gametes, 765 *et seq.*
 Gas poisoning, 579.
 Gases, combination of, by volume, 324.
 — compression of, 323.
 — diffusion of, into the atmosphere, 706.
 — discovery of, by van Helmont, 269.
 — distinguished from liquids, 324.
 — distribution of, in the atmosphere, 716.
 — elasticity of, 323.
 — Hales's experiments on, 275.
 — inert, 458.
 — — and low temperatures, 576 *et seq.*
 — kinetic theory of, 972.
 — liquefaction of, 576.
 — poisonous, 1021, 1022.
 Gastric juice, 913.
 Gastro-intestinal tract, radiography of, 909.
- Gastrula, 771.
 Geissler tubes, electric discharges in, 446.
 General Medical Council, 238.
 Genes, 809 *et seq.*
 — development of new, 820.
 — origin of the term, 818.
 Genetics, 734, 799.
 — on a mathematical basis, 802.
 Genius, nature of, 971.
 — of the Greeks, 34 *et seq.*
 Genotypes, natural selection of, 802.
 Geodesic, 541.
 Geographical discoveries, 113.
 Geography, interrelation with history, 1.
 — of the ancient world, 1.
 — — books for reference on, 7.
 Geological map of England, 657.
 — Society, Lyell's influence on, 657.
 — survey, 593.
 Geology, 656 *et seq.*
 — books for reference on, 695.
 — foundation of stratigraphical, 657.
 — modern developments of, 657-8.
 Geometrical model of theory of relativity, 567.
 Geometry, algebraic, 185, 540.
 — Cartesian, 185.
 — Descartes', 183, 185, 188, 540.
 — Egyptian, 27.
 — Euclid's, 976.
 — — applicability of, 542.
 — Lobatchevsky's non-Euclidean, 543.
 — Riemann's non-Euclidean, 543.
 — spherical, 544.
 — varieties of, 539.
 — Veblen's, 976.
 Geophysical experimental survey, 694.
 — Laboratory at Washington, 659.
 Geophysics, 656 *et seq.*
 — applied, 689 *et seq.*
 — books for reference on, 695.
 — connotation of, 660.
 — scope of, 659.
 Germs, nature of, 895.
 Germ-plasm, 798.
 German idealism, 228.
 — people, difference from British, 1025.
 — philosophers, obscurity of, 230.
 Gibbon, likeness to man, 826.
 Glaciation, problem of ancient, 841.
 Glands, ductless, 919.
 Glass-making in Greece, 12.
 Globular clusters in galactic system, 623.
 Glyco-ethylene, production of, 575.
 Goitre, 920.
 Golden section and Pythagoras, 46.
 Gorilla, likeness to man, 825 *et seq.*
 Goths, Rome sacked by, 90.
 Government grants for medical research, 804.
 Graptolites, 783.
 Graves' disease, 920.

- Gravitation and thermal convection, 714.
 — Einstein's geometric law of, 554.
 — law of universal, 200, 210.
 Gravitational force of the stars, 673.
 Gravity, Newton discovers law of, 202, 205.
 Great Pyramid and Egyptian mathematics, 28.
 — building of, 11.
 — fantastic arithmetical relations of, 30.
 — measurements of, 29, 30.
 — orientation of, 31.
 — structure of, 28.
 Greece, civil wars in, 17.
 — culture in, 16, 17.
 — early civilization in, 15.
 — Golden Age of, 41.
 — invaded by barbarians, 14.
 — period of oligarchy in, 1013.
 Greek architecture, 36.
 — astronomy, 58 *et seq.*
 — — books of reference on, 67.
 — — progress of, 59.
 — biology, 68 *et seq.*
 — — works of reference for, 70.
 — coastal islands, 7.
 — colonies in Asia Minor, 6.
 — conception of epicyclic movement of planets, 64.
 — — of the solar system, 62 *et seq.*
 — learning, Christian hostility to, 87.
 — literature, 36.
 — mainland, cities on the, 7.
 — mathematics, 46 *et seq.*
 — — books of reference on, 57.
 — medical schools, 70.
 — medicine, 71 *et seq.*
 — — books of reference on, 74.
 — — Hippocrates the father of, 71.
 — philosophy, Justin Martyr on, 87.
 — physical science, 75 *et seq.*
 — — books of reference on, 80.
 — schools, 34, 37.
 — — books of reference on, 45.
 — — chronological table of, 45.
 — science, character of, 44.
 — statuary, 36.
 Greeks and chemistry, 77.
 — and the movement of the earth, 66.
 — as mathematicians, 35.
 — contrasted with Romans, 82.
 — genius of the, 34 *et seq.*
 — mathematics learned by, from Egyptians, 33.
 — origin of the, 16.
 — reasons for intellectual superiority of, 34.
 — scientific methods of, 35.
 — solar system of the, 58.
 Greenwich Observatory, 617.
 Grenada, academy at, 233.
 Gresham College, 189, 235.
 Grid, the, 580.
 Halley Stewart Laboratory, 729.
 Halos, 730.
 Hartz mountains, Werner's work on strata in, 656.
 Hearing, hypothesis of, 571.
 Heart, chambers of the, 244.
 — Galen on valves of, 254.
 Heat as complex molecular motion, 438.
 — as motion, Rumford on, 433.
 — Clausius on transference of, 437.
 — Davy's experiment on development of, 433.
 — transference of, 437.
 — transmission of, 708.
 Heidelberg man, discovery of, 830.
 Heliotherapy, 889.
 Helium, 458.
 — as disintegration product of radium, 682.
 — electrons of, 481.
 — in the stratosphere, 717.
 — ions and alpha-rays, 462.
 — liquefaction plant, 577.
 — Ramsay discovers, 576.
 — solidification of, 577.
 Hemisphere, area of surface of, 32.
 Herculaneum, excavations at, 849.
 Heredity, 734.
 — books for reference on, 822.
 — Darwin's theory of, 796, 797.
 — environment and, 796.
 — Lamarck's theory of, 796.
 — Mendel's theory of, 746, 799, 800, 803.
 — theory of, 793.
 — Weismann's theory of, 798.
 Hermetic philosophers, Boyle on, 284.
 Hindus, 99 *et seq.*
 — books for reference on, 101.
 — contributions to mathematical science, 99.
 — hygiene of, 874.
 Hippocratic collection, 72.
 — treatment of disease, 73.
 Histology, Malpighi the founder of, 261.
 Historical methods, 19.
 — periods, 21.
 History, interrelation with geography, 1.
 — stages of, 10, 11.
 Hormones, 578, 917, 920.
 Horse, evolutionary changes in, 784.
 Horse-power, meaning of, 572.
 Hospitals, mediæval, 876.
 Human action, 942.
 — embryo compared with chick, 773.
 — Genetics Committee, 801.
 Hydnocarpus oil in treatment of leprosy, 908.
 Hydrogen discovered by Cavendish, 303.

- Hydrogen, electron of, 481.
 — heavy, Lawrence's bombardment with, 505.
 — — properties of, 507, 508.
 — — Soddy on, 508.
 — — transformations effected by, 505.
 — in the stratosphere, 717.
 — lines in spectrum, 385.
 — molecule, size of, 903.
 — solidification of, 576.
 Hydrogenation of coal, 575.
 Hydrophobia, prevention and cure of, 887.
 Hygiene, books for reference on, 924.
 — in ancient times, 873.
 — in 18th and 19th centuries, 878.
 — Roman achievements in, 84.
 Hygrometers, 700.
 Hypodermic needles, medical use of, 890.
 Hypotheses, authoritative opinions on, 965.
 — conditions of, 964.
 — imagination a factor in, 968.
 — nature of, 963.
 — of hearing, 571.
 — scientific, 965.
 Ice crystals, Bragg's models of structure of, 498.
 Ictidisaurians, 753.
 Idealism and present-day science, 990.
 — as philosophic term, 226.
 — German, 228.
 — in physics, 981 *et seq.*
 Ids, 798.
 Ilium, 7.
 Image, apparent and real, in optics, 152.
 Imagination a factor in hypothesis, 968.
 Imperial College of Science and Technology, 600.
 Indeterminacy, authoritative opinions on, 951.
 — Eddington on, 948.
 — in relation to uncertainty, 948.
 — two meanings of, 952.
 Index notation in arithmetic, 608.
 Indivisibles, principle of, 187.
 Induction of electric currents, 365.
 Infant mortality in mediæval times, 877.
 Inference, scientific, 974.
 Infinite, meaning of, 538.
 Influenza, 902.
 Infra-red photography, 587-8.
 — region of the spectrum, 427.
 Inheritance, significance of, in biology, 731.
 Innate ideas, Locke on, 224.
 Inoculation in 18th century, 891.
 — Jenner's experiments on, 892.
 — theory of, 901.
 Inquisition, imprisonment of Galileo by, 159.
 Inquisition in Spain, 113.
 Insecticides, use of, 859.
 Insects, control of injurious, 859.
 — injurious to crops, 857.
 — species of injurious, 858.
 Insolation, 708.
 — three-dimensional graph of, 700, 711.
 Institute of Animal Genetics, 870.
 Insulin, 578, 919, 920.
 Integral calculus, birth of the, 213.
 Integration, 214.
 Intellectual bias, 975.
 — darkness during Church supremacy, 92.
 Interference of waves, 404 *et seq.*, 410.
 Interferometer at Mount Wilson Observatory, 616.
 — development of, by Michelson, 629.
 — Miller's experiments on, 562.
 Internal combustion engines, 584.
 Intolerance, cause of, 973.
 Inventions of 20th century, 591.
 Inventiveness and resource, 963.
 Invertase, hydrolytic action of, 913.
 "Invisible" College, 235.
 Iodine, use of, in radiography, 910.
 Ionian School, 37.
 Ionization by ultra-violet light, 725.
 Ionosphere, the, 724 *et seq.*
 Ions, hypothesis of, 491.
 — in solid salts, 500.
 Iron, Age of, 845.
 — in ancient Egypt, 12.
 Isobars, 717.
 Isohydrogen, *see* Hydrogen, heavy.
 Isomerism and structural formulæ, 492.
 Isostasy, connotation of, 678.
 Isotopes, 455.
 — and definition of element, 470.
 — of neon, 470.
 Jericho, excavations at, 847.
 Jews, sanitary rules for, 874.
 Joule, definition of the, 573.
 Judæa, excavations in, 847.
 Kalar-azar, 905, 908.
 Karroo rocks, reptiles in the, 753.
 Kennelly-Heaviside layer, 727.
 Kidneys, discovery of ducts of, 883.
 Kite stations, 703.
 Krypton Period, 482.
 Lacteals, discovery of, 883.
 Lamarckism, Darwin and, 744.
 — fundamental idea of, 740.
 Lands and seas, antipodal arrangement of, 676.
 Langerhan's islets, 919.
 Laryngoscope, 890.
 Lattice, space, of crystals, 496.
 Laudanum, first use of, 267.

- Lead as decomposition product of radium, 682.
- Learning, Christian hostility to Greek, 87.
- in 13th century, books for reference on, 109.
- revival of, 111.
- Legal methods compared with scientific, 1017.
- Lenard rays, 447.
- Leprosy, 905, 908.
- Leucocytes, 900.
- Leyden jar, origin of, 329.
- Lick Observatory, 613.
- Life, biochemistry and, 916.
- biology of communal, 731.
- Light, aberration of, 547.
- action of grating on, 414.
- Alhazen on velocity of, 417.
- and electricity, Maxwell's inferences on, 392.
- Aristotle on, 417.
- as factor in photosynthesis, 757.
- atomic linking and the rotation of, 493.
- Bradley measures velocity of, 418.
- contraction factor for course of, 548.
- corpuscular hypothesis of, 412, 518-19.
- — evidence against, 413.
- curved path of, in gravitational field, 554.
- Descartes on transmission of, 417.
- dispersion of, 410.
- diffraction of, 411, 519.
- emission theory of, 189, 419.
- Empedocles on theory of, 75.
- extension of visible, in the spectrum, 431.
- Foucault measures velocity of, 418-19.
- Galileo on velocity of, 417.
- Grimaldi's experiments on, 419.
- Hook's wave theory of, 189, 198.
- Huygens on emission theory of, 419.
- — wave theory of, 199.
- hypothesis of loss of energy of, 639.
- Michelson measures velocity of, 418.
- Newton and corpuscular hypothesis of, 412.
- — and emission theory of, 198, 418.
- — research on spectrum of, 197.
- photo-electric, effect of, 521-2.
- polarization of, 414 *et seq.*
- quantum formula, Einstein's, 522.
- rays, bending of, 644.
- reflection of, 409.
- refraction of, 409.
- Römer measures velocity of, 417.
- spreading phenomenon of, 413.
- transmission of, 416 *et seq.*
- Light, Tyndall's experiments on refraction of, 422.
- wave and emission theories of, 189, 198, 408 *et seq.*
- waves of, 404.
- — interference of, 410.
- — medium, 404.
- years, significance of, 122, 610.
- Young and the wave theory of, 419.
- Zwicky's theory of loss of energy of, 639.
- Lightning conductors, 729.
- Limits, Newton's method of, 57.
- Linnean Society, 236.
- Lipiodol, 910.
- Liquids, differentiation from solids, 675.
- distinguished from gases, 324.
- molecules in, 487.
- Literature, peak periods in, 1012, 1013.
- Lithium, disintegration of, 505.
- electrons of, 481.
- transformation into alpha-particles, 505.
- transmutation of, 506.
- Lithosphere of the earth, 687.
- Little Joss wheat, 870.
- Liverpool School of Tropical Medicine, 905.
- London School of Tropical Medicine, 905.
- London skull, 832.
- Low temperature research at Cambridge, 600.
- Lyceum at Athens, 42.
- Lycopods, 793.
- Lymph for vaccination, 892.
- Lymphatic system discovery of, 883.
- Magdalenian culture, 839, 842-3.
- Magnet, magnetic field of bar, 337.
- Magnetic field, effect of rays from radioactive substances on, 452.
- — research in, 600.
- medium, Fizeau on elasticity of, 356.
- method of prospecting, 693.
- needle, 337.
- pole of the earth, 338.
- Magnetism and electricity, connexion between, 338.
- Gilbert's work on, 117.
- interplay of electricity and, 372.
- Magneto-electric induction, 368 *et seq.*
- Malaria, 905.
- parasites in mosquitoes, 862.
- research on, 894, 905.
- Malarial diseases, parasites of, 906-7.
- Mammals, evolution of, 789, 790.
- primate order of, 824.
- transition from reptiles, 751.
- Man, antiquity of, 832.
- Cartesian comparison of skulls of ape and, 851.

- Man, distinction from apes, 824, 826.
 — evolution of, 752.
 — fossil remains of, 828.
 — genealogical tree of, 751.
 — prehistoric, models of, 834.
 — primitive, progress of, 8.
 — the product of Pleistocene period, 839, 840, 845.
- Maps, weather, 717 *et seq.*
- Materialism, passing of, 1026.
- Mathematical calculation, discoveries made by, 392.
 — discoveries of Hippias, 47.
 — of Pythagoras, 46.
 — equations, interpretation of, 976, 978.
 — interpretation, limitations of, 977 *et seq.*
 — problems inherited from antiquity, 38.
 — science, contributions of Arabs and Hindus to, 99 *et seq.*
 — symbols and the physical world, 978.
 — — Dirac on, 534.
- Mathematician, function of the, 976-7.
 — insensitiveness of the, 971.
- Mathematics, æsthetic aspect of, 972.
 — after Newton, 219 *et seq.*
 — and entropy, 993.
 — and Plato's Academy, 42.
 — and probability, 973.
 — and relativity, 565 *et seq.*
 — as aid to discovery in physics, 393.
 — cultural influence of, 971.
 — Egyptian, character of, 27, 31.
 — learned by Greeks from Egyptians, 33.
 — limitations of, 976.
 — mysticism in modern, 979.
 — "pure", and symbols, 393.
- Matrix mechanics, 530.
- Matter, annihilation of, 992.
 — conservation of, 269.
 — existence in two states, 918.
 — unity of, in alchemy, 265.
- Maturation, 765.
- Measurement, units of, in astronomy, 610.
- Mechanics and the second law of motion, 201.
 — Archytes' treatise on, 75.
 — doubts on classical, 510 *et seq.*
 — foundation of, 163 *et seq.*
 — books for reference on, 176.
 — peak periods in, 1012-13.
 — quantum, new theory of, 530.
- Mediæval period of civilization, 1012.
 — thought, 96.
- Mediævalism and science, 97.
- Medical discoveries since 17th century, 883.
 — practice during the Renaissance, 240.
 — research, 891.
- Medical research, Government grants for, 894.
 — Research Council, 893.
 — — Committees of, 894.
 — science, Pliny on, 84.
 — training, British, 921.
- Medicine, beginning of rational, 239 *et seq.*
 — books for reference on, 924.
 — — on history of, 263.
 — Greek, 71 *et seq.*
 — preventive, 889.
 — psycho-therapy as a branch of, 932.
 — Roman, 83.
 — tropical, 904.
- Mediterranean, sketch map of, 3, 5.
 — countries, summary of events in, 21.
- Meiosis, 766.
- Memphis, founding of, 11.
- Menes, 11.
- Meningococcus, 897.
- Mercury, eccentricity of orbit of, 680.
 — motion of perihelion of, 974.
- Merychippus, 784.
- Mesoderm of embryo, 772.
- Mesohippus, 784.
- Mesolithic age, 838, 844, 847.
- Mesopotamia, 6.
- Metabolism of the organism, 912.
- Metals, seven, in alchemy, 266.
- Metazoon, definition of, 786.
- Meteorites, material of, 688.
- Meteorograph, 703.
- Meteorological department of the Air Ministry, 699.
 — matters of special interest, 729.
 — Office, establishment of, 699.
 — — typical weather map of, 718.
- Meteorologists, equipment of modern, 700 *et seq.*
- Meteorology, 697 *et seq.*
 — anticyclonic system in, 720 *et seq.*
 — Aristotle on, 698.
 — as a science, 697.
 — books for reference on, 730.
 — cyclonic system in, 720 *et seq.*
 — millibar as unit in, 707.
 — of the Polar regions, 722 *et seq.*
 — temperature scale in, 710.
- Metozoa, 786, 788.
- Mezosoic animals, 784.
- Micro-organisms, nature of, 895.
 — and disease, 885 *et seq.*
- Micro-waves, wireless, 729.
- Microbes, nature of, 895.
- Micrococci, 897.
- Micros, 895.
- Microscope, development of, 260.
 — principle of, 153.
- Middle Ages, intellectual activity of, 94.
- Milk, cows' yield of, 871.
- Milky Way, 620.
 — — distribution of stars in, 621.

- Milky Way, movement of solar system in, 683.
 Millibar as unit in meteorology, 707.
 Miner's lamp, invention of, 321.
 Ministry of Agriculture and Fisheries, Bulletins of, 856.
 — duties of, 855.
 — formation of, 855.
 — Journal of, 857.
 Ministry of Health, establishment of, 893.
 Minoan culture, 14.
 Miocene period, 839.
 Mirage, the, 729.
 Mitosis, 762 *et seq.*
 Mohammedan invasion of Alexandria, 44.
 Molecular dipole moment, 500.
 Molecule, carbon atoms in, 489.
 — Gowland Hopkins on the, 500.
 — polar, 500.
 — structure of the, 487.
 — modern, 486 *et seq.*
 Molecules and atoms, 327.
 — Berzelius' dualistic system of, 491.
 — Couper on bonds in, 488.
 — Dumas' unitary system of, 491.
 — graphic formulæ of structure of, 488.
 — in a gas, 486.
 — in a liquid, 487.
 — nature of, 311.
 Molluscs, 787-8.
 Moment, molecular dipole, 500.
 Mona Lisa of da Vinci, 116.
 Mond Laboratory, 599.
 Monsoons and trade winds, 698.
 Moon, Anaxagoras on the, 60.
 — distance of, from the earth, 607.
 — — measurement of, 611.
 — Newton calculates course of, 204.
 — perturbations of, 211.
 — tidal theory of origin of, 682.
 Moors the, 100.
 — academies founded by, 233.
 Morphology, 733.
 Moscow papyrus, 31.
 — calculation of area of circle in the, 33.
 — discovery of, 27.
 — problem 10 of, 32.
 Mosquitoes as carriers of malaria, 862.
 — control of, 863.
 — disease caused by, 905.
 — distinction from other insects, 860.
 — species of, 861.
 Moths, change of colour in, 818.
 Motion, Boltzmann on molecular, 438.
 — formula for uniform, 164.
 — — for uniformly accelerating, 165.
 — fundamental laws of, 200 *et seq.*
 — Galileo and laws of, 200.
 — — formula of, for, 164 *et seq.*
 — — propositions of, on, 167 *et seq.*
 — heat as complex molecular, 438.
 Motion in a circle, formula for, 204-5.
 — Kepler's laws of, 202.
 — Maxwell on molecular, 438.
 — Newton's statement of laws of, 201:
 — parallax, 610 *et seq.*
 — perpetual, 486.
 — quantities involved in, 163.
 — relative, 538, 544.
 — — ratio of, 545-6.
 — relativity of accelerated, 552.
 — Rumford on heat as, 433.
 — Wollaston's experiment on electrical power and, 361.
 Motor, Faraday's infant, 362.
 Mount Wilson Observatory, 613 *et seq.*
 — telescope at, 195.
 Mousterian culture, 830, 839, 842, 847.
 Museum, Alexandrian, 232.
 — founded by Ptolemy, 233.
 Mustard gas, 1022.
 Mutation, rate of, 820.
 — hypothesis of, 800, 819.
 Myxædema, 920.
 Nagana, cause of, 907.
 National Physical Laboratory, 594 *et seq.*
 — compressed air-tunnel in, 596.
 — departments of, 595.
 Natural history, 733.
 — processes, uni-directional, 436.
 — selection, Darwin's theory of, 744, 797.
 — — Russel Wallace's theory of, 745.
 Naturalism, 226.
 — Locke's sympathies with, 228.
 Nautilus, section of, 801, 802.
 Neanderthal child, 830, 832.
 — man, description of, 842.
 — — discovery of, 829, 833.
 — — model of, 834.
 Nebula, estimate of numbers of stars in, 627.
 — in Andromeda, 625, 628.
 — in constellation Gemini, 637.
 — in Triangulum, 625.
 — theory of development of solar system from spiral, 668.
 Nebulæ, 623 *et seq.*
 — classes of, 624 *et seq.*
 — Doppler effect in spectra of, 636.
 — Eddington on recession of, 640.
 — — estimates number of, 628.
 — extra-galactic, 625.
 — Jeans on the great, 626.
 — Milne on expansion of the, 648.
 — new general catalogue of, 636.
 — radial velocities of, 635.
 — recession of the, 633 *et seq.*, 640.
 — relative distance of, 122.
 — spectrograms of, 635.
 — velocity of, 637-8.
 Nebular hypothesis of origin of earth, 663.

- Nebular observations, instruments for, 614.
- Neo-Darwinians, 747, 798, 820.
- Neo-Lamarckians, 747, 796.
- Neolithic Age, 838, 844.
- beginnings of, 8.
- — evidence of, 9.
- culture in Crete, 14.
- — in Nile Valley, 9.
- man, arts of the, 9.
- Neon, electrons of, 481.
- isotopes of, 470.
- parabola, 468.
- transformation of carbon and, 505.
- Nephoscope, 729.
- Neptune discovered, 970.
- distance from the earth, 608.
- Nervous system, research on disorders of, 894.
- Neural canal, 772.
- Neutrons, radiation of, 504.
- transformations effected by, 505.
- New learning, attitude of Luther towards, 112.
- development of the, 113.
- Nile, geography of the, 2.
- Valley, neolithic culture in the, 9.
- Nîmes, Roman aqueduct near, 86.
- Nitrogen nucleus, bombardment of, 503.
- transformed into oxygen nucleus, 503, 505.
- Nitrous oxide, Davy discovers, 321.
- Nobel Prize, British holders of, 1010.
- Noctovisor, invention of, 588.
- Noise abatement, work of Dr. Kaye on, 570.
- Nuclei, disruption of atomic, 504.
- Rutherford's bombardment of nitrogen, 503.
- Nucleus of atom, components of, 502.
- of cell, 762.
- of element, 456.
- Numerical relationships, 379.
- Oceans, estimation of age of, 682.
- Ohm, definition of the, 573.
- Oligarchy succeeds period of autocracy, 1013.
- Oligocene period, 839.
- Ontogeny, relation to phylogeny, 776.
- stages of animal's, 769.
- Ophthalmoscope, 890.
- Optical glass, Faraday's researches on, 352.
- Opticks* of Newton, 199.
- Optics, apparent and real image in, 152.
- Orang-utan, likeness to man, 825.
- Orbits of electrons, 473.
- Order of Merit, 1011.
- Ordnance Survey Department, 855.
- Organism, metabolism of the, 912.
- Organisms, characteristics of living, 732.
- Organisms, variability in living, 754.
- Ottawa, Observatory at, 617.
- Ovum, fertilization of, 766-7.
- Oxford, Academy at, 233.
- biological work at, 603.
- Locke at, 222.
- "new philosophy" at, 222.
- Sheldonian Theatre at, 262.
- Oxygen, first discovery of, 302.
- Lavoisier names, 309.
- nucleus, transformation of nitrogen nucleus into, 503.
- Priestley's discovery of, 299.
- transformation of nitrogen and, 505.
- Ozone in the upper atmosphere, 725-6.
- Padua, Galileo becomes professor at, 155.
- Painting, peak periods in, 1012-13.
- Palæolithic Age, 838.
- — cultures of, 839 *et seq.*
- — discoveries of the, 9.
- man, 8.
- Palæontology, 733.
- evolutionary facts from, 782.
- Palestine, archæological work in, 847.
- man, discovery of, 847.
- Pancreas, discovery of ducts of, 883.
- Pancreatic juice, 913.
- Pangensis, 798.
- Papacy, supremacy of, 93.
- Papyrus, Moscow, *see* Moscow papyrus.
- of Ahmes, 27.
- Parabola, quadrature of the, 55.
- Paracelsans, Boyle's evidence against, 290.
- doctrine of the, 285.
- Parallactic motion, 125, 610 *et seq.*
- Parallax of stars, 613.
- Parallaxes, spectroscopic, 630.
- Parallel lines, Euclid's postulate of, 542.
- Paraselenæ, 730.
- Parathyroid glands, 919.
- Parhelia, 730.
- Parsec, significance of, 610 *et seq.*
- Particles, alpha, *see* Alpha-particles.
- attempted fusion of waves and, 378.
- Bragg on, 534.
- estimate of sizes of, 903.
- merging of waves and, 525.
- Pasadena, solar laboratory at, 614.
- Pasteur Institute in Paris, 887.
- Pathogenic germs, isolation of, 888.
- Pathology, definition of, 873.
- Peking man, 832.
- Pendulum, Huygens' work on, 175.
- Pentane, Bragg's model of structure of, 498.
- Pepsin, 913.
- Period-luminosity law, 631.
- Periodic law of elements, atomic number and the, 445.
- — modern form of, 456.

- Periodic law, periods in the, 480.
 — table of elements, according to atomic numbers, 457.
- Peripatetic School at Athens, 42.
- Perpetual motion, 486.
- Persepolis, discoveries at, 846.
- Persia, 13.
 — Ancient, 4.
 — archaeological discoveries in, 846.
- Pests, damage to crops by, 858.
- Petrol, tar-oil substitutes for, 575.
- Petrology, physico-chemical investigations in, 659.
- Phagocytes, 900.
- Philosopher's Stone, 115.
- Philosophers, lack of lucidity in British, 230.
 — present-day, 925.
- Philosophic thought, opposed schools of, 226.
- Philosophy, fundamental task of, 928.
 — in relation to science, 925.
 — of Cicero, 233.
 — of Hume, 231.
 — of Locke, 224 *et seq.*, 230.
 — reasoning the basis of, 929.
 — scholastic, 103.
 — unprogressive character of, 926.
- Phlogiston theory, 270, 272.
 — Black and the, 275.
 — Cavendish and the, 275, 306.
 — Lavoisier and the, 275, 309.
 — Priestley and the, 275, 301.
- Phlogistonists, the, 270 *et seq.*
- Phœnicia, arts in, 15.
 — geography of, 4.
 — history of early, 15.
- Phœnicians, colonies of the, 7.
- Phosphorescence distinguished from fluorescence, 449.
- Photo-electric cell, 590.
- Photo-electrons, 521.
- Photography, advances in, 587.
 — by invisible rays, 587.
 — infra-red, 587.
- Photometric method of measuring distances of stars, 629.
- Photomicrography, 587.
- Photons, 455, 518.
- Photosphere of the sun, 426.
- Photosynthesis, action of ultra-violet rays in, 759.
 — in plants, 756.
- Phototherapy, Finsen's invention of, 592.
- Phyla, characteristics of principal, 750.
- Phylogenetic tree of man's evolution, 845-6.
- Phylogeny, 774.
 — of animals, 783.
 — relation to ontogeny, 776.
- Phylum, definition of, 781.
 — in zoology, 750.
- Physical formulæ, rational and empirical, 386 *et seq.*
 — science, books for reference of, 603.
 — — contrasts between old and new, 990.
 — — Greek, 75 *et seq.*
 — — practical developments in, 569 *et seq.*
 — work, development of, in other countries, 604.
 — world, mathematical symbols and the, 978.
- Physicians, practising in 17th century, 261.
- Physicists and measurements, 380 *et seq.*
 — as mathematicians, 379.
- Physics, achievements of Archimedes in, 76.
 — books for reference, riddles of modern, 568.
 — — on transition to newer, 440.
 — branches of, 376 *et seq.*
 — British leaders of New School in, 981.
 — character of Greek, 75.
 — developments in, 579 *et seq.*
 — discovery in, made by use of mathematics, 392
 — idealism in, 981 *et seq.*
 — in the 16th century, 154.
 — some problems of modern, 441 *et seq.*
 — some riddles of modern, 510 *et seq.*
 — symbolism in, 533.
 — transition from older to newer, 376 *et seq.*
 — units in, 572.
- Physiology, 733.
- Pile, Volta's, 333.
- Piltown man, 829, 832-3, 845-6.
- Pisa philosophers, opposition to Galileo, 155, 157.
- Pitchblende, radium in, 451.
- Pithecanthropus Erectus*, discovery of, 828, 833.
 — model of, 834.
- Pituitary glands, 919, 920.
- Pituitrin, 919.
- Placentals, 784.
- Plague, 905, 908.
 — bacillus discovered, 888.
 — fleas, 755.
 — Great, 194, 875.
- Planes, curvature of, 541.
- Planetary orbit, shape of, discovered by Kepler, 145.
- system of Tycho Brahé, 136.
- Planets, apparent epicyclic movement of, 65.
 — Greek view of epicyclic movement of, 64.
 — orbits of the, 207.
 — tidal theory of birth of, 667.

- Plant breeding station, 869, 871.
 — physiology, 755 *et seq.*
 Plants, absence of transitional forms of, 793.
 — photosynthesis in, 756.
 — Ray's classification of, 735.
 — transpiration of, 756.
 Platonic Academy, 234.
 Pleistocene period, climatic conditions of, 840.
 — man the product of, 839, 845.
 Pliocene period, 839.
 Pliohippus, 784.
 Pneumococcus, 897.
 Poetry, distinction from science, 1018.
 Poisonous compounds, research on, 579.
 — gases, 1021, 1022.
 Polar exploration, international, 722 *et seq.*
 — regions, meteorology of, 722 *et seq.*
 Polarization of light, 414 *et seq.*
 — wave explanation of, 416.
 Polonium, 451.
 Poly-morpho-nuclears, 900.
 Positron, Blackett's discovery of, 507.
 — of heavy hydrogen, 508.
 Potassium, discovery of, 322.
 — isolation of, 491.
 Poultry, Ministry of Agriculture leaflets on, 856.
 Primates, definition of, 824.
Principia of Newton, 206 *et seq.*
 Printing, invention of, 114.
 Prisons, condition of mediæval, 876.
 Probabilism, 233.
 Probability, calculus of, in connexion with atomic structures, 439.
 — concept of, 946.
 — degree of, 973.
 — laws of, 439.
 — mathematical theory of, 973.
 — Pascal's theory of, 188.
 — "waves", 529.
 Professional status, 238.
 Propagation of chance, 533.
 Prophylactic, definition of, 873.
 Proportions, law of constant, 312.
 — law of multiple, 319, 320.
 Prospecting, 689, *et seq.*
 — electrical methods of, 694.
 — gravitational method of, 690.
 — magnetic method of, 693.
 — seismic method of, 693.
 Proteins, action of enzymes on, 913.
 — structure of, 912.
 Protobes, 903.
 Protons, 455.
 — transformation effected by, 506.
 Protoplasm, 761.
 Protozoa, 786, 788.
 Protozoan, definition of, 786.
 Proxima Centauri, distance from the earth, 610, 613.
 Psychological research, 932.
 Psycho-analysis, 932.
 Psychology, science of, 930.
 — terminology of, 931.
 Psychotherapy, 889, 932.
 Ptolemaic geocentric hypothesis, 67.
 — system, 62, 127 *et seq.*
 Public Health Act of 1875, 878.
 Puerperal fever, research on, 894.
 Pus, 899, 900.
 Putney Bridge, construction of, 586.
 Putrefaction, nature of, 885.
 Pyramid, volume of a, 31.
 — volume of a truncated, 32.
 — *See also* Great Pyramid.
 Pyrenees, Palæolithic man in, 8.
 Pyrometer, electric, 660.
 Pythagorean School, 38.
 Quadrant, Tycho Brahe's, 137.
 Quadratrix of Hippias, 39, 47.
 Quadrature of the parabola, 55.
 Quantities, Newton's view of, 214.
 Quantum of action, 515.
 — mechanics, Dirac on, 531.
 — new theory of, 530.
 — theory, 510 *et seq.*
 — and radiation, 514.
 — application of, to structure of atom, 472 *et seq.*
 — books for reference on, 568.
 Quicklime, Black's experiments on, 293 *et seq.*
 Race, blending and improvement of, 1026.
 — history of animals, 783.
 — of a species, 782.
 Radiant matter, 446.
 Radiation, 445 *et seq.*
 — and the quantum theory, 514.
 — black-body, 513.
 — cavity, 513.
 — constant, Planck's, 473.
 — transmission of heat by, 708.
 Radiators, full, 514.
 Radio research, 593.
 Radio-active atom, transformation of, 501.
 — elements, 450.
 — disintegration of, 452.
 — — Madame Curie discovers, 451.
 — substances, effect of rays from, on magnetic field, 452.
 — — rays emitted by, 452.
 Radioactivity, 449 *et seq.*
 — and transmutation, 115.
 — estimate of age of earth from phenomena of, 681.
 — Madame Curie's researches on, 450.
 Radio-diagnostics, 909.
 Radio-geophysics, 724 *et seq.*
 Radiology, advances in, 908.

- Radium atom, Kramers on structure of, 498.
 — discovery of, 451.
 — disintegration products of, 682.
 — — rate of, 681.
 — spontaneous evolution of energy, by 451.
 — therapy, 910.
 Radon, disintegration product of radium, 681.
 Railways, electrification of, 580, 581.
 Rain gauge, 698, 701.
 Rainbow, colours of, 729.
 — geometrical theory of, 729.
 — Newton's theory of, 197.
 Range-finding at sea, 135.
 Rat-fleas, 755.
 Rays and radioactivity, 445 *et seq.*
 — anode, 447.
 — canal, 447.
 — cathode, 446.
 — cosmic, cloud method study of, 507.
 — — Millikan on, 652.
 — emitted by radioactive substances, 452.
 — — by uranium, 450.
 — Lenard, 447.
 — positive, 447, 467.
 — — parabolas of, 468.
 — — Thomson's investigation of, 467.
 — X-, *see* X-rays.
 α -Rays, 452.
 — and helium ions, 462.
 — bombardment with, 461.
 — track of, photographed, 462.
 β -Rays, 452.
 γ -Rays, 453.
 — in radiology, 911.
 — length of, 431.
 Reason in relation to cause, 936.
 Reasoning the basis of philosophy, 929.
 Recapitulation theory of embryology, 773 *et seq.*
 Red Sea, 2.
 Reference, frame of, 540.
 Reflection of light, 409.
 — of water-waves, 411.
 Reformation, the Renaissance and, 110 *et seq.*
 — results of the, 113.
 Refraction of light, 409.
 Relative motion in the universe, 124.
 Relativity, 536 *et seq.*
 — and Newton's discoveries, 536.
 — as algebraic theory, 567.
 — books of reference on, 568.
 — Clerk Maxwell on, 536.
 — Einstein's theory of, 548.
 — general theory of, 552 *et seq.*
 — geometrical model of theory of, 567.
 — Haldane's obscurity on, 230.
 — hypothesis of Einstein's theory of, 549.
 Relativity in connexion with wave mechanics, 650.
 — intervals in, 555.
 — Larmor on, 537.
 — Levi Civita on, 565.
 — mathematical model of theory of, 567.
 — mathematics and, 565 *et seq.*
 — of accelerated motion, 552.
 — restricted principle of, 546.
 — space-time in, 555.
 — universe in the theory of, 642.
 — world lines in, 555.
 Religion in relation to science, 1028 *et seq.*
 Renaissance, the, 97 *et seq.*
 — academies, 234.
 — and the Reformation, 110 *et seq.*
 — books for reference on, 118.
 — in Italy, 111.
 — meaning of the, 110.
 — medical practice during the, 240.
 — morning of the European, 102.
 — science, England and, 177.
 Reptiles, 784.
 — evolution of, 789, 790.
 — fossil, 752.
 — in the Karroo rocks, 753.
 Research, advisers on methodical, 177 *et seq.*
 — Associations, 594.
 — books for reference on methodical, 186.
 — Defence Society, 895.
 — Department of Scientific and Industrial, 593.
 — Government grants for medical, 894.
 Respiration, mechanics of, 883.
 Result, nature of a, 937, 940.
 Rhodesian man, discovery of, 831, 833.
 Rice leaf hoppers, 858.
 Road transport and the internal combustion engine, 584.
 Rock, production of sections of, 660.
 Roman Aqueduct at Nîmes, 86.
 — Empire, Aix-la-Chapelle as capital of, 94.
 — — Constantinople as seat of, 92.
 — — divisions of, 90.
 — — fall of, 90.
 — — map of, 91.
 — engineering, 85.
 — hygiene, 84.
 — medicine, 83.
 — science, 81 *et seq.*
 — — books for reference on, 88.
 — scientific writings, 82.
 Romans contrasted with Greeks, 82.
 — technical knowledge of, 86.
 Rome, fall of dominion of, 18.
 — foundation of, 18.
 — period of oligarchy in, 1013.
 — sacked by the Goths, 90.

- Rome, sanitation in ancient, 874.
 Rothamsted Agricultural Experimental Station, 866.
 Rowett Research Institute, 868.
 Royal Academy of Arts, 234, 236.
 Royal Agricultural College, 864.
 Royal Astronomical Society, 236.
 Royal Botanic Gardens, 855.
 Royal Geographical Society, 236.
 Royal Institution, Brande as professor at, 349.
 — Davy at the, 321.
 — lectures at, 346.
 — Faraday appointed Fullerian Professor at, 351.
 — founded by Rumford, 321.
 — Tyndall appointed professor at, 359.
 Royal Military School, Woolwich, 233.
 Royal Society, 232, 235.
 — admission to, 235.
 — Boyle as President of, 277.
 — Charles II and the, 235.
 — Charter of Incorporation of, 235.
 — foundation of, 235.
 — Hooke becomes Secretary of, 206.
 — Leeuwenhoek becomes Fellow of, 260.
 — Newton elected President of, 217.
 — Newton's telescope at the, 196.
 Royal Society of Tropical Medicine, 905.
 Rudolphine astronomical tables, 147.
 Russia, agricultural research in, 868, 872.
- St. Albans, excavations at, 848.
 St. Paul's Cathedral, 262.
 Sakkarah pyramid, circumcision depicted on, 874.
 Saliva, function of, 913.
 Salivary gland ducts discovered, 883.
 Salt, accumulation of, in oceans, 682.
 — crystallization of, 500.
 Salts, ions in solid, 500.
 Salvarsan, discovery of, 903.
 Sanitation in ancient times, 873.
 — in mediæval England, 875.
 Saros cycle, discovery of, 24.
 Saturn, apparent path of, plotted, 65.
 — distance from the sun, 630.
 — rings of, and the origin of the earth, 662.
 — spectrum of, 634.
 Scholastic philosophy, 103.
 Scholasticism, 94, 96, 102.
 — British reaction against, 228.
 — in 13th century, 102.
 Schools, the Greek, 37 *et seq.*
 Science and mediævalism, 97.
 — applied to agriculture, 856, 866.
 — as a humanity, 1018.
 — as a seeker after truth, 1016.
 — as monopoly of priests, 35.
 — conception of time in, 1007.
- Science, debit and credit sides of, 1019.
 — distinction from poetry, 1018.
 — generalization in, 1016.
 — humility of modern, 1028.
 — idealism and present-day, 990.
 — in relation to economics, 1019.
 — to religion, 1028 *et seq.*
 — peak periods in, 1012-13.
 — philosophical implications of, 925.
 — "pure", as opposed to applied, 1016.
 — question of decline of, 1014.
 — Roman, 81 *et seq.*
 — spirit of, 1016.
- Scientific and Industrial Research, Department of, 593.
 — development, centres of, 592 *et seq.*
 — hypothesis, 570 *et seq.*
 — methods compared with legal, 1017.
 — questionnaire, 1038.
- Sculpture, peak periods in, 1012-13.
 Sediments, accumulation of, 682.
 Seismic method of prospecting, 693.
 Seisometer, records of the, 685.
 Sepsis, definition of, 873.
 Sequence, immediate, 938.
 Sheldonian Theatre at Oxford, 262.
 Silk, chemistry of artificial, 578.
 Silkworm disease, 886.
 Simplicity, Newton's principle of, 968.
 Simultaneity, Eddington on, 551.
 — Einstein's criterion of, 550.
 Sirius, distance from the earth, 610, 613.
 — spectrum of, 634.
Sceptical Chemist of Boyle, 284, 286 *et seq.*
- Sleeping sickness, 905, 907.
 Slovenia, excavations in, 849.
 Small-pox, cow-pox a preventive of, 891-2.
 — inoculation for, in 18th century, 891.
 Snail, forms of fresh-water, 782-3.
 Societies, proceedings of learned, 235.
 Society, difference from Academy, 234.
 Sodium, Davy discovers, 322.
 — electrons of, 481.
 — isolated by Davy, 491.
 — lines in spectrum, 424.
 Sodium chloride, Bragg's model of structure of, 499.
 Soil, research work on, 866, 868.
 Solar eclipse, meteorological observations during, 728.
 — observations, instruments for, 614.
 — radiation, intensity of, 708.
 — Soddy on propagation of, 655.
 — spectrum, 607.
 — Doppler effect in, 634.
 — Newton's experiments on, 422.
 — system, 606 *et seq.*
 — and Descartes' theory, 183.
 — Aristarchus' conception of, 60.
 — contrasted with stellar universe, 121.

- Solar system, Copernican, 120.
 — dynamical laws concerned with, 664.
 — Greek conception of, 58, 62 *et seq.*
 — — Jeans on, 663.
 — — Jeffrey's estimate of age of, 681.
 — — movement of, in the Milky Way, 683.
 — — theory of development of, from spiral nebulae, 668.
 — year determined by Chaldæans, 25.
 Solenoid, action of magnet on, 342.
 — orientation of, 341.
 Solid, molecules in a, 487.
 Solids, molecular formulæ and reactions of, 494.
 Solubility determinations, 384.
 Solutrean culture, 839, 842-3.
 Sound, propagation of, 397.
 Space and time, Jeans on, 563.
 — curved, 556.
 — de Sitter on curvature of, 561.
 — different conceptions of, 561.
 — — kinds of, 539.
 — Einstein on curvature of, 561.
 — expanding, conception of, 641.
 — four-dimensional, 540, 556.
 — infinite, 538.
 — Jeans on curvature of, 558-9.
 — Milne on, 648.
 — nature of, 646.
 — or continuum, meaning of, 421.
 — three-dimensional, 540.
 Space-curvature and astronomy, 644.
 — as mathematical fiction, 644.
 — mathematical conception of, 641.
 Space-relations, H. W. B. Joseph on, 560.
 Space-time, construction of, 978.
 — Hallett on "physical", 560.
 — in relativity, 555.
 — intervals, 1008.
 — mathematical concept of, 566-7.
 Spagyrist, characteristics of the, 286.
 — significance of, 284.
 Sparta, 7.
 Species, causes of variation within a, 820.
 — definition of, 781.
 — fixity of, 748.
 — influence of environment on, 740.
 — natural selection of a, 797.
 — origin of different, 781.
 — pre-evolution idea of fixity of, 736.
 — question of origin of, 822.
 — races of a, 782.
 Specific gravities, 380.
 Spectra, absorption lines in, 425.
 — of elements, 425.
 — of nebulae, 63.
 Spectrograph, Aston's mass, 468, 470.
 Spectrographic lens designed by Rayton, 635.
 Spectrometer, 424.
 — X-ray, 465.
 Spectroscope, use of, 424.
 Spectroscopy, 422 *et seq.*
 Spectrum, extension of visible light in the, 431.
 — infra-red region of the, 427.
 — invisible, 426.
 — medical use of, 890.
 — position of X-rays in, 427.
 — range of electro-magnetic waves in, 432.
 — scale, response of eye to, 432.
 — sodium lines in, 424.
 — solar, *see* Solar spectrum.
 — ultra-violet region of the, 427.
 — visible, 426.
 — wave-lengths in the, 428.
 Spermatogenesis, 765.
 Spermatozoa, 766.
 Sphygmomanometer, 890.
 Spiral nebula in Ursa Major, 626.
 Spirillum form of bacteria, 897-8.
Spirocheta pallida, 898.
Splashes, Study of, 395.
 Spontaneous generation, Bastian and, 889.
 — Pasteur disproves, 886.
 "Sport", biological definition of, 819.
 Staphylococci, 897.
 Star, determination of altitude of a, 139.
 — neutralization of gravitational force of sun by a, 670.
 — parallactic angle of a, 612.
 Starch, photosynthesis of, 757.
 — size of molecule of, 903.
 Stars, Anaximine's conception of, 59.
 — atlas of, 519.
 — estimates of numbers of, 622.
 — gravitational force of, 673.
 — measurement of angular diameters of, 616.
 — — of distance from the earth, 612.
 — parallax of, 613.
 — photometric method of measuring distances of, 629.
 — relative distances of the, 122.
 — tidal response of, to sunbolts, 665 *et seq.*
 Static system, causation in, 933.
 Statics of Archimedes, 75.
 Status, professional, 238.
 Steam-engine, invention of, 584.
 Steel, Bessemer process for, 586.
 Stellar observations, instruments for, 614.
 — system, 607.
 — — statistical method of ascertaining structure of, 619.
 — universe contrasted with solar system, 121.
 Stereo-isomerism, 492 *et seq.*
 Sterilization of the unfit, 923.

- Stevenson screen, 700.
 Stone Age cultures, 838.
 Stratigraphy, fundamentals of, 658.
 Stratosphere, 708 *et seq.*
 — composition of, 716-17.
 — height at which it begins, 712.
 — temperature of, 710, 712.
 Streptococci, 897.
 Structures, modern, 585-6.
 Sugar, photosynthesis of, 757.
 Sun, condensation of gaseous filament from, 672.
 — diameter of, 607.
 — distance from the earth, 607.
 — of Altair and Saturn from, 630.
 — elements in the, 426.
 — energy of, stored in coal, 435.
 — experimental determination of energy of, 434.
 — Galileo discovers spots on, 158.
 — neutralization of gravitational force of, 670.
 — photosphere of the, 426.
 — transformation of elements in, 507.
 Sunbolts, ejection of, 665.
 — tidal response of stars to, 667.
 Sunlight, spectrum of, 424.
 Suprarenal glands, 919.
 Surface, volume enclosed by, 213.
 Surgery, beginning of rational, 239 *et seq.*
 — in 17th century, 878.
 Symbolism in physics, 533.
 Symbols and the "pure" mathematician, 393.
 Syphilis, bacillus causing, 898.
 — salvarsan for, 903.
 Syphons, Boyle's explanation of action of, 282.
 Systole, meaning of, 249.
 Taungs skull, 832.
 Taxonomy, 734.
 Telephone, invention of modern, 592.
 Telescope, Galileo invents, 150, 156.
 — Newton's reflecting, 195.
 — principle of, 153.
 Telescopes in Mount Wilson Laboratory, 195, 614-15.
 Television, 588 *et seq.*
 — application of micro-waves in, 729.
 — Baird's process of, 589.
 — von Ardenne's process of, 589.
 Televisor invented by Baird, 588.
 Tell-el-Amarna tablets, 847.
 Temperature in meteorology, 707 *et seq.*
 Tertiary era, 839.
 — climatic conditions of, 841.
 — periods of, 839.
 Tetanus bacilli, 888, 898-9.
 Tetany, 920.
 Tetrahedral hypothesis of distribution of land and water on the earth, 677.
 Thebes, ruins of, 2.
 Theodolites in meteorology, 704.
 Theology, anatomy and, 239.
 Therapeutics, definition of, 873.
 Thermal convection as gravitational phenomenon, 714.
 Thermionic valve, 592.
 Thermit welding, 592.
 Thermodynamics, 433 *et seq.*
 — Joule's first law of, 433.
 — second law of, 434.
 — — Maxwell on, 437.
 Thermograph, 701.
 Thermometer, clinical, 890.
 — construction of, by Galileo, 698.
 — Fahrenheit's, 698.
 — Wilson's work on, 699.
 Thermometric substances, 383-4.
 Thermosphere of the earth, 687 *et seq.*
 Thorium, radioactivity of, 451.
 Thorotrast, 910.
 Thunder and lightning, 729.
 Thyroid gland, 919.
 Thyroxin, 919.
 Tidal hypothesis of origin of the earth, 633 *et seq.*
 Tigris, geography of the, 4.
 Time, conception of, in science, 1007.
 — infinite, 538.
 — relative significance of, 551.
 Toronto, observatory at, 617.
 Torsion balance, Boy's modification of, 692.
 — Eötvös' modification of, 692.
 — Michell-Cavendish, 691.
 Toulouse, Floral Games at, 234.
 Tourmaline plates, 415.
 Toxins, 900.
 Trade winds and monsoons, 698.
 Transmutation of elements, 501.
 Trinitrotoluene (T.N.T.) in warfare, 1022.
 Trinity College, Cambridge, closed because of Plague, 194.
 Trojan War, 16.
 Tromsö, auroral observatory at, 730.
 Tropical fevers, medical research on, 893.
 — medicine, 904.
 Tropopause, 710.
 Troposphere, 710.
 Trosome, 762.
 Troubadours, 234.
 Troy, Homer's, 13.
 Trypanosomiasis, 905.
 Trypsin, 913.
 Tuberculin, 888.
 Tuberculosis bacillus discovered, 888.
 Tuning fork, vibration of, 397.
 Turbine, invention of, 582 *et seq.*
 — plant, statistics of use of, 584.
 Turks, Constantinople taken by, 92.
 Typhoid bacilli, 888, 898-9.

- Typhus, 905.
Tzetzé fly, 908.
- Ultra-violet light, ionization by, 725.
— rays, action of, in photosynthesis, 759.
— — irradiation of ergosterol by, 915.
— region of spectrum, 427.
- Uncertainty, principle of, 523, 947.
- Unconditionalness, 939.
- Unemployment, science a cause of, 1019.
- United States system of arithmetical notation, 609.
- Units in physics and engineering, 572.
- Universe, adverse views on the expanding, 992 *et seq.*
— and the atom, Eddington on, 649 *et seq.*
— Clausius on the entropy of the, 437.
— Coleridge on expansion of, 558.
— conceptions of the, 642.
— de Sitter's, 643.
— Eddington's, 643.
— — annihilation of, 652.
— Einstein's, 643.
— — earlier view of, 987.
— — estimate of size of, 642.
— — later view of, 992.
— estimates of size of, 642.
— expanding, 638 *et seq.*
— in the theory of relativity, 642.
— Jeans' mathematical interpretation of, 986-7.
— — on annihilation of, 651.
— — on expansion of, 557.
— Knox Shaw on expansion of, 649.
— Lindemann on expansion of, 649.
— mathematics in interpretation of, 977.
— Milne's hypothesis of, 647.
— Plato's conception of structure of, 79.
— Pythagoras' conception of, 59.
— relative motion in the, 124.
— scale-model of measured, 646.
- Universities in the 13th century, 103.
- University research, 593.
- Upper atmosphere, effect of, on wireless waves, 725.
— ionization of, 725.
— ozone in, 725-6.
— records of, 702.
— wind velocity in, 704.
- Ur, excavations at, 848.
- Uranium compounds, fluorescence of, 449.
— disintegration of, 682.
— rays emitted by, 450.
- Urinary tract, radiography of, 910.
- Ursa Major, spiral nebula in, 626.
- Vaccination, benefits of, 891.
- Vaccination, Jenner's work on, 892.
- Vaccines, use of, 889, 901.
- Vacuum-tube rays contrasted with natural rays, 454.
- Valency of elements, 487.
- Venus, phases of, 156.
- Vertebrates, 781.
— characteristics of, 787.
— classes of, 750.
- Vibration, amplitude of, 401.
— Ballot's observations on frequency of, 633.
— of tuning fork, 397.
— of waves, 401.
- Virus units, sizes of, 903.
- Viruses, nature of, 902.
- Vision, hypotheses of, 571.
- Vitalism, dynamic, 803.
- Vitamins in relation to life, 917.
— nature of, 915.
— production of, 578.
— study of, 914.
- Vitelline membrane, 768.
- Vivisection, 894.
- Volts, definition of, 573.
- Vortices, Descartes' system of, 182, 964.
- Warfare, chemistry in, 579.
— science in, 1019, 1021.
- Water, Cavendish discovers composition of, 303 *et seq.*
— electric decomposition of, 336.
— heavy, properties of, 507 *et seq.*
— in alchemy, 266.
— pollution research, 593.
— waves, reflection of, 411.
- Watt, definition of the, 573.
- Wave, complete vibration of, 401.
— filter of Chamberland, 902.
— frequency of a, 401.
— longitudinal, 398.
— period of a, 401.
— periodic motion of, 401.
— spreading, Huygen's principle of, 413.
— theory of electricity, 356.
— — of light, 419.
— transverse, 398.
- Wave-lengths, 401.
— and frequencies, 430.
— Ångström units of, 634.
— frequencies of elements, 466.
— in the spectrum, 429.
- Wave-mechanics, modern views on, 518 *et seq.*
— of de Broglie, 528.
— of Schrödinger, 529.
— relativity in connexion with, 650.
- Wave-medium, elasticity of, 403.
— movement of elements in, 400.
- Wave-motion, 394 *et seq.*
— graphic representation of, 398.

- Wave-numbers, 431.
 Wave-packets, 525.
 Waves and particles, attempted fusion of, 378.
 — — Bragg on, 534.
 — — possibility of merging, 525.
 — composite, 407.
 — electro-magnetic, in the spectrum, 432.
 — in earthquakes, types of, 686.
 — interference of, 404 *et seq.*
 — lengths of, in Ångström's units. 431, 634.
 — nature of, 395.
 — of light, 404.
 — "probability", 529.
 — propagation of, 396.
 — reflected, 396.
 — transverse, of light, 404.
 — velocity of, 402.
 — wireless, *see* Wireless waves.
 Wavicle, conception of, 526-7.
 Wealth, peak periods in, 1012-13.
 Weather chart, daily, 699.
 — forecasts, 721-2.
 — lore, early, 698.
 — maps, 717 *et seq.*
 Weeds, eradication of, 856, 859.
 Western Empire, fall of, 89 *et seq.*
 Wheat, research on, 869.
 William Froude Laboratory, 597.
 Wind tunnel at National Physical Laboratory, 595.
 — vane, 701.
 — velocity in upper atmosphere, 704.
 Wireless, invention of, by Marconi, 592.
 — phenomena in high altitudes, 728.
 — waves and atmospheric refraction, 724.
 — — effect of upper atmosphere on, 725.
 — — electric, 408.
 — — for broadcasting, 726.
 — — kinds of, 727.
 — — mode of travel by, 725.
 Woolsthorpe Manor House, 218.
 Woolwich, research work at, 594.
 Woolwich, Royal Military School at, 233.
 World, early maps of the, 7.
 — population, closer contact of, 1015.
 — — greater intelligence of, 1015.
 — reality of the external, 926.
 Writing, alphabetic, 10.
 — of Babylonians, 10.
 Xanthophyll, 758.
 X-ray and Radium Protection Committee, 908.
 — diffraction, 520.
 — irradiation, 465.
 — photographs, interpretation of, 909.
 — spectra, photograph of, 466.
 — spectrometer, 465.
 — — examination of crystals by, 495.
 — spectrum and atomic number, 465.
 — therapy, 908, 910.
 — tube, 448.
 X-rays, 447.
 — and fluorescence, 449.
 — as waves, 520.
 — danger in using, 909.
 — diffraction of, 465.
 — length of, 431.
 — medical use of, 890.
 — rate of mutation increased by, 82c.
 — scattering of, 522.
 — velocity of, 418.
 Yaws, salvarsan for, 903.
 Yellow fever, 905, 908.
 Yeoman wheat, 870.
 Yugo-Slavia, excavations in, 849 *et seq.*
 Zodiac, grouping of constellations in the, 23.
 Zoological classification, 748 *et seq.*
 Zoology, 733.
 — classification in, 747.
 — influence of Aristotle on, 69.
 — specific differences in, 748.
 Zygote, 767-8.
 — cleavage of, 770.
 — factors of heredity contained in, 794.
 — from gametes to, 765 *et seq.*

