

# Birla Central Library

PILANI (Jaipur State)

Class No :- 380.1

Book No :- W445C. V.2

Accession No :- 29124





THE  
COMMON SENSE OF POLITICAL ECONOMY  
AND  
SELECTED PAPERS AND REVIEWS  
ON ECONOMIC THEORY  
VOL. II



**THE COMMON SENSE  
OF  
POLITICAL ECONOMY  
AND  
SELECTED PAPERS AND REVIEWS  
ON ECONOMIC THEORY**

BY  
**PHILIP H. WICKSTEED, M.A.**

---

EDITED WITH AN INTRODUCTION BY  
**LIONEL ROBBINS, M.A., B.Sc.(ECON.)**  
*(Professor of Economics in the University of London)*

VOL. II

LONDON  
**GEORGE ROUTLEDGE & SONS, LTD.**  
**BROADWAY HOUSE, CARTER LANE, E.C.4**

*Revised and Enlarged Edition published January 1933*

*Reprinted May 1934*

*Reprinted February 1938*

*Reprinted February 1944*

*Reprinted April 1946*

PRINTED IN GREAT BRITAIN BY  
LUND HUMPHRIES  
LONDON · BRADFORD

# CONTENTS OF VOL. II

## THE COMMON SENSE OF POLITICAL ECONOMY

### BOOK II

#### EXCURSIVE AND CRITICAL

	PAGE
CHAPTER I	
MARGINS AND THEIR DIAGRAMMATIC REPRESENTATION . . .	401
CHAPTER II	
ON THE DIAGRAMMATIC METHOD OF REPRESENTING AREAS OF SATISFACTION AND MARGINAL SIGNIFICANCES . . .	439
CHAPTER III	
ON THE NATURE OF CURVES OF TOTAL SATISFACTION . . .	474
CHAPTER IV	
BUYER AND SELLER. DEMAND AND SUPPLY . . . . .	493
CHAPTER V	
THE THEORY OF "INCREASING AND DIMINISHING RETURNS" . .	527
CHAPTER VI	
THE DIAGRAMMATIC EXPOSITION OF THE LAW OF RENT AND ITS IMPLICATIONS . . . . .	550
CHAPTER VII	
BANKING. BILLS. CURRENCY . . . . .	575

### BOOK III

#### ANALYTICAL AND PRACTICAL

##### CHAPTER I

SAMPLES OF ANALYSIS . . . . .	627
-------------------------------	-----



CHAPTER II	PAGE
SOME FURTHER ANALYSES . . . . .	660
CHAPTER III	
CONCLUSION . . . . .	696

## SELECTED PAPERS AND REVIEWS

<b>THE MARXIAN THEORY OF VALUE :</b>	
A. <i>DAS KAPITAL</i> : A CRITICISM . . . . .	705
B. THE JEVONIAN CRITICISM OF MARX (A Comment on the Rev. P. H. Wicksteed's Article by Bernard Shaw) . . . . .	724
C. THE JEVONIAN CRITICISM OF MARX: A REJOINDER . . . . .	731
ON CERTAIN PASSAGES IN JEVONS'S <i>THEORY OF POLITICAL ECONOMY</i> . . . . .	734
<b>ELEMENTARY MATHEMATICAL ECONOMICS :</b>	
1. Dimensions of Economic Quantities . . . . .	755
2. Degree of Utility . . . . .	759
3. Final Degree of Utility . . . . .	762
POLITICAL ECONOMY AND PSYCHOLOGY . . . . .	766
THE SCOPE AND METHOD OF POLITICAL ECONOMY IN THE LIGHT OF THE "MARGINAL" THEORY OF VALUE AND DISTRIBUTION . . . . .	772
FINAL UTILITY . . . . .	797
<b>REVIEWS AND BIOGRAPHICAL NOTES :</b>	
1. Stanley Jevons . . . . .	801
2. Jevons's Economic Work . . . . .	809
3. Pareto's <i>Manuale di Economia Politica</i> . . . . .	814
4. Sir Sydney Chapman's <i>Political Economy</i> . . . . .	818
5. H. J. Davenport's <i>Economics of Enterprise</i> . . . . .	822
<b>SELECTED SYLLABUSES OF EXTENSION LECTURE COURSES :</b>	
1. The Elements of Political Economy (Value or Worth), 1891 . . . . .	827
2. Hire and Interest, 1892 . . . . .	840
3. The Theory of Earning and Spending (Second Course), 1895 . . . . .	841
4. Getting and Spending, 1905 . . . . .	849
APPENDIX: BIBLIOGRAPHY OF WRITINGS ON ECONOMICS AND SOCIOLOGY . . . . .	863
INDEX . . . . .	865

**BOOK II**  
**EXCURSIVE AND CRITICAL**

**Cum rerum natura nusquam magis quam in minimis tota sit.**

**PLINY THE ELDER.**

Nowhere is the nature of things more intimately revealed than in  
the calculus of infinitesimals.

## CHAPTER I

### MARGINS AND THEIR DIAGRAMMATIC REPRESENTATION

**SUMMARY.**—*This chapter is devoted to a fuller examination of the principle of declining marginal significances. It is always the provocatives, opportunities, or supports of desired experiences or vents of impulse, and never those experiences themselves, that this law illustrates; but within that area it seems to be universal. It may appear, at first sight, that the claims of duty, of faith, or of humanity are not (or at least should not be) subject to any declining urgency as they are more fully met; and also that some satisfactions are habitually indulged in down to the point of satiety, whereas, according to our theory, the last and least significant increments of the things that minister to them should be less valued than increments of other things that would minister to still unsatisfied wants. But a careful examination will shew that these objections either rest on some misapprehension or are due to the fact that, under any given set of conditions, there is always a "minimum sensible" below which conscious estimates cannot be carried. Another set of difficulties arises from a confusion between the positive and negative sign of increments of satisfaction and a positive or negative state of satisfaction. The attempt to dispel this confusion, in connection with the diagrammatic method, leads us to an examination of the reactions of various kinds of indulgence upon the organism itself and its future capacities for enjoyment. This again leads to the discovery of interesting relations between a hedonistic calculus and current moral judgments. Our method, however, does not imply a hedonistic theory*

of conduct. The chapter closes with some notes on the dangers and limitations of the diagrammatic method it has introduced.

The whole structure raised in the First Book of this treatise rests upon the principle of declining marginal significance as supplies increase; and though we have established and illustrated it with sufficient firmness and accuracy for the immediate purposes of that Book, yet a number of problems to which no precise answers have been given may well present themselves to the reflective reader; and the extreme importance of the principle itself makes it desirable that it should be investigated and tested, not only in its immediate applications to economic problems, but in its fuller scope. Any misgiving as to its general validity might throw a taint of suspicion on its special applications. Moreover, we shall find that the closer investigation upon which we are now to enter will throw much light upon the connection between the narrower problems of Economics and the broader problems of Sociology; or perhaps we might say, between commercial Economics and the true Political Economy, in the sense of the economy of the *polis*, or regulation of the resources of the community.

Let us begin by noting that in speaking of declining significance we are never dealing with the ultimately desired experiences themselves, but always with something that we value as likely to produce such experiences. Thus, we spoke of concerts which a man wishes to attend because he thinks he will derive enjoyment from them; and we saw that, other things being equal, he would value a fifth concert per week less than a fourth. We did not say that a fifth "unit of enjoyment of music" would be less valuable to him than a fourth, for our only conception of a unit of enjoyment must be a quantity of enjoyment which equals some standard amount; so that each unit, being equal to the standard, would be equal to every other unit, and to say that the fifth unit was of less value than the fourth would be to say that two amounts were equal to the same but not equal to each other. Indeed it would obviously be nonsense to say that equally desired experiences have a declining sig-

The law of declining marginal significance.

Distinction between experiences and the things that generate them.

nificance, for if their significance declines they are not equally desired. In the same way, if we declare that opportunities of study have a declining value to a man, we may mean that if he has twelve hours a day clear for study he will attach less value to a thirteenth hour than he would to a fifth hour if he had only four; but we can hardly mean that successive acquisitions of a unit of information have a declining value, for we can hardly define a unit of information; and we cannot mean that successive increments of the pleasure or advantage he derives from the results of his study have declining value, for our only conception of equal increments of satisfaction must be increments that have the same value. And so throughout. So we are never speaking, in this connection, of units of experience, which (if we can form any conception of them at all) must be regarded as equal, but of units objectively measurable, roughly or accurately—whether by time, space, weight, number, or otherwise,—which are valued for the sake of the states of consciousness they are expected to produce or the vent they afford to impulses.

What we assert, then, is that after a certain point successive increments of external stimulants, or opportunities, produce successively declining increments of the desired internal experiences. And this principle applies not only to things provocative of delight to the senses, but to means of artistic and literary enjoyment, and even to opportunities for securing the satisfactions, or obeying the impulses, of friendship or affection. But it is sometimes asked, "Is not the case different when questions of duty are concerned? Does not duty always remain paramount, however much of your powers and resources you have already devoted to its demands? And are not the claims of compassion always superior to those of selfishness, however much you may have indulged the former and starved the latter? Is it possible for a well-regulated mind to bring about a marginal coincidence of value between the means of satisfying desires which are on essentially different ethical levels? Can such qualitative distinctions be reduced to questions of quantity?" That they are so reduced, it will be admitted, is a fact (whether lamentable or not), and in dealing with ordinary humanity we might be safe enough in assuming that such a reduction

would take place; but when we find that the martyr who has borne the rack is ready to be burnt to death sooner than depart a hair's breadth from the formula of his confession, we seem to have reached a region to which this law of diminishing significance does not apply. However much the martyr has given to his faith and however little he has kept for his comfort, it would appear that the escape from no quantity of physical anguish, however great, will weigh against any concession in the matter of faith, however small.

Such questions may seem to take us very far from our proper subject, and so indeed they do, and it is for this reason that they have been excluded from consideration at an earlier period. But I have maintained from first to last that the laws of Economics are the laws of life, and consequently if a law declares itself to be paramount on the economic field, it proclaims itself by implication as a general law of life and conduct. It may therefore be legitimately challenged on any field, and if it cannot hold its own everywhere it must at least lie under suspicion in its economic applications. In any case, a closer inspection of our general principle, in other applications, is almost certain to throw light upon the special applications in which we are most interested. To begin with, then, it is not only consistent with our theory of "prices," but is actually involved in it, that to any man, at any given time, there *may* be some alternative so horrible that sooner than accept it he would endure all the physical and mental torment that can possibly be inflicted on him. This does not necessarily mean that he does not feel the torture, though even that might be the case, but it means that the whole sum of torture which he is capable of enduring before his frame cracks will not be enough to overcome his shrinking from the only alternative open. Something must give way first, and if his resolve, or his aversion, is stronger than his physical vitality, the tissues of his frame will be disintegrated or his vital functions unhinged before his choice is reversed.

History shews that these conditions have from time to time arisen; and we contemplate with awe the heroes who have supplied the demonstration. We probably think that few people could rise to this pitch of heroism in any cause;

Are the  
claims of  
duty and of  
faith exempt  
from the  
law?

but, on the other hand, it is no more than we have a right to expect of every normal human being, living a normal life, that there should be certain things which he would not do for any amount of money, however large; perhaps because he regards the actions as detestable or dishonourable, perhaps only because he regards them as intensely disagreeable. This only means that to him the total difference between the command of things in the circle of exchange that he already enjoys, and an indefinite or unlimited command of them, does not weigh as heavy in his mind as the dishonour or the discomfort of the specific thing that he is required to do. It does not mean that his objection is "infinite." It merely means that it is larger than his estimate of all the satisfaction that he could derive from unlimited command of articles in the circle of exchange, and this is a strictly, perhaps narrowly, limited quantity.

These considerations, it is true, do not completely satisfy us; for they would seem to imply that although the offer of money may not be enough to make an honourable man do a dishonourable action, yet if he is in want of money at all the offer must tend in the direction of making him do it, so that raising the bribe would strengthen the temptation. If it is true, as we have said, that every force tells for all that it is worth whatever other forces are already on the field, would it not follow that if a man is in want of money the offer of money must tell for what it is worth, whatever other motives actuate him? And if so, must he not be nearer to doing the dishonourable action (though he does not do it) than he would have been had the bribe not been offered to him? And if the bribe is raised (so long as he would still value the increased sum), must not the tendency to make him do the dishonourable thing become more marked? Or in the case of the martyr, if he shrinks from pain at all, must not the infliction of greater and greater degrees of pain tend to make him renounce his faith, though the inducement is not high enough actually to bring about the renunciation? It is true that there is nothing in these conclusions that greatly shocks our general experience or observation. We hear men say, "I confess I was almost tempted by the prospect, for a moment," or "It required all my resolution to hold out, I



can assure you," when they are speaking of actions the commission of which would have filled them afterwards with shame and self-contempt. But nevertheless we can by no means admit that every man can be at any rate tempted, though not seduced, by a bribe, or shaken, though not broken, in his resolution by torture. We are certain that this is not even approximately true as to the bribe, and we cannot believe that it is completely and universally true as to torture.

On this we may note, in the first place, that the very offer of the bribe or application of the torture may wake resisting forces which were dormant before.<sup>1</sup> I might be considering whether or not an action was really dishonourable before the bribe was offered, and as soon as a bribe is proposed I may have a conclusive reason for associating it with dishonour. Or again, if a man offers me half a crown for doing or saying something I may be contemptuously amused, but if he offers me £1000 I may be deeply insulted. For I might take the first proposal as a naïve attempt to overcome my inertia, but the second as revealing a serious intention of finding out the price at which I would sell my honour. Thus the increased inducement might itself touch the spring of increased resistance. If the briber can contrive to associate his material offer not with dishonour but with some appearance of honour, and can make his insult take the semblance of a tribute of respect, it will perhaps be found that £1000 does indeed weigh more than 2s. 6d. in the scale. But even here a finer perception might detect the finer insult, and might resent it the more deeply for its deliberate subtlety.

But there is something deeper even than this, and its examination will lead us back to our economic and commercial investigations. Just as it is very easy to suppose that a man could tell the difference between a half-pound and a quarter-pound weight by trying them in his hand, but very difficult to suppose that he could tell the difference between 14 stone and 14 stone plus a quarter of a pound by lifting them in a basket, so it is very easy to imagine a man's refusing to give 1s. for a thing that he would be glad to have for 6d., but very difficult to imagine him willing to give £1000 for some object but refusing to

*The minimum  
sensible.*

<sup>1</sup> Compare the qualifications to the Principle of Superposition on page 204.

give £1000:0:6 for it. That is to say, 6d. is appreciable when the whole matter at issue is only 1s., but inappreciable when the matter at issue is £1000. It is a case of proportion. When the stake is of any given magnitude there is a certain *minimum sensible* or minutest quantity that can be felt or appreciated in connection with it; and this *minimum sensible* will vary with the magnitude of the thing at issue. The same principle applies in the moral world. When my feelings are deeply moved and I am vividly realising any one of the main issues of life, things to which I should give careful attention on other occasions do not affect me in the least. The mind does not readily adapt itself at one and the same time to the higher and the lower end of the scale. When it is experiencing great things it is not sensitive to small ones. When some grave disturbance of equilibrium has occurred or is threatened, or some vast issue is at stake, small things are not felt. Only if the great things were secure and had not recently been disturbed would the small things be able to assert themselves as significant. If I hear of the sudden and unexpected death of a dear relative and immediately begin to speculate about his will, why am I ashamed of myself? Because I had imagined that my affection for him was so great that immediately on the news of his death the significance of a few hundred or thousand pounds would have sunk below the *minimum sensible*. And when I find that it is not so, I perceive that I have given myself credit for a higher appreciation of the things that are not in the circle of exchange, relatively to those that are, than I really possess. It is a startled sense of my own sordidness that brings my shame. It is not that I believe I ought not to care whether I have or have not the sum of money, but that I should have supposed that at that moment there would have been no room in my mind for such a thought, any more than for the fit of my trousers, or any other subject of consideration in itself perfectly proper but not sufficiently important to claim a share of my attention at the moment. I might experience the same kind of shock if, in catching up a child wounded by a passing dog-cart or motor-car, I found myself annoyed because my cuffs were stained or my clothes damaged by his blood. And the proof

that this correctly represents the psychology of the case is that if the question of the legacy or of the stained cuff merely presented itself to me externally but failed to touch the springs of interest or emotion, if it were a mere shadowy presence with no weight or "tactile value," I should note it as something strange, but should not feel it as anything shameful. The same analysis applies to occasions on which some great happiness comes to a friend accompanied by a slight incidental inconvenience or disappointment to oneself. The examination of such cases reveals the possibility of any given consideration sinking beneath the *minimum sensible*, but it also reveals the fact that in an enormous number of such instances the feeling or the motive that we neglect without one moment's hesitation is nevertheless actually felt. It is negligible, but if we look for it, it is there. It does weigh something, but it does not for a moment threaten to turn the scale.

Returning now to the martyr or the "incorruptible," we see that it is perfectly possible for the extremest pressure that can be brought to bear upon either to be quite negligible, so that it would no more be recognised as a reason (even an inadequate one) for doing the abominable thing than fear of staining my cuffs would be recognised as a reason against helping a wounded child. And it may be that it is not only negligible and practically unrecognised, but absolutely imperceptible even when we look for it. There is ample room for these facts within the limits of our theory.

Another point suggests itself for consideration in connection with moral questions. There is much confusion and ambiguity in our use of the word "duty." I may say that no personal or private considerations however urgent ought to affect the performance of my duty, even in the minutest point; but I shall not allow that I ought to leave a burglar despatching his business in my house rather than be a minute late at the office. "Of course not," it will be said, "because it is your obvious duty to protect your family, to say nothing of your property." Apparently, then, it is my "duty" to attend to whatever I conscientiously consider the most important matter at stake; and to say that nothing should interfere

Ambiguity  
of the word  
"duty."

with duty simply means that I ought to do the thing, whatever it is, which a high-minded man would regard as most important. Certain family claims which are not "duty" in a general way become so when they reach a certain point of urgency; and when satisfied down to a certain point they will again cease to be duty. In this sense "duty" is not a label which is attached to certain classes of action and not to others, giving precedence to the smallest volume of that to which it is attached over the largest volume of everything else. It is a name we give to the resultant course of action when every consideration has been given its due weight and no more, and nothing that is irrelevant has been allowed to weigh at all. And we shall generally find, on analysing any dilemma, that the dictum "Duty before all things" is only maintained by giving the name of "duty" to whatever, under the circumstances, properly comes first; and that our determination on this point is influenced both by the terms on which the alternatives are offered to us and by the extent to which we have already paid tribute to the one or the other claim. The label can only be attached after the conclusion is reached, and cannot indicate any short cut by which to reach it. If I insist on allowing no weight to any considerations that cannot be labelled "duty" in advance, I shall generally find that I must include in my "duties" not only my duty to my family and to my friends, but also that trump-card of the casuist, my "duty to myself." And I shall find myself speaking of a "conflict of duties," thereby implying that duty itself is a quantitative conception. It is of course true that if we are to allow no more than its due weight to a certain consideration we shall often allow it no weight at all, because it is irrelevant. If I am asked, for instance, to arrange a number of candidates in order of merit, I shall probably regard it as absolutely irrelevant to the matter in hand that a widowed mother is dependent on the success of one candidate, while another is a man of property himself and has no one dependent upon him, or that I am attached to one and am repelled by the moral character of another, or that I believe that success will react prejudicially on the character of one and favourably on that of another. And if I take this view, then undoubtedly it is my duty not

to give any weight to considerations that ought not to weigh, and it may or may not require some heroism on my part to act up to my convictions; that is to say, the temptation may tempt or it may not, as in the cases already noted. Or I may find that the real temptation is to incline to the verdict counter to my wishes, in order that I may escape the reproach of having been influenced by them. We may note that it is usual to protect examiners, as far as possible, from all knowledge of facts that are to be regarded as irrelevant; and this shews that the difficulty of ignoring them, if known, is generally recognised.

On the other hand, if I am making an appointment I may think that some or all of these considerations are relevant, and in that case it may be my duty carefully to appraise them all and weigh them against each other. When we have admitted that considerations of extreme strength in their personal appeal may be wholly irrelevant, and ought not to be realised as motives at all, even if they are felt, we shall have done full justice to the absolute conception of duty; but it is interesting to note how very many cases there are in which we are inclined at first to regard a consideration as irrelevant in principle, but find on close examination that a mere quantitative change in the things considered, if sufficiently pronounced, appears to us to raise the irrelevant into relevancy. In any case, our theory only asserts that when a consideration that "ought" not to weigh at all does as a matter of fact weigh—that is to say, is felt as a temptation—it may be felt more or less according to the magnitude and urgency of the issues at stake.

It is highly instructive to turn from the objection to the doctrine of declining significance which we have just examined to another which is quite as frequently urged. —It is said that the whole theory of distributing our resources so as to gratify our wants *pari passu* and keep the marginal wants balanced, is false to fact and experience. The truth is, it is said, that there are certain things that we "must have and we get "as much as we want" of them before we begin to consider less urgent requirements at all. For instance, we all eat as much as we want several times a day,

Do we secure  
"as much as  
we want" of  
one thing  
before we  
secure any of  
another?

and do not stop short of satisfaction because our desire for literature or travel is unsatisfied. Now to begin with, this is obviously an argument of the well-to-do. It is flagrantly untrue of the very poor that they get as much food as they want before they begin to trouble about keeping up their supply of clothes.<sup>1</sup> We have already spoken of the thousands of young people, well above the line of actual want, who in managing their own slender resources consciously and constantly bring their meal to a conclusion at a penn'orth or two penn'orth short of satisfaction in order to advance some other margin. In its crude form the whole contention that we are examining is palpably false. Where do we or can we find in civilized society the man who gets as much food as he wants "before" he gets any clothes or any shelter? All that can be seriously maintained is that if a man's resources are sufficient to provide him with a certain amount of the things he needs most urgently, including food, he will soon come to points in every other branch of his expenditure at which he will be content to rest until he has completely satisfied his desire for food as far as mere quantity, apart from quality, goes.

In the contention so formulated there is a great deal of truth, but it need not disturb our confidence in our general theory. Any one who has tried saving pence out of his meals by restricting them in quantity, not quality, will know that the significance of these pence rises very rapidly as they are successively withdrawn. A halfpenny-worth of bread (two thick slices of a half-quartern loaf) may carry a man from a sharp sense of hunger to a sense of satiety. To save 3d. a week on bread might involve a very considerable volume of unpleasant experiences, and therefore, unless the 3d. would minister (as in Cobbett's case) to very keenly felt wants in other directions, it would be bad husbandry to save it. "Yes," it may be said, "but by your theory to save 1½d. a week would involve less than half the sacrifice of saving 3d. a week, and its expenditure on something else would secure more than half the gratification of three pennyworth; and since by hypothesis the expenditure on bread is taken down to a point at which it ceases to have any significance at all, there must be some small quantity<sup>2</sup>

<sup>1</sup> Pages 34 *sq.*

<sup>2</sup> Cf. pages 66 *sqq.*

of the resources expended upon it that could be profitably turned elsewhere." This is theoretically true as far as it goes; but theory also tells us that this adjustment would be an exceedingly delicate matter, and that it might demand an amount of attention and exercise of will that could be more profitably employed somewhere else where it would have a higher marginal significance.<sup>1</sup>

We have now examined two attempts to invalidate the general principle on which, as I have maintained, we administer our resources. It has been contended both that the sense of duty *ought to be* completely satisfied down to the last and minutest demand, and that the appetite for food *actually is* so satisfied, before anything else is attended to at all. The collocation of these two contentions is amusing; and before we leave them we may note that the sense of duty and the desire for food may become direct rivals. In that case I may perhaps cheerfully go without a meal at the call of "duty"; but presently I shall find that it has become my imperative "duty" to suspend the direct performance of my "duty" for a short time in order that I may eat something to enable me to perform my "duty" more strenuously (or to perform it at all) afterwards; and the graduated formulæ of "it is an imperative duty," "I almost think it is a duty," "I really think that without any dereliction of duty I may allow myself," etc., ease the (in this case) *difficilis descensus* from the pretentious heights of absolutism to the *avernus* (shall we call it?) of practical relativity.

Another and closely related aspect of the question of declining significances is suggested by charitable appeals.

The relief of For instance, there is a famine in India, and I suffering. subscribe a guinea. That would appear at first sight to mean that I consider the want of food in India more urgent than any other wants of my own or any one else's to which the guinea would have ministered. But if so, why not give a second guinea? Has the want in India been sensibly reduced by my subscription? In bulk, yes. But in intensity? Even if I could suppose that my guinea had met the most urgent case, would there be any perceptible

<sup>1</sup> For a worked-out example see my *Alphabet of Economic Science* (London, 1888), pages 128 *sqv.*

decline of urgency in the next case waiting to be met? It is exactly the question of the increments of tea over again. We saw that there was no perceptible decrease in the significance of tea as we passed from one quarter-ounce to the next at the margin of 4 lbs., though there was a perceptible satisfaction in the consumption of either.<sup>1</sup> So I must suppose that a perceptible relief of suffering has been effected by my guinea, but I can hardly believe that a second guinea would relieve suffering perceptibly less intense than that relieved by the first. The marginal significance of a guinea, then, in relieving distress in India, appears to remain the same. Why do I not pay a second guinea and a third, and so on? The answer is twofold. In the first place, in the majority of cases it is not really the famine in India but my own conscience that I am appeasing, and my own conscience becomes perceptibly less clamorous after the first guinea has been paid. It may still grumble, and dispute the ground with other applications, but it may no longer dispute it successfully. My conscience may be right or wrong in insisting that I should take a share in the burden, and in being appeased when I tell it I have done so; but that is not the question. The point is that the demand I am meeting is, as a matter of fact, perceptibly reduced by what I have done to meet it. It is otherwise, however, if I really am directly appraising the urgency of the want that my guinea relieves when given to the famine fund, and the wants it can supply in other applications. In this case it is true that the want in India does not perceptibly decline as I give guinea after guinea, but it is also true that the wants that I neglect in order to meet it perceptibly rise as guinea after guinea is subtracted from the supply of them, until at last they rise to the level at which they balance my sense of the urgency of the need in India. This point may not be reached till I have reduced myself and all those dependent upon me to the level of misery of those that I am relieving; and some moralists are courageous enough to hold this up as an ideal. Our theory of marginal significance is elastic enough to adapt itself to their creed; for all that we assert is that, whatever the grounds on which we form estimates of the



relative significance of rival applications of resources, we can so administer those resources as to bring their marginal significance in each application to equality. The urgency of the Indian claim is no doubt gradually declining if the administration of the fund is even approximately sound; but within the limits of the influence of my fortune it does not decline perceptibly. The balance is therefore found when all other expenditures are curtailed to the point at which their rising marginal significance equals that of the Indian claim.

Curious light is thrown on this class of problems by the added joy and relief which is not unfrequently felt by the recipient of a present that comes with the condition that it is to be spent on a holiday or on some personal indulgence. Presumably the recipient, if free, would have spent the sum as he wished. Why is he pleased at being forbidden to do what he would have wished? Because it is the sense of his duty to do the thing, not his sense of the importance of the thing's being done, that would have successfully contested the first place; and his "sense of duty" is entirely extinguished by the prohibition. The demand that would have had to be appeased before the other could be indulged is withdrawn from the lists, and the indulgence can be secured without a drop of gall. A goad has been blunted, and the hedonistic gain is obvious. In cases where this analysis would be untrue and where the wish to do something else with the money is really inspired by the eagerness of direct sympathy, the restriction would be actually felt, and perhaps resented, as a reduction in the value of the gift. Perhaps by the painful associations it waked it would altogether annul it or leave a balance to the bad.

We have now concluded our examination of the class of objections to the law of diminishing psychic returns which is based on the absolutism of ethical or social conceptions; but in the course of these investigations we have been incidentally led to contrast a demand or craving that has to be appeased with an enjoyment that may be secured. This opens in its entirety the important subject of positive and negative satisfactions, their relations to each other, and the proper notation to be employed in their calculus; and to this subject we must now turn.

Examination  
of an apparent  
paradox.

Positive and  
negative  
increments  
and states.

If we regard pain as negative pleasure, and discomfort as negative satisfaction, then a supply of anything that gradually relieves me from acute suffering leaves me in a state of (decreasing) negative satisfaction throughout the process. But the reduction in the volume of this negative satisfaction, which is taking place all the time, is a movement in the positive, not the negative sense. It is an addition, not a subtraction, of desired effects; for it is a subtraction of undesired experiences. The acquisition, therefore, is a positive quantity, and must be noted by a plus, not a minus sign. Here we may introduce the familiar notation of curves. On Fig. 1 we measure the supply of any commodity per unit of time along the line  $OX$ , or the axis of  $X$ ; and on  $OY$ , or the axis of  $Y$ , we measure rates of satisfaction. Thus the curve

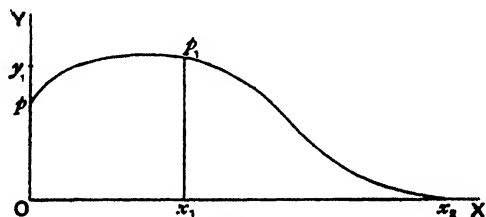

FIG. 1.

$pp_1x_2$  would represent that the initial increment of the commodity per unit of time satisfies some kind of desire at the rate of  $Op$  per unit of commodity; that by the time the supply is increased to  $Ox_1$  the rate at which it is satisfying desire has risen to  $x_1p_1$  or  $Oy_1$ , and that when the supply reaches  $Ox_2$  per unit of time, the desire is completely satisfied. The quantities measured along  $OX$ , which are called abscissas, indicate the breadth of the supply per unit of time, or the breadth of the stream of supply. Quantities measured along  $OY$ , which are called ordinates, indicate the marginal values investigated on pages 47-71 of Book I,<sup>1</sup> and areas such as  $Opp_1x_1$  sums of satisfaction per unit of time, secured by the consumption per unit of time of the quantity of the commodity indicated by the corresponding abscissa. Generally speaking, such an area must (as we have here supposed) itself be taken as representing a rate of total enjoyment per unit of time, rather than a

<sup>1</sup> For the full justification of this statement, see below, pages 440 *seq.*, especially pages 446 *seq.*

sum of total enjoyment: <sup>1</sup> but sometimes it will be convenient to take the whole figure as representing not a rate of consumption, but a single act. And in such cases we shall take  $x_1 p_1$  as representing the marginal value, and the area  $O p p_1 x_1$  as representing the "value in use" or total significance of the definite quantity  $O x_1$ . For instance, the figure might roughly represent the experiences of a single meal, during which for a time "the appetite comes as we eat" and we are conscious of increasing enjoyment, whereas after that point our hunger is gradually appeased to the point of satiety.

Now this diagrammatic method is useful as an instrument of research, as a means of demonstration and exposition, and, most of all, as a vivid and comprehensive form of statement. But it is very dangerous, and if not used with due caution and precision it may lead to grave confusion and may encourage loose and irresponsible thought. In the next chapter, accordingly, we shall examine the construction of one particular curve in great detail; and whenever we make use of curves we must try to bear in mind the necessity of giving an exact account of what they mean, so that the results obtained may not be in any way equivocal. The necessity for caution in this matter is illustrated on the very threshold, for (apart from the difficulty of determining how we are to measure a unit of satisfaction <sup>2</sup>) we have to note at once that this first curve which we have introduced is ambiguous in relation to the very matter we are now discussing, viz., the relation between assuaging a craving and securing a positive enjoyment, or, more generally, between removing negative and securing positive objects of desire. We have seen that the removal of a pain must have the positive sign, and it must therefore be represented by a positive area, so that if we begin in pain and the supply of a commodity gradually removes that pain, the result must be represented as positive—comparable with, and to be weighed against, a gain of positive satisfaction. Our figure, therefore, will not tell us whether we begin in a state of positive satisfaction, a state of indifference, or a state of negative satisfaction, or pain. It will only tell us that if we command the quantity of the commodity represented by  $O x_2$ , our state will be the *better*,

<sup>1</sup> Cf. page 101.

<sup>2</sup> See Chap. II. of this book, and cf. Chap. III.

by the whole area  $Opp_1x_2$ , than it would have been had we had no supply at all. If we only command  $Ox_1$  our state will be the better by the area  $Opp_1x_1$ . The area  $x_1p_1x_2$  will then represent either an unassuaged pain or an unrealised pleasure, but in either case the area  $Opp_1x_1$  must have the positive sign. It is a gain, not a loss. The existence of the possibilities represented by the figure may in itself constitute a misfortune or a privilege; but granted their existence, the command of  $Ox_1$  of the commodity, whether it means plus a pleasure or minus a pain, is a gain (in the estimation of the subject), and must be regarded as positive.

If we draw Fig. 2, it will represent the effects of the supply of a commodity which ceases to act in a positive

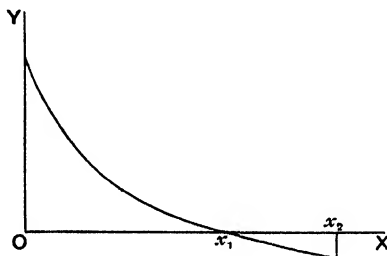

FIG. 2.

sense when it exceeds  $Ox_1$  in quantity. Thus at a given temperature the consumption of fuel might begin by being extremely acceptable, and when it had reached the rate of  $Ox_1$  per hour it might cease to be acceptable at all, and might, if raised still higher, become positively undesirable, or negatively desirable. Now one man may be so constituted that whereas he does not feel any positive distress by sitting without a fire, he may be conscious of a distinct pleasure if a fire is lighted; and another may be consciously miserable without a fire, and as the warmth increases may be conscious only of more or less adequate relief from discomfort till the quantity  $Ox_1$  is exceeded, after which another kind of discomfort ensues from excessive heat. Yet another may at first be conscious of relief from suffering; then, before the quantity  $Ox_1$  is reached, may feel that all his discomfort is gone and a positive enjoyment of the cosy warmth has succeeded to it; until, as the quantity  $Ox_1$  is

exceeded, he feels that although the room is still positively pleasant it would be pleasanter yet if the fire were kept a little lower. To all these men alike the supply of the commodity up to the quantity  $Ox_1$  will produce a result that should have a positive sign and should be represented by a positive area, though to one it is minus pain, to another plus pleasure, and to the third at first minus pain and then plus pleasure; and to all of them the further increments represented by the line  $x_1x_2$  produce a result that should carry the negative sign and should be represented by a negative area, though to one it is plus pain and to another minus pleasure. All of them are in a state more to be desired as the supply grows from zero to

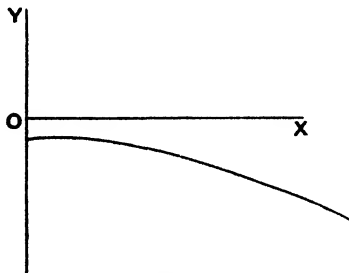

FIG. 3.

$Ox_1$ , and in a state less to be desired as it grows from  $Ox_1$  to  $Ox_2$ .

It follows from this example that an area below the axis of  $X$ , which represents negative satisfaction, may mean a subtraction from pleasure that leaves a positive balance, just as well as an addition of pain. Fig. 3 would represent a supply, or an experience, that, whether it detracts from the happiness of a happy state or makes a neutral one positively painful, or a painful one more painful yet, in any case produces a negative result, of increasing intensity per unit, as one increment follows another. If we are speaking in terms of positive satisfaction we shall still say that these increments have a declining (positive) significance, though if we were speaking in terms of negative satisfaction, or pain, we should say that they had a rising (negative) significance. Thus the fact that things which cause discomfort normally act with increasing intensity as unit is added to unit does not affect

the generality of our proposition that additional increments, after a certain point, produce decreasing (positive) results.

It sometimes happens that a positive quantity (in the technical and ambiguous sense in which it includes the subtraction off a negative quantity) is only to be had in association with a negative quantity. In that case probably the positive ordinates of the first will decline, and the negative ordinates of the second will increase, the movement in both cases being technically in the sense of positive decline. Thus a man who has bitten his tongue or has bitten a piece half out of his cheek may be in need of food, and yet eating may cause him acute annoyance. As his hunger or sense of faintness

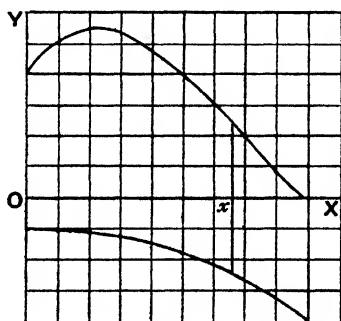

FIG. 4.

gradually yields, and his demand for food becomes less urgent, the increasing painfulness of the terms upon which alone he can assuage the declining urgency of his want will soon balance it, and his meal will come to what would else have been a premature conclusion. This might be represented either analytically by Fig. 4, or synthetically by Fig. 5. Both figures alike represent the fact that up to  $Ox$  an advance from the origin is accompanied by a balance of advantage, and that after that point the reverse is the case. And both figures agree in the magnitude of the advantage or disadvantage in either case.

Where there is no indication to the contrary a curve must be taken to indicate not a history but an anticipation, and an anticipation that has discounted (not necessarily for what they are worth) all conflicting elements, risks, and reactions as far

as they come within the ken of the person who makes the estimate. It will be a synthetic and resultant estimate of the balance of advantage to be anticipated from the acquisition of each successive unit of the commodity, of the type of Fig. 5.

We have noted that positive and negative quantities may be balanced against each other, and also that mathematically positive and negative quantities may both alike be ambiguous psychologically; for just as a subtraction from pain and an addition to pleasure are alike positive, so a subtraction from pleasure and an addition to pain are alike negative. Thus Fig. 2 (page 417), where the increments of the same commodity

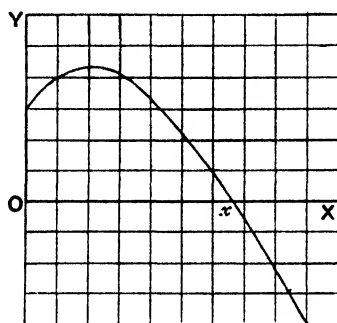

FIG. 5.

at first have a positive and then a negative effect, is explicit as to the positive or negative sense of the process in question, and as to declining (positive) significance of all increments after a certain point; but it is equivocal as to the positive or negative state of the person affected. He might be either in a state of suffering or a state of enjoyment throughout the process, or he might pass from suffering to enjoyment at any point on the line  $Ox_1$ , or from enjoyment to suffering at any point on the line  $x_1x_2$ ; but in any case he has either more enjoyment or less suffering as he passes from  $O$  to  $x_1$ , and either less enjoyment or more suffering as he passes from  $x_1$  onward.

Now, although the relief from a pain and the securing of a pleasure, or the deduction from a pleasure and the addition of a pain, have respectively the same signs, and

may be taken as equivalents, yet they are in themselves very different things. Given my constitution and circumstances, a certain relief from pain must be regarded as equivalent to a certain positive pleasure, a certain deduction of pleasure to a certain access of pain; and certain pleasures and pains taken together, or certain relinquishments of pleasure and escapes from pain taken together, must be regarded as balancing or neutralising each other; but it makes all the difference in life whether my constitution and circumstances are such that my energies have to be given chiefly to escaping or minimising undesired things or are mostly free for securing or developing desired ones, and whether I can often or only seldom get a pleasure without a concomitant pain or escape a pain without a concomitant loss of pleasure. And it is just here that our immediate choices react upon our future possibilities.

Difference  
between re-  
lieving pain  
and securing  
pleasure.

This subject of the reaction of our enjoyments, privations, and endurances upon our future capacities for enjoyment has already been touched upon in Book I,<sup>1</sup> but the investigation we have just completed will now enable us to enter upon it more fully. We have to make constant adjustments between the immediate gratification of desires and the building up of capacities. A great part of wise conduct obviously consists in forgoing a present gratification, or incurring present pain, or making irksome effort, in order to acquire a capacity for future enjoyment, or power ultimately to secure or promote desired ends. Wise administration of vital resources must therefore take constant note of this reaction of the present upon the future.

Every wise man must desire to build up for himself such habits of mind and body from within, as well as to surround himself with such outward circumstances, as will make life as little as possible an escape from wretchedness and as much as possible an experience of well-being and an achievement of desired ends. We must therefore cultivate the power to endure such undesired experiences as are inevitable, and to forgo such desired experiences as are unattainable, with the minimum of suffering, and to derive the maximum of satisfaction from the realisation of things desired. An

<sup>1</sup> See page 85.



example may make this clear. Two men are on a tour together in a beautiful and sparsely inhabited country. They find themselves out of their reckoning, and when dinner-time comes they are far from any opportunities of dinner. The spirits of one of the companions begin to sink, his temper becomes unstable, he cannot enjoy the scenery through which he is passing, the exhilaration of mountain air or of the battle with the waves is a thing he knows not, the suggestion to turn aside and spend half an hour in ascending a rock or exploring a cave is fiercely resented, and, in fact, the man's whole moral, æsthetical, and physical being is swept up into one hideous craving for food. At last the friends (if they still deserve the name) reach hospitable quarters. Their hostess wishes to do justice to her reputation and keeps them waiting for an hour in order to set a noble repast before them. But when it comes it is too late. The poor wretch can now eat nothing, and goes sick and miserable to bed. His companion (so far as his sympathetic heart allowed) has meanwhile been drawing in delight at every pore, keenly enjoying the tussle with the waves or the stride across the heather, with an eye that (like Wordsworth's) finds no hairbreadth of earth, sea, or sky from which it does not gather delight, ready at any moment to turn aside and delay the end of the journey in order to increase the enjoyment of its progress, conscious indeed of keen hunger, but conscious of it rather as a prospect of future pleasure than as a present experience of pain; and when at last he finds himself opposite his victuals, a harmony is established between the organism and the environment which almost rises to the dignity of a spiritual experience. The less fortunate of these travellers derives the maximum of suffering and the minimum of enjoyment, the other the minimum of suffering and the maximum of enjoyment, from the necessity of taking food. The one is the victim of a craving; the other has a capacity for enjoyment. To the one it is agony to be thwarted, and only a negative satisfaction to be humoured; to the other privation is no pain, but a supply "adds sunshine to daylight."

The wise or happily constituted man has a mind so regulated that many of his desires only become rampant as

the prospect of satisfaction approaches. Till then they are dormant potentialities of enjoyment. Thus the man who on coming in sight of a public-house declared that he "had a thirst on him for which he would not take £5" was perhaps to be congratulated if he had been thoroughly happy before he saw it; but if he had been miserable himself and a cause of misery to his companions for the last hour or two because there was *not* a public-house in sight, he was an unenviable person as well as an undesirable companion.

What, in the instances we have given, may be regarded at any rate primarily as a difference of physical constitution has all manner of analogies in acquired habits of mind and body; and every wise man would desire for himself and others such habits and impulses as would conform to the happier type. Now, though all means or opportunities of gratification seem to have this in common, that the immediate effect of successive increments is (after a certain point) of declining positive value, yet different kinds of gratification differ enormously in their after-effects upon the organism itself. Is our present enjoyment building up an increased capacity for future enjoyment? Is it leaving us permanently unmodified, so that after a time we shall return to exactly the same state in which we were before? Is it undermining our power of future enjoyment, so that after every act of indulgence we return not to the same, but to a lower power of enjoyment than we had before? Or is it substituting a craving for a capacity for enjoyment?

Building up capacities for satisfaction, or desired habits and impulses.

The characteristic of ruinous enjoyment is that it not only tends to satisfy us at the time (as do all enjoyments), but that it also tends to undermine our capacity for future enjoyment. The most pronounced forms of ruinous enjoyment are probably those which are popularly regarded as vicious, such as intemperance. The characteristic of a vice, from a hedonistic point of view, is that it tends to replace a capacity for enjoyment by a craving. Intoxication may be extremely delightful, but the more habitually a man drinks, the less pleasure it gives him to be drunk and the more pain it gives him to be sober. He begins, perhaps, by hitting on a means of heightening enjoyment; but he ends by being

Ruinous satisfactions and vice.

in a state of chronic misery, from which he gains occasional respite in an intoxication which no longer gives him any positive pleasure. His whole conscious being has been swallowed up in the vortex of one frightful and incessant craving. This is a typical case of ruinous enjoyment. I am not here concerned with any attempt to analyse the ultimate grounds of the reprobation implied in the terms "vicious" and "vice," but it is interesting to note that the popular moral judgment stands in intelligible relation with the results of a hedonistic calculus. And note that our diagrammatic method gives us no notice of this change from a source of pleasure to a craving. Diagrammatically the appeasing of a craving is indistinguishable from the securing of a satisfaction; and if the acquired craving is more imperious than the natural desire for pleasure originally was, we should have to represent the change by an increased height of the curve indistinguishable from the representation of an increased capacity for enjoyment.

But there are many enjoyments which, so far from producing a vicious craving, rather tend to beget a sense of satiety, or even disgust, unless kept within very moderate limits. The danger here is not of converting a possible source of enjoyment into a craving, but simply of deadening by indulgence the susceptibilities from which the enjoyment springs. For example, most people enjoy a little salmon occasionally, and are inclined to regard it as something of a treat; but it is pretty generally known that, if used as a staple food, salmon very soon loses its charm. The provision long customary in the indentures of apprentices, that they must not be required to eat salmon more than so many times a week, is the historical record of this fact. Salmon therefore could not well take the place of the Englishman's traditional rasher of bacon as the breakfast dish for all the year round. It seems to be a fairly general experience (though of course by no means universal) that you may eat fried bacon for breakfast whenever you are inclined to do so, and may continue to be so inclined day after day and year after year; whereas if you were to eat salmon whenever you were inclined to do so, you would very soon cease to be inclined to eat it at all. The appetite for bacon, then, when extinguished for the moment, rapidly recovers its pristine

Wasteful  
satisfactions  
and luxury.

vigour; whereas the appetite for salmon, unless it is allowed a long period of recovery, becomes permanently lowered or deadened. If a man, though eating salmon as often as he feels inclined, does not eat as much at a time as he is inclined to do, the effect may be deferred. But even so, salmon will soon cease to be much of a treat.

Again, a man is not likely to eat oatmeal porridge for the pleasure of the palate when the appetite (as an index of an organic demand of the system) is assuaged; whereas the skilled cook, "by successive intensifications of his diabolical art," may tempt a man from excess to excess by appeals to his palate, even when his appetite has long been sated. Now

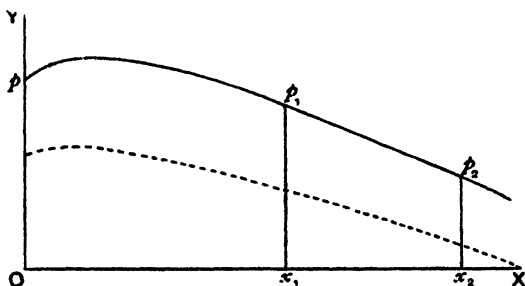

FIG. 6.

healthy and vigorous persons who are accustomed to simple and frugal ways are perhaps conscious, or subconscious, on most days that they would enjoy a rather more elaborate diet than they are accustomed to. But every one who has had experience of the two ways of living will tell us that those who live with severe simplicity get more enjoyment out of their meals than those who have an elaborate dinner every day. It is very easy to see why. The man who tries to extract the maximum of sensuous satisfaction out of every meal is securing trifling increments of satisfaction at the margin to-day, and is thereby deadening his capacity for enjoying the more significant increments nearer the origin<sup>1</sup> to-morrow. He is not indeed substituting a craving for a source of satisfaction, but he is lowering his possibilities of satisfaction. Thus, if a man has a moderate supply of any such luxuries as we have been discussing, his enjoyment may be represented by Fig. 6.

<sup>1</sup> "Origin" is the technical term for the point marked O in all our figures.

He stops at  $x_1$ , and there are still unexhausted possibilities of enjoyment. But if he habitually goes on to  $x_2$ , though at first he secures the additional area of enjoyment  $x_1p_1p_2x_2$ , yet he gradually lowers the significance of the initial increments, and ultimately only enjoys the smaller area bounded by the dotted line above  $Ox_2$ , instead of the larger area  $Opp_1x_1$ . Again, the man who eats or drinks as soon as he is inclined to do so, often falls into the habit of eating and drinking as soon as he is able to do so; and, as he never recovers a state of healthy hunger, he too always remains at the low level of enjoyment.

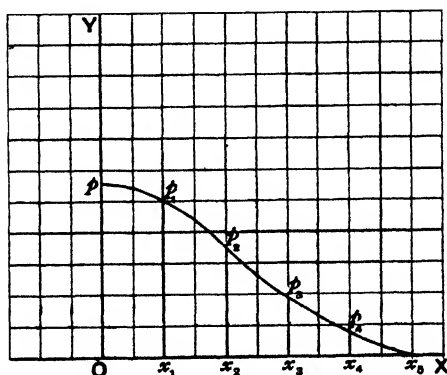

FIG. 7.

Let us take another illustration. Some moderate smokers will declare that a pipe two or three times a day gives them great satisfaction, but that they do not miss it, in the sense of feeling any positive discomfort, if for any reason they are deprived of it. For the time being a single pipe completely exhausts the possibility of enjoyment, so that they would find no pleasure in further smoking. Let Fig. 7 represent the total pleasure, declining from the initial point of intensity to the point of complete satisfaction.

It is obvious that after a pipe has extinguished the present possibility of further enjoyment a certain time must elapse before it is recovered; and it will not be recovered suddenly. Let us suppose that after an hour the area of possible enjoyment  $x_4p_4x_5$  has been recovered; that is to say, the man is in the condition in which he was when he had smoked four-

fifths of his pipe. He may now enjoy a cigarette that contains one-fifth of a pipeful of tobacco as much as he enjoyed the *last fifth* of his pipe; and if he repeats this every hour he enjoys five times the area  $x_5 p_5 x_5$  in the course of five hours. Whereas if he had not smoked for five hours he would then be just where he was before he smoked his last pipe and could enjoy the whole area  $O p_5 x_5$  again.

We have seen that our diagrams do not distinguish between the assuaging of a craving and the conferring of a positive satisfaction, and that in many cases the earlier increments of a commodity may perform the first function, and the later increments the second; and, moreover, that the two may overlap. In the case of smoking it is possible, though not usual, for a man who enjoys it to be able to abstain completely from it without positive suffering. In the case of food or drink this is impossible. Thus, if a man had a suitable allowance of food and drink, he might divide it up into a number of rapidly succeeding nibbles and sips (like cigarettes), or he might take larger portions at longer intervals. It would seem that in such cases the man who does not allow his organism time to recover its full sensitiveness to pleasure before he endeavours to extract renewed enjoyment out of it, and the man who pushes abstinence to the point of positive pain and craving before he assuages it, supposing them both to eat the same amount, would be alike wasteful in their administration. The man who lets his organism recover its power of yielding enjoyment without inflicting positive suffering on it (or, if the two states overlap, goes back to the point at which the pain incurred and the pleasure secured just balance) is administering his resources to the best advantage.

Self-indulgence and asceticism.

Note here again the extreme care that must be taken in the use of diagrams. If our curve in Fig. 7 represented the value of successive increments of any commodity per month (as in the case of tea in Book I. Chap. II.), or per year, or per day, it would take no note of the different effects of the same rate of supply differently distributed within the period in question, which is the problem we have now been discussing. Some system as to this internal distribution is tacitly assumed (as it was in our former tea problem) as constant during the

whole inquiry, or as modified according to some consistent system as the supply contracts or expands. This is as it should be, for whatever particular condition we are examining and are supposing to be subject to variations; it must always be assumed that the other conditions are constant.

To return to our main inquiry. We have seen that certain kinds of enjoyment, and certain habits of consumption, while apparently innocent in themselves, are eminently wasteful from the hedonistic point of view, either because they more or less permanently deaden the keener powers of enjoyment, or because they never give those powers the opportunity of recovering themselves. And yet deliberately to stop eating salmon when you would like more, in order that you may be able to get more pleasure out of a help of salmon this day week, is a piece of self-conscious sybaritism from which the healthy mind revolts. Even the man who will not eat when he is hungry and has suitable food before him, for fear of "spoiling his appetite" for a more sumptuous repast which he expects in a couple of hours, fails to excite our admiration. We seem then to be in the presence of a kind of waste against which it is impossible to provide without unworthy attention to appetites that are only wholesome so long as they are unreflective. And so indeed we are. But our analysis has resulted in a triumphant vindication of certain instincts which we may henceforth trust more completely, and which, if we follow them, will effect the desired saving and give zest and vigour to life, without any habitual self-consciousness. Luxurious living has always lain under suspicion as hostile to a vigorous life, as something which, if not absolutely culpable, deserves a certain disapproval, and moreover as self-defeating even on its own chosen ground of physical enjoyment. Self-indulgent habits which, on the face of it, only seem to open up innocent sources of enjoyment are nevertheless regarded with a certain contemptuous impatience by healthy and vigorous minds. The man accused of self-indulgence retorts on his critic with a charge of asceticism; and his mentor, while repudiating the charge, often finds it difficult to defend by logic the position to which he is guided by an obscure instinct. But that obscure instinct, we now see, is perfectly sound, and it warns us against

forms of enjoyment which, if not viciously ruinous, are yet wasteful.

We seem now to have got at something like the philosophy of it. The self-indulgent person is perpetually nibbling and never giving himself the chance of a hearty meal. The ascetic is always cutting back to the point at which the potentiality of a satisfaction passes into the realisation of a pain. And both alike debilitate their frames, and unduly concentrate their minds upon material sources of satisfaction. For, be it observed, persons who have practised genuine asceticism (as distinct from persons who by nature or training have become indifferent to what most men enjoy) will generally tell you that they were never so greedy in their lives as when they fasted severely; and perhaps that they have never quite recovered from the effect of the practice. A sufficient effort of will, or a strong enough preoccupation, may extinguish or indefinitely suspend a craving, but to maintain a want at the stage of craving, without extinguishing it, is to fix the mind upon it. Hence many curious parallels in the moral effects of luxurious and ascetic living; and hence the justification of the instinct for a robust and simple life that shuns both.

We can now fully understand the recognised failure of all elaborate attempts to make life enjoyable by luxuries. A rich man trying really to enjoy himself in the midst of his wealth often suggests a man attempting to bathe in his Sunday clothes. He cannot feel the sweep of wind and water over his limbs. Hence the genuine but futile wail of persons surrounded by luxury, hence their craving for the "simple life," and their restless longing to break away from their surroundings and to put themselves into circumstances where money positively will not command any but the simplest supports of life. Only so can they get into contact with the initial satisfactions which are reserved for those whose nerves have not been deadened and blunted by being called upon to respond to fresh supplies before they have recovered from the last, or to seize a little more excitement at the margin to the detriment of their tone at the origin. There can be little doubt that those who constantly go without things, not

Hedonistic  
value of a  
simple life.



because they do not want them, but because they cannot get them, and who have an unfailingly abundant supply of nothing but a few simple things, selected by experience for their staying qualities, get more physical enjoyment out of life, and a larger amount of physical delight out of their contact with things, than all the devices of luxury can secure. And, very happily, this mode of ordering life, with all its invaluable reactions, may be maintained, when once deliberately embraced, not by thinking but by not thinking about it. The man who cares most for other things will act with the greatest wisdom in these matters; and he will instinctively form habits, or, if you like, contract prejudices, which without self-consciousness will secure the best fruits of reflection.

This question of self-consciousness enters closely into another problem, which has to be faced in all housekeeping above the lines of poverty and below the lines of luxury. We have seen that "second helps are never so good as first," and it would seem to follow that there is a *prima facie* gain (under the reserves indicated on pages 82 *sq.*) in having no second help to-day, but another first help to-morrow or this day week. That is to say, if green peas or new potatoes (in themselves, let us take it, of the "staying," not the "cloying" order of commodity) are a treat which cannot be indulged freely, it would seem to be better to have a little often than a great deal seldom. And many housewives follow this line. But it is by no means above challenge. Children who are habitually stopped at the first help when they keenly desire more will almost certainly become greedy, if the reason given for stopping is that they may have the rest to-morrow; whereas if they had sometimes had as much as they wanted, and none at other times, they might have remained healthily animal. And so we are back again at the point which we encountered early in our inquiries.<sup>1</sup> We may pay too heavily for securing the best possible administration of certain defined resources in their application to their immediate purposes. On the whole, may we not say that the popular instinct regards as the most desirable life one which is simple to the verge of severity,

The perfect  
Epicurean.

<sup>1</sup> See pages 21, 82, etc.

but which allows a certain amount of variety, and prefers long or even complete and permanent abstinence to stinted and watched indulgence? Bread and water, Epicurus declared, were good enough for him; but for all that he would like a bit of cheese, so that he could have a blow out when the fancy took him. We may be sure that when he did have cheese he liked to have plenty. I once heard of a servant girl who every year bought and cooked for her single self a peck of green peas. She said she liked to "have her fill o' peas" once a year, and when that was accomplished she was in a state of equilibrium for the rest of the season. She was a true Epicurean.

As far as material indulgences are concerned, then, the instincts of popular moral judgment condemn the most ruinous forms of enjoyment as vicious, regard less ruinous but still wasteful forms as undesirable, if not exactly culpable, and look askance at too scrupulous attempts to economise and maximise enjoyment, as savouring of self-conscious materialism and wanting in directness and robustness. The man who so orders his life that, with small or great variety, he periodically pursues his enjoyments down the slope of diminishing returns to a point determined by his general resources and the claims upon them, but never dulls his capacity for periodical renewal of them, escapes the censure of the most rigid moralist. He is "living the simple life."

But there is another kind of satisfaction, the indulgence of which positively increases the capacity for future enjoyment. The man who enjoys himself in such ways as neither to reverse nor to destroy nor merely to maintain, but to increase his hedonistic capacity, gets a curious kind of credit for his conduct. Intellectual, literary, and artistic enjoyments (to those who really enjoy them) belong to this class. Most of them demand at some period or other a certain more or less painful effort and discipline. Probably no one can get the highest and most sustained form of enjoyment out of literature without a considerable amount of drudgery of one kind or another; and the same is true of art, and at least equally so of science. Even exercises or studies which are in the main enjoyable must often be

Capacities  
for enjoy-  
ment which  
indulgence  
develops.  
Painful  
training of  
capacities.  
"Superior"  
tastes.

pursued all down the scale of diminishing returns of satisfaction until they cease to give any pleasure at all and become in various degrees painful, if we are really to make anything of our studies. Some wise man (is it Ruskin?) has said that if we wish to do our best we must never work against the grain, but if we wish to do better than our best we must often go on when the work is irksome. We shall spoil it, but next time we shall do better than our former best.

Now this kind of gratification, sometimes merely pursued past the point of enjoyment, sometimes associated with painful training or irksome preparation, but always tending to create an increasing fund of possibilities of enjoyment, is regarded by the popular instinct as "superior." We speak of people who cultivate such sources of satisfaction as having "superior tastes." The slight half-veiled contempt for the "superior" person that we can often trace is apparently due, partly to a doubt whether he really does enjoy his superior pursuits, and partly to a suspicion that he may be starved into them by the lack of a wholesome and vigorous appetite for the robuster enjoyments of his neighbours. Lady Jane Grey appeared to prefer reading Plato to hunting and hawking; but did she really prefer it, or did she only wish to prefer it, or wish to be thought (by herself and others) to prefer it? And if she did prefer it, was it because she got more out of Plato or because she got less out of hunting and hawking than the others did? Was it the presence of a faculty they had not, or the absence of a faculty they had, that made her choice differ from theirs? Our respect for "superior" tastes when they are genuine is shewn by our extreme desire that the "working-man" should contract them, by our distress if more fiction than history and science is taken out of our public libraries, and our willingness to bear a part of the expenses of lectures on "superior" subjects—for others to attend.

Roughly speaking, these more fruitful enjoyments seem as a rule to be less exclusively and often less directly connected with the senses than the neutral or ruinous enjoyments are. It is true that the eye and ear are directly concerned in the enjoyment of music or of art, but the element of intellectual analysis and judgment, and, far more, the element of imaginative and emotional association, play a preponderating part

in them. In the enjoyment of literature or of scientific investigation the place of the senses is still more subordinate. Now it is generally regarded as an axiom that mental and spiritual enjoyment is of a higher order than the enjoyment of the senses, and it is interesting alike for those who are, and for those who are not, prepared to receive such a judgment as axiomatic, to note that at any rate it finds itself, like the other moral judgments we have examined, in easily traceable relations with the hedonistic calculus.

But the coincidence is not quite complete. For capacities that can be developed and rendered fruitful, perhaps at the expense of initial pain, sometimes yield material, not spiritual or intellectual satisfactions. They are then on a level with "superior" satisfactions hedonistically. But the moral judgment declines to consider them "superior." The process of learning to smoke wakes no moral enthusiasm even if it results in a power of enjoyment free from any vicious or wasteful craving. Having the ears pierced for earrings, in the old days, was only regarded as really praiseworthy by those who thought it a woman's first "duty" to make herself attractive. No one gets moral credit for what has been called "the long and painful apprenticeship to the art of liking olives." We have got some light, I trust, in this chapter on the relations of instinctive moral judgments and the results yielded by a hedonistic calculus; but it is far from my own belief that the one can be completely resolved into the other. This last set of instances may serve as a warning against any such belief.

The relation between popular moral judgments and the result of a hedonistic calculus.

The tendency, not fully accounted for by hedonistic considerations, to attach a note of intrinsic inferiority to pleasures of the sense is curiously illustrated by the case of connoisseurship in wines. If an interest in wines and a delicate judgment of them is combined with strict moderation it presents many of the qualities of an artistic enjoyment; and the old-fashioned elaborate conversation about wine presented a curious analogy to the discussion of the merits, say, of pictures. Yet to have given such close and earnest attention to things of sense suggested a more or less material view of life. Hence a somewhat confused feeling. Connoisseurship in wines seemed

in itself to belong to a "superior" order of enjoyments, but by its associations and suggestions, to an "inferior" order; and accordingly it often provoked in the mind of the impartial outsider curiously mingled and conflicting feelings, now bordering on contempt, and now rising to something very like respect or even envy.

It will hardly have escaped the reader's notice that our examination of the reactions of different enjoyments upon the organism, and especially the section on the waste-fulness of enjoyments of the intrinsically cloying order, or enjoyments carried to the cloying point, has been a running commentary on the dangers of civilisation and of increased command of material comforts. If wisdom does not grow with power, our latter state, even from the material point of view, may well be worse than our former, as material wealth increases; and the action of the economic forces, unguided and unchecked, naturally favours the growth not only of a class of ministers to vice, but of a class of persons who live by enabling people to get another drop out of the squeezed orange of to-day's capacity for enjoyment, reckless of its reactions upon to-morrow. And further, it will be seen that the "simple life" comes, if at all, rather incidentally as a natural result of caring for worthy things than as an object self-consciously aimed at for its own sake. The remarks on pages 186-189 may be re-read in the light thrown on them by this chapter.

Nothing that has been said in this chapter must be taken as committing the author to a hedonistic theory of ethics.

**Hedonism** Suppose a man deliberately desires to cultivate not involved in our general principles. impulses, and to train himself to a sense of values which he does not expect to give him the maximum of personal happiness. Suppose there are things that he really does care for more than his own happiness, or impersonal objects that he wishes he did care for, and hopes he one day will care for, more than for his personal enjoyments. Such a man would endure suffering, sacrifice pleasure, and fight against many of his impulses, in order to secure a permanent set or habit of will and a firmly established scale of values which could only be justified by reference to some social or religious test. These purposes would have secured his loyalty,

but not on the ground that they promised to secure his happiness. But the formation of such habits and the cultivation of such affections would, in this case, be the man's active desire, for whatever reason; and he would sacrifice the gratification of other desires in pursuing it. His self-discipline and his renunciations would be, from our point of view, of the same order as those of the man who undergoes irksome discipline for the sake of acquiring a hedonistically valuable taste, though he would not be moved by hedonistic considerations. It is not my purpose, however, to discuss ethical theories, but merely to shew that the general principles on which our investigations are based, while throwing light on the hedonistic calculus, do not presuppose a hedonistic theory, but are equally applicable to any other.

I will conclude this chapter with a few additional notes on the nature and limitations of the diagrammatic representations we have used. They may be best regarded as attaching themselves to the examination of roused and dormant desires on pages 422, 423. A large number of personal curves probably rise for some time before the ordinates reach their maximum and begin to decline. The matter is a little difficult to decide, for it is not easy to keep it clear from the considerations, entered upon above, of changes in the ethos of the individual during any considerable period. But it may well be that the same man with the same tastes and capacities would be willing to pay a larger sum for, say, a second chance in the month of hearing good music than he would for the first, possibly more for a third chance than for a second (and then less for a fourth and fifth, and so on), not because his musical taste is improved, but because his musical appetite is roused. In any case, when a dormant capacity or desire is roused, or a mild one stimulated, an abrupt or early cessation of the means of satisfying it may leave us in a balked or aching state, which constitutes a pain in excess of the original sense of want or privation (hunger, or what not) which is as yet imperfectly relieved. It is possible that, starting with any given condition, and regarding relief from discomfort and positive pleasure alike as positive, the sudden arresting of satisfaction might leave a legacy of actual pain which would not be represented on our

Limitations  
of the  
diagrammatic  
method.

diagram; because the supply of the commodity has a positive value as long as it lasts, and would continue to have a positive value if it proceeded. Fig. 8 might give some kind of representation of such a case. It might mean that the man started from a state of indifference, but pursued some occupation or enjoyment with growing keenness, and derived a pure access of satisfaction as the appetite was at once roused and gratified. Up to the amount  $Ox_1$  he has secured the area of satisfaction  $Op_1x_1$ , and there remains an unexhausted possibility of satisfaction represented by the area  $x_1p_1x_2$ . But if the supply is now broken off, the unsatisfied desire continues and the satisfaction ceases. The result is a pain represented by the negative area

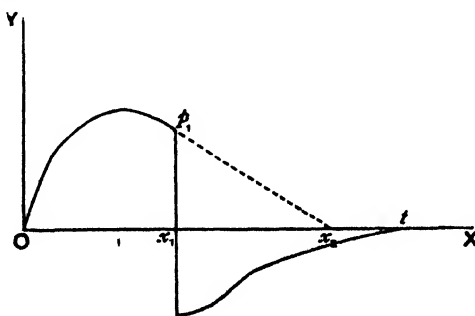

FIG. 8.

below  $x_1t$ . It is only after a lapse of time represented by  $x_1t$  that the pain wears itself out and the man returns to his initial state, having experienced both a positive and a negative satisfaction, the latter of which might in some cases be the greater. In such cases we say we had rather have had none of a thing at all than the tantalising amount we secured, even though we thoroughly enjoyed that little while it lasted. Fig. 8, however, is a monstrosity; for progress along the axis of  $X$  means increments of commodity up to  $x_1$ , and for the positive area above, up to  $x_2$ ; whereas for the negative area it means the passage of time from  $x_1$  to  $t$ . It is really two figures, and the units of area alone are common to the two.<sup>1</sup>

Returning to the phenomenon itself, we note that it may occur in every case of gratification arrested short of complete satisfaction. As a rule we may suppose that the lower the

<sup>1</sup> Cf. page 441, and the whole of Chap. II.

point to which we have reduced the ordinate the smaller will be this offset of dissatisfaction. And in a well-filled life it will often be absolutely eliminated; for although the lowest increment of satisfaction has not been squeezed out of some indulgence, and a theoretical sense of want might supervene if the next occupation or experience of the man were inherently neutral, yet if there is some other pleasant or desired occupation to which to turn, the anticipation of it substitutes eagerness for something else in the place of a languid desire to continue the present experience on the declining slope. Perhaps the best theoretical defence of smoking that has yet been discovered by the numerous and able advocates engaged in the cause is the assertion that it prevents listless and self-indulgent persons from over-eating, because when the keen demands of appetite have been satisfied but there is still enough left to dally with, the seductive prospect of a smoke turns the mind into another direction and offers a greater satisfaction from the arrest of the process of eating than can be gained from its continuance.

It is a fact pointed out and abundantly illustrated by the psychologists, that the very same present sensations may be pleasant or painful, according to the anticipations of the immediate future with which they are associated. The hunger that is a conscious pain, if the prospect of a meal is at all remote, may be a source of keen pleasure to the man who actually has his victuals before him, even before he has eaten the first mouthful. And in the same way the man who is accustomed to associate self-control with vigour, enjoyment of life, sense of command, and self-respect, may derive positive and immediate satisfaction from the absence, at the end of every meal, of that "sense of repletion" which in itself, according to Alexander Bain, is "massive and serene."

The conclusion of the whole matter, so far as our diagrams are concerned, is that it is generally an abuse of the diagrammatic method to attempt to make a curve represent, with any closeness, an isolated and concrete experience. A curve must represent the *estimate formed by the consumer* of the value to him of the successive increments of the commodity, and that estimate will be formed in view of all the immediate effects



and remoter reactions and implications which he is capable of appreciating. All these considerations therefore will tell on the height of the ordinates, which must be regarded as registering the resultant estimate. The anticipations on which they rest will perhaps never be perfectly justified; but as anticipations they have already made all the necessary discounts, and they need no kind of supplementing or correction. Declining ordinates mean that the consumer, taking at his own valuation all the considerations that can influence him, desires successive increments of the commodity with declining eagerness; and his estimates are based upon anticipations which are constantly being checked and modified by experience.

## CHAPTER II

### ON THE DIAGRAMMATIC METHOD OF REPRESENTING AREAS OF SATISFACTION AND MARGINAL SIGNIFICANCES<sup>1</sup>

**SUMMARY.**—*The method of representing economic phenomena by curves demands closer examination than we have yet given it, and turns out on inspection to present many problems both of interpretation and construction. The measurements on the axis of Y indicate limiting rates of marginal significance, and, while expressed in an objective rate-unit, they must ultimately rest on estimates based on psychic experience. Hence difficulties arise as to the relation between objective and psychic units, the possibility of keeping that relation stable, the meaning we are to attach to accuracy of estimate and the conditions which limit that accuracy. If we express the data of Book I. Chapter II. as to the significance of tea in the form of a tea curve we are led to examine (a) the implications of the special formula to which our data conformed, and (b) the possibility of any simple mathematical formula approximately representing the facts. An attempt accurately to interpret the curve further leads us to distinguish between a curve of total satisfaction and marginal significance on the one hand, and a curve of price-and-quantity-purchased on the other hand. We find that these curves can, at best, only coincide approximately, and that an individual curve purporting to represent both series of phenomena can theoretically only be a "temperamental" compromise.*

In the preceding chapter I have represented satisfactions

<sup>1</sup> Chapters II. and III., though important from the theoretical point of view, are of an abstract and somewhat academic character, and some readers may prefer to go on at once to Chapter IV.

by areas bounded by curves, though with the express reservation that this procedure raised questions and required explanations upon which it was not convenient to enter at the time. We will now proceed to a more careful examination of this method. We shall frequently employ it hereafter.

The representation of a given satisfaction by an area of any kind, whether rectilinear or curvilinear, involves by implication the conception of a unit to which different satisfactions can be reduced, and in which they can be expressed for diagrammatic comparison with each other. And though this idea is far from familiar and presents great difficulties when first expressly suggested to the mind, we have nevertheless seen that it is directly implied in all our practical dealings and deliberations; and it underlies all the investigations upon which we have hitherto been engaged. For to say that two things are of equal value to us, and that another thing is just as valuable to us as both of them put together, is to say that the latter is worth twice as much to us as either one of the former, or that we anticipate a satisfaction twice as great from the one as from either of the others. If we say that a thing is just worth a penny, we are thereby equating the satisfaction we expect it to yield with all the other satisfactions which we believe a penny would secure at the margins of other branches of expenditure, and if we went on to say that something else was worth exactly three shillings and not a penny more, we should be saying that we expect it to yield as large a satisfaction as any thirty-six things we could get for a penny each, or a satisfaction thirty-six times as large as that which any one thing just worth a penny is expected to yield. Now it is quite true that such estimates are often vague, and almost casual, and that they are subject to every kind of fluctuation and inconsistency; but every deliberate act of choice, or of administration of resources, is an attempt to make them more precise and consistent; and even an impulsive choice is a declaration that at any rate one thing is more valued by us than another, and this involves an act of quantitative comparison. Such as they are, these choices, impulsive or deliberate, are verdicts as to comparative volumes of satisfaction, considered

as magnitudes, and they often express themselves in units of pence and shillings.

Now all commodities, services, or opportunities that enter into the circle of exchange are ultimately estimated not as physical or objectively measurable magnitudes, but as sources of anticipated satisfaction; and we frequently estimate things that are not in the circle of exchange in terms of things that are, and constantly choose between things that are and things that are not in this circle, weighing them against each other. Thus it is clear that for each one of us, at any given moment, the ordinary conduct of life unmistakably implies and involves the conception of satisfactions as magnitudes, and therefore as expressible ideally in units, which may be represented diagrammatically by unit lines, or areas, or otherwise, as suits our convenience. And just as, in measuring and comparing lengths with a view to determining their relative magnitudes, it does not matter whether our unit is an inch, a metre, or a mile (the difference being only in the numerical expression of the results obtained, not in the results themselves), so it is of no consequence whether we take our unit of satisfaction as that represented by 1d. or that represented by £1. But in comparing different satisfactions, expressed as areas, we must always remember that to be comparable as magnitudes the satisfactions must be estimated by the same person. With these reservations we may now proceed to the diagrammatic representation of the estimates dealt with in the second chapter of Book I. and generally to the interpretation of curves of total and marginal satisfaction.

We may take (arbitrarily) a small square on the ruled paper of Fig. 9 to represent one-quarter of the satisfaction anticipated from the expenditure of a farthing. Then four squares will represent the satisfaction corresponding to a farthing, sixteen squares that corresponding to a penny, and  $12 \times 16 = 192$  that corresponding to a shilling. Any rectangular or curvilinear area, irrespective of its shape, if equal to 192 small squares would then represent this shilling volume of satisfaction. It might, for instance, be a rectangle with a base of 1 and an altitude of 192, or one with a base of 16 and an altitude of 12.

Taking a side of a small square as our linear unit, let us

now agree that the unit length (not area) measured along any base line shall represent a periodic (monthly or as otherwise defined) supply of one ounce of tea, and a base of 16 such units a supply of one pound. We can now represent diagrammatically any of the data as to tea which we assumed in Book I. Chapter II. For instance, the fourth pound was expected to yield a satisfaction equal to the significance of 8s. in any other application. This would be represented by an area of  $8 \times 192$ ; and as we have agreed that a basis of 16 shall represent a pound, a rectangle of base 16 and altitude  $8 \times 12 (= 96)$  will be the proper representation of the satisfaction anticipated from the consumption of the fourth pound per month (Fig. 9 (a)). But of this fourth pound we saw that the first half was estimated at 4s.  $5\frac{1}{4}$ d. and the second at 3s.  $6\frac{3}{4}$ d. These values would be represented respectively by rectangular areas containing 852 and 684 small squares, and since the basis of each would, by our convention, be 8 (corresponding to  $\frac{1}{2}$  lb.), their altitudes would be respectively  $106\frac{1}{2}$  and  $85\frac{1}{2}$  (Fig. 9 (b)). We can now interpret units of altitude. They will not signify positive quantities, as the units of the base do, but penny rates of satisfaction per pound of the commodity, or halfpenny rates of satisfaction per half-pound, and so forth.

Now, taking *ad* in Fig. 9 (b) at an altitude of 96 as in Fig. 9 (a), it is obvious that the rectangle *ab*, which is added to the original rectangle at the left, is equal to *cd* subtracted from it at the right, since the total area of the two differentiated rectangles is to be exactly equal to that of the integral rectangle that represents the satisfaction yielded by the whole pound; and we may suppose that this differentiation between half-pounds, quarter-pounds (or any other fractions, for it is not necessary to proceed by bisection of a pound rather than trisection, for instance), may be carried as far as we choose. The area of any succession of differentiated rectangles will always remain equal to that of the integral areas that present them collectively as a single magnitude. In Fig. 10 let us carry out this process to different degrees of advancement for the different pounds; and let us draw a curve such that in the case of the small and the large rectangles alike it always adds on an area to the left equal

to that which it cuts off to the right, so that for any base the area bounded above by the curve shall be exactly equal to the rectangle standing on the same base. Such a curve may be regarded as integrating any number of contiguous rectangles which we choose to take in succession. That is to

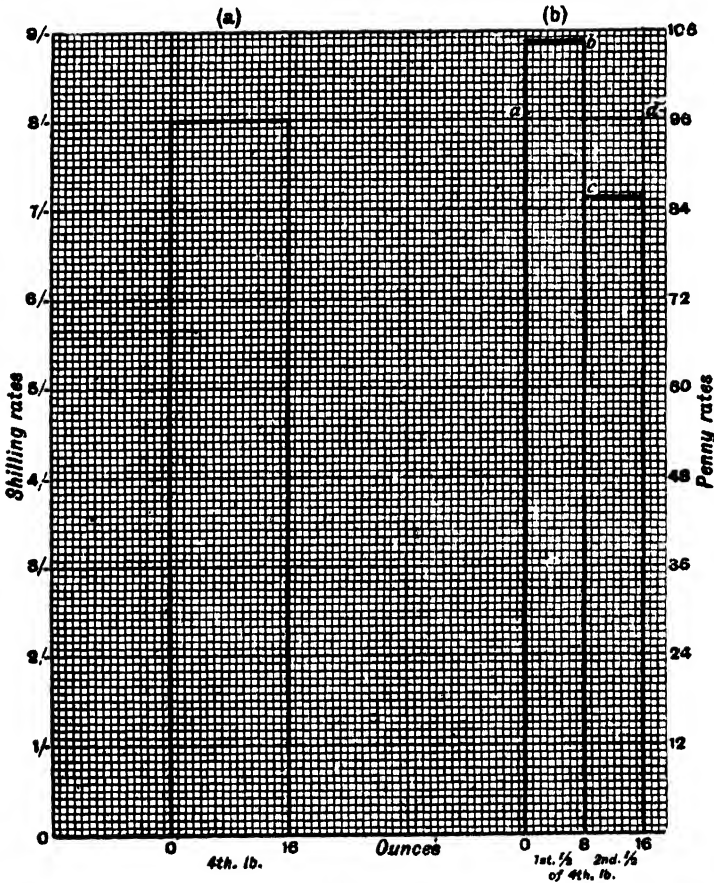

FIG. 9.

say, the area intercepted by the curve above any line measured along *OX* will be exactly identical with the area contained in the whole series of rectangles standing upon the same base.

This is a curve of total satisfaction, and its meaning is now obvious. We have seen that ideally, and in the limit, the significance of any commodity is a magnitude continuously

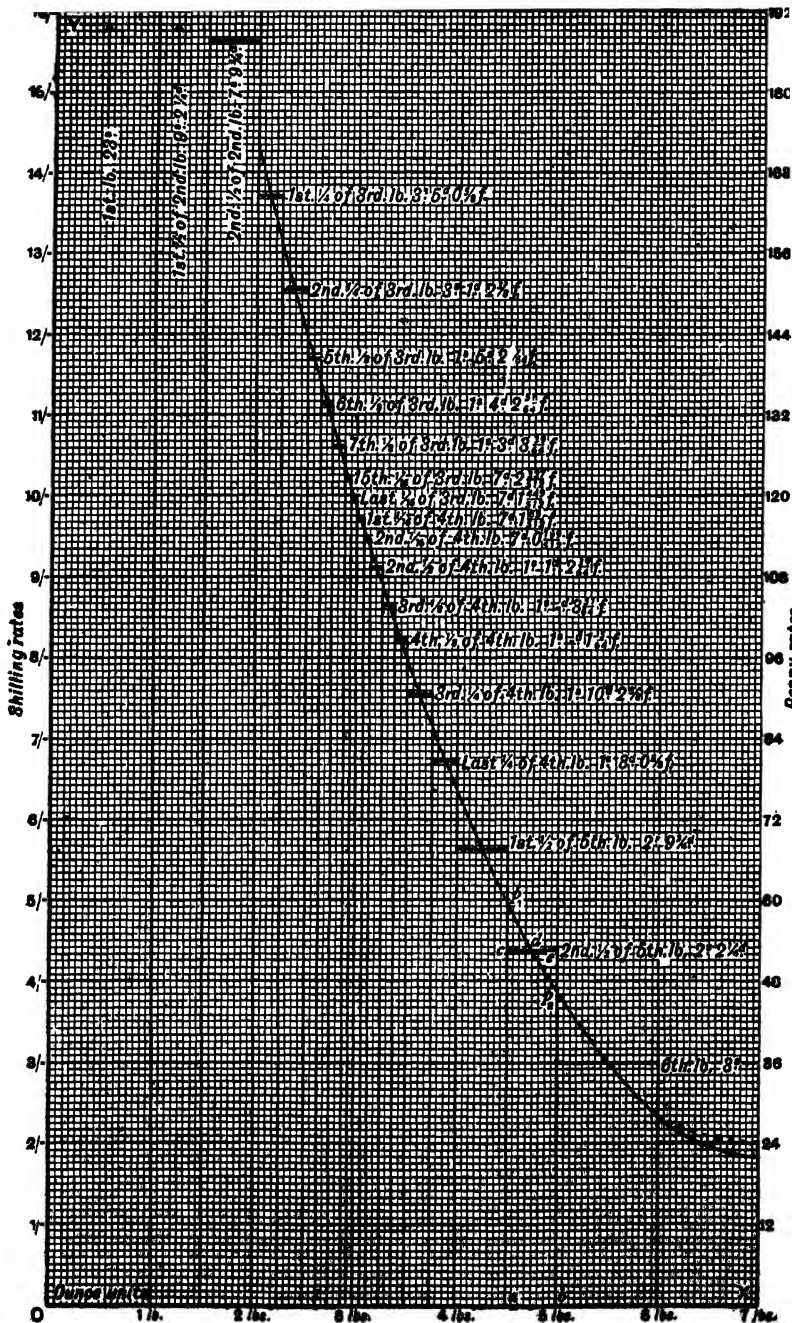

FIG. 10.

changing as we recede from the origin, so that, however small the increment we are considering, the change cannot be regarded as suspended during the progress of its consumption. The whole process, then, ideally considered, is properly represented not by a series of steps or discrete areas, however small, but by a curve-bounded space. Such a curve, could we obtain it, would give us at a single view the whole infinity of facts to be registered. If we take any portion of the weekly, monthly, or other periodic supply of a given commodity (whatever our conventional units may be), *e.g.* the third unit, or the quarter of a unit between  $7\frac{1}{2}$  and  $7\frac{7}{8}$ , or generally the portion represented by the line  $ab$  on the axis of  $X$  (Fig. 11), then the curve is constructed so as to bound an area,  $ap_1p_2b$ , exactly representing the satisfaction anticipated from the consumption of the portion of the commodity represented by  $ab$ . And note that whereas in Book I. Chapter II. we directly assumed data as to pounds and binal fractions of pounds only, a curve assumes that we have all conceivable data, and can begin and end anywhere we like.

This continuity and entire accuracy of data is, of course, purely ideal. We may conceive approximations to it, but to imagine that any one could distinguish between the rate at which tea was ministering to his satisfaction at the beginning and at the close of his consumption, say, of the 7.9432th pound, and could express this difference in fractions of a shilling-per-pound rate, is an absurdity. Indeed the reader who has some tincture of mathematical culture will perceive that even an underlying assumption of commensurability between the satisfactions accruing from successive conventional units of the commodity and those represented by the conventional units of the currency is inconsistent with ideal accuracy. These reflections reveal at once the great convenience and the ingrained artificiality of the method of representing economic quantities by curves. The very nature of a curve is incompatible with the nature of the phenomena we are investigating; but it is of high value as an ideal simplification, and as a means of mentally arresting phenomena, which in their actual existence are unmanageably complex and fluctuating. If we professed in our diagrams to present possible or actual facts, we should have to undertake the hopeless task of



determining in each case what degree of accuracy might reasonably be assumed; whereas by frankly presenting the unattainable limit in every case we declare at once the ideal nature of our hypothesis and of our representation of it.

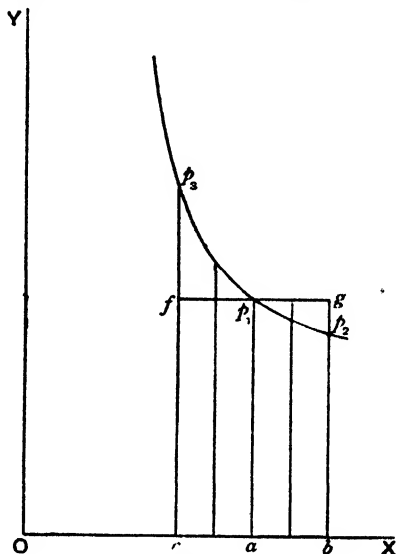

FIG. 11.

This being understood, the reader will have no difficulty (if he turns back to our investigations as to "limiting rates"

on pages 60 *sqq.*) in recognising the height  $ap_1$  (if he turns back to our investigations as to "limiting rates" on pages 60 *sqq.*) in recognising the height  $ap_1$  represent limiting rates of marginal significance. (in whatever unit measured) of increments or decrements of the commodity taken from the point  $a$ . For on considering the errors ( $p_3fp_1$  and  $p_1gp_2$  respectively) that would be involved in treating the areas above  $ab$  and  $ac$  as equal to each other and to the rectangle on base  $ab$  (or  $ac$ ) and with altitude  $ap_1$ , we shall find that they become smaller not only absolutely but proportionally to the areas themselves as we make the increments  $ab$  and  $ac$  smaller; and this without limit. For if we halve the lengths  $ab$  and  $ac$  and erect perpendiculars on them and then compare the rectangles on these bases, and with altitude  $ap_1$ , with the areas above the bases bounded by the curve, we shall see that

the error involved in treating them as equal is in each case less than half of the corresponding error for the wider basis. The proportion of error, therefore, decreases, without limit, as smaller bases are taken. Thus the height  $ap_1$  represents a rate of satisfaction per unit to which no increment or decrement taken from the point  $a$  ever conforms, as a whole, but which always lies between the rates proper to any given increment and to the corresponding equal decrement, and to which those rates approximate without limit as they decrease in magnitude. The units on  $OY$ , therefore, measure limiting rates of the significance of units of the commodity (per unit of time) as the increments are taken smaller. Or, in abbreviated terminology, the ordinates represent the marginal significance of the commodity for any given supply. So, too, in Fig. 10 the areas  $p_1cd$  and  $p_2ed$  respectively will be not only smaller, but smaller in proportion to the rectangles  $da$  and  $db$  as  $c$  or  $e$  approaches  $d$ .

We have now a provisional conception of what a curve of marginal significance would mean if we had it, and we may go on to the examination of the bearing upon the determination of the form of such a curve of any data we may suppose ourselves actually to command. Let us rule our paper, as in Fig. 10, so as to mark rectangles of base 16 and altitude 12. Returning to our example of tea, we may retain the significance of all our units, and for convenience may register successive pounds (each pound being 16 ounce-units) of supply along  $OX$ , and successive shilling-per-pound rates of significance (each being 12 times a penny-per-pound rate) along  $OY$ . Each large rectangle, containing 192 small squares, will indicate, as before, the area of satisfaction represented by a shilling.

It is obvious, to begin with, that any datum we may be able to obtain will give us some information as to the course of the curve. If we know, for instance, that the fourth pound of tea yields an area of satisfaction valued at 8s., we shall know that the curve must be such that the area  $ap_1p_2b$  equals the area  $ac$ , and the area  $p_1df$  equals the area  $fc p_3$ . (We shall express compliance with this condition by saying that the curve "satisfies the datum" of the area  $ac$ .) But there is an infinite number of curves that would fulfil this condition.

Construction  
of a curve  
of total  
satisfaction.

Some of them might bisect  $dc$ , and others might cut it at points indefinitely near to  $d$  or  $c$ , and they might intersect the verticals from  $a$  and  $b$  at any variety of points. But if we have the additional data that the first half of the fourth

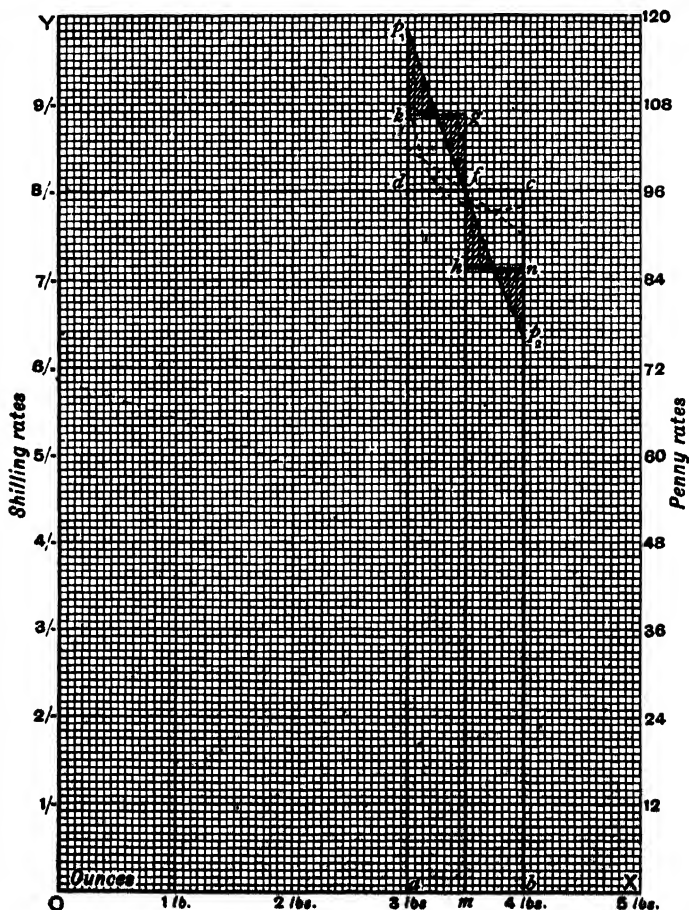

FIG. 12.

pound corresponds to the area  $ag$ , and the second to the area  $bh$ , many of these possibilities will be excluded, for the area which the curve adds to  $ag$  must equal the area it cuts off from it; and the same must hold for  $bh$ . The course of the curve, therefore, will be more closely determined by the two

rectangles  $ag$  and  $bh$  than by the one rectangle  $ac$ , which is equal to their sum. In our original hypothesis we supposed the estimates of successive pounds of tea to reveal an easily detected law which enabled us at once to calculate any smaller areas we liked to choose. This formula would absolutely determine the form of the curve, and tracing it would only be a matter of calculation. But if we assume no such property, and imagine each datum to stand alone and not to involve any derivative data (assuming only the general property of continuous decline, after a certain point, which we may take as fixed by the nature of our inquiry), then it is clear that the minuter the increments for which we can obtain estimates, the more closely can we determine the course of the curve. For instance, we have set out on Fig. 10 (page 444) a series of data as to pounds, half-pounds, etc., and we see that, *so far as they shew* (that is to say, apart from our knowledge that our formula would enable us to split up the larger rectangles as finely as we choose), there would be room to suppose that the curve undulated with considerable violence over the portion corresponding to the increment from 4 lbs. to 7 lbs., but that our data enable us to assert a more regular course for the portion corresponding to the increment from 2 lbs. 12 oz. to 3 lbs. 4 oz. Seeing then that if we have given any two contiguous rectangles of satisfaction,  $akgm$  and  $mhn b$ , the curve must always pass between the points  $g$  and  $h$ , it follows that if we could determine the areas corresponding to indefinitely small increments we could determine the position of the curve at any part of its course within indefinitely narrow limits; for just as we determine a point absolutely if we can determine any position we choose of points, that approach each other without limit, between which it lies,<sup>1</sup> so we can determine a curve absolutely if we can determine, as closely as we like, two mutually approximating points between which the value of  $y$ , corresponding to any given value of  $x$ , lies.

But here it will be well, for our security, to establish the fact that whereas (as we have just seen) a curve may satisfy the datum of a certain area, but may fail to satisfy the data of two smaller areas into which it can be broken up, it is

<sup>1</sup> See page 60.

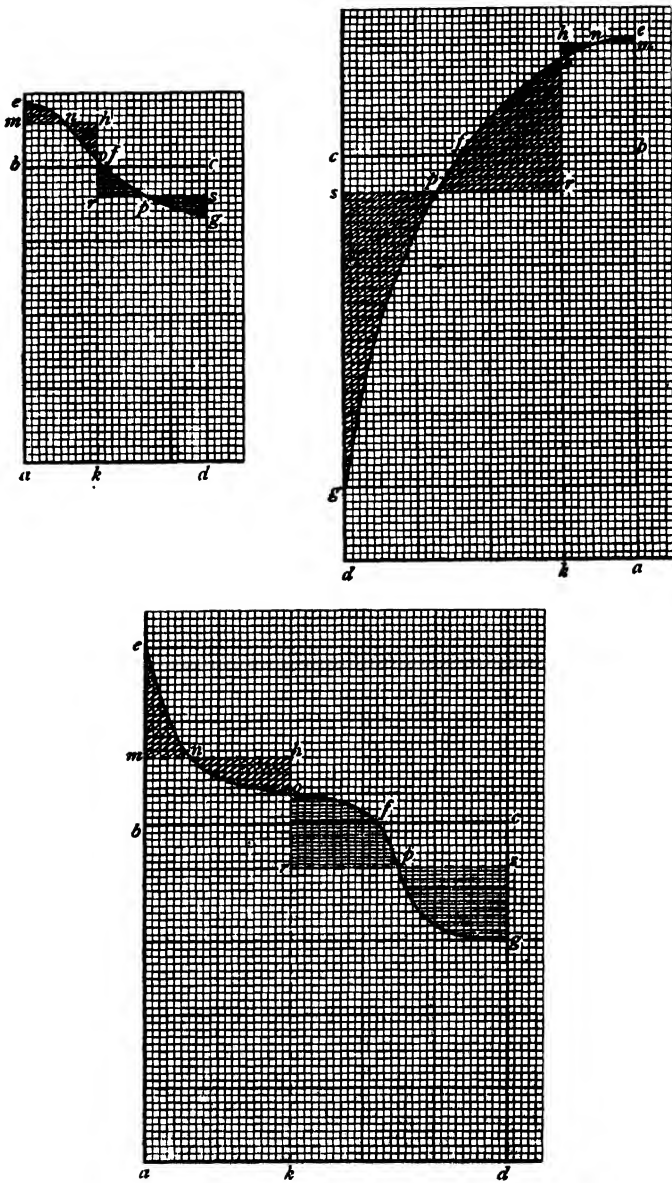

FIG. 13.

not possible for it to satisfy the data of two adjacent areas, severally, without also satisfying the data of the total area which is their sum. The general proof of this proposition, to which we will now proceed, applies to all the different forms of curve shewn in Fig. 13.

We start with the two rectangles  $ah$  and  $ks$  and construct a curve,  $enofpg$ , such that it adds and subtracts equally from each of the two rectangles. The equal areas we mark by oblique or horizontal lines respectively. There are, of course, an indefinite number of such curves; but if we construct an integrating rectangle,  $ac$ , by drawing a line,  $bc$ , that makes the rectangles  $bh$  and  $rc$  equal, the area which the curve  $enofpg$  cuts off from the rectangle  $ac$  will be equal to that which it adds to it—that is to say, the area  $ebf$  will equal the area  $gcf$ . Since we have  $emn = nho$  we may substitute the latter for the former, and we shall have  $ebf = bmhof$ . Again, since we have  $bh = rc$ , we can obtain by substitution  $bmhof = scfor$ . And since we have  $rop = psg$ , we can again obtain by substitution  $scfor = gcf$ . Therefore we shall have  $ebf = gcf$ . Q.E.D.<sup>1</sup>

Thus, if we have any series of rectangles arranged as in Fig. 10, on bases measured continuously along  $OX$ , a curve which adds to and cuts off equally from any contiguous pair of these rectangles, severally, will have the same property with respect to the integrating rectangle that is equal to their sum. The rectangle so obtained may then be substituted for the two rectangles of which it is the sum, and we may again integrate it with another rectangle, still relying on the same result, so that the curve will always add and subtract equally from the area of the integrating rectangle that sums any number of contiguous areas with the data of which the curve complies severally.

It is evident, therefore, that since we can always rely on the curve's retaining its fundamental property when we add together the data on which we build it, but never when we subdivide them, the accuracy with which we can determine it will depend on the accuracy and the fineness of the data on which we can construct it.

<sup>1</sup> This analytical proof is, strictly speaking, unnecessary; for since we have  $ah = aco$  and  $ks = kogd$ , we have also  $aeqd = ah + ks = ac$ ; and this involves the equality of  $bef$  and  $fgc$ . But the proof by substitutions may probably be found the more enlightening.

To what degree of approximation, then, can we hope actually to determine such a curve? Or, rather (since the question so put hardly admits of a definite answer), what are the principles which will determine the degree of approximation to an ideal curve that may be realised in any particular case? In the first place, let us consider the question of accuracy.

In the case of the tea curve, for instance, we have to ask what will determine or influence the limits within which we can reasonably suppose our housekeeper's estimates to be exact. But on the very threshold of this inquiry we are met by a grave difficulty. What do we mean by accuracy of estimate? If we are speaking of the estimate a man forms of the length of a stick, for example, or the height of a top-hat, we are speaking of something which can be tested by actual measurement. Thus if we say that a man can be trusted to judge a yard to within a quarter of an inch, we mean that if he declares such and such a thing to be exactly a yard long, or undertakes to measure with his eye a yard length from any given point, we shall find on testing it by standard measure that what he pronounces to be a yard will not be less than  $35\frac{3}{4}$  inches, nor more than  $36\frac{1}{4}$  inches. But what could we mean by saying, for instance, that you could rely on a housekeeper's estimates of the significance to her of such and such an amount of tea, under such and such circumstances, to a farthing? She is making an estimate, and if that is her estimate, what is the meaning of calling it accurate or inaccurate? Even if you try to bring it to the test of experience, and ask her afterwards whether her estimate is justified by the result, she can only tell you that it has or has not procured a satisfaction equal to what she now supposes she could have got by the sum she mentioned, if she had applied it otherwise; and this is itself an estimate. Though her estimates, therefore, are based on experience, and are checked and modified by it, yet no objective standard of experience can be kept for reference, or can be applied objectively as a check, like the standard yard.

Apparently, therefore, what we should mean, in the first instance, by saying that a housewife's estimates, under certain conditions, will be reliable to a farthing, would be something like this:—If we are dealing with estimates, as such (and not

with the experiences which might or might not correspond to them if the experiment were made), we shall find that they may be made in various ways. We might ask a housekeeper to say how much another half-pound of tea would be worth to her if she already had  $2\frac{1}{2}$  pounds, and then some time afterwards, when she had not that question and answer in her mind, we might ask her what half-a-pound would be worth if she had 3 pounds. Then again we might divide the amount into other fractions of a pound, thirds or fifths, and begin at some other base than  $2\frac{1}{2}$  pounds, but include the former area in our new inquiries. And finally, we might ask how much a whole pound would be worth if she already had  $2\frac{1}{2}$  pounds. Now if she answered all these questions independently, giving every answer on the strength of a direct estimate, without mental reference to previous answers, and if the answers when compared never revealed inconsistencies of more than a farthing in the pound, and if similar tests produced similar results wherever applied, we could say with confidence that her estimates were not mere guesses or random selections of prices or quantities on which her mind was accustomed to rest, but were direct and genuine quantitative estimates, accurate as estimates, and therefore consistent, to within a farthing a pound. Another test would be to present the same question at different times in such different lights or connections as to suggest different answers, and see whether such suggestions or associations influenced the answer.

This must be the primary meaning of accuracy and reliability of estimates as such. But behind this we may think of the correctness of the estimates as attempts to realise hypothetical experiences. We may have a clear and consistent idea of the value we should attach to such and such a supply of a commodity if we already commanded just so much of it and no more, and it may be impossible to shake that estimate by the most skilful cross-examination; but yet if the experience comes we may find that we had formed a very erroneous conception of it, and our estimates may be very different now from what they were when the experience was only hypothetical. Thus remoteness of the supposed case from experience may either affect the precision of our estimate as such, or it may make our estimate

Meaning of accuracy in estimates.



now (whether precise or vague) unreliable as a forecast of what our estimate would really be under other circumstances. These two things must always be distinguished in our minds, though it may not always be necessary to insist on the distinction in any particular context.

But yet again. It is impossible to banish the idea that as well as more or less imperfect estimates there are certain definite and ultimate facts to be estimated, and that faults or errors of estimate do not affect these ultimate facts. How can we get at precise conceptions in this matter? Clearly we are still dealing with subjective experiences and not with external magnitudes. But just as we know that many impressions are received by the eye but not consciously registered by the mind, so there may be many sensations and experiences that actually go to making us happy or strong or the reverse, but of which we are not conscious as causes, or which are in themselves so slight that we have not learned to pay attention to them. An ideally perfect estimate would identify every cause and register every effect, and would actually assign to all experiences the values they *would* have for us if we distinctly realised them. We can reach no conception more nearly approaching objectivity than this.

Returning now to our actual estimates as such, we may go on to examine some of the influences which make a greater or lesser degree of accuracy, in the sense of precision and consistency, possible in any given case. But it will be well at this point to develop a distinction that has already been made, though not emphasised.<sup>1</sup>

Accuracy is not the only valuable quality in our data, for we have seen that the curve which satisfies the minuter will always satisfy the broader data, and the minuter data determine the curve more closely than the broader. Minuter data of a certain relative inaccuracy might therefore determine the course of the curve more closely than the broader data of relatively greater accuracy. In Fig. 10, for example, we might suppose that the area of satisfaction corresponding to the sixth pound was given with great accuracy, but if we had no minuter data the curve might, for anything we should know, undulate in an indefinite number of ways, within wide

<sup>1</sup> At the bottom of page 451.

limits, over that portion of its course. We should have one accurate datum, but the course of the curve would be indeterminate; whereas we might suppose a considerably higher degree of proportional inaccuracy in our data at and about the end of the third pound, and yet be more certain that we had determined the course of the curve about that point within narrow limits. The relatively inaccurate data, because narrower, would exclude many possibilities which a more accurate datum, if broader, might admit. And, as we shall see, it may very well happen that the broader data are, as a matter of fact, proportionally more accurate than the narrower. In such a case the narrower data may be of service to us in determining the general course of the curve within the limits of the broader data, but owing to their relative inaccuracy in detail their summation might give results incompatible with the broader data, and in such cases we should be guided by them only in such a general way as is consistent with compliance with the less determinate but at the same time more accurate conditions implied in the broader data.

With this proviso we will proceed with our examination of the conditions favourable to precision and consistency of estimate. Some general remarks on precision in estimating objectively measurable magnitudes may precede our examination of the more evasive estimate of satisfactions as magnitudes.

We must not blink the difficulty and complication of this problem, or the fact that any general principles we can lay down will be subject to every kind of disturbance from the personal idiosyncrasies or the special experiences of the individual who makes the estimates. It will, however, be admitted that in estimating quantities of any kind, a given individual will have a range, or theoretically a point, of maximum accuracy. Take an observer whose experience, professional or other, gives him no particular guidance in the matter, and present him successively with two pieces of wire, one an inch and the other an inch and a half long; then, successively, with diagrams shewing spaces of  $\frac{1}{32}$  in. and  $\frac{3}{4}$  in. respectively, intercepted between fine lines. Then take him to a place from which he has a variety of views, and under conditions identical as to distance, angle of observation, and

so forth, ask him to notice the distance between the trunk of a tree and a boulder (known by you to be 1000 yards), and subsequently the distance between the edge of a tarn and the edge of a snow patch (which is 1500 yards). In each case ask him what proportion the first length in each pair bears to the second. You will probably expect a more accurate proportional estimate in the case of the inch and the inch and a half than in either of the other cases. Perhaps there will be some other length which he will be able to estimate more accurately still, but there will be some point, between the thirty-second of an inch and 1000 yards, in the neighbourhood of which his estimate will reach the maximum of accuracy. And as he recedes from this in either direction his estimate will become less reliable. It does not follow, however, in individual cases, that this departure from accuracy will be regular and continuous. There may be certain definite magnitudes which, for one reason or another, the individual has been accustomed to measure with unusual accuracy, and these may be irregularly distributed. Thus, if we take a carpenter who is also a professional cricketer, and who, when a boy, sometimes ran along a mile of road keeping pace with a stage-coach, and if we submit to him pairs of lengths which are really the same fractions of each other in every case, and not very remote from equality (say that one is nine-tenths of the other), probably if their mean is a foot he will estimate them with greater proportional accuracy than if their mean is 9 yards. But again he will measure them with greater accuracy if their mean is the 22 yards of a cricket pitch than if their mean is 9 yards; with less accuracy if their mean is 1000 yards than if their mean is 22 yards; but with greater accuracy again if their mean is a mile than if their mean is 1000 yards. Thus, the general principle that there is a certain magnitude in the neighbourhood of which estimates reach a maximum of accuracy from which they depart in either direction, may be qualified by any vivid experience or frequent practice which may have cultivated particularly accurate observations of certain lengths. And whatever the points of maximum accuracy may be the man will attempt to reduce his problems, when possible, to terms of the lengths he can best judge. Thus if a length is unmanageable he will try to

divide it into halves, thirds, or quarters, or to multiply it by two or one and a half, and see whether these fractions give him lengths that he can judge immediately with some confidence and from which he can then calculate the others. The boy who, when asked how he would estimate the distance of the sun from the earth, answered, "Guess a quarter and multiply by four," had a confused sense of a sound method in his mind, though he was not fortunate in his application of it.

Now in the case of our tea curve all these complications are present, and certain others as well. The ultimate quantities to be estimated and compared, here as elsewhere in the administration of resources, are not tea-leaves and pence, but quantities of satisfaction; and yet the housewife is never accustomed to think of these as quantities at all. She thinks in pounds and ounces of tea, and in shillings and pence of money, but the half-unconscious and wholly unanalysed processes which emerge into conscious deliberations under these denominations of ounces and pence really concern lots of satisfaction. Hence a divergence between the points on which her deliberations crystallise themselves in her own consciousness and those on which they actually depend.

It is not difficult to see why this is so. In order to estimate tea with reference to other commodities we must express its value in terms of money, as the common measure between all the commodities in question; and we shall estimate it in the quantities in which we are accustomed to buy it. But our direct experience of its value is based on much smaller units, for while we pay for tea by the pound we consume it by the cupful. If a man drinks two cups of tea of a certain average strength every day for breakfast, his estimate of the value of a pound of tea must be arrived at by considering it as supplying, say, sixty-four breakfasts, and the marginal value of a quarter-pound by considering the significance of substituting a cup and a half for two cups at these sixty-four breakfasts. The enjoyment of tea at one breakfast is the quantity of satisfaction he really estimates, but in order to bring it into correspondence with his problems of expenditure he must reduce it to the terms in which he actually deals

Relation  
of psychic  
quantities to  
units of the  
currency.

in it. If we express our estimate of one sixty-fourth of a pound of tea in terms of money we fall into manifest absurdity. For money is an instrument of practical exchange, and since we cannot give effect to these minute estimates of a fraction of a farthing in any actual transaction, this method of expression loses all its value. Hence the sense of intolerable unreality in our previous working out of the tea problem (pages 44-63). As we narrowed the areas of our estimates and so brought ourselves nearer to the actual basis of realisable experience we continued to express those estimates under a denomination that was becoming more and more hopelessly inappropriate and unconvincing.

Thus the point at which we deliberate as to alternative expenditures of money is likely to be remote from that at which our experience gives us the most direct and vivid sense of the immediate value of a commodity. In a word, to compare one *expenditure* with another we have to recede indefinitely from the points at which we can best compare one *experience* with another. Commodities are not practically exchanged with each other, or obtainable as alternatives, in the quantities in which the experiences they provoke are most directly comparable with each other. And as we are more accustomed to deliberate consciously as to expenditure than as to satisfaction (though our whole expenditure is ultimately regulated with a view to satisfaction), a difficulty inevitably arises. The careful administrator does occasionally revert consciously to the primary and ultimate basis. She may from time to time calculate, for instance, how many rice puddings can be made out of a pound of rice, or how many breakfasts a pound of tea will provide, in order to establish a kind of bridge along which she may pass either way from the quantities in which she buys commodities to the quantities in which she experiences their services. She sometimes travels from her expenditure per pound or per annum to her satisfaction per quarter-ounce or per diem, in order to base herself upon experience, and she sometimes calculates how much a saving too minute to be estimated in coin of the realm day by day would amount to in a month or a year, in order that she may bring one set of experiences into terms under which it may be compared with another and alternative set.

As we are now to deal with the ultimate limits of accuracy in the construction of a curve, it is obvious that we are concerned not directly with shillings and pence per pound, but with the estimates of satisfactions <sup>Ultimate</sup> per cup, and so forth, as quantities. Obviously it <sup>psychic basis</sup> of estimates. is with these that the housewife must ultimately wrestle. For instance, if an economy is to be effected she may have tea at fewer meals, never supplying it at certain times of day unless it is expressly asked for, or in the last resort saying that it cannot be had; or instead of this she may make it weaker, or she may practically limit the amount of the infusion at each meal while not limiting the amount of hot water that passes through the pot, or she may look for a cheaper tea, or (*horresco referens*) one that will not be so popular in her household. She may or may not be subject to such more or less unsympathetic pressure from her family as is implied in some of the foregoing suppositions, but in any case she is dealing with certain alternatives, and in considering them she is estimating and comparing volumes or areas of satisfaction, and it is a reference to these that underlies her estimates in money of the marginal value of an ounce of tea, and determines at what point of pressure she will buy more or less of any given quality at any given price.

It is therefore here that we must apply the principle of the magnitude that is estimated with greatest proportional accuracy; for there may be some one or more of the satisfactions she habitually considers which, as magnitudes, are realised with especial distinctness and vividness, and to which others are consciously or unconsciously referred as to a kind of standard. Suppose, for example, there is one member of the household whose wants, for any reason, good or bad, the housekeeper considers it specially important to satisfy, and whom she occasionally disappoints, as to quality or quantity, in the matter of tea. The significance of this occasional contretemps may well constitute the actual unit of greatest proportional accuracy of estimate, and it may be by unconscious reference to it that the housewife can determine most accurately the relative values of all the alternative refusals, indulgences, evasions, devices, and pecuniary expenditures, with which she is concerned in the matter. Here, as in the case of the

carpenter, there may be other points impressed by other experiences that give an exceptional degree of firmness to estimates of certain other quantities; but, neglecting this consideration, we may follow up the special clue we have grasped.

Note that our housekeeper will probably never deliberately incur or inflict the specific privation we are considering, merely in order to economise the tea needed to avert it. It will occur through some inadvertency or miscalculation, and it will be the delay, or trouble, or want of courtesy to a guest, or incidental (as distinct from primary) waste, that would be involved in correcting the error that will determine her to accept the result. But when the housekeeper is asked to make a number of hypothetical estimates as to what successive increments of the supply would be worth to her, and comes to think of a contraction of supply great enough to make this specific privation normal and permanent instead of occasional and accidental, she finds she has a very clear conception of that particular "lot" of satisfaction, that she has been accustomed to translate it into a great variety of equivalents, and that she has from time to time defined it pretty closely as worth just so much of certain other things, but not even a little more. She can now translate it, by a deliberate calculation, into so much tea per month, and can estimate it with some precision at its money value. This may form a kind of standard unit of reference, and may be the magnitude she is capable of estimating with the highest degree of proportional accuracy and precision. The area thus determined will be that of the elements out of which our curve can be constructed with greatest accuracy. For in considering the value of other increments nearer to the margin or further from it, our housewife (we are supposing) will find it easiest to make accurate estimates of areas of satisfaction of this particular magnitude; and she will find, of course, that if she has to think of herself as compelled by the further contractions of her supply to cut deeper back into the satisfactions of her household than she has ever actually done, she will realise that a smaller amount of tea, at the higher significance so reached, would yield the standard unit of satisfaction, and that in like manner at a more advanced point it would require a correspondingly larger amount to secure it. Geometrically the standard area will

stand on a narrower basis as we approach the origin, and on a broader one as we recede from it.

Thus, subject to all the qualifications hinted at or developed, we may suppose that the ultimate elements out of which data for the curve would be obtained with the greatest proportional accuracy would consist in estimated satisfactions of a magnitude about equivalent to that of the satisfaction relinquished on the occasions of disappointment that have impressed themselves most vividly on the housewife's mind. They would be represented on our diagram (when reduced to the terms of a month's supply, and expressed in shilling and penny rates per pound) by a series of rectangles of uniform area standing on progressively larger bases as we recede from the origin.

Elements from which the curve is constructed.

Now seeing that every day the housekeeper deals with the whole supply for the day, and has the opportunity of experiencing or observing the actual service rendered by every increment from the initial to the final one, we might be tempted to think that she could base her whole conjectural construction of the curve from the origin to the margin upon direct experience. But this is not so. We have seen that recurrently satisfied wants never take us back to the real initial significance of the things that satisfy them.<sup>1</sup> If our supplies were very much contracted (even apart from any reaction upon the organism that might ultimately take place) we should gain experience of significances that had evaded us before; for the want which to-day's first increment supplies is a different want according to the point up to which our want was satisfied yesterday. And as soon as we begin to contract or increase our supply at all this process sets in, though its effect at first may be hardly perceptible, and it may only become pronounced as we recede considerably from our present margin. Thus an additional element of uncertainty enters into all estimates far behind or far in advance of the present margin, and our ideal equal areas will become correspondingly more speculative. This speculative element may reveal itself consciously in a refusal to make equally precise estimates, or unconsciously in an inability to make equally consistent ones, as we recede from the actual

Range of experience

<sup>1</sup> Cf. page 426.



margin. Past experiences, vividly remembered, may establish at irregular intervals other bases of comparatively direct and immediate estimates; or critical points may so appeal to the imagination as to give a firm but illusory precision to speculative estimates; or some changed unit of maximum accuracy may assert itself in certain regions of the curve; and throughout we must distinguish between precision and consistency in the sense explained above, and approximation to the estimates which would be formed under the pressure of immediate experience should it ever be realised.

When formed, our curve, such as it is, will be an estimate, or a register, more or less reliable, both of the total significance to be derived from the consumption of any given quantity of the commodity, and of its marginal significance at any point.<sup>1</sup>

Before leaving this branch of the subject we may note that if we asked for estimates of the significance of a series of objectively equal increments of the commodity we should have a series of rectangles, not of equal area but on equal bases, from which to construct our curve; and we may ask what conditions would influence the delicacy and accuracy of our estimates of the difference of area between them. Two considerations are relevant here. In the first place, the same magnitude is less easily perceived and estimated as part of a larger than as part of a smaller whole. The difference of an inch is more conspicuous in the length of two men's noses than in their heights. Small differences will therefore be less delicately noted when the areas are large than when they are small, and therefore a given difference between two contiguous rectangles might escape detection near the origin but might be distinctly felt farther from it. But in the second place, our whole investigation has shewn us that the significance of successive increments of the commodity changes more rapidly in some regions than in others. Between two successive rectangles on equal bases, therefore, we shall sometimes have greater differences and sometimes have keener powers of observation. The first condition is indicated by a rapidly falling curve, and the second by a higher positive altitude of the curve. In our example of the tea, and in Fig. 14, *a*, these two conditions tend to counteract each other; for as the

<sup>1</sup> But see below, pages 467 *seq.*

differences themselves decrease, our power of perceiving them increases. But in Fig. 14, *b*, they reinforce each other. As the differences themselves become greater our power of observing them also becomes more acute.

Enough has now been said to shew in the first place how extremely precarious any actual evaluation of a curve of total significance of any commodity must necessarily be, but also, in the second place, that this value, which it is so difficult to estimate, is actually a definite and a highly significant quantity.

The area bounded by the curve represents what the older economists called the "value in use" of the commodity, that

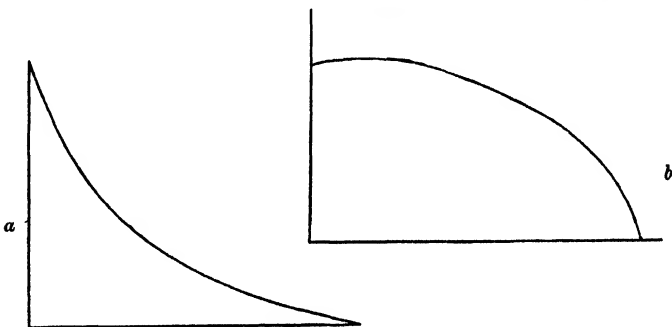

FIG. 14.

is to say, the total satisfaction or advantage derived from its enjoyment; and the height of the curve above any point on the abscissa represents its marginal significance, which, in the case of exchangeable things, will always tend to be brought into coincidence with its "value in exchange." And note that if our expenditure is wise a decline in marginal significance due to an increased supply will always coincide with an increased volume of satisfaction. A reduction in the "exchange value" of any commodity, taken in itself, should always result in its increased "value in use" to us.<sup>1</sup>

We have now sufficiently examined the general meaning of a curve of total significance or satisfaction, and we have seen the very precarious nature of the data upon which any attempt actually to evaluate the total significance of a

<sup>1</sup> Cf. pages 45-47.

commodity must depend. But we have still to take note of certain points, a neglect of which might lead to erroneous or inaccurate thought.

It will be understood that a curve proves nothing whatever as to the facts from which we start. It is merely an idealised picture of facts and their implications. It may therefore enable us to understand the full meaning of any set of supposed facts, but it cannot establish them. At most it can only shew us the relations in which certain facts, if they exist, stand to each other. But by doing this it may bring out implications involved in our data that we had not fully realised, and this may throw back light on the validity of the data themselves. For instance, a glance at the tea curve at once suggests that it will not decline any further after the point to which we have carried it; and as there is no reason why the law of declining significance should become invalid after seven pounds, we begin to suspect our data of being in some way self-contradictory or impossible. And this is really the case. We supposed our original data as to the values of successive pounds of tea to conform to a perfectly rigid and easily discernible algebraical law. But this is strictly impossible. In the first place, it is impossible that the estimates should be mathematically accurate at all. That is to say, it is impossible that an infinitesimal change in the quantity of the commodity could be actually and directly appreciated, and its significance registered in terms of money. But if we are dealing only with approximations it may possibly happen that the more or less loose estimates given may conform loosely to some simple algebraic formula. Since, however, an immense number of heterogeneous factors would enter into the composition of every region of the curve, some of them changing as it proceeds, we may be very sure that no simple algebraical formula would be able to represent them all even approximately, though it might approximately fit a certain portion of the curve. So if we had assumed this precise algebraical law as determining the whole curve, we should have assumed in the first place an impossible precision, and in the second place a highly improbable (and, as it turns out, impossible) simplicity and regularity. As a matter of fact it will be found that our original data themselves assumed

Form of the  
supposed  
tea curve.

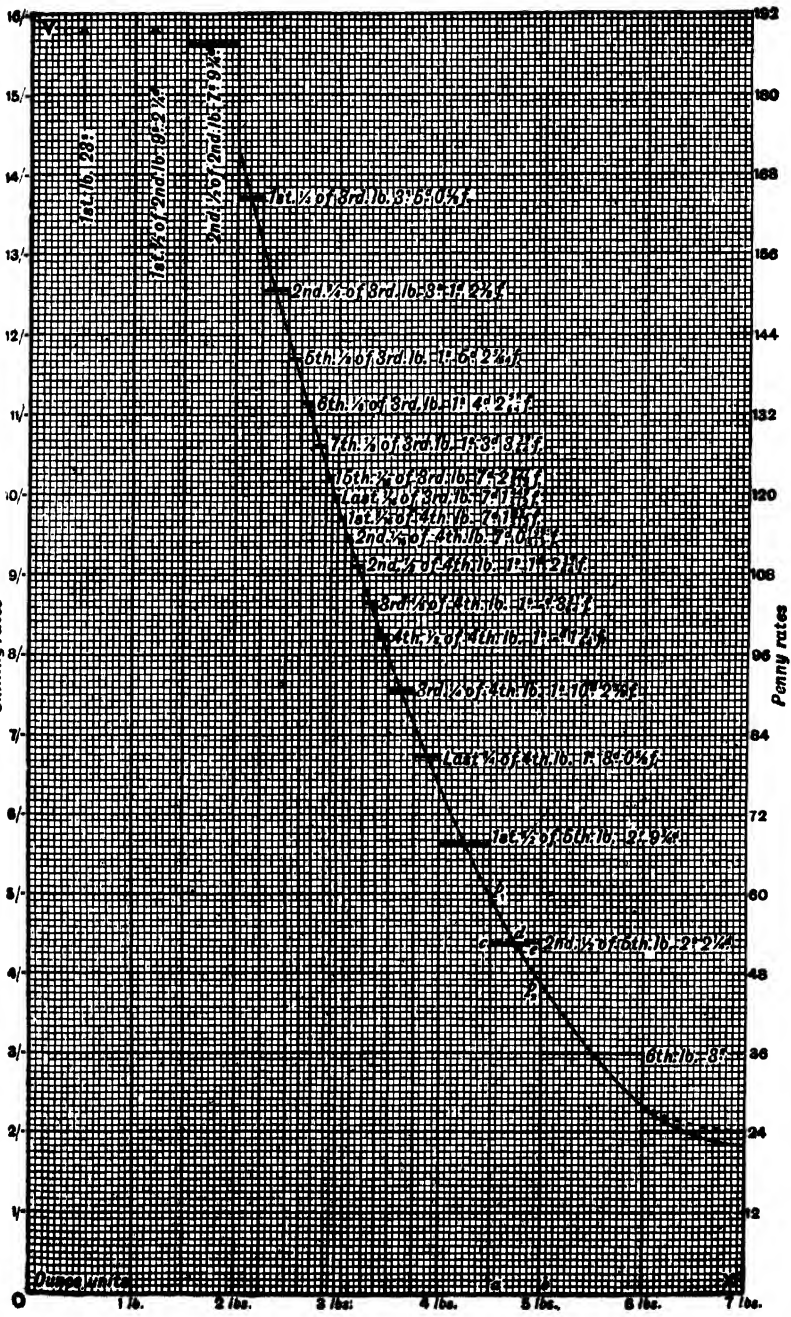

FIG. 10.

that after the sixth pound the law of the curve would change ; for the series 23s., 17s., 12s., 8s., 5s., 3s. would give as its next term 2s., and we have constructed the curve on this estimate. But this contradicts our original data, for we started with the supposition that at 2s. a pound the purchaser would take 7 lbs. ; and the figure makes it very clear that if the whole seventh pound is only worth 2s., then the first half-pound is worth more than a shilling, and the second half-pound worth less. The second half-pound therefore would not, on this supposition, be bought at all. Our curve would give about 6.42 lbs. as the ideal point at which the purchase would stop. So if we are to suppose that 7 lbs. would be bought at 2s. we must suppose the character of the curve to change after 6 lbs. It might take some such course as that indicated by the dotted line.

In very many cases a curve that approximated to a similar formula during a part of its course might reasonably be expected to change its character as it approached the origin ; for we have seen that at first a commodity may have increasing significance, and may only enter upon the period of declining significance "after a certain point."<sup>1</sup> In the case of tea, however, there is nothing palpably absurd in supposing our curve to follow approximately the formula we have assumed, at any rate up to a very close proximity to the origin. It is easy to imagine that as tea (or coffee) became dearer and dearer a careful housekeeper, whose family still retained a taste that they were less and less able to indulge, might limit the purchases more and more till at last it was only on occasions of special festivity that the precious infusion was consumed. When the price of £1 : 6 : 4d. a pound was reached, a quarter of a pound, or two ounces, might be bought for Christmas Day, and none at all at any other time. This consumption (four or two ounces a year) would be at the rate of one-third or one-sixth of an ounce per month, and would be represented on our figure by a point only one-third or one-sixth of the side of a small square from the origin. And if we had lowered the whole curve by, say, two of the large units on *Y* so that it intercepted the axis of *X* at a little under 6 lbs. 7 oz., the whole series of marginal values from the initial

<sup>1</sup> Cf. page 435.

increment to the one that completed the full satisfaction of the desire might, without palpable absurdity, have been supposed to be represented by this particular curve. As it is, it is clear that our original data involve the supposition that the law indicated by the successive steps in declining value from 1 lb. to 2 lbs., etc., up to 6 lbs., would not continue to hold for the decline from 6 lbs. to 7 lbs.

Even if we do not assume an algebraical formula for a curve, we can seldom use this diagrammatic method without expressing more and expressing it more precisely than we desire, and this constitutes a grave disadvantage in the use of curves for popular demonstrations. If, for example, we say that successive increments of a commodity will decline in significance after a certain point the statement remains general. But if we illustrate it by a curve, the "point after which" will be determined and the rate of decline at every point will be determined, and a general conception of the modes of variation will be suggested. And so the incautious student may be misled by the characteristics of the individual curve selected, and may fail to distinguish between them and those characteristics really involved in the data. The utmost caution is needed to prevent a curve from surreptitiously insinuating into our minds suppositions which are not included or involved in our data, but which we nevertheless receive into our conclusions. Nor is it beginners only that have fallen into this trap.<sup>1</sup> But this by the way.

We might now suppose that in such a diagram as Fig. 15, if properly constructed, we should have an ideal presentation of the amount of the commodity  $Ox$  that would be purchased by a certain individual at any given market price  $Oy$ ; of the total satisfaction  $Oy_0px$  that its consumption would afford; of the volume of other satisfactions  $Op$  sacrificed in the total sum paid for it; and of the surplus of satisfaction  $yy_0p$  which is secured over and above what is sacrificed. If this were so, then this last-named area would represent the advantage which the consumer derived from the existence of this particular market, and the volume of

Interpretation  
of a curve  
of total  
satisfaction.  
Instability of  
the psychic  
meaning of  
the unit of  
currency.

<sup>1</sup> Cf. pages 552 and 568 *op. cit.*

satisfaction of which he would be deprived if it closed or became inaccessible to him, all other things remaining equal.

These conclusions, however, are still subject to sundry modifications and qualifications which we must now examine.

In constructing our curve, we have used denominations of shillings and pence simply as measures of certain definite satisfactions, and we have tried to shew how, ideally, the area of total satisfaction corresponding to any given supply  $Ox$  of the commodity could be actually evaluated in these denominations. But on closer inspection we become aware of a disturbing instability and ambiguity in our unit when regarded as a psychological magnitude. We have often noted that 1s. has a different psychological significance to two

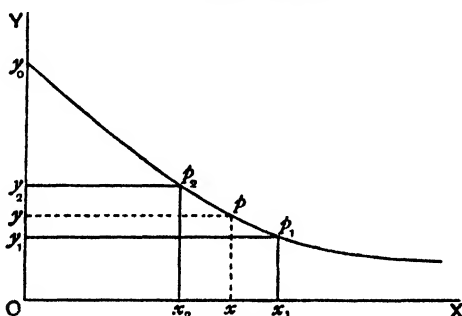

FIG. 15.

different men, and also to the same man if his income rises or falls. Theoretically, then, the marginal significance of a shilling will be affected by the sum the man has already paid to secure a certain satisfaction. We supposed, in our example of the tea, that the housekeeper gave us the outside value of the first pound of tea to her, and then *supposing herself to have paid that sum* for it went on to give us the outside value of a second pound, and so forth. If our Fig. 15 has been constructed on this system, then  $x_1 p_1$  will represent the marginal value of a commodity to a man, on the supposition that he has actually paid the money represented by the area  $Oy_1 p_1 x_1$  for the quantity  $Ox_1$ . But will  $Ox_1$  represent the amount he would actually buy if the market price were  $Oy_1$ ? Not unless the sum of money represented by the whole area  $Oy_0 p_1 x_1$  is so insignificant a part of the man's total expenditure that it

makes no perceptible difference to the marginal significance of a penny whether the area  $Oy_0p_1x_1$  or only the area  $Op_1$  has been spent upon tea. If this is not so, then the fact that he can actually get  $Ox_1$  for the expenditure of  $Op_1$  will leave him better off than on our first supposition by the area  $y_1y_0p_1$ ; and this being an appreciable sum it will enable him to get a little more of everything or anything (including the commodity under direct consideration) than he would have been able to do had he spent  $y_1y_0p_1$  (as well as  $Op_1$ ) on the supply  $Ox_1$ . A little more than  $Ox_1$  may therefore be purchased. And again, since all the man's wants will be satisfied down to a lower point of urgency, the significance of what a penny will buy at this advanced margin is lowered. Thus the psychological significance of our unit will be smaller if the whole supply is purchased at the lower price than if the full sum represented by the mixtilinear area had been given for it. As we imagine  $Ox$  to advance or recede, the changing values of the total or the rectangular areas will react upon the psychological significance of the unit, and the difference between them will prevent the abscissa from accurately representing the amount that would be consumed at the price represented by the ordinate.

This is not a mere fanciful speculation. If a careful housekeeper were giving any such estimates as we have supposed, when she came to think of herself as paying 50s. or 60s. a month for tea instead of something like 14s., she might be perfectly conscious of the constraint she would feel in all branches of her household expenditure, and might realise that she was estimating the increments of tea in a unit of higher significance than that by which her actual expenditure is regulated.

The curve as constructed, therefore, does not represent the relation of price to quantity purchased with any theoretical accuracy at all, and it represents the psychological value of the satisfaction secured in a fluctuating unit.

We will begin with the latter difficulty. How can we maintain the stability of our psychological unit throughout a series of estimates? What we really want is to fix in our own minds or the mind of our informant the actual psychological magnitude represented by the objective unit at the



margin of our current expenditure; and then to estimate *in that unit* the significance of small increments of the commodity at various margins. We should then have, for any given quantity consumed, what we set out to obtain, viz. an evaluation in a stable unit of the total estimated satisfaction enjoyed, as distinct from the sum paid. These estimates, however, are such as we could only imagine experts trained in a psychological laboratory attempting to make. The naïve, however careful and acute, answers we could expect from practical administrators would never be based on so subtle a conception as that of the psychological unit. We should have to assist our informant by putting our questions in some such form as this: "If when you had bought your tea for the month and paid for it at market prices, you lost half, three-quarters, nine-tenths, or all of your stock, what in each case would you pay for a first small increment, sooner than go without it?" The smallness of the increment estimated would reduce to a vanishing point the reaction of the sum to be paid upon the psychologic value of the money unit, and the fact that in every case the full amount that is actually paid for the commodity, and no more, is already written off, would keep that psychological value uniform. The ingenious reader may still think of disturbing influences, the shock of the loss, the changed significance of other enjoyments caused by the reduction in the supply of tea and so forth; and he may imagine any system of discounts that pleases him. It is clear that in any case absolute fixity of the psychological unit is only an ideal conception, and that actual estimates in money will never be more than approximately consistent in their psychological significance. The essential point is that the total psychic value of the satisfaction derived from the consumption of a given amount of a commodity is a finite quantity, capable of ideal evaluation in a fixed unit, and that over a vast field of our current expenditure it exceeds, in our own estimate, the value of the alternatives we relinquish for it.<sup>1</sup> This total area of satisfaction may, in theory, be represented accurately by a figure which sets forth the marginal significance of every successive increment of the commodity; but if we have taken as our psychic unit the satisfaction which the money unit

<sup>1</sup> But compare the following chapter.

commands at the actual margin of our expenditure under existing conditions, then any hypothesis which sensibly changes those conditions (as by increasing or diminishing the amount actually spent on our commodity) will change the significance of the unit; and therefore, if we measure penny or shilling rates on the axis of  $Y$ , it follows that the same figure cannot represent, with theoretical accuracy, the meaning of a number of different hypotheses, regarded as co-existing. Given any price and the actual administration of resources that corresponds to it, we can ideally construct a curve of total satisfaction, the unit of which corresponds to the marginal satisfaction now secured by a penny or a shilling; but if the price changes we cannot preserve the same figure and get an accurate result by simply changing the point on  $OX$  at which we erect a perpendicular to cut the curve; for under the changed conditions the satisfaction secured by a penny or a shilling will have changed.

I have been careful to speak of the Figure as giving, ideally, a representation of the total satisfaction derived from the consumption of  $Ox$ , in the mixtilinear area above it. I have not said that the surplus of satisfaction over payment would be accurately represented by the area  $yy_0p$ . For this again would only be an approximation. In evaluating the price actually paid at  $Op$  our Figure implies that if the market for the commodity in question were closed, or if the commodity ceased to exist, the purchaser, while losing the total area above  $Ox$ , would gain the released area of the rectangle  $Op$ . This means that the whole of the money now spent on this commodity could be expended on other commodities at a marginal significance represented by  $xp$  or  $Oy$ . But theoretically this is not true, for if the supplies of other commodities were increased, it would of course be at a declining significance, and consequently, when the whole sum  $Op$  had been distributed amongst them, their marginal values would have declined to some extent, however small, from the height  $xp$ . Some portion of them, therefore, would have less value than if their marginal significance had remained at  $xp$ ; and in the sum they will not equal  $Op$ . And here again, as we recede from the actual point of departure towards the origin, there will be another source of

Interpreta-  
tion of the  
rectangle of  
payment.

disturbance in the psychic significance of the money unit, independent of the advancing margin, viz. the change in the whole significance of remaining sources of satisfaction as the one to which the Figure refers dries up. Here again, therefore, all attempts to guard against and discount sources of disturbance in the psychic value of our objective unit must be at once subtle and clumsy. The only ideal method is to conceive of a mind trained to hold a psychic magnitude firmly and apply it consistently as a unit. That magnitude would be the satisfaction represented by the money unit under existing conditions, but it would be applied to hypothetically changed conditions directly, and not through the convenient but treacherous intervention of a money unit which might be perpetually changing its significance.

If we traced our original curve with a stable psychic unit, based on the satisfaction secured by a penny or a shilling at present margins, and if we then allowed for the decreasing values of other commodities as the margins advanced, represented by a decline in the height of the ordinates as we pass from  $xp$  to  $Oy$ , we should have a consistent representation of total satisfaction, and of surplus of satisfaction over the sacrifice represented by the price, corresponding to the actual state of things. It would shew how much satisfaction I get and how much I pay for it, measured in a stable unit. But it would not give us accurate information as to any other than the actual state of things.

If, on the other hand, we were to ask, not "how much would you give for an ounce of tea under such and such circumstances?" but "how much tea would you buy if it were such and such a price?" we should get a curve with just the opposite characteristics.

It would give us information about a number of different hypothetical conditions, but its different parts would have no consistent significance. Thus, by asking "how high would the price of tea have to rise before you would stop buying it altogether?" we might find a point on the axis of  $Y$ , and then, by asking how much would be bought at the several prices descending from that to zero, we might obtain points on a curve which would accurately represent the relation between price and quantity purchased for every

Curves of  
price-and-  
quantity-  
purchased.

hypothesis at once. But on each hypothesis the psychological significance of the unit would be different, and as it would always make a (theoretical) difference whether the whole sum represented by the mixtilinear area above any abscissa, or only that represented by the rectangle, were paid, the area would never represent accurately either the total sum that the consumer would pay for the amount  $Ox$ , or its psychological evaluation in any fixed unit.

A curve, therefore, which professes to give, for every price, (1) the quantity that would be purchased at that price, (2) either the pecuniary or the psychic evaluation of the total satisfaction it would yield, can only be a <sup>Tempera-</sup><sub>ment.</sub> compromise, for it endeavours to comply with two incompatible sets of conditions. Its construction would illustrate the principle of "temperament" by which a note on the piano which is neither D sharp nor E flat, but a compromise between them, is made to do duty for both alike. This is only possible if the interval between them is small. In our case the errors involved in confounding the two curves become negligible in proportion as the total expenditure on the commodity in question is a negligible part of the man's whole income.

The psychological curve always remains the ultimate and basal fact, and though we can never rely on its precise evaluations it is essential that we should form a precise conception of its nature and should realise that it has a definite value. The price-and-quantity-purchased curve is the most accessible and is the one with which we shall usually work; but unless the contrary is expressly stated we shall assume that our curves have a "temperament" which allows us to read them either way.<sup>1</sup>

<sup>1</sup> Cf. Appendix to Chapters II. and III. pages 490-492.

## CHAPTER III

### ON THE NATURE OF CURVES OF TOTAL SATISFACTION

**SUMMARY.**—*Curves of total satisfaction are purely abstract ; that is to say, they represent the subjective value attached by a consumer to each increment of the commodity, or the amount he would purchase at any given price, apart from any consideration of the causes that might be supposed in actual experience to limit his supply or raise the price of the commodity, and apart from all reactions upon the price of other commodities. They are also isolated ; that is to say, we cannot conceive of a system of such curves being so constructed as to be valid simultaneously. Nor can we sum their areas, taken successively, without omitting some values and counting others more than once. Nor can we read on them the effect of a rise or fall in the consumer's income. Nevertheless their general form has a high theoretical significance. Communal curves of price-and-quantity-saleable cannot be interpreted psychically, though they rest on a psychic basis. A system of such curves cannot possess simultaneous validity.*

The refinements dwelt upon in the preceding chapter are usually ignored. A curve of price-and-quantity-that-would-be-purchased is supposed to be constructed by a direct process of estimates ; and its area is taken to represent the total satisfaction accruing from the consumption of any given amount of the commodity, while the rectangle of price-multiplied-by-quantity is taken to represent the value of the sacrificed alternatives, the surplus satisfaction being secured without corresponding sacrifice or payment. But, independently of the difficulties thus ignored,

Ideal and isolated character of personal curves.

the legitimacy of the whole conception has been seriously challenged. Probably this is due to the fact that a personal curve of total utility, though its formation is in itself entirely legitimate, is nevertheless of such an ideal and isolated character, that it cannot be regarded as co-existing with other curves of the like nature, for the same individual, nor can it, and its analogues for other individuals, be made, as they stand, the basis for the calculation, by summation, of a communal curve of the one commodity. And therefore when we try to bring a curve of this nature into relation with any practically realisable hypothesis as to the conditions of markets, it assumes an elusive and evasive character which has tempted the bewildered and impatient student to fling it aside as a mere illusion. All this must now be explained.

We shall best avoid the confusions in which the controversy has often been entangled, and shall at the same time best vindicate the fundamental value and significance of the method itself, by examining more closely the meaning of the condition that "other things must remain unchanged" while we are obtaining our successive data as to how much of the commodity the consumer would purchase at such and such prices. To begin with, amongst the other conditions that are to remain unchanged, we must include the power of purchasing substitutes at the prices now current. For example, when our housekeeper is considering how much tea she would buy if it were 6s. a pound, she will probably think of herself as increasing her purchases of coffee or cocoa as she contracts her purchases of tea; and she will suppose that she will still be able to buy coffee and cocoa at the present prices. Now this shews us at once the isolated nature of our hypothetical tea curve. For suppose we had constructed a coffee curve, as well as a tea curve, on the same principles. We should then find that the conditions we supposed to be stable when we were drawing up our tea curve included the possibility of getting more coffee at the present price; and, in like manner, the conditions we supposed to be stable when we were drawing up our coffee curve will have included the possibility of buying tea, as required, at the present market price. Thus, as soon as we suppose the price of tea to rise, we are violating

Meaning of  
the condition  
"other things  
remaining the  
same." Sub-  
stitutes.

one of the conditions on which the validity of our coffee curve depends; and, in like manner, if we supposed the price of coffee to change, we should thereby be violating one of the conditions on which the validity of our tea curve depends; for it is sufficiently obvious that the amount of coffee which a housekeeper would buy at any given price might be affected by a change in the price of tea; and *vice versa*. It seems impossible, then, even ideally to draw up a system of curves which shall be valid simultaneously; for any curve purports to represent a number of simultaneous possibilities, indicating what quantities would be purchased at any given price; but a change in the price of any one of the commodities will, or may, affect the quantity of other commodities that would be taken at *any* given price. That is to say, if we change our supposition as to the price of any one commodity, that very supposition will change the form of the curves of other commodities, throughout their course. This perhaps needs some further elaboration and explanation.

Let us start on the assumption that the consumer's income is as a matter of fact distributed in a certain way. He buys

Reaction of  
changed  
supply of one  
commodity  
on the form  
of the curves  
of other  
commodities.

*Oa* of commodity A at the price *aa*, *Ob* of commodity B at the price *bβ*, *Oc* of commodity C at the price *cγ*, etc. We construct the curves severally as in Fig. 16, on the principles already illustrated, in every case starting from the same initial hypothesis. Each commodity is measured on the axis of X in its own conventional unit, but the unit on the axis of Y is uniform. We can now suppose *any one* of the curves (say the curve of B) to set forth (as a first approximation, subject to the secondary inaccuracies and inconsistencies dwelt on in the last chapter) the marginal significance of B, at any point of supply, the quantity that would be purchased at any given price, and the surplus of satisfaction over enjoyment attendant on the consumption of any quantity, provided always that A, C, etc., can be obtained in any quantities desired at the prices *aa*, *cγ*, etc. But the moment we suppose the price of B to rise and the consumption to contract we may find the consumer taking more of A or C as a substitute, and in that case *Oa* would no longer represent the amount of A that would be consumed at the price of *aa*. Nor would the curve as it stands

(unless by accident) represent the relation between price and quantity at any other point either. The curves of A and C therefore may change their form for every value of  $b\beta$  and are drawn up on the supposition that it is constant, whereas the curve of B is drawn up expressly to illustrate the significance

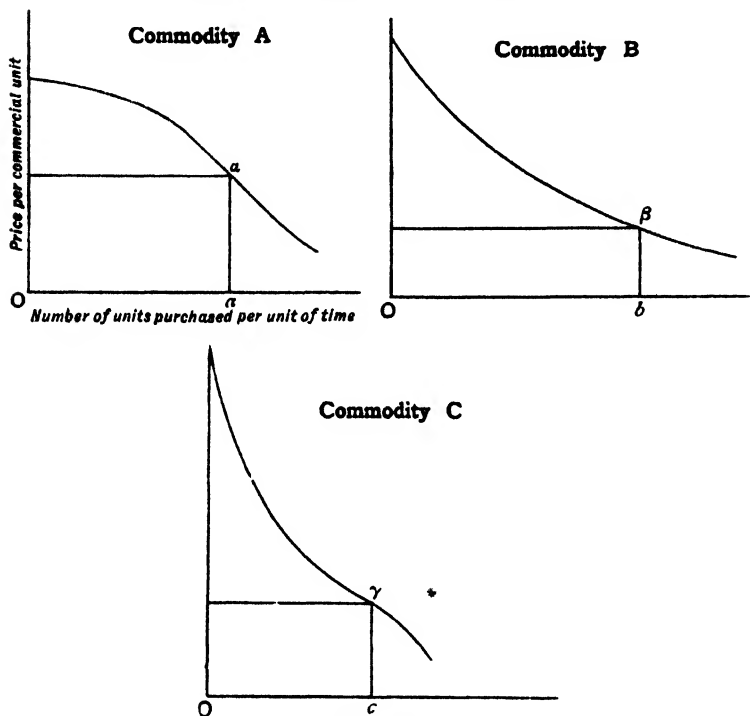

FIG. 16.

of changes in that value, regarded as causes or effects of a change in the magnitude of  $Ob$ .

In constructing the curve of B we must be supposed to register the value of  $b\beta$  for any value of  $Ob$ , or *vice versa*, as the resultants of all the complex readjustments of expenditure caused by a change of supply, or a change of price, in B, the prices of A, C, etc., remaining constant. And if we start in every case from the actual prices  $aa$ ,  $b\beta$ ,  $cc$ , etc., we may thus trace the curves of A, B, C, etc., severally and independently, and *any one* of them will then be valid as long as all the



others are cancelled and the original data (*aa*, etc.) treated as constant; but no two of them will represent a system of relations between changing quantities and marginal values which holds contemporaneously for both of them.

We have now sufficiently developed the fact that we can only regard such a curve as we have been discussing as valid in isolation. But it will be instructive to consider a little further the nature of the reaction of a change in the price of one commodity upon the demand for another. A glance at any of the figures will shew that a rise in the price of a commodity (A), while it will always cause a contraction of the quantity purchased, will sometimes increase and sometimes diminish the amount of money spent on it. And in either case it may cause an increased expenditure on the readiest substitute (B). Thus a rise in the price of A, whether causing an increased expenditure on A or not, may easily cause an increased expenditure on A and B between them. This may extend to other commodities also; but since the man's total resources are not increased by the rise in the price of A economies must be effected somewhere. Thus a rise in the price of A may cause an increased consumption of B but a diminished consumption of C.

In some cases this result might be the direct, not the indirect, effect of the rise in the price of A; for there are commodities which are complementary to each other as well as commodities which are substitutes. Thus Complementary commodities. a man may have a taste for *café au lait* but not for *café noir*, so that if the price of coffee rose it might check his purchases of milk. If the total expenditure on the two commodities were reduced, then some other expenditure would be increased.

Thus every modification in the price of any one commodity reacts on the demand curves, or curves of total estimated value, of some other, ideally of all other, commodities, services, and opportunities. A system of such curves purporting to represent the whole range of any man's scale of preferences would be mutually destructive, for each one only represents the possibilities of a sliding scale of purchases and prices on the supposition that there is no movement in any of the others. Any one curve represents a track, movement along which

incidentally modifies some one or more of the other tracks, and which is itself modified by a movement along any one of them. This is the meaning of the principle so constantly insisted on by Pareto, that the marginal significance of any commodity is a function not only of the quantity we possess of that particular commodity but also of the quantity we possess (including zero as a quantity) of other, ideally of all other, commodities. The quantities of all desired things, services and opportunities which we command, and the marginal significances we attach to them, are therefore a system of magnitudes which mutually determine each other within the limits imposed by our total command of resources.

Well, then, taking these curves as indicating, severally, the consumer's own estimate of the addition to his total satisfaction which the existence of each market confers upon him, his resources and alternative opportunities being what they are, can we say that as the market in A does under existing circumstances yield the net additional satisfaction corresponding to the mixtilinear area shown by the curve of A, and the market in B the corresponding area shown by the curve of B, the two areas added together will indicate the total additional satisfaction yielded by the two markets?

Manifestly not. Let A and B be tea and coffee. Now there are (or may be) services that can be rendered either by tea or coffee indifferently. If the rise in the price of tea, while making the consumer buy less tea, makes him buy more coffee, this is manifestly the case. The curve of A, therefore, shows the value not of the whole service which is actually rendered by the tea the man consumes, but that part of the services only which could not be rendered by coffee. And in like manner the curve of B represents that part of the services rendered by coffee which could not be rendered by tea. Thus, if we first take the advantage we derive from the tea market on the supposition that the coffee market is open as an alternative, and then the advantage we derive from the coffee market on the supposition that the tea market is open as an alternative, and then add the two together, we shall have arrived at something very different from the total advantage which the two markets together confer upon us; for

Impossibility  
of summing  
areas of  
surplus  
satisfaction.

that range of wants which can be indifferently satisfied by tea or by coffee will have evaded our estimate altogether. When we estimate tea it escapes and is transferred to coffee, and when we estimate coffee it escapes and is transferred to tea.

If we suppose the effect of the closing of the markets to be cumulative, then if we take tea first this common service will escape to coffee, changing the form of its curve and increasing the mixtilinear area for any given abscissa. If we then close the coffee market too, the value of the common service will be apprehended and registered under the head of coffee; whereas if we had taken coffee first it would have been the tea curve that would have been modified, and the common service would have been evaluated there; but in neither case would the sum of the areas shown by the original curves, drawn out severally on the basis of existing alternatives, give us any evaluation of the service that can be rendered indifferently by either of the commodities.

And again, the service which can be rendered by tea or coffee indifferently, but not by anything else, does not exhaust the whole service that they do now severally render. If when the tea and coffee markets are closed the cocoa market remains open, the alternatives still available may enable a considerable portion of the services now rendered by tea and coffee still to be performed. Perhaps, indeed, an important part of the services which they render is discharged by the hot water and not by the infusions or solutions it contains. So that we shall not capture the whole of the significance of the service actually rendered by tea till we have closed all access to hot water—nor then either, for the most important of all its services could be rendered by cold water.

But when commodities are complementary to each other, the several curves, instead of not counting certain values at all, will count them twice (or many times) over. To enjoy tea we require fuel and a kettle, and we value a teapot and cup, and the value we attach to tea depends upon our command of these things. Or there might be a man who found cream with his tea essential to high enjoyment. If such a man declared that he would go up to £1 for two ounces of tea sooner than give up his Christmas Day treat, the estimate might be made on the supposition that he could command an

adequate supply of cream for a few pence. If he were asked about cream he might say that he would give £1 for a small jugful once a year sooner than give up his Christmas celebration, but that would be on the supposition that the tea would cost him a few pence. If we added the two estimates together we should have counted nearly all the enjoyment of tea-with-cream twice.

These sources of confusion have, as a matter of fact, puzzled many a student of marginal and total significance, and obscured many an exposition of them. For example, we are told that a man gets a loaf of bread for a few pence, for which he would give his whole fortune sooner than go without it. Nay, by a still deeper confusion we are told that the value of an initial supply of bread is "infinite." And it has been suggested that a wheat curve should stand at an infinite height at the origin—that is to say, should be what mathematicians call asymptotal to the axis of Y. This at once prompts the question, "How about water?" Should the curve of water be asymptotal to the axis of Y too? If it were so, we should have an extreme case of repeated counting of the same value; for a man dying of thirst would certainly not attach an "infinite" value to a crumb of bread. He would not give a drop of water for it. But of course the truth is that price cannot be "infinite." If a millionaire paid his whole fortune for the smallest crumb of bread he could see, the price would be high but not "infinite." Moreover, even if we substitute more accurate language for talk about "infinities," and say that if a man had plenty of water he would give all the rest of his possessions for a certain supply of bread, or if he had plenty of bread he would give them all for a certain supply of water, it remains true that if he is without either bread or water he can but offer all the fortune he has for both, and we cannot take the two previous suppositions as applicable concurrently.

Nor must we raise the initial value of bread by crediting it with relieving us from all the agony we should endure if we had water but nothing to eat, and credit water with relieving us from all the agony we should endure if we had bread to eat but nothing to drink, and then put down the

sum to their joint credit; for to be without both food and drink would not involve suffering equal to this sum.

The outcome of all this inquiry is a more enlightened perception that the importance to us of increased supplies of any one commodity depends not only on the degree to which we are supplied with that commodity, but also on the degree to which we are supplied with all other alternative or complementary commodities. And since our general state of vitality and sensitiveness may be regarded as complementary to every desired experience, we may venture on the generalisation that theoretically the marginal significance of any commodity depends primarily on our supply of that commodity, secondarily on our supply of the most obvious substitutes and complements, and remotely on our supply of all things, whether in the circle of exchange or not, which in any way affect our vitality.

Hitherto we have been trying to evaluate the loss of desired experiences which the closing of a market would involve to a given individual, on the supposition that he could still obtain the same total amounts of all other commodities. that he would be able now to obtain, should he choose (from change of taste or convictions or for any other reason) entirely to give up purchasing the commodity in question. We may express this by saying that his total resources or income are to remain the same, but that this particular market is to be closed to him. We are neglecting the lowered marginal significance of other commodities which would follow his increased purchases.<sup>1</sup> Now let us suppose the reverse case, that while his income remains the same some new possibility is opened to him: bicycles or motor-cars are invented, or new fruits are imported, or opportunities of study or of hearing good music or of travel are organised, and he finds that by contracting his expenditure on other articles to the total amount of  $Ox$  (Fig. 17), and expending the sum thus saved on the freshly opened alternative represented on the figure, by the sacrifice of an area equivalent to  $yx$  he will gain the total area contained between the axes, the line  $xp$ , and the curve. This newly opened opportunity then will present

Loss and gain  
as markets  
are closed  
or opened.

<sup>1</sup> See page 477.

him with a total advantage of the mixtilinear area above  $yp$  for the expenditure of the same income. Whether this will be for his ultimate good or not is of course quite another question. We have seen ample reasons for declining to assume anything of the kind.<sup>1</sup> But at any rate he has now got something for which he would have been willing to sacrifice the whole mixtilinear area, and has only surrendered the area  $yx$  for it. Measured by his own immediate desires, then, there is the gain indicated.

But now let us suppose that a man's income increases

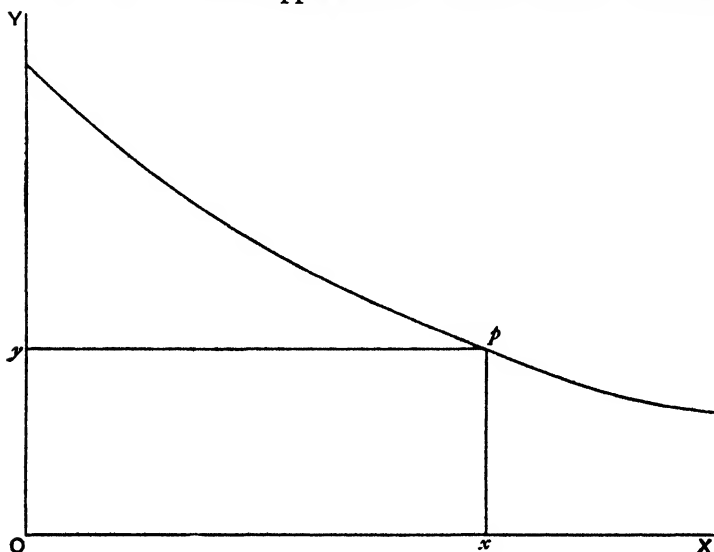

FIG. 17.

or diminishes. This will obviously affect the whole system of his scales of preference. Possibly "pop and cockles" may completely fall out of his list of purchases, and "champagne and oysters" may appear on it; but in an ordinary case (especially where the change is not so great as to declass the man), while some modes of expenditure will probably be dropped and some almost certainly introduced, a large number will be extended. He will perhaps increase the scale of his hospitalities, will pay more for houseroom, and so forth. That is to say, on a great

<sup>1</sup> See pages 15 *sqq.* and 428 *sqq.*

number of individual commodities the amount of his purchases will increase, but he will pay for land, railway tickets, concerts, and provisions at the same rate as before, and, as before, will gratify his tastes to the point at which the *relative* marginal significance of the things he buys is the same to him as it is to his competitors in the market. But the price of things, though the same, will not represent the same sacrifice, for he is better supplied with all the things in the circle of exchange that the price represents. But as for those things that do not enter into the circle of exchange—irksome effort, for example, or the sacrifice of personal tastes or the thwarting of personal affection—he would not now incur the same sacrifice in these things to avoid a slight decrement or to secure a slight increment of any of the things in the circle of exchange that he would have done when his smaller income gave each of these latter a higher psychic significance to him at the margin.

For instance, if one of his children shews signs of ill-health, and by the expenditure of £100 a year he can place him under more favourable conditions, he may not hesitate to sacrifice the alternatives of things in the circle of exchange at the margins of his other expenditures which will be necessary; whereas when his income was narrower he could not have faced the acuter hardships and sacrifices which would have been involved in drawing back these margins. Thus his marginal estimates of the significance of things on which he still expends his money, relatively to other things in the circle of exchange, are the same as they were; but relatively to things not in the circle of exchange they have taken a lower place. Whatever his income he will always bring his expenditure into equilibrium with the market prices; that is to say, the marginal units of the things he buys will always occupy at the margin the same fixed place on the objective scale of things in the circle of exchange, but on the subjective scale they have advanced to a point of lower significance.

It would be useless to attempt to indicate this change diagrammatically, for, as we have seen, every curve is changed by a change in the supplies of other commodities as well as that to which it specially refers. If we were, therefore, to draw up a man's curve of a certain commodity on the

supposition that he was poor, and then again on the supposition that he was rich, the only fixed point on which we could rely would be that if he continued to consume the commodity at all, he would consume it down to the same point of objective value as before, but that the objective unit would have a lower psychic significance. Whether he would consume more or less of the commodity, whether his surplus satisfaction would, measured in coin, be greater or smaller, and if greater in coin whether it would be greater psychologically or not, and what its proportional significance to his whole satisfaction would be, we should have no means of determining. The two curves, therefore, would have no significant relation to each other. All we can say is that if the man's expenditure is wise, he enjoys a larger total area of satisfaction as the marginal satisfaction which a shilling will command diminishes; but that it really is so would be a rash assumption.

There is still another source of confusion. We have been attempting to evaluate the surplus satisfaction, over and above the sacrifice involved in the payment, which a consumer actually derives, under existing circumstances, from his normal consumption of a given commodity, and to evaluate it in terms of the actual significance of pounds, shillings, and pence under the actual conditions of his resources and expenditure. Our questions as to what he would give for such and such an increment at such and such a margin, or how much he would buy altogether at such and such a price, have merely been a device for discovering the actual value in use that things have for him; and he will not give us the answers we require unless he treats the hypothesis of an increased price as purely ideal and applying to himself alone. For as soon as he begins to think of any actual circumstances under which the price would rise, it will involve the supposition that causes are at work which affect not only him, but others also. And if he imagines that the supply of tea, for instance, is contracted, and that is why he has to pay a higher price for it, he may assume that other people are in the same position as himself; and if that is so, then obviously the general demand for substitutes such as coffee and cocoa will rise, and the prices

Possible confusions from inconsistent hypotheses as to causes of contracted supply.



will rise correspondingly, and the condition "other things remaining the same" will be violated, for he will not be able to purchase the substitutes at the prices for which he can now obtain them. If he is a commercial man he may instinctively take this into account, and give us estimates of what he would do under given conditions, modified by an instinctive sense of what others would be doing under pressure of the causes which had brought these circumstances about. And even the non-commercial student, as he imagines himself retreating towards the origin in his consumption of some particular commodity, often frames half unconsciously some hypothesis to account for the fact, which reacts upon his suppositions as to the supply of other commodities.

Thus when we imagine a curve that rises rapidly as we recede from the actual rate of supply towards the origin we may very generally detect ourselves arbitrarily and tacitly assuming both a gradual (or sudden) exclusion of all natural substitutes and a continued command not only of the strictly complementary commodities but of all the other things necessary to continued life and sensitiveness. That is to say, we begin by considering how much we give for a loaf of bread, all our other supplies and open alternatives being what they are, and consider what inconvenience we should actually suffer if we happened to be "short of bread" one day; but when our imagination travels back towards the origin we not only cut down our supply of bread, but silently cut ourselves off from increased supplies of potatoes, etc., until at last we find ourselves in a besieged city—but always with a good supply of water. And during this process the significance of money has itself indefinitely changed. Money, as we have seen, represents open alternatives. And in a besieged city a shilling represents less and less of the common objects of desire. Many things it cannot get at all. Of many other things it can get very little. The only things of which it may possibly be able to get more than before are such as have little relevancy to our distressed condition and narrowed opportunities—jewels and works of art, for instance. So the value of the unit in which we estimate our rising want as we approach the origin is itself declining, owing to the changed conditions that affect the whole society in which we live.

Thus an attempt to trace an individual curve back towards the origin is legitimate, and its results are interesting, suggestive, and enlightening, in proportion as the condition "other things remaining the same" is observed. But as in the case of any great and essential article or group of articles of consumption we can scarcely imagine the origin to be approached owing to an actual rise in the price while other things remain equal, such curves must depend for their construction on imaginative estimates of the value we ourselves should under present conditions attach to small increments of the commodity at given margins; not on attempts to reconstruct conditions that might really raise the market price to a high figure.

It may well be asked whether a method that needs so much guarding and explaining is worth adopting at all. The answer is that the principle of declining marginal significances is absolutely fundamental. The Essential significance and value of curves of total satisfaction. doctrine of surplus value in the thing bought over and above the value of the price paid, is an inevitable deduction from it. The awakened mind must, and as a matter of fact does, speculate upon it. It underlay the old distinction between value in use and value in exchange. It underlies modern discussions of the significance of a more even distribution of wealth. It is intimately connected with the relation of Economics to life. A want of a clear understanding of it brings perpetual confusion into our speculations and entangles the student in perplexities and contradictions. And it is therefore of the very first importance that we should try to find out exactly what it is and how far it takes us.

Moreover, though we cannot assume a system of curves of total significance to co-exist and to retain its general validity while modifications take place in one or more of the supplies, yet we may assume that, in spite of all the modifications which are perpetually taking place, all the curves of commodities, some supply of which is still enjoyed, continue to be such that in the neighbourhood of the actual supply an advance would mean an increased, and a retreat a diminished, marginal significance. That is to say, at and about the point of the actual supply, the curve, however fluid we may consider its form, will always preserve the property of declining as we recede from the origin.

What we have regarded as a source of disturbance and confusion in our attempts to construct individual psychic curves would become an essential element for consideration in the construction of a curve representing the collective or communal scale spoken of in Book I. (pages 142 *sqq.*). That scale, as we saw, is purely objective, and is not susceptible of any consistent psychic interpretation, though it ultimately rests on psychic phenomena. If we take any given commodity, and ask not how much any individual would take of it at a given price, other things being equal, but how much the community would take, other things being equal, the term "other things being equal" has essentially changed its significance. When dealing with the individual, "other things being equal" would mean that all the substitutes were to be had at their present prices. When we are dealing with the community we cannot mean any such thing. For obviously if the price of any one commodity were seriously changed, the consumption of substitutes or complementary commodities would also be changed, and if this were done on the large scale it must alter their prices also. By "other things remaining equal" then, we must now mean "no changes taking place in the conditions on which other commodities may be obtained, except such as are directly involved in the reactions of the supposed change of price in the commodity under direct consideration." Those changes themselves must necessarily be considered, and the estimates as to how much the public will take of any given commodity at such and such prices must be based on the consideration of the actual effect which the price would have on the general expenditure of the public, at the prices which that general expenditure would determine, if no independent causes changed the supply of other commodities. Dealers might be able to form a fairly accurate estimate of the course the curve would take in the near neighbourhood of actual experience, but might have no means of forming a close estimate at points near the origin, for example, or near the point of intersection with the abscissa.<sup>1</sup>

In such a communal curve of a single commodity, the mixtilinear area above the rectangle of price paid would have

<sup>1</sup> Cf. further pages 531 *sq.*

no consistent psychic significance. It would be made up of satisfactions corresponding alike to the halfpence of Cobbett and those of the millionaire. The figure would merely represent the objective fact that persons could be found who, under existing circumstances, would pay for so much of the commodity at the rates represented by the successive ordinates; and, therefore, the area in question would represent satisfactions for each of which some one would pay the money unit sooner than go without it, but they would have no psychic parity or equality at all.

They are not susceptible of psychic interpretation,

If we compare a communal curve with an individual one, the former certainly appears to have a firmer and more defined significance, for it represents the tangible fact that so much of the commodity would be bought at such a price. But it will be noted that this objective fact is merely the resultant of the play of innumerable psychic forces which take causal precedence of it. It is a perfect illustration of the Aristotelian distinction between that which is first relatively to the observer, and that which is first in the order of nature. The observer of the market who has little concern with psychology finds the phenomena of the market directly accessible, and, if he works back towards the psychic phenomena at all, he does so from the basis of the objective facts. But the apparent firmness of these objective facts really rests on what has perhaps appeared to us the quagmire of the psychic data which are first in the causal order of nature.

though they rest on a psychic basis.

Finally, we have to note that with the collective, as with the individual curves, it is impossible to construct a system the members of which shall be simultaneously valid; for any change in the selection between the alternative points presented by the form of any one curve reacts upon the forms of all the others. If we start with the existing state of things, we might trace a curve for any one commodity, shewing the prices which would result from a reduction of the supply by one-tenth, two-tenths, etc., on the supposition that the supply of all other commodities remained what it is; and then, returning to the supposition of a normal supply of the first commodity, we

Like individual curves they mutually cancel each other.

might trace a curve with respect to a second, and so forth. But the members of the system thus created would each start from the basis of the present state of things and on the supposition that no change took place in the supply of any commodity but the one under direct treatment. The conditions, therefore, on which they are constructed would mutually cancel each other, and only one could be regarded as valid at a time.

### APPENDIX TO CHAPTERS II. AND III.

We have generally assumed that the same curve may represent, with a sufficient approximation to accuracy, both the total excess of satisfaction over payment for a given amount purchased, and also the system of relations between prices and the quantities that would be purchased. But this assumption will not always be justified.

If a man's income rises or falls, he does not increase or diminish his expenditure upon every article of consumption.<sup>1</sup> The consumption of bread *per capita* is likely to be larger, not only relatively but absolutely, in a poor man's household than in a rich one's. Thus a marked diminution in a man's effective income may actually increase his purchases of bread. Now if such a practical diminution is caused by a rise in the prices of articles other than bread, there is nothing surprising in an increased consumption of bread resulting from it. But it may be that it is a rise in the price of bread itself which contracts the man's general resources, and we may then have an apparently anomalous result, for in that case a rise in the price of bread may make him buy more of it; and within certain limits he may therefore take more bread when the price is higher than when it is lower.

This, however, does not affect the principle of declining marginal significance. It still remains true that if the man were deprived of half his stock of bread he would suffer more than twice as much as if he only forfeited a quarter of it.

<sup>1</sup> Cf. page 483.

On the principles finally formulated on page 461, we may construct the curve of marginal significances, shewing the surplus of satisfaction over payment for any given quantity purchased at a given price. But this curve, so far from representing with approximate accuracy the curve of price-and-quantity-purchased, will be of a wholly different character from it. The latter curve will, at this point, be sloping upwards as we recede from the origin. Within certain limits the higher the price the more the quantity purchased; but this will not be because the price is higher, but because the man is poorer. This example is an emphatic warning that no curves which depend for their validity upon the condition "other things remaining equal" can be fruitfully applied to any hypothesis that covers more than a small fraction of the whole area of a man's vital experiences.

Before leaving this illustration we may note that if the rise in the price of bread is caused by a defective harvest, then, the total amount of wheat being reduced, and the consumption of a certain class of the community being increased, it is obvious that there must be a diminution of consumption in other classes of the community sufficient to cover both the deficiency in the crop and the extra consumption; and that means that the poor would outbid the rich for bread to a certain point, as they already completely outbid them for tripe.

If it is true that for a large proportion of the community the curve of price-and-quantity-consumed really has this rising slope in the neighbourhood of the actual supply, it seems possible that the poor may be forced deeper into this disastrous necessity of outbidding the rich as an incidental consequence of "corners" in the wheat-market manœuvred for financial purposes.

There is another case in which portions of a curve of marginal significance will entirely fail to coincide with the curve of price-and-quantity-purchased. We have seen that some curves of marginal significance rise in the region near the origin. Fig. 18 represents such a case. For any price,  $Oy$ , the figure suggests that there are two possibilities of purchase,  $Ox_1$  and  $Ox_2$ . But a moment's reflection will shew that the earlier portion of the curve cannot be interpreted in

this way. To buy  $Ox_1$  would be to sacrifice  $yx_1$  and only to gain  $Oxp_1x_1$ . The curve, therefore, only begins to be a curve

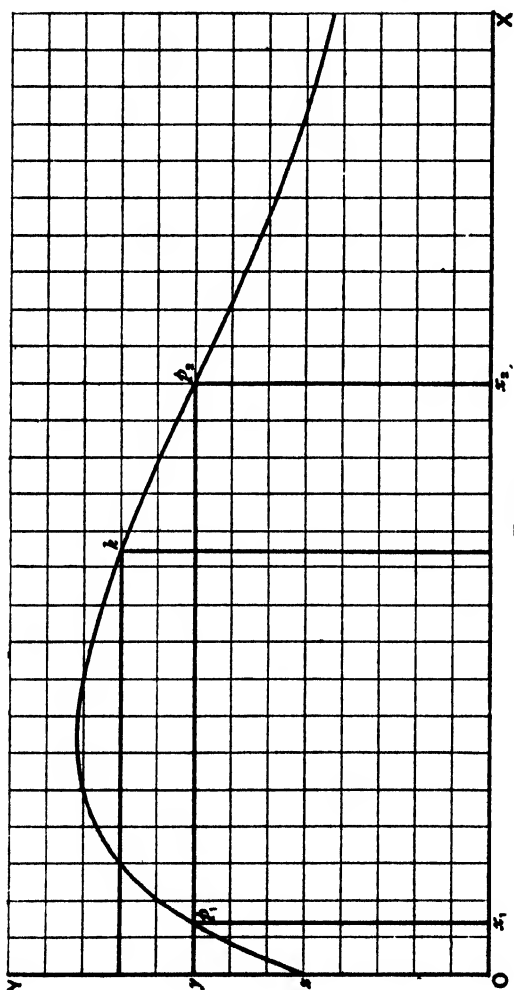

FIG. 18.

of price-and-quantity-purchased after the point  $k$ , at which the total area of the price would equal the total significance of the commodity.

## CHAPTER IV

### BUYER AND SELLER. DEMAND AND SUPPLY

**SUMMARY.**—*This chapter deals with the application of the diagrammatic method of curves to the phenomena of the market. Individual curves of price-and-quantity-taken, if properly constructed for the purpose, can be added into a communal curve, on which the price corresponding to any given supply can be read. A disguised method of reaching the same result by means of intersecting curves is frequently employed, but though legitimate in itself it is misleading when used, as it generally is, in conjunction with a distinction between buyers and sellers, which is irrelevant to the issue. The same principle that determines the flow of any given commodity to the various consumers also determines the flow of the factors of production to the different industries. Capacity for productive effort is distributed between economic and non-economic employments, or is reserved and not put forth at all, on the general principles of the distribution of resources or choice between alternatives.*

We have seen that the curves of the total significance of different commodities to the same individual cannot be added together, though a joint curve of two or more commodities can be constructed independently. When we pass to the consideration of the summation of curves of different individuals referring to the same commodity, we see at once that so far as we interpret them psychologically there can be no sense in speaking of addition at all, for there is no common psychological unit. But so far as we interpret them as curves of quantity-



taken-at-the-price, there seems no reason why they should not be added. If we know the quantity that each individual would take at a given price, we know the quantity that they would take amongst them, and if we know the total supply of the article, we can find the price by determining to what point of relative marginal significance that supply will satisfy all the individuals concurrently.

But here a difficulty presents itself. If the price rises because the supply is reduced, the amount that A will take at this higher price is affected by the terms on which he can get all the available substitutes; but if B is having his stock reduced at the same time as A he will probably run to the same substitutes, and since this will raise their market value A will find that the conditions under which he made his estimates have been violated. We asked him how much he would take at such a price, "all other things remaining equal," and we constructed his curve from his replies; but now we find that (in the normal case) as the price rises all other things do not remain equal, for the price of substitutes rises also; and the modifications which this will introduce into A's estimate of the relative significance (expressed in the objective unit) of the commodity at any given margin cannot be determined simply by analysing his present sense of values, for the terms on which the alternatives will be offered to him will be changed to an extent which he cannot determine and which does not depend on his own estimates of different satisfactions.

It is the dealer's business to forecast the effect which a change in the supply will produce upon the price of the commodity when all these reactions have had their full effect, but he will not individualise the different demands. He will estimate the nature of the sum of all the individual curves, but he will think of it (or at any rate estimate it) as a single thing, not as arrived at by the addition of a number of individual demands. Thus, neither the mind of the dealer nor the minds of the individual consumers contain material out of which we could construct a number of personal curves of price-and-quantity-consumed, which could be added together into a total curve. The dealer's mind contains the material

for the (speculative) construction of such a total curve, but not for the construction of the elements out of which it is composed; and the minds of the individual consumers contain the material out of which the first approximation to the individual curves might be made, but not the material for estimating the modifications which will be produced in those individual curves by the reaction of the changing prices of substitutes, which the dealer estimates in the mass.<sup>1</sup>

Nevertheless, it remains true that these effects, which are only estimated by the dealer in the mass, are actually composed of the sum of the effects on individual demands, and we may therefore conceive ideally of a series of individual curves of price-and-quantity-demanded, in which these reactions have been discounted, and which can therefore be added together.

They will represent for each individual the prices which he would give for each successive increment sooner than go without it, under the modified possibilities as to substitutes which would accompany the contracted supply which caused the rise in price; and the sum of them will constitute a collective scale shewing at what price any given quantity of the commodity could be sold, or what quantity could be sold at any given price, all other supplies remaining constant, though the demand upon those other supplies varies.

In Fig. 19 let (*a*), (*b*), (*c*), etc., represent the curves of one commodity for the individuals A, B, C, etc. On the axis of X the commodity itself is measured in its proper conventional unit, and on the axis of Y the corresponding price or marginal significance is marked. Now take (*d*) equal to the sum of (*a*), (*b*), and (*c*) read laterally. That is to say, for any ordinate of determined length *Oy* the abscissa on (*d*) is to equal the sum of the abscissas on (*a*), (*b*), and (*c*).

Supposing A, B, and C to represent all the potential consumers of the commodity, this would mean that (*d*) represents its collective or communal scale of significance. If we have the three curves and know the total amount of the commodity at command, we can construct the collective curve (*d*), measure off the total supply on its abscissa, as *Ox*, and find the corresponding ordinate *Oy*. This will be the point

<sup>1</sup> Cf. pages 485 sq.

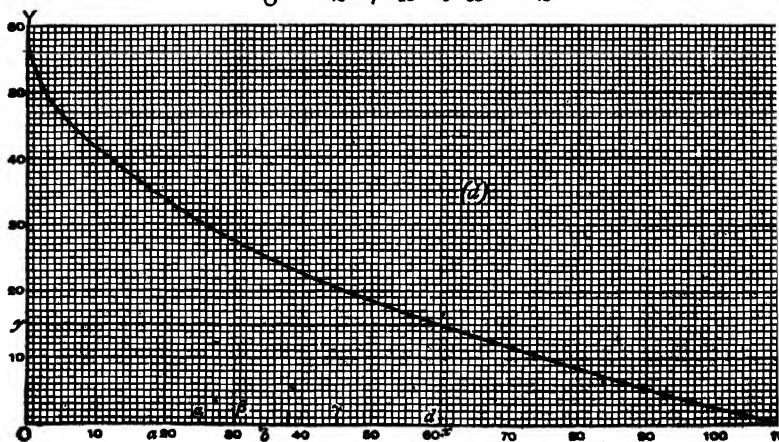
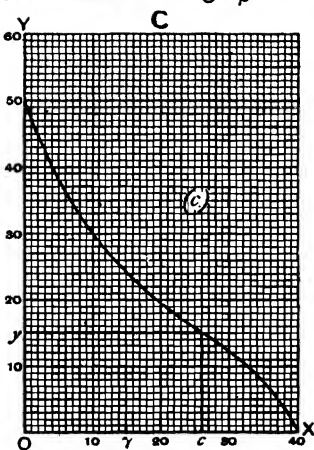
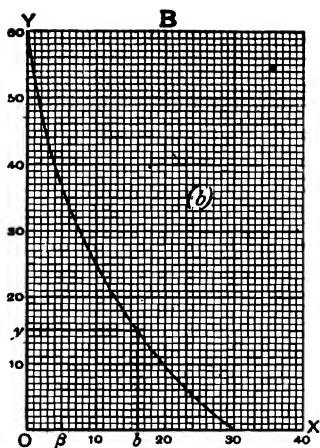
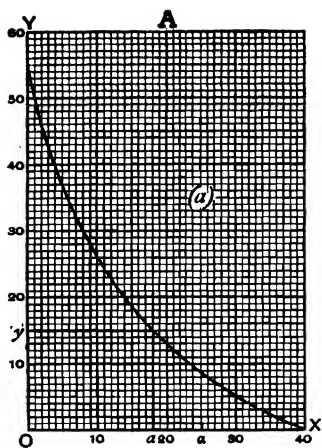

FIG. 19.

of relative significance down to which all the claimants will be satisfied; and we can measure off the several abscissas on (*a*), (*b*), and (*c*) that it will determine. They will shew the amounts of the commodity that A, B, and C will respectively take out of the market. The communal curve will be represented by (*d*), on which equal areas, though they represent satisfactions that correspond to the same objective unit, have not the same psychological significance.

This addition of curves is given primarily as a graphic device for finding that point on the ordinates of the curves which will make the corresponding abscissas amount, in their sum, to the total supply. This distribution is actually determined by the play of the demands represented by the several curves. If the supply were distributed in any other way, there would be no equilibrium, and the conditions of further exchange would exist. But we have seen that the collective curve directly represents the facts of the market in the form in which the sellers actually endeavour to estimate them. They have more knowledge by experience of the collective scale than they have of the individual scales, and each purchaser may find a price ruling in the market which has been arrived at by a direct attempt on the part of the sellers to construct a portion of this collective scale, without reference to the elements out of which it is composed; and the purchaser will then regulate his purchases in accordance with this price. Thus the graphic process of determining the price by finding the ordinate on the collective scale that corresponds to the total supply, and then determining the share that falls to each individual by ascertaining the abscissas that correspond to the ordinates on the individual curves, closely corresponds to the facts of the market.<sup>1</sup>

We may now, therefore, pursue our investigations into the constitution of the market by aid of this system of diagrams. Our figures, so far, have given no indication of the amounts of the commodity (if any) which the individuals concerned possessed before the market opened. And we shall find that no suppositions we can make as to this will affect the result so long as the curves and the total quantity of the supply are supposed to remain the same. If neither A.

<sup>1</sup> Cf. pages 218-219.

B, nor C possesses any of the commodity when he comes into the market, and the whole of the supply  $Ox$  ( $d$ ) is brought in by sellers who have no reserve price, A will be the purchaser of  $Oa$ , B of  $Ob$ , etc. If each of the individuals A, B, etc., already possessed the exact amount that we have arrived at as his ultimate portion, no business would be done at all, and the "price" would be virtual, not actual. But now let us suppose A, B, etc., to possess respectively the amounts  $Oa$ ,  $O\beta$ ,  $O\gamma$ , ( $Oa$ ,  $a\beta$ ,  $\beta\gamma$ , on ( $d$ )). And let us further suppose that an amount  $\gamma d$ , bringing the total to  $Od$  (which we will call  $Ox$ ), is thrown upon the market without reserve. The total  $Ox$  remaining unchanged, and the curves remaining the same, the final distribution will also be the same, but A will have sold  $aa$ , B will have bought  $\beta b$ , C will have bought  $\gamma c$ , and the sellers who are not potential buyers on any terms will have sold  $\gamma d$ .

Thus the initial distribution of the stock affects the amount of business done and the movements that bring about equilibrium; but it does not affect the price or the ultimate distribution, which depend solely on the total amount of stock and the curves of the individuals. If we know what the stock is we know where the ideal equilibrium will be, and if we also know how the stock is distributed we know the extent of the disturbance of equilibrium from which we start; but this latter piece of information does not affect the point of equilibrium itself.

The facts of the market, however, are very generally presented in a disguised form, determined by considerations irrelevant to the result, and fostering what I take to be a mistaken conception of the whole matter. If we had a number of curves to deal with, we might suppose them to be divided (on any or no principle) into two groups, and then reduced by addition to two collective curves. We should then be able to escape the cumbrous process of addition as far as these two curves were concerned, and arrive at the resultant price by the graphically simpler method of intersection. In this case too, of course, it would be necessary to know the total amount of the commodity in the market, and unnecessary to know its initial distribution. Thus in Fig. 20 let us add together in ( $d$ ) all

Intersection  
of curves a  
disguised  
form of  
addition.

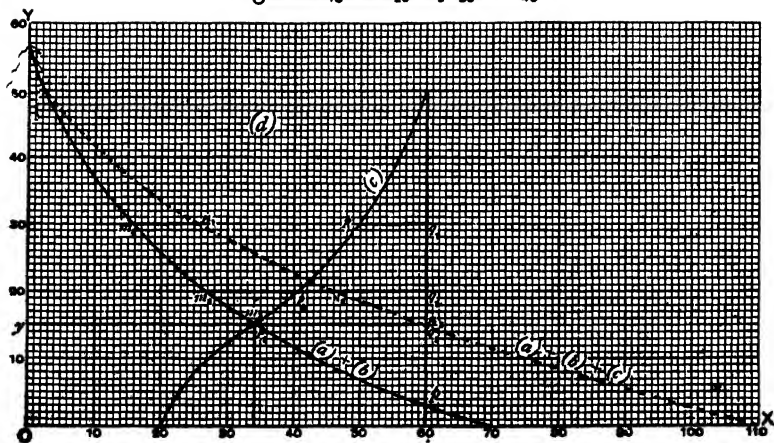
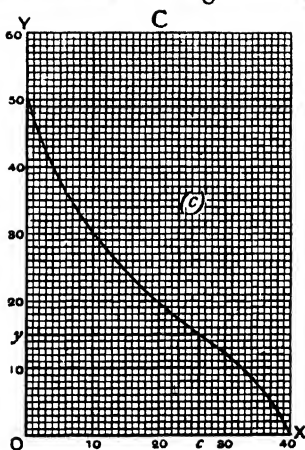
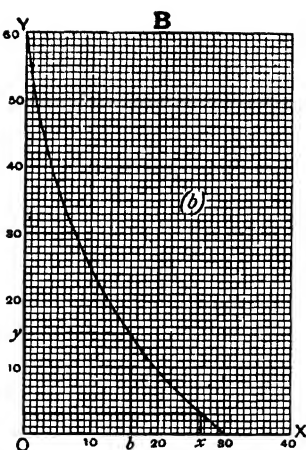
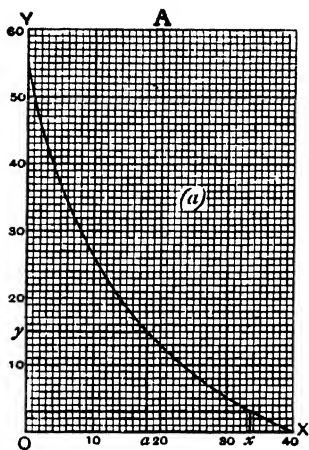

Fig. 20.

the constituent curves except (*c*), and instead of adding (*c*) as before, let us measure  $Ox$  (the total amount of the stock) along the axis of  $X$ , and taking the point  $x$  as the origin of the curve (*c*) let us reverse that curve. The point of intersection will have the same ordinate which we obtained by addition in Fig. 19. This is easily seen from a study of the dotted line, which is constructed, as before, by adding all the curves together. Thus every  $mn$  will equal the corresponding  $pq$ . In the figure,  $p_s q_s$  and  $m_s n_s$  coincide. Therefore ( $Ox$  being the whole amount of the commodity, and the dotted line being the collective curve)  $xn_s$  is the price that was determined by our former method (Fig. 19). And it coincides with the height of the point of intersection of the sum of (*a*) + (*b*) with the reversed (*c*). Every point on every curve has been taken into equal account in obtaining this result; and it does not matter which curve or curves have been reversed. It is the height of each point that affects the result, not the question whether it has been registered and combined with the others in a curve rising towards the left or one rising towards the right.

What we have now got is an ordinate such that the portions of all the curves which are above it have abscissas that collectively make up the length  $Ox$ , representing the total amount of the commodity.

But this method of intersection can only be applied once. It cannot be applied cumuatively, for it confuses the record while registering the result. Thus if we add (*a*) and (*b*), and suppose the stock still to be the same, we arrive at  $xp$  as the price which would rule between A and B if C were not in the market; and having C's curve we can then arrive at the modification in the price effected by C's entrance into the market either by the method of addition or that of intersection. But suppose we had originally treated (*a*) and (*b*) by the method of intersection. We should have arrived at the same result as far as they are concerned (Fig. 21), but we should not now be able to combine it with the data of (*c*). Thus it will be seen that the method of addition is the only fundamental one. Intersection is a disguised form of addition, and this very disguise obliterates the record. We shall see the importance of this more clearly as we proceed.

The methods of addition and intersection may both be applied in cases where our data are less complete than we have hitherto supposed ; for the process of addition may be regarded as beginning at any point of the collective curve which we like to select. Thus, if we knew, for instance, not how much of the commodity A, B, C, etc., possess collectively, but how much more (or less) than would satisfy them down to the urgency represented, say, by 20, and if we knew the course of the curves in the neighbourhood of the 20 point in each case, we

Addition and intersection of uncompleted curves.

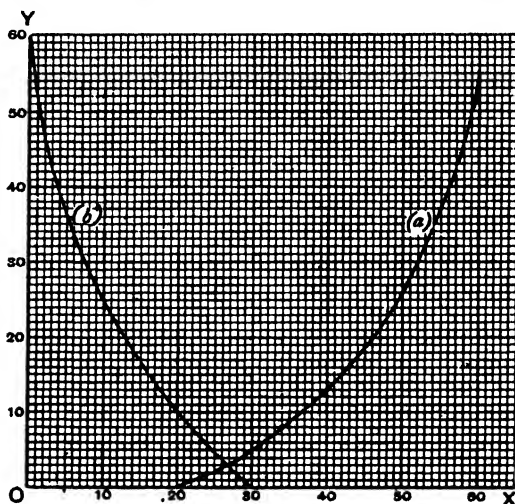

FIG. 21.

should have all the material necessary for determining the equilibrating price that would satisfy all the consumers, and the ultimate distribution of the aforesaid excess amongst them ; but we should not know how distant that point might be from the origin either of the collective or of the individual curves.

We shall enter upon the detailed examination of a case of this kind presently, and it will be seen that it is a perfectly natural one. Our present business is to illustrate it diagrammatically. We are not supposed to have complete knowledge of the curves. We do not know where they start or how they arrive (Fig. 22) at the points in (a), (b), and (c), which



bring A, B, and C respectively to the margins at which the commodity has a value of 20 for them; nor do we know the total amount of the commodity; but we know how much of it is left when the 20 points in (a), (b), (c) have been reached, and we know the course of the curves for some space about these points. Assuming data consistent with those of Figs. 19, etc., let us say that the supply is 14 in excess of that required to bring all the margins to 20. We simply have to add the curves as before, beginning at this point, and we shall

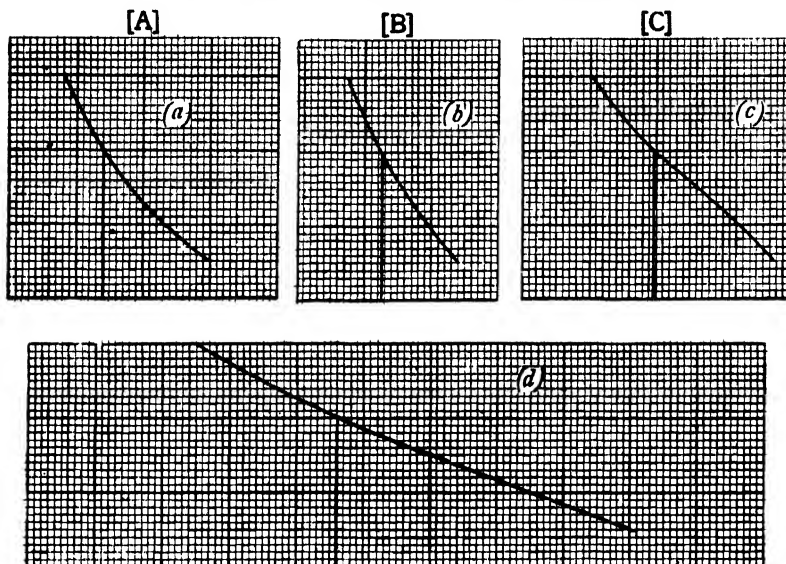

FIG. 22.

obtain a portion of the identical curve (d) which we had in Figs. 19 and 20, only we shall not know how far off the origin is. We measure off the length 14 from this point, and obtain, as before, 15 as the price. If we preferred the method of intersection we could first add (a) and (b), and then reverse (c), making the space between the highest point of (a) + (b) and the highest point of (c) equal to 14; so that wherever the curves intersect we shall have the collective abscissas of all the curves taken together, above the height of the point of intersection, subtending abscissas to the amount of the stock (Fig. 23)

It would be a great mistake to suppose that in such a case the portions of the curve and the stock about which we have no information are without influence upon the result. It is because the total amount of stock is what it is and because the curves are what they are that the whole amount of the stock, minus fourteen, is capable of satisfying all the demands down to the ordinate 20. There might, of course, be other combinations of data which would yield the same result, but that would be a coincidence. At any rate the result from which we start is determined by definite data, and our final result is as much determined by those data, of which we only possess the registered results, as by those which are represented by the fragments of the curves and the surplus of the supply which are given us in detail. What

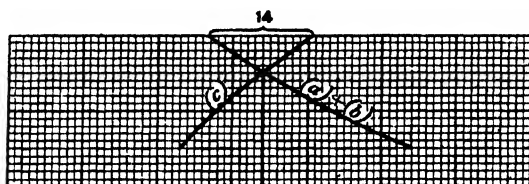

FIG. 23.

ultimately determines the price, then, is the whole amount of the commodity and the character of the individual curves.

We may suppose our information to be given in yet another form. Suppose a whole body of curves (no longer the same body we have represented in Figs. 19, etc.) has been reduced to two (Fig. 24), and we have one of these collective curves given us from the origin onwards (*a*). Concerning the other we are told that the total amount of stock (unspecified), if distributed exclusively amongst the consumers represented by this second curve, would satisfy them to the point with the ordinate 4. The course of this curve upward from the point in question towards the origin is given us for a certain distance (*b*), but we do not know how far off the origin is. We measure 4 on the ordinate of (*a*) at the origin, and then reverse (*b*). The point of intersection will give us the price 17. But this again is only a disguised addition of the partial character that we have just

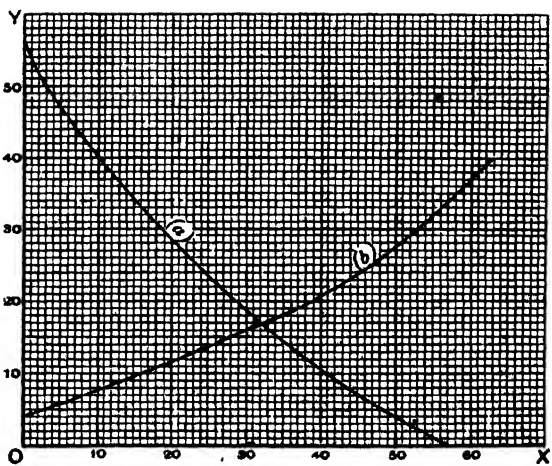
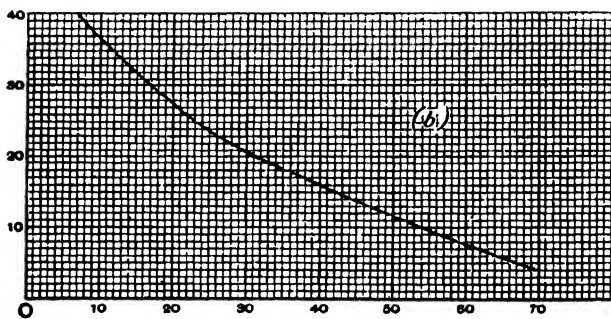
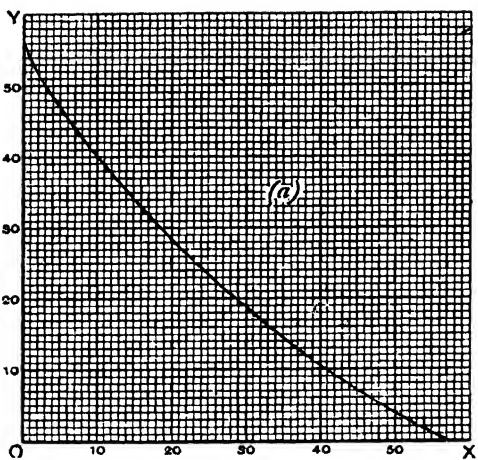

FIG. 24.

examined. We do not know what the quantity of the commodity is, but we know how much it is in excess of any ordinate on curve (b) which we choose to select, within the limits of our information. Thus we know that it is 63 in excess of the amount required to bring the ordinate of (b) to 40, 39 in excess of that required to bring it to 20, and so forth. The reversed curve (b), therefore, will secure that every point is at such a distance from the origin, or highest point of curve (a), as to comply with the conditions specified in connection with Fig. 23; and the data of the latter figure can be reduced to the form presented in the other with perfect

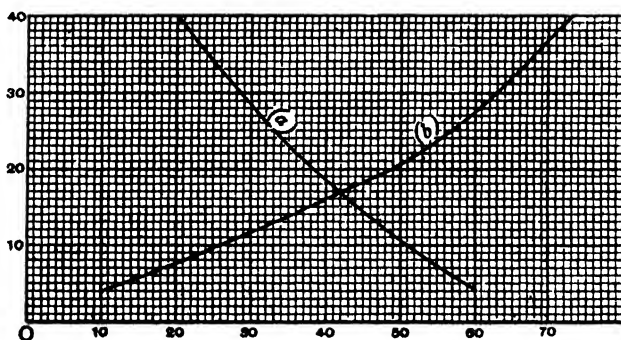

FIG. 25.

ease. The total amount of the commodity required to bring the ordinate of group (b) from 40 to 4 is 63. We know from curve (a) that 10 would be required to bring group (a) to the same point. Starting then at the points of the two curves with ordinate 40 we have  $63 - 10 (= 53)$  as the surplus of the supply; and we can present the two curves from the points of ordinate 40 onwards, with a space of 53 between these two points, and obtain (Fig. 25) the price by intersection precisely as in Fig. 23. But here, as before, the real process is one of addition. We could of course have started at any other point of (b) lower than 40, and the corresponding point of (a), with the same result. In fact our Fig. 25 includes all such alternatives in itself.

We can now understand the exact meaning of the confirmed habit of presenting the phenomena of the market under the form of a curve of "supply" and a curve of "demand."

the intersection of which determines the price. It is based in the first place on a division (irrelevant as we have seen) between those persons in the market who have, and those who have not, a certain stock of the commodity in question. The curve of the latter is given in its completeness, or, at any rate, the origin is marked and the portion of the curve which is sketched is made to begin at a defined distance from the origin. This is called the curve of demand. The other curve is then inserted as a reversed curve, and a definite ordinate is assumed either for the point at the origin or for a point at a defined distance from the origin; and this is called the supply curve. Now this curve is a curve of reserve prices, which, as we have seen,<sup>1</sup> is merely another name for the demand curve of those who possess a stock of the commodity; and its reversal is merely a quick way of arriving at the results of addition. But in connection with it information is tacitly given us as to the surplus of the total stock over the amount required in order to gratify the whole market down to some given ordinate. The connection between these two pieces of information is arbitrary; for the vital information as to excess of supply over that required to bring the ordinates to a certain point, might just as well have been given us in connection with the other (so-called "demand") curve, or partly in connection with one and partly in connection with the other, or without any specified connection with either of them. Thus, if we had not had the two curves given us at all, but only the whole collective curve, without distinction between possessor and non-possessor, and had also been told that the stock was enough to satisfy all claims down to the ordinate of 40 with a surplus of 53, we should have obtained exactly the same result. And if we suppose curve (a) and curve (b) alike to be miscellaneous groups, both of them made up of some persons who possess and some who do not possess supplies of the commodity, we shall still have precisely the same results.

But the distinctions which are irrelevant to the determination of the market price and of the quantities ultimately possessed by the individuals constituting the market do affect,

<sup>1</sup> Pages 229 *seq.*

as we have seen,<sup>1</sup> the specific steps by which the price is discovered and the equilibrium reached. It is in the failure to distinguish between the methods by which that price is *discovered*, and the ultimate facts by which it is *determined*, that the current analysis of the market appears to me to fail. Though the division between buyers and sellers is not absolute (for we have seen<sup>2</sup> that a man may be a buyer or a seller according to circumstances in the same market, and that the buyer may be a possessor of stock also), yet it is undoubtedly the "higgling" of buyer and seller that discovers the actual price. Hence the seductive character of the current representation, and the insidious character of its concealment of the ultimate nature of the market and market prices.

We will now proceed to the examination in detail of examples of the way in which relevant and irrelevant facts are usually confounded in the analysis of markets and market prices.

In his book on *The Economics of Distribution*<sup>3</sup> (pages 11 *sqq.*) Mr. Hobson supposes that in a horse-market there are eight "sellers" (of horses of uniform quality) who have reserve prices running from £10 to £26, Mr. Hobson's horse fair. and ten "buyers" willing to give prices running from £15 to £30. The details may be thrown into the form of Fig. 26. The figure is necessarily defective, for if H will sell at £26 and P will buy at £26, this involves a difference in the place of a horse upon the scales of preference of H and P, but Mr. Hobson does not tell us how great the difference is. It may be less than a farthing; that is to say, it may be that H would not sell at a farthing less than £26, and P would not buy at a farthing more. But that H would sell at £26 shews that he prefers £26 to the horse, though by never so little; and that P would buy at £26 shews that he prefers the horse to £26. A horse, then, stands on H's scale at a little below £26, and on P's at a little above. This is not shewn on our figure; but neither is it necessary for the purposes of our investigation.

Mr. Hobson proceeds to argue that if a price of anything above £21:10s. were set there would be more sellers than

<sup>1</sup> Page 498.

<sup>2</sup> Pages 233 *sqq.*

<sup>3</sup> Macmillan, 1900.

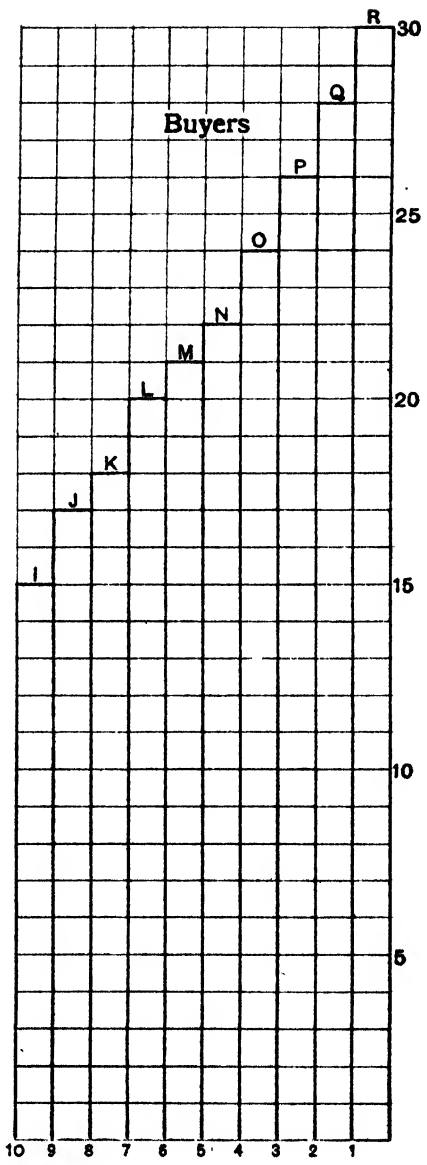
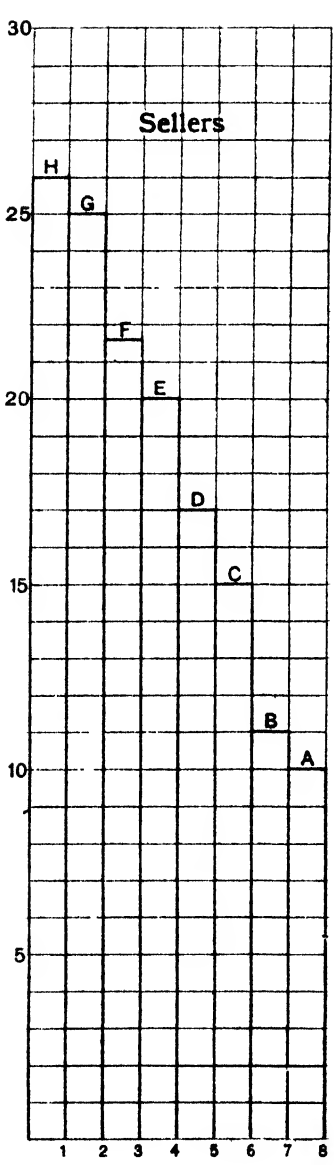

FIG. 26.

buyers, and if anything under £21 were set there would be more buyers than sellers, so that the price would settle somewhere between £21 and £21:10s. Anywhere within this range there would be an equal number of buyers and sellers.

This is all perfectly true, and it corresponds to our elaborate exposition of the market as a machinery for discovering the ideal equilibrating price.<sup>1</sup> But if it is given as a statement of the data which determine that price it is quite needlessly complicated and gives us a number of irrelevant facts. If we know nothing at all as to who possess the horses but know the position a horse occupies on the relative scale of each of the persons concerned, we shall have, on Figure 27, a statement of what prices would rule for any supply of horses from one to eighteen, and shall see that for eight horses it might be anything from £21 to £21:10s.

The relevant facts for determining the price, in the case supposed by Mr. Hobson, are found to be that there are eight horses altogether, and that the places that a horse occupies on the scales alike of A-H and I-R are as stated, and as represented in the diagram. The irrelevant facts are that the eight horses are at present in the possession of A-H, and that I-R are all without horses. When I say that the possession or non-possession of a horse is irrelevant, I mean that it is irrelevant if we know the position of a horse on the scale of preferences of each of the persons concerned. The possession or non-possession of a horse may no doubt affect that position, but so may the man's health, or the health of his wife, or his age, or the fact that his wife has recently read Mrs. Hayes's *Horsewoman*, or that his daughter has read Xenophon *On Horsemanship*, or a thousand other things. There may, in short, be an indefinite number of reasons why the horse occupies just this position on his relative scale, but as long as we know the fact we are indifferent to the causes. Given, then, the relevant facts, you may distribute the items between the groups just as you like. You may arrive at your conclusion by the method of addition or the method of intersection. You may deprive the whole alphabet from A to R of horses altogether, and throw eight horses from some other source upon the market, without reserve

<sup>1</sup> Pages 219-227.



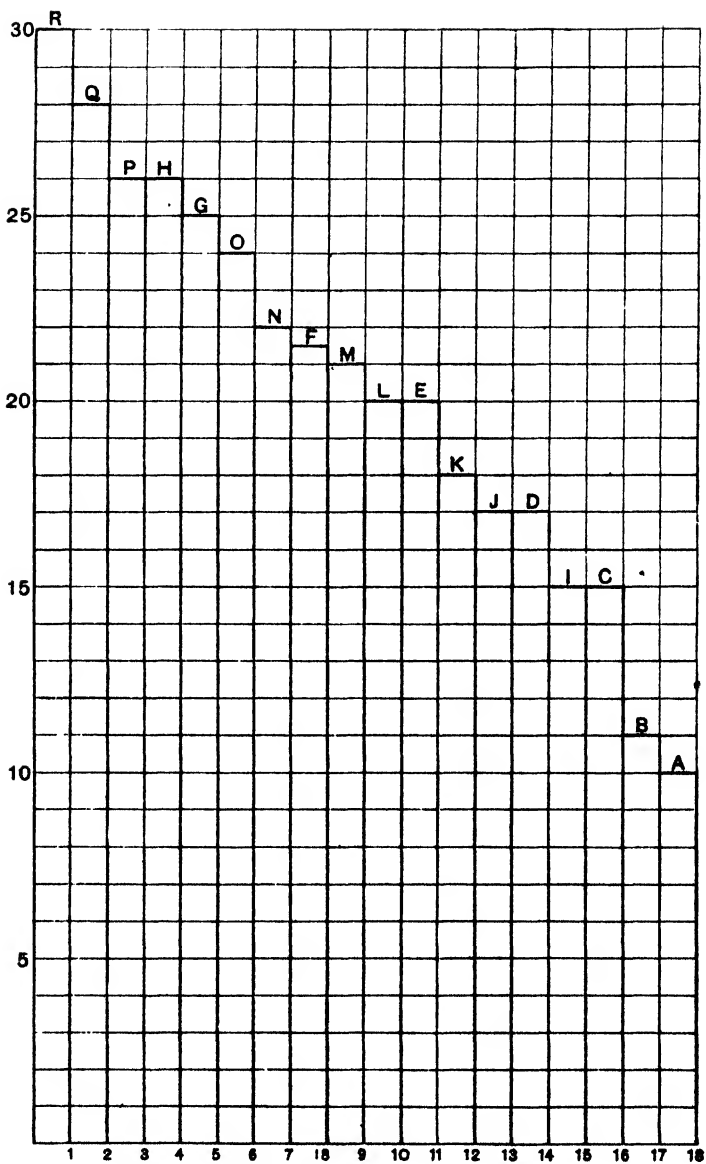

FIG. 27

price; you may suppose that some in group A-H possess horses and others do not; but you will always bring out the identical result that the market price, virtual or actual, will be somewhere between £21 and £21:10s., and that the ultimate possessors of the horses will be H, G, F, R, Q, P, O, N. Naturally. They are the eight persons on whose scales of preference a horse (whether they have him to begin with or not) stands highest, and there are only eight horses altogether.

If the fundamental method of addition is adopted, it is obvious at once that no hypothesis as to which of the persons brings the horses into the market will in any way affect the result, and, on examination, the same will be found true if we adopt the method of intersection. On Mr. Hobson's supposition, group I-R possess no horses, and group A-H possess eight. We know, then, that as there are eight horses altogether, we must so arrange the curves that between the highest of one group, R, and the highest of the other group, H (both included), there shall be eight units, so that whatever the point of intersection may be there shall be eight and only eight letters above it. This will give us Fig. 28,<sup>1</sup> which will bring out the same ultimate possessors of horses and the same prices as we had in Fig. 27. But if we suppose that the eight horses were originally possessed by A, C, F, H, K, L, M, O, and that B, D, E, G, I, J, N, P, Q, R were without them, and proceed by intersection to determine the price and the ultimate possessors, we must again see to it that between R and H (both included) there are eight units, and again we shall obtain identical results (Fig. 29). But this rearrangement of the individuals is really superfluous. We may suppose the down and up sloping series in Fig. 28 each to include possessors and non-possessors, according to the data of Fig. 27. This will in no way affect the result; nor is it necessary to have any information on the subject in order to split up the data of Fig. 27 in any way we like and place the two groups cross-wise, with the interval between their highest members determined by the datum as to the total number of horses.

<sup>1</sup> I have preserved the convention by which the "demand" curve is made to run down and the "supply" curve to run up, from left to right. Of course it has no significance and might just as well be neglected or reversed.

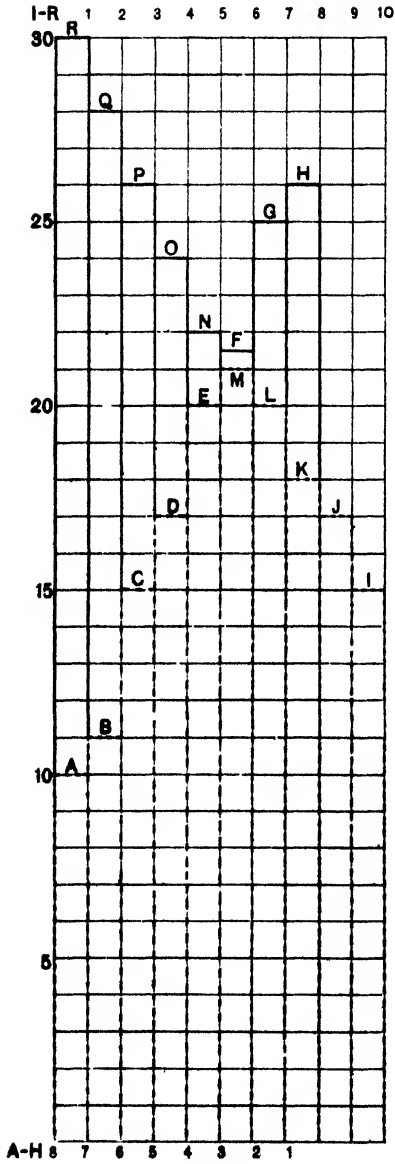

FIG. 28.

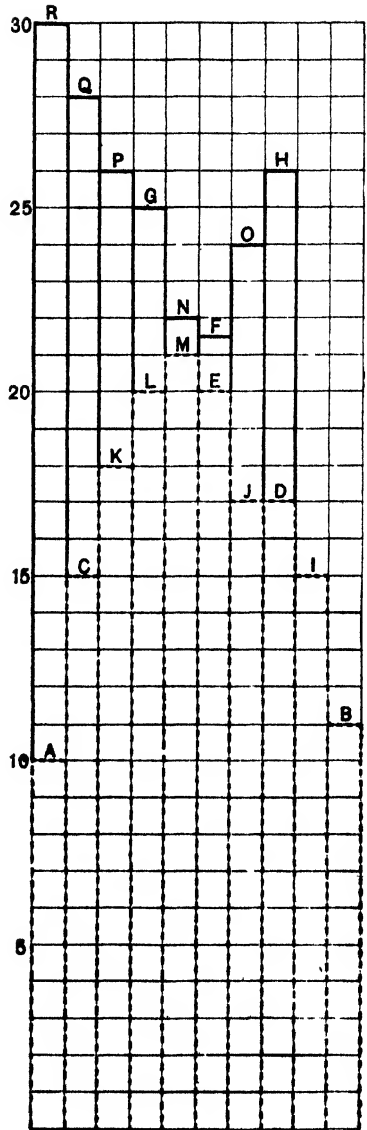

FIG. 29.

It will be noted that Mr. Hobson gives us the whole of the facts. Mr. Marshall (*Principles of Economics*, ed. 3, page 410) has a parallel example in which he only gives some of them. He supposes, in a corn-market, <sup>Mr. Marshall's corn-market.</sup> that at 37s. a quarter there will be "sellers" of 1000 quarters of wheat and "buyers" of 600; at 36s. "sellers" of 700 and "buyers" of 700; at 35s. "sellers" of 500 and "buyers" of 900.

The facts given us may be tabulated thus:—

A	B
Sellers will sell—	Buyers will buy—
1000 . . . . . at 37s.	600 . . . . . at 37s.
700 (keeping 300) at 36s.	700 . . . . . at 36s.
500 (keeping 500) at 35s.	900 . . . . . at 35s.

Therefore (subtracting from the B figures the 600 required to bring the B's to the 37s. point) we find that when all are satisfied down to the point of 37s., it will take—

A	B
300 more to satisfy the A's to the point of 36s.	100 more to satisfy the B's to 36s.
500 more to satisfy the A's to the point of 35s.	300 more to satisfy the B's to 35s.

It appears, then, that in the market altogether there are 1000 quarters more than would satisfy the group A, called "sellers," down to 37s. (for they have 1000 quarters that they value at less than 37s., or they would not sell them at that price). It would take 300 of these to satisfy them down to the point of 36s. (for we are told that at 36s. they would hold back 300), and 200 more to satisfy them down to 35s. What we know of the curve of the group called "sellers" is therefore represented on Fig. 30 (a). As to the group B, called "buyers," we do not know to what point they are already satisfied, *i.e.* we do not know at what price they would begin to buy, but we know that 600 quarters (or 600 more than they already have) would bring them to the point 37s., and then another 100 would bring them to 36s., and another 200 yet to 35s. What we know of their curve, then, from the 37s. point onwards is represented on Fig. 30 (b). In neither case do we know how far from the origins the curves start.

Let us add the two curves, starting at the points with the ordinate 37s. Fig. 30 (c) gives us the result. Now we know that after all parties are satisfied to the point of 37s. there are 400 quarters left; and these will satisfy all parties to the point of 36s. Or we might adopt the method of intersection, placing 400 quarters between the 37s. points of the two curves. The result, of course, will be the same (d). Both (c) and (d) can be constructed and read without reference to the initial distribution of the corn. If all the corn had originally been in the possession of the group A, or if half of it had been in A's possession and half in B's, or whatever the proportion had been, so long as the curves of significance remained the same, and the excess over the amount required to bring them all to the point 37s. remained 400, we should always have the same result. The course of the curves, then, and the amount of the excess, constitute our relevant information—relevant, that is, to the determination of the market price and the ultimate distribution of the excess. The irrelevant information is that the corn is now in the possession of group A.

A psychological objection may here be raised. It may be said that it is impossible that the curve of preference should be conceived irrespective of the possession or non-possession of the commodity. In the case of the horse-market it may be admitted that every man has a more or less determined relative estimate of the significance of a horse, and that we need not inquire how he came to form it. But in the case of the wheat we are asked to suppose that each man has a scale on which successive quarters of wheat are continuously registered with continuously declining significance. Now it may very well be that the man who comes into the market with the intention and hope of selling may buy when he becomes better informed of the facts, or *vice versa*, yet some mental friction would have to be overcome, so that the curve would not decline regularly, but would break at certain points determined by the amount of corn the man possessed. The answer is that this may be, though it need not be, the case; but that in a large market such individual considerations will counteract each other, and the whole body of persons conducting the business will present a sensibly continuous curve.

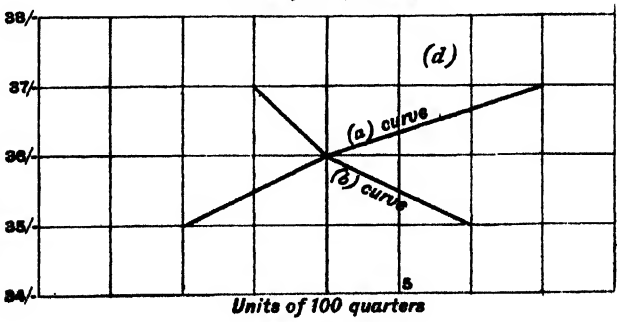
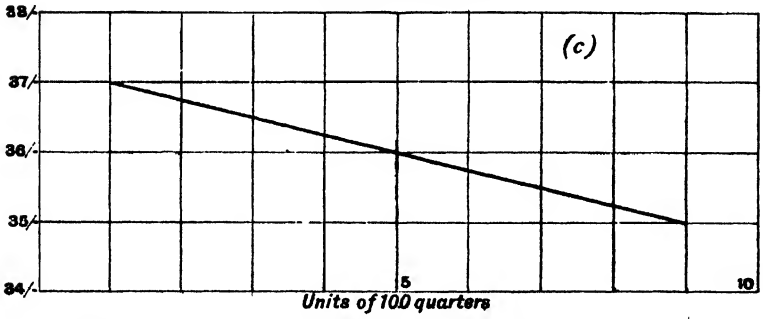
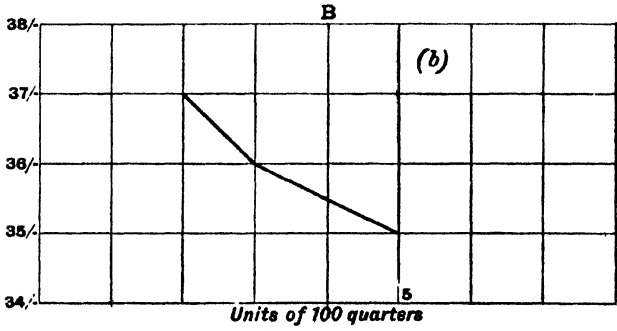
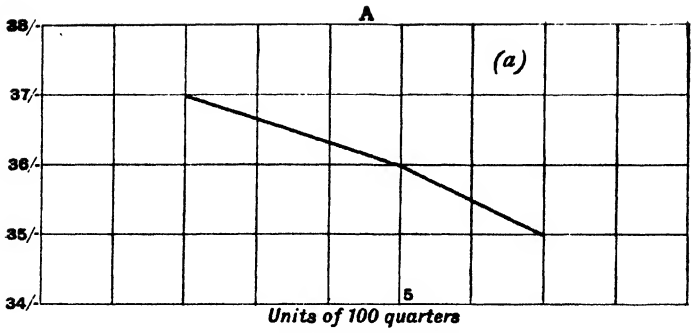

**FIG. 30.**

The final outcome of these investigations is that the diagrammatic method of taking a buyers' curve and a sellers' curve and shewing by their intersection what the market price will be is perfectly legitimate if properly understood, but that if it is supposed to represent the ultimate facts which determine the price, it embodies and emphasises irrelevant matter. If it is supposed that the two curves are different in kind and represent two principles, that they could not equally well be represented as a single curve, or that the transference of any constituent elements from one to the other would affect the result, or that either curve might not contain the register of both buyers' and sellers' preferences, then the method is misleading and mischievous. In the higgling of the market the price *emerges* as the result of the play of a conflict between buyers and sellers as such, which is not relevant to the ultimate facts and forces which *constitute* that price. The method of intersection is, in fact, a mere disguise of the method of addition, and it might ignore the distinction between buyer and seller without affecting the result, as far as price and ultimate distribution are concerned. If adopted to shew the amount of business done under given conditions, the distinction between buyers and sellers and the intersection of their curves is a legitimate method; if adopted to shew the ultimate considerations that determine the market price, it is, to say the least of it, seriously misleading.

Our main conclusions are nothing new. They merely restate the results of the analysis of markets entered upon in Book I. Chapter VI. Given the total supply of the commodity, the market price that any single customer finds established is determined in the main by the demands of all the other purchasers, but in some degree by his own. If his demand is, in bulk, a very small portion of the whole, then its effect on the price will be correspondingly small, that is to say, the total curve will decline so slowly that the addition or withdrawal of an amount of the commodity sufficient to carry this one purchaser from his initial to his final increments will not perceptibly raise its ordinate. And therefore in dealing with any one individual separately we may assume the market price as already fixed by all the other individuals, and may then simply measure it

Restatement  
of the Law of  
the Market.

off on the axis of  $Y$  of the particular curve we are examining, and may draw a parallel to the axis of  $X$  through that point. The abscissa of the point at which this parallel cuts the curve will measure the amount that this particular purchaser will take. We may put it in this way: the amount of any commodity which will flow, in obedience to the economic forces, to the satisfaction of any one consumer's wants will be determined by his curve of preferences, by the similar curves of all the other claimants, and by the total amount of the commodity. This is the general law of distribution.

If we go on to ask what determines the quantity of the commodity, we find ourselves dealing once more with the identical problem that we have just solved. The flow of the productive forces into this or that industry is determined on exactly the same principles as the flow of the stock of any single commodity to the different consumers. To breed horses you need land, buildings, corn, apparatus of many kinds, and trained human faculty. In supplying horses, therefore, you demand all these things. To raise corn you need land, buildings, ploughs, waggons, gates, ships, machinery, and human faculty. In supplying corn, therefore, you demand these things. And so with all other commodities. Thus the supply of any commodity is itself a demand upon other commodities and services, and if we separate out the demand, say, for woodwork implied in the supply of each of the commodities into which it enters, we shall be doing just the same thing that we did when we separated out the demand for potatoes from all the individual budgets of the persons that composed the market. Here, as there, the share that each one gets is determined by the curve representing the urgency of the want it satisfies, by the similar curves of the other industries, and by the total available resources of the community. Thus the supply of any commodity is regulated by the combination of productive factors needed for its production and the rival claims of other commodities for the factors of this combination. Ultimately, then, we have at one end the undifferentiated and unmanipulated forces and materials of nature, the faculties (trained and untrained) of man, and the various modifications of the former

The "supply" of one market itself a "demand" upon other markets.



by the latter, which exist at the moment. This constitutes the total available stock. And at the other end are the tastes and resources of each individual. The amount of the supply, at any moment, of this or that commodity (in its final and united form, or in any of its intermediate states or constituent elements) is determined by the attempts of the commercial community to gauge and anticipate individual wants and to regulate the flow and the combinations of the ultimate sources of supply in accordance with them.

We have seen that all the different items of the ultimate sources of supply, and all the existing products, can, at any given moment, be expressed in a common unit. Therefore, in considering any single industry, we have first to determine what unit we will take to measure amounts of the productive agents. We might take, for instance, the amount that would exchange for an ounce of gold, or a ton of pig-iron, or a quarter of wheat of given quality, or any combination of these or other articles we choose to select. This will be our arbitrary unit-of-products-and-factors-of-production, and as we are now applying it exclusively as a measure of factors of production we will call it the unit-factor of production. The unit of the special product we will take as that amount of it which the unit-factor of production can produce. What will the unit on the axis of  $Y$  be? It will represent the general command of articles in the circle of exchange which corresponds to the ounce of gold, ton of pig-iron, or what not, that we have taken to measure our unit-factor of production. We may think of it in terms of money. It may be a pound's worth or a shilling's worth of anything that is in the circle of exchange, including the factors of production themselves. The curve, then, will indicate the place on the communal scale of preferences of each successive unit of the commodity; and the flow of productive forces into that industry will be regulated exactly as the flow of fish or carrots to this or that purchaser's larder is regulated. It will bring it down to the (objective) level determined by its marginal significance elsewhere. If the total amount of the resources of society which will in any case be deflected to this particular industry is an infinitesimal portion of the whole, we may take this margin as independently fixed.

The curve (Fig. 31) gives us the rate at which the unit-factor of production will satisfy human wants (measured objectively) in this industry at any margin. At what rate (measured by the same standard) will it satisfy human wants

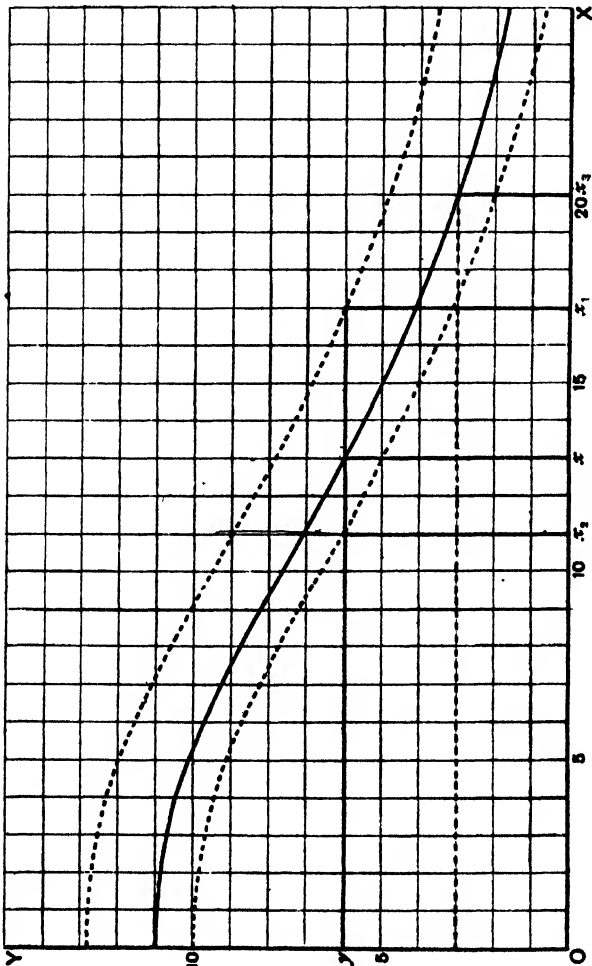

FIG. 31.

in other marginal applications? Whatever that rate may be it can be represented by a line. Measure off that line on the axis of  $Y$ , draw through the point thus determined a parallel to the axis of  $X$ , and the abscissa of its point of intersection with the curve will determine the flow of the

productive resources to this industry, and the corresponding amount of the product. The curvilinear space above this line will represent (objectively) the satisfaction which the creation or destruction of this particular industry would add or subtract from the community. Its revenues of enjoyment (or at least of anticipated or estimated satisfaction) will be increased to that extent by the existence of this industry. It follows, of course, that whereas the communal curves of demand for, say, a certain kind of timber in the furnishing, the building, the shipping trades, and so forth, can be added, under the conditions laid down on pages 494 *sq.*, the communal curves for different commodities (houses, ships, race-horses, diamonds, books, fruit, music, etc.) cannot be added, since each such curve assumes that all other conditions remain the same, and to travel along any one of them constitutes a change of the conditions for some or all of the others.

If the demand (estimated significance) for a commodity increases, as represented by the upper dotted line in Fig. 31,

the product will be increased from  $Ox$  to  $Ox_1$ . If it declines, as in the lower dotted line, the industry will shrink to  $Ox_2$ . If, while the demand remains the same, some invention is made which doubles the quantity of the commodity which could be produced by the unit-factor of production, or, which

is the same thing, halves the amount of the productive forces required to produce the units we have hitherto registered along  $Ox$ , the dotted line parallel to the axis of  $X$  will indicate the quantity which will be produced. We might equally well represent this latter change by retaining the length  $Oy$  unchanged and doubling the height of the ordinate at every point, because the factors that would give the value  $Oy$  in other industries will now be producing the units of our product, and therefore the anticipated satisfactions they yield, at double the previous rate. The unit of  $Ox$ , therefore, will represent twice as much of the commodity, measured in its own proper unit, as before (Fig. 32).

We have now to note that any very extensive departure from the existing state of things might affect the whole constitution of the unit on which we are working, for it might disturb the marginal relations between different kinds

Representation of the effects of a change in demand or in the conditions of production.

of human effort and different products or gifts of nature. And, as the value of anything can only be expressed objectively in terms of something else, changes or discoveries that affect

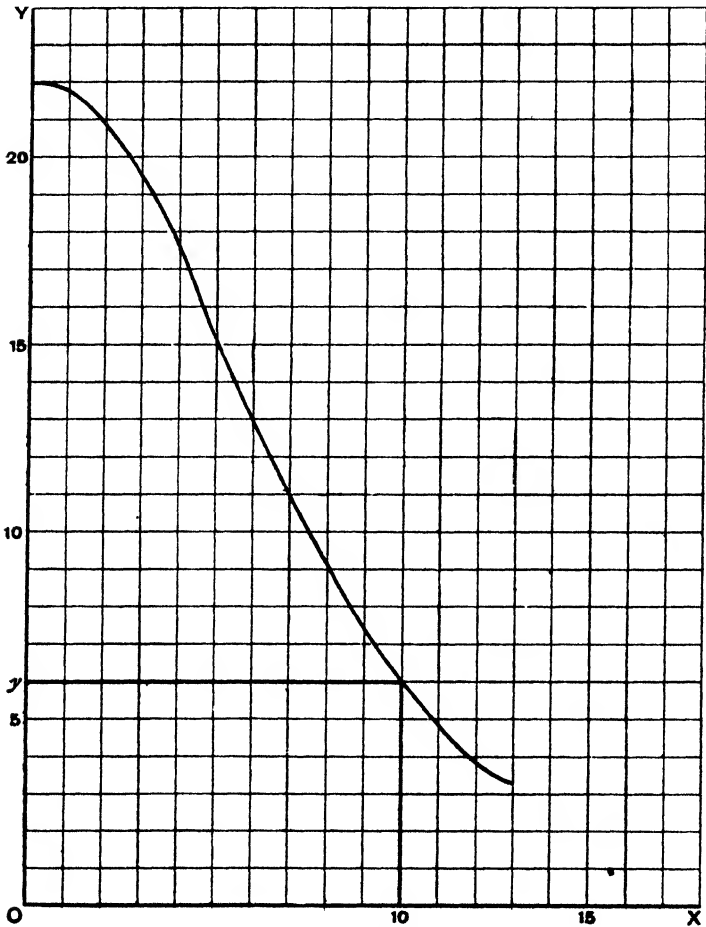

FIG. 32.

the general fertility of human effort, and the significance of natural products and agents, cannot be recorded by any consistent objective method. Further, the diagrammatic illustrations which we have been using can only be regarded as applicable to cases in which we are examining a very

small part of the whole field, so that we may consider the general conditions as stable. An attempt to draw up the whole scale of significance of any one of the main factors of production, carried back to the origin, would of course be quite futile. It would be impossible to imagine the origin at all nearly approached without such a disturbance in other conditions as would deprive our units of all continuous significance.

One other point of theoretical interest remains for investigation here. We have seen<sup>1</sup> that the creation of the

supply of undifferentiated human capacity is to be regarded in the main as itself constituting a branch of expenditure or "consumption." It is determined, at any moment, by the scale of relative significance of this particular form of expenditure, "consumption," or expression of impulse, which has ruled in the past. But the total capacity-for-effort that exists is not employed "economically." What determines the amount that is devoted to the production of things that enter, or might enter, into the circle of exchange? Here, as in previous instances, we must begin with individual curves. Writers who have paid attention to the subject have usually regarded the output of human effort (spoken of under the rather dangerous abbreviation of "labour") as limited by its irksomeness, and have represented its significance (at least after a certain point) as a negative quantity.

We will begin with Robinson Crusoe. Along the axis of  $X$  (Fig. 33) we measure units of effort. The proper basis for such a unit would be foot-pounds if we were considering mere muscular effort, but it will be convenient to take an hour's work as our unit, including all physical and mental effort, and ignoring the fact that during different portions of the day, and so forth, the actual output of effort made per hour, measured by any objective standard, will vary. The  $p$  curve will now represent the marginal significance to Crusoe of the result of successive unit-outputs of effort, and the  $l$  curve will represent the marginal irksomeness of the output of effort itself. The unit on the axis of  $Y$  is essentially psychic, and we may for the present read the figure as

<sup>1</sup> Pages 386 sq.

meaning simply that at the margin of six hours' work per day the value of the product compensates threefold the irksomeness of the effort ; that is to say, Crusoe would make the effort even if its results accrued at only a trifle above one-third the rate at which they actually accrue. Thus the balance is

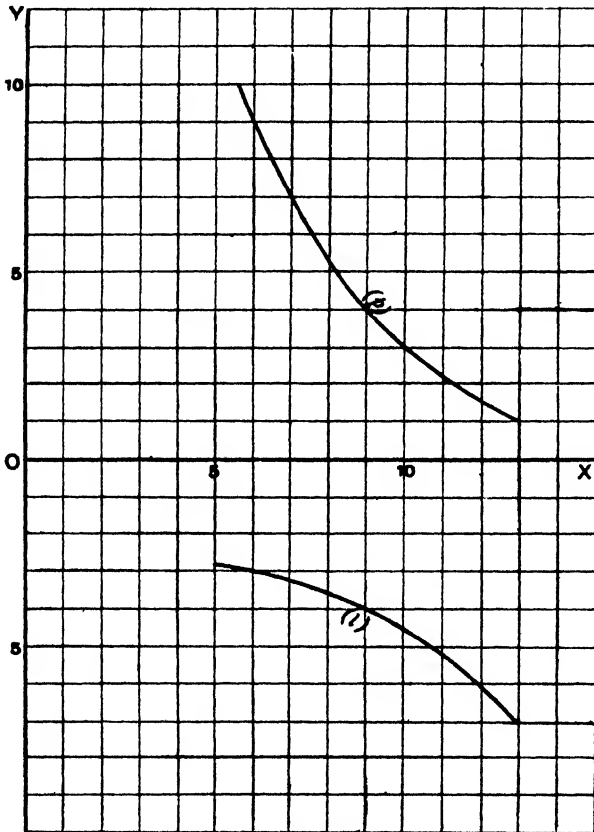

FIG. 38.

favourable up to 9 on the axis of  $X$  ; after that it would be unfavourable, and therefore the output of effort is carried to that point and no further.

Leaving the island and returning to civilisation, we take the remuneration of each man's effort per hour as a datum, fixed by the general laws of the market, and, still reading the

curve psychologically, we find that at the margin of six hours a day the individual whose curve we are examining estimates the advantage of the increased supplies of all commodities and services in the circle of exchange as threefold compensation for the irksomeness of the work that secures them. And the advantage is on the side of doing more work for wages up to nine hours a day, but no further. This, then, is the amount of labour he chooses to supply on the terms which it will command in the market. Well, then, he sells his time with a system of reserved prices, which constitutes his own demand for it; just as the stall-keeper sells her plums.<sup>1</sup> Each individual can get for his work economically as much as his doing it is worth to others, and he will require for it as much as his not doing it is worth to himself. The total supply of any kind of effort is the whole capacity of the persons capable of making it, and this supply is distributed between economic and other applications in accordance with the general laws we have studied so fully.

This way of putting it at once suggests that the man who sells his labour is selling something for which he himself has a demand of some kind, and that this demand should be represented as a positive, not a negative quantity. Reflection fully justifies this suggestion. The irksomeness of the labour by which we earn money is not really the only thing that we have to set against the advantages the money secures. It is only a negative expression of one element in the desirability of rest or leisure. This latter is a positive conception, and it includes all output of effort upon the direct securing of things not in the circle of exchange, as well as rest. Our previous studies<sup>2</sup> of the relations of positive and negative satisfactions and their diagrammatic representation will remove all difficulties from our path in this matter. We may treat "desirability of leisure" as positive, and may represent the *l* curve with positive ordinates, as in Fig. 34. We shall then get the same point as before, viz. 9, by intersection, and shall see that the whole diagram is no more than another disguise of the process of addition of curves.

We may read the *l* curve, whether in Fig. 33 or in Fig. 34, thus:—We have no information as to the total of

<sup>1</sup> Pages 229 *sqq.*

<sup>2</sup> Pages 414 *sqq.*

exchangeable commodities which the man could conceivably secure to himself by his extreme output of effort, reducing his leisure to the minimum requirements of rest and nutrition which would enable him to continue at the same level. But we know that if he had already reserved as much leisure as would reduce its marginal significance to 7, he would still have thirteen hours a day, to distribute between the further gratification of his desire for more leisure and the total gratification of his desire for things in the circle of exchange. The *p* curve shews us that it will take seven of those thirteen

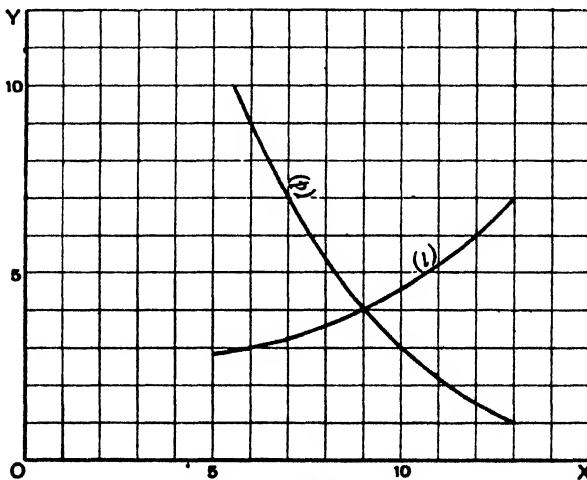

FIG. 34.

hours to bring his desire for things in the circle of exchange down to the point of 7. That is to say, the marginal value of leisure, when eleven hours have been reserved for it, and of the reward of labour, when seven hours have been devoted to it, stand alike at 7. There are six hours more to be distributed between them. Add the curves together from this point, reversing *l* (Fig. 35), and we shall obtain our former result as to the point to which both sets of desires will be gratified. Two more hours will be devoted to work, making nine hours altogether, and four more to leisure, making fifteen hours altogether.<sup>1</sup>

<sup>1</sup> It is necessary, however, to note that in thus reversing our original *l* curve we have assumed a stability in our psychic unit on the axis of *Y* that was not



For obvious reasons we have not carried our curves back to the origin. The assumption that "other things are equal" would be patently absurd at any great distance

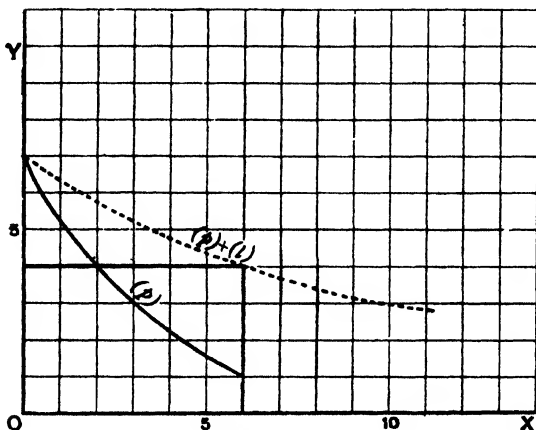

FIG. 35.

from the actual point of equilibrium. Even the range that we have actually allowed our curves to cover can only be justified by considerations of facility of demonstration.

granted in our first construction of the figure. The ordinates of the  $p$  and  $l$  curves for any abscissa were determined with reference to each other, at that point, and consequently our ordinate of 7 for the  $l$  curve, when the abscissa is 13, means that irksomeness of effort (or desire for its cessation) at that point is seven times as great as the advantage accruing from labour at that point. It does not follow that it is just equal to the advantage accruing at the abscissa 7, unless we can be sure that the psychic value of the unit remains stable for  $p$  throughout its course; and we have seen (pages 469 *sqq.*) the extreme difficulty of securing even a fair approximation to such stability in far simpler cases than this. If we retain the form of the  $p$  curve, and reversing the  $l$  curve relate each ordinate to the now corresponding ordinate of  $p$ , we may get a different form of the curve, representing the same relations and the same psychic values. But the point at which the two ordinates are equal to each other must obviously be the same.

## CHAPTER V

### THE THEORY OF "INCREASING AND DIMINISHING RETURNS"

**SUMMARY.**—*The laws of "increasing and diminishing returns," as currently stated, are in no sense co-ordinate, and do not form an antithesis. The use of the terms in economic argument seldom coincides with the definitions given to them. As applied to "cost of production" the conception of diminishing returns is often misleading and confused; and a fatal graphic resemblance between two intersecting curves of demand on the one hand, and a curve of demand intersected by a curve of "cost of production" on the other, has (together with other misleading influences) produced a habit, in graphic demonstrations, of treating increasing cost of production, as the amount produced increases, as the normal case. Other and less academic influences are at work to foster an irrational dread of "decreasing returns" to labour in the near future.*

Diagrams of intersecting curves have been used with many different meanings, and a failure to distinguish precisely between them has given rise to much confusion. Our path to the further investigation of this subject lies through a consideration of what are known as the laws of "increasing" and "diminishing" returns.

In books on Political Economy our attention is called to the following facts. If successive doses or increments of labour (or labour and capital) are applied to a piece of land, we find that, at any rate after a certain point, doubling the amount of labour does not double the product. As we increase the amount of labour, therefore, each successive increment secures a smaller

"Diminishing  
and  
increasing  
returns."

return in the shape of product. This is called the "law of diminishing returns," and is said to apply generally to agricultural and extractive industries. On the other hand, if an industry such as that of the cotton or iron trade so increases that, say, twice as much labour (or labour and capital) is employed in it as before, it will generally be found that the result is a more than doubled output. This is said to illustrate the "law of increasing returns," and to apply generally to manufactures.

When the statements are made thus baldly the reader can hardly fail to see that the two "laws" are in no sense co-ordinate, and cannot be regarded as standing side by side and proclaiming "divisum habemus imperium." The cases are not parallel. In stating the law of diminishing returns, it is assumed that the factor of land is constant, and if, when a number of factors co-operate to produce a result, you double some of them without doubling others, of course you cannot expect to double the result. If you double the pastry without doubling the apples, you do not double the pie. If you double the diners without doubling the dinner, or double the dinner without doubling the diners, you do not double the dining experience. In like manner if you double the land without doubling the operations on it, or double the operations without doubling the land, you cannot expect to double the crop. This principle would apply to manufactures just as much as to agriculture. If, for example, you had doubled the number of hands, retaining the same machinery and buildings, or if you had doubled the raw material without doubling the labour bestowed upon elaborating it, or if you had doubled the labour bestowed on the same raw material, you could in no case expect the exact doubling (or other proportionate increase) of the product. Or if a tradesman doubles his accommodation without doubling his stock and staff, or doubles his stock without doubling his accommodation and his staff, he will not double the effectiveness of his whole establishment. There are circumstances under which any of these operations might more than double the total result. If a business were desperately under-staffed or under-stocked, for instance, doubling the defective factor might more than double the

A false  
antithesis.

effect of the whole; but if doubling any one of these factors without doubling the others exactly doubled the efficiency of the concern, it could only be a coincidence; and "after a certain point" it would certainly less than double it. The "law of diminishing returns," then, is really no more than an axiomatic statement of a universal principle that applies equally to all forms of industry, and to a great range of non-industrial experiences and phenomena as well.

The law of increasing returns, on the other hand, includes all those cases in which economies may be effected in one or more of the factors by increasing the scale of production. There is no kind of parallel or contrast between the two principles. If you double *some* of the factors and not the others you will not exactly double the product (except by a coincidence). If you increase *all* the factors in a suitable proportion you will in many cases be able to secure double the product without more than doubling any of the factors and without as much as doubling some of them.

The law of increasing returns, then, is an intelligible formulating of a very interesting and important phenomenon. Production on a large scale makes certain economies possible. A man who is cultivating 50 acres of land may require a waggon, but if he were cultivating 200 acres he might only require two, not four. And if, instead of supposing one man to increase his holding, we imagine four holders of 50 acres each to be working in co-operation, we may still suppose the same economy to be effected. Or, without any "co-operation" in the technical sense, a man may own a steam thrashing-machine, and may do the thrashing for all the farmers and holders in the neighbourhood more economically than they could do it for themselves; but it is only if there is a great deal of wheat grown in the district that this can be done. No limit seems yet to have been reached to the possibility of economising in one direction or another as the bulk of any industry increases. It seems always possible, at every stage, to introduce some new process of specialising or division of labour, and so to effect some new economy for which the industry was not ripe until it had reached its present dimensions. And note that the phenomenon we are now examining is independent of the question how far the

business of a single concern, or under a single management, may be carried advantageously. The economies which a large volume of production, as such, renders possible are in principle independent of the question whether the industry is in few or many hands.

The principle of increasing returns, therefore, is intelligible and important; and it directs our attention to a significant point in the analysis of the processes of production. The "law of decreasing returns," on the other hand, as ordinarily stated, is, as we have seen, the mere enunciation, with special reference to land, of an axiomatic and sterile proposition. Of course you cannot indefinitely increase a product in proportion to the increase of certain selected factors of production if you do not increase the other factors.

This utter disparity of the two "laws" is sometimes veiled by stating the case merely in terms of "labour," or, it may be, of "labour and capital." Thus it is said that in

Attempts  
to veil the  
disparity  
between the  
two "laws."

agricultural and extractive industries the increase in the output will not be proportional to the increase in labour and capital, whereas in manufactures it will be more than proportionate. But manifestly this is only a partial statement. There is a suppressed assumption that you do not (or a suppressed postulate that you cannot) contemporaneously increase the other factors in the one case, and that you do (or can) increase them in the other. The enunciation of the "law" of diminishing returns, then, reduces itself to a veiled statement, or hypothesis, as to facts. Sometimes writers perceive this, and base their argument on explicit statements as to the actual limitation of the supply of land on the surface of the earth, or place their whole investigation on the footing of a hypothetical isolation, say, of England in time of war. On the relevancy or legitimacy of these statements or hypotheses we may have something to say presently,<sup>1</sup> but meanwhile it is abundantly evident that there is no possibility, along any of these lines, of formulating two co-ordinate "laws," in the proper sense, parallel one to the other. The only "law" is that (within limits that do not appear as yet to have been ascertained or realised) successive economies in the administra-

<sup>1</sup> Pages 533 sq., 539 sq.

tion of the factors of production may be introduced as the volume of production increases. But of course that does not mean that these economies are always such as to secure an increase in the product more than proportionate to the increase of *some* of the factors, if the other factors are not increased at all. The two "laws" therefore hold united, not divided, sway over industry.

But the semblance of a parallel in the statement of the genuine law of increasing returns on the one hand, and of the axiom and the disguised assumption (or hypothesis) which jostle each other under the cloak of a "law of diminishing returns" on the other, has led to a frequent treatment of the two as parallel, and this has reacted upon the conception of the "law of diminishing returns" itself. This "law" accordingly has made a series of masked movements by which it has in some degree approximated itself to a parallelism with the other.

If we were to construct an interpretation of the phrase *law of diminishing returns* in strict analogy to the rational use of *law of increasing returns*, we should formulate it thus:—"There are some industries of such a nature or in such a stage of development that you could double the output without more than doubling any of the factors of production, and by less than doubling some of them; but there are other industries of such a nature, or in such a stage of development, that you cannot double the output except by as much as doubling all the factors of production and more than doubling some of them." This would be an enunciation of two parallel principles which really might divide the realm of industry between them. It would remain to be shewn what industries, if any, came under the latter law. But this completely consistent use of the terms has never, so far as I am aware, entered either consciously or unconsciously into books of Political Economy; and that for a very sufficient reason. The terms in which we have attempted to give precision to the law of increasing returns are not the terms in which we habitually think. "No more than doubling any of the factors of production, and less than doubling some of them," is not a working formula. We might more than double some, but the economies effected by the reduction of others might more than

compensate this increase; and, moreover, the question is complicated by substitutions, by the introduction of totally fresh factors, by the partial or complete elimination of existing factors, and so forth. And in order to make comparisons we need a common denominator to which all these entering and vanishing, waxing and waning factors can be reduced. This common denominator, as we have already seen,<sup>1</sup> we have; and its index is the value in exchange of the several factors, that is to say, their marginal efficiency in other industries; and this we measure in terms of gold. What we practically mean, then, by the law of increasing returns is that in certain industries (or conditions of an industry) an increased output means a cheaper production, as measured in gold values; and, by analogy, we should interpret the law of decreasing returns to mean that in certain other industries (or conditions of an industry) an increased output would mean an increased cost of production.

Here, then, we have an intelligible use of the two terms in a parallel and consistent sense; and in most generalisations

and inferences concerning "industries which obey the law of increasing returns" and "industries which obey the law of diminishing returns" this seems to be what is in the mind of the writers. But the reader will see that by a process of attraction the meaning of the "law of diminishing returns" has been drawn completely away from its original basis. Both laws have effected a masked movement from terms of specific factors of production, measured in their proper units, to terms of generalised productive resources measured in the unit of gold. And the law of diminishing returns has effected a further, and if possible more important movement, from the statement that *if* you do not adequately increase some important factor you must not expect an increase in the product proportional to the increase in the other factors, to the statement that in certain industries it will not be normally possible largely to increase certain important factors or to find adequate substitutes for them, except on terms so unfavourable, pecuniarily, that the net result will be an increase in the cost of production as the volume of the output increases.

Increasing  
and diminish-  
ing cost of  
production  
as the scale  
of production  
increases.

<sup>1</sup> Pages 361 *sqq.*

These ambiguities would hardly have maintained their place in the textbooks had they not been supported by the assumption that in the case of agriculture there really is a normal difficulty or impossibility in obtaining at will an increased command of land, whereas in the case of manufactures there is no such normal and permanent limitation to the increase of any factor. Thus, the axiomatic statement that if you do not increase the land you will not increase the product in proportion to the increase of the other factors, coupled with the postulate that you cannot increase the land, yields the result that you cannot increase agricultural products except at an increase in the cost of production; and this result (flagrantly as it contradicts the facts in many instances) is accepted as representative of an important though undefined class of industries, the characteristics of which are often developed without further challenge, and without examination as to the extent to which such industries, or such conditions, actually exist. The generalisation, which still seems to pass loosely current, that the law of "increasing returns" applies to manufactures and the law of "decreasing returns" to extractive and agricultural industries, when translated into terms of cost of production, seems to derive little or no support from history, nor is it easy to apply it to the analysis of the actual phenomena of industry. It is true, of course, that land is ultimately limited in quantity, but at present there is plenty of land to be had for any specific use, either by withdrawing it from other uses,<sup>1</sup> or by taking in fresh land not at present used for anything. And, on the other hand, if any specific manufacturing industry calls for an increase of labour, that labour can only be had by being withdrawn or withheld from other occupations, or taken up from labour-power that is not at present being used at all. As a matter of fact, no practical difficulty has been found in increasing to any required extent the area of the earth's surface applied to the production of wheat. And seeing that the men who, in an English manufacturing centre, construct thrashing-machines or other agricultural implements for use in Russia, are just as truly and certainly taking their part in the agricultural industries of Russia as the peasants who are on the spot,

<sup>1</sup> Cf. below, page 540.



we cannot even say that the land of the great wheat-growing countries of the old and new worlds is out of the reach of the inhabitants of English cities; for they are actually harvesting the crops. In truth, the great industry of wheat-growing might be taken as affording a typical example of the economies of large scale production, and the abundance and cheapness of wheat in the world market indicates the fact. And, on the other hand, it is monstrous to assume it as self-evident that all the factors of production in a manufacturing industry can be increased at will. The raw material of many of them, as of the cotton industry, is itself an agricultural product, and none of them can at short notice indefinitely increase the factor of adequately skilled labour.

The most general case alike in manufactures and in extractive industries appears to be that a large and sudden increase of output must be made at an industrial disadvantage, because the supply of one or more important factors cannot be largely increased at a moment's notice. The increase, therefore, must be made at more than proportional sacrifice, since the proportions of the factors will necessarily be disturbed; and unless a sufficiently higher price is offered an increased product will not be forthcoming at all. On the other hand, if an increased demand continues for a long period, an increased flow of all the requisite factors will set in, and ultimately the advantages and economies of large production, with the factors of production duly balanced against each other, will be realised. Hence, whether in agriculture or manufactures, it seems to be a fairly general rule that when an increased demand causes an increased production that presses against the existing limits, at first cost of production will rise, but ultimately it will fall. There may, of course, be numerous and important exceptions; for there may be real and permanent difficulty in increasing the supply of certain materials; but the cereals, and generally the great vegetable staples, are a singularly unfortunate example to allege. Here at any rate there is no theoretical difficulty, and has been no practical difficulty, in increasing all the factors of production *ad libitum*.

We are now in a position to examine various diagrammatic

Contrast  
between the  
immediate  
and the  
ultimate effect  
of increased  
output on  
cost of  
production.

methods which have been employed to exhibit the relation between value in exchange and cost of production, determining the normal price of an article by the method of intersection. It is usual to speak in this connection, as in that of the market,<sup>1</sup> of a demand curve and a supply curve, but to distinguish between the cases that illustrate diminishing and those that illustrate increasing returns. Thus, we might take Fig. 36 to illustrate the case of an industry following the law of increasing returns. This would mean that if the quantity  $Ox$  of the commodity

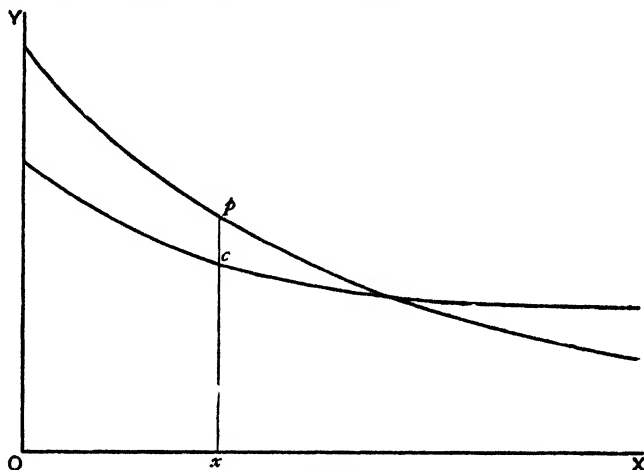

FIG. 36.

were produced its market value would be  $xp$  per unit, and the cost of production of a unit would be  $xc$ . Under these conditions there would obviously be an inducement to extend the industry. As  $Ox$  increased  $xp$  would, of course, fall. But so, by the action of the law of increasing returns, would  $xc$ ; for as the output increased, economies could be introduced which would bring down the cost of production. There is a limit, however, to the decline of  $xc$ , whereas there is no limit to that of  $xp$ , and therefore a point of intersection must ultimately be reached. If the production were carried beyond this point, the cost of production would be greater than the price; that is to say, the effect of applying the necessary combination of

<sup>1</sup> Page 504.

factors of production at the margin of this industry would be the sacrifice of (objectively) higher values at the margin of other industries; and there would consequently be a tendency for these factors to flow from this industry to others, and so to contract the supply.

We may note, once for all, that what appears to be in the mind of writers who use this diagram is prevailing cost of production as measured in the standard unit (gold). But as the distinction between this measurement and the measurement of the factors of production themselves, in their proper units, has seldom been kept steadily in view, there has naturally been some ambiguity in this matter.

Apart from this, we must carefully note that the two curves cannot be interpreted in the same manner. The demand curve represents a group of facts or possibilities which all of them exist contemporaneously. It is a synopsis. The high values near the origin represent possibilities as to market price, should an isolated change take place in the supply of this particular commodity, and they represent actualities in the shape of the (objective) value of certain units of the commodity to the persons who actually consume them; whereas the supply curve does not represent a series of co-existing facts. It is not true that some units are produced at the high cost represented by the points of the curve near the origin. The economies resultant on the larger output affect the conditions of production generally, and if the amount produced is  $Ox$ , the cost  $xc$  (except for temporary and individual reasons) will apply to one unit as much as to another. Scrupulous writers are also careful to note that the curve is often used with a historical significance, and in that case the high values near the origin no longer represent even potentialities in case of a reduced supply, for many of the economies which have been effected are permanent and might be applied even to a smaller supply. The supply curve, in such a case, represents a historic development on which the industry has travelled forward, but on which it could not travel backward without modification. This being so, it would be an altogether grotesque supposition that during the whole of this historical process the demand curve had remained constant. Thus the two curves could hardly

be regarded as co-existing on the same plane, and no satisfactory interpretation can be given to their intersection.

It is undoubtedly true, however, that in some cases economies can at once be effected, if the scale of production is increased, without awaiting the elaboration of new methods. In such cases all the possibilities represented by the declining cost of production curve may be conceived as actually co-existing, *qua* possibilities, though not as actualities. In the same way an amount-of-the-supply and market-price curve represents a series of prices that co-exist as *possibilities* but not as actualities; whereas a curve of marginal significances represents, if properly constructed, a group of co-existing *actualities*. With these limitations a curve (as in Fig. 36) may be accepted as theoretically giving a closer approximation to the truth than the straight line of Fig. 31, in cases where the whole curve of demand is given from the origin onwards, or in which a large part of the whole curve is under consideration. Within the limits of actual oscillation, while "other things remain the same," a straight line will often best represent the facts.

The case is far worse for the application of the method of intersection of supply and demand curves, as in Fig. 37, to instances that are supposed to illustrate the "law of diminishing returns," and this unfortunately has been its favourite application. We have seen that it is normal for a sudden increase in the demand which provokes a sudden increase in the supply to meet with the check caused by the difficulty of suddenly increasing certain of the factors of production, whether land, or skilled labour, or elaborate machinery, or premises. Hence an up-sloping curve will represent the immediate effect on cost of production of an expansion of the supply. We have seen, however, that these effects are transitory. It is only a question of time; for if time be given, all the factors of production will probably be made to flow into this particular industry in proportions corresponding to, if not identical with, those that prevailed before; and the increased scale of production will give scope to all the usual economies. Broadly speaking, then, the up-sloping curve of

Legitimate  
use of  
intersecting  
curves to  
illustrate  
"increasing  
returns."

Confusions  
and errors in  
their use to  
illustrate  
cases of  
"diminishing  
returns."

supply, as contrasted with the down-sloping one, represents not a class of industries, but the condition that the increased demand is recent and has been sudden. There is not only a difference but a contrast between the immediate and the ultimate effect of an increased demand accompanied by an increased supply. The obvious application, however, of the up-sloping curve of supply to the *immediate* effects of an increased demand has, I think, misled students into the assumption, never sufficiently examined, that there is a large and normal class of industries to which this form of curve *permanently* applies.

The remark which has been made with reference to Fig. 36 is also applicable here. The lower curve represents a succession of facts and is not a synopsis of co-existing ones. Lower ordinates of the supply curve nearer the origin do not represent any actual facts which exist contemporaneously with those represented by the ordinate of the point which the production has actually reached; whereas the higher (objective) significance of the units nearer the origin, as represented by the demand curve, does represent facts that co-exist with the lower objective significance of the marginal units.

But the same form of curve has often been used for quite a different purpose to which this last objection does not apply, but which is open to other objections still more grave. If we select some factor, such as land, to exclude from consideration, and then draw a curve on which we arrange the individual units of the product in order of the proportion in which they depend on this factor and not on the others, we shall again obtain a curve of the form presented in Fig. 37. Thus, if land were the factor excluded from representation in our supply curve, we should register at the origin that individual unit, say of wheat, which had been produced by the smallest output of labour and capital because it was raised on the most fertile land; that is to say, the land employed in its production, having the highest marginal efficiency, would have been combined with the smallest amount of the other factors.

In every industry the different units will be produced under very different conditions, and when they are brought to market the ratio in which wages, rent, transport, expenses

of management, and so forth, enter into their costs of production will be different in each case, whether we measure some or all of these agents in their proper units, or measure all of them in the general standard (gold). And we may of course arrange them if we like in the order dictated by the proportion in which any one selected factor or factors (or all the factors except one or more selected ones) have entered into the process of their production. We should then have a curve of the form represented in Fig. 37. Here the ordinate of a certain unit would not be  $xc$  because the

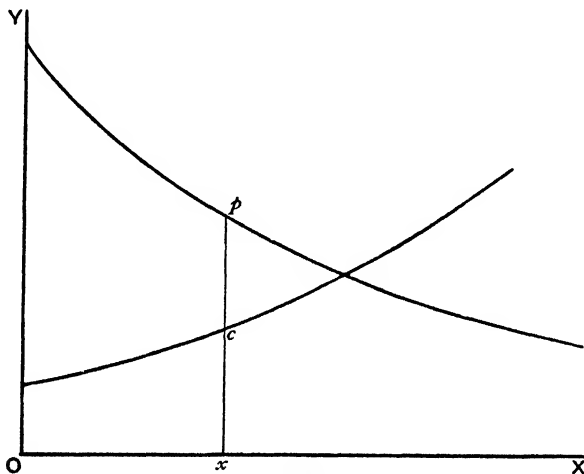

FIG. 37.

total number of units produced is  $Ox$ , but that particular unit would be registered in that place because its ordinate is  $xc$ . It is as if you were to collect a number of men and arrange them in order of their heights. A certain man would not be, say, 5 ft. 11 in. because he was the twentieth man originally brought in, but would be put into the twentieth place because he was 5 ft. 11 in.

The habit of treating land as something wholly exceptional that does not enter into production on the same footing as other factors has led to a frequent use of this form of diagram as though it represented cost of production. It will be worth while to dwell on this point for a moment. It is usual to speak of wheat which has been grown on specially fertile

ground as having been raised "under favourable conditions." This is quite natural and intelligible in itself, but if we translate it into a statement that the cost of production of this wheat has been less than that of other wheat grown on less fertile ground, we at once land ourselves in a tangle of confusion. There is no presumption that the cost has been less to the man who raised it, for he has had to pay higher rent for the more fertile land. Nor

is there any reason to suppose, from the communal point of view, that a smaller sacrifice of open alternatives has been made for this unit of wheat than for any other. Just as

in a broad generalisation we assume that labour might be withdrawn from the margin of any one industry and applied at the margin of other industries, not indeed without loss, but without great and conspicuous loss if the transfer were

only small, and with a loss that diminishes without limit as we suppose the transfer to be smaller, so we must also assume that if land were withdrawn in small quantities from any given use, agricultural or other, it could be applied to some other use where it would be only a little less valued. The cost of production of any commodity, as we have seen, is determined by the significance of the alternatives sacrificed in its production, and there seems to be no kind of justification for excluding land, and the other purposes that it might have served, from the cost of production either of wheat or of anything else. If we ask the origin of so strange a practice as that of excluding land (which, moreover, we cannot separate from capital) from consideration when estimating the cost of production, the answer seems to be as follows: It was taken as an axiom that cost of production determined the value of the product. It was then seen that wheat raised upon land for which a high rent had been paid sold for no more than wheat of the same quality that had been raised on inferior land. Hence the syllogism: "Cost of production determines exchange value; rent does not affect the exchange value of wheat; therefore rent is not part of its cost of production." The major premise was false and the conclusion absurd, but so firmly was the premise established as an axiom that even

The use of an up-sloping curve to indicate increasingly "unfavourable conditions."

Aftermath of the "cost of production" fallacy.

a *reductio ad absurdum* did not lead to its revision. The argument, such as it is, would of course apply just as much to labour, raw material, or capital, as to land. For some wheat less has been paid in wages than for other wheat of the same quality; it would follow that if cost of production determines exchange value, wages are not part of the cost of production. The general truth is, as we have seen, that the value of the factors of production is derivative from the value of the product. The price or hire of some land is higher than that of other land because its products or services are more valued, but the same is true of all raw material and of all kinds and grades of skill. Their value is derivative from the value of the commodity, or ultimately the experience, they produce. This derivative nature of the value of factors of production was perceived in the case of land earlier than in other cases; and thinkers who were still under the impression that in general the product derived its value from the value of the factors of production, and who perceived that this was not true in the case of land, at once set land on a footing of its own, with the resultant confusions which we have been examining.

A certain semblance of rationality has been given to this arrangement of the units of wheat in the order of the decreasing ratio in which the cost of land stands to the cost of the other factors in their production, by dwelling on the idea that the most fertile land is likely to be occupied first, so that every extension of agricultural industry will be from more to less suitable land; and then the reaction of the considerations already dwelt on<sup>1</sup> in relation to the immediate effect of a rise or fall of demand has enabled writers to pass from this specific conception of progressive recourse to inferior land in wheat-growing to the general conception of the necessity of progressive recourse to less and less favourable conditions as any industry expands; and so again a rising curve has been taken, without adequate examination, as representative of a large and normal class of industries. But this whole conception is illusory. The conditions that are favourable or otherwise to any particular industry are constantly changing, and an increasing scale of production is itself a factor in the change.

<sup>1</sup> Page 538.



A man may be at a positive disadvantage because he set up his machinery yesterday as against the man who is to set it up to-day. Manitoba may offer more favourable conditions for growing wheat for the London market than Essex does. It is quite as likely that the established man has to work at a disadvantage because he is committed to less favourable conditions than are now open, as it is that the man who is entering upon the industry is at a disadvantage because he finds all the most favourable sites and conditions preoccupied.

But probably the most deeply seated of all the predisposing causes which keep the up-sloping curve of cost of production

in favour is one that has no connection whatever with the theory of decreasing returns. Neither of the intersecting curves of Fig. 20, on page 499, has any connection with production, or cost of production, at all. Yet one of them slopes up as the other slopes down. If we place all the holders on the up-sloping curve, so that all the "supply" is in the hands of the persons whose desires it represents, it is easy to fall into the habit of calling it the "supply" curve. We have seen that it is no such thing. It is the demand curve of a certain number of the persons in the market arbitrarily grouped together. The supply is not represented by a curve at all, but by a length on the abscissa. But once use crossing curves to illustrate the determination of the market price, and call the up-sloping one the "supply" curve, and you have at once a figure that you can transfer bodily, and without knowing that you are doing it, to the illustration of the regulation of "supply" as determined by cost of production. Thus crossing curves may come to be used indifferently to represent "demand and supply" or "demand and cost of production," the term "curve of supply" may be used indifferently in either case, the up-sloping curve of the one (which is merely a down-sloping curve of exactly the same nature as the other, reversed for convenience, and having no constitutional connection with "supply" whatever) may be transferred to the other; it may then be read as a curve of diminishing returns and increasing cost of production, and may create a habit of mind to which cases of "increasing return" present themselves as graphically inconvenient phenomena which must be recognised from time

A false analogy imported from intersecting demand curves of "buyers" and "sellers."

to time but can generally be comfortably neglected. A more disreputable origin for a respected figure in the economic world it would be difficult to conceive!

It remains true, however, that there may be industries in which an increased volume of production must normally imply increased cost, and under the limitations insisted on in the parallel case of decreasing cost of production<sup>1</sup> such industries might legitimately be illustrated by a diagram such as that of Fig. 37. But when this very ambiguous diagram is employed without examination to represent unspecified industries that obey the "law of decreasing returns"; when that law, as originally defined, has been the mere statement of a truism that applies to all industries; when the unwarrantable exclusion of rent from a place amongst the costs of production, and unwarranted assumptions and delusive analogies as to increasingly unfavourable conditions and as to the nature of supposed "supply" curves, have presided over the construction and the interpretation of the curve and strengthened its hold on the imagination, and when purely geometrical deductions from it have then been applied to important practical matters, it is surely time to submit all the emergent theories to a thorough revision, based on a severely precise definition of the meaning to be assigned to the curve, and a demonstration that it actually represents an important body of industrial fact.

We may now summarise our results. A curve representing the conditions of increasing or diminishing returns, if properly constructed, would be an attempt to register a continuous series of changes of the nature of that represented by the transition in Fig. 31, page 519, from the unbroken to the dotted lines parallel to the axis of  $X$ . It might be in the same sense (increasing returns) or in the opposite sense (diminishing returns) to what is there represented. It would have no connection or relation whatever to the up-sloping curve on Figs. 20, etc.

A final word as to the processes illustrated in Figs. 19, etc., may be introduced. We must distinguish between the process by which the ordinate  $Oy$  was obtained, and the merely graphic presentation of the quantities which each

<sup>1</sup> Page 537.

of the consumers, A, B, C, etc., will take out of the market. The height  $Oy$  was only obtained by a process which involved the securing by A of the precise amount  $Oa$ , and by B of the precise amount  $Ob$ . These amounts were determined by the form of the curves ( $a$ ), ( $b$ ), etc., and the device of adding them together indicates that a claim is met or is not met, without reference to whose claim it is, according as its position is high or low on the relative scale. The shares which A, B, etc., have respectively taken in determining the final result are registered on the curves ( $a$ ), ( $b$ ), etc.; but though the results may be registered separately, the process could only be conducted in combination. We start with the marginal significance of the commodity to A at about  $8\frac{1}{2}$ , to B at  $36\frac{1}{2}$ , etc., and we learn from combining all the curves that if the total quantity of the commodity is  $Ox$  ( $d$ ), the market will tend to bring the marginal significance to all the consumers to the magnitude  $Oy$ , and in proportion as its action is frictionless and effective will actually do so.

In the same way if we take any individual industry, the price is determined by the collective curve of demand and the quantity possessed. This corresponds to the ordinates of the points  $a$ ,  $\beta$ ,  $\gamma$  in the curves of Fig. 19. It may be, like the ordinate of  $\beta$ , above, or like the ordinate of  $a$ , below the ideal equilibrating ordinate, but the curve itself enters, together with other curves, into the determination of that ideal ordinate; and the amount produced, that is to say, the amount of the productive resources which flows into this particular industry, tends to coincide with the abscissa corresponding to that ordinate.

If the amount of the product can be increased or diminished by the inflow or outflow of the productive resources of the community in relatively fluid forms, the approach to the equilibrating ordinate will be rapid. If the forms in which the factors of production can be added or withdrawn are such as require a long period of time to mature or to wear out (deep shafts, for instance, or extensive premises and elaborate machinery), the movement will be slow; but in any case the price will only be changed by a change in the amount produced. Except as it affects that, the ideal equilibrating ordinate can have no influence on the price. Thus, if we

know the course of the curve in the neighbourhood of the actual point reached by the supply, and know what the supply is, we know the price. If we wish further to know whether the tendency will be in the direction of expanding or contracting the supply we must know what the cost of production in the existing state of the industry actually is. This cost of production is represented by the ideal equilibrating ordinate and is no other than the marginal value of other commodities, measured for convenience in the standard (gold); just as the equilibrating point to which A's desire for plums can be satisfied is determined by the place of plums on the relative scales of B, C, etc. If by any combination of factors (and there will probably be a number of different combinations realisable under different conditions, and equivalent to each other as measured by the standard) a unit of the commodity can be produced at a cost less than its present price in the market, the tendency will be for the supply to increase. If no such combinations will produce it except at a cost which exceeds its present price, the tendency will be for the supply to contract.

But as we advance from individual curves to the collective curves of great industries it comes out more and more clearly that all the elements of a commercial civilisation mutually determine each other; that any marked change in the conditions disturbs the whole structure, composition, and significance of our units; and that the diagrammatic method can only be regarded as precise, even ideally, when it refers to an industry or a portion of an industry that is too insignificant a fraction of the whole to cause serious disturbance in general relations. In other words, it is only in the neighbourhood of present margins that our standard units can be regarded as stable. In an individual curve we may fruitfully imagine ourselves, if due caution is exercised, as travelling far; but only on the supposition that the general margins are maintained. In great collective curves we must never think of ourselves as commanding, even conjecturally, more than a minute portion of the tracing, in the neighbourhood of the actual point of realisation.

We have been engaged throughout almost the whole of this chapter in the discussion of theories about increasing

and diminishing returns, and our conclusions have been almost entirely negative. One important point, however, remains, as to

which we may hope for more positive results. The habit of isolating "labour," and tacitly assuming sometimes that it is, and sometimes that it is not, proportionately backed by other factors, has

The fear of impending diminishing returns to "labour."

caused us a great deal of trouble, but it is not difficult to explain. It is the reward of labour, in the general sense of output of human effort, about which we are ultimately concerned, and all the questions about increasing and diminishing returns derive their interest from attempts to estimate or to forecast the conditions under which humanity conducts or will conduct its attempt to secure the satisfaction of its desires from the resources and opportunities of nature. If the law of diminishing returns to labour is, or will ever become, dominant, these conditions will become less favourable, and the thought of this possibility has sometimes been a nightmare to the speculative thinker. I am not about to enter upon any investigation of the terrors that haunt many minds as to the ultimate limitation of the resources of the planet. Though it be true at the present moment that the whole of the inhabitants of the globe could stand shoulder to shoulder on the surface of the Isle of Wight, it is of course easy to shew that if the increase of the population proceeded uniformly at a moderate rate, a state of things would come about within a calculable and imaginatively not a very remote period at which there would be no room for them to stand shoulder to shoulder on the face of the dry land and on the floor of the ocean. For the matter of that, it would be equally easy to shew that within a calculable period the atmospheric envelope of the planet would not contain sufficient nitrogen to renew the tissues of the population, if all other obstacles to their increase were removed; and possibly the one speculation may be found as suitable food for melancholy as the other to one whose temperament promotes "going far to seek disquietude."

But apart from these speculations which are too remote to cause any rational anxiety if they stood alone, there is a reason why a perpetual suggestion of the possibility of decreasing returns to labour, as an instant possibility, should force itself upon our minds irrespective of any foundation that

it may or may not have in reality; and if we can rob this dismal suggestion of the unfair advantage it derives from a wholly irrelevant group of phenomena we may perhaps have contributed in some modest degree to the gaiety of nations.

Let us then suppose that some individual industry illustrates the law of increasing returns in the sense that if an increasing volume of human effort were devoted to it, land, capital, and so forth, could be obtained on such terms that the marginal effectiveness of labour, measured by product in bulk, would increase. Now, taking Fig. 38 in which as usual we measure

This terror is fostered by phenomena that in no way justify it.

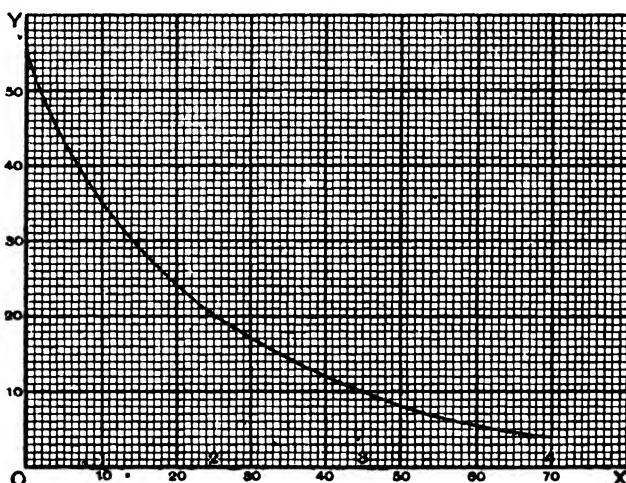

FIG. 38.

on the axis of  $X$  units of the product, and on the axis of  $Y$  their marginal exchange value, we are to suppose that if we double, treble, or quadruple the amount of labour devoted to this industry we shall in each case more than proportionately increase the material output. The divisions of the paper then represent the selected unit of the commodity, and the numerals, 1, 2, 3, 4, placed at increasing intervals, represent the successive additions to the product caused by the doubling, trebling, or quadrupling of the output of effort. The figure would then mean that whereas a given number of men, which we take as our unit, properly backed by capital and so forth, would produce an amount of the commodity represented by 10, double

that number of men would produce not 20 but 25, three times the number not 30 but 45, and four times the number not 40 but 70. But we are dealing with the material product in bulk, not with its value, and as the amount of the product increases, its marginal significance per unit will decline. If the curve takes such a form as that indicated in the figure, we see that doubling the number of men will give a more than proportional increase not only to the amount of the output, but also to its value, for the declining height of the ordinates is more than compensated by the increased length of the basis from 1 to 2. But when we pass from doubling to trebling, and from trebling to quadrupling, the original number of men, the still increasing proportional bulk of the output is now more than compensated by its decreasing value. Thus, although the industry obeys the law of increasing returns as interpreted in the return to labour of the material product, the law of diminishing returns is illustrated in the return to labour as measured in command of other commodities. For the units on the axis of *Y* which represent the value of the product must be interpreted in terms of other commodities. Men will give less of them in return for a unit of the commodity under investigation, because they are now better supplied with it.

But suppose they were better supplied with other things also. Suppose that the gradual increase of the population, accompanied by a suitable increase of capital and applications of fresh land or fresh and improved applications of land, enabled all the other industries to increase in volume also; and suppose that all likewise obeyed the law of increasing returns of material product to labour. Every one, then, having not only more of the particular commodity we first took into consideration, but having in suitable proportion more of all other commodities as well, will give as much of these other commodities for a unit of the first as they did before, and every one, therefore, will have more of everything, including opportunities of leisure and every form of self-expression. This would be the ideal condition of a progressive community, in which every generation, partly because of progress in the arts, but partly also from the mere increase of population and the resultant economies in every industry, would find itself

wealthier than the last, and able to secure the co-operation and alliance of nature on ever pleasanter and easier terms. But it would still remain true that in each individual industry the position of its members would be strengthened if the other industries absorbed a relatively larger amount of the new energies and resources, and weakened if it absorbed a relatively larger amount itself. Every one would be aware that however much the ordinates of his industry were being raised by general processes that made all other commodities more abundant, and therefore to be had on easier terms, they would be falling in virtue of his own advance along his own line.

Thus generalising from his own industry every one will argue that the law of decreasing returns is already in full swing, that the more persons there are engaged in producing things, and the more abundantly they produce them, the poorer every one will be.

Thus we have arrived at a more exact analysis of the phenomenon which we have already described as the microbe of the disease of civilisation,<sup>1</sup> the fact, namely, that every man is convinced (except in exceptional periods) that his own industry or profession is overstocked. However true it may be that an increase in the numbers engaged in every industry, accompanied by a suitable increase in tools and appliances, would secure a larger general command of resources, it remains true that in any industry, taken in isolation, the reverse must seem to be (and in a sense must really be) the truth. Hence it is to the interest of the existing members of every industry, taken severally, that every other industry should recruit its staff and increase its output, while they themselves retain the exclusive right of ministering to the increased demand for their own product thus created. They will then reap the full benefit of the raising of their own curve which the advance of other industries down their declining slopes secures, and will themselves escape the obligation of raising the curves of others by advancing on the down-slope of theirs. But it is obvious that if the advance were even in all industries the remuneration of each factor of productivity, measured in the sum of things in the circle of exchange of which it represented the command, would increase.

<sup>1</sup> Pages 345 *sqq.*



## CHAPTER VI

### THE DIAGRAMMATIC EXPOSITION OF THE LAW OF RENT AND ITS IMPLICATIONS

SUMMARY.—*The current exposition of the law of rent, based on a diagram of "decreasing returns" to labour, for a constant of land, mistakes the characteristics of the constant for those of land. Hence many errors in nomenclature and in thought have arisen. It is equally easy and equally legitimate to represent the same facts in the form of a diagram with labour for the constant and land for the variable. This will shew that both rent and wages are shares in the product determined by marginal efficiency; and that when all the factors have received their share in this marginal distribution there is no surplus or residuum at all.*

The roots of the error concerning the exceptional treatment of land, which we examined in the last chapter, go down far deeper than the point to which we have as yet traced them, and the process of extirpation cannot be completed without an elaborate examination of the current exposition of the theory of rent. We will therefore go on to the examination of the ordinary diagram given to illustrate both the supposed "law of decreasing returns" and the "law of rent" derived from it. In Fig. 39 increments of "labour" applied to a constant of land are reckoned along the axis of  $X$ , and rates of increment to the crop per unit increment of labour along the axis of  $Y$ . The total yield for  $Ox_1$  "labour" is  $Orw_1x_1$ , and labour being rewarded at the rate of  $x_1w_1$  per unit receives the area  $Ow_1$

The diagram of rent. Its form, its interpretation, and its implications.

altogether, the balance  $y_1rw_1$  being rent. If  $Ox_2$  only had been applied to the same amount of land the total yield would have been the smaller area of  $Orw_2x_2$ , but the reward of "labour" *per unit* would have been higher, namely,  $x_2w_2$ . Rent would only be  $y_2rw_2$ , a smaller proportion of a smaller total. Thus decreasing returns to land per unit and increasing returns to "labour" per unit are read as we recede from the margin, and decreasing returns to "labour" per unit and increasing returns to land per unit as we advance from the origin. More labour bestowed on

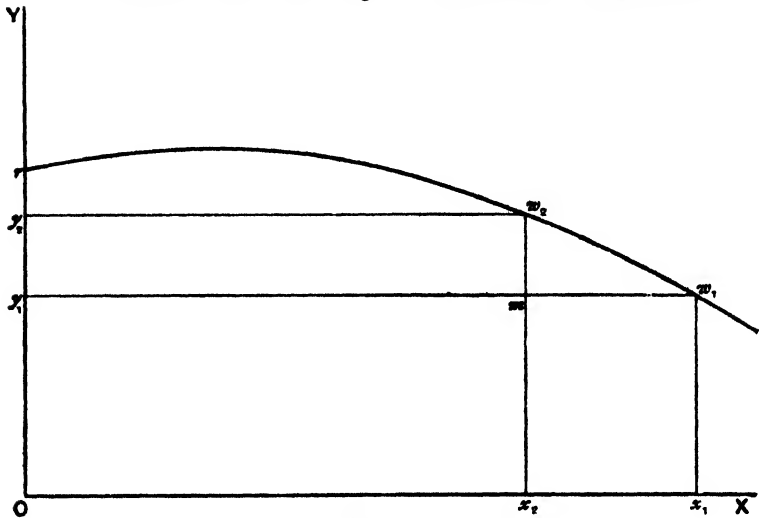

FIG. 39.

the same land means less land under the same labour. So we have these results: More labour on the same land or *less land under the same labour* means a larger rent per unit of land and a less "wage" per unit of "labour"; whereas less labour on the same land or *more land under the same labour* means a lower rent per unit of land and a higher "wage" per unit of "labour." Those of the results just formulated which are directly illustrated in the figure are very familiar to all students of Political Economy, and familiarity has made them appear axiomatically true. But those of them which are just as explicitly contained in the data, but are only indirectly illustrated by the figure, and

which have been italicised in the statement just made, are unfamiliar to most students of Political Economy, and may appear startling and perplexing, though they are absolutely identical with those expressed in the more familiar form and at once accepted as axiomatic.

Thus every one sees that if (after a certain point) more labour is applied to the same land the return to the land will be higher. But every one does not see that this is exactly the same as saying that after that point if more land is brought under the same "labour" the return to labour will be higher.

In our figure rent appears as a mixtilinear area and "wages" as a rectilinear one; and this has usually been assumed to be due to some special characteristic of land, but if we work out our data under the other form of statement we shall find that these graphic forms are simply due to the fact that land was taken as the constant. Had we thought in terms of less or more land under the same cultivation instead of more or less cultivation bestowed upon the same land, we should have found "wages" represented by a mixtilinear area and rent by a rectilinear one. This I shall go on to shew in detail. But before proceeding to the demonstration it will be well to note certain special points.

I have explained why certain phrases have been italicised above. I must now explain why I have put "wages" and "labour" between inverted commas. It is because labour is taken to include capital. In short, "labour" means all the factors of production except land. And "wages" means the remuneration of all these factors. To measure them all in one unit implies that they have all been reduced to a common denominator, and this must have been done on some such principle as that expounded in Book I. Chapter IX. It would be useless to attempt to express such a unit accurately every time we have occasion to speak of it. Even to call it a "unit of labour-and-capital-reduced-to-a-common-denominator" would be too cumbrous. To call it a unit of labour is in the highest degree dangerous; but the danger is reduced, though not altogether avoided, by systematically writing "labour" for this complex of factors,

and "wages" for its remuneration. We must add that the distinction between "labour" in this sense and "land" is artificial and arbitrary; for all the land we ever deal with embodies capital, and so does "labour" as now defined.

We have next to note that the figure, and the argument that usually accompanies it, do not really give us any theory of rent at all. They assume our own law of remuneration in proportion to efficiency for all the other factors (tacitly reduced to a common denomination), and then simply tell us that whatever is not anything else is rent.

Further, we must note with extreme care that the number of units of "labour,  $Ox_1$  or  $Ox_2$ , applied to the constant of land, will be fixed by the alternatives open to land and "labour" respectively. "Labour" is devoted to, say, wheat-growing till the marginal return is only  $x_1w_1$ , because it cannot find any more eligible alternative, and it is not devoted to it beyond that point, at a lower marginal significance, because it can find alternatives as eligible. And in like manner so much land and no more offers itself at a declining marginal significance to a given amount of wheat-growing "labour," because it cannot find anything else better, but can find other things as good, to do with itself. So land will not come to a man unless he offers it as good terms as it can get anyway else, and men will not come to land unless it offers them as good terms as they can get anyway else. The quantities  $Ox_1$ ,  $x_1w_1$ ,  $y_1rw_1$ , are determined by the general conditions of industry and the markets; and if under conditions which would justify these proportions an individual should choose to take land and work on it at the rate represented by  $Ox_2$ , instead of earning  $Ow_2$  and paying  $y_2rw_2$  in rent, he would find that out of his total crop of  $Ow_2$  he would have to pay a rent of  $y_1rw_1$ , and would only have  $Om$  minus the mixtilinear triangle  $w_2mw_1$  for himself. If rent were at the rate of  $y_2rw_2$ , and "wages" at  $x_2w_2$ , it would be because more eligible alternatives had been opened to "labour," or a more abundant supply of land had become available to it as against the conditions that determined  $y_1rw_1$  and  $Ow_1$ . It should be noted incidentally that any such change would be sure to affect the internal constitution of the complex unit of what we have called

“labour”; it would not act upon interest on capital and wages for every different grade and character of work, for instance, in exactly the same proportion.

Lastly, we may note that the figure deals with yield per unit of land of a given quality, as it is plied with more and more “labour.” It takes no account of different grades of land, each of which would present a curve of different form. Neither does the figure take account of the different conditions that might prevail on larger and smaller holdings.

With reservations, the nature of which will presently appear, as to the general form of the curve, we may now proceed to the detailed demonstration promised on page 552. It will be well to begin from the beginning and build up our curves step by step.

Suppose a man holds 50 acres of land and bestows 3000 hours’ personal work upon it in the course of the year,

backed by tools and apparatus of every kind, stock, seed, manure and so forth, and also hired labour. An hour’s labour will in this case be a mere symbol of an aggregate of factors of production, of defined magnitude, expressed under a common denominator, and will mean “the totality of the applications and combinations which may be supposed to accompany, or to be included in, the expenditure of an hour’s work on the land by the tenant.” Let us suppose that the crop is about equivalent to 5 quarters (or 1280 quarts) of wheat per acre. For convenience of subsequent operations we will take it at 1260 quarts, and this would be 630 quarts per half-acre. Thirty “hours” a year will be devoted to each half-acre. So the crop will be at the rate of 21 quarts per “hour” expended. We will take this as our starting-point. But it will be convenient to take a smaller unit of land than the acre or half-acre. Let it be the twentieth of a rood (which would be two poles), or the fortieth of a half-acre. The selection of the unit is determined merely with a view to diagrammatic convenience. Then our supposition will be: Land cultivated to the point of 60 “hours” to the acre yields the equivalent of 1260 quarts of wheat per acre,

Construction of curves of the marginal significance of labour to a constant of land, and of the marginal significance of land to a constant of labour.

which is at the rate of 21 quarts per hour, or 15·75 per (two-pole) unit of land.

The scale of  
1260 quarts per 80 land-units under 60 hours' cultivation  
is the scale of  
630 quarts per 40 land units under 30 hours' cultivation,  
and the yield is at the rate of  
 $630 \div 30 = 21$  quarts per hour, or  
 $630 \div 40 = 15\cdot75$  quarts per land-unit.

Here the reader must note carefully that these rates per unit of land and labour are not shares which fall to each of the factors, nor estimates of the value of their respective contributions. They simply indicate the ratio of the gross crop to the land or to the labour, taken severally. Yield per unit of land is a familiar conception. Yield per unit of labour is equally important for our present investigation, and the reader must try to make himself equally familiar with it.

Let us now suppose that if the man only cultivated at the ratio of 25 "hours" per half-acre his crop would be at the rate of 531·40 instead of 630.<sup>1</sup> Here note that we are imagining our cultivation to be less intensive than on the first supposition; that is to say, the cultivation or "labour" is spread thinner on the land. This we may think of in terms either of the unit of land having less labour spread on it, or of the unit of labour being spread over more land. Thus, if we pass from 30 "hours" on 40 land-units to 25 "hours" on 40 land-units, we get the same ratio (5 to 8) which we should have got had we passed from 30 on 40 to 30 on 48 (5 to 8 again); but of course the total crop on 48 land-units under 30 "hours'" cultivation will be greater by a fifth than that on 40 land-units under 25 hours' cultivation

Thus if, as we have (arbitrarily) supposed, the crop on 40 land under 25 labour is 531·40 quarts, it follows that the crop on 48 land under 30 labour will be 637·68 quarts (six-fifths of the other); and whichever way we measure it we shall have a yield of 13·285 quarts per unit of land and of 21·256 quarts per unit of labour.

<sup>1</sup> It is of course admitted and understood that such minuteness of estimate takes us absolutely away from all contact with practical business or practical possibilities. It is adopted merely for graphic purposes and to illustrate the principles involved in the current expositions.

We may tabulate these results:—

		Quarts per "hour."	Quarts per land-unit.
30 to 40	gives a yield of	21	15·75
25 to 40	} " "	21·256	13·285
or			
30 to 48			

Thus as we pass from 25 to 30 units of cultivation on 40 units of land we have decreasing returns to labour, but increasing returns to land. To say that we have a decreasing or increasing "total yield" would have no sense unless we had established some common denominator (pecuniary or other) under which we could express land or labour indifferently, or both collectively. This lies outside our present inquiry; and we see that "increasing" and "decreasing" returns, from our present point of view, are merely relative terms and may be applied to the same phenomenon simultaneously according to whether we are speaking of land or of "labour." To this important conception we will presently return, but meanwhile we are to follow our investigations along another track.

Our hypothesis is that at 30 "labour" to 40 land we have a crop of 630; so that we may call this the return either to 30 "labour" or to 40 land, on the supposition of the ratio of 3 to 4. When we alter the ratio to 5 to 8, we may keep either 40 land (with 25 "labour" spread on it), or keep the 30 "labour" and spread it over 48 land. In the one case we shall have a crop of 531·40 instead of 630, and in the other a crop of 637·68 instead of 630; that is to say, if we spread so much less labour on the same land we shall decrease the yield *to the land* by 98·60 quarts, and if we bring so much extra land under the same "labour" we shall increase the yield *to the "labour"* by 7·68 quarts.

We may now begin to plot out our results on Fig. 40. In (a) we may assume that the half-acre (40 of our land-units) is constant. We mark along the axis of *X* the number of "hours" per half-acre put in annually, and on the axis of *Y* rates of yield measured in quarts, so that the crop per half-acre, for any ratio between land and labour, will be represented by areas in which every small square is

a quart. In (b) we will take 30 "hours" of cultivation per annum as our constant, and will measure along the axis of  $X$  the units of land (twentieths of a rood) over which it is spread. The meaning of the units on the axis of  $Y$  will still be rates of yield measured in quarts, and areas will represent the crop per 30 "hours" cultivation, for any ratio between land and "labour." In (a) as we advance from 25 "hours" to 30 we secure by hypothesis an addition of 98.60 quarts per half-acre, or if we move in the opposite direction, from 30 to 25, a diminution of that amount. This may be plotted on (a) by erecting a rectangle of an altitude 19.72 on the base line between 25 and 30. This means that, land remaining constant, the addition or withdrawal of these 5 hours per half-acre will make the difference we have assumed in the crop. But, as we have seen, to pass from 30 to 25 on (a) is equivalent to passing from 40 to 48 on (b), since each of them means changing the ratio of 3:4 into that of 5:8; and the effect of this change is to increase the yield to 30 "hours" of labour by 7.68. In (b), on the base line between 40 and 48, we must therefore erect a rectangle of area 7.68 or altitude 0.96, which means that, "labour" remaining constant, the addition or subtraction of these eight land-units will make a difference of 7.68 quarts in the crop.

Note that movement towards the origin in (a) corresponds to movement away from it in (b). We may either start with the ratio 3:4 and move to the left in (a) and to the right in (b), or we may start with the ratio 5:8 and move to the left in (b) and to the right in (a). That is to say, our data imply that if we increase the number of "hours" spread over the same land we shall increase the yield per unit of land and decrease the yield per unit of "labour," whereas if we bring more land under the same output of cultivating labour we shall increase the yield per unit of "labour" and decrease the yield per unit of land.

Let us now change the ratio of 3:4 in the contrary sense. Let us suppose (as an arbitrary datum) that a ratio of 7:8, that is to say, of 35 "labour" to 40 land, or 30 "labour" to 34.286 land, would yield a crop of 705.98 per half-acre, or six-sevenths of this, viz. 605.13 per 30



“hours.” This would mean that the difference made to the

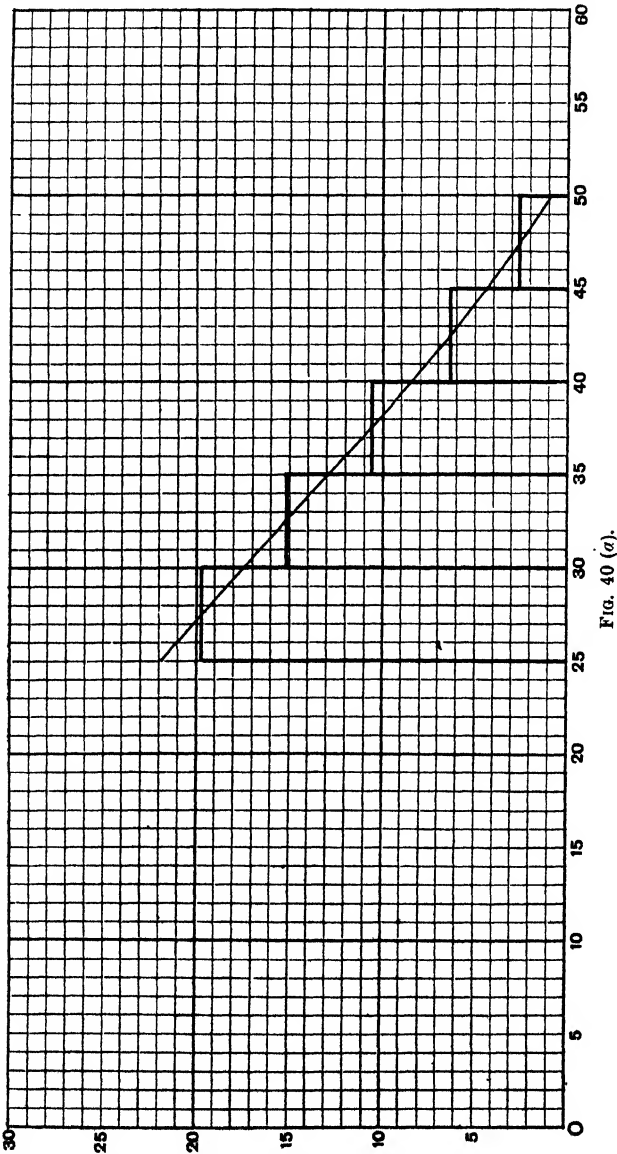

FIG. 40 (a).

crop by the addition or subtraction of these five “hours” on 40 land-units is 75·98, and may be represented on (a)

by a rectangle on the base line between 30 and 35 with an

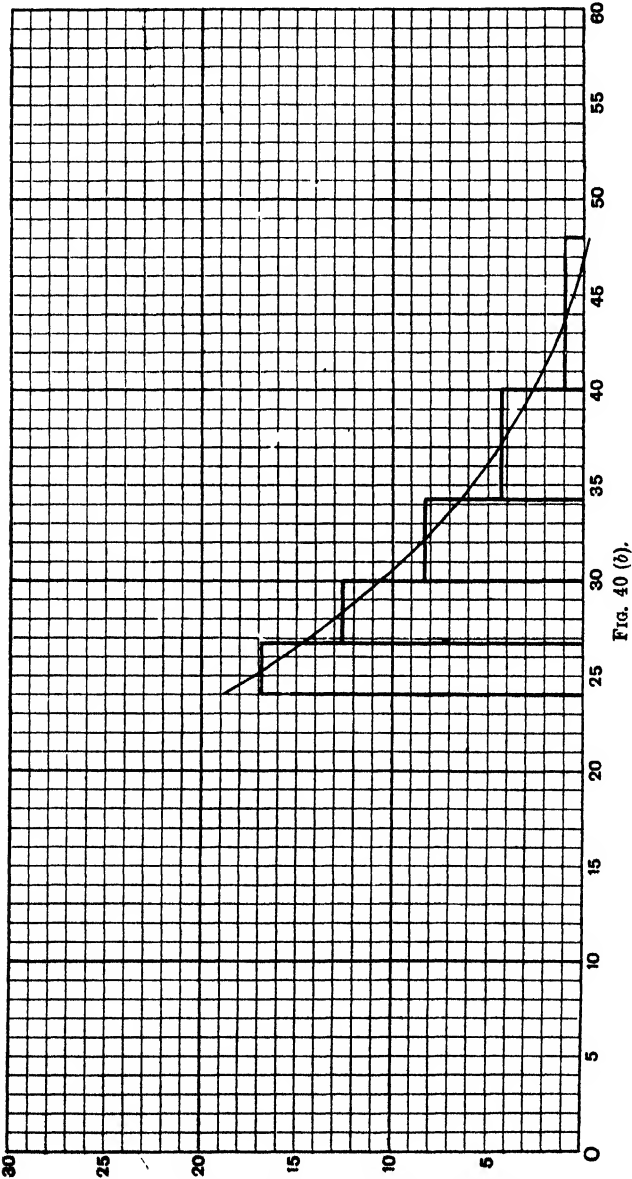

FIG. 40 (b).

altitude of 15·20; whereas the difference made by the addition or subtraction of these 5·714 land-units under 30

"hours" of cultivation is 24·87, and will be represented on (b) by a rectangle whose base is the line between 34·286 and 40 on the abscissa, and its altitude 4·35.

We can now tabulate and extend our results. If we start with the rectangle on the left in (a) and move to the right, and with the corresponding rectangle on the right in (b) and move to the left, we shall have a series of increments to record on (a), and of decrements to record on (b). But the figures may be read either way, and if we read (b) towards the right and (a) towards the left we should have increments to record on (b) and decrements on (a). We shall therefore not mark positive or negative signs on our table; for if we read it down the differences in column 6 will be positive and those in column 7 negative, and if we read it up it will be the other way, and either reading is equally legitimate.

Ratio of "Hours" to Land-units.	"Hours" to Constant of 40 Land-units.	Land-units to Constant of 30 "Hours."	Crop to Constant of Land (on Arbitrary Hypothesis).	Crop to Constant of "Labour" (on same Hypothesis).	Difference in Yield to Constant of Land.	Difference in Yield to Constant of "Labour."	Height of Rectangle on (a).	Height of Rectangle on (b).
5 : 8	25	48	531·40	637·68	98·60	7·68	19·72	0·96
3 : 4	30	40	630	630	75·98	24·87	15·20	4·35
7 : 8	35	34·286	705·98	605·13	53·18	35·76	10·64	8·34
1 : 1	40	30	759·16	569·37	31·85	42·03	6·37	12·61
9 : 8	45	26·667	791·01	527·34	12·99	44·94	2·60	16·85
5 : 4	50	24	804	482·40				

Now, as the effect of increasing the labour bestowed upon the same land in the one case, or increasing the land brought under the same expenditure of cultivation in the other, will obviously be continuous, we may trace curves on the principle fully explained on page 447, which in the case of (a) will correspond to the ordinary curve given to illustrate rent in the books, and in the case of (b) will be the complementary curve in which labour is supposed to be constant.

Thus, for any abscissa on (*a*) the corresponding ordinate will mark the marginal efficiency of labour per hour, at that point, in increasing the yield to a constant of half an acre of land (40 land-units); and for any abscissa on (*b*) the ordinate will represent the marginal efficiency of land per unit, at that point, in increasing the yield to 30 "hours" of labour.

What we have got in (*a*), therefore, is a portion of the familiar rent curve. It shows us the "decreasing returns" to "labour" as successive increments or doses are applied to the same piece of land; and since "labour" is remunerated at the rate of its marginal efficiency, the rectangle of the ordinate multiplied by the abscissa, that is to say, the rectangle contained by the curve, is the total amount that would be paid in "wages." There remains the rest of the crop for rent; and if the curve were completed, that would be represented by the mixtilinear area above the rectangle.

This last point may easily be established. The land would produce no crop at all unless some labour were expended on it. Thus, if we start with the crop for *x* "hours" per land-constant, and successively account for, and register as an area, the part of the crop dependent on the difference between *x* and (*x* - 1) "hours," the part dependent on the difference between (*x* - 1) and (*x* - 2), and so on, up to the part dependent on the difference between 1 and 0, we shall have accounted for the whole crop. Now our curve is constructed precisely on these principles. Over each successive base it bounds an area which represents, by construction, the part of the crop for which the corresponding portion of the abscissa is responsible. Thus, if we had completed it, it would account for the whole crop. For example, at the ratio of 3 "labour" to 4 land, or 30 "labour" to 40 land, we take the abscissa 30 on (*a*) and read 17.50 as the marginal significance of "labour" per hour. If this represented a state of equilibrium,  $17.50 \times 30 = 525$  would be the amount of the crop that would fall to "labour," and the rest would measure the rent of half an acre.

In (*b*) we should have a portion of a precisely analogous curve shewing the "decreasing returns" to land as successive

increments are brought under the same amount of "labour"; and since land will also be remunerated at the rate of its marginal efficiency the rectangle contained by the curve is the total paid for rent. The rest of the crop will remain for "wages." The point 40 on the abscissa of (b) corresponds to the point 30 in (a). Reading the ordinate for the abscissa we find it to be 2.625. The rent then will be  $40 \times 2.625 = 105$ , and the rest of the crop will be the "wages" of thirty "hours" of labour.

If our curves have been accurately drawn and correctly read these results must coincide. And so they do. For returning to page 554, where the total crop for 30 "hours" bestowed on 40 land-units is taken at 630 quarts, we find from (a) that wages will be at  $30 \times 17.5 = 525$ , and from (b) that rent will be at  $40 \times 2.625 = 105$ . And  $525 + 105 = 630$ .

Let it be clearly understood that all we have proved is that the same data may be diagrammatically expressed in two different ways; and that these two representations, if correctly made, will be consistent. That our sum comes out right proves nothing; and if it came out wrong it would disprove nothing. The curves are to be drawn in accordance with the calculations, and they can be calculated more accurately than they can be read. They illustrate the calculations; but they do not prove them to be correct. The calculations, as legitimate inferences from the data, must stand or fall on their own merits. The curves simply illustrate the relation in which the different inferences stand both to each other and to current (or recently current) economic teaching.

The essential and all-important point of the demonstration, up to this point, is that in the ordinary diagrams rent is set forth as a mixtilinear and "wages" as a rectangular area, not because there is any inherent appropriateness in these geometrical forms as representatives severally of the respective industrial factors, but simply because return to the constant, whatever it happens to be, will always come out as a mixtilinear area, and that to the variable as a rectangular one. And whether a distributive share is represented as a mixtilinear or a rectangular area, it is the same quantity and it is marginally determined.

This will become still clearer if we plot the total crop (for each ratio of land and "labour") to 40 land-units and to 30 "hours" respectively, in conjunction with the marginal returns to "labour" and to "land." I must refer my readers to the short mathematical treatise already mentioned<sup>1</sup> for the detailed justification of the general form of the curves which our data imply; but it is sufficiently obvious that the form of figure usually given (as in Fig. 39) is an exceedingly crude representation of the facts. The more careful writers always state that the law of diminishing returns will only come in "after a certain point," and assume that when we are near the origin increments of labour will produce more than a proportionate increase in the product. Further, it is clear that if I were to distribute a few hours' labour over many acres of land (really distributing it over the whole, not selecting a portion of it), I should produce no appreciable effect at all. The difference between giving so much labour and no labour would not be perceptible. If, on the other hand, I were already giving 300 days' work to a holding of 40 acres, every extra hour of work would produce an appreciable result. Thus I have attempted, in the work referred to, to shew that our curves will pass through the origin, will rise for a time, and then decline. Our data have hitherto been assumed in accordance with this theory, and we may now extend them so as to carry our data for (a) back to the origin in one direction, and some way farther to the right than it has yet reached in the other.

Construction of the rectangles of the gross crop to constant land and variable labour, and vice versa; and distribution of the whole product in accordance with marginal significances.

We will assume, then, the following data, some of which have been already tabulated, the rest being now introduced for the first time:—<sup>2</sup>

<sup>1</sup> *Co-ordination of the Laws of Distribution*, London, 1894.

<sup>2</sup> As a matter of fact the assumed data throughout conform to the formula,  $\text{crop} = 2.248x^2e^{-.175x}$ , in which  $x$  stands for the number of "hours" put in per annum per 40 land-units. The corresponding formulæ for the pair of curves on Fig. 41 (a), page 566, will naturally be  $2.248xe^{-.175x}$  for the curve containing the rectangle, and  $2.248(2 - \frac{1}{175}x)xe^{-.175x}$  for the curve the integral of which equals the rectangle.

TABLE I.—LAND-CONSTANT AT  $\frac{1}{2}$  ACRE (40 UNITS).

Ratio of Labour to Land.	"Hours" of Cultivation per Constant of Land.	Crop per Constant of Land (Assumed).	Total Crop per Unit of Land (Derived).	Total Crop per Unit of "Labour" (Derived).
1 : 8	5	46.26	1.16	9.25
1 : 4	10	152.36	3.81	15.24
3 : 8	15	282.24	7.06	18.82
1 : 2	20	413.08	10.33	20.65
5 : 8	25	531.40	13.28	21.26
3 : 4	30	630.00	15.75	21.00
7 : 8	35	705.98	17.65	20.17
1 : 1	40	759.16	18.98	18.98
9 : 8	45	791.01	19.78	17.58
5 : 4	50	804.00	20.10	16.08
11 : 8	55	800.91	20.02	14.56
3 : 2	60	784.74	19.62	13.08
13 : 8	65	758.22	18.96	11.66
7 : 4	70	724.01	18.10	10.34

If we take the figures in the second column as a series of abscissas and those in the last column as the corresponding ordinates, we shall have a series of points in a curve the rectangle contained in which gives the total crop per half-acre (40 units) at any ratio of land to labour. And if we add the curve of marginal significance of "labour" applied to a constant of 40 units of land, we shall have on our Fig. 41 (*a*) one curve *c* (which stands for "crop") containing the rectangle of the total crop per 40 units of land, and another curve *w* (which stands for "wages") containing the rectangle of the share of labour in that total. The first of these rectangles minus the second will obviously represent the share of land, also as a rectangle. And this last rectangle will be equal to the total area of curve *w* minus the rectangle it contains. If we divide it by 40 we shall have the figure in the last column but one of our table.

But the assumed data of Table I. can be presented in Table II. for a constant of 30 "hours" and a variable of land-units. We have taken our points on the abscissa of (*a*) at uniform intervals of 5 units and assumed data to match them. The corresponding intervals on (*b*), being reciprocals,

will not be uniform. It would, of course, have been equally easy to have gone the other way about, so the regularity in one case and the irregularity in the other has no theoretical importance. We will tabulate for 30 "hours" constant the data corresponding to the abscissas from 60 to 15 in Table I.

TABLE II.—FOR 30 "HOURS" CONSTANT.

Ratio of Labour to Land.	Land.	Crop per Constant of "Labour" (Derived).	Crop per Unit of "Labour" (Derived).	Crop per Unit of Land (Derived).
3 : 2	20	392.37	13.08	19.62
11 : 8	21.818	436.86	14.56	20.02
5 : 4	24	482.40	16.08	20.10
9 : 8	26.667	527.34	17.58	19.78
1 : 1	30	569.37	18.98	18.98
7 : 8	34.286	605.13	20.17	17.65
3 : 4	40	630.00	21.00	15.75
5 : 8	48	637.68	21.26	13.28
1 : 2	60	619.62	20.96	10.33
3 : 8	80	564.48	18.82	7.06

Here again, by taking the figures in the second row as abscissas and those in the last row as the corresponding ordinates, we shall obtain a series of points on a curve *c*, Fig. 41 (*b*), the rectangle in which gives the total return to 30 "hours" cultivation applied to the amount of land marked by the abscissa; and if we add the curve of marginal significance of land, we shall have in (*b*) a curve *c* (crop) containing the rectangle of the total crop to 30 "hours," and a curve *r* ("rent") containing the rectangle of the share of land in that total. The first of these rectangles minus the second will represent the share of "labour," also as a rectangle. And this last rectangle will be equal to the total area of curve *r* minus the rectangle it contains. If we divide it by 30 we shall have the figure in the last column but one of Table II.

Thus the readings of (*a*) and (*b*), either in Fig. 40 or Fig. 41, will give absolutely identical results, if the figures are correctly and consistently drawn. The reader will be able to check this roughly by reading the curves for any two



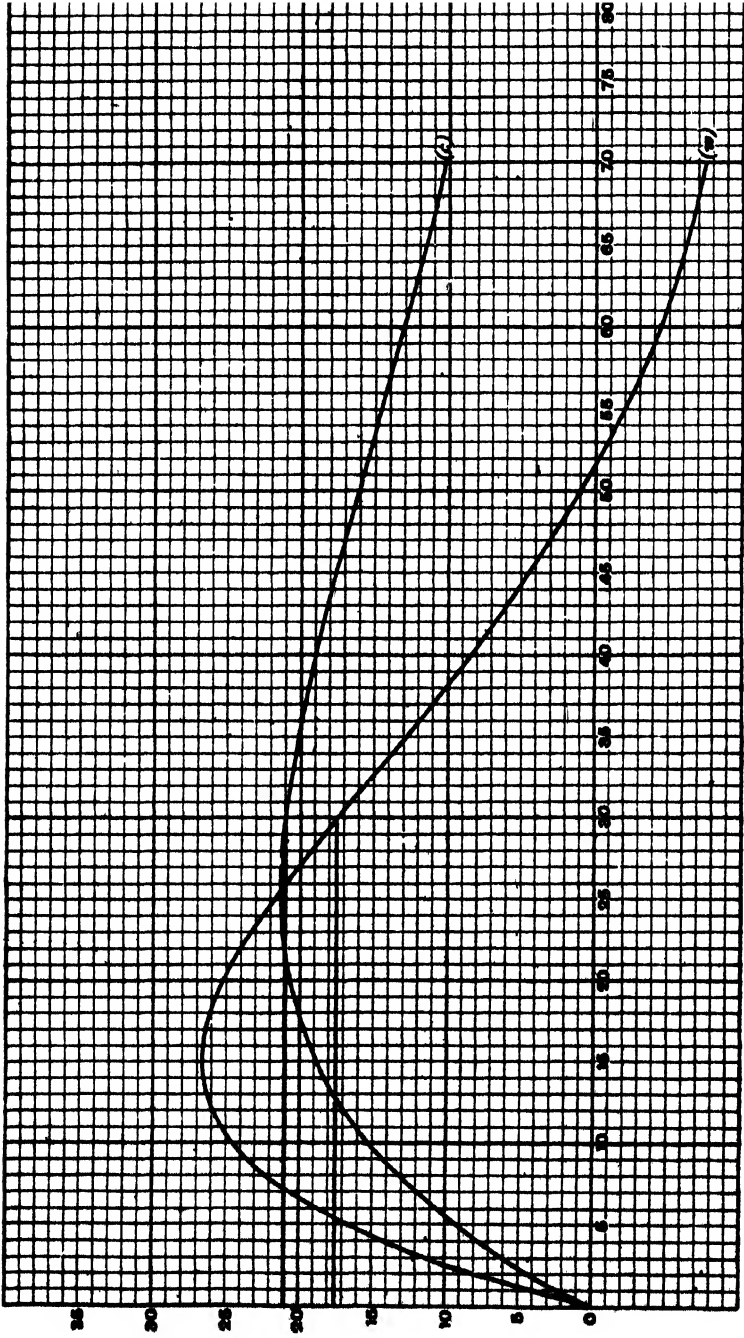

FIG 41 (a).

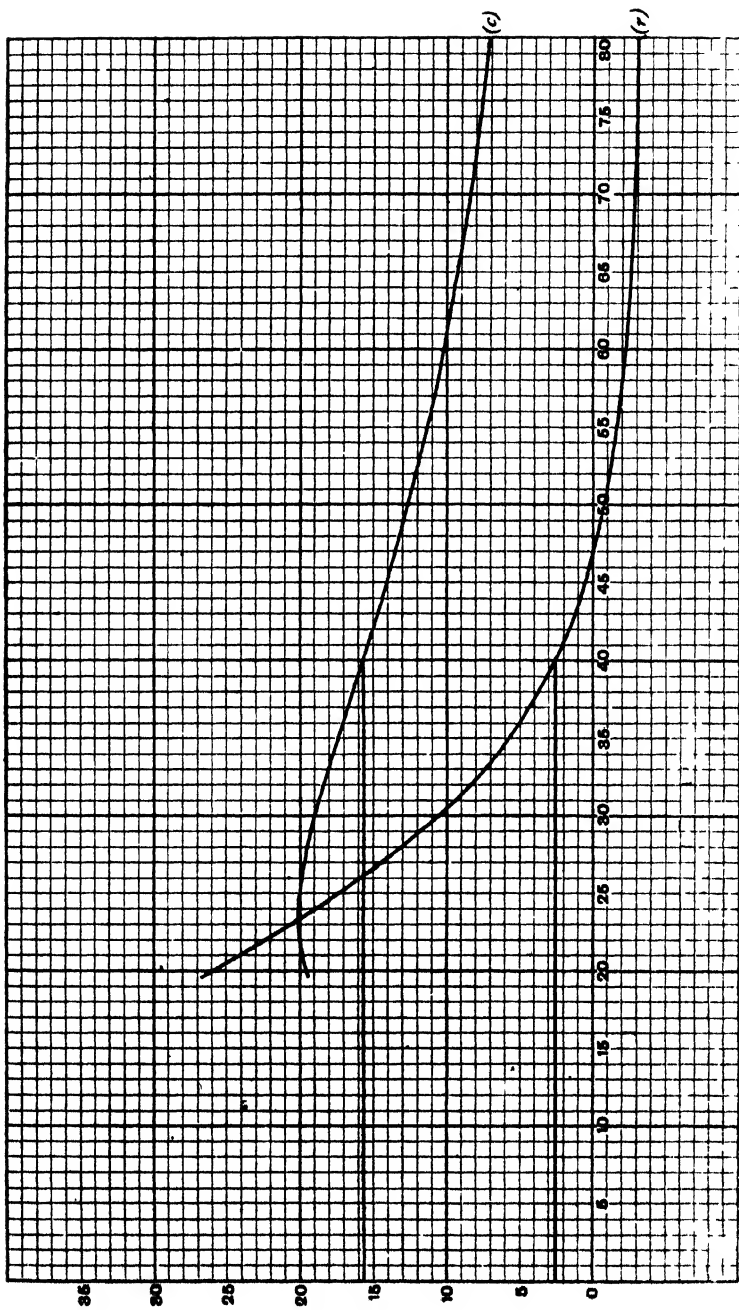

FIG 11 (A)

corresponding points that lie between the tabulated points. For example, on (a) take the rate of 35 "labour" to 40 land. This gives us 12.9 for wages per hour; and  $7.3 \times 35$  for the rent of 40 units of land, or about 6.4 per unit. Now 35 to 40 is 30 to 34.3. Therefore the corresponding point on (b) will have the abscissa 34.3. If we read the ordinates we find that rent is about 6.4 and the wages  $11.3 \times 34.3$  for 30 hours, or 12.9 per hour.

We have now thoroughly established the important conclusion that there is no special propriety in regarding rent as a residual share in the product, nor is there any special or necessary appropriateness in representing rent diagrammatically as a mixtilinear area, in contrast to the representation of wages, for example, as a rectilinear area. But the mistaken conceptions now dissipated have led to what I cannot but regard as disastrous confusions both in thought and nomenclature which may long impede the progress of Economics. It has been assumed, in the first place, that every economic quantity that presents itself graphically, under any treatment, in the form of a mixtilinear area has some specific analogy to rent. And here we may note that what is known as the "Ricardian" law of rent may be presented in this same form. Thus a diagram of the form in Fig. 39 (page 551) might be regarded not as shewing the relation between marginal-return-per-unit-of-labour-and-capital and ratio-of-labour-and-capital-to-land, but as an arrangement of the several units of labour and capital employed in the wheat industry, referred to the varying fertility of the land to which they are applied. We should then have the mixtilinear area representing the excess of the yield of the more fertile over the yield of the least fertile land under cultivation. The Ricardian theory of rent usually (though quite unnecessarily) assumes that the least fertile land will bear no rent at all, and in that case the mixtilinear area would represent the whole rent; otherwise it would represent the excess of rent over a minimum. Now, if you take a number of persons who possess different talents and arrange them in the order of the marginal value to the community of the exercise of their talents, you will have

Examination  
of errors  
resulting  
from a mis-  
conception  
of the rent  
curve.

near the origin an individual the product of whose efforts per annum is relatively high, and as you go forward you will come to individuals the exercise of whose talents produces a smaller and smaller pecuniary return. If we draw a line on the level of the return to the efforts of the least efficient of the men in question, the area above it will represent the excess over that minimum return that accrues to the more able individuals; and simply because this is a curvilinear figure the revenue it represents has actually been called "rent of ability."

It is clear that at this rate any excess in the value of one article above another that is nominally the same would be entitled to the name of "rent." Thus, if a pound of one kind of manure produces the same result as two pounds of another, and so forth, you might register pounds of the different manures, in order of their efficiency, along the axis of  $X$ , and treat the excess of efficiency of a pound of the one over a pound of the other as "rent of superior efficiency." Indeed, if any two things could perform the same function, but one of them could perform more of it than the other, you might regard the excess of the price of one over the price of the other as a case of "rent." And in very truth that is all that the Ricardian law of rent amounts to. If two pieces of land can each of them yield wheat to labour and capital, but one yields more wheat than the other, the value of that land will be proportionately higher, just as the value of an apple-tree that bore an average of two hundred apples of given quality per annum would be higher than that of one that only bore an average of one hundred and fifty of the same quality. In fact the Ricardian law of rent is nothing whatever but a statement that the better article commands an advanced price in proportion to its betterness. The introduction of the hypothesis that the lowest quality of the article is to be had for nothing would make the whole price of the better article due to its "betterness." If there is no such gratuitous supply, then only the excess of the price of the more expensive article in the market would be due to its "betterness," and the rest to its "goodness" up to the point of lowest goodness in the market.

Again, reverting to our former interpretation of the

figure (waiving all scruples as to the course of the curve in the neighbourhood of the origin), and bearing in mind that the form of the mixtilinear area is determined simply by the fact that land is constant, we shall see that by representing any other factor as constant we shall obtain a representation of it as a mixtilinear area. Thus, in all the individual and communal curves which represent the declining marginal significance of successive supplies of any commodity, we may regard the *psyche* or sensitive organism as the constant, and the areas as psychic. If the sensitive organism, or body of sensitive organisms, remains constant, successive increments of the provocative or stimulus will, after a certain point, produce decreasing revenues or volumes of the experience in question, and we shall therefore have the mixtilinear area representing an excess in the experience provoked by the earlier over those provoked by the marginal increments. When students perceived this they promptly dubbed that excess "consumer's rent."

But misleading as these uses of "rent" appear to me to be, they constitute but a small part of the evil that we have to deal with.

We have seen that the figure constructed on the hypothesis of land being constant, and labour and capital Rent not a variable, may equally well be regarded as an residuum. illustration of the Ricardian theory of rent when associated, as it usually is, with the hypothesis of "no-rent" land being under cultivation. The general attitude of mind with regard to rent that results from all this may be thus described:—Rent is a residuum which is determined by the subtraction of the shares of the other factors of production, and what those shares are is determined by the remuneration they can secure on "no-rent" land—that is to say at the margin of cultivation.

We may notice in passing that this treatment of rent as a residuum incidentally stultifies the claim of the current economic science to have established a "law of rent" at all. For if rent is simply what is left when the other factors have been satisfied, we have not established a law of rent, but have assumed that we know how to determine the shares of everything except land, and then simply stated that

what is not anything else is rent. If we start from  $x = a + b + c + \text{etc.}$ , we cannot determine  $a$  simply by the equation  $a = x - b - c - \text{etc.}$ , unless we have independently determined the values of  $b$ ,  $c$ , etc. Thus, what is usually given as a derivation of the law of rent from the law of decreasing efficiency of successive doses of labour and capital on the same land is really an assumption that every other factor of production obeys the law of marginal efficiency which we have taken as our guide to the whole theory of distribution. Instead of elaborating a theory of rent the current exposition tacitly assumes a (correct) theory with reference to everything except land, and then claims that no theory at all is necessary for land. But our elaborate examination has shewn that the diagrammatic exposition strictly involves the conclusion that that same law really applies to land just as much as to the other factors. In truth, then, the mixtilinear area represents rent, not because it is all that is left when the other claimants have been satisfied, but because it represents the marginal efficiency of land, and would be represented by an ordinate if we had taken labour as the constant, just as labour is represented by an ordinate when we take land as the constant.

But we are concerned at present not with the inconsistencies already involved in regarding rent as a residuum, but with the further conclusions that have flowed from it. If rent, it is argued, is a surplus or residuum which can be arrived at by deducting the remuneration of the other agents, as measured by the return to them on marginal or "no-rent" land, why should not profits be regarded as the residuum or surplus to be arrived at by deducting the remuneration of other agents, as measured by their returns in a marginal or "no-profit" business? And when, by these or similar processes, we have arrived at satisfactory "laws" which determine rent, profits, and so forth, surely we can determine wages (as General Walker did) by making them, too, a residuum when the other factors have been paid off. It is clear that all such attempts are based on the system of equations  $a = x - b - c - \text{etc.}$ ,  $b = x - a - c - \text{etc.}$ ,  $c = x - a - b - \text{etc.}$ , and so on, none of which adds anything to the original datum

Consequences  
of the con-  
ception of  
rent as a  
residuum.

$x = a + b + c + \text{etc.}$ , but each of which assumes that data have been independently obtained, with respect to all agents except that one to which it specially refers.

Nor is this the last or the worst of it. The reader will have noticed that the use of "margin" or "marginal" which we are now examining is quite different from that in which we have defined it on page 40 *sq.* and used it throughout this work. "Marginal land," for instance, or "marginal ability," in this connection, is not land or ability considered with reference to the volume of the supply, at the margin of which it is added or subtracted, but land or ability of the lowest intrinsic quality which is devoted to the industry in question. And the marginal conditions are not the conditions determined throughout the industry by the "margin" in our sense, that is to say, by the marginal significance of adding or subtracting a small increment, but are certain specified conditions applying to the production of specified units of the product. On this conception of margins many writers have conceived of one distributive category after another as consisting of an actually existing "surplus," mounting backwards towards the origin from the "margin," and constituting a great reservoir untapped by marginal distribution; and bewildered and bewildering attempts have been made to get at the marginal (least efficient) man working with the marginal (least efficient or least abundant) capital on the marginal (least efficient) land, and to calculate everything backwards from this point. But it must now be clear to the reader that all such attempts are based either on the mere arrangement of units on the abscissa in the order of their efficiency, which neither illustrates nor proves anything except that the better article commands the better price, or else are based on a misunderstanding of the geometrical form necessarily assumed by the area that represents the constant, whatever it may happen to be, in a diagram constructed on the principles of Fig. 39 (page 551). The ambiguous use of the term "margin" has obviously added to the confusion. We now see once for all that the marginal distribution in our sense (that is to say, the distribution of the product amongst the claimants in proportion to the

Errors  
arising from  
the ambigu-  
ous use of  
the terms  
"margin"  
and  
"marginal."

significance of the addition or withdrawal of a small increment, at the margin determined by the present supply), exhausts the whole product. The curvilinear area represents a margin just as much as the linear ordinate does, and may just as well be represented in the same geometrical form.

In our phraseology a unit "at the margin of  $x$ " is not contrasted with the other units in the group, which are in some way superior to it. All the units in the group are at the margin. The distinction is not between the  $x$  units of the group severally, but between the significance of each of a number of qualitatively indistinguishable units when forming one of a group of  $x$  and when forming one of a group of  $x + 1$ . The one use of the term implies qualitative differences, the other presupposes qualitative identity, within the group. In our sense of the term, therefore, all the units of every group are always marginal units, whatever the margin may be; and therefore, naturally, the marginal distribution accounts for the whole product.

It is open to any one to examine or to dispute the ethical or social claim of any factor of production to a share, in accordance with its marginal significance, or to argue that there is no industrial necessity to allow such a claim; but it is not open to any one who understands the facts to argue that when, by a marginal distribution, every factor, reduced to the common term (on the principles of equivalence of marginal significance expounded in Book I. pages 368 *sq.*), has been satisfied, there remains any residuum or surplus whatever to be divided or appropriated. The vague and fervid visions of this unappropriated reserve, ruling upward as we recede from the marginal distribution, must be banished for ever to the limbo of ghostly fancies.

Before we bid farewell to the current or recently current expositions of the law of rent, we have still to notice one curious and instructive point. There is no connection whatever between the definition of rent given by the economists and the demonstrations by which they seek to determine its amount; for the economists first carefully define land as the primitive and inalienable properties of the soil, and explain that any ordinary piece of agricultural land is, to an indefinite

The expositions of the law of rent have no connection with the definition of rent.



extent, not land at all, but capital; and then proceed to examine the law of rent (almost invariably drawing their illustrations from agricultural land) on principles that take no account whatever of this distinction; for, as far as concerns the "Ricardian" law, it is clear that if one man commands a rich alluvial soil, and another man commands soil which by drainage, permanent manuring, and other devices, has been made equally desirable, both the one and the other, and both in equal degree, will pay a higher rent than they would pay for unmanipulated moorland which it is just worth while for some one to cultivate. And again (to take the law of rent as expounded in connection with the principle of "decreasing returns"), whether the land which we rent has been made what it is by mixing marl with the original soil, by drainage, or by other deliberate process, or is what it is by virtue of its original properties, or has become valuable because of the opening of a railway line or the building of a number of houses in the neighbourhood, in any case it will be cultivated more or less intensively on exactly the same principles. The law of rent, then, as expounded by the economists, has no connection with land as defined by them, but connects itself readily enough with land in the popular sense, which is an amalgam of economic land and economic capital.

There is nothing surprising in this, for we have seen over and over again that it is impossible to draw the line either between land as a primitive gift of nature and land as embodying capital or the results of human effort, or between a change in the value of a piece of land caused by something that has been done to it and that caused by changes that have taken place elsewhere. And, finally, since we know that land and capital are remunerated on one identical principle, in conformity with their marginal efficiency, we can see that the attempt to distinguish accurately between them is as unnecessary as it is hopeless.

Indeed it may be roughly said that everything that we read in Economic books as to the pure theory of distribution, whether it refers to wages, interest, rent, or profit, is either false when asserted of the category under discussion, or else true of all the others as well.

## CHAPTER VII

### BANKING. BILLS. CURRENCY

**SUMMARY.**—*Banking had its origin in the practice of depositing money with goldsmiths for safe custody. It was found that most of the money so deposited was never taken out again, but was transferred from one credit to another. Hence it was found safe to invest the greater part of it in revenue-yielding ways, and only to hold a comparatively small reserve in gold. The miscellaneous forms of property held by the bank represent the sums that their clients hand over to each other by cheques and so help to transact the business of the country, and are in truth media of exchange. The actual transfers of gold necessary to settle balances, after all the obligations in the country have been "cleared" as far as possible, is undertaken by the banks without specific charge. But not so in the case of balances between one country and another.*

*International trade is generally carried on under the denomination of gold (or silver), but the Englishman who owes money in France might buy goods in England to the value of his debt, export them to France, sell them there, and ask his correspondent to pay his debt for him. Thus gold transactions within the countries would be substituted for cross gold transactions between them. And if an Englishman owes gold in France he would find an advantage in liquidating his debt in this way, even if he made no independent profit on this subsidiary transaction, so long as he lost less on it than it would cost to transport the gold. This machinery for discharging debts in goods when it is cheaper to do so than to pay for them in gold*

*is simplified and generalised by the use of "bills," and its action is registered by the "rates of exchange" prevailing between different countries.*

*We measure changes of value in commodities by changes of price, and as all prices are measured in gold and the price of gold therefore cannot vary, it is difficult to realise that gold varies in value just in the same way and on the same principles as other commodities do. The resistance of retail prices, and other relatively fixed scales of payment, to change, prevents the ratio of exchange between gold and certain classes of commodities and services from adapting itself rapidly to changed conditions. But in principle all values are determined by the same considerations of quantity and place on the relative scale. But whereas the use of gold as a standard of value does not affect its place on the relative scale, its use as a medium of exchange does, for it withdraws a portion of it from other uses and so raises its marginal significance. A minted sovereign is a piece of gold certified by the Government as to weight and quality. The certificate may be of value, and persons may be willing to pay for it. Hence a sovereign may be worth a little more than the gold it contains. But its cost of production (i.e. the expense of minting it) cannot maintain its price if for any reason the certificate should fall in value. This only happens rarely, for short periods, and within narrow limits. A paper currency can only be maintained so long as the paper is directly or indirectly convertible into actual commodities or immunities. A Government cannot make it circulate by saying it shall, unless it puts some actual meaning and power into it by effectively relating it to actual values.*

We have now closed our critical investigations directly relating to the construction and interpretation of diagrammatic curves and the economic problems they suggest; but a somewhat isolated branch of inquiry, indicated by the title of this chapter, still demands our attention. It is not my purpose to enter in detail upon questions of finance and currency, but the very short examination of the subject with

which we contented ourselves in Book I.<sup>1</sup> must be supplemented by notes on a few topics, selected partly for their fundamental nature, partly for their important bearing on current discussions, and partly because, as I believe, false conceptions of a peculiarly insidious kind are current concerning them. Much will be omitted that would have to appear in even an elementary treatment that aimed at completeness within its own limits.

We have already distinguished between two functions of gold. It is a standard of value by which a survey of the terms on which all manner of alternatives are offered can be facilitated, or, in other words, it furnishes the scale on which exchange values are expressed; it is also an actual medium of exchange, inasmuch as it constitutes a universally acceptable commodity, and is thus a convenient means of dividing into two stages the operations by which we transform the things we have into the things we want; for it enables us first to generalise the special forms of wealth or capacity we have, and then specialise this generalised wealth into what we want. It is obvious at once that the former function is of the wider scope, for two persons directly exchanging their wares might do so in terms of gold without using gold as an intermediary. A farmer who has hay which he will have to sell at the market price in order to buy turnips at the market price may find another farmer with turnips to sell who wants hay. In this case there may be no necessity for the material intervention of gold at all, even though it be employed mentally as a means of enabling each of the farmers to realise the other alternatives that are open. Each of them may estimate both the hay and the turnips in gold to help him in determining their relative values. When they have both determined that they can do no better than exchange, the one so much hay for so many turnips, and the other so many turnips for so much hay, they have simply to make the exchange; and if each farmer makes out a bill of the same amount to the other and they then exchange receipts, though in form there will be two distinct transactions in which each farmer assumes that the other will pay him in

Gold as a  
standard  
of value.  
Cancelling  
obligations  
to pay gold.

<sup>1</sup> Pages 127-141.

gold, as a matter of fact this is a mere customary fiction, and there are not two transactions but one. The turnips and the hay are exchanged for each other, but their values are expressed in terms of gold.

Now it may well be that two men have frequent dealings with each other in which each receives goods from the other, without at the time giving him anything in exchange for them, but promising to pay him gold to the amount required. Here the obligation to pay gold is not a mere fiction. There is no agreement to give anything else and no obligation to enter into further transactions, and the gold promised may ultimately be paid. But if at the end of six months one man finds that forty sovereigns are due from him to his neighbour, and thirty-eight sovereigns due from his neighbour to him, there is obviously no necessity for him to hand over forty sovereigns and to receive thirty-eight; it will be the same if he pays over two and the men exchange receipts. And if some such approximate balancing of claims can be anticipated with confidence there will be no occasion for each of the two to keep by him a stock of sovereigns in order to meet the claims of the other. And of course the mere fact of A owing fifty pounds to B may suggest to A the possibility of hitting upon something that he can sell him. And if (as may probably be the case) it would be inconvenient to him to find the ready money he may try to tempt B by offering him a slightly advantageous bargain. Thus he goes a little out of his way to *create* a counter obligation against which he may cancel his. Thus, one way or another, instead of requiring between them to keep eighty or a hundred sovereigns in order to be able to settle with each other, the two men will find it enough if each of them has five or six sovereigns ready to pay any balance that is likely not to be cancelled when they compare their mutual claims. This is a great advantage, for each wants to put all his available wealth into his land and crops. Here all the accounts are kept in terms of gold, but very little of the business is transacted through gold as a medium. Nevertheless each transaction is in itself a promise on the one side to deliver the goods and on the other side to pay gold. Now this incurring of obligations to pay gold which never have to be fulfilled is a phenomenon of extreme

importance in the industrial world, and the machinery by which such obligations are met without the transfer of gold repays careful study.

The simplest case would be such as the one we have already examined, where A has supplied B with commodities or services and has a claim for gold against him, and B in like manner has supplied A with other commodities and has a claim for gold against him.

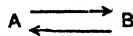

These two claims for gold, so far as they go, will cancel each other, and only the balance need be paid. Gold as a standard of value and a potential medium of exchange has been associated with the whole transaction; gold as an actual medium of exchange, only with a small part of it. But suppose A is under obligation to pay gold to B, and B is under obligation to pay gold not to him but to C, who in his turn is under obligation to pay gold not to B but to A. Then A is to receive gold from C and pay gold to B, B is to receive from A and pay to C, and C is to receive from B and pay to A—

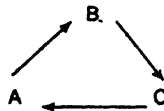

so that in the end the gold will be exactly where it was at the beginning, if the obligations are equal; and if the various transactions are not of the same value in gold, the final state will only differ from the initial state by the margin beyond the area of coincidence. Here again it is clear that a sum of gold passing from A to B, and from B to C, and from C to A again, is making the same superfluous journeys that it was found easy to avoid in the simpler case when it passed from A to B and then back again from B to A.

Now any one of these three, B for instance, might say to C: "I owe you money, but A owes me money. Instead of paying you I will tell A to pay you, and will accept your assurance that he has discharged my obligation to you in lieu of his payment to me." If C accepts this arrangement, then the form

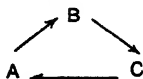

has been reduced to the form

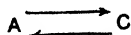

and, as we have seen, these claims cancel each other; so that the whole of the three transactions can be cancelled, so far as the gold is concerned, except for the settlement of the balances. If A, B, and C are in easy connection with each other, it does not matter whether they live in the same house or in the same city or in the same country. They might be one in New York, one in Berlin, and one in London; or they might be next-door neighbours; or they might be (as they often are) members of the same family liquidating their obligations across the table. It is easy to see that the same principle might be successfully applied to any number of persons and to any network of cross obligations and combinations if a system of cancelling could be established that involves less expense and inconvenience than the keeping and transferring of the metal would. Now the actual transfer of gold may be a more serious matter between Glasgow and London than between two streets in Glasgow, and a more serious matter between Glasgow and Berlin than between Glasgow and London. Therefore if two persons,  $A_1$  and  $A_2$ , live within easy access of each other and are in habitual communication, and two other persons,  $B_1$  and  $B_2$ , are similarly situated with respect to each other, then suppose  $A_1$  is under obligation to pay gold to  $B_2$ , and  $B_1$  under a similar obligation to pay gold to  $A_2$ , we should have

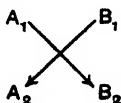

that is to say,  $A_1$  and  $B_1$  are to pay, and  $A_2$  and  $B_2$  are to receive. Then let  $A_1$  pay  $A_2$  on behalf of  $B_1$ , and let  $B_1$  pay  $B_2$  on behalf of  $A_1$ —



the result being the same, namely, that  $A_2$  and  $B_2$  have received money, and  $A_1$  and  $B_1$  have paid it. Thus, if we

regard  $A_1$  and  $A_2$  as a single group, and  $B_1$  and  $B_2$  as another single group, the form

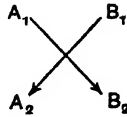

may be regarded as reducing itself to the form



and only the balance between the total obligations of the A's to the B's or the B's to the A's will have to be settled by the transfer of gold. And in the same way the A, B, and C of a former example may be groups of persons living respectively in London, Berlin, and New York.

This is the whole theory and principle of foreign exchanges and international trade, but we must further examine the machinery through which it is applied. Before proceeding with this branch of our inquiry, however, we must consider another closely connected but also contrasted financial scheme.

Let us suppose that a man who has numerous transactions with his neighbours both buys and sells with most of them, though there are some from whom he buys only and others to whom he only sells. This still is, The origin and nature of banking. or recently was, very much the case in remote country districts. Such a man may, by the cancelling process already described, conduct a great part of his exchanges under the denomination of gold but without the intervention of gold as an actual medium. But he both receives and pays in gold to some extent, and he must take care to keep by him enough of the gold that he receives to enable him to make his payments. And there are periods during which a considerable amount of coin is simply lying in his cash-box in anticipation of claims that will be made before any more cash has come in. Indeed, to be safe he always aims at having a little more than he is at all likely to want. If he could be sure of its safe custody he would be glad to be rid of the anxiety and risk of keeping this cash himself; and we are told that it was the lodging of sums of money with goldsmiths for safe custody that first gave rise to the system of banking.



Let us suppose, then, that a bank is established and that it receives the greater part of the stock of money which the community finds it convenient to have available for paying their balances in gold. The banker credits each of his clients with the amount of his stock. When A has to pay a sum in gold to B, instead of handing over the sovereigns he now gives him an order for those sovereigns upon the banker, and B, if he likes, can go to the bank and get them out. But if he too wants gold chiefly for paying balances, and if he too lodges the greater part of his stock with the banker, it is unlikely that he will draw the sovereigns out at all; he will simply hand over to the bank A's certificate that so many sovereigns are now his, not A's, and the banker will transfer the amount from A's credit to B's.

This system could be carried on either in conjunction with the cancelling process described above, or apart from it; for A and B may either give each other orders on their bankers for the full amounts of their obligations, or may exchange their bills as far as they go, and only settle the balance by an order on the banker for the transfer of credit from one to the other. And where the accounts of a whole community are thus kept by the banker, it is obvious that machinery is at once established by which many cross transactions may be simplified. Thus, in the instance given on page 579, if A has given an order on his banker to B, B may simply transfer the order to C without knowing that C owes money to A. C, in any case, may go to the bank and draw out the money, or he may leave it there to his own credit. Or if B prefers it he can draw a cheque on his bank in C's favour, and at the same time pay in A's order, so that he would at once have the credit transferred to him from A's account out of which he can meet C's claim. The more complicated the transactions are the greater the simplification that can be effected by one central recipient who has the whole field under his survey. The transactions of the community, therefore, when banking is firmly established, will be to a very great extent conducted without any physical transfer of gold at all. But so far we have not seen that the banking system effects any further economy in the amount of gold required to carry on the business of the community.

It is true that the gold need not be shifted. If it lies at the bank and is now B's, whereas it was A's, the shifting is only in the books, not in the cellars, of the bank; but A, B, and C must severally, and therefore collectively, have credit at the bank for the full number of sovereigns that they must otherwise have kept at home. Indeed in some ways the banking system rather tends to limit than to extend the cancelling of obligations, in the strict sense, as between individuals. Every one knows that it often conduces to simplicity and clearness of account-keeping actually to go out of the way to avoid cancelling transactions, and to exchange cheques as well, when exchanging receipts; so that a man may have to keep a larger balance at his banker's than the reserve of sovereigns that would be necessary if he did business with his neighbours by cancelling accounts. Otherwise there would be danger of overdrawing, at any rate for a few days or hours. For if A owes B £40, and B owes A £38, and neither of them has more than three or four sovereigns, they can settle their accounts when they meet; but if they avail themselves of the conveniences of banking, and without waiting till they meet send each other cheques, if one presents his cheque at the bank a few hours before the other there will be no credit to meet it unless balances of £40 or so are kept at the bank. Thus in some cases the conveniences of banking may be an alternative to those of cancelling, and may involve the maintaining of a larger balance of money in hand. But it is also possible that banking may be resorted to in conjunction with a system of private cancelling, and in any case it may obviously facilitate the interchange of obligations by which A can make his credit with B discharge his obligations to C, and so forth. But all the while it would appear as yet that the gold, whether for paying of balances or total amounts, must exist in the hands of the bankers though it is not transferred. The economy is in moving the gold, not (so far as we have yet seen) in the amount of gold that is kept.

But now we must take another step. The banker finds that only a comparatively small part of the gold with which his clients are credited is ever taken out: the greater part of it is left with him

Bankers' investments and reserves.

and is simply transferred now to one credit and now to another. The consequence is that he does not find it necessary actually to keep all the gold which stands to the credit of his clients. He can transform the greater part of this wealth into revenue-yielding forms, provided he keeps enough cash to meet all claims that he can in reason expect will be made on it. For, as we have seen, if A gets an order for gold from C, whether he wants it immediately to settle B's claims, or wishes to keep it ready for any other and future purposes, he will generally not draw out the actual sovereigns, but will simply leave the credit he has received in the banker's hands, or request him to transfer it to some one else.

But the persons in the neighbourhood of Bank A will not deal exclusively with each other. They will deal to some extent with persons in other parts of the country; so that persons dealing with Bank A may be under obligation to pay sums of money to the clients of Banks B, C, etc., and customers of these banks will be under similar obligations to the clients of the others, including A. All these transactions may also be carried on by means of orders to the bankers to transfer credits, only now the client of Bank A will order his banker to transfer his property not to another of his own clients but to a client of Bank B. Here then is an actual order to transfer gold from his cellar to that of another banker, not from the credit of one of his clients to the credit of another, and it would seem that the gold must be shifted. But there will be a number of such obligations on the part of Bank A to Bank B, and a number of counter obligations on the part of Bank B to Bank A, and now, so far as the transfer of gold is concerned, a genuine cancelling of obligations may take place. Bank A sends a number of orders for gold on Bank B, and Bank B meets a part of these by counter orders for gold on Bank A. Perhaps a balance is still due from Bank B to Bank A in gold, but a balance may be due to Bank B from Bank C, and so forth; and—since all the banks will be connected with each other directly or indirectly, through local branches of the Bank of England, through their agents in London, or otherwise, and since they will all (as we shall see)

ultimately have balances at the Bank of England,—partly by a system of cancelling obligations and partly by a system of cheques on the Bank of England, they will probably arrange all their affairs without the material transfer of any coin whatever.

Thus it is only a portion of his property (if he is in trade a small portion) that each individual will wish to command in the form of gold; and of this portion, again, he will only desire to have a fraction, probably a small one, actually in his cash-box in the form of gold; the rest he will hold as a balance at his banker's, which he is entitled to realise in gold at any moment he chooses. Now of these balances the banks will hold the larger portion in the shape of revenue-yielding forms of wealth; and of the portion which they desire to command in the form of gold the branch banks will, again, only keep a fraction in their tills; the rest will be held by the great houses in Birmingham, Liverpool, Manchester, and so forth; and these, again, will hold only a portion of their reserves in gold, and the rest in the form of credit with the Bank of England. The Bank of England in its turn will hold the greater part of the property with which it is entrusted by the other banks, and which they may at any time claim in the form of gold, in the shape of revenue-yielding forms of property, only maintaining such a reserve in actual coin and bullion as it deems sufficient both to meet the claims that will actually be made upon it and to maintain its credit unshaken.

Thus we see that enormous economies in the use of gold as a medium of exchange are effected. The whole metallic reserve held by all the banks constitutes a very small fraction of the collective liability of the banks to pay gold on demand; for note that every depositor in every bank is entitled at any time to draw out the whole of his property in coin of the realm, or in Bank of England notes, which in their turn he may present at the Bank of England, demanding gold in exchange for them. Every one, then, is entitled to draw out the full amount of his balance in gold, and *any one* can actually do this as long

By the banks all kinds of property are converted into media of exchange, though gold remains the only standard of value.

as the machinery is working smoothly; but it would be impossible for *every one* to do it, because the immensely greater part of the property does not exist in the form of sovereigns or gold at all; it consists of all kinds of property and obligations, of a value equivalent, at the marginal terms of exchange, to the total sum which the public has the theoretical right to draw out in gold. It all exists, however. Every man's balance severally, and the whole amount of the deposits in the banks collectively, represent real property, and all this property is in the possession of the banks at every moment, to its full amount. It is the greatest mistake to suppose that the whole body of banking transactions reduces itself to mere entries and transfers in books, and that if the banker had simply squandered the property entrusted to him, everything would go on just the same so long as nobody knew it. For it is just because the property is there, and is most of it yielding revenue, that the banker is able to pay his staff and support his own expenses. The property of the clients, represented by their balances at the bank, is real property and is doing real work; and the revenues that accrue to it in virtue of that work are paying for all the privileges and conveniences that the clients enjoy. If five hundred people draw cheques on the same bank on the same day to the extent of £5000, and only 50 sovereigns, one per cent of the whole, are actually drawn out of the bank, nevertheless, each individual cheque has behind it a basis of actual property to which the drawee has received a valid title. If the bank is solvent, then even if it had to "stop payment," that is to say if it were unable to meet all the simultaneous claims for actual coin made upon it, the holder of credit in it would be the holder of actual property. Thus the man who pays a cheque, hands to his correspondent a document which gives him a substantial claim; and the sum of these substantial claims (unlike the formal right to draw coin) can be met simultaneously; for the holders of the cheques and credits in the bank are entitled, in the last resort, to enter into acknowledged and legal possession of miscellaneous property that is actually bearing revenue and is negotiable, like all other property, in the public markets. So when I receive a cheque in exchange for

valuable possessions or services, though I do not thereby enter into possession of the commodities and services that I myself require, yet I do get actual property, not a mere pretence or symbol of property. The actual property I get is valued by some one else, and I can hold it until I find it convenient to exchange it for property that I value myself. Thus by the banking system a vast amount of miscellaneous claims and possessions other than gold are converted into "media of exchange" just as real as gold itself; for they mediate between the things I have and the things I want, and enable me to transform the one into the other without the necessity of a double coincidence between my wants and those of my correspondent. The whole mass of cheques which is exchanged day by day is therefore not an economy of "media of exchange" at large. It is a calling into partnership with gold, as a medium of exchange (but not as a standard of value), of an immense amount of other property. To regard the banking system of England as consisting in a cunning device to make sovereigns that only exist as entries in a book do the work of real sovereigns, is a fundamental misconception.

The great bulk of the business of the country, therefore, is still carried on by the intervention of media of exchange, but only a little of it by the medium of gold; whereas almost the whole of it is carried on under the denomination of gold. Gold, therefore, has a far wider application as a standard of value than as a medium of exchange. But even in this last capacity it is still active. Actual transfers of gold are constantly made from individual to individual, from bank to bank, and from city to city. The obligations of the bankers in Edinburgh and the bankers in Liverpool may not accurately balance each other, and even if the balances are settled by cheques on the Bank of England the receiving banks may find it convenient to demand cash and not a credit from the Bank of England itself. Or at any time and independently of other banks any given bank may desire to draw cash from the London (or other) agent with whom its reserve is deposited. So there will be a pulsation and ebb and flow of gold not only within any given district but from one district to another, and the banks undertake, as

part of their business, to convey the actual coin from one part of the country to another, as may be needed.

Thus if I live in Birmingham and owe money to a man in Leeds, I may send him a cheque on a Birmingham banker, and this will save me the expense and risk of actually sending him the gold. It may turn out, as the result of the whole series of transactions between Birmingham and Leeds, that gold actually has to be transferred directly or indirectly from Birmingham to Leeds, or it may turn out the other way. In the first case the fact that I have transferred a portion of my credit in Birmingham to the credit of some one in Leeds will aggravate the situation. In the other case it will relieve it. And this will make a difference

to the bankers, but it will make no difference to me. The banker will conduct my business on the same terms whether this particular transaction happens to increase or to diminish his own expenses. It is indeed possible that if I am dealing with a distant part of the kingdom he may charge a special commission on all cheques, but this commission will be uniform and will not depend on whether this particular transaction tends to involve him in the expense of the transfer of gold or tends to relieve him from it. The expenses of the transfer of gold, then, whenever it may be necessary, are a part of the general obligations incurred by the bank to its clients, and no individual dealing with other individuals through a bank in the United Kingdom has to consider whether this particular transaction is likely to involve the expense of a transfer of gold, for if it does he will not have to pay anything extra, and if it saves such a transfer he will derive no benefit from the fact.

But if a London merchant is under obligation to pay gold to a Paris merchant there is no machinery by which he can once and for all contract himself out of the liabilities or privileges that may be incidental to the money being due in Paris and the gold being in London, when the time of settlement comes. And it is here that the economic difference between home and foreign trade clearly emerges.

In home trade the expense of actual transfer of gold, in settlement of balances, is not made a separate charge by the banks on the persons on whose behalf it is undertaken.

In foreign trade the responsibility for the transfer remains with the contracting individual.

There is obviously no reason why the purely economic forces which urge men to further the purposes of others in order that they may thereby further their own, should in any way be limited or qualified by national boundaries. And from the economic point of view it therefore seems impossible to conceive that there should be any essential difference between foreign and domestic trade. Whatever differences there are must apparently be differences of condition or of machinery, not of economic principle or theory. But what are these differentiating considerations? Some of the conditions under which, and obstacles in the face of which, the economic forces act may indeed be determined by a difference of government or language, or both. But it is difficult to assign any general or dominant efficacy to them even when they coincide with the areas of "home" and "foreign" trade. Familiarity and confidence are essential elements for the carrying on of business, and this may, in a vague way, be furthered by a common nationality, language, or government; but it is hard to see why a merchant in Dover should necessarily have more familiarity with or confidence in a merchant in the Hebrides as against a merchant in Calais. English and Americans speak the same language, yet their dealings constitute a branch of foreign trade. Englishmen and Welshmen deal with each other, and their dealings are a branch of domestic trade, even if they habitually speak different languages. English and Irish trade is domestic, and English and French trade foreign quite irrespective of the *cordialité* or otherwise of any *entente* that may exist between the peoples. Colonial trade is usually (and rightly, as we shall see) classed with foreign rather than home trade, though by the sentimental tests it should belong to the latter. Tariff boundaries seem to promise a more important distinction; but the trade between England and Denmark is foreign trade though there are practically no tariff barriers to overcome, and the trade between Florence and the surrounding agricultural districts is domestic although a tariff barrier is drawn round the city. Where, then, are we to look for any essential differences? Is it in the different systems of currency? No; for the standard coins minted by any one of the countries forming the "Latin Union" were made legal tender in the



public treasuries of all the others by a treaty of 1866, and were practically received as such in all private transactions. Moreover, even where there is no such legal or conventional equivalence of currencies, transactions are conducted under a common standard. The affairs between Germany and England are conducted in terms of gold, and the sums of gold which people in London and people in Berlin have engaged to pay each other can be cancelled directly or indirectly, as between Liverpool and Glasgow; the balances in either case being ultimately paid in gold which has to be physically transported from the one centre to the other. But, as we have seen, there is a real difference in the machinery by which the cancelling is effected and the form in which the individual trader meets his share in the expense of the necessary transfers; and it is to the examination of this point that we must now return.

Let us revert to the case examined on page 579. We suppose that three persons, A, B, and C, are in such relations with each other that A owes to B, B to C, and C to A. That is, B having supplied things to A, sends him in a bill, C sends in a bill for the like sum to B, and A to C. Let A send in his bill to C and request him not to pay it, but simply to acknowledge that he owes the money and will pay it to any one A may nominate. Let C send back A's bill with this undertaking endorsed on it, and then let A write on it a statement that it is B to whom the money is to be paid, and let him then forward the document with these two endorsements upon it to B. B has now a claim upon C for the money which A owes him, and as C has a claim for the same amount on B, the two claims meet each other and there is no transfer of coin at all. A has settled his account with B by giving him a bill upon C; and this is the type of the instruments by which international obligations are cancelled. We have only to suppose that A lives in London, B in Bombay, and C in Amsterdam to transform this into an actual case of settlement of international accounts by bills.

We may note at this point that theoretically there are three exactly equivalent ways of settling such a group of accounts.

Importance  
of "bills" in  
foreign trade  
and the  
nature of the  
economies  
they effect.

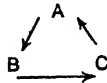

may be resolved into

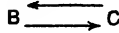

into



or into



according as A "draws a bill" on C, B draws a bill on A, or C draws a bill on B. All these processes are identical in principle and in effect. Custom determines the prevailing practice in each important case.

But the "double coincidence" implied in this example will be rare. An English merchant may well export woollen goods to New York, a New York merchant wheat to Amsterdam, and a Dutch merchant dairy produce to London; but it is not likely that it will be the same English merchant that sells the woollen goods and buys the dairy produce. And so with the others.

We shall therefore have, in the simpler case of the two countries, dealing with each other both ways,

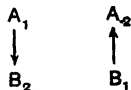

resolving itself, by the agency of a bill, into

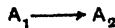

That is to say: the Paris merchant  $B_1$  who owes money to the London merchant  $A_2$  will find another Paris merchant  $B_2$  who has a bill against another London merchant  $A_1$ ; he will pay it and will then send  $B_2$ 's order on  $A_1$  in payment of his own obligation.  $B_2$  will then have been paid by  $B_1$ , and  $A_2$  will draw upon  $A_1$ , who will pay him.

In the more complex case we have

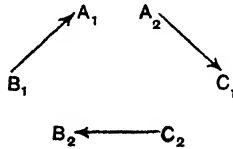

An English merchant A<sub>2</sub> has bought dairy produce from a Dutch merchant C<sub>1</sub>. C<sub>1</sub> finds another Dutch merchant who has bought wheat from a New York merchant B<sub>2</sub> and wishes to pay him. C<sub>1</sub> sells his bill on A<sub>2</sub> to C<sub>2</sub>, who forwards it in payment to B<sub>2</sub>. B<sub>2</sub> finds another New York merchant B<sub>1</sub> who owes money to an English merchant A<sub>1</sub> for woollen goods. He buys the bill on A<sub>2</sub> from B<sub>2</sub>, and forwards it in payment to A<sub>1</sub>, who presents it to A<sub>2</sub> and receives payment for it. Thus A<sub>2</sub> has paid A<sub>1</sub> instead of C<sub>1</sub>; C<sub>1</sub> has been paid by C<sub>2</sub> instead of by A<sub>2</sub>; C<sub>2</sub> has paid C<sub>1</sub> instead of paying B<sub>2</sub>; B<sub>2</sub> has been paid by B<sub>1</sub> instead of by C<sub>2</sub>; B<sub>1</sub> has paid B<sub>2</sub> instead of paying A<sub>1</sub>; and A<sub>1</sub> has been paid by A<sub>2</sub> instead of by B<sub>1</sub>.

The movement has been

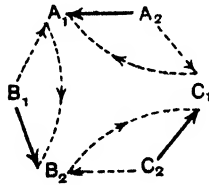

A<sub>2</sub>, C<sub>2</sub>, and B<sub>1</sub> have paid, and A<sub>1</sub>, C<sub>1</sub>, and B<sub>2</sub> have received, as was due; but the settlements have all been made without transfer of coin from country to country.

The instrument of liquidation has been a bill on London; but theoretically it might equally well have been A<sub>1</sub>'s bill on B<sub>1</sub> in New York, or B<sub>2</sub>'s bill on C<sub>2</sub> in Amsterdam. But it is manifestly unnecessary for more than one bill to circulate.

Thus we see that in international or colonial trade (for we might just as well have had Quebec as New York in our example), through the instrumentality of bills payments within a country may be substituted for payments from one

country to another, even when all the transactions are conducted and all the obligations incurred in terms of gold, and even if every one of the creditors requires and receives full payment in gold.

But the most important and complex part of the investigation still remains. How are balances settled? They

might be, and sometimes are, settled by the actual transfer of gold, but the expense of transferring gold from Berlin to London, for example, is about  $\frac{1}{4}$  per cent. More closely, if a German has to fulfil an obligation to a London merchant for £1000, it would cost him about £1002:9s. if he actually sent the gold. Now in any given state of trade there will always be German merchants who would be pre-

The settle-  
ment of  
balances.  
Rates of  
exchange  
between  
different  
countries.  
Their effect  
upon trade.

pared to export, say, musical instruments or glass to London, if they could get a very little better price than they can actually command. A German merchant who would just not be induced to accept a certain order at £1000 might just be induced to accept it at £1001. If such a man, having an offer of £1000 for certain goods, were to say to the German who owes £1000 in London, "I will discharge your debt for you by sending goods to London which will be accepted as the full value of £1000, if you will give me £1 for doing so," it would pay the German debtor to accept the offer. The German manufacturer would present him with a bill against his correspondent to the full amount of £1000, he would despatch it to London in payment of his obligation, and it would have cost him £1001 only, instead of £1002:9s. Thus the exports to England will increase, and the balance "against" Germany (that is to say, the obligations of Germany to England in excess of those of England to Germany) will be reduced. But it may be that in spite of this Germans are still buying more from England than England is buying from Germany, so that the obligations of Germany are still mounting, and German debtors, having exhausted all the possibilities of finding German manufacturers who are within £1 on the £1000 of striking bargains in England and so creating bills on her, will have to offer better terms and make use of those who are, say, only within £1:5s. on the £1000. And this process may go on until there is no German manufacturer or

exporter who will undertake to deliver any goods in London which will have the market value of £1000 there, unless he receives a premium of £2:9s. for doing so. When it comes to this, if there is still a balance to be paid, the German debtor will have nothing to lose by despatching the gold, and he will therefore do so.

If the balance is the other way it will be the English debtor who may have to pay a premium on getting his debt discharged, and the English manufacturer of woollen or leather goods, or hardware, who may be induced to sell his wares in Berlin at a lower price, after allowing for transport, than he would accept in England, because he will receive a premium for discharging a debt in Berlin. In a word, when there is a balance due from London to Berlin, a claim for money in Berlin being worth more to a London merchant than a claim for money in London, the export trade will be stimulated. And when the balance is the other way of course the reversed relation holds.

Sums approximating to £99:16s. and £100:5s. are known as the *gold points* between London and Berlin. Naturally the gold

points between any other two centres are different. The gold points. They are the points to which the premium must rise either way in order to make the actual export of gold the cheapest way of settling a balance. Within the gold points balances are settled by exporting goods which would not have yielded a profit had exchange been at par.

The gold balance will, normally, be "against" gold-producing countries, where gold is a staple export and obligations are normally discharged in it, for these countries normally export gold and receive other commodities in exchange; whereas in other countries the balance will prevalingly be "favourable," that is to say, they will receive their share in the increasing supply of gold in return for export of other commodities.

On the basis of these actual "bills" a fabric of drafts and instruments of every kind is raised, by which international obligations are liquidated. Thus a cheque on my London banker sent to a friend in Berlin becomes a "bill" on London, that is to say, a claim for so much gold in London; and if such claims are at a premium in Berlin, it will sell for more than the metallic value of the gold it represents. And so, too,

with Bank of England notes.<sup>1</sup> The case of actual coin seems anomalous. By hypothesis gold in London is of more value to the Berlin merchant than gold in Berlin. Yet when, for that very reason, bills on London are at a premium, English sovereigns follow the bills and will exchange for more than their metallic weight in German coin. *Qua* gold they are worth less, but *qua* instruments by which obligations can be discharged in London they are worth more, and persons who are intending to go to London and spend money there will pay more for them, just as willingly as for notes. If there were a large number of them, and their export to settle obligations in London became a business, a man who undertook to send them to England for the convenience of others, instead of desiring to take them across for his own convenience, would have to be paid. But as there are not enough to satisfy all the wants of those who desire them, not as gold but as English coin, they remain at par with the notes this purpose of which they serve equally well. The chief centre of the "bill" business in the larger sense is London, and "drafts" on London are drawn by all nations in settlement of their accounts.

Expositions of the theory of foreign exchanges often dwell too much upon the form which the transactions take without connecting it sufficiently closely with the ultimate movements of trade which it represents. We do not find in practice that one man goes to another, as we have supposed, and says, "I will discharge your debt for £1000 in London if you will give me a commission of £1 for doing so." But the man who owes £1000 goes into the market to buy a bill by which he can discharge his debt, and finds he has to pay £1001 for it. This of course simply means that to induce some one to create a bill for £1000 on Berlin, that is to say, to supply goods for which he will receive £1000, he must offer him a premium of £1 for doing so. A man who has a bill must sell it for what it can fetch, but he will not create a bill, by a transaction which taken alone would involve a loss, unless he can sell it at a profit. If there is a profit of £1 to be made on creating a bill for £1000, any one can do it if it is worth

<sup>1</sup> Notes that are at a discount, and will not discharge gold debts to their face value, in their own country, will of course be at a discount elsewhere too, independently of the balance of indebtedness

his while. And as a matter of fact bargains are struck by telegraph all over the world in accordance with the rate of exchange, which varies from day to day; and the amount for which a man can negotiate a bill on such and such a centre is a material consideration in the terms which he can offer his correspondent. All this is perfectly understood, but a delusive simplicity can be given to the exposition by simply treating bills as though they were themselves commodities, and saying that if bills on Berlin are scarce they will rise in value like any other commodity, and if they are abundant will fall, only that they cannot rise or fall beyond the gold points because there would then be cheaper substitutes for them. The superficiality of this treatment need hardly be pointed out. The bill is not a commodity, and we must go behind the phenomena of the bill market to the actual commercial facts which it represents.

Our treatment of the principles of banking and of foreign exchange has necessarily been extremely brief and imperfect, and it is not compatible with the scope and aim of this work to go into further detail. There is, however, one branch of the subject which still remains for examination, and it cannot be wholly neglected. It is the question of the principles which regulate the distribution of the precious metals, and specifically gold, between its uses in the arts and in the currency.<sup>1</sup> The difficulties that surround this question do not arise so much from the use of gold as currency as from its use as a standard of value, and with this we will therefore begin. There should be no real difficulty in understanding the fundamental relation between gold and other commodities. But it is extremely difficult not to be confused by the language in which we have to express

Difficulty of tracing the similarity of the effects of an increase or diminution of gold and those of an increase or diminution of other commodities, due to the confusion caused by the reversing of our terminology when we are speaking of the standard commodity.

<sup>1</sup> As I believe that the line of investigation here pursued is somewhat novel, and as I have no technical knowledge of minting or of the gold market, the whole of this section should be regarded as a tentative suggestion rather than a dogmatic exposition. My reason for giving it at all is that I believe the usual treatment of the subject to be theoretically unsound (cf. pages 610 *seq.*), and therefore it seemed desirable to attempt a fresh analysis.

the facts. Thus high gold prices mean low price of gold; for the gold prices of other things are the amounts of gold that must be given for them, whereas the price of gold is the amount of other things that must be given for it. Thus, abundant gold means high prices (in gold), and scarce gold means low prices (in gold). Whereas abundant wheat means low prices (of wheat), and scarce wheat means high prices (of wheat). This is perfectly consistent; but since, when we are speaking of gold, "prices" mean the prices *in* the commodity of which we are discoursing, and when we are speaking of other things prices mean the prices *of* the commodities of which we are discoursing, the terms constantly confuse and frequently betray us when we are considering the theory of finance and currency. The most experienced scalers of the Alpine heights of speculation in the currency have constantly to steady their heads in these regions of discourse, and the novice is almost certain to be the victim of aggravated *vertigo*. The facts, however, that lie behind these bewildering phrases are intelligible enough. We will approach them by forgetting gold for a moment and speaking of wheat. If there is a good wheat harvest, a given amount of wheat will exchange for less of any other commodity or service, and any other commodity or service will exchange for more wheat than if the harvest is bad. High wheat prices would correspond to a relative abundance of wheat; that is to say, a value which was expressed as ten pecks of wheat when wheat was relatively scarce might be expressed as eleven pecks when it was relatively abundant. Consequently if a man had a fixed income of so many quarters of wheat, independently of its abundance or scarcity, he would find when wheat was abundant that prices had risen against him, and although his nominal wheat income would be the same, his real income in the general command of commodities and services would have fallen. But if the man's nominal income were increased so as to make his real income the same, he would find that wheat being cheaper than before relatively to other things, that is to say, the sacrifice of other things involved in consuming a peck of wheat being smaller than before, there would be a tendency in his administration (imperceptible if he were rich, very



marked if he were poor) to consume more wheat in proportion to other things than he had done previously.

On the other hand, if the crop of wheat relatively to the number and habits of the population remained constant for a long series of years, and the amount of gold increased, people would gradually discover that all articles made of gold became relatively cheaper, whether measured in wheat prices or in the equivalents of other services and commodities; and men who had hesitated to pay the extra price for the use of gold in dentistry, or publishers who had refrained from attractive touches of gold in the make-up of their cheap issues, would find that it was now worth their while to incur the lessened expense. Thus, if a man were considering whether he would order a set of artificial teeth, containing a certain amount of gold in the plate, he would find that whereas the extra cost would formerly have been a quarter of wheat, now that gold is cheaper it will be less by a few pecks. He may think this lower (wheat) price worth giving for the additional advantage, in durability and comfort, of having the gold in his plate, whereas at the former price he would not have ordered it. Gold being cheaper it can be had at less sacrifice of other things.

Now these consequences of an increased crop of wheat or an increased output of gold will remain exactly the same if gold, instead of wheat, is the standard. If gold becomes relatively more abundant, gold prices rise, and the man whose real income remains the same (his nominal income being raised, as in the case of the wheat standard) finds gold articles relatively cheaper because all other things are dearer in gold prices, so that the amount of other things he would be able to get instead of the gold in his plate is now smaller than it was, and the sacrifice of other things now involved in securing the plate being therefore smaller, he may be willing to incur it. If, on the other hand, the relative supply of gold remains constant for a series of years and wheat becomes more plentiful, there will be a tendency to substitute the consumption of wheat for that of certain possible alternatives. Thus the relative value of wheat or of gold in relation to other things, and the extent to which they are used by individual consumers, depend on the

relative abundance of wheat or of gold, and are entirely independent of the standard in which values are measured, though the position of a man with a fixed income is naturally dependent on the article in which that income is fixed.

If our general thesis is correct that the economic forces tend to secure remuneration to every man and prices to all articles in accord with the marginal significance of the services they render, then there would always be a tendency for nominal wages in wheat to increase if wheat became more abundant and for nominal wages in gold to increase if gold became more abundant; but this tendency may have serious obstructions to overcome. Confining ourselves to the case of the gold standard and the gold prices with which we are familiar, it is obvious that even if a man has not a fixed salary expressed in terms of gold, there may be a traditional price of his services which will offer a certain opposition to change. It would not be easy for a man to change his terms from 7s. 6d. to 7s. 8d. an hour for some kind of instruction, or from 4s. or 10s. a thousand words for translation to the same sum for 1010 words, if the ratio in which gold exchanges for wheat and other commodities had changed. This inertia, or friction, affects all kinds of bargains, the terms of which ought, on the general principles of exchange, to fluctuate not only with the supply of the commodity or capacity concerned and its place on the communal scale, but also with the change in the significance of the unit in which it is expressed; and schemes of a complex standard of value that would automatically preserve the ratio between established prices and their purchasing power have been designed; but they have never come into use; and therefore any man may find himself prejudiced or advantaged by a contract or convention that only yields to the changing facts under severe pressure; and he may therefore be giving either more or less than the value of what he gets, because the terms of his bargain have ceased to correspond with the facts. There is a specially marked tendency to retain certain retail prices at a fixed nominal level, and the fact that this

Friction caused by traditionally or contractually fixed salaries and prices.

can continue—that the price of a hat, for instance, or the admission to an exhibition remaining fixed through great fluctuations in the purchasing power of gold—shews how much friction counts for, and how much the action of the general economic trends is impeded when it has to force itself through the narrower channels of the commercial system.

But when the amplest allowance has been made for all this friction the general proposition remains true that whether wheat or gold were the standard an increased crop of wheat would at once raise wheat prices and encourage the consumption of wheat, whereas an increased supply of gold would raise gold prices and encourage the use of gold. We have, therefore, to keep in mind that, under a gold standard, high prices correspond to cheap gold and low prices to dear gold; and that in principle and in the long-run this difference of expression is the only difference which the selection of gold as the standard of value really makes, *except in so far as the use of gold as a standard of value involves its use as a medium of exchange.* This use as a medium of exchange constitutes an extra use for gold, and consequently raises its value, just as every additional use for any other commodity would, and does. Every individual finds it convenient to hold a portion of his property in the form of gold (or the subsidiary currencies, into the relation of which with gold we need not enter), and therefore a certain amount of gold is withdrawn from other uses, and its marginal significance in these other uses rises. How much does each individual thus set aside? If he is living from week to week or from year to year upon his current earnings, he will practically desire to have the whole of his income immediately available in this form, for he never has enough property for a long enough time to enable him to invest it in revenue-yielding ways. But if he is engaged in any kind of trade or any occupation which involves the acquisition and maintenance of capital, or if he is spending less than his income, or if his earnings are considerable and his expenditure is irregular over long periods, there will be a perpetual question in his mind how much of his property to keep immediately realisable in

The use of gold as a medium of exchange, unlike its use as a standard of value, constitutes an actual demand for it, and therefore raises its marginal significance.

gold and how much to employ remuneratively. He will not, indeed, in any case keep any large stock of actual coin about him, but he will keep a certain amount of his property as a fluctuating balance at his banker's, and all of this is available at any moment in the form of gold. This balance he will not make larger than necessary, for (neglecting the details of the arrangement with his banker) it will be practically "lying idle." The adjustment, then, of the portion of his income which he keeps available in coin to the rest of his income will be determined on exactly the same principles as all other distributions. A very small balance might be inconvenient, a somewhat larger balance less inconvenient, and the marginal inconvenience of this larger balance might not be sufficient to compensate the advantages of investment. When we come to the bankers we are in face of exactly the same problem. They must be prepared to meet all claims for coin. This they will do by keeping actual coin in their tills and by keeping a balance, that is to say, a claim for gold which will ultimately lie for the most part against the Bank of England. They do not wish this balance to be more than enough to keep them safe, for it is from the revenues derived from the rest of the property which they hold in trust that they derive their own incomes. And the same is true of the Bank of England itself.

But we have still not quite come to the question of the currency. We have been speaking chiefly of gold rather than of sovereigns, and the great reserve in the Bank of England is, as a matter of fact, largely in bullion, not in sovereigns. What determines the amount of gold which is actually coined? The answer to this question is at bottom quite simple. The process of converting bullion into sovereigns or sovereigns into bullion is supposed to cost about  $1\frac{1}{2}$ d. an ounce either way, and if any competent firm were allowed to undertake the minting of sovereigns, and were to do it at that price, it is clear that the value of an ounce of gold in sovereigns could not remain greater or less than that of an ounce of gold in bullion by more than  $1\frac{1}{2}$ d. an ounce (which is about 0.16 per cent), for the one could be converted into the other at that price. For the purpose of actual currency the gold must

Distinction  
between a  
gold reserve  
and coin.  
What deter-  
mines the  
amount of  
coin!

be in the form of sovereigns, for that is the certificate (of the Government in the actual fact, of the issuing firm in the case we are supposing) of the quality and quantity of the gold, and such a certificate would be required by all persons, not experts, as a guarantee that they were really receiving the gold. Now it might be worth any one's while to pay something for this convenience; that is to say, he might be willing to receive a little less gold in a form in which it would be accepted and could be exchanged by any one, rather than a little more in a form in which it could only be accepted by or exchanged with experts. The ordinary man, indeed, desires to have no gold except in this form and incidentally in his bookbinding, jewellery, and so forth. But the goldsmith, the bookbinder, the dentist, and others who put gold into their business in the most literal sense, desire gold both in coin and otherwise, and they will not take a smaller quantity in sovereigns in preference to a larger quantity in bullion unless they derive some corresponding convenience from it. And this they will only find to be the case to a limited extent. Thus, with the goldsmith in particular, the balance which we have seen other men strike between the amount of property which they keep in their business and the amount which they keep at the banker's will resolve itself to a great extent in his case into a distribution between the amount which he keeps in bullion or manufactured articles and the amount he keeps in coin or as a balance with his banker. Now, seeing that it costs the equivalent of  $1\frac{1}{2}$ d. an ounce to convert bullion into sovereigns, one might naturally expect under the conditions we have supposed that sovereigns would be worth more than bullion at the rate of  $1\frac{1}{2}$ d. an ounce, for why should any one be at the expense of making them to such an extent as to bring their marginal significance below that point? Whereas until it has reached that point there will be a profit in coining; so it will not rest anywhere above it. But we have seen that there is always a risk of the price of manufactured articles being less than their cost of production, and it is therefore conceivable, in the abstract, that such changes should take place in the demand for sovereigns and the demand for bullion as to reduce the marginal value of sovereigns below the point which alone would have justified their manufacture.

But neither could the departure in this sense be more than  $1\frac{1}{2}$ d. an ounce, for if bullion rose above that point it would become profitable to melt sovereigns. Now the gold contained in sovereigns is at the rate of an ounce to £3:17:10 $\frac{1}{2}$ . It follows, therefore, that the price of gold, if any one were at liberty to mint it, could never, except for a short time and under quite exceptional circumstances, sink below £3:17:9 an ounce, or rise above £3:18s.

Now this state of things, which we should expect if coining were an ordinary industry, corresponds exactly to the actual facts. In explaining this we will confine ourselves to the conditions established by law in England. Every man has a right to take properly assayed and certified gold to the Mint and have it coined into sovereigns gratuitously, at the rate of £3:17:10 $\frac{1}{2}$  the ounce. Any valuable alloy there may be in it belongs to the Mint, but *per contra* the Mint makes no charge for the alloy in the sovereigns.

Limits between which the value of coined and uncoined gold may vary. The Royal Mint and the Bank of England.

But though the Mint is compelled by law to coin and return the gold handed in to it, yet it is not bound to give it back at once. It is to treat all customers without favour in the order of application; and since there are always orders on hand from the Bank of England that it would take months to execute, any one who should apply to have his gold coined would be likely to have to wait, say, six months for his turn. If you reckon interest at four per cent the delay would be equivalent to a payment at the rate of about 1s. 7d. an ounce for mintage. The consequence is that no one ever does take his gold to the Mint. There is, however, another legal provision by which the Bank of England is bound to buy all the gold that is offered to it at the rate of £3:17:9 per ounce. This is only  $1\frac{1}{2}$ d. on the ounce, or a little above a third of a penny on £1. Any one, therefore, who wishes to have his gold coined can legally command better terms from the Bank of England than he can from the Royal Mint. The Bank of England is not bound to pay in sovereigns; it may pay in its own notes. But the cash department of the Bank of England is compelled to give gold for the notes of the issue department, on demand, and consequently any one who likes may take his gold to the issue department and receive notes

for it at the rate of £3:17:9 per ounce, and may then go round the corner to the other department and receive the gold. If he does this it will not hurt the Bank of England, for the Bank of England does not pay for having its gold minted; nor will it be embarrassed by an excess of gold in its cellars, for the gold will be drawn out in sovereigns as rapidly as it is put into the cellars in bullion, and the Bank may have its gold coined as fast as it pleases by the Mint. The Bank of England, therefore, will be the gainer by  $1\frac{1}{2}$ d. for every ounce of gold that is thus given it. The country, indeed, will be the loser by the expense of coining, for which it, not the Bank of England, pays. Whether by a coincidence or not, it happens that this  $1\frac{1}{2}$ d. that the Bank of England may take off the value of the gold in the sovereigns it returns, coincides with the best estimates of the cost of minting, so that while the country loses and the Bank of England gains  $1\frac{1}{2}$ d. on every ounce of gold that is minted, the net result to the man who sells the gold is exactly the same as if he had paid for the minting. There is, therefore, exactly the same check on reckless turning of gold into sovereigns that there would have been under the conditions we imagined of a country in which any firm might mint gold into coin, the cost of doing so being  $1\frac{1}{2}$ d. an ounce.

As a rule, however, the persons selling gold to the Bank of England will not at once cash the notes. Bank-notes are legal tender, and it will be convenient to the man who has disposed of a large amount of gold (if he does not wish to open a credit with the Bank of England<sup>1</sup>) to take away the legal tender that he desires in the form of bank-notes rather than in the actual sovereigns. The Bank is compelled to hold actual gold against every one of its notes that is in circulation beyond the eleven millions guaranteed by the nation. Consequently, the Bank will hold the gold that is brought in, against the notes that it issues, and if the country already has as many notes in circulation as suits the convenience of the public a large fresh issue will determine, not immediately but in a short time, the presentation of a corresponding number of notes at the cash department, in which case the effect will be the same as if the sovereigns

<sup>1</sup> See below, page 606 *sq.*

had been taken out directly. If the number of notes issued is not such as materially to swell the body of notes in circulation, no perceptible effect will take place, but in any case the Bank cannot be inconvenienced. It gains its  $1\frac{1}{2}$ d. an ounce and loses nothing.

Our investigations so far would lead us to expect that the market price of gold bullion in the open market would be £3:17:9, and this may in truth be regarded as the normal state of things, but there are occasions on which the price rises not only to the metallic par of £3:17:10 $\frac{1}{2}$ , but even to £3:18s. We saw but now<sup>1</sup> that such a state of things is not inconceivable, but the examination of the conditions under which it may arise will lead us to the most difficult part of our subject.

We have seen that the Bank of England holds a great part of the gold reserve of the world, and occasions arise on which the bankers of some one or more countries may wish to withdraw a large amount of the gold which stands to their credit. There may be danger that when called upon thus actually to pay an abnormal proportion of the claims for gold which some of its clients are in a position to make, the Bank may feel that the remaining reserve threatens to be reduced to an alarmingly low proportion of the total claim which it is still nominally liable to have to meet. It must, therefore, "protect its reserves," that is to say, prevent their being further depleted. Now what is really wanted is some means of inducing people not to draw gold, but to settle their affairs by transfers of credit; and a very small charge on actually cashing cheques in gold instead of paying them in to the accounts of the drawers, or on withdrawing gold from an account instead of transferring the credit, would suffice to accomplish this. But it is impossible to make such a charge. The value of a cheque or of a bank credit is due to the fact that though you are not likely to cash it you always can. And to place any obstacle in the way of cashing it would amount to a qualified "stoppage of payment," and it is of the essence of the security and credit of the Bank that it should be prepared at any moment and to any extent to meet its nominal obligations

<sup>1</sup> Page 603.



to pay gold. The difficulty, then, has to be met by circuitous and wasteful processes. In the first place the Bank of England does a great business in discounting bills. We have hitherto<sup>1</sup> spoken of bills as though they were claims for the instant payment of money at such and such a place, and so they may be; but many of them are claims for money, not now, but six months hence; and a merchant who holds such a bill, that is to say, who has supplied goods to a customer, whether at home or abroad, for money that will not be due for three or six months, may want to have the money either in cash or, more probably, in credit with his banker, at once. If the Bank accepts his bill that is to say, the promise of his correspondent for money three or six months hence, and gives him present cash or credit in exchange for it, it will, of course, make a charge corresponding to the interest on the money which it lends, so that when the bill becomes due it will not only repay the loan but pay interest on it also. This charge is discount. Now the Bank of England cannot prevent its clients who actually have credit from withdrawing as much gold as they choose, but it can discourage the formation of credits by raising the terms on which it discounts bills. It can, therefore, to a great extent regulate the proportion between its reserves and its liabilities by refusing to enter into fresh liabilities and so contracting its business. It thus limits the potential calls for gold, and thereby restricts the actual calls which stand in a definite relation to them. This is a wasteful and indirect process, and it affects the terms on which loans are made all over the country, often to the extreme embarrassment of business; but no more direct or economical device has yet been hit upon.

But the Bank has another means of protecting its reserves, —the very curious one of bidding for gold in the open market and offering more sovereigns for it than would make its own weight if melted. This may seem at first sight a strange way of increasing its reserves, for it is offering more than an ounce of gold in payment for an ounce; but the Bank will pay for the gold either in bank-notes or in acknowledgments, that is to say, in credit, and it calculates that the credit of the importer of gold will not actually be

<sup>1</sup> Pages 590 *seq.*

drawn out in sovereigns to any greater extent than the credit of its other clients will, and, therefore, by buying gold for notes or credit it will increase its reserves in larger proportion than its business. Thus, by buying gold and at the same time raising discount it protects its reserves from depletion, partly by contracting its general business and so reducing the claims on its reserve, and partly by increasing its dealings with a particular set of clients who will actually bring gold into its cellars, to the full amount of their accounts, and will only draw the ordinary proportion of them out again in gold. These are the conditions under which the value of bullion in the market per ounce rises above the value of sovereigns per ounce. But except for a very short time and in very exceptional circumstances this excess cannot exceed  $1\frac{1}{2}$ d. an ounce, for if the Bank of England bought gold at a higher rate than this its clients would proceed to draw out sovereigns simply for the purpose of melting them down, and bringing them back again to sell at a profit as bullion.

But we have not even yet answered the question what determines the amount of gold that is actually minted into sovereigns. The whole reserve of the Bank of England need not be, and is not, coin; and the means the Bank takes to protect its reserves has no immediate connection with the amount of gold that is minted. <sup>What determines the amount of the gold minted.</sup> What then determines this amount? The answer is simple. The private individual, who deals in gold little and indirectly except as coin, places an amount of his property determined by considerations already explained<sup>1</sup> with his banker. It is registered in terms not of bullion but of sovereigns, and he can draw out absolutely as much of it as he chooses in the form of sovereigns. Provided he has a balance at the banker's, or a claim on any one else's balance, it costs him absolutely nothing to get it in the form of coin. Hence the celebrated declaration of a Member of Parliament: "We all of us have as much money as we want." So the depositors in the banks can, and do, take out as many sovereigns as it suits their convenience to have, and the Bank of England has to see to it that enough sovereigns are minted to meet the demands. The answer to the question, "What

<sup>1</sup> Pages 600 sq.

determines the number of sovereigns coined?" is therefore, "the estimate formed by the Bank of England of the number of sovereigns that the depositors in the banks collectively want to have." As it costs the Bank of England nothing to have the sovereigns coined, and as it always has plenty of gold, there is no reason why any one should be stinted. The country, therefore, bears the expense of providing all the depositors with as much coin as they call for.

But the importers of gold are in a different position. They cannot generally exchange their gold for sovereigns at weight par. They may have to pay 16 per cent premium. Thus there is generally a check, not indeed to the minting of gold, but to the flow of gold into the cellars of the Bank of England, where it lies ready to be coined. But the Bank may reduce or remove this check or substitute a stimulus for it within certain limits, whenever it conduces to its credit to do so. On the other hand, there should be a normal check to the flow of gold out of the currency into the form of bullion again, and so to a certain extent there is. If it were not for a certain abuse, to be explained presently, all persons who required gold for their business would have a slight advantage in buying it direct from the importers rather than drawing it out of the currency. For it would seem that if the market price of gold is £3:17:9 an ounce, a man would be able to get more gold by 16 per cent in return for his cheque if he paid it to an importer than he would get from his banker by drawing out the sovereigns and melting them. And there would be the additional expense of the melting. If we put that at 1½d. he would lose 32 per cent by drawing his gold out of the currency instead of out of the market. And if the market price rose for any reason, though this advantage would be diminished, it would still always be on the side of buying gold in the market. It is true that most persons whose business requires them to deal in gold will tell you that they are not conscious of being influenced by this consideration, and that whether they buy gold from a merchant or take it out of the currency is determined by considerations of convenience quite independent of this premium, even supposing that the market price of gold perceptibly affects transactions of the scale on which they conduct them. But in the nature

of things this cannot be universally true. A market price is after all a market price, and means that gold or sovereigns are actually at a commercial premium, that is to say, that a preference for one or the other is actually felt by some one, presumably by the large dealers in bullion.

But this difference between the market price of gold and the gold weight of the sovereigns in which that price is paid, is crossed in the case of the working jewellers by a practice which we must now examine. Those <sup>A leakage in the currency.</sup> of them who deal with branches of the Bank of England are in the habit of requesting their bankers to select the heaviest sovereigns and put them aside to meet the cheques that they draw in their own favour, for purposes of melting.<sup>1</sup> Now the standard weight of a sovereign in England is 123·27447 grains. But a "remedy" is allowed to the mint-master; that is to say, an allowance for the imperfection of workmanship; so that if a sovereign does not weigh more than 123·474 or less than 123·074 it may be issued by the Mint; and it is legal tender, and may be issued by the Bank of England against its own notes and cheques, until it has sunk by abrasion to 122·50047. Between the heaviest and the lightest sovereigns paid out by the Bank of England and its branches there may therefore be a difference of ·97353 grains, which is about ·79 per cent. But presumably the Mint keeps very well within the allowed "remedy," and we may suppose that there are few sovereigns in the currency much above the standard weight, whereas the sovereigns issued against a cheque in the ordinary way would, on an average, be far above the lower limit. We shall therefore perhaps not be far wrong if we say that the average weight of the selected sovereigns exceeds the average weight of the unselected sovereigns by something less than 387 gr. or ·315 per cent, which would be very close to the full amount of 3d. on the ounce, which marks the maximum theoretical advantage on buying in the market as against melting the currency. The subject is one as to which it would be a matter of some delicacy to make close inquiry, and I do not profess to have

<sup>1</sup> The prevalent idea that private melting is illegal is without foundation. It is illegal to deface or intentionally abrade (sweat) sovereigns. Any one may melt them.

any accurate information. The practice, as far as it goes, is obviously an abuse, and together with the fact that the Mint (and therefore indirectly the Bank of England) throws in the excess of the alloy in the sovereigns which it issues above that in the gold it receives, it establishes a permanent leakage in the currency for which there is no theoretical necessity, and which constitutes a loss to the nation.<sup>1</sup> The activity of the Mint must be sufficient to keep the public stocked with all the sovereigns it wants in spite of this leakage; and the Bank of England must maintain its reserves against it.

We have concluded our positive examination of the selected points of financial science; but one theory must still be examined, for it seems to be not only unsound in itself but a fruitful source of confusion throughout the whole range of monetary science.

The "quantity law." must still be examined, for it seems to be not only unsound in itself but a fruitful source of confusion throughout the whole range of monetary science.

A treatise on currency frequently expounds what is known as the "quantity law," as regulating the value of the currency. The supposed law may be stated as follows: "The exchange medium of every country (coined gold in the case of England) has to carry on the business of the country, and this business consists in the whole volume of exchanges conducted day by day or year by year. Seeing then that the whole body of the currency, consisting of so many pieces, has to conduct the volume of exchange, each passage of a coin from hand to hand will have to conduct a certain fraction of it, and this fraction will be determined by a division sum; the dividend being the volume of exchanges, and the divisor being the number of coins employed multiplied by the average number of times that each coin changes hands during the period over which

This is only a particular case of the general phenomenon which is defined under "Gresham's law" as the tendency of bad money to drive out good. This is not really a special law affecting the currency. It is merely a special application of the general principle that if  $S_1$  and  $S_2$  are units of two specified commodities (in this case heavy and light sovereigns) which are equally capable of serving the purposes of A (who cannot indeed distinguish between them), whereas  $S_1$  will serve certain purposes of B (who can distinguish between them) better than  $S_2$  will, there will be a tendency, as they pass in exchange, for B to "secrete" the  $S_1$ 's for his own special purposes and pass on the  $S_2$ 's to A. Or in more general terms, if  $S_1$  will serve some purposes as well as  $S_2$  and other purposes better, there will be a tendency to assign  $S_1$  to those purposes which it can serve better than  $S_2$  rather than to those it can only serve as well. A light sovereign (within the limits of legal tender weight) will serve the purposes of the ordinary citizen as well as a heavy one, but the latter will serve the technical purposes of the jewellers best.

the volume of business has been taken." Hence the name "quantity" law, from the supposed determination of the value of each unit of the currency in inverse ratio to the quantity of the currency as a whole.

The unsatisfactory character of the statement must be obvious at once, and it is noteworthy that there is (unless it has escaped me) no mention of any such law, nor any implication direct or indirect of its existence, to be found from end to end of the numerous works on currency and finance of the late Professor Jevons. To begin with we may eliminate all mention of the number of coins and the "average" number of times that each changes hands. For this "average" can only be arrived at by adding together the number of times which each coin has circulated and then dividing by the number of coins. When we multiply  $a$  (number of coins) by  $b$  (number of times each circulates on an average) to obtain  $c$  (total number of transactions) we have really already assumed  $c$  and obtained  $b$  by dividing  $c$  by  $a$ . We start with  $c$  then, and as it is  $c$  we want we may dispense with the process of first dividing by  $b$  to get  $a$  and then multiplying by  $b$  again to get back to  $c$ .

The simplified statement of the quantity law would then be: "A certain total volume of trade has to be conducted by a given number of changes of a sovereign from hand to hand. Therefore each one of those changes has to conduct a given volume of exchange, arrived at by division. And as it 'has' to do this, it will do it. The amount of work we set it to do determines the amount of work it does. That is to say, the value in exchange of a sovereign is determined by the work it 'has' to do every time it shifts."

*Prima facie* this is an inversion. How can we make a sovereign do a certain amount of work by telling it it must? The total business that the sovereigns collectively do is the sum of what each of them does whenever it changes hands. The business the sovereigns *do*, one would say, depends on their efficiency severally. How can their efficiency severally depend on the work they *have to* do amongst them? Obviously no one would suggest that the services rendered to the community by a pound of potatoes or a ton of iron could be arrived at by

*Prima facie*  
objections to  
it; and the  
grounds on  
which it is  
defended.

determining in the first place the total services that potatoes or iron *have to* render annually to the community, and then dividing it by the number of pounds or tons in existence; or determining the amount of earth that a navvy shifts by every swing of his spade by stating how much earth the whole body of navvies *has to* shift, and then reckoning up their number and the average number of spade-swings which each of them performs, and dividing the total work they *have to* do by the figure so obtained. It is obvious, then, that if any such law holds in the case of the currency, it must be owing to some special characteristic which completely differentiates it from every other article. And this is exactly what is asserted by the exponents of the law in question. Their contention is that currency is a purely legal institution. A government, it is supposed, can make anything currency by declaring that it shall constitute the legal discharge of obligations; and as a proof of this we are referred to the numerous instances in history in which paper currency has been maintained for indefinite periods. In these cases a piece of paper which has an inscription, corresponding to a certain weight of gold, passes as the equivalent of so much gold and is actually received as such an equivalent by persons who deal in gold as a commodity, although it carries no right to demand gold from anybody. A Bank of England note, of course, can be cashed at the Bank of England, that is to say, any one who likes is legally entitled to receive five sovereigns of full weight at the Bank of England in exchange for the note. But in countries where there is no such obligation on the part of any private or public body, nevertheless the dealers in gold are willing to part with it in exchange for paper, and all other persons are willing to receive the paper just as if it were gold. And it is further noted that the value of the notes will not sink below the par of gold unless there has been an over-issue. Thus it seems that the government, by itself giving its servants pieces of paper with the name of an amount of gold upon them, declaring that all its obligations are thus discharged, and that it will regard all other obligations amongst its subjects as discharged in like manner, can actually give a value to the paper that depends on the amount it issues. In other words by enacting that its paper shall be received in

payment of all debts and obligations it can cause all the business transactions of the country to be conducted by its means, and having thus determined the total amount of work that the paper shall do, it can further decree how much paper there shall be to do it; and since the habits of the industrial community determine how much of its business shall be done by the currency, and how much by cheques, paying of balances, and so on, the rate at which the paper will circulate, that is to say, the number of times, on an average, that each piece will change hands in the course, say, of a year regulates itself; and so the amount of the issue will determine the amount of business which each paper unit will conduct each time it changes hands.

These facts being supposed to be established, it would follow that if the business of a country is actually conducted in gold, that is to say, in an article which has an independent industrial value, apart from the enactment which makes it legal tender, this is an unessential incident. Because, as we have seen, all the functions of money can, by hypothesis, be conducted by a unit that has no primary industrial value. If (it is maintained) the currency of any country, England for example, consists of pieces of metal that happen to have a value in the arts and sciences, then there are two independent uses to which a piece of gold can be put, one of them being the natural and direct service which gold, as gold, can render in the arts and sciences; and the other being a fictitious or legally established value, which the legislature has chosen to affix to gold, but might just as well have attached to paper, leather, or anything else, provided it could so stamp its units of currency as to prevent their unauthorised issue by others than itself. Thus, according to this theory, a sovereign as a weight of gold, and a sovereign as a unit of legal tender, are indeed physically identical, but the values that the coin has in its capacity of a legal discharge of debt and in its capacity of a weight of gold have no direct or immediate connection with each other whatever.

But a government which chooses a valuable for its currency saves itself, it is admitted, from the temptation of over-issue; for if it over-issued, then its sovereigns, *qua* currency, would have less value than they would have *qua* gold, and whoever



got hold of them would melt them until their contracting number threw more work upon each individual sovereign, and therefore raised its value in the currency; whilst the increased supply in the arts would lower the significance of gold in them. On the other hand, there can be no possibility of the value in the currency being permanently higher than the value in the arts if (as in England) there is a free mint. For any one who has gold can have it coined at will, and therefore if the amount of work thrown on each sovereign were such as to raise its value in the currency above what it bore in the arts, gold would be coined till the increasing number of sovereigns lightened the amount of work that each had to do, that is to say, reduced its value, whereas the deflection of gold from the arts and sciences would raise its value in them, and equilibrium would be restored. Thus, it is maintained, the two capital functions of gold (one primary and specific, the other wholly legal and independent of the natural properties and uses of the substance gold) will keep in balance with each other.

This theory of currency is fascinating by its ingenuity and neatness, and derives enormous practical support from its harmonising with the psychology of the ordinary man, in whose mind there is no practical connection between the value of gold as currency and its value in the arts. No man is conscious of being willing to work or to surrender his goods for a piece of gold, because gold is valuable for dentistry, for gilding picture frames or book leaves, for setting jewellery, or for making plate. His value of it for currency is something which, if he thinks about it at all, he regards as resting on custom or law. This theory then has the enormous polemic advantage of allying itself directly to the ordinary way of thinking, and as it is easy to expound and has a certain elegance, it is equally popular with teachers. But nevertheless the reasoning on which it rests is throughout topsy-turvy. From first to last it goes on the assumption that sovereigns, collectively and individually, will do what they have to do, and that the legislature can determine what that is; and throughout our exposition of the doctrine it has been obvious that we have been compelled to treat the value of a sovereign not as constituted by anything that it can and will do, but by

something which in obedience to law it has to do. Now, that the law can enable any assemblage of things to perform a certain service, or conduct certain operations, collectively, simply by saying that it has got to do so, is so startling a proposition as to demand the closest inspection. If we maintained, for instance, that the government could by decree determine that all the agricultural operations of this country should be carried on by persons and with instruments authorised by itself, and if it were assumed that this would not affect the extent or nature of the operations, but that they would all be necessarily conducted by the authorised men and implements, and therefore if there were few men and implements each would do a great deal of work, whereas if the government issued more each individual would do less, but precisely the same amount would be done altogether, we should at once see the impossibility of supposing that the amount done by each unit was determined by dividing the sum of what they all do by the number of units; because as a matter of fact the amount that each of them does is the primary datum, and what they all do together is arrived at by addition or multiplication. If the government had any power of making each individual do more or less it could make a larger or smaller number of them capable of doing a given amount of work, but it cannot decree how much they *shall* do collectively, independently of their numbers, and then determine what each of them does by regulating those numbers.

What, then, are the supposed peculiarities of the work of the currency which have given rise to the belief that these exceptional possibilities exist in this case, though not in others? In the first place, the undoubted fact is pointed out that the amount of transference of goods or services which can be effected under the denomination of a sovereign depends solely upon the value of that sovereign. That is to say, if a quarter of wheat and a ton of hay are each worth the gold in one and a half sovereigns, they can be exchanged under the denomination of one and a half sovereigns. If, on the other hand, they are each worth the gold in a sovereign, they can be exchanged under the

The difference between the primary and the derived values of all commodities mistaken for a difference between currency and other commodities.

denomination of a sovereign. Thus the same amount of business, namely the exchanging a ton of hay for a quarter of wheat, might be conducted with the intervention of one sovereign, of one and a half sovereigns, or of two sovereigns, equally well. And therefore, if, for any reason, the stock of gold were so reduced that the gold in a sovereign should double its value, then the sovereign would be able to conduct twice as much business as it did before. The services that the currency renders to the community at large, therefore, seem to be independent of the number of sovereigns that are in the currency. And it is undoubtedly true that, within wide limits, the money function could be performed equally well, in any community, by a larger or smaller number of sovereigns. This then, we are told, constitutes a fundamental difference between the money function and the functions of other things, for a large or a small number of potatoes will not equally well perform the nutritive functions of potatoes, nor will a large or small number of men or tools be able to perform the same industrial functions equally well. The derivative nature of the exchange function of gold, therefore, seems to differentiate it from the primary functions of other commodities. But, as we have seen, this derivative value is not peculiar to the currency. To any man who is dealing in anything it is a matter of indifference, within wide limits, whether he receives a large or a small quantity of it for any given consideration, provided the small amount in one case is as valuable as the large amount in the other. If, for instance, a certain class of books is worth 5s. a volume in the second-hand trade, and a bookseller has a considerable trade in them, making on an average 10 per cent per annum on his turnover, and if presently this class of books, through a change in the taste of the public, becomes twice as valuable, and the bookseller with the same general apparatus and machinery, and with the same effort of attention and so forth, deals in half the number of books, his purposes will be just as well served, so long as he makes the same profit on his turnover. For neither his expenses nor his income depend on the value that he attaches to the books for his own use. They depend on the value that some one else attaches to them, so that this derivative function which they perform for him can be performed equally well by a

smaller number that are highly valued and by a larger number that are valued low. But to the student purchaser of books it is by no means the same thing whether he has a thousand volumes for which he has given, on an average, 5s. each, or five hundred of the same volumes for which he has given, on an average, 10s. each. The five hundred at 10s. each do not facilitate his studies or serve his other purposes any better than if he had only given 5s. each for them. And he is without half the library he would have had on the other supposition. The distinction, then, that we are at present examining is not one between currency and all other commodities, but between primary and derivative values, between the value attached to an article by the user and the value attached to it by the dealer. And in all cases, whether of primary or derivative value, the total service consists in the sum of the individual services. We can in no case get at the individual services by saying that each individual has got to perform, and therefore will perform, its due fraction of the total, fixed as a total by some external power. Surely we should expect that if the government really has the power of making the currency do certain work, it must be by giving to a definite quantity of gold the power to do a definite piece of work, not by enabling an indefinite sum of gold, whether great or small, to do a definite amount of work by its fiat that it shall do it. If, as we have seen, a little gold can under certain circumstances do as much as a great deal under other circumstances, it must be because under those circumstances each unit of gold is made capable of doing a larger amount of work; not because it is told that there is more work for it to do. This is obvious enough in an ordinary way, and the example of the books will again serve our purpose. If the primary services of the books (to the readers) have mounted on the collective scale then their derivative services (to the dealer) mount too, and each book will convert a larger amount of his energy and thought into a correspondingly larger amount of the things he desires. Just so if the primary services of gold mount, either because of a falling off in the rate of production, or because of increased applications of gold to the satisfaction of tastes and wants, or for any other reason, each unit of gold will be able to conduct a larger amount of business.

These considerations suggest that we should begin our inquiry as to the connection between the amount of gold in the currency and the value of each sovereign at the other end from that by which it is usually approached. Granted that, in a general way, the total amount of work that the currency has to do is fixed by the general business habits of the community (though, as we shall see presently, this is a large assumption), it will follow that if the marginal value of an ounce of gold, in the arts, is high, then a small amount of gold will be enough to conduct that part of each man's transactions for which he employs the currency, and he will become a "dealer in gold" only in small volume. That is to say, the withdrawal of a small volume of gold from its primary applications will suffice to conduct the business of the country because each piece of gold, having a high value, will be able to transact a large amount of business. If, on the other hand, a large output of gold during a series of years, or any cause affecting the use of gold in the arts, should bring down the marginal significance of an ounce of gold in the arts, then each man will find that as a "dealer in gold" he needs a larger volume of gold to do his business for him, and a larger volume will be held out of its primary applications. Thus it is not the amount of gold in the currency that determines how much work each piece shall do, but the amount of work that each piece can do that determines the amount in the currency.

If we now turn to paper currencies, again, we shall remodel the statement thus: It is not true that a government can confer on pieces of paper, or other intrinsically worthless articles, the collective power of doing the business of the country, but it can within certain limits confer a defined power of doing business on certain pieces of printed paper. For the government, as general guardian of contracts and of property, has the power to enforce or to decline to enforce any contracts, and as guardian of the rights of property it can determine whose property anything shall be. It is possible, then, for a Government at any time to say: "There are in this country a number of persons under legal obligation to pay fixed rents for premises, fixed interest on capital, fixed salaries for services, over such

Re-examination of the connection between the amount of gold in the currency and the value of each sovereign.

What makes paper currencies circulate?

periods as their several contracts cover. There are also a number of persons under definite obligations to pay such and such gold, at such and such dates, once for all. Now we, the Government, can, if we like, issue stamped papers bearing various face denominations of one, ten, a hundred, etc., units of gold currency, and we can decree that any one who possesses himself of such papers, to the face value of his debts, and hands them over to his creditor shall be held to have discharged his debt, and we will henceforth defend his property against his late creditor and declare that he has, in the eye of the law, paid the sum of gold which he owed." It is obvious that these pieces of paper will thereby acquire definite values to all persons who are under obligation to discharge debts or to pay salaries or rents or other sums due under contract; for to command one of these pieces of paper will be, for certain of their purposes, exactly equivalent to commanding a sovereign. As these persons constitute a large and easily accessible portion of the community, there will at first be no difficulty whatever in circulating the notes, for those who have no direct use for them themselves will know that there are plenty of people who have, and a certain number of these certificates can, in this way, be floated. Each will be able to transact business to the same extent as a piece of gold of its face value. But as the contracts gradually expire and the debts are gradually discharged, the original force that gave currency to the Government's paper will become exhausted. At first the holder of such a bond will from time to time come across men who will say: "Oh, yes, I was just looking out for paper in order to discharge my debt or pay my rent"; and if there were the smallest tendency to depreciation, competition would instantly rise amongst these persons who would be glad to get, at any reduction whatever, these things which their creditors would be compelled to receive at full value. If people chose to go on making fresh contracts and giving fresh credit, without specifying that the payment should be in gold, and thus went on perpetually bringing themselves under legal obligation to receive paper in full payment, the process might go on for a certain time, by its own impetus, but there would be nothing to compel any one to enter into such a contract; and if at any time, for any reason, there were a slight preference for making

contracts in gold, so that there was a dearth of people of whom it could be definitely asserted that for their own immediate purposes, independent of the general understanding, the paper was worth the gold, there would obviously be no firm basis for the structure, and every one would become nervous and would want to make some allowance for the risk of not finding any one who would take the paper at or near the face value.

The Government has, however, a further resource. It has the means of maintaining a perpetual recurrence of persons thus desiring money at its face value, for the Government itself has more or less defined powers of taking the possessions of its subjects for public purposes, that is to say, enforcing them to contribute thereto by paying taxes. Ultimately it requires food, clothing, shelter, and a certain amount of amusement and indulgence for its soldiers and all its officials; and it requires fire-arms, ammunition, and the like. And in proportion to its advance in civilization it may have other and humaner purposes to fulfil. Now, as long as gold has any application in the arts and sciences it exchanges at a certain rate with other commodities, just as oxen exchange at a certain rate against potatoes, pig-iron, or the privilege of listening, in a certain kind of seat, to a prima donna at a concert. The Government, then, levying taxes upon the community, may say: "I shall take from you, in proportion to your resources, as a tribute to public expenses, the value of so much gold. You may pay it to me in actual metallic gold or you may pay it to me in anything which I choose to accept in lieu of the gold. If you do not give it me I shall take it from you, in gold or any other such articles as I can find, and which would serve my purpose, to the value of the gold. But if you can give me a piece of paper, of my own issue, to the face value of the gold that I am entitled to claim of you, I will accept that in payment." Now, as these demands of the Government are recurrent, there will always be a set of persons to whom the Government paper stamped with a unit weight of gold is actually equivalent to that weight of gold itself, because it will secure immunity from requisitions to the exact extent to which the gold would secure it. This gives to the piece of paper an actual power of doing the work that gold to its face value could do, in the way of effecting exchanges; and therefore the Government will find

that the persons of whom it has made purchases, or whom it has to pay for their services, will not only be obliged to accept the paper in lieu of payments already due, and which it chooses to say that these papers discharge, but will also be willing to enter into fresh bargains with it, to supply services or to surrender things for the paper, exactly as if it were gold; as long as it is easy to find persons who, being themselves under obligation to the Government, actually find the Government promise to relinquish their claim for gold as valuable as the gold itself. The persons who pay taxes constitute a very large portion of the community and the taxes they have to pay form a very appreciable fraction of their total expenditure, and consequently a very large number of easily accessible persons actually value the paper as much as the gold up to a certain determined point, the point, to wit, of their obligations to the Government. Thus it is that a limited demand for paper, at its face value in gold, constitutes a permanent market, and furnishes a basis on which a certain amount of other transactions will be entered into. The Government, in fact, is in a position very analogous to that of an issuing bank. An issuing bank promises to pay gold to any one who presents its notes, and to a certain extent that promise performs the functions of the gold itself, and a certain volume of notes can be floated as long as the credit of the bank is good. Because bank promises to pay are found to be convenient, as a means of conducting exchanges. After this number has been floated the notes begin to be presented at the bank, and presently it has to redeem its promises as quickly as it issues them. The limit then has been reached and the operation cannot be repeated. After this people will decline to accept the promises of the bank in lieu of the money, or, which is the same thing, they will instantly present the promise and require its fulfilment. The amount of notes in circulation may be maintained, but it cannot be increased. The issuing Government does not, without qualification, say that it will pay gold to any one who presents the note, but, in accepting its own notes instead of gold, it says, in effect, that it will give gold for its own notes to any *of its own debtors*; and as long as there is a sufficient body of these debtors to vivify the circulating fluid the Government can get its promises accepted at par.



Any Government which, even for a short time, insists on paying in paper and receiving in gold, that is to say, any Government that does not honour its own issue when presented by its debtors, will find that its subjects decline to enter into voluntary contracts with it except on the gold basis; and if its paper still retains any value whatever, it will only be because of an expectation of a different state of things hereafter that gives a certain speculative value to the promise. In fact a Government which refuses to take its own money at par has no vivifying sources to rely on except the very disreputable and rapidly exhausted one of proclaiming to debtors, and persons under contract to pay periodic sums, that they need not do so if they hold a certificate of immunity from the Government. Such immunity will be purchased at a price determined, like all other market prices, by the stock available (qualified by the anticipations of the stock likely to be available presently) and the nature of the services it can render. The power, then, of Governments to make their issues do exchange work depends on their power to make a note of a certain face value do a definite amount of exchange work; and this they can effect by giving it a definite primary value to certain persons, and then keeping the issue within the corresponding limits. It does not consist in an anomalous, and, in fact, inconceivable, power of enabling an indefinite issue to perform a definite work, and arriving at the value of each individual unit by a division sum.

Indeed, this division sum is impossible in any case to make; for the proposed divisor is arrived at by multiplying the number of units in the face value of the issue by the rate at which, on an average, they circulate. Now the Government can undoubtedly regulate the amount of the issue, but it cannot regulate the average rate at which the units will circulate. Nor indeed can it rely on the dividend, namely the amount of business which the circulating medium shall perform, remaining constant. For it is a matter of convenience how much of the business of a country shall be carried on by the aid of a circulating medium and how much without it; and as a matter of fact, at periods when there is a dearth of small change in a country a great amount of retail business is conducted on account, and balances are more often settled in

kind. Thus business which would ordinarily have been carried on by the circulating medium is carried on without it, because of its rarity. In Italy, for instance, when coppers were rare the exchange value of a copper did not rise because a smaller number had to do a greater amount of work, but each unit did as much business as it could, and the rest of the business was done without them. Again, the history of paper money abounds in instances of sudden changes, within the country itself, in the value of paper money, caused by reports unfavourable to the Government's credit. The value of the currency was lowered in these cases by a doubt as to whether the Government would be permanently stable and would be in a position to honour its drafts, that is to say, whether, this day three months, the persons who have the power to take my goods for public purposes will accept a draft of the present Government in lieu of payment. It is not easy to see how, on the theory of the quantity law, such a report could affect very rapidly the magnitudes on which the value of a note is supposed to depend, viz. the quantity of business to be transacted and the amount of the currency. Nor is it easy to see why we should suppose that the frequency with which the notes pass from hand to hand is independently fixed. On the other hand, the quantity of business done by the notes, as distinct from the quantity of business done altogether, and the rapidity of the circulation of the notes may obviously be affected by sinister rumours. Two of the quantities, then, supposed to determine the value of the unit of circulation are themselves liable to be determined by it.



## BOOK III

### ANALYTICAL AND PRACTICAL

Verum animo satis haec vestigia parva sagaci  
sunt per quae possis cognoscere cetera tute.  
Namque canes ut montivagae persaepe ferai  
naribus inveniunt intactas fronde quietes,  
cum semel institerunt vestigia certa viai,  
sic alid ex alio per te tute ipse videre  
talibus in rebus poteris caecasque latebras  
insinuare omnis et verum protrahere inde.

LUCRETIVS.

But this faint spoor suffices for an alert mind ; so that thou thyself may'st come at all the rest. For just as hounds, when once they have found the true track, full often search out with their nostrils the lair of the mountain-roaming quarry, hidden though it be with foliage, even so may'st thou, in such things as these, see for thyself one thing after another, work thyself into the secret lurking-places, and thence drag out the truth.

## CHAPTER I

### SAMPLES OF ANALYSIS

**SUMMARY.**—*We may apply the principles we have been studying to the analysis of a miscellaneous set of phenomena in the social and industrial world, both by way of exercise and by way of testing the principles themselves. The subjects chosen in this chapter are gambling, the housing problem, unemployment, depression and crises, the immediate and permanent effects of attempts to relieve distress, or of changes in expenditure, the meaning of the national income and the legitimacy of inferring from it the average command of commodities and services which would accrue to each individual if wealth were more evenly distributed.*

The systematic portion of our task is completed. It remains to illustrate and test the value of the instrument of analysis which is now in our hands by applying it to concrete cases.

We may take our material almost at random. An institution such as Trade Unionism; a programme such as the scheme of "communalising the instruments of production," or the more limited proposals to nationalise or communalise the land, or to feed ill-nourished school children; or matters of discussion such as the housing problem, or the proposals of the "tariff reformers"; or phrases such as the "national income"; or the problems suggested by a concrete action, like that of subscribing to a famine fund, or by practices such as playing cards for money, or betting on the turf, may provide us with subjects for analysis. In the course of our examination of any one of these questions we shall find

abundant illustration of that interdependence of economic, social, and moral questions which has been so often insisted upon in the body of this work.

We will begin with the highly complex question of gambling, and we will take it first in the simple and undisguised form which it assumes at the gaming-table. Our treatment must necessarily be brief and inadequate, for it is not within the scope of these concluding chapters, either in this or in any other case, to give more than a bare indication of the way in which our principles may be applied.

From the individual point of view, there can be no doubt that an immense number (I should say an overwhelming majority) of those who gamble intend to win and think that they can do so. In the case of a pure game of chance, such as we are now supposing, a man who thinks that he can win must believe in such things as runs and turns of luck, the occurrence of which may be felt by a natural or acquired sense, or must be the victim of some analogous superstition; or else he must rely on some "system," all which systems reduce themselves either to a belief that in matters of pure chance what has already happened affects the probabilities of future happenings, or to a transformation (by a systematic scheme of successive stakes), of a game in which there are even chances of loss and gain into one in which a gain is made more probable than a loss, but at the expense of the loss being proportionately heavier if it comes. In this latter class of "system" the gambler's attention is absorbed by the increased probability of gain, and he does not realise that the proportional gravity of the loss leaves him in the long-run exactly where he was. So far it is obvious that we are not on economic ground at all. Superstition, and ignorance of the doctrine of chances, can only be eliminated by general intelligence or special study. Meanwhile, we can but stamp as a delusion, and set aside without further examination, the belief that any instinct or system can give a man an advantage in a game of pure chance. The man who thinks he is more likely to mend than to mar his fortunes by gaming is the victim of an illusion, and there is an end of it. But this dogmatic statement cannot now and here be justified.

We now pass to the social aspect of the question. Dropping

for a moment the question of the commission taken in the form of the favourable chances of the table, it is clear that if there is any considerable transference of money from some of the players to others our general principle of declining marginal significance shews us that the gains will, on the average, be of less significance to the winners than the losses to the losers ; so that there will be a net loss in the psychic significance of the collective wealth of the players. The money will have been transferred from the place in which it is more to the place in which it is less significant ; for since the relative wealth or poverty of the players has no influence on their gain or loss, we may put it out of consideration, and may treat the gainer and loser as though they were equally wealthy ; and in that case it is obvious that the gain, which advances from the existing margin onwards, will have less significance than the loss, which retreats from the existing margin backwards. We may illustrate this principle by passing for a moment from the gaming-table, and taking the case of a sweepstake on a horse-race. Each player makes a uniform stake, and the names of all the horses that are to run are then written on separate lots, and a sufficient number of blanks is put in to make the number of lots equal to the number of players. Each player then draws a lot, and the holder of the name of the horse that wins sweeps all the stakes. Now it is clear that if there are fifty players, each of them sacrifices his stake at the existing margin, whereas when they accumulate in the hands of the winner they advance, at a constantly declining significance, from the present margin downwards. Each stake, therefore, comes from where it is more and goes to where it is less significant.

Contrast the case of insurance against fire. There is an uncertain loss to be met. The margin of the man upon whom it falls suddenly and notably retreats. He receives sovereigns, each one of which is taken at the existing margin of the other insurers and is applied at his raised, because retreated margin ; so that the sovereigns come from where they are less and go to where they are more significant. Gambling and insurance, therefore, which have some elements in common, namely the certainty of the stake and the uncertainty of the issue, are, from the social point of view, exactly the opposite of each



other. Gambling is a machinery for carrying money from where it is more to where it is less significant, and insurance is a machinery for carrying it from where it is less to where it is more significant.

Insurance companies charge a commission, and, as they render a social service, they are creating a fund (not indeed material, but psychic) in the extra significance which wealth gains by the transference they effect, out of which fund they are paid. And now we will return to the table and reintroduce the element of the "chances of the table," which is the analogue of the commission of the insurance agent. It is not necessary to explain in detail what these "chances of the table" are. It is enough to instance the game of *rouge et noir*, in which the teetotum turns up "zero" on an average once in thirty-seven cases, and what then happens is equivalent to each player forfeiting half his stake. Thus the table has an advantage of one chance in seventy-four over the players. The owner of the table practically draws this commission for facilitating the anti-social work of making wealth less significant, just as the insurance agent draws his commission for his social service of making it more significant. And here we may return for a moment to the individual. He cannot alter the chances of the game, and at the table the chances are not even. It is as if the player paid a small fee for the privilege of staking on an even chance; and as the players collectively would win and lose equally on an equal chance, they collectively lose on a chance which is in favour of the table; so that to the psychic loss which accrues to them collectively from the transference of wealth from one to the other, there must be added the material loss of the subtraction from their collective wealth of the commission of the table. And in the long-run his portion of this loss must come home to every persistent gambler, and must more than swallow up any gains he individually may make; for it is steady and cumulative and bears a proportion to the magnitude of his transactions, whereas his gains are at best casual and have no tendency to repeat themselves. The successful gambler, then, if he persists, will pay all and more than all his gains in return for the privilege of making them, and the unsuccessful gambler in addition to his losses will pay for the privilege of incurring

them. These statements, again, can only be substantiated by the doctrine of chances, but they cannot be questioned or shaken.<sup>1</sup>

There remains a theoretical possibility of a man having, say, only one shilling in the world and no prospect of getting another for months or years. It is possible to argue that the best thing he can do with it is to stake it at some game in which the prizes are enormously high and the chance of winning them correspondingly small. Say he has one chance in thirty thousand of gaining £1000. This chance is not actuarially worth 1s. It is only worth 8d. But yet to the man in his present state it may reasonably appear that £1000 would be worth more than 30,000 times as much as a shilling. For whether he goes into the workhouse (or the Thames) to-day or to-morrow may seem to him to make hardly any appreciable difference at all, if he knows that this fate is in any case coming; and so he gets something—a small chance of £1000—for almost or quite nothing. It is a case of rising margins such as our theory fully recognises.

Doubtless in such cases an element of illusion generally enters, and when the man draws a blank he will probably be conscious of something very like a disappointed expectation; but it is conceivable that the transaction dispassionately considered might really be reasonable. Such a case, however, could only be isolated. For a man to make a practice of thus staking his shillings would imply that he had a flow of shillings to stake; and if the flow and his play continued long enough he would be sure to lose more than he gained. Other cases, in which the unschooled imagination pictures the large gain of one as more than compensating the collective small losses of the many, resolve themselves into various forms of hallucination, and are, above all, inapplicable to habitual or repeated transactions.

We have already seen<sup>2</sup> that the speculating public occupies

<sup>1</sup> The only theoretical reservation is that any individual gambler may stop short (if only because he dies) before the run has been long enough to absorb all his gains. But it is a mistake to think that there must come a moment in the career of every gambler at which, if he were wise enough to stop, he would be a winner on his whole transactions. It is probable but not certain that there may be such a moment, or such moments, early in his experience; but the longer he goes on the less likely is it that he can ever stop as a winner on the whole body of his transactions since he began.

<sup>2</sup> Page 246.

exactly the same position to the Stock Exchange which the gamblers collectively occupy to the table, and that the ruin of the one, as of the other, is probably due to the commission, not to luck. In horse-racing, the bookmaker, even if perfectly honest, is able to derive a similar commission, from the curious fact that the inner circle of the backers of the horses, whose estimates ultimately determine the "odds," collectively over-estimate the chances. This may be illustrated by an example, much too crude to correspond with actual facts, but manifesting the principle. Suppose there are four horses in a race, and the trainers and owners of each horse, and others who have a special interest in it, estimate its chance of winning at one-third. It follows that their estimate of the collective chances of the horses is  $1\frac{1}{3}$ ,—i.e. more chances than there are. It will work out thus: Each owner or backer who thinks that his horse has one chance out of three of winning will regard 2 to 1 against the horse as the proper odds; that is to say, he will promise to pay £1 if he loses on condition that he is to receive £2 if he wins. The first chance being only twice as great, in his opinion, as the second, he regards the odds as fair and the chances even. So a bookmaker betting 2 to 1 against each of the four horses will receive £1 on each of the three that loses and will pay £2 on the one that wins, leaving himself a balance of £1. The bookmaker, then, does not back horses any more than the "bank" makes stakes on the table. They leave that to the public. The difference between staking on the green table and speculating on the Stock Exchange or the turf, is simply that in the two latter cases an element of judgment may enter, though it seldom really does. The judgment of the ordinary speculator or backer of horses being on a level with the "judgment" of the gambler who dots down on his card a certain number of the turns of the teetotum until he considers the proper moment has come for him to back his luck. In so far as judgment really enters into the case of the horse-race, an individual's chance of making money may be better than his chance of losing it, but we must observe that he is only "making" money from the individual point of view. From a social point of view he is merely "taking" it from his less competent correspondent. And on the principle already examined his gain will normally be less significant than his

companion's loss. "Judgment" on the Stock Exchange in purely speculative transactions stands on the same footing. But if a property or concern of any kind is speculatively bought with a view to developing and improving it, then nobody need lose and the gains of the speculator may really be "made."

And this will serve to illustrate the transition from the speculation which is of the nature of gambling to the speculation which is not. There can be no doubt that the excitement of taking risks is not only a deeply rooted but a valuable trait in human nature. But the man who devotes his resources to acquiring special skill and training, without knowing whether he will be able to make a living by it, or to prospecting for minerals without knowing whether he will find them in payable quantities, is speculating in a very different sense from that in which the gambler speculates. The former aims at creating wealth, the latter merely at getting wealth that is already created, instead of some one else getting it. Or, to put it in another way, the former class meet uncertainties on their industrial way and deal with them as best they may; the latter go out of the industrial way just to create uncertainties. But it need hardly be pointed out that here as everywhere the line is difficult, or rather impossible, to draw. We know perfectly well that the man who buys for a rise, intending to sell again before settling day,<sup>1</sup> is practically gambling, and that the man who takes shares in a new industrial undertaking, intending to hold them and to draw his dividend, is not gambling. But the point at which fools who came to scoff remain to pray, or saints who came to pray remain to scoff,—that is to say, the point at which the man who bought to sell becomes interested in the concern on its own merits and holds for a dividend, and the point at which the man who bought to hold sells because he thinks the selling price is more than the shares are worth,—can seldom be foreseen or defined. Nor can we tell how the two motives combine even at the beginning. A man may buy partly because he thinks the thing good enough to hold, and partly because he expects a fancy on the part of the public to make it still better to sell. Probably the majority of those who

<sup>1</sup> See page 246.

buy stock at all are at least potential speculators in buying and selling.

The gambler's ultimate plea, however, has not yet been examined. Suppose he declares that he knows perfectly well that he loses, that it to say, that he pays for the game, but says that he enjoys the game and is willing to pay for it. This is the account that many people who play cards for money will give of themselves. Some, no doubt, believe in their luck, and unreasonably expect and intend to win. Some believe in their skill and judgment and deliberately intend to profit at the expense of their guests and hosts, or fellow-guests. But the majority, I suppose, will say that their gains or losses are in the long-run trifling, and that, in any case, the game is worth the price. And we may note that as in this case there is no commission, there is no certainty of loss to be taken into consideration. To judge of this plea we must consider the nature of the satisfaction, whether it is of the character of vicious or ruinous indulgence as examined and analysed in a previous chapter;<sup>1</sup> and, finally, we must consider how far it is possible to dissociate it from the incidental cruelties involved in drawing the young, the poor, and the inexperienced into risks in which loss is likely to be crushing and gain corrupting.

We will now turn to another question, without any attempt to establish a link between it and the one we have just examined; for the scheme of this chapter does not imply that any special connection between its successive sections exists.

Many people live under housing conditions which rightly shock every feeling of humanity; and the fact raises a growing sense of social compunction. How it is to be met constitutes the housing problem. But it is clear, on examination and analysis, that it is only in a very limited sense that we can speak specifically of a housing problem at all. In what sense is the question why people live in improper houses, and how we are to stop it, different from the problem why they eat improper and

The housing  
problem.

<sup>1</sup> See pages 423 *seq.*

insufficient food, or why they are inadequately clothed, or amused? The problem how to house people is obviously only a branch of the problem how to provide for them generally, both in body and mind. Certain persons are ill-provided with everything. In their own eyes they are not ill-provided with houseroom relatively to other things, for if they were they would redistribute their expenditure so as to get more houseroom and less of everything else. But you will answer they cannot afford to give up anything else. Exactly. That is to say, they are as keenly in want of more of everything else as they are of more house accommodation. Their conditions of accommodation possibly strike us as even more terrible than their conditions of feeding and clothing, but they do not strike them so. The housing problem, then, is in the first place the general problem of poverty. In the next place it is the problem of education. We think, perhaps, that people ought to value decent accommodation more highly than they do. And lastly, we think (and here it seems for a moment that we come upon a specific housing problem) that rents ought not to be so high. But why is the house rent of the poor so high? Primarily because they have to live near their work and land is of great value there because it is a highly efficient industrial instrument there. The rich man either does not live where his work lies, or lives there in a good house. If the poor man lives in foul quarters, then, it is either because he is poor or because he does not appreciate the value of better housing conditions as highly as we think he ought to do. Broadly speaking, it would seem that the only ways of dealing with the housing problem are to combat the poverty of the ill-housed, to quicken their sense of the evil of bad housing, to make good houses cheaper, or to give houses to people for less than they are worth. All these plans have been attempted. Miss Octavia Hill and her disciples have done much in educating individual slum-dwellers into desiring better conditions, but the process is too slow and laborious to satisfy the impatience of the demand for improved conditions. Attempts, whether by public authorities or private companies, to build better houses at a cheaper rate, on commercial principles, come under an important class of experiments of

which we have already spoken.<sup>1</sup> If, on the other hand, houses are provided by philanthropic companies or individuals, who are content with 3 per cent on their capital (or otherwise on less than commercially remunerative terms), a privileged class of occupants is at once created; and the difficulty may be found insuperable of securing the privilege, even as far as it goes, to the class of persons most in need of it. Possibilities of cheap and easy transport are constantly opening, and perhaps the best hope of depleting our overcrowded centres lies in a development of tram services which would relieve the competition for central business sites. Thus, the housing problem turns out to be a poverty problem, a land problem, an education problem, a problem of locomotion, and a problem of town-planning. Attempts to deal with it merely by saying that bad houses shall be destroyed and none but good ones built in their stead do not in themselves touch the difficulty. They are open to the same danger which we encounter in connection with proposals for a minimum or standard wage.<sup>2</sup> As a minimum wage may mean the multiplication of the unemployed, so minimum requirements of decency and convenience in houses may mean the multiplication of the unhoused; or if the standard only applies to new houses it may mean the crowding into existing tenements of those who cannot afford to come up to the new requirements. At best, if it stood alone, it would mean attempting to force people to pay for what we think they ought to want instead of for what they want themselves. There is no doubt a wide range for insisting on sanitary conditions which do not notably add to the expense of building, but it can hardly be doubted that in some country districts the by-laws enforced by the local authority prevent cottages being built, and therefore aggravate overcrowding.

It should hardly be necessary to add that overcrowding may be brought about by any cause that makes building land difficult to obtain; and if the owners of land object to having cottages on their estates for æsthetic, social, or sporting reasons, the result is just the same as if the competition for the land were purely industrial.

<sup>1</sup> See pages 209 *sq.*

<sup>2</sup> See pages 693 *sqq.*, and cf. page 344.

We will now turn to the connected problems of unemployment, depression, and commercial crises, which are admittedly amongst the most baffling on the whole field of applied economic science. I am <sup>Unemployment.</sup> far, indeed, from claiming that the principles laid down in this work present an obvious and convincing solution of them. But the following points may be considered. Every one knows that persons, not without some dexterity both of mind and hand, may be absolutely unemployable in a given post. Every busy man has had embarrassing offers of "help" from zealous friends who are willing to do anything,—but who can do nothing that does not require more superintendence and correction than the result is worth. In an industrial society of increasing complexity it may reasonably be expected that the conditions which enable the individual to pass from a negative to a positive efficiency will become more and more exacting. An advancing education may be supposed to meet these more exacting conditions, but, so far as it depends on the specialising of capacities, the man who has been made eminently employable in one line of activity may thereby be made all the more unemployable in another. Again, unemployment may be absolute or relative; that is to say, a man may be unable to find any employment at all because he can do nothing that is worth anything to any one else that he can find, or he may be unable to find employment at a living wage or at the wage which he demands. Now the specialising, alike of instruments and of faculties, and the minute division of labour, which are characteristic of the organisation of industry on the great international scale, are accompanied by liability to variations in the stress of demand, and such variations mean accompanying variations in the relative worth, economically considered, of this or that particular skill. Industries in which sliding scales prevail recognise this fact. When, for any reason, the product becomes worth less, there may still be employment for the same number of labourers if they are willing to recognise that their work also is worth less. The sliding scale cannot obviate disputes, for it is based on an evaluation of the significance of labour relatively to the significance of all the other factors of



production, which can hardly, in the nature of things, be above dispute; but it does at least recognise the fact that with the changing stress of demand the significance of any kind of labour changes also. If this fact could be universally recognised, one cause at least of unemployment would be removed or qualified; for it is obvious that the attempt to maintain a standard wage, or to fix a minimum wage, independently of fluctuations in the market of the product, must, so far as it succeeds, throw men out of work when the demand falls, until the marginal value of the reduced product and the marginal significance of the reduced number of workers bring about equilibrium. The larger product might have been sold at the lower price, and all the workers might have been kept in employment at the lower wage. And the supplies of the rest of the community would have been maintained at a higher level.

There is, however, no limit to the possible fluctuations of demand, and however much the principle of the sliding scale were elaborated and extended, and even if it were applied to all interests, rents, and salaries, fluctuations in demand might reduce all concerned in a given industry to a starvation wage, if not to absolute "unemployment."

Obviously, the only real issue from such a state of things will be found in the draining off of labour from the depressed industry to others. This is a process beset with inherent difficulties in the want of mobility and versatility on the part of the workers,<sup>1</sup> but the difficulties are indefinitely aggravated by the jealousy with which any invasion of other industries (all of which normally regard themselves as overstocked<sup>2</sup>) is sure to be regarded.

Note, further, that every business must be carried on to a great extent on a speculative basis. Promises of all kinds are made<sup>3</sup> in anticipation of the results of an industrial undertaking. Thus, before a great ship is launched or a great building completed, not only an immense number of promises, but an immense number of payments have been made in anticipation of the value that the completed work will have. All kinds of estimates of the marginal

<sup>1</sup> It has often been noted that old sailors are scarcely ever out of a job, because of their general resourcefulness and versatility.

<sup>2</sup> See pages 546 *sqq.*

<sup>3</sup> See pages 370 *sq.*

significance of land, tools, technical skill in directing and executing work, and every variety of factor of production, have thus been formed and acted on. These estimates are not necessarily correct. When the whole commercial community is in high spirits and feels successful, vast numbers of over-estimates of the worth of things may be indulged in. Payments out of current stock may be made on the assumption that the stock is being more than replaced *pari passu*; and while the country thinks itself growing in wealth, it may in fact be living on its means. At last the time for keeping promises and replacing expenditure comes, and the resources from which this was to be done are found not to exist. In detail this is a chronic phenomenon in all periods, whether of prosperity or of depression. Individual firms are perpetually becoming bankrupt because they find themselves unable to keep their promises; and others who have promised or performed on the strength of these promises are involved in the ruin in their turn. But if business in general is sound, these events do not shake the general confidence, however much they discourage or hamper individuals. If, on the other hand, the general estimate has been at fault and the commercial world collectively, or in a particular country, has consumed more rapidly than it is creating, and has promised what it cannot perform, a general shudder of nervous apprehension will run through it when the discovery is made. People become afraid of promising anything at all, and still more afraid of paying in advance, or of trusting other people's promises, and the whole complex system of mutual supply becomes more or less paralysed. Mechanics and others have been receiving and have consumed more than the equivalent of their marginal significance, and now that this is known they cannot get the same wages any more. Meanwhile, the people who gave them more than they get from them are impoverished or ruined. And not only do many people realise that they have spent more than they had or more than they could afford, and are actually in poverty, but the means of communication and combination by which alone we can prosper have been disorganised and the mutual confidence without which the industrial machine will not work has been shaken. A starves for want of the things that B can make; B starves for want of the things that C can

make ; and C for want of the things that A can make ; because A, B, and C can only be brought into relation with each other by a system of speculative promises which no one dares to make or which no one cares to trust. Now, as soon as a man finds that he cannot sell his goods at the accustomed price, he complains of over-production and says that the markets are glutted. Thus we have the paradoxical situation of general "over-production" and "glutted markets," accompanied by general want. That is to say, apparently, there is so much of everything that no one can get anything. But it is not really the abundance of the things produced, or the abundant power of producing them, that causes the mischief, but the timidity or forlornness of those who weave the vast and intricate maze of promises, through confidence in which alone things can be moved from those who make to those who use them.

For recurrent general depressions the only radical cure seems to be a raising of the intelligence and conscientiousness both of the directors of industry and of the public. It is possible that this may ultimately be furthered by making them state officials, but at present the socialistic Utopias are generally characterised by totally ignoring the necessity of any connection and proportion at all between promises and the means of fulfilling them.<sup>1</sup> It is said, however, that private persons are already beginning to take advantage of slack times for outlay on permanent plant and improvements ; and it seems ideally conceivable that the State should pursue a similar course, and should undertake public works, that must be executed some time, in the slack periods when they can be executed at least expense, and will, at the same time, have a tendency to counteract a serious evil.<sup>2</sup>

Note, finally, that it is easy to exaggerate the magnitude of the material difference between prosperous and depressed times. The bulk of the business of the country goes on successfully all the time. It is only over a comparatively narrow margin that inflation and contraction succeed each other.

The question may often have presented itself to reflective minds whether it would be possible, by limiting the area of commercial intercourse, to prevent the inhabitants of a given

<sup>1</sup> Cf. pages 682 sq.

<sup>2</sup> Cf. page 357.

country from being swept into the storms of the whole industrial world. Just as it is argued that a yeomanry, living largely on the direct products of its own industry, would be less liable to desolating economic disturbances than a manufacturing population, which is <sup>Tariffs and fluctuations of trade.</sup> helpless to supply its own wants if the world markets cease to demand its product, so it may be argued in the abstract that the fluctuation within a limited area will be less violent and disastrous if it is approximately self-supplying than if a considerable portion of its population are liable to bear the brunt of changes in the currents of the whole commerce of the world. But though the question whether such relative isolation and self-sufficiency are possible, and whether they might be expected to yield a balance of advantage, is perhaps arguable in the abstract, as a matter of fact no scheme of fiscal union is ever based on any such idea of shielding a suitably constituted area from the commercial storms of the world. The fact becomes obvious when we note that actual or proposed areas of fiscal union are always determined by other than commercial or economic considerations. The United States of America are often cited as furnishing a typical case of protection, but we should never lose sight of the fact that there is free trade within the United States themselves, so that it seems safe to assert that there is no other free trade area of so great an extent and embracing so wide a variety of natural and social conditions in the whole world. Moreover, it is generally supposed that the United States would welcome the accession of Canada, and in case of a union would at once throw down the fiscal barriers that now separate the two countries. If this is so, one is led to the conclusion that the tariff is not maintained on economic grounds, and that no economic loss would be anticipated from its removal. In the same way the desire to federate the British Empire fiscally is clearly determined by other considerations than those of an economically convenient and suitable area, containing a due balance of productive resources; and the desire of all advanced industrial communities to find external markets for their "surplus products" shews that they have no idea of cutting themselves off from the great world-streams of commerce and constituting themselves into self-supplying

groups of a size and character determined by the prospect of economic stability.<sup>1</sup>

It will be a good exercise to see how far we can trace the meaning of such an act as subscribing a guinea to a famine fund in India. The root fact is that there is a shortage of food, and the inevitable deduction seems to be that man or beast must somewhere go so much short.<sup>2</sup> If the otherwise starving Hindus are fed, they must eat food that some one else would eat if they were left to starve. Now, if I subscribe a guinea, it is exceedingly improbable that I save that guinea out of food. Even if I did we should have to inquire in what way the food that I should have eaten gets, directly or indirectly, to the Hindu; but if I eat just as much as I should have done, the more perplexing question remains: Who abstains from food because I subscribe a guinea? How does my subscribing make him abstain, and how does the food from which he abstains reach India directly or indirectly? Let us consider the special circumstances, which would of course vary if the famine were not in India, but in China or Sicily. To begin with, we may assume that there is no actual lack of food-stuffs in British India as a whole, even in time of the severest famine. Probably there will be plenty of food near the famine-stricken districts, easily accessible. The trouble is not that there is no food, but that the ryot has no money or general command of wealth by which to get it. Nay, it is very possible that the starving ryot has himself managed to grow rice enough for sustenance and next year's seed, but has to sell to enable him to pay taxes.<sup>3</sup> Now a certain not inconsiderable part of the taxation of India is devoted to the payment of pensions and annuities in England. This, then, is the situation. India exports rice in order (amongst other things) to pay pensions in England. Suppose, in the first instance, that English pensioners or annuitants, who would actually have consumed a guinea's worth of Indian rice, determine to subscribe a guinea to the famine fund, and to go short of the food them-

<sup>1</sup> For some remarks on unemployment and "tariff reform," see pages 666 *sqq.*

<sup>2</sup> See, however, page 649.

<sup>3</sup> See Vaughan Nash, *The Great Famine*, pages 134 *sqq.*, London, 1900.

selves. That is to say, they give up eating the rice and eat nothing else instead. The case would then be perfectly simple. The distressed ryots would either keep their own rice or buy rice from a neighbouring district, and India would export less rice by that amount. Money can in this case be eliminated from the question, and we can regard the English pensioner as simply giving the ryot a bill on himself for the price of the rice which he has never received. The ryot can then either keep his own rice and pay his taxes by his bill on the Englishman, or can buy rice from his neighbour with the bill and pay his taxes out of other resources. It would be exactly the same if you or I abstained from the rice, and subscribed the guinea. In that case the essential facts might be represented thus. I allow India to draw a bill on me for a guinea, and at the same time I abstain from eating rice. India, instead of selling rice to raise a guinea for the pensioner in England, sends him the bill upon me for that amount, and keeps and eats the rice; leaving me to pay the pension. But now, suppose that the subscribers, instead of abstaining from rice, abstain from stalls at the opera, or dishes of early asparagus or strawberries, or that they travel third class instead of first, or go without books they would otherwise have bought, or trench upon their other charities. How does this relieve the famine? The immediate answer is obvious and is the same as before. India has leave to draw a bill upon the subscriber, and, therefore, is not compelled to sell the rice. There is, therefore, so much more rice in India, and so much less in the general market, and it follows that somebody must go short. But the accounts are not "cleared" as they were in the former case, and we must pursue our inquiries further. Two apparently independent centres of disturbance have been established. On the one hand, the rice market in England is to a certain extent depleted. Our previous studies enable us to form a perfectly clear conception of what that would mean if it stood alone. What would have been the marginal demands had the supply been as great as usual would remain unsatisfied. The price of rice would rise, and certain people would either go without rice altogether, or would take less than usual. As we need not suppose that any of the phenomena we are examining affect the incomes of the

majority of these abstainers, they would presumably increase their purchases of the most obvious substitutes for rice, let us say sago, tapioca, or Indian corn. And since at present we have seen no reason to suppose that the available supply of these substitutes would be in any way increased, these markets also would feel the reaction, and there would be a tendency to a rise. And so, in widening circles, the effect of a shortage in rice would diffuse itself, and minute abstinences would be the result, until the whole effect of the shortage was exhausted in the diminished satisfactions of a great number of individuals who had unconsciously and unintentionally made minute marginal concessions to fill up the hideous void in India, where for once we watch a margin actually running back, unless arrested, to the origin itself.

So far, then, the effect of my donation to India has been to diffuse the suffering caused by the shortage of the rice crop, and this is entirely satisfactory. But, so far as we have yet gone, though the diffusion is in itself a subject of congratulation, it is a little surprising to discover that the persons amongst whom the actual loss is diffused appear to be entirely involuntary agents in the transaction.

But we have only traced the movement from one of the centres of disturbance. Let us now return to the other. If I economise in my railway travelling or in my payments at the box-office of a theatre, I do not save any expenditure except to myself. The first-class carriage in which I should have travelled is run just the same, and the performance I should have witnessed takes place; but the shareholders of the company or the proprietors of the theatre are a guinea to the bad. So far as I am concerned, the balance-sheet is made up. I have given a guinea to the ryots, and I have gone without a guinea's worth of comfort or enjoyment. But the enjoyment or comfort that I have forfeited is not transferred to some one else. It has perished, or rather it has never come into existence, but has remained a dormant opportunity. I am the loser to the full extent; but nothing whatever has yet been done towards economising rice. And again, though I bear the loss of the pleasure or comfort that has not emerged into actuality, yet the management of the theatre or the shareholders of the company have their resources

curtailed by the full extent of the guinea of my subscription, and they must bear the loss too. I, therefore, compel them practically to pay the subscription over again in some shape or another; and they again have the alternative of standing out of some open opportunity already provided for them, or of going without some material transferable thing which is there not potentially but actually. We may carry on this process as far as we like in the imagination, though it is clearly impossible to trace it in the concrete, as the pressures becomes more and more diffused. It is impossible to say how many potential enjoyments, or exchanges of service, are sterilised without in any way affecting the consumption of rice. But, ultimately, the pressure must come home somewhere to persons who economise by going without material things. We need hardly repeat the stock warning that no sharp line can here be drawn. Gathered fruits or cut flowers stand more nearly on the footing of a stall at the opera-house or a journey in a first-class railway carriage than on that of a bag of rice or corn. The opportunity they offer is open, indeed, for a longer time than the opportunity of witnessing the performance or taking the journey, but they are indefinitely more perishable than a bag of grain, and it may well be that if I do not buy them, they cannot be kept and supplied to some one else. In that case the vendors will be the losers, wholly if they cannot sell at all, partly if they are obliged to make a reduction at the close of the market. In the latter case the loss is not complete, but a product which would have satisfied a want higher on the collective scale goes to satisfy one lower on that scale. There is an objective loss, amounting to something short of the whole objective value that would have been realised; but whether there is psychic gain or loss no man can say. In any case nothing has yet been done towards bearing the ultimate privation caused by the shortage of rice except just so far as the enjoyment I have abstained from is directly or indirectly a substitute for the consumption of rice.

But the widening effects of my abstinence are reaching the same diffused markets which the widening effects of the relief of the Hindu's starvation have reached, and they are acting in opposite directions. While the retention of rice



in India is raising demands, the enforced abstentions in England are lowering them, and so theoretically we have found the meeting-place, and have seen not only that the relief of the famine in India is directly caused by my abstaining from a certain enjoyment, but also that the effects of these two primary phenomena theoretically meet and counteract each other through a vast network of minute capillary channels. It still remains true, however, that my voluntary subscription causes an undefined series of involuntary contributions on the part of those whom my contracted expenditure affects, and that these are passed on from hand to hand, repeating and multiplying themselves in diffusing circles, and all of them without effect in relieving the markets upon which extra pressure has been put, so long as they affect forms of consumption which are not effective substitutes for the consumption of rice. Further, it remains true that the ultimate abstinences are borne by involuntary, not voluntary, agents, except in so far as the original subscriber actually abstains from such food-stuffs or other commodities as are direct or indirect substitutes for the rice.

Now, note that the unforeseen and sudden nature of the demand is the real cause of the disturbance. If an enlightened administration came to the conclusion that the regular levying of taxes, together with irregular appeals to charity for their practical remission, was a wasteful method; and if the English public were to make up its mind, once for all, to give peace and justice to India on easier terms<sup>1</sup> than are now nominally exacted, and were to regularise and rationalise the methods on which these lower terms were enforced; we might then have a continuous instead of an intermittent abstinence on the part of the British public from certain satisfactions in order to relieve the pressure upon India. The energies which are now devoted to the construction of first-class carriages, the production of operas, and so forth, would be turned into other channels, and might, directly or indirectly, produce food

<sup>1</sup> The salaries of the Indian officials, pensions and all, are surely not higher than the market value of the talent and fidelity which they exercise at their posts. So far as that goes, the justice and peace given her cannot presumably be purchased on any easier terms; but England might give them to India for less than they cost, instead of charging her the full price and then giving her doles when she is ruined.

to make good the diminished tribute in rice from India. And even if no direct provision could in all cases be made, so that an ultimate shortage of food was somewhere felt, at any rate there need be none of that incidental and gratuitous waste that our analysis has traced as due to the intermittent character of the claim upon England's charity and the inability of the machinery of the economic world to adapt itself to it.

Now let us eliminate the fact that the suffering to be relieved is in one country, and the abstinence that relieves it in another. We may suppose that a disaster has occurred in our own country and that subscriptions are made to relieve it. Here the conditions are essentially the same as before. There will be two centres of disturbance, caused respectively by the destruction, say, of crops and herds, due to a flood, and by the contraction of my own expenditure, when I have by my subscription transferred a part of my purchasing power to the sufferers; and unless the things I abstain from are precisely the things which the relieved sufferers consume, my abstinence does not cover their consumption, and the same succession of incidental and, so to speak, gratuitous losses that we have already traced will accompany the process of my compelling some less well-to-do person than myself involuntarily to incur the really effective abstinence that balances my beneficiary's consumption.

Now let us take another step and eliminate the element of suffering or loss altogether, simply supposing that one person in England makes a gift to another. The difference here is that there is no primary loss to be made good. We are not supposing that there is a shortage anywhere. But, if the presentation is not one of a group of actions that has been contemplated and provided for in advance by the enterprise of the industrial world, that is to say, if it constitutes a disturbance in the regular and anticipated course of events, it may be accompanied by all the incidental disturbances that we traced in the other case. If I buy for my friend something different from what I should have bought for myself, or if I make him a present in money and what he buys with it is not the same thing that I abstained from, then two markets are affected. Prices tend to rise in the one and to fall in the other, and there is a suction in the one case and an obstruction in the other, which, if continued, would tend to draw produc-

tive resources down one set of channels to the relief of the other.<sup>1</sup> Meanwhile, there is a certain amount of waste of services and of swiftly perishable commodities, and as the relative places on the communal scale of a variety of things are directly and indirectly shifted up or down by the tightening and relaxing demands, certain people are made richer or poorer.

And now, finally, we may eliminate the hypothesis of a gift altogether, and may see exactly how any sudden change of expenditure tends to produce loss and disturbance. The provision already made for the expenditure which ceases will run more or less to waste, and the increased demand on another market will squeeze out certain marginal claimants upon it, driving them to alternative forms of expenditure. But, as the increased expenditure in the favoured market improves the position of those who command its wares, it is probable that some of them may secure, in the falling market, some of the satisfactions from which I have turned aside, and caused others to turn aside, and so far the wastage of accumulated resources and talents which my contracted expenditure has caused will be checked. Some waste, however, there will always be, as well as the disturbance of the raised and lowered values of existing goods. If the new order of things becomes established, the distribution of the factors of production adapts itself to it, and the things more in demand are produced instead of those less in demand, and there is no continuous loss.

The incidental disturbance due to any change, as such, may be ignored when there is a great and obvious purpose to be served, such as in our instance of the relief of famine. Nor need it trouble the most scrupulous conscience when it is of a casual and personal nature, for such irregularities are always taking place, and in the broad cancel each other. But capricious changes in fashion have, doubtless, a depressing effect upon the material and moral condition of the industrial populations they affect; and even where a new invention or reformed administration increases the resources and the well-being of the community, the incidental disturbance may be disastrous in its local effect, and, unless some provision be made to meet it, may be a heavy social offset against the total gain.<sup>2</sup>

In leaving this subject we may note that we have through-

<sup>1</sup> See pages 353 *sq.*

<sup>2</sup> Cf. pages 352-357.

out been assuming a "rigidity" in the industrial organisation that allows no room for "play." As a matter of fact it would require very extensive movements to complete the circles in the way we have supposed. Any small changes of pressure would probably exhaust themselves long before their effects met and counteracted each other in diffused markets, and at every point spare energies might be released and directed into compensating channels. To take a single instance; a rise in the price of any food might make it just worth while to harvest some small and distant crop in some part of the world that would otherwise not have paid for the picking or saving and transporting.

We are now in a position to enter upon the last inquiry to be undertaken in this chapter, namely, the meaning of estimating the national income at so much, and the value of the speculations as to the average income which it would secure if wealth were more evenly distributed. I may warn the reader in advance that we shall reach no particularly definite or novel results; but the inquiry will itself, I think, constitute a particularly valuable exercise.

Total and  
average  
national  
income.

What would be meant by saying, for example, that the total income of England is about seventeen hundred million a year, and that this gives an average of £40 a head, or of £200 for a family of five? The total income is arrived at by adding up the estimated incomes of individuals. Both the national and the individual incomes are expressed in terms of gold. But how are these incomes reckoned, and in what do they consist? If a man earns his living by growing vegetables and selling them in the market, he acquires a certain command of commodities and services that other people control and which they consider marginally equivalent—each to each—to the lots of vegetables they receive from him in exchange. The vegetables he produces, therefore, are the communal asset that is represented in his income. They are what he contributes. What he consumes is contributed by others. If he pays rent, then part of this asset of vegetables is represented not in his income, but in that of the landlord. But what if the man earns his living by teaching Greek, or by book-keeping, or by preaching, or by dancing, or by company-promoting? He

renders services, in return for which he receives certain things he desires. The communal asset is his services. They are what he contributes. What he enjoys is contributed by others. The communal income, then, though measured by marginal significances in gold, is constituted by the marginal significance of everything made, produced, or done, that enters into the circle of exchange. The revenue of a community for a year is all the desired things, whether material commodities or services, which come into existence that year. Hence, if my income is £500, and out of it I pay a servant the equivalent of £30 in board and lodging and wages, her income will be estimated at £30 and mine at £500. And this will not be counting her £30 twice. I have rendered services that count for £500, and she has rendered services that count for £30, and both are reckoned in the national income, just as much as the wheat grown by the farmer. Many reflections are at once provoked. Naturally, the total income of a nation tells us nothing unless we know how it is distributed. Wealth and starvation side by side may shew as large a total as evenly distributed comfort would. Again, the income of the nation consists only in exchangeable things; but we have seen<sup>1</sup> that the true revenue of satisfaction, enjoyment, or vital realisation and experience (whether of the individual or of the community), though supported by things in the circle of exchange, is neither secured nor measured by them. Probably, if any community realised this, its income would decline and its well-being would increase, for it would create less and enjoy what it created more.

Again, as all wealth is estimated by its marginal significance in gold, it would be possible for an increased supply of any commodity or service, except gold, to appear on the estimate of the national income as a loss. For, if the fall in marginal significance relative to gold should more than compensate the increased supply, the total area of enjoyment would increase while the total exchange value of the commodity declined; and a gain in the means of satisfaction would be registered as a loss of wealth. If gold increased in greater proportion than other things, prices would rise and all supplies would be registered at a higher figure and so the income of the

<sup>1</sup> Pages 152 sq.

country would rise all round, whereas only gold would really be more abundant. In all careful statistics this is allowed for, and an "Index Number" is used which measures values not in gold but in a complex unit that may be supposed to give a much nearer approach to psychic or vital stability.

Innumerable sources of error and illusion, however, remain. Since all services and commodities are impartially estimated at their market value, the tools that the burglar buys and uses are just as much a part of the year's income as those that the farmer uses. The services of two rival "travellers" who are endeavouring to capture the same market count as much in the national income as if they had been bringing conveniences and utilities within the reach of persons who would otherwise have gone without them. Mutually destructive or inherently vicious activities and services count for as much as constructive and wholesome ones. The "services" for which the wages of shame are paid constitute a part of the national revenue as much as any other;<sup>1</sup> but if Portia is Brutus's wife and not his harlot her companionship ceases to count in the national revenue. And, moreover, any changes in the tastes, habits, or morals of the community which enabled them to derive increased enjoyment from their own personal activities or their mutual intercourse would tell for nothing in the estimates of national wealth.

All this, however, and much more of the same sort, is admitted. It must not be lost sight of, but it need hardly be pressed, for it is all generally allowed, and some of it is habitually realised. Any one who says that the national income amounts to £40 a head means no more, at most, than that the resources of the country are such that there is enough for every one to have forty pounds-worth, at the rates now current, of the things and services in the circle of exchange that, wisely or foolishly, virtuously or viciously, he desires. But it is just this proposition that we must now proceed to examine, for it is by no means obviously true.

If, indeed, we could be sure that, however the wealth of the country were redistributed, the same things would be wanted in the same quantities and with the same relative intensities by the people then in a position to realise their desires as they

<sup>1</sup> Cf. pages 184 *seqq.*

are now by the present commanders of wealth, then, truly, all the activities of the country might go on just the same and the revenue might remain the same, only the things and services now made and rendered would be given to other people. Indeed, less than this would satisfy us, and would justify us in speaking of the "average income" of the country in the usual way. We have learnt to distinguish between the immediate disturbance and the ultimate effect of any change, and the former of these considerations may be ignored. It will be enough for us if the resources now devoted to the production of services and commodities desired by those who are at present in a position to command them, are capable of being so diverted as to produce commodities and services demanded in the new order of things, in such quantity and quality that, estimated at their marginal significance, they would total to the same amount as at present. Have we any right to assume that this will be so? Let us try to see.

The mere fact of a thing being desired by a number of wealthy men gives it a high marginal value objectively. It is possible to conceive, for example, that a man of very great wealth might be willing to offer a larger sum for a great area of land for purposes of sport than a number of poorer men might be willing to give for the same land for purposes of subsistence. Strange and paradoxical as it may seem, the land would in this case occupy a higher place on the scale of preferences of the man to whose pleasures it made a slight addition than on the scales of the men to whom it made the difference between a hard life of unrelieved toil and a fair degree of comfort;<sup>1</sup> because the wealthy man has so great a command of generalised resources and commodities that the whole amount which would make the vital difference between poverty and comfort to a hundred families signifies very little indeed to him, and opens to him no alternative more eligible than that of adding to his game preserves. The price of the land, therefore, is higher because of the existence of a few very rich men than it might be if there were the same general command of resources and services in the community, more evenly distributed. Thus land might stand lower on the communal scale, if wealth were more evenly distributed.

<sup>1</sup> Cf. pages 145 *sqq.*, 189 *sqq.*, etc.

One may see the same fact illustrated in the case of the fees that an eminent surgeon or counsel can command. If there are a number of exceedingly wealthy men in the community, there may be many persons to whom the difference between the services of the acknowledged possessors of the very highest skill in their respective branches, and those whom skilled opinion places just one distinguishable degree below them, might weigh in the scale as heavily as anything else that could be got for, say, £200; and if there were enough of these persons to employ the energies of some two or three surgeons, they might command fees of five hundred guineas; whereas, if there were no very wealthy men, no considerable body of persons would care to spend more than, say, £20, or £10, or 10s., as the case might be, on the mental satisfaction of thinking they had got the services of those whose public reputation was supreme, in preference to the services of others, possibly quite as good, and certainly barely distinguishable from them in excellence. If I suppose that by going to one dentist I can have one per cent greater security against present or future suffering than if I go to another, the extent of my general resources will determine the amount at which I am willing to purchase this extra security. If I am a millionaire and am unfortunate enough to require the amputation of a limb, the difference between three hundred and five hundred guineas sinks, in the presence of such a crisis, below the range of perceptible distinctions. If my whole income is not above a few hundreds, I shall be well content with the services of a man of good local reputation in whose hands I shall feel reasonably safe; and if he will perform the operation for £20 I might not be willing to give £30 (much less £500) for the services of the top man in the profession. Thus the difference between a certain exercise of A's skill and of B's may be valued at £480, or at something under £10, in the estimate of the national income, according to the degree to which the inequalities in the distribution of wealth have been carried.

It is unnecessary to multiply examples. It is sufficiently clear that if the command of the collective resources of the community were more evenly distributed, they would all be there just the same. The surgeon's skill and every other faculty would be there, available for the relief of suffering, and the



sustaining and adorning of life, but minute differences would not count for so much, relatively to staple articles, as they do now. Whereas fine distinctions of talent in music-hall "stars" and others, who render services to masses of persons at once, might possibly command greater not less differentiated remuneration. But these latter cases would be exceptional. When we think of the scheme of values in the minds of the rich and poor respectively, we must surely feel that these considerations entirely vitiate the calculations made from the total income of the nation to the ideal "average" which each might enjoy; for if we divide the national income by the population and say that the quotient is £40, what that suggests is that there is now enough to give every one the things that he individually would buy if under present circumstances, and with present prices ruling, he had £40. But this is not so. He would have a share in the national revenue of things and services, the items in which share, taken severally, can each find somebody now who attaches such a value to it that all the values added together make up £40. But to some of them no one not immensely rich could attach the high values they now bear, so that if wealth were evenly distributed they would be there, but would not be valued by any one at such a figure as to make up the average of £40.

This does not mean that there would be a material loss to set against the psychic gain of a more even distribution. It merely means that the averaging of the national income, objectively measured, gives an unreliable estimate of the actual command of the things he desires which his share of that revenue would secure to each individual.

But, it may be urged, although it is obvious that a family with an income of £200 a year would not value jewellery or game preserves, choice bindings or *editions de luxe*, thoroughbred horses or skilled professional services, at the figures they now command, yet this would merely create a disturbance for a time, if the change were sudden; and ultimately the talents and resources that are devoted to the production of these things would flow down other channels and would produce equal values in the things that are now most in demand. But can we really place any reliance upon this? The talents and resources that are now devoted to the breeding of a bull-dog worth £1000

might conceivably, if diverted, produce the year's food, clothes, shelter, amusement, and so forth, which five families of five each would demand, if each family had an income of £200 a year; and our general assumption that all free resources can be turned into various channels at approximately equivalent commercial significances seems to imply something like this; but the assumption is far from safe even as a *prima facie* probability if we are supposing the change in the direction of resources to be not a mere shifting of margins but a substitution in bulk of one set of industries for another. It does indeed seem at least possible that the kind of talent that produces prize bull-dogs might succeed in producing particularly fertile varieties of plants and animals that would be valued under the new conditions. But no one can say how these things would work out in terms of marginal value in gold; or whether, for instance, the general distribution of the population of the earth over her surface could remain substantially the same as it now is if the processes of industry were so completely revolutionised as they would be under the conditions we are supposing.

Forecasts on such subjects must be based on general considerations, and their speculative character should be recognised. An extensive redistribution of wealth would certainly change its psychic significance, but its actual effect cannot be arrived at by any such simple process as doing a division sum. And statements based on such a procedure have a delusive air of solidity and precession against which we should be on our guard. If we are confident that the world, or any particular community, is rich enough to enable every member of it to live in human comfort, our confidence must be based on our general belief in the versatility and resourcefulness of human intelligence, and our anticipation that the reaction of a more even distribution upon the energies, tastes, and morals of the community would be such as to heighten rather than to lower the effectiveness of human effort.

This confidence is not shared by every one, and, therefore, the desire for a more even distribution of wealth, which animates most social reformers, is looked upon with open suspicion or with secret misgiving by many men who would

be slow to admit that they were willing to purchase the luxury of the few at the cost of the penury of the many. They believe that all devices for relieving poverty at the expense of wealth will result in impoverishing the rich without enriching the poor in the first instance, and in still further impoverishing the poor ultimately. The only basal answer that can be given to such forecasts is that we must at least try to devise such methods as may make the experiment worth trying; but it is well, meanwhile, that we should try to face the implications of our Utopia itself, suppose we could get to it. And to this we are led by some aspects of the inquiry we have just concluded.

We have asked whether the talents that are now devoted to choice bookbinding, for instance, could under changed conditions produce improvements in the potato crop that would stand on the relative scale of the new community as high as the object of artistic beauty stood on that of the old one. Well, if they could, and if they did, there would doubtless be a psychic gain, but would there not also be a psychic loss? Few of us would dare to say that we prefer a society in which there are both slums and culture to one in which there is no want and no refined artistic taste. But, nevertheless, if the disappearance of poverty meant the disappearance of a wealthy and leisured class, and if the disappearance of such a class meant the disappearance of what we now think of as refined tastes, refined manners, and all the finer artistic enjoyments, we should feel that a heavy price had been paid. A comparison, however, of such social and economic conditions as those of Denmark with those of countries of greater wealth and greater poverty does not support the belief that the higher qualities and finer tones of the intellectual and æsthetic life need fear anything from more even distribution of wealth.

One thing, however, is very clear; namely, that there actually are some satisfactions or indulgences which in the nature of things could not become universal, even if our general command of material resources were indefinitely increased, and which must tend to disappear if wealth is more evenly distributed. And the examination of a case in point may serve to remind us of the necessity of constant

vigilance against the tacit assumption that what is possible to any one is possible to every one.

Napoleon may have wished to encourage the belief that every soldier carried in his knapsack a marshal's baton. But he must have known that, however true it might be that *any* soldier might rise to the position of a marshal, that "fool of a word" impossible was the only one to apply to the supposition that *every* soldier could do so. For the existence of one marshal implies the existence of a number of soldiers who are not marshals. In like manner it is possible in any advanced industrial community for any man to become wealthy; but it is not possible for every man to become wealthy, with the implications we now attach to the term; for, included in our conception of wealth (even in the modest degree to which every middle-class establishment aspires to its possession) is the keeping of servants. The personal ideal then, at which middle-class people aim, appears to be one which cannot in its very nature be universally realised; for, if we cannot all be marshals, neither can we all belong to the servant-keeping class. This is the most obvious and stubborn of a great number of facts indicating that most of us wish to command the services of others on terms on which we should not wish to render them ourselves.

People who for any reason have done all their own housework know how much of it there is which is not worth doing for the sake of enjoying the results. Amazing simplifications of life take place, for good or ill, when the alternative is to work the apparatus of a complicated life one's self.

Let us suppose that one family enjoys an income of £500 a year and another an income of £100. One member of the poorer family goes into service with the richer family and receives in food, wages, and accommodation, the equivalent of £30 a year. The income of the poorer family is now scheduled as £130, and the joint incomes of the two families are £630. Had the girl stopped at home and done the same things for her own family that she does for the other family the joint incomes would only be £600. *Prima facie* both families would be the losers, not only nominally but really, for the poorer family prefers £30 a year in other things to the

services of the girl, and the richer family prefers the services of the girl to £30 worth of other things. But now, suppose that the income of the poorer family rose, from independent causes, to the level of the other. The family, now in command of £500 a year, might not only prefer to keep their daughter at home rather than that she should earn the equivalent of £30 elsewhere, but might further desire to command the services of another girl at £30 a year, and might soon come to consider themselves the victims of extreme social hardship if they could not get her. But "where everybody's somebody, there no one's anybody"; and if the rendering of personal services stands no lower down upon any one's scale of preferences than it is upon yours, you must either (1) render personal services yourself, or (2) get them from other people at terms which you or your compeers would accept, or (3) go without them.

Thus we see that not only an equalised distribution of existing wealth, but changes which should raise the resources of the poorer to a level of those of the richer without any corresponding loss anywhere, would in themselves render the realisation of the usual middle-class ideal impossible.

Such reflections may cause many searchings of heart, and may bring home to us the danger of allowing a not inconsiderable gap to arise, unobserved, between our social sympathies and the goal to which our practical endeavours are directed. On the other hand, it may strengthen our sense of the true nature of independence, and may direct our thoughts to many possibilities of simplification of the apparatus of life by extension of our communal as distinct from our private opportunities, and dissociation of the idea of enjoyment from the idea of exclusive possession and command. The flower-beds in a public park may be enjoyed by hundreds of thousands, and half a dozen gardeners may give as much pleasure as hundreds could have done if each of them had worked at that which only a few could enjoy. In the National Gallery or the Louvre the poorest citizen who has the rudiments of artistic taste and culture may secure opportunities of enjoyment and education which no private collection could secure to even a handful of the community. The extent to which

this economy can be carried depends very largely upon the development of two qualities in the general mind: the capacity for dissociating the idea of enjoyment from the idea of possession, and the sense of respect and responsibility in handling or enjoying public property.

## CHAPTER II

### SOME FURTHER ANALYSES

SUMMARY.—*The subjects dealt with in this chapter are the general nature of taxation, the contention that it may be placed on the foreigner and that properly arranged import duties might relieve unemployment, the meaning of borrowing for unproductive expenditure, schemes for communalising the instruments of production generally or land in particular, and Trade Unionism.*

Taxation is the deflection of the resources of members of the taxed community from purposes which they would have selected for themselves to purposes which are selected for them by the governing power. It is justified only by the belief that the purposes to which these resources are directed are collectively more important than those from which they are deflected. To the question, "What is the test or standard of importance?" the only answer is that the power which imposes the taxes must judge of that as best it can; and according to the form of government, and the state of public opinion, or of opinion prevalent among the governing classes, this or that material or spiritual consideration will weigh lighter or heavier. It is obvious, then, that importance will be very differently weighed under different political and social conditions, but in any case the individual who differs from the government view as to the relative importance of things has to acquiesce, under penalties, in the judgment from which he dissents.

There is a fairly general consensus that taxation is justified when it secures objects which the great majority of the nation considers extremely important, and which they

believe would not be done at all, or would not be done adequately, if they were not done collectively. The maintenance of the army and navy, and of the police force, and the law courts, are usually cited as instances in point. It is generally believed that all these things are necessary to secure civilized life, and that, if their institution and maintenance had to depend on voluntary effort and combination, uncertainty as to the action of others would paralyse each man's efforts, so that nothing effective would be accomplished. These postulates are not granted by every one, and amongst those who grant them acute divisions of opinion may remain as to the extent to which provision should be carried, the amount of taxation which it justifies, and the persons from whom the taxes should be raised. As to this last point, again, it seems easy to lay down a general principle, but impossible to determine its application except by the judgment of those who apply it. The principle is that the purposes from which the resources are deflected should be as little significant or important as possible. If any one thinks that the use of great wealth is usually considerate, enlightened and large-hearted, the use of moderate wealth generally sordid, and the use of small wealth vicious, his conception of the suitable sources of national revenue will be very different from that of the man who thinks that the pence of the poor usually minister to vital needs of extreme urgency, those of the middle classes to honourable ambitions and human comforts, and those of the wealthy to idle display and dissipation. The man who declines to accept either of these generalisations may regard the problem as a highly complex one, and may not be prepared with any general receipt for the application of the accepted principle. Or he may say that he does not trouble himself about the value of the satisfactions of this class or that; but he sees that some people get a great deal of what they want, such as it is, and others only a very little, and he would like to give them more even shares. This is merely the application of the general principle that the psychic significance of wealth declines as wealth increases. It is not scientifically capable of proof, but it derives strong support from the common sense.<sup>1</sup>

<sup>1</sup> Pages 148 *sqq.*



But it may, in any case, be safely asserted that to the extent to which democratic sentiment, or an effectively democratic constitution, dominates the action of a community, the more even distribution of wealth will be thought of as a thing to be desired; and there will, therefore, be a tendency to throw taxation upon wealth, qualified by the fear of checking the productive energies of the community; and a tendency to relieve the relatively poor from taxation, checked only by the feeling that all who have a share in controlling the public expenditure should have something directly to lose by its unwise application.

But when questions of taxation and public expenditure are discussed, we often hear it said: "All taxation falls ultimately on the wage-earners, for, if a wealthy man is heavily taxed, he cannot himself spend the portion of his income which is taken by the Government, and since his income is all of it ultimately expended in wages, he will have the less to pay in wages, and will, therefore, dismiss some of his servants and workmen, who will compete with others for employment, and so reduce the average wage." We will not stay to examine the contention that the wealthy man's expenditure, all of it, ultimately goes in wages; and we will admit that, in so far as it constitutes a disturbance of economic relations, the imposition of a fresh tax is liable to produce distress and inconvenience. But, as a general principle, it is just as true, or just as false, of what the Government takes, as it is of what the individual keeps, that it is ultimately expended on wages. If the rich man pays wages to grooms, gardeners, and footmen, the Government pays wages to soldiers, sailors, and schoolmasters; and, barring the strain of change, the question is whether the marginal significance of the work done by the gardeners, grooms, and footmen is higher or lower than that of the work done by the soldiers, sailors, and schoolmasters. This may be a very serious question, but we must not allow it to be complicated by the idea that it has any connection with the problem of unemployment, except in its temporary effects if the change is sudden. And, as far as that goes, a sudden remission of taxation would have just the same effect as a sudden imposition of it. It would throw one set of men out of work and would create a demand for another set.

The introduction of the schoolmaster into the last illustration reminds us that there are many things beside national defence (as it is uniformly called among civilians, though if no armies and navies exist except for purposes of defence, it is difficult to see against whom any one is to be defended), and the maintenance of internal order and justice, to which the effective will of the community has determined that every man shall contribute, whether he himself thinks it sufficiently important to justify his contribution or not. When compulsory education was introduced into England, it was felt that no parent should be allowed to judge for himself whether he would or would not devote a certain amount of his resources to the education of his child. It was felt to be a question of national importance that the child should be educated, and, therefore, every parent must be compelled to educate his children, with such public and private assistance as had already been provided. Presently it was felt that the contribution of the citizen towards the education of the children of the State should be entirely independent of the question whether he was or was not himself a parent and was having his child educated.

On what grounds may we suppose that the individual citizen came to consider the education of every child his concern? It may be that he felt he would be relieved from some personal risk or detriment by the general enforcement of education. If it were merely argued that a community is safer and more comfortable to live in if its children are schooled, the appeal would be to each citizen's personal interest. But, if the argument were that a child who has been schooled is more likely to live a worthy and satisfactory life himself, then the person who decrees taxes for educational purposes is actuated by a desire for the well-being of the children, and that well-being becomes one of his own direct interests and purposes. If the argument were that "England" will be in a better position, commercially, morally, or intellectually, thirty years hence, and if the person who advocates the imposition of the tax is already sixty or seventy years old, his motive will be of a highly abstract and ideal nature. He desires well to a community linked by a certain historical, local, and racial continuity to the one in which he lives (and

perhaps depreciates and denounces) after he is dead, and is willing to forego present satisfactions of a more personal character in order to help towards this desired end. This is rightly praised as patriotism. Or he may etherealise his purposes still further, and may wish well to future "humanity." This may perhaps be considered "emasculated cosmopolitanism"; but if his interest extends to the uncertain boundaries and nationalities of the "Empire" a generation hence, and no further, he may escape that reproach.

These are merely illustrations of the different principles on which different men may estimate the relative importance of purposes and objects, and they will help to explain why a large section of the nation is chronically and normally more or less indignant at the kind of things on which "their money" is being spent. Owing to the tax-gatherer the unwilling and unconvinced leave undone sundry things which they want to do, in order to secure ends which are considered more important by others, but not by themselves.

Before leaving the subject of national taxation, we may examine very briefly two claims that are put forward in favour of taxing foreign imports that compete with home products. It is urged that by such taxation we might either lay the burden of taxation upon the foreigner or relieve unemployment. In so far as we did the one, it will be admitted by the more clear-sighted advocates, we cannot do the other, for, in so far as the foreigner pays the tax he will import his goods, and import them at present prices, and, therefore, the market will be unaffected and the home-producer will neither employ more labour nor reap any other special advantage. But, so far as the one object is not accomplished, it may be urged, the other will be, and both are desirable.

Both schemes illustrate our general principle that the object of taxation is to direct resources from less to more important purposes. In the abstract the pure-blooded cosmopolitan thinker might boggle at the proposition that the purposes of the foreigner, as such, are less important than our own; but he would have to admit that, as we are at present constituted, they are more important to us; and if he genuinely believed that we are already paying the foreigner's

taxes, his last scruple would vanish, and he would earnestly desire to make him pay ours. But can he? A lengthened discussion would be out of place, but a few general principles may be formulated.

We have seen<sup>1</sup> that although the expenses incurred in producing goods, and in bringing them to the market, do not determine their exchange value when there, yet their exchange value when there does determine how much expense will be deliberately encountered in order to get them there. If the expenses are raised, therefore, goods that would have been produced will be produced no more. If this holds, then, an import tax that did not produce, or was not accompanied by, a rise in prices would tend to close the market against the foreigner who now supplies it. He would not pay the tax, for he would cease to import. If, on the other hand, the price rose by the amount of the tax, he would go on importing, but would recover the tax in the higher price received.

But is it not possible that he has no other market, and that his resources are committed to this particular product? Certainly he may have no other market that will take the whole of what he sells to us at approximately the same price which we pay for it, and so far we have him at our mercy, much as a sufficiently powerful Trade Union might have in their power the employers whose resources were already committed to one particular trade. But, unless it can be shewn that certain resources in the foreign country are permanently and inherently incapable of producing, except at a considerably lowered efficiency, any other commodity than that for which we permanently constitute the only market, this exaction of the tax from the foreigner cannot be maintained. In any case it would contract, if it did not entirely stop, his importations, and this would tend to raise prices.

If a preferential system is advocated, this may be the deliberate intention. If we wish to get our wheat, for instance, from our own colonists rather than from the United States, Russia, Hungary, or the Plate River, and think this object worth paying for, it seems to be theoretically possible to exclude some of the foreign wheat by an import tax and

<sup>1</sup> Pages 373 *sqq.*

by the consequent rise in prices to encourage not only home, but colonial wheat-growing. If the price were not raised, no result would follow, for our home-farmers and colonists already produce as much wheat as they care to do at present prices. If we contemplate damping the foreign imports and encouraging the home and colonial cultivation through a series of years during which the price of wheat will be artificially maintained at a high enough figure for our purpose, there seems to be no theoretical principle on which we can determine the extent to which the courses of the world's industry might be modified with a corresponding redistribution of its population; but we should have carefully to inquire who pays the cost, what are the risks, what is the significance of the incidental waste of disturbance, and what is the value of the contemplated results. When we duly consider these matters we shall fully understand the phrase in which the late Duke of Devonshire declined to "gamble" in the people's bread.

But by far the most attractive of the pleas urged in favour of such taxation as we are now considering is that it will Tariffs and un-relieve unemployment. This plea we must examine employment. at some length. The attempt to induce any one, by a system of taxation, to buy at home what he would otherwise buy abroad is palpably an attempt to make him "employ" one set of persons instead of another, to his own economic detriment. But we may urge that such action, though to his own economic detriment, will be to the advantage of those he "employs." And in answer to the objection that it is just as much to the disadvantage of those whom he ceases to employ, we may say that as we are not interested in these last we do not mind that.

Two points must be made clear before we proceed to a further analysis. In the first place, we have seen<sup>1</sup> that there is, properly speaking, no economic theory of foreign trade as distinct from home trade. We may therefore consider putting pressure on an Englishman to deal with an Englishman or a Canadian rather than with a citizen of the United States, or putting pressure on a London publisher to get his printing done in London rather than in Glasgow or Hull, or on a

<sup>1</sup> Pages 589 sq.

villager to get his table and chairs made by the village carpenter instead of buying them in the neighbouring town, as all raising the same theoretical points for consideration. Thus the matter under investigation is the policy of directing a man's bargaining along lines which he would not choose for himself in order to benefit certain people in whom we are specially interested at the expense of others in whom we are interested less or not at all. The area and the grounds of our interest may be important in many ways, but they do not affect the economic theory. Whether we take the Empire, or the United Kingdom, or the country, or our own district, city, village, estate, or family as the area of intenser interest, the problem is the same. And in the second place, the policy of pushing others, to their economic detriment, into transactions they would not have chosen for themselves, because we desire certain results to accrue, and the desirability of our voluntarily entering upon similar transactions ourselves, at a certain sacrifice, for the sake of those same results, may be discussed together; for their investigation demands the same analysis. In other words, the question of whether it is patriotic to buy at home what it would suit me better to buy abroad, and the question whether it is patriotic to make other people do the same must ultimately depend upon a common principle for their answers.

Let us return for a moment to first principles. The villagers who once did their own spinning and weaving, forging and furniture-making find that they can provide themselves with the products of all these industries more satisfactorily to themselves by not working at them at all, but by sending, say, milk and fruit to the towns, and receiving tools, clothes, and furniture from them. The villagers can get better clothed by keeping cows than by spinning and weaving, and the townsfolk can get better fed by weaving cloth where they are than by going elsewhere and cultivating the soil. The distribution of the population between country and town is determined by the equation of marginal significance between food on the one hand and raiment on the other.

We have insisted<sup>1</sup> that this highly organised industry has very heavy drawbacks, but also that it is an essential

<sup>1</sup> Pages 183 *sqq.*

condition of that materially advancing civilisation which we cannot escape, even if we would. And we have also seen that in spite of the increased general wealth which results from the new order of things, the currents of industry cannot be swiftly changed without loss and possible hardship to individuals. Certain village artisans or tradesmen are hard pressed by the competition of the towns, that is to say, by the existence of persons who, working at an advantage, can do more for the same return than they themselves have been accustomed to do. Theoretically, they should either turn to agriculture where they are, or go where they can work at a better advantage in their present trade; and whichever course tends to establish the equation of marginal significances is the better one. Anything that obstructs or retards this change is, so far, bad. Anything that softens the hardship of the transition is, so far, good. Sound thought and sound policy must distinguish between these two things with the utmost care; and the basal fact that now concerns us is that the new equilibrium towards which we are moving is economically more advantageous to all concerned than the old; and the policy of buying at home, at a disadvantage, instead of abroad tends to retard or to disturb this superior equilibrium. If a patriotic villager determines, at a loss to himself, to patronise the village artisan, he thereby holds him back, or brings him back from whichever of the courses, indicated above, the situation demands; and at the same time by withdrawing or withholding his custom from the artisan in the neighbouring town, and ceasing to send him food, he drives him to get his food in some other way, which by hypothesis is less advantageous. Thus, at a loss to himself, he has kept one man, for whom he cares, in a position of relative inefficiency, and has forced another man, for whom he does not care, into a position of relative want. There is a collective loss to the two communities jointly and severally. It is sometimes said that the doctrinaire free-trader's golden rule is, "buy in the cheapest and sell in the dearest market, and so fulfil the law of Christ." So far as he neglects, in thought or in policy, the hardships of the transition, and so far as he takes a purely material view of well-being, the taunt is justified. But, nevertheless, it is the most substantial

of facts that the constant desire to further our own purposes, whatever they are, of which "buying in the cheapest and selling in the dearest market" is one aspect, is in truth the great underlying force that perpetually draws us into relations of mutual service. Largely understood, "buying in the cheapest and selling in the dearest market" is the best rule that the plain man can find for directing his own energies and those of others along the most efficient lines—efficiency, be it always remembered, being measured by reference to the things, good or bad, that men want done; and each "man" counting for more or less according to the extent of his command of the things in the circle of exchange.

But it may be urged that by neglecting what we have dismissed as "the incidental hardships of the transition," we have really falsified the problem. It is not a question, it may be said, of keeping a man in a relatively inefficient employment or pressing him into a relatively efficient one. It is a question of employment or unemployment for him. Now, so far as this state of things, wherever it really exists, is due to changes and fluctuations of trade, we have recognised it as a problem of urgent importance, but have seen that no tariff proposals touch it.<sup>1</sup> And so far as it is not a question of changes and fluctuations, it can be due to nothing but a relative inefficiency, which we are to regard as permanent. That is to say, one part of the community is asked (or is to be compelled) permanently to abstain from fulfilling certain of its own purposes for the sake of persons who, relatively speaking, are permanently inefficient. This may be, and in some cases obviously is, extremely right and proper, but the admission that a considerable portion of our own able-bodied industrial population comes permanently under this category of the relatively inefficient would be humiliating indeed, and no treatment could be regarded as anything but a palliative unless it aimed at removing, rather than providing for, such inefficiency. This consideration is quite fundamental. The disputants in current "tariff-reform" controversies will generally be found to be working on different underlying suppositions. The free-trader assumes that in considering permanent conditions the man who is employed

<sup>1</sup> See pages 640 *sqq.* and *cf.* pages 356 *sq.* etc.



in one industry must be regarded as withholding himself from another industry. His opponent assumes that the man his schemes are going to employ is now, and but for him will remain, out of employment. But the existence of a body of men permanently out of employment because all who have anything to give find it suits them better to deal with other people means the existence of a permanent body of the relatively inefficient.

But suppose we let this pass and grant that the object is desirable, we have still to ask whether the proposed means would be calculated to attain it. Our examination of this question will lead incidentally to the unmasking of a certain ambiguity in the phrase "inefficiency" so freely used in the argument just closed, and will also open some very wide questions of inter-racial policy.

The terms "finding work" and "giving employment" are unfortunate, for they readily ally themselves with the "lump-of-labour" habit of mind; and, therefore, though we can hardly avoid using them, we must always be on our guard against their misleading suggestions. Let us consider exactly what they mean. The Europeans have "found employment" in abundance for the unhappy natives of Congo-land, but not in the sense that the phrase connotes in Political Economy. Giving employment to a man means enabling him to provide more ample satisfaction for his wants and desires by the indirect means of serving some one else than by the direct means of serving himself. Normally, this is a mutual or two-sided relation. The industrial inhabitants of town and country "employ" each other in this sense, and the whole principle of the division of labour involves the mutual "giving of work." But it is not always easy to keep this in mind as the normal relation; and that for many reasons. In the first place the mutuality is generally indirect. The man to whom I give work is not usually the same as the man who gives me work. In the second place, our habitual use of the terms *employer* and *employed* disguises the fact that the hands really "employ" the manager or the capitalist (in the sense of enabling him to do better for himself by doing well for them) just as much as the manager or capitalist employs them. The term "employment" then conceals rather than

reveals the intimate nature of the mutual relations in connection with which it is often used. But, in the third place, mutuality of employment is really subject to certain limitations. We think of the consumer as the employer and the producer as the employed, and although in a general way we know that consumption implies production and production consumption, and that the normal member of an industrial community is both producer and consumer, yet there are many and important cases in which the consumer is not a producer at all; so that we think of him exclusively as employing and not at all as being employed. To such a case we must now turn our attention.

We will go back to our village and will suppose that a wealthy man lives in it whose income is drawn entirely from outside its area, so that for village purposes he is a consumer and employer and nothing else. Now, it is clear that so long as he stays in the village and consumes his wealth there, it must come into the village in some shape or other without anything going out to balance it. Does it make any difference to "employment" in the village in what form this revenue comes in? Clearly it does. The rich man may have many of the things he wants made in London or anywhere else and sent down to him complete; or he may (in the last analysis) have food, beer, clothes, tobacco, and so forth, together with the raw material of the things he wants, sent into the village, and in that case the villagers may eat, wear, drink, smoke, and chew, while they are constructing the article. In the end the patron will get things that he wants, but in one case he will have "employed" outsiders and in the other case villagers. That is to say, villagers in one case and outsiders in the other will have been eating and drinking some of his revenue while making the rest of it available for his purposes. In deciding between the several courses the rich man may be guided by no considerations but those of efficiency. He may simply ask himself what suits him best. But it is also possible that he may employ relatively inefficient workers for the sake of benefiting them rather than "outsiders." If so, he is doing a kindly thing, which, if he has not good judgment, may tend to perpetuate an economically undesirable situation, but which, if he has good judgment, may simply alleviate the

hardship of a transition. In any case, he makes a voluntary sacrifice himself and imposes an involuntary sacrifice on the more efficient persons from whom he withdraws or withholds his patronage.

But now, suppose the villagers themselves can determine what the rich man in their midst is to do. Suppose they can keep all others than themselves from entering their area, and can dictate to the consumer that he shall draw his revenue in such forms as to make him dependent upon them for transforming it into the things that will minister to the satisfaction of his desires. They can then make their terms with him as to the share of his revenue which they are to receive in reward for making the rest of it available for his purposes. If they can force him to bring it in in forms, some of which will directly suit their purposes and the rest of which will only indirectly suit his, they can take the part that suits them in return for bringing the part that potentially suits him into the form that will actually suit him. The outsiders would do the same service to the "employer" if he were allowed to employ them, and they would do it on better terms for him; but the villagers may say, "That is your gauge of efficiency, but it is not ours. We ask no more than is right, and we give as much as is due. If other people want to give more and take less we won't have it. We will keep them out and keep you in, and we will have our share of the wealth that comes to our village."

That is a perfectly intelligible position; and it violates no principle of Political Economy. Given the object the means are well suited to its accomplishment, and circumstances are conceivable under which it might be successful. We have had to assume that the villagers can not only regulate imports but can also prevent immigration. Otherwise the patron might be able to import a population which would be, from his point of view, more efficient than the villagers. Thus, if a tariff system could be contrived which would compel all Englishmen who draw income from foreign sources to introduce their revenue in forms, some of which would directly serve the purposes of the working population and the rest of which would only indirectly serve their own, the "amount of work" or "employment" in England might thereby be increased, but

since it might be impracticable to prevent the movements of the European populations from one country to another the increase of employment might be rather to England than to Englishmen. England would tend to become a residential country, and persons of all nations who could make themselves useful to the rich residents would come to England, where their patrons might employ them, from other countries in which they might not.

If there is a class of inhabitants who, though not drawing their revenues from outside our selected area, are yet consumers only and not producers (such as landlords or owners of minerals), the situation is to some extent the same, but any "inefficiency" of the workers may in this case react to some extent upon the revenue to be shared. Still a policy might well be advocated either of hampering the "pensioners" in purchasing manufactured goods from outside, or of preventing immigration, or both. The hostility to Chinese labour (apart from any objection to special conditions) that is so marked in our Colonies and elsewhere is due to a feeling that certain classes or individuals are in actual command of the sources of the communal revenue, and that the labour they may consider most "efficient," from their point of view, would cut out the landless White Man from his opportunity. The idea is very probably mistaken. The voluntary presence in a country of an industrious and frugal population, willing to give much in return for little, is probably an economic advantage to all classes of the inhabitants. But the opposite belief is far from unnatural.

Now, let us take stock of our conclusions. It seems to be ideally possible to conceive of a system of tariff regulations which should favour the producer at the expense of the consumer. If immigration can be stopped, the producer who would not have been employed at all without the protection of the tariff may now get a living, and the producer who would have been employed may now be employed on more favourable terms; and all this at the expense of the consumer. If immigration cannot be stopped, there will be a movement of population, especially of the kind that ministers to a wealthy residential community, towards the area on which the "consumer" is allowed to employ people; and this would tend to

undermine the privileged position of the producer and to throw the inefficient out of work again. In any case, the consumer who is not a producer might be forced to give "more employment," and that at a higher scale of remuneration, whether to natives or immigrants, within the area which controlled him.

But this whole system aims at benefiting the producer at the expense of the consumer, by prohibiting the import of things directly useful to the consumer and allowing the import of things directly and indirectly useful to the producer; and it is, therefore, entirely inapplicable to an industrial community in so far as the consumer and producer are identical, and in so far as men mutually "employ" each other at home, and also enter into the mutual relation of employer and employed with the foreigner. We may hope that a manufactured article may be excluded in the interests of the producer at the expense of the consumer if the consumer and the producer are two different people and if the consumer's revenues are independent of the terms on which he employs the producer. But if A consumes B's product and B consumes A's, and if each would be hampered in his production by being forced to make worse terms at home instead of better ones abroad, then we can hardly hope to make every one succeed better by allowing him to prevent his neighbour from taking the natural steps to success. The contrast between consumer and producer falls to the ground; for the things that one producer desires to exclude because they are his manufactured article may be those that another desires to import because they are his raw material, or because, as consumer, he wants them for himself and can get them best abroad. Oilcake is the manufactured product of the maker but the raw material of the stock farmer. Tools are the product of one manufacture and the instruments of another; and as long as we talk of "capturing neutral markets," and "finding markets for our surplus products," we cannot contemplate crippling one manufacture to help another. But enough of technicalities.

The central truth is this. If we can separate out persons who are consumers only from consumers who are producers also, we can imagine the interests of the former being neglected without prejudice to the latter. But, if we are considering those who are both producers and consumers, our ultimate

consideration must always be for them as consumers. They produce only in order to consume. If you injure them as consumers, you stultify them as producers. Sectionally, you may benefit one man as consumer by giving him an advantage as producer at the expense of others. Collectively, you cannot. And to speak collectively of benefiting the producer at the expense of the consumer would be to speak of strengthening the means by balking the ends. Proposals to tax food, for other than purposes of revenue, are the *reductio ad absurdum* to which this confusion leads. To stay hunger is the first and deepest object of work or production. And if you impede the importation of food because it is an industrial product and should, therefore, be protected, you are "protecting" work against the accomplishment of its primeval and basal purpose.

We will now pass from national to local taxation. There is no distinction in principle between the action of the state and the action of the municipality or other administrative area; and the Poor Law furnishes, as Municipal enterprise and socialism. a matter of fact, one of the chief examples of purposes recognised by the community as sufficiently important to justify compulsion in securing co-operation from the unwilling. Drainage, the maintenance of public roads, the establishment or maintenance of public parks and gardens, or of public libraries, offer further illustrations. But the library and the park stand on a different footing from the rest. It is very difficult, even ideally, to conceive of any test by which we could draw up a balance-sheet between the money cost of the army, for example, and the collective estimates of the marginal significance of a company of soldiers, or of a Destroyer, formed by the individuals composing the community. But in the case of the park or the library it is a comparatively easy matter. If a charge were made on entering the park or taking books out of the library, could it be so arranged as to make it cover the public expenditure? If not, then apparently the members of the community taken head by head would have preferred other applications of the communal resources. Each one has estimated the significance to himself of the privilege of taking out books and entering the park, and the sum of them, measured in the objective standard, does

not amount to the value of the resources expended upon them. If the community is justified in the expenditure, therefore, it must be because it is convinced that the purposes balked by the levying of the tax, or its diversion to this purpose, though objectively of greater volume than the purposes accomplished by its application, are yet of less vital significance.<sup>1</sup> Such action is, no doubt, ethically and socially justifiable in principle, but its concrete justification can only rest on fallible estimates which cannot be objectively checked. Here, as elsewhere, the rule seems to hold that the higher and more ideal your purpose, the greater your difficulty in gaining any assurance that you have accomplished it. This is probably at the back of people's minds when they say that you must not judge municipal enterprises simply by the commercial test of whether they pay. This is perfectly true; but it is equally obvious that if we come to think that it does not matter whether they pay (or would pay if put to the commercial test) or not, we may open the door to recklessly wasteful and whimsical experiments. That an experiment does not pay is at least *prima facie* evidence that some other application of the resources expended upon it would have stood objectively higher on the collective scale. This may not be enough to condemn it, but it tells against it as far as it goes, and the burden of the proof lies on those who defend the expenditure.

In this connection we may touch on the question of the principle that should regulate the scale of wages, or, generally, of remuneration for services, paid by the government or the community. If it is more than the market rate, the public body is establishing a privileged set of persons; and by "privileged" we need not mean privileged as against the average citizen, but privileged as against other persons with whom they would be on a level but for their having been selected by the public body. The two-fold question will arise: On what principle are they selected? and, At whose expense are they privileged? Neither of these is an easy question to answer, and both are highly important. It may well be, however, that a higher than the current wage will really be economically justified. By paying better the public body may get better men and better work, even if that was

<sup>1</sup> Cf. pages 146 *sqq.*, 189 *sqq.*, 215 *sq.*

not the inspiring motive. This would be a case of using the public funds for an experiment of a kind already examined.<sup>1</sup>

\* We have now opened the way to the consideration of the far-reaching question of the extent to which it is desirable to push the municipal or other communal management of enterprises that stand on a commercial basis. The most natural industries for public bodies to enter upon are those which it is in any case deemed necessary or advisable to make monopolies, whether absolute or qualified. Railroads, tramways, letter-carrying, the liquor trade, gas and water supply, and many others, will occur at once to the mind; and every one of them offers a number of problems and suggests a number of considerations which can be debated from many points of view. The ultimate object may be to restrict trade; it may be to extend and encourage it; it may be simply to effect economies. But in all these cases the services ultimately rendered may be paid for by the individuals who desire them, and the objective test at once exists which we sought in vain in some previous cases, and which we can only apply ideally in others. Here, if the governing body submits to the financial test, it is aiming lower than in some of the previous cases, but it can be more certain that it is accomplishing its humbler aim. Sometimes, as in the case of the liquor traffic, for example, to adopt the financial test would be absolutely to renounce the purpose for which the communal action is taken; but in the case of trams or railways financial success would be a proof that the marginal estimates of the significance of the privilege secured, formed by certain members of the community, raised it to a place on the collective scale that economically justified the expenditure of the resources that had been devoted to it. But, if the money is to be not only spent but raised on economic principles, it must be raised on loan and not by taxation; for only so can we know that all concerned have got what they consider a good bargain. Now, a public body is at a great advantage in raising money on loan, but it is an advantage the basis of which it is instructive to examine. The credit of a municipality, and still more the credit of the nation, is good because no one is afraid of its becoming bankrupt; that is to say, it is not the persons

<sup>1</sup> Pages 209 sq.



who lend the money but the persons who do not that will have to bear the loss if the undertaking fails. The risk, far from being eliminated, is in the opinion of some greater (though in the opinion of others it may be less) than that of a well-guaranteed private company. The municipality, however, enters upon the competition with this advantage, an advantage which is denounced as unfair when looked at from one point of view, and should be regarded as gained at the risk of the community when regarded from another. The effective conduct of the business will, doubtless, be placed in the hands of a skilled manager, but the work of the directors and promoters will, to a certain extent, be done by volunteers, who either have a direct interest in the well-being of the community, or value the credit that attaches to public service, or enjoy managing affairs and directing enterprises, especially, perhaps, when detached from the personal risks of private business. Thus, there are sources of economy in the conducting of business by public bodies,—the easy terms on which they can raise capital, and the amount of business talent which they can secure without payment. What does this latter consideration amount to? The question being one of fact must depend for its solution upon experience rather than argument. How far is there really a store of competent business capacity which can be put into harness by motives other than economic? Not only the contractor but the general designer and conceiver of all kinds of work, as well as the mechanic who carries out the physical portion of it, are as a rule supposed to be actuated mainly by the desire to accomplish their own purposes and to put themselves in command of general resources and services to be turned in the direction they desire. How far can you give men a primary interest in the well-being of the community so that they will be willing to exercise vigilance, to give thought, to lay down far-seeing and far-reaching combinations, not in order to put themselves in command of resources to be devoted to other objects, but with the primary object of serving the community? In a word, can a succession of competent men be found to do public work for the sake of the public? And if the idea once becomes well established, will the public spirit that secures the services of such men be subject to a law of

acceleration? Any amount of a *priori* argument may be brought to bear as to the fitness or unfitness of municipalities to undertake this or that class of work, but it can only be decided by experiment how far the persons who are fit for this kind of work can be found willing to do it as a primary object, and whether such machinery can be constructed as will give scope to the continuous and systematic exercise of their ability and goodwill. It is possible, of course, that the work thus got for nothing might be of inferior quality to the work done at high salaries, but the difference might not be worth the salary. In all these matters "collectivism" or what is (perhaps too hastily<sup>1</sup>) called "Municipal Socialism" is not so much an economic theory as a social faith.

People who think that their economic advantage is seriously threatened by the willingness of other persons to do for nothing the work for which they wish to be paid will never be more amiably disposed towards their public-spirited rivals than Shylock was to Antonio, but, apart from trade jealousies, there is abundant room for difference of opinion as to the extent to which it is prudent to push our experiments. Experiments, however, there must be, and they will be the less costly and the more conclusive in proportion as they are watched by honest and competent observers who have no interest but that of the public at heart.

But if ever it is claimed in the name of collectivism or socialism that the *exclusive* ownership of the instruments of production shall pertain to public bodies, we come to questions in the answer to which economic doctrine must hold a much more prominent place. There is nothing at present to prevent the State from acquiring instruments of production to any extent; but a proposal to prohibit private citizens from holding them would seem to rest on a radical misconception of the social function of the instruments of production themselves. If our general analysis of industrial phenomena is correct, then the man who makes a tool has so far benefited the industrial community from the industrial point of view, and he can only get any good out of his tool by making a bargain with his neighbour, to that neighbour's advantage. His

<sup>1</sup> For if the Municipality borrows capital from individual lenders and pays for work and material at market rates, we are far from any accepted definition of socialism.

neighbour, then, is the better for his having constructed the tool. If the public body can increase the advantage, that is to say, if, from public spirit or otherwise, it can offer better terms than private individuals are urged by the economic forces to offer, that is so much to the good; but to prohibit the private citizen from offering terms which his neighbour will find more eligible than those offered by the State, is to prohibit him from conferring a public benefit. Probably, this would be admitted by most socialists, although many of them appear to be haunted by an idea that capital in private hands is actively oppressive and is necessarily evil, whereas in the hands of a public body it would be helpful and necessarily good. That capital in private hands may be, and often is, used for purposes injurious to some sections of the community is an indubitable fact, but the idea that the capital employed in an industry is an instrument of oppression *to the workers in that industry* appears to be the offspring of mere confusion of thought. The fact of a rich man employing "those who create his wealth" at a starvation wage naturally suggests that it is the existence of the capital that makes them starve, whereas in principle it is the existence of the capital that prevents them from starving. The capital, that is to say the tools and apparatus, is worth more to them than they pay for it, and is so far a benefit to them; but every humane person will wish that they should get greater benefits at a less cost, and if the State can back them with capital on easier terms, or if any agency can transfer them to other occupations in which their marginal significance will be greater, a real improvement will have been secured. The existence of the capital in private hands does not injure them (unless indeed prolonging their existence is an injury) but it does not benefit them enough to satisfy the demands of humanity. Those socialists who would allow private capital to compete with that of the State apparently admit all this. At any rate, they would concur in the action of those who do.

Returning to the public body, we may ask whether it should borrow capital for its enterprises or should raise it by taxation. Those who regard the receiving of interest as an evil in itself will presumably advocate the former course, but if they exclude the latter they will have to make a material

sacrifice, for the satisfaction of their sentimental objection, which it will repay us to examine. Raising capital by taxation means compelling the willing and the unwilling alike to stand out of so much present satisfaction in order to secure a communal revenue in the future. Opinions will differ as to what return is adequate to justify the sacrifice. Suppose it is fixed at 5 per cent, that will mean that the effective majority of the community decides that the communal industries must be fed down to the point at which the marginal yield of capital is 5 per cent, but that less than £5 a year does not justify the enforcing of a saving of £100. Now, some members of the community would prefer to spend the share of their capital that they will be required to surrender and go without their share of the revenue it will produce; and others will think that a lower yield would justify the investment of capital and would like to save more and produce larger revenues. We may, if we like, ignore the unwillingness of the former class, and force them, without compunction, to conform to the communal standard of prudence; but nothing is gained by not allowing the others to be more prudent than the average. Suppose, for instance, that taxation (perhaps withholding dividends, which is simply a special form of taxation) has raised as much as the communal authority cares to exact as capital for the establishment of some new industrial undertaking; and suppose that a marginal significance of 5 per cent determines that amount. There will be members of the community who for one reason or another estimate future revenue relatively to present satisfactions more highly than the enforced standard requires. Suppose another £10,000 would bring the marginal yield of the capital down to  $4\frac{1}{4}$  per cent, another £10,000 yet to  $3\frac{3}{4}$ , and yet another £10,000 to  $3\frac{1}{2}$  per cent; and suppose we could raise a loan of £20,000, but no more, if we offered  $3\frac{3}{4}$  per cent. We should then know that we could not carry the margin of productivity down lower than  $3\frac{3}{4}$  per cent without paying more for our capital than it was yielding at the margin, but that we could carry it down to that point. We may, therefore, borrow £20,000, pay for it at  $3\frac{3}{4}$  per cent, and secure to the community the whole curvilinear area which stands above the rectangle of payment, beginning at a height of  $1\frac{1}{4}$  above it and gradually

declining to it. And this gain, against which there is nothing to set, has been secured by opening an opportunity to the more prudent of our fellow-citizens which they value. If we are amongst those who are personally willing to sink capital in the new industry till it reaches the marginal significance of 5 per cent, our more prudent neighbours have now not only helped us (as they would have done even if we had raised no loan) to drag our unwilling fellow-citizens up to our mark (which we have agreed to regard as an advantage), but have also made us a gratuitous present of further revenue. The sentimental objection against such a proceeding must be strong if it is to overrule its advantages. At any rate it is well to realise what the advantages are.

But the most difficult part of the collectivist problem still remains, and is not always faced. If public bodies were the only employers, on what principle should remuneration of the different agents be fixed? Is it possible to conceive of any machinery by which the marginal significance of each should be determined without anything corresponding to the present system of free experimental combination and transference from group to group, in which each individual is urged by his desire to fulfil his own purposes to seek the place in which his marginal significance to others is highest? It may be possible to give an affirmative answer to this question, but the claims sometimes made in the name of "socialism" seem to indicate that in many quarters it has never been seriously asked. We hear it urged, for instance, that the Government ought to be compelled to "find work" for every one at the standard wage. What is the standard wage? It is something that has been arrived at under the various economic pressures of the present system of industry. And the difference between the standard wage of a bricklayer and a bricklayer's labourer, or between that of a type-setter and a cab-washer, may or may not be due to privilege of birth, position, and opportunity, just as much as the difference between the standard wage of a professional man and that of an agricultural labourer. On principle it would seem as reasonable to demand, without further inquiry, employment at the standard wage for doctors and lawyers who were out of work, as for mechanics and labourers. And what is to secure the State that undertakes

such a task from bankruptcy? How is it to know that all the values it secures by its organisation of human effort will cover all those it has promised in remuneration? The receipt given by Bernard Shaw—"to give every man enough to live well on, so as to guarantee the community against the possibility of a case of the malignant disease of poverty, and then (necessarily) to see that he earned it"—is a more rational one, for it would not stereotype the *status quo* of standard wages, and it recognises (parenthetically) that the State must secure assets equal to its liabilities. But if it is a sound receipt it ought to be capable (after the initial outlay of bringing the subject, where necessary, into condition) of reversal, and of being put in this form: "To see that every man earned enough to live well on, and then to let him have it." Let the State try to do this by all means, not recklessly indulging in random experiments and not grudging the expense of promising ones. Let it take care that the expense is laid on the proper shoulders, and finally, while opening all the opportunities that it can, let it close none that are opened by private individuals whether in isolation or in voluntary association.

All this should, of course, be read in the light of facts already laid down,<sup>1</sup> that a large part of the revenue of a community is not earned at all, and that some must, and all may, receive more than they earn.

Expenditure on the part of a public body that brings in revenue in any direct form is spoken of as productive. Expenditure that brings in no direct pecuniary return, such as that on armaments and <sup>Unproductive</sup> loans, more particularly expenditure in war, is spoken of as unproductive. When nations are at war they almost invariably meet a part of the expense not out of accumulations in the war-chest, or out of current taxation, but by borrowing. From whom do they borrow? What is the exact process? And who repays? Clearly the resources devoted to manufacturing ammunition, transporting soldiers, and so forth, are not created by the process of borrowing. Resources of every kind that might have been devoted to other things are devoted to the war, and in the process are destroyed or consumed.

<sup>1</sup> See page 341 *et seq.*, and compare page 573.

Somebody, then, has actually expended energies and resources. We have seen that expenditure is usually induced by promises. In this case the promise is an allowance of so much a year by the nation for every £100 expended on its behalf. We examined the particular terms of our last great loan on pages 239, 240. When two nations are at war, and one of them raises a loan, the persons who actually find the resources required may belong to the borrowing nation, or to neutral nations, or even to the nation with which the country is at war; but the obligation to pay is taken by the borrowing nation in its collective capacity, and will be handed down to its posterity or successors. It is obvious, then, that if posterity is to be regarded as having any rights whatever, the act of borrowing for unproductive purposes is one of extreme gravity which should only be undertaken under any conditions with compunction and a heavy sense of resultant responsibility. It is one thing to consider that a war is worth waging and paying for currently; it is another thing to determine that a war is worth waging provided that we induce certain people to pay for it on the strength of promises, only a small part of which we can fulfil ourselves, and the rest of which will have to be fulfilled by those who have never been consulted in the matter. Hence, there is some general recognition of responsibility for paying off a war debt within a period which will throw the burden substantially on the generation that made the war. But it is only this unreliable sense of obligation, or the still more spiritualised force of abstract devotion to posterity, that can sustain a determination to reduce the National Debt. If we clear the question from all sense of obligation incurred, and look upon it simply as it concerns ourselves, that is to say as presenting us with alternatives between which we may choose after our own convenience, it would seem that we shall never wish to reduce the National Debt at all, unless for certain secondary considerations which will be developed below.

For without any collective action being taken, it is always open to any one to pay off his share of the National Debt and reap his share of the benefit. Suppose we put an individual's share of the debt at £20 (a little above the average arrived at by dividing the National Debt by the population of the

United Kingdom). All he has to do is to invest £20 in the Funds and leave it there. He will then draw 10s. a year, just the amount, according to hypothesis, that he pays in taxes. If every one had thus bought his share (in some cases, of course, more, and in other cases less than £20, for it depends on what each pays in taxes on this account), the whole could be cancelled without affecting any one's position in any way. It would, in fact, be already virtually extinguished.<sup>1</sup> But why do some people hold more and others less than their share of the National Debt? Some consider £2:10s. a year on government security compensates them for saving £100, or is the most desirable way of investing it if they come into possession of it. Others do not. But the Sinking Fund, by which the National Debt is reduced, compels these others, if they are tax-payers, to buy relief from annual payments at the rate of £100 purchase money for £2:10s. annual relief, though if left to themselves they do not do it. If a man who does not think permanent investment in the Funds good enough for himself nevertheless advocates the maintenance of the Sinking Fund, it would seem to be because he feels his responsibility to posterity so keenly that he is willing to relieve posterity from an annual charge of £2:10s. on terms on which he does not care to relieve himself from it; unless, indeed, he realises that he is a very small tax-payer himself, and that he is compelling others to pay in much larger proportion than himself.

It is, however, true that if we contemplate the odious possibility of making other wars for which we do not pay, the fact of our having retained a Sinking Fund may enable us to raise the loan on easier terms than we could otherwise have done. Indeed, apart from that, it is conceivable that our steady maintenance of a Sinking Fund may, together with other causes, so raise our credit that we may be able to reduce the interest on our National Debt by converting it. This is a process into the details of which it is not my purpose to enter. In principle it amounts to borrowing at a lower interest a sum with which to pay off our present debt, thus substituting for it another of the same amount but contracted on easier terms.

<sup>1</sup> We have neglected the expense of collecting and distributing the revenue and have taken Consols at par, for the sake of simplicity.



How far these considerations actually weigh in the counsels of the nation it would be difficult to say ; but I think it is safe to assert that the anxiety of the ordinary citizen to see the National Debt reduced is in fact very largely due to his sense of responsibility to the future ; and nothing can conceivably be more wholesome than the sense of our obligation to pay off our debt, for if once we got rid of it, there would be no check on reckless borrowing with the deliberate intention of paying interest only and never redeeming the debt.

The gravity of the act of borrowing for unremunerative or doubtfully remunerative expenditure will be fully realised when we understand that the burden we lay upon posterity thereby is one that must either be borne for ever or paid off, under a sense of public responsibility, by persons who on their own account would rather go on bearing the burden than pay the price of deliverance.

We have seen that a great deal of what is often thought of as municipal socialism works with capital borrowed from individuals. In such cases the municipality applies Land Nationalisation and manages the capital, but has not full ownership of it. Exactly the opposite condition of things is contemplated by land nationalisers, in the narrower sense, for they advocate the possession of the land by the community, and its application to industrial or other purposes by the rent-paying occupier. Socialists who advocate the complete programme of public possession and administration of all instruments of production are, in a broad and inclusive sense, necessarily land nationalisers, but many land nationalisers declare that they are entirely opposed to socialism. The movement for land nationalisation makes a strong appeal to instinct. It is impossible to think either of a mountain or of the soil of a city as belonging to a private individual without a certain shock. And this instinctive sense of incongruity has undoubtedly been stimulated by the elaborated conception that land, being the free gift of nature, belongs to no one and ought not to be private property, and, further, by the belief that the value of any piece of land is largely determined not by what is done to or on that land itself, but by what is done to or on the land round about it ; so that a vacant site in London,

which owes nothing to capital directly expended on it, may, nevertheless, be worth £50 a square foot or more. It is easy to riddle with destructive criticism all the arguments for land nationalisation, when they are stated absolutely. Why should the land values of London belong to the nation any more than to the world? If New York and all its inhabitants were destroyed by earthquake, or if Russia were swept bare, it would affect the value of land sites in London just as the destruction of the woollen industry in Yorkshire would. What right has the "nation," then, to land which belongs to humanity? Again, we have seen that it is impossible to draw a line between land and capital. A field is not the gift of nature only. It consists in the gifts of nature modified for human purposes by human toil; and so does a book, a coat, or a picture. This is recognised by land nationalisers to some extent, for they would nationalise only that element in any given piece of land, as we usually understand the term, which is not due to labour bestowed on that piece of land itself. Thus, we should everywhere nationalise the indirect value which the expenditure of capital on one piece of land confers on other pieces of land, but nowhere the direct value which it confers on the land to which it is applied! It is generally recognised, therefore, that some statute of limitations would have to be accepted, and that all values that have become practically indistinguishable from those due to the environment, and to the primitive and inalienable properties of the soil itself, should become part of the national property. The abstract distinction, then, between what nature gave and what man has made cannot be consistently maintained. Again, the value of all our possessions may be affected by the course of social or industrial progress. Changes of taste, or catastrophes, or discoveries, for which we have no responsibility, and for which we can take no credit, may secure unearned increment or inflict unearned decrement on the value either of our talents or of our possessions.

Nevertheless, public opinion seems to be flowing towards the recognition of the desirability in many cases of land being held by public bodies. The very fact of the impossibility of distinguishing between land and capital, and the tendency of all those products of labour which it is difficult to separate or

remove from the land—drains, buildings, and so forth—to lapse into the possession of the possessor of the soil, strengthen the feeling that the possessors of the soil collectively hold its inhabitants in the hollow of their hands. The many Allotments and Small Holdings Acts which have been passed testify to the feeling that the powers implied in ownership of the land cannot be safely left to the action of the economic forces with any confidence that they will be used in the best interests of the nation. The scheme of taxing vacant building sites is evidence of the same conviction with reference to non-agricultural uses of land. Public bodies constantly require land and have to buy it, and the questions concerning the value conferred on adjacent sites by capital expended by the public on the public property rise in an acute form. If the whole area were public property, the increased values would automatically fall into that public purse, by expenditure out of which they had accrued. Again, if any industrial opportunity is opened in a particular place, which makes a man's labour worth more within a certain radius of that place than it is elsewhere, the owner of the soil can make him pay more as a condition of allowing him to live there; for the soil on which a man is worth more than on any other soil itself becomes worth more than other soil, and if its quantity is closely limited the marginal increment may be heavy.

These and many other considerations are pushing legislation in the direction both of the taxation and of the communalising of land. Perhaps all social and economic questions are questions of degree, and although we have seen that every kind of property is subject to increments and decrements of value by the action of others than its possessors, yet this is most conspicuously so in the case of land. And its fixity makes it particularly easy to secure its public possession. The instinct, then, that the increase of wealth due to the communal progress should fall under communal control or should be distributed amongst those who have created it, though quite incapable of being logically confined to the land, can, nevertheless, find in the land an eminently suitable subject on which to fasten.

We need not carry our analysis any further. It has

shewn us that many doctrines and many social purposes are blended in the movements which are vaguely thought of as tending to the nationalisation of land. Taxing the unearned increment, when land passes from hand to hand, is an attempt to secure to the nation a portion at least of a value, the creation of which cannot be brought home to any assignable individual or individuals, and may, therefore, be considered as a communal product. Taxing building sites is based on a belief that the economic forces unite individual holders of land in the neighbourhood of cities into tacit combinations, which, while not benefiting them economically as a class, are detrimental to their fellow-citizens. For the theory is that by preventing the natural spread of cities they actually realise the enhanced value of their sites more slowly and in smaller bulk than they would do if they allowed the city to spread. Allotments and Small Holdings Acts, so far as they contemplate the acquisition of land by local authorities, rest to a large extent on the conviction that when cultivation of the land really offers an eligible alternative to the labourer, the small shopkeeper, or the craftsman, there is often a tacit combination to shut him out of it; or, where this is not the case, that he may require some help and encouragement in starting his new career, which it is not to the economic interest of any individual to give him, but which the nation is willing to risk for national purposes. Other points that have been touched upon are sufficiently clear without further comment. And, lastly, the example of great estates managed entirely by agents (or bursars) fosters the idea that land is a convenient form in which public bodies may hold property.

It is to be noted, however, that the nationalisation of land could not, in any direct or immediate form, create wealth. If the nation takes it, it must take it from somebody. No wealth would be immediately or directly destroyed and none would be created; and if any one was at once to be the richer in consequence of land nationalisation, some one else would have to be poorer. In any scheme of land nationalisation, however, a distinction must be drawn between the question from whom the wealth is to be taken and the question in what form it is to be held. Acquiring land does not necessarily mean that the land is to be taken without compensation from the persons who

now own it, though it might mean that; but it must mean that the *value* of the land is taken from some one, unless, indeed, it should be borrowed; and in that case the burden of the interest would have to be borne by some one.

It would be out of the question to attempt an exhaustive analysis of the many-sided phenomenon of Trade Unionism.

Trade Unionism. A Trade Union is, amongst other things, an intelligence department, enabling a man to know, better than he could find out for himself, where he is likely to find the marginal significance of his labour highest, and what that significance is likely to be. Further, it may be a benefit club, providing him with sick pay, out-of-work pay, or an old age pension. But its most characteristic functions are connected with the principle of collective bargaining. If a man earning 25s. a week thinks he is worth 28s., and his employer does not agree with him, and each is determined to act on his opinion, the man will leave his employment and will get work elsewhere if he can. The stake with which he has backed his opinion is a high one, for if he is wrong he will suffer heavily before he has found it out. And he may after all be right, in the sense that he really was worth 28s. to his employer, and would be to other employers if he could but get at them, but he may, nevertheless, fail to find any one else who will give him even 25s. On the other hand, the employer backs his opinion by a comparatively light stake, for if he loses the services of a man who would have been worth 28s. to him, and saves the wage he would have paid him, he is only the loser by the undetermined margin of the gain he would have made on employing him, and this will constitute a very small part of his income; whereas the workman risks the whole of his. The workmen, therefore, taken severally, are at a disadvantage in bargaining with the employer. If however, the whole body, or a considerable number of them, determine to back their opinion, they will bring the stake of the employer individually to something more like equality with the individual stake made by each of them; for though it would make little difference to him to lose the services of one man, it would make a great difference to him to lose the services of many or of all of them. Moreover, by accumulating

a fund they can hope to diminish their risk by gaining a power of resistance which will secure respectful treatment; and by spreading their sacrifices over a long period of preparation and accumulation they may make them at a lower total cost, should the worst come to the worst.

But as far as we have yet gone it would seem that both employer and employed would have an interest in ascertaining how much the man is really worth, and that the competition of the employers will tend to secure him in getting it; for, if the employers are always eager to take a man if he is willing to work for less than he is worth to them, will not every employer prefer making a shilling a week himself to seeing another make 1s. 6d.? And will he not, therefore, bid the man up until he is receiving his full economic wage? It would, therefore, seem that the machinery of Trade Unionism is a rather elaborate provision for the assistance of economic forces which are strong enough to look after themselves. But here an interesting point arises. Suppose two employers of a thousand hands each are paying 25s. a week to each of them, and that each employer knows that every man is really worth 28s. a week to him, *i.e.* if he lost the services of one man, at the margin of a thousand, it would reduce his own incomings by 28s. a week. It follows that it would pay each of them to take on a certain number of extra hands; not only at 25s. but at anything short of 28s. So it is generally argued that each of the employers will compete for the men with the other until the wage is raised to 28s. But this is not really so; for, if an employer took on, say, a hundred more men at 26s. or 27s., he would have to raise the wages of the thousand men he already employs by one or two shillings each. He would, if he raised wages to 26s., get a hundred new men worth 28s. each for 26s. and so make a clear profit of £10 a week, but he would have to pay a thousand extra shillings a week to his present men, and so would lose a clear profit he is now making of £50. If he got the new men at 27s., the gain would be £5 and the loss £100. The employers, of course, perfectly understand this practically, and consequently there is an automatic lock on the competition of the large employers, without the necessity of any formal combination

or agreement amongst them. They will decline to bid for a few extra men and a small extra profit which would involve a greatly increased expenditure. Each, then, will contentedly remain at the point at which he stands. Theoretically, it would seem, it is only where there is a fringe of small employers that there is any effective competition amongst those already in the trade. If a small man who is not employing any hands at all, or is only employing two or three, sees his way to taking a job that would employ ten men, and making £1 a week clear profit, he may bid for them. There will only be, at most, two or three shillings a week to set against the gain. He, therefore, might become an effective competitor for labour in the market. But if the business is one that it is difficult to enter without the expenditure of large capital and the lapse of considerable time, the established employers will be shielded for a considerable period against competition from fresh employers, who have not the choice between normal and abnormal profit in the business, but only between the normal profit and none at all. This seems to be the true economic justification of collective bargaining; for, if the hands are sure of their case, they can, by the threat of a strike, place before the established employer the alternative that would face him if he were thinking of entering the trade, namely, the payment of the economic wage of 28s., or ceasing to conduct the business at all.

But while discovering the economic justification of collective bargaining we have also unveiled the theoretical possibility of its being an economically destructive force; for the established employer is not, after all, in the position of the man who is thinking of entering the industry. His capital is not free for other alternatives, and it is conceivable that a powerful organisation may compel him to make such terms as would have precluded him from entering the industry and will preclude others from doing so. This course, if successfully maintained and persisted in, would ruin the industry. Hence, it would appear that the action of Trade Unions in demanding a rise or resisting a fall of wages is justified only when the ideal economic position coincides with their demands. And by the ideal economic position

I mean the position that would be determined by the marginal economic worth of every man if they all moved freely to the positions in which that worth was highest, depleting the less remunerative trades and so raising the marginal significance of labour in them and replenishing the more remunerative trades and so bringing down their marginal rewards to equality with those of the others. This being so, it is conceivable that an arbitrator or even a government official might be able to form a closer estimate of the actual economic position than would be arrived at by a combination of employers and a combination of employed trying their strength one against the other. On the other hand, it would be exceedingly dangerous to assume that this would be so, and only so far as it was so could the award be really effective; for, though it is conceivable that an external authority might determine that all persons employed in a certain industry should be paid at a certain rate, it would be impossible to enforce the employment of a given number of men at that rate. Men might turn to other employments, or employers might take on fewer hands, if the award did not correspond with the economic facts of the situation.

A number of questions arise in connection with the enforcement, whether by Unions or by the State, of a standard or minimum wage. If no one is to be employed in a certain industry at less than 28s. a week, then no one who is not deemed worth 28s. a week will be employed in that industry at all, and the ranks of the unemployed may be swelled. The unwillingness of employers to take on any but young men, and the cruel hardship suffered by men who have passed their full strength, because they cannot find employment at the standard wage and the employers are forbidden by the Unions to pay them anything less, is, with apparent justice, attributed to this cause. And all proposals for establishing a rigid minimum wage should take careful note of this. You cannot make a man worth a given wage by saying that he shall not be offered and shall not take any less. You rob him of such earnings as he could make and the community of such results as his labour could produce, and this sterilising of his powers of



production seems to have no compensation. The Trade Unionists, as a body, appear to be convinced that allowing a man who is not worth the full wage to accept a lower remuneration would have a detrimental effect on their interests, but it is difficult to see any general principle on which this apprehension can be based; and possibly it may rest in part on that most natural, but socially most pernicious, conception, that we have spoken of elsewhere as the lump-of-labour theory.<sup>1</sup> The necessity of making some provision for their own members when out of work must act as a check upon powerful Trade Unions which might otherwise be tempted to maintain a wage which would involve extensive unemployment. Any proposal that relieves or tends to relieve those who have a powerful voice in fixing the rate of wages from this burden, so as to give the higher wage to those who are employed and throw the care for the unemployment it causes upon other shoulders, should be watched with the utmost jealousy.

And this brings us to our last series of remarks on the subject of Trade Unionism. If, and in so far as, the Trade Unions seek to limit their numbers, or to limit the output, and so to maintain their wage, they are seeking to establish themselves as privileged members of society, and are acting unsocially. And if, and in so far as, they successfully resist an access to their numbers which would reduce their marginal significance while increasing that of other groups (by hypothesis now lower than theirs), they are again acting unsocially, though naturally. Lastly, the justification of a strike must be that there are not a sufficient body of persons able and willing to do the work demanded at the wage offered. If the employers can find competent workers who will accept the wage they offer, that is an indication that, should the claims of the strikers be met, these others, able and willing to do the work on certain terms, would be driven to alternatives less eligible to themselves. And this, again, is establishing and maintaining a position of privilege to the detriment of the unprivileged workers. We are driven, therefore, to the hard saying that the hatred of the blackleg, however natural, has no social justification, and if ever a Union has to invoke

<sup>1</sup> Page 354.

public odium to assist it in defeating the blackleg, it seems to shew that its position is economically unsound. It is, of course, possible that the blacklegs, being inferior workmen, may really be less than worth their wage, so that permanent employment of them would be economically ruinous to the employer. In such cases the show of carrying on the business may be mere bluff, intended to demoralise the Unionists by a pretended independence of them. But, if the blacklegs are really doing the work, they are demonstrating that the Unionist claim is for a position of privilege and is anti-social. Acts of personal cruelty and spite in this connection are always formally condemned; but, under the impression (a mistaken one as I have tried to shew) that such acts are done in a good cause and are directed against men who are "traitors" not only to their own mates but to humanity, they are sometimes judged leniently or altogether condoned. If it is true that acts of cruelty and tyranny are largely practised, as is hotly asserted and as hotly denied, no one can be more interested in their extirpation than the leaders of the Trade Unions themselves.

## CHAPTER III

### CONCLUSION

**SUMMARY.**—*Unearned revenues of some kinds may be appropriated to public purposes, and exceptionally high private revenue of all kinds may be taxed, to a degree that cannot be theoretically determined beforehand, without detriment to the springs of industrial efficiency. A man's share in such public revenue may be independent of his economic worth. So far men may be required to give according to their means, and may receive according to their needs. But the economic forces tend to give every man what he is worth to others, neither less nor more. The economic problem of poverty, therefore, regarded as a part of the social problem, but not the whole of it, is the problem of making the "underpaid" worth more so that they will receive more under the pressure of the economic forces. This may be attempted by developing their powers, physical and mental, and by impartially securing access to opportunities. The consequent abolition or reduction of privilege may cut down many of the mighty from their seats, and exalt the humble. Preparing for the Kingdom.*

In a brief concluding chapter we may attempt to draw together the conclusions that are warranted by the whole course of our inquiry, so far as they bear upon the question of securing a less uneven distribution of wealth. Every one is shocked by the co-existence of luxurious wealth and hopeless poverty side by side. The time is gone for a fatalistic acquiescence. The warning that if we try to mend things we shall only make them worse is losing its terror. On the

other hand the heyday of Utopias, in which both the conditions of life and human nature itself were to be completely revolutionised, seems to be passed. Few people are now either so certain that they will succeed or as much afraid of trying as they were even a few years ago. Increased intellectual caution and increased practical boldness seem to characterise the present in contrast with a very recent past. But theory may still be useful, partly in pointing out the most hopeful lines for experiment and yet more in enabling us to understand and profit by its results. It is true that an appalling sense of helplessness must often overwhelm the student as he contemplates the magnitude of the problems and the uncertainty and feebleness of the methods by which the attempt is being made to solve them; but a note of hopefulness can generally be heard from those who are most closely engaged in the actual battle, and who, one would think, have best reason to despair. To us, too, in all social matters hope is a "paramount duty," but so is a determination not to feed ourselves and others on illusions.

Setting aside more ambitious and revolutionary schemes, and taking it that the economic pressures, which urge every man to place himself under the conditions in which he will be useful to others, will remain the great moving forces of the industrial world, we ask how the general level of success in gaining a steady foothold in that industrial world may be raised, and how failure, rising from lack of opportunity, lack of capacity, or accident, may be robbed of its sting. The successful have always acknowledged some kind of obligation to the unsuccessful. Theoretically, no man need starve in our country, but until lately the public as distinct from the private provision for the defeated and unsuccessful has been consciously and intentionally grudging and reprobating. It has been thought that, dread of want being the great stimulus to effort, the natural or social penalties of failure may indeed be mitigated to some extent, but must not be allowed to become other than terrible. A marked change is coming over our feelings in this respect. It is already difficult to recover the attitude of mind in which it was seriously believed that the prospect of a workhouse, little short of penal in its regula-

tions would create an energy and thrift which the prospect of an old age pension would hamstring.

But in what sense need there be any failures at all? What proportion of the failures are due to lack of opportunity? And how far need the success of one be accompanied not only by the relative but by the absolute failure of another? This is the problem to which we are now addressing ourselves, and there is a widely spread and still spreading conviction that the actual human material that comes into existence year by year is capable of indefinitely better development than it now receives, with indefinitely better results. We have seen reason to believe that some of the contemplated methods of amelioration are illusory, but the awakened spirit of humanity will not accept defeat. If our investigations have been in any degree enlightening, they will be forgiven for being sobering.

The central thesis of this book is that, so far as the economic forces work without friction, they secure to every one the equivalent of his industrial significance at the point of the industrial organism at which he is placed. The full and comprehending acceptance of this principle would at once dispel a number of hopes and banish a number of fears and scruples. It used to be maintained, for instance, that if the workers of the country had allotments, or if cheap baths and wash-houses were provided for them at the expense of the municipality, or if in any other way their condition were improved, their wages would automatically fall. Naturally it is true that if such improved conditions were extended to persons within a certain area, and were not available elsewhere, there would be a tendency to migrate to that area, and so to overstock the local markets of labour and reduce the wages there; but this would not be because the workers were better off, but because there were more of them without proportional increase in the other factors of industry. Again, we may set aside at a stroke the fear that old age pensions, for example, will lower the rate of wages by creating a set of persons who "can afford to work cheap." If men get what they are worth, and if the worth of a man who has 5s. a week safe is as high as that of one who has nothing, then he will receive as much. It may of course be true that he was receiving more than

he earned because the payment was not wholly economic, and that when the obligation to keep the man's head above water is assumed by the State it is dropped by the individual. But that is another matter. And so far as any friction caused by imperfect markets and imperfect mobility has to be overcome, the man who has something to fall back upon will be better able to exact the payment for his full economic worth than the man who has nothing.

On the other hand the idea that life can be improved by a simple decree that higher wages shall be paid, in other words the hope of social regeneration by the enactment of a minimum wage, appears to be illusory. We have noted again and again that you cannot make a man worth so much a week by saying that he shall receive it, and that the economic forces will never induce any one to give a man more for his work than that work is worth to the giver. The only circumstances under which the enforcement of a minimum wage can be theoretically defended are when there is reason to believe that the economic conditions really justify a higher wage, but that friction and lethargy prevent the economic forces acting; or when the creation of a certain amount of unemployment is deliberately contemplated under the idea that it will be easier to deal with than a mass of employment at starvation wages. We start, then, from the thesis that if there are great bodies of persons in every country receiving starvation wages, it must be either because the economic forces cannot overcome certain frictions, or because the persons in question, under existing circumstances, are not industrially worth any more than they are receiving. If so, it is no use denouncing some one else for not giving them more than they are worth. We must either overcome the industrial frictions, or make them worth more where they are, or place them somewhere where they will be worth more. The steady tendency of present movements is to concentrate on the attempt to make them worth more. The cry for feeding school children, which defies all the wisdom of our fathers, justifies itself by pleading that ill-nourished children will be worth nothing, and, therefore, will get nothing, in the industrial world. This is only carrying a step further the principle that was acknowledged long ago in the State aid of

education, and finally in the full acceptance of the national responsibility for the education of the people. But many are bitterly disappointed with the results of compulsory education and sceptical as to the value of our present methods, and are trying to conceive of a system of true education, at once industrial and human, that shall be a great instrument for training, sorting, and directing the faculties and developing the characters of the community, so as to make every talent available for the highest and most urgently needed function which it is capable of performing, and making every normally efficient man and woman worth enough at the margin to be able to command the means of a human life.

The "population question" in the old sense no longer troubles us. We have no fear of "population overtaking the means of subsistence" in the abstract. But it may well be that labour exchanges and emigration offices may have to be organised on an international scale to secure the due balance and distribution of efforts; and the growing belief that it is our collective duty to take charge in some way or other both of the children and of the unemployed directs many minds to speculate on the possible rise of the stupendous problem of the regulation of population in the not distant future. Only experience, however, can decide whether better conditions of life and a fuller sharing by the State of the responsibilities of the parent will really tend to stimulate, in any unmanageable degree, the multiplication of a helpless population. There are many reasons, to say the least, for gravely questioning it.

Meanwhile, we can already trace in the Allotments and Small Holdings Acts the feeble beginnings of a movement to open fresh opportunities, and to force, against the obstruction of prejudice or class jealousy, fresh channels through which the economic forces may beneficently flow.

The means for all these developments must be secured by a frank recognition of the claims of the unsuccessful and unfortunate upon the successful and the fortunate. The tax on "unearned increment" is an initial claim of the community on the unearned income which is perpetually flowing into private hands. And the super tax even on earned incomes, if they are sufficiently high, is an acknowledgment of the

principle that success, as such, has its special duties. Our general principle will not incline us to fear that if success is "robbed of its reward," to a certain extent, it will cease to be attractive, and men will be too much discouraged to care to exert themselves. On the contrary, we have seen reason to believe<sup>1</sup> that the more highly a man is paid, the less work he is likely to wish to do for pay, so that in theory cumulative taxation should make men of exceptional ability and success more rather than less industrious. And surely we may hope (or at the very least we may "dream a dream of good" and be the better for it) that the time will come when a rich and successful man takes a pride in thinking that his direct public usefulness automatically increases with his growing command of resources for his private purposes.

We have already spoken of the fund, let us hope the growing fund, of public spirit which devotes administrative talent to the communal service.

But we, the privileged, must remember that if we are in earnest we are endeavouring to curtail or to abolish privilege. We are throwing open the preserves, and in proportion as we succeed in our endeavours, we and our children will have to take chances in a world that has no special care for us. We can contemplate the prospect without dismay if we believe that the lowest places in a regenerated industrial society will be places that can be filled with dignity and satisfaction, and will yield the conditions of a truly human life. So and only so can we accept without either terror or self-reproach a competitive system. We can only regard the highest success as an object of honourable ambition, if the failure to attain success does not involve the exclusion from all that makes life worth living.

And, finally, how are we individually to "prepare for the Kingdom"? By learning to find our chief delights in the things which all may share and which are the solace, not of our class, but of our humanity. By learning to rejoice in the common weal, and to respect and enjoy the communal property. By learning to feel that "keeping up appearances" is a sorry substitute for grasping realities which would cost the same sum. And above all by understanding that the

<sup>1</sup> See page 77.



relatively wealthy and successful man, by unconsciously shewing what the things for which he most cares really are, directs the ambitions and moulds the aspirations of those who have less power of realising their ideals than he has himself.

As the wealthy are called upon to bear more and more of the public burdens, as the privileged see their preserves invaded, as equality of opportunities more and more prevails, and men rank according to their worth, not according to their antecedents, there will be bitterness and indignation wherever the value of humanity has not come to be felt as higher than that of position. The triumph of a material democracy, without the corresponding spread of the democratic spirit, would cause acute distress and sense of wrong in the face of phenomena which would be hailed with heartfelt thankfulness were the democratic spirit penetratingly present.

## **SELECTED PAPERS AND REVIEWS**



# SELECTED PAPERS AND REVIEWS

## THE MARXIAN THEORY OF VALUE

### *DAS KAPITAL* : A CRITICISM<sup>1</sup>

I HAVE long wished to lay before the disciples of Karl Marx certain theoretical objections to the more abstract portions of *Das Kapital* which suggested themselves to me on my first reading of that great work, and which a patient and repeated study of it have failed to remove.

The editors of *To-Day*, with equal candour and courtesy, have given me the opportunity I sought; and my first duty is to thank them for opening the pages of their review to a critical analysis of the teaching of the great Socialist thinker. The sense of obligation will be more than doubled if any student of Marx should think my criticisms deserving of a reply; for while making no illusions to myself as to the probability of serious and matured convictions being shaken, on either side, by such a controversy, I am none the less persuaded that in studying so profound and abstruse a work as *Das Kapital*, neither disciples nor opponents can afford to neglect the side-lights that may be thrown upon the subject by any earnest and intelligent attempt to analyse and discuss it from a point of view differing from their own.

As a challenge, then, to a renewed study of the theoretical basis of *Das Kapital*, the following remarks may perhaps be regarded as not altogether out of place in *To-Day*, even by those Socialists who are most convinced that a vigorous propaganda, rather than a discussion of first principles, is the specific work to which the Socialist press is now called.

<sup>1</sup> [Reprinted from *To-Day*, Vol. II. (New Series), pp. 388-409, Oct., 1884.]

It has been held by Economists of the most widely divergent schools that the wages of manual labour normally tend, under existing conditions, to sink to a point at which they barely suffice to support existence and allow of reproduction; and that the only means (always under existing conditions) by which wages could be permanently raised would be a collective refusal on the part of the working-classes to live and propagate on the terms at present granted—*i.e.* a raising of the standard of minimum comfort. This position—which I do not stay to examine—is accepted by Marx (*Das Kapital*, pp. 155-163 [73-5]).<sup>1</sup>

But if his results coincide, in this respect, with those of the old school of Economics, the grounds on which he rests them are, of course, entirely different.

In the Malthusian philosophy the reason why wages steadily tend to the minimum allowed by the "standard of comfort" (*aliter dictum*—to starvation point) is sufficiently obvious. It is a law not of society but of nature. The point of "diminishing returns" has been reached and passed, and every additional labourer whom the increase of population throws upon the field reduces the average productiveness of labour, so that there really is less wealth per head to be consumed, and each labourer, of course, gets less for himself. This is supposed to go on until the labourers refuse to add to their numbers (standard of comfort check) or are unable to do so because their children cannot live (starvation check).

On the monstrous assumptions of Malthusianism all this is obvious enough; but it need hardly be said that Marx does not grant these assumptions, and must, therefore, find some other explanation of the phenomenon they are called on to account for. It is not in the material environment of humanity, but in the social and industrial organisation of capitalistic societies that we must look, according to Marx, for the reasons that force men to accept starvation wages.

What is it, then, in the conditions of modern industrialism that compels the producers of all wealth to make such hard terms with the non-producers? What is it that constantly

<sup>1</sup> I cite from the second German edition (1872), which is probably the one in the hands of most of my readers. References to the French translation are added in square brackets.

fills the markets with men willing and anxious to sell their "labour force" for the wages of bare subsistence?

As far as I can see, Karl Marx gives two distinct and disconnected answers to this question. In the later portion of *Das Kapital* (I speak, of course, of the single volume published), he shows how the alternate expansions and contractions of the several branches of industry, aggravated by the disturbances caused by the introduction of "labour-saving" machinery and so forth, tend constantly to throw upon the market a number of unemployed labourers, who will offer their "labour-force" to the purchaser at prices barely adequate to support existence. All this seems to me worthy of the most earnest attention; but it is not my present purpose to dwell upon it further; for according to Marx there is a deeper cause of the phenomenon we are examining, immanent in the very fact of the purchase of "labour-force" in the market at all, and essentially independent of any such influences as I have just referred to which may depress or disturb that market when once established. It is to this alleged inherent necessity of "capatalistic"<sup>1</sup> production that I wish to direct attention.

<sup>1</sup> Throughout his argument in the published volume of *Das Kapital* Marx deals with the "capitalist" simply as an employer of labour, reserving for future treatment not only the merchant, but the possessor and investor of money who draws interest from it without personally engaging in any industrial or commercial pursuit (pp. 148, 149 [69b, 70a]). Now it is the investor of money, as such, whom recent English-writing economists, such as Sidgwick and Walker, have agreed (as it seems to me with good reason) to call the "capitalist," in contradistinction to the employer of labour, or the trader, who may or may not be his own capitalist. On this, however, I do not insist. Marx is justified, from his point of view, in using the term as he does, for he regards the function of the employer of labour, i.e. the purchase of labour-force and the employment of it in producing "utilities," "commodities," or "wares" (*vide infra*), as the sole normal source of that "surplus value" which is subsequently divided up into rent, interest, and profit (pp. 204, 205, 210, cf. 195 note [92b, 94b, cf. 88a, note]). According to him, therefore, the function of the "rentier" or receiver of interest is merely a derived form of the function of the "entrepreneur" or employer of labour, and it is this latter who is the "capitalist" *par excellence*, the prime recipient or extractor of all the wealth which labour creates, but which the labourer does not receive. Marx is perfectly aware, though I am not sure that his disciples always remember it, that this view of the origin of all "surplus value" appears to stand in glaring contradiction to experience and to the historical order in which the successive forms of capital have been evolved, and that this apparent contradiction can only be removed by a long chain of reasoning which is not given in the published volume of *Das Kapital*, though it seems to be promised in a future portion of the work (pp. 312, cf. 148, 149, 203 [133a, cf. 69b, 70a, 92b]); but again I have no intention of insisting upon this, as my purpose is not to inquire whether Marx's

I must ask leave to restate the main positions which lead up to Marx's conclusions in the order which will be most convenient for subsequent analysis. According to Marx, then, the (exchange) value of wares is determined by the amount of labour necessary on the average to produce them, and in the last resort their average selling price depends upon their value (pp. 52, 81, 151 *note* 37, etc. [30a, 42a, 70b *note*, etc.]), so that in dealing with normal relations we must always assume that whatever is sold or purchased, is sold or purchased at its full value and no more.

The manufacturer, then, must be supposed to sell his product at its value, which is as good as to say that he receives a sum of money for it representing the number of days of labour required to produce it. But he must also be supposed to have purchased all the machines, raw material, labour-force, etc., necessary to production at their value, *i.e.* he must have given as much money for them as represents the number of days of labour needed to produce them. Now if we take any one of these necessaries of production, such as the coal needed to work the engines, and inquire into the relation in which it stands to the value of the product, the problem seems to be a very simple one. Inasmuch as a certain amount of coal must be burned before so much cotton cloth can be produced, the labour expended in getting the coal is in reality a part of the labour expended in producing the cotton cloth, and in estimating the value of the cotton cloth, we must reckon in so many days' labour expended in getting coal. The cloth, then, is more valuable than it would have been had the coal

explanation of the phenomena of capitalistic industry is adequate, but whether the fundamental analysis upon which it rests is sound.

With reference to the terms "commodity" and "ware," which will frequently occur in this article, it may be noticed that Marx's use of the word *Gebrauchswerth* for concrete objects exactly corresponds to Jevons's definition of a *commodity*: "By *commodity* we shall understand any object, substance, action or service, which can afford pleasure or ward off pain" (*Theory of Pol. Ec.*, p. 41), except that Marx would substitute "labour-force, etc.," for "action or service." It seems a pity that "utilities" as a designation of concrete objects is not sanctioned by English usage. Marx uses *Waare* to signify a commodity or "utility" which was made expressly with the view of exchanging it, not of using it directly (p. 15). It seems to me that *ware* is the proper English for this, though there are indications that Marx himself might perhaps have translated it "commodity," a term which in English writers certainly does not carry the *differentia* of his *Waare*. Passages bearing on the correct translation of *Waare* will be found on pp. 15, 17, 55, 61, 63, 111, 137, etc., of *Das Kapital*.

been unnecessary to its production by the precise amount of labour needed to produce the coal; but by hypothesis this is exactly represented by the money paid for the coal, so that the price of the coal (if purchased at its value) will reappear in the price of the cloth (if sold at its value)—so much *and no more*. The same reasoning will apply to the machinery, raw cotton, and so forth. The labour needed to produce each of these is labour needed to produce the cotton, and the fact that they are all necessary to the production of cotton enhances the value of cotton by precisely the amount of their own value—so much *and no more*. But when we come to labour-force, the case is different. Labour-force, like every other ware, has its value determined by the amount of labour needed to produce it. Now the amount of labour needed to produce, say, a day's labour-force, is the amount of labour needed to produce food, clothing, etc., adequate to maintaining the labourer in working condition for one day, allowance being made for the support of a number of children adequate to keeping up the supply of labourers, and so forth. Our capitalist then goes into the market and purchases labour-force *at its value*.<sup>1</sup> We may suppose, for the sake of argument, that this value represents six hours' work, *i.e.* that it would need so much work to provide the labourer with all things needful to keep him in working condition for one day. The capitalist, then, by expending a sum of money representing six hours' work has purchased at its value, and becomes the possessor of, a day's labour-force. It is now at his absolute disposal, and on the supposition that a man can work eight or ten hours a day without any undue strain upon his system (so that the labour-force, the value of which the capitalist has paid, is labour-force capable of being applied over eight or ten hours), it is obvious that the capitalist will realize a gain of two or four hours' work. He (virtually) puts into the labourer (in the shape of food, clothing, etc.) a value representing six hours' work, and in virtue of this transaction, he causes the labourer to put eight or ten hours' work into the cotton. Hence the

<sup>1</sup> He may, and often does, purchase it below its value, but the abstract argument assumes the contrary as the normal condition of things. It is essential that this should be quite clearly understood. (Cf. pp. 150, 151, 207. *Da der Werth des variablen Kapitals—Werth der von ihm gekauften Arbeitskraft*) and [70 and 93 b] *passim*.)



result that, though he buys all the things needful to the production of the cotton (including labour-force) *at their value*, and sells his cotton *at its value*, yet *more value comes out than goes in*. This "more" is the "surplus value" to secure which is the capitalist's aim, and from which interest, rent and profit are ultimately cut out as so many slices.

The production and appropriation of this surplus value is, according to Marx, the immanent law of capitalistic production, and no mere incidental development of it. If the extraction of surplus value from the application of labour-force were rendered impossible, the capitalist would lose his sole motive for engaging in his peculiar form of production at all.

I believe this is a fair summary of Marx's argument, and if so, its essential positions are as follows:—

First. The (exchange) value of a ware is determined by the amount of labour needed on the average to produce it.

Second. There is such a degree of correspondence between the value of a ware and its average selling price, that for theoretical purposes we must assume that nominally wares are bought and sold at their values.

Third. Labour-force is (in our industrial societies) a ware subject to the same laws and conditions of value and exchange as other wares.

Whether Marx's conclusions can be logically deduced from these positions or not is a question which I will not attempt to answer now, for I am concerned with the positions themselves. Against the second (when a correct definition of value has been reached) I have nothing to urge. It is the first and third that I wish to test.

With reference to the theory of value, it will be convenient to follow Marx in his fundamental analysis of the process of exchange.

He begins by pointing out that the fact of two wares being exchangeable (no matter in what proportion) implies of necessity both *Verschiedenheit* and *Gleichheit*; i.e. that they are *not identical* (else the exchange would leave things exactly where it found them), and that they are different manifestations or forms of *a common something* (else they could not be equated against each other). In other words, things which are exchange-

able must be *dissimilar in quality*, but yet they must have some common measure, by reduction to which the equivalent portions of each will be seen to be *identical in quantity*.

Now with regard to the qualitative dissimilarity, I do not see that there is any room for difference of opinion. It consists in the divergent nature of the services rendered by the respective wares. Cast-iron nails and new-laid eggs differ in respect to their "value in use." They serve different purposes. Even a red and a blue ribbon, though they both serve purposes of adornment, are capable each of rendering some particular services of adornment under circumstances which would make the other a mere disfigurement. I agree with Marx, then, that the *Verschiedenheit* of the wares is to be found in the respective *Gebrauchswerth* of each, or, as I should express it, *commodities differ one from another in their specific utilities*.

But in what does the *Gleichheit* consist? What is the *common something* of which each ware is a more or less? Marx replies that to get at this something, whatever it is, we must obviously set on one side all geometrical, physical, chemical and other natural properties of the several wares, for it is precisely in these that they differ from one another, and we are seeking that in which they are all identical. Now in setting aside all these natural properties, we are setting aside all that gives the wares a value in use, and there is nothing left them but the single property of being *products of labour*. But the wares, as they stand, are the products of many *different kinds* of labour, each of which was engaged in conferring upon them the special physical properties in virtue of which they possess specific utilities. Now to get at that in which all wares are identical we have been obliged to strip off all these physical properties in which they differ, so that if we still regard them as products of labour, it must be labour that has no specific character or direction, mere "abstract and indifferent human labour," the expenditure of so much human brain and muscle, etc. The *Gleichheit*, then, of the several wares consists in the fact that they are all products of abstract human labour, and the equation  $x$  of ware A =  $y$  of ware B, holds in virtue of the fact that it requires the same amount of abstract human labour to produce  $x$  of ware A or  $y$  of ware B (pp. 12, 13, cf. 19, 23, sq. [14b, 15a, cf. 17a, 19 sq.]).

Now the leap by which this reasoning lands us in labour as the sole constituent element of value appears to me so surprising that I am prepared to learn that the yet unpublished portions of *Das Kapital* contain supplementary or elucidatory matter which may set it in a new light. Meanwhile the analysis appears to be given as complete and adequate, so far as it goes, and I can, therefore, only take it as I find it and try to test its validity. But instead of directly confronting it with what seems to be the true analysis of the phenomenon of exchange, I will follow it out a little further, and we shall see that Marx himself introduces a modification into his result (or develops a half-latent implication in it), in such a way as to vitiate the very analysis on which that result is founded, and to lead us, if we work it out, to what I regard as the true solution of the problem.

A few pages, then, after we have been told that wares regarded as "valuables" must be stripped of all their physical attributes, *i.e.* of everything that gives them their value in use, and reduced to one identical spectral objectivity, as mere jellies of undistinguishable abstract human labour, and that it is this abstract human labour which constitutes them valuables, we find the important statement that *the labour does not count unless it is useful* (pp. 15, 16, 64 [16a, 35a]). Simple and obvious as this seems, it in reality surrenders the whole of the previous analysis, for if it is only useful labour that counts, then in stripping the wares of all the specific properties conferred upon them by specific kinds of useful work, we must not be supposed to have stripped them of the abstract utility, conferred upon them by abstractly useful work. If only useful labour counts, then when the wares are reduced to mere indifferent products of such labour in the abstract, they are still *useful* in the abstract, and therefore it is not true that "nothing remains to them but the one attribute of being products of labour" (p. 12 [14b]), for the attribute of being useful also remains to them. In this all wares are alike.

Armed with this result, let us return to the fundamental analysis of the phenomenon of exchange.

The exchange of two wares implies a heterogeneity (*Verschiedenheit*) and a homogeneity (*Gleichheit*). *This is implied in the fact that they are exchangeable.* And here I must chal-

lunge the attention of students of *Das Kapital* to the fact that the analysis by which "labour" is reached as the ultimate constituent element of (exchange) value, starts from the naked fact of exchangeability and is said to be involved in that fact. It is true that in the instances given by Marx the articles exchanged are wares (*i.e.* commodities which have been produced for the express purpose of exchange), and moreover wares which can practically be produced in almost unlimited quantities. It is true also that Marx elsewhere virtually *defines* value so as to make it essentially dependent upon human labour (p. 81 [43a]). But for all that his analysis is based on the bare fact of exchangeability. This fact alone establishes *Verschiedenheit* and *Gleichheit*, heterogeneity and homogeneity. Any two things which normally exchange for each other, whether products of labour or not, whether they have, or have not, what we choose to *call* value, must have that "common something" in virtue of which things exchange and can be equated with each other; and all legitimate inferences as to wares which are drawn from the bare fact of exchange must be equally legitimate when applied to other exchangeable things.

Now the "common something," which all exchangeable things contain, is neither more nor less than abstract *utility*, *i.e.* power of satisfying human desires. The exchanged articles differ from each other in the *specific desires* which they satisfy, they resemble each other in the *degree of satisfaction* which they confer. The *Verschiedenheit* is qualitative, the *Gleichheit* is quantitative.

It cannot be urged that there is no common measure to which we can reduce the satisfaction derived from such different articles as Bibles and brandy, for instance (to take an illustration suggested by Marx), for as a matter of fact we are all of us making such reductions every day. If I am willing to give the same sum of money for a family Bible and for a dozen of brandy, it is because I have reduced the respective satisfactions their possession will afford me to a common measure, and have found them equivalent. In economic phrase, the two things have equal abstract utility for me. In popular (and highly significant) phrase, each of the two things is *worth* as much to me as the other.

Marx is, therefore, wrong in saying that when we pass

from that in which the exchangeable wares differ (value in use) to that in which they are identical (value in exchange), we must put their utility out of consideration, leaving only jellies of abstract labour. What we really have to do is to put out of consideration the concrete and specific qualitative utilities in which they differ, leaving only the abstract and general quantitative utility in which they are identical.

This formula applies to all exchangeable commodities, whether producible in indefinite quantities, like family Bibles and brandy, or strictly limited in quantity, like the "Raphaels," one of which has just been purchased for the nation. The equation which always holds in the case of a normal exchange is an equation not of labour, but of abstract utility, significantly called *worth*. The precise nature of this equation we shall presently examine; but let it be observed, meanwhile, that "labour" is indeed one of the sources (not the only one) alike of value in use (specific utility) and value in exchange (abstract utility), but in no case is it a constituent *element* of the latter any more than of the former. A coat is *made* specifically useful by the tailor's work, but it *is* specifically useful (has a value in use) because it protects us. In the same way, it is *made* valuable by abstractly useful work, but it *is* valuable because it has abstract utility. Labour, in its two-fold capacity of specifically useful work (tailoring, joinery, etc.) and abstractly useful work, *confers* upon suitable substances both *Gebrauchswerth* (value in use) and *Tauschwerth* (value in exchange), but it is not an element of either.

I venture to think that if any student of Marx will candidly re-peruse the opening portion of *Das Kapital*, and especially the remarkable section on "the two-fold character of the labour represented in wares" (pp. 16-21 [16-18]), he will be compelled to admit that the great logician has at any rate fallen into formal (if not, as I believe to be the case, into substantial) error, has passed unwarrantably and without warning, from one category into another, when he makes the great leap from specific utilities into objectivised abstract labour (p. 12 [14b]), and has given us an argument which can only become formally correct when so modified and supplemented as to accept *abstract utility* as the measure of value.

But to many of my readers this will appear to be an absurd

and contradictory conclusion. "When all is said and done," they will think, "we know that as a matter of fact the exchange value of all ordinary articles is fixed by the amount of labour required to produce them. It may be true that *I am willing to give* equal sums for A and B because they will gratify equally intense or imperious desires, but, for all that, the reason why *I have to give* equal sums for them, and why *I can get them* for equal sums, is that it took equal amounts of labour to produce them; and the proof is that if owing to some new invention A could be made henceforth with half the labour that it requires to make B it would still perform the same service for me as it did before, and would therefore be equally useful *but its exchange value would be less.*"

It is the complete and definitive solution of the problem thus presented which will immortalise the name of Stanley Jevons, and all that I have attempted or shall attempt in this article is to bring the potent instrument of investigation which he has placed in our hands to bear upon the problems under discussion. Under his guidance we shall be able to account for the *coincidence*, in the case of ordinary manufactured articles, between "exchange value" and "amount of labour contained," while clearly perceiving that exchange value itself is always immediately dependent, not upon "amount of labour," but upon abstract utility.

The clue to the investigation we are now to enter on is furnished by the combined effects of "the law of indifference" and "the law of the variation of utility" (see Jevons's *Theory of Political Economy*, pp. 49 and 98). By the former of these laws "when a commodity is perfectly uniform or homogeneous in quality, any portion may be indifferently used in place of an equal portion; hence, in the same market, and at the same moment, all portions must be exchanged at the same ratio"; and by the latter, each successive increment of any given commodity (at any rate after a certain point has been reached) satisfies a less urgent desire or need, and has, therefore, a less utility than the previous increment had. For example, one coat possessed by each member of a community would satisfy the urgent needs of protection and decency; whereas a second coat possessed by each member would serve chiefly to satisfy the less urgent needs of convenience, taste, luxury, etc. Now

in a community every member of which possessed two coats already, a further increment of coats would (*ceteris paribus*) satisfy a less urgent need, possess a less utility, and therefore have a lower exchange value than would be the case in a community each member of which possessed only one coat; and, by the "law of indifference," all coats (of identical quality) would exchange with other goods at this lower ratio. Thus the abstract utility of the last available increment of any commodity determines the ratio of exchange of the whole of it. The importance of these facts in their bearing on our problem, I must endeavour briefly to indicate, while referring to Jevons for their full elaboration.

Exchange value is a phenomenal manifestation (conditioned by our present social and industrial organisation) of *equivalence of utility*, which equivalence of utility would, and does, exist even under industrial conditions which render its manifestation in the particular form of exchange value impossible. Let us, then, try to track it down on ground where it is less surrounded by complications and prejudices than it is at home. "All the mystery," says Marx, "of the world of wares, all the false lights and magic which play about the creations of labour when produced as wares, disappear at once when we have recourse to other forms of production. And since Political Economy delights in Robinsoniads, let us begin with Robinson on his island" (p. 53 [30]). I accept this invitation, and proceed to make my own observations on what I see.

Robinson, then, has to perform various kinds of useful work, such as making tools or furniture, taming goats, fishing, hunting, etc.; and although he does not ever exchange things against each other, having no one with whom to exchange, yet he is perfectly conscious of the equivalence of utility existing between certain products of his labour, and as he is at liberty to distribute that labour as he likes, he will always apply it where it can produce the greatest utility in a given time. The need of food being the most urgent of all needs, his first hours (if we suppose him to start with nothing) will be devoted to procuring food, but when he has got some little food, a further increment of it, however acceptable it would be, is not so necessary as the first instalment was, and will, therefore, not be so useful. By devoting a few hours

to the search for, or construction of, some rude shelter he will now be producing a greater utility than he could produce in the same time by obtaining more food; and thus he continues always producing so much of what he wants most that the next increment would have a less utility than some other thing which it would take the same time to secure. He has arrived at a state of equilibrium, so to speak, when his stock of each product is such that his desire for a further increment of it is proportional to the time it would take to produce it, for when this state of things is realised, equal expenditures of labour, wherever applied, would result in equal utilities.

Let us now take the case of an industrial community the labour of which is directed to the immediate supply of the wants of its own members, without the intervention of any system of exchange, and let us suppose, for instance, that it takes a working member of such a community four days to make a coat and half a day to make a hat. We will put all other branches of industry out of consideration, we will suppose that at a given moment the members of the community are, owing to some special cause, equally ill-provided with coats and hats, and that under the climatic and other conditions to which they are subject, it would cause them equal discomfort to go without coats or without hats. A hat is therefore, at the present moment, as useful as a coat, and it only takes one-eighth of the time to make it. Labour will, therefore, be directed to hat-making rather than to coat-making; for why should I spend four days in producing a certain utility when I could produce another utility exactly equivalent to it in half a day? But when a certain number of hats have been made the inconvenience caused by the insufficient supply becomes less acute, whereas the want of coats is as great as ever. Additional hats, therefore, would no longer be as useful as the same number of additional coats, but would be, say, half as useful. But since a man can produce eight hats in the time it would take him to make one coat, and since each hat is worth half as much (*i.e.* is half as useful) as a coat, he can still produce four times the utility by making hats which he could produce in the same time by making coats. He therefore goes on making hats. But the need of hats is now rapidly diminishing, and the time soon arrives when additional hats would be



only *one-eighth* as useful as the same number of additional coats. A man can now produce equal utilities in a given time whether he works at coats or hats, for though it will take him eight times as long to make a coat as to make a hat, yet this coat when made will be as useful as eight hats, it will be *worth* eight hats to the community. Equilibrium will now be established, because the stock of coats and hats is such that the utility of more coats would be to the utility of more hats as the time it takes to make a coat to the time it takes to make a hat. But observe a coat is not worth eight times as much as a hat to this community, because it takes eight times as long to make it (that it always did, even when *one* hat was worth as much to the community as a coat)—but the community is willing to devote eight times as long to the making of a coat, because when made it will be worth eight times as much to it.

The transition to the industrial conditions under which we actually live is easy. Indeed it is already contained in the word “worth.” The popular instinct has appropriated this word to the “common something” which all exchangeable commodities embody, irrespective of the industrial conditions of their production and of the commercial conditions of their circulation and consumption. From my own individual standpoint I may say that A is worth as much to me as B, *i.e.* that there is to me an *equivalence of utility* between A and B, though their specific utilities may be wholly unlike. From the standpoint of communistic or patriarchal economics, I might use the same language with the same meaning. A is worth as much to the community as B, *i.e.* there is an equivalence of utility to the community between A and B. Lastly, from the point of view of a commercially organised society in which no man’s wants are reckoned unless he can give something for their gratification (the ordinary point of view) we may say “A and B are *worth* the same,” = “there is an equivalence of utility to ‘the purchaser’ between A and B,” = “there are persons who want more A and persons who want more B; and the desire for more A on the part of the former (as measured against their desire for other commodities), is equivalent to the desire for more B on the part of the latter, measured in the same way” = “the (exchange) values of A and B are equal.”

One point remains to be cleared up. In the case of manufactured articles, such as hats and coats, for instance, there is always a certain stream of supply flowing, and when we speak of "the desire for more hats," we must be understood to mean, not the desire on behalf of purchasers for more hats *than they have*, but their desire for more hats *than are being supplied*, i.e. the pressure (or rather suction) which seeks to widen supply. By the "law of indifference" it is the force of demand *at the margin* of supply which determines the exchange value of the whole. For example, a watch of a certain quality is *worth* £15 to me, i.e. it would have as great a utility to me as anything else which I have not got, and which I could obtain for £15. But watches of the quality in question are now being supplied to the commercial society of which I am a member at the rate of fifty *per diem*, and the ranks of the men to whom such watches are worth £15, are only recruited at the rate of ten *per diem*. The ranks of those to whom they are worth at least £10 are, however, recruited at the rate of fifty *per diem*, i.e. the worth or utility of watches of such and such a quality, supplied at the rate of fifty *per diem*, is, at the margin of supply, £10, and, therefore, by the "law of indifference" all the watches exchange at that same rate. A desire for *all* the watches that are available (theoretically identical with the desire for an infinitesimal increment of watches *beyond* what are available) is felt by persons to whom each watch has a utility represented by at least £10. A desire for *some* of the watches (but not all) is felt by persons to whom each watch would have a utility represented by some larger amount, in some cases perhaps £15 or even more, but this high utility of watches to *some* people does not affect their utility at the margin of supply, and therefore does not affect their exchange value. Thus, while value in exchange is rigidly determined by value in use, yet it may happen that any number of persons short of the whole body of purchasers, may obtain for £10 each, watches which have a utility *for them* represented by something more than £10. It is needless to add that the "margin of supply" may be fixed by the holding back from the market of a certain part of the commodities in question by the traders, or by the deliberate limitation of the production by the manufacturers, or by the physical

limits imposed on the manufacture, or perhaps by other causes. This does not affect the matter.

Let us now take up the problem from the other side. Watches are being produced at the rate of fifty *per diem*, and they are worth £10 each when produced. It requires, say, twelve days' labour to produce a watch, and (due allowance being made for the quality of the labour (cf. *Das Kapital*, p. 19 [17a]) we will suppose there is no other direction which could be given to this labour by which in the same time it would produce anything worth more than £10, *i.e.* having a greater utility at the margin of supply than the watch has.

Now suppose an improvement in the manufacture of watches to be made which saves twenty-five per cent of the labour. This does not, in itself, affect the utility of watches, and therefore, nine days' labour applied to watch-making will now produce as great a utility as twelve days applied to any other industry. Anyone who has the free disposal of labour will of course, now apply it to watch-making, but the watches he makes *will no longer be as useful* as watches have been hitherto, and for the following reason. There are more watches available now than there were formerly. If they are all to be bought (or indeed used) they must, some of them, be bought (or used) by persons to whom (in comparison with other things) they are *less useful* than the watches formerly sold were to their purchasers. All the persons to whom a watch was as useful as 200 lbs. of beef (supposing beef to be a shilling a pound), or anything else they would get for £10, are already supplied (or are being continuously supplied as they continuously appear), and if more watches are sold it must be to persons to whom they are only as useful as, say, 180 lbs. of beef would be. A man to whom *one* watch was as useful as 200 lbs. of beef, but to whom a second watch in the family (though a great convenience) was not so imperiously required as the first, will now determine to buy a second watch which *will be less useful* than the first, but still as useful as 180 lbs. of beef. Others to whom even a single watch would not have been as useful as the greater amount of food, purchase one now because it is as useful as the smaller amount. The usefulness of a watch at the margin of supply is now represented by £9. The value of watches has fallen, *not because they con-*

tain less labour, but because the recent increments have been less useful, and by the "law of indifference" the utility of the last increment determines the value of the whole.

Still, however, there is an advantage in making watches. Nine days' labour applied in any other direction would only produce a utility represented by £7 : 10s., whereas if applied to watch-making it will produce a utility represented by £9. Labour free to take any direction will still be directed to watch-making, and by increasing still further the number of watches available, will again lower their *usefulness* (measured by its ratio to the usefulness of other things) at the margin of supply, till at last there are so many watches already in the possession of those to whom they are useful, or in the normal stream of supply, that any further increment of watches would not be more useful to anyone than 150 lbs. of beef or a dress suit, or a sofa, or new clothes for the children, or something else which he wants, which he has not got, and which he can get for £7 : 10s. When this point is reached equilibrium is restored. Nine days' labour produces a utility represented by £7 : 10s., whether devoted to watch-making or anything else. The value of the watch now coincides with the amount of labour it contains, yet it is not worth £7 : 10s., neither more nor less, because it contains nine days of a certain quality of labour, but men are willing to put nine days and no more of such labour into it, because when made it will be worth £7 : 10s., and it will be worth that sum in virtue of its utility at the margin of supply which, by the "law of indifference," determines its exchange value.

The correctness of this theory of value may be tested in another way. Utility arises from the power possessed by certain things of gratifying human desires. We have seen that as these things are multiplied, the desires to which each successive increment ministers, become relatively less intense, by which their utility at the margin of supply (called by Jevons their "final utility") is lowered. We have seen that this "law of variation of utility" fully accounts for all the phenomena of supply and demand and for the coincidence, in the case of articles that can be indefinitely multiplied, between the relative amounts of labour they contain and their relative values. But if utility is the real constituent element of

value, there must be another aspect of the question. Utility rising out of a relation between human desires and certain *things* (whether material or immaterial), must be affected by any modification either in the things or in the desires. We have seen that in many cases labour can indefinitely modify the number of the things, and by so doing can modify their (final) utility, and so affect their value. But there are other things which are normally exchanged (and which we must, therefore, regard as containing that "common something" which is implied in every equation of exchange, and to which it is the height of arbitrariness to refuse the name of "value"), the number and quality of which labour is powerless to affect; and yet they, too, rise and fall in value. Such are specimens of old china, pictures by deceased masters, and to a greater or less degree, the yield of all natural or artificial monopolies. The value of these things changes because their utility changes. And their utility changes, not because of any change in their own number or quality, but because of a change in the desires to which they minister. I cannot see how any analysis of the act of exchange, which reduces the "common something" implied in that act to *labour* can possibly be applied to this class of phenomena.

We have now a theory of value which is equally applicable to things that can, and things that can not, be multiplied by labour, which is equally applicable to market and to normal values, which moves with perfect ease amongst the "bourgeois categories" that have been prominent in the latter part of our argument, and fits all the complicated phenomena of our commercial societies like a glove, and yet all the while shows that these phenomena are but the specially conditioned manifestations of the ultimate and universal facts of industry, and find their analogues in the economy of a self-supplying patriarchal community or of Robinson Crusoe's island.

— It only remains to apply our results to Marx's theory of surplus value. The keystone of the argument by which that theory is supported is, as we have seen, the proposition that the value of labour-force is fixed by the amount of labour needed to produce it, whereas in its expenditure that same labour-force liquefies into a greater amount of labour than it

took to produce it, so that if a man purchases labour-force at its value, he will be able to draw out at one end of his bargain more labour (and therefore more value) than he puts in at the other.

We have now learned, however, that value does not depend upon "amount of labour contained," and does not always coincide with it. Under what conditions does it so coincide? And does labour-force comply with those conditions? Whenever labour can be freely directed to the production of A or B optionally, so that  $x$  days of labour can be converted at will into  $y$  units of A, or  $z$  units of B, then, but then only, will labour be directed to the production of one or the other until the relative abundance or scarcity of A and B is such that  $y$  units of A are as useful at the margin of supply as  $z$  units of B. Equilibrium will then be reached.

But if there is any commodity C, to the production of which a man who has labour at his disposal can *not* direct that labour at his will, then there is no reason whatever to suppose that the value of C will stand in any relation to the amount of labour which it contains, for its value is determined by its utility at the margin of supply, and by hypothesis it is out of the power of labour to raise or lower that margin.

Now this is the case with labour-force in every country in which the labourer is not personally a slave. If I have obtained by purchase or otherwise the right to apply a certain amount of labour to any purpose I choose, I cannot direct it at my option to the production of hats (for instance) *or to the production of labour-force*, unless I live in a country where slave-breeding is possible; and, therefore, there is no economic law the action of which will bring the value of labour-force, and the value of other commodities, into the ratio of the amounts of labour respectively embodied in them.

It appears to me, therefore, that Marx has failed to indicate any immanent law of capitalistic production by which a man who purchases labour-force at its value will extract from its consumption a surplus value. We are simply thrown back upon the fact that a man can purchase (not produce) as much labour-force as he likes at the price of bare subsistence. But this fact is the problem we are to investigate, not the solution of the problem.

The object of this paper is purely critical, and my task is, therefore, for the present, completed. Only let me repeat that in the latter portion of the published volume of *Das Kapital* Marx appears to me to have made contributions of extreme importance to the solution of the great problem, though I cannot see that they stand in any logical connection with the abstract reasoning of his early chapters.

### THE JEONIAN CRITICISM OF MARX

(*A Comment on the Rev. P. H. Wicksteed's Article by Bernard Shaw.*<sup>1</sup>)

The October number of *To-Day* is memorable for containing an attack by a Socialist on the theory of value held by the late Karl Marx. A Roman Catholic impugning the infallibility of the Pope could have created no greater scandal. Sentence of excommunication was pronounced by *Justice*. *The Inquirer* and other papers well affected to the cause demanded impatiently, as the months passed, why the heretic remained unanswered. That he can easily be answered, refuted, exposed, smashed, pulverised, and economically annihilated, appears to be patent\*to many able Socialists. Without adding such an atrocious comment as that I am glad to hear it, I do not mind admitting that a certain weight will be removed from my mind when the attack is repulsed, and the formerly pellucid stream of the Ricardian labour value theory has deposited the mud which the late Stanley Jevons stirred up in quantities which, though expressed by differentials, were anything but infinitely small. Mr. P. H. Wicksteed, the assailant of Marx, has adopted the Jevonian theory. He is known as an accomplished Scriptural critic, and was perhaps in search of fresh Bibles to criticise when *Das Kapital*, the Bible of Socialism, came under his notice and struck him as being vulnerable to Jevonian equations of utility. Socialists often dogmatise intolerably on the subject of what Marx taught, or what they suppose him to have taught, on the subject of value; and Mr. Wicksteed, being a sworn enemy of dogma, has in my opinion acted wisely as well as written ably in leading the assault which must have

<sup>1</sup> [Reprinted from *To-day*, Vol. III. (New Series), pp. 22-26 (Jan., 1885).]

been made sooner or later upon the economic citadel of Collectivism. An odd effect of this assault is the appearance of Marx, for the first time since he defended Ricardo against Proudhon nearly forty years ago, in the ranks of the orthodox economists. As against Cournot, Jevons, Walras, Professor Marshall, and Mr. F. Y. Edgeworth, Marx is undoubtedly on the side of the standard English school of Adam Smith, Ricardo, Mill, and Cairnes. His disciples are still a little bewildered at being no longer scouted as the dupes of a revolutionist and incendiary, but patronised as the old-fashioned followers of an excellent writer of the past generation, whose ideas, all very well in their day, are now quite obsolete.

I have not the slightest intention here of defending Karl Marx against Mr. Wicksteed. It is impossible, in the face of the *Misère de la Philosophie*, and several passages in *Capital*, to suspect Marx of having lost sight of the supply-and-demand phenomena which make the actual world so different from the sphere of "catallactic atoms" with which he deals in the opening chapters of his great work. On the other hand it is equally impossible, without access to the unpublished volumes of that work, to answer for the way in which so subtle a reasoner may have reconciled these contradictions, or even to feel sure that Jevons might not, had he lived, have found himself anticipated in the very quarter from which he expected the most determined opposition. I write partly to draw further attention to a controversy which seems to me of great interest because it is one on which Socialists, without at all ceasing to be Socialists, are sure to divide very soon; and partly because I wish to have a word with Mr. Wicksteed as to my own perplexities concerning "final utility" before some more competent hand deals him the *coup de grâce* to which I have already alluded. Even were I economist enough to do that myself, I am not mathematician enough to confute Mr. Wicksteed by the Jevonian method. I somewhat mistrust mathematical symbols. I remember at school a plausible boy who used to prove to me by algebra that one equals two. He always began by saying, "Let  $x$  equal  $a$ ." I saw no great harm in admitting that; and the proof followed with rigorous exactness. The effect was not to make me proceed habitually on the assumption that one equals two, but to impress upon me that there



was a screw loose somewhere in the algebraic art, and a chance for me to set it right some day when I had time to look into the subject. And I feel bound to make the perhaps puerile confession that when I read Jevons's *Theory of Political Economy*, I no sooner glanced at the words "let  $x$  signify the quantity of commodity," than I thought of the plausible boy, and prepared myself for a theory of value based on algebraic proof that two and two make five. But as it turned out, Mr. Jevons, less ingenious or more ingenuous than my schoolfellow, arrived at no more remarkable conclusion than that if  $x$  equalled  $y$ ,  $y$  equalled  $x$ , which I should have granted freely without the aid of algebra. And I was much relieved subsequently to find that the late Professor Cairnes regarded these equations as identical propositions.

Says Mr. Wickstced: "The clue to the investigation we are now to enter on is furnished by the combined effects of the 'law of indifference' and 'the law of the variation of utility.'" Let us take an example of the law of the variation of utility. To a hungry man the utility of beef is high. The first few mouthfuls, which save him from actual starvation, are of very great utility to him indeed. But as he gets his fill, every successive mouthful has less and less utility, until finally he can eat no more, and the remainder of the beef is useless to him. Here the utility has varied constantly. Now by the law of indifference, which is that there cannot be two prices for like commodities at one time in one market, the last mouthful of beef costs just as much as the first. Consequently the man has not to pay more for the first mouthful than for the twentieth, though it is infinitely more useful to him, nor, when he has eaten so much that he can eat no more, could he buy another mouthful more cheaply than the first, useless as the beef has become to him. The value has not varied at all, whilst the direct utility has varied from infinity to zero. But the beef which is thus bereft of its direct utility may possess acquired utility; that is, its satiated possessor may have a hungry neighbour willing to pay him for it. Suppose, however, the man to be a member of a wholly improvident community, every member of which has just, like himself, had a sufficient dinner. The utility of his beef will then be at zero; the choicest undercut will be as valueless as it is

in heaven, no matter how much labour its production may have cost. Utility, then, is evidently a condition of value. But let six hours elapse. In that space Nature produces "negative utilities" in the form of appetite: the universal discomfort. The utility of beef, useless and valueless six hours before, rises to the utility of human life itself: from nothing to everything. Will the exchange value rise equally? By no means: it will rise to the cost of catching, killing, and cooking a cow: not a farthing higher. If a man demand a greater price from another, obviously that other will, in the last resort, catch, kill and cook for himself, and so save the excess demanded from him. If the labour necessary to produce the beef be halved or doubled, neither the mass nor the final degree of utility in the beef will be altered one jot; and yet the value will be halved or doubled. Evidently, then, the utility does not determine the value. The utility of water to a thirsty man is exactly the same at Aldgate Pump as in the middle of the Sahara, yet he will give nothing at Aldgate for a gallon, whereas in the Sahara he may give all he possesses for a thimbleful. Even in the latter extreme instance of a monopolist demanding an outrageous bribe for a share of the means of subsistence, the price of the water would vary without the least regard to the utility. To half a dozen travellers dying of thirst, but having unequal possessions, half a dozen draughts of water would possess equal utility; yet a Jevonian sheikh with command of the water would receive different quantities of commodity for each draught. And if the parties were in the same position a few hours later, the desperate necessity of the travellers would recur; the sheikh would still have command of the water, the final utility of which would again be infinite; yet the price of the water would be a mortgage on their future labour as slaves; the travellers having nothing else to give. I use this illustration because it shows that even a monopoly value is not determined by the final utility any more than a market value (such as that of beef), and because it directly illustrates the ordinary economist's habit of regarding the value of a thing as the maximum of blackmail which its possessor can extort from the person who desires to consume it. To the end of time a monopolist who cannot be expropriated by force will be able to force other men to do more labour for

him than he does for them in return. If he be at once base and acute enough to extort the utmost his victims will give, then, in a community of infinitely rich men, the prices obtained by him might be said to be determined by the final utility of his commodity to the purchasers; but each of them would pay a different price, and would, therefore, have to be presupposed incapable of exchanging the commodity one with another after purchasing. Otherwise they would defeat the operation of final utility, precisely as rich people defeat it now when they borrow their servants' clothes and obtain gratuitous medical advice at hospitals.

"If I am willing," says Mr. Wicksteed, "to give the same sum of money for a family Bible and for a dozen of brandy, it is because I have reduced the respective satisfactions their possession will afford me to a common measure, and have found them equivalent." This may be so; but it does not at all follow that Mr. Wicksteed will find Bibles and brandy exchanging in that ratio. The price of neither would be raised or lowered by one farthing if Mr. Wicksteed suddenly got tired of the Bible and became a dipsomaniac. Apart from that his nearest teetotal neighbour would probably give more money for a Bible than for a dozen hogsheads of brandy; while the nearest drunkard would eagerly offer a dozen Bibles for a single bottle of brandy, if the ratio of exchange were determined by the utility of the commodities. But as the rain falls alike on the just and the unjust, so is the price of Bibles and brandy the same to Mr. Wicksteed and his neighbours, though the utility differs in each of their cases. And even were it possible to determine an average ratio of utility between brandy and Bibles, the fact that this would remain the same although the ratio of the labour necessary to produce them should vary, and that the ratio of exchange would nevertheless immediately alter, shews that the ratio of exchange does not depend on utility. Mr. Wicksteed insists on "abstract" utility; but what he has really abstracted is not utility but value. He has accused Marx of having leaped from one category to another, because, as it seems to me, he has mistaken the category to which his own abstraction belongs.

Every appreciative reader of Mr. Wicksteed's article will at once conclude that these considerations are as obvious to

him as they are to me, and that his theory must in some way explain them. "For example," he says, "a watch of a certain quality is *worth* £15 to me: *i.e.* it would have as great a utility to me as anything else which I have not got, and which I could obtain for £15." But again it does not follow that the watch will therefore cost Mr. Wicksteed £15. It may cost him only £5. All that does follow from the conditions laid down is that, if necessary, he will go as high as £15 for the watch, but that if the price rises to fifteen guineas he will go without a watch. That does not mean that the utility of the watch to him will fall to zero the moment the odd shillings are added to the price. It simply means that though the utility remains the same, he will not be able to afford the price, or will think that he might spend fifteen guineas to better advantage on a writing-table than on a watch. The comparison of utility which he has made between them does not change the value of either. The order in which desires arise does not affect the cost of satisfying them, which is always ultimately a cost of labour. On the contrary, the labour cost of satisfying our desires generally determines the order of them. A child sometimes quarrels with its bread-and-milk and cries for the moon; but eventually it succumbs to economic conditions and puts off thinking about the moon until its bread-and-butter is secured.

Mr. Wicksteed maintains that if twenty-five per cent of the labour necessary to make a watch be saved by an improvement in manufacture, the value of watches will fall "not because they contain less labour, but because the recent increments have been less useful." By this he appears to mean, not that a watch is less useful to a workman with a pound a week than to a lord with a hundred pounds a day, which is obviously not the case, but that the workman can now afford to buy a watch whereas he could not do so before. If the determination of the ratio of exchange (or the measure of exchange value) by duration of labour be founded on the fact that if two "catallactic atoms" A and B produce and exchange commodities, A cannot afford to give more than the product of an hour of his labour to B in exchange for the product of an hour of B's labour, and that B cannot afford to take less, it is not clear to me that Mr. Wicksteed advances the matter

by calling exchange value "utility at the margin of supply." He certainly does not simplify it to the Socialist proletariat who, face to face with the monopolist, does not achieve quite so fair a bargain as a couple of "catallactic atoms" might strike on Marx's principles.

I regret that the utility of space at the margin of supply, the obscurity of the Jevonese language, and the extreme unpopularity of our subject, have compelled me to put forward a counterblast to Mr. Wicksteed rather than a thorough analysis and discussion of his interesting contribution. Some considerations which arise from his paper are important from a domestic point of view. At present a middle-class man, when his immediate needs are satisfied, furnishes himself with commodities in a certain order, as, for instance, wife, house, furniture, pianoforte, horse and trap. The satisfaction of each desire leaves the mind free to entertain the next, so that you actually make a man feel the want of a horse by giving him a pianoforte. Let the cost of a pianoforte suddenly rise to a figure exceeding that of a horse and trap; and the conventional order of furnishing will be altered: the horse and trap will be bought before the family ventures on the extravagance of a pianoforte. A collectivist administration, bound to preserve the catallactic atomicity of the markets by adjusting supply to demand, may yet find themselves compelled by the operation of purely subjective notions of utility to admit that Jevons was on the right track when he broke away from economics into psychology, and that the comparative utilities of things are of far greater moment to the community than their ratio of exchange, to which our social system has given a factitious importance. Marx saw this when, many years ago, he compared the utility of the capitalist commodities, potatoes and cotton stuffs, with that of the pre-capitalist commodities, wheat and woollens. My own hopes centre in a Socialist state in which Mr. Wicksteed and I, as perfect and regenerate catallactic atoms, shall dispute about utilities alone, forgetful of the very existence of a ratio of exchange.

THE JEVONIAN CRITICISM OF MARX. A REJOINDER.<sup>1</sup>

Mr. Bernard Shaw's brilliant but good-natured "comments" on my article on the theory of value seem to invite a few words of reply from me.

I will, however, make them very short. After admirably illustrating the fact that to each individual the utility of beef runs daily and weekly through enormous variations, Mr. Shaw declares that this does not affect the exchange value of the article. No more it does, if the variations counteract each other. If they are all in the same direction at the same time they do affect the exchange value—as Mr. Shaw would know were he a butcher or a housekeeper. But at any rate, says Mr. Shaw, the exchange value cannot rise above the "cost of catching, killing and cooking a cow." Had I Mr. Shaw's pen in my fingers I could give my readers a delectable picture of the indignant housekeeper defeating the extortionate butcher by sallying forth to catch, kill and cook "a cow" for dinner, but I will not enter upon an unequal combat in badinage with Mr. Shaw. I presume he means that the price of beef cannot rise above the cost of bringing it into the market. No more it can, permanently. Temporarily it can, and often does. The only reason why it cannot do so permanently is because as long as labour can produce a higher average utility by bringing beef into the market than by taking any other direction it will put itself to that special task by preference and so will *reduce the final utility of beef* by supplying the want of it down to a lower point.

I am quite at a loss to know what Mr. Shaw means by saying that "If the labour necessary to produce the beef be halved or doubled, neither the mass nor the final degree of utility in the beef will be altered one jot; and yet the value will be halved or doubled." Unless and until both the total and the final utilities *are* altered the exchange value will remain exactly the same. It is only by producing more beef, and thus at the same time increasing its total and lowering its final utility, that the increased facilities of beef-making can produce any effect on the price whatever.

<sup>1</sup> [Reprinted from *To-day*, Vol. III. (New Series), pp. 177-179 (April, 1885).]

As for Mr. Shaw's extortionate sheikh, he simply illustrates my contention that *some* of the consumers always get the whole, and every consumer may sometimes get a part of the commodity he consumes at something less than it is worth to him (the first mouthful of beef costs no more than the twentieth), but that all pay the price represented by the minimum or final utility of the last increment to that one of the consumers, to whom it has, relatively to other commodities; the least utility.

Similar remarks apply to Mr. Shaw's remaining criticisms; but I should like to say a word in elucidation of my statement that when the supply of any commodity is increased the successive increments meet an ever less urgent want, and are, in fact, less and less useful. I admit that in a certain sense this language is misleading, for if we are speaking of *absolute* utilities the presumption is that if the supply of beef is increased till it falls to sixpence a pound, the final increments which get into the workman's alimentary canal are more useful than previous ones, the fate of which we need not pursue beyond the servants' hall. But I never compare absolute utilities, and I do not see how such a comparison could be instituted on any scientific basis. All I contend for is that if yesterday no one had a watch except those to whom a watch was as useful as anything that could be got for £15, and if to-day a number of men possess watches to whom they are only as useful as other things which could be got for £10, the new watches are *relatively to other things* less useful than the former ones were.

Mr. Shaw's youthful experiences about  $x$  and  $a$  are so highly instructive that I cannot refrain from dwelling upon them for a moment. His friend induced him to "let  $x = a$ ," and Mr. Shaw—not expecting that  $x$  would take any mean advantage of the permission—granted the request. But he did not understand that in letting  $x = a$  he was also letting  $x - a = 0$ , and the proof (of the proposition,  $2 = 1$ ) that "followed with rigorous exactness," assumed that  $x - a$  did *not* equal 0.

Mr. Shaw arrived at the sapient conclusion that there was "a screw loose somewhere"—not in his own reasoning powers, but—"in the algebraic art"; and thenceforth re-

nounced mathematical reasoning in favour of the literary method which enables a clever man to follow equally fallacious arguments to equally absurd conclusions *without seeing that they are absurd*. This is the exact difference between the mathematical and literary treatment of the pure theory of political economy.

Only a single word, in conclusion, on the importance of this controversy. It is not a mere question of abstract reasoning (although, if it were, that could hardly be urged in its disparagement by an admirer of Marx). It affects the whole system of economics, and more particularly Marx's economics. In admitted contradiction to apparent facts, and without (at present) any attempt to remove the apparent contradiction, Marx by sheer logic attempted to force us into the admission that "profits," "interest," and "rent," *must* have their origin in the "surplus-value" that results from purchasing "labour-force" at its value, and selling wares at their value. The keystone of the arch is the theory of value adopted by Marx, and I have tried to show that it is not sound. In doing so, I have found an unexpected but powerful ally in Mr. John Carruthers, whose elaborate and thoughtful essay on "The Industrial Mechanism of a Socialist Society," shows the phenomena of "profits" reappearing, in a modified form, in communal industry. My own rather clumsy illustrations of the varying utilities and values of "coats and hats," etc., laboured under the disadvantage of requiring my readers to imagine the wants of society in part at least supplied successively, not contemporaneously. Mr. Carruthers escapes this, and shows how, in a communal industry, the price (though he would not say the "exchange" value) of each article depends on its final utility, and that it is only when, *as a consequence* of the indications thus afforded, labour has been properly apportioned amongst the industries, that prices are apportioned to labour cost.



## ON CERTAIN PASSAGES IN JEVONS'S *THEORY OF POLITICAL ECONOMY*<sup>1</sup>

THE diagrammatic method of studying economics may be regarded from three points of view.

(i.) Many teachers find in it a stimulating and helpful appeal to the eye, and use it as a short and telling way of making statements and registering results.

(ii.) A few students treat it as a potent instrument for giving precision to hypotheses in the first instance, and then for rigorously analysing and investigating the results that flow from them.

(iii.) A very few investigators (among whom I think we must rank Jevons) have hoped ultimately to pass beyond the field of pure hypothesis and analysis, and to build up constructive results upon empirical curves of economic phenomena established by observation.

Precision and firmness in wielding the mathematical method as a hypothetical and analytical instrument are of the first importance; for, without them, all its other uses will turn out illusory. What may be called the "picturesque" use of diagrams, to illustrate theory, is fatally misleading unless an absolutely rigorous and precise interpretation is insisted on; and empirical or hypothetical data may be seriously misinterpreted, even by experts, for want of a sufficiently close preliminary analysis of the mathematical instrument of investigation.

I propose, then, to examine certain passages in Jevons's great work, in the hope of carrying his analysis a step further inward rather than of projecting his results further outward.

---

(i.) "Gregory King's" estimate of the variations in the price of wheat.

<sup>1</sup> [Reprinted from *The Quarterly Journal of Economics*, Vol. III., Boston, 1889, pp. 293-314].

The celebrated estimate of the probable effect of serious deficiencies in the wheat harvest, usually attributed to Gregory King, but perhaps due to Davenant, is made the subject of an interesting investigation by Jevons.<sup>1</sup>

The estimate itself may be put into the following form : Taking 10 as the numerical value of the normal harvest and 1 as the normal price, it is estimated that we should have the price rising to 1.3 for a harvest of 9, to 1.8 for a harvest of 8, to 2.6 for a harvest of 7, to 3.8 for a harvest of 6, and to 5.5 for a harvest of 5.

Without inquiring into the grounds of this estimate, or making himself responsible for its correctness, Jevons tries to throw it into scientific form by deducing from it a law of price as a function of quantity. Taking the ordinates to register price, and the abscissas quantity, we shall have the following data :—

$x$	. . .	10	9	8	7	6	5
$y$	. . .	1	1.3	1.8	2.6	3.8	5.5

Of course there are an indefinite number of possible curves that pass through the six points thus indicated, and we shall be guided in our method of attack by any conceptions we may form on general grounds as to the probable form of the curve.

Jevons (p. 170) proceeds :

“ It is probable that the price of corn should never sink to zero, as, if abundant, it could be used for feeding horses, poultry, and cattle, or for other purposes for which it is too costly at present. It is said that in America corn, no doubt Indian corn, has been occasionally used as fuel. On the other hand, when the quantity is much diminished, the price should rise rapidly, and should become infinite before the quantity is zero, because famine would then be impending. The substitution of potatoes and other kinds of food renders the famine point very uncertain ; but I think that a total deficiency of corn could not be made up by other food.”

These considerations lead Jevons to conjecture that the curve will be of the form  $y = \frac{a}{(x - b)^n}$ , and he fixes the constants so as to get a fair approximation to the values given in the estimate. He concludes, “ Considering the close approximation

<sup>1</sup> *Theory of Political Economy*, second edition, pp. 167-172. I take it that the estimate refers to wheat alone. See Davenant, *Essay upon the Probable Methods of making a people gainers in the Balance of Trade*, pp. 80, 81. But in one passage wheat, barley, and rye seem to be included.

in the above numbers, we may safely substitute the empirical formula for [Davenant's] numbers."

Now I submit that, in the first place, the estimate, whether founded on observation or conjecture, obviously refers to wheat exclusively in its capacity as human food. Indeed, it is distinctly implied by Jevons that it is not actually used for any other purpose. If we are to consider its use as food for horses or (when burned) as manure, we shall have to take into account another curve, which will follow its own law, and will have to be added laterally to the curve we are now examining, as soon as the latter descends low enough to be affected by it.<sup>1</sup> But the fact that if wheat were cheaper people *would* buy it for horses, does not in any way, directly or indirectly, affect the price they really give, or the price they would give if the supply were *diminished*. Obviously, then, the law connecting the six points which constitute our data must be independent of such possible uses of wheat as are wholly inoperative throughout the region over which our observations (or conjectures) extend. In other words, our data belong to the curve that connects the price and the quantity of wheat as *human food*, and this curve will follow its own law independently of any other curves that may combine with it to form the total curve that gives the price of wheat as a function of its quantity. Now it is clear that a comparatively small increase of the supply of wheat would actually reduce its marginal degree of utility as human food to zero; that is to say, would give every potential purchaser as much as he wanted to eat. Our curve, then, must not, as Jevons thinks, be asymptotal to the axis of  $x$ , but must cut it for a comparatively low value of  $x$ .

Again, impending famine will not make the price of wheat infinite. There is no such thing as an infinite price. Whether or not there can be an infinite *utility* is a question of some interest; and I am prepared to defend a negative answer even to that. But there can be no question at all as to the impossibility of an infinite *price*. It is a contradiction in terms. Again, a total failure of wheat, or even of grain in general, would no doubt produce famine, but not amongst the wealthy classes, and famine

<sup>1</sup> This branch of the subject is well worked out by Walras in his "*Éléments d'Économie Politique Pure*. 11<sup>e</sup> Leçon, 30<sup>e</sup> Leçon et passim. Cf. my *Alphabet of Economic Science*, p. 60.

amongst poor people could not raise the price of corn to any very high figure: they can but offer all they have, and before the price of corn has risen many hundred per cent they will have no power to purchase it; their demand will cease to be "effective." Amongst the wealthy people and their retainers there will be no lack of meat and potatoes, vegetables, fruits, etc.; and wheat-bread, though commanding a high price, will not be purchased, in appreciable quantities, at what we are accustomed to think of as extreme famine prices, for there will be no famine amongst the purchasers, there will only be a lack of *bread* in the literal and narrow sense. I must therefore again join issue with Jevons in his second assumption; *viz.* that before we get back to the origin, our formula ought to give us an infinite value for *y*. Indeed, it is pitiable to think how slight the rise would probably have to be in order to induce incipient "famine," and how false the inference that if people are dying for want of a thing the price of that thing must be "infinite."

Divesting ourselves, then, of Jevons's preconceptions as to the general form of the curve, and reserving our own preconceptions (*viz.* that the curve will cut both axes) to act as a check upon our results, let us look for the simplest law we can find which unites the six points. It will appear that they do not lie on a conic. The conic fixed by any five of them does not pass through the sixth. We next try a curve of the third degree. If we assume the simplest form, *viz.* :

$$y = ax^3 + bx^2 + cx + d,$$

we shall find that the curve determined by any four of the points passes through the other two.<sup>1</sup> Its formula will be

$$60y = 1500 - 374x + 33x^2 - x^3.$$

This curve cuts the axis of *x* between 13 and 14, and that

<sup>1</sup> It may be conveniently found by the method of differences. Take four points:—

10	.	.	.	.	1	
						3
9	.	.	.	.	1.3	2
						5
8	.	.	.	.	1.8	3
						8
7	.	.	.	.	2.6	

It will be found that the law here suggested gives the other two points with perfect accuracy. I am indebted to Mr. John Bridge, of Hampstead, for suggesting the application of this method.

of  $y$  at 25. These results have a *vraisemblance* which is truly remarkable when we consider how little right we have to expect such a curve as this to yield reasonable results when carried far beyond the limits of the data.

Such an outcome of our investigations can hardly fail to stimulate curiosity as to the origin of this most interesting estimate, and the grounds on which it was formed.

(ii.) Dimensions of economic quantities.

There are no portions of Professor Jevons's great work that are more difficult or (as I think) less satisfactory than the sections on the dimensions of economic quantities.

The previously uninitiated (of whom I am one) will be able to gather from the works of Professor Jevons himself that the theory of dimensions has been found a powerful instrument in the investigations of natural science, and will welcome his attempt to introduce the same method into economic studies. It is of vital consequence that we should have a precise conception of our several units and their relations to each other, if the mathematical method of economic study is to make any real progress and the careful student will very rapidly learn to recognise in the theory of dimensions a valuable means of elucidating and checking his processes and results.

But the method, as applied by Jevons, appears to fit his diagrams singularly ill; and if it is to find any harmonious development in connection with them, some better principle of co-ordination must be sought.

Perhaps I shall be excused if I introduce the subject by a simple and elementary illustration of the theory itself, derived from the field of dynamics.

If we represent graphically the space which a body, falling from rest, traverses in any given time, under the action of gravitation, we shall have a curve roughly of the form of Fig. I., in which the ordinates represent length-space (10 feet to the unit), and the abscissas time (1 second to the unit). Here the dimension of the ordinates is  $L$ , or length, and that of the abscissas is  $T$ , or time. The *number* of the units contained in any ordinate is connected by a definite law with the *number* of the units contained in the corresponding abscissa ( $s = 16 t^2$ , in feet and seconds), but the *nature* of the units in either case is entirely

distinct. Thus the interpretation of an ordinate of a given length (when once obtained) is independent of the unit of time, because  $T$  does not enter as a dimension into the ordinates ; but if I call a certain ordinate 10 when the unit of length is a foot, I must call it 120 if I change the unit to an inch. Again, if I call a certain abscissa 10 when the unit of time is a second, I must call it  $\frac{1}{6} \frac{0}{0} = \frac{1}{6}$  when the unit of time is a minute. Thus the numerical expression for any quantity of one positive dimension must be increased when the unit of its dimensions is decreased, and decreased when it is increased.

Let us now, treating the number of seconds in the formula

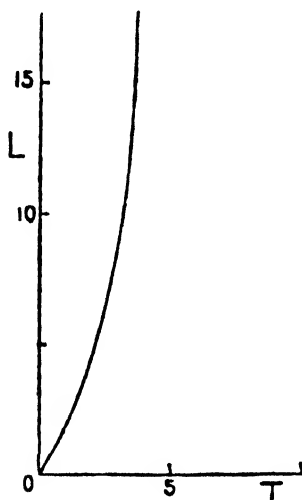

FIG. I.

$s = 16 t^2$  as the variable, and the feet traversed as the function, differentiate the latter to the former. That is to say, let us find the *rate* at which increments of time are increasing the space traversed, at any point in the course of the body ; or, in other words, let us find the formula, and the curve, which will give us the *rate* at which the body is falling, as a function of the time it has been in motion.

The formula, of course, will be  $v = 32 t$ , and the curve is given roughly in Fig. II. Here the unit by which the abscissas are measured is the same as before. Their dimension is  $T$ . But the unit of the ordinates is no longer a unit of length. It

is a unit of *rate*. An ordinate does not now represent feet, but feet-per-second. The unit of the new ordinates, then, is a unit of ratio between length and time, each measured in its own appropriate unit. Both  $L$  and  $T$  must therefore enter into the new ordinates as dimensions; but they do not enter upon the same footing.

Sixteen feet a second is the same thing as  $16 \times 12$  inches or  $16 \div 3$  yards per second; that is to say,  $L$  enters as a dimension into the new ordinates on the same footing as into the old ones. But 16 feet per second is  $16 \times 60$  feet per minute; that is to say,  $T$  enters into the ordinates in the inverse relation of

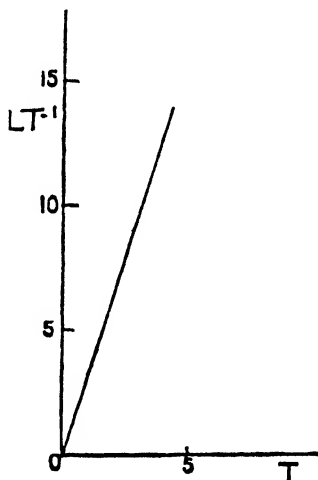

FIG. II.

$L$ . This is represented by saying that  $T$  enters negatively as a dimension. The dimensions of rate of movement will thus be  $LT^{-1}$ .

Since the process of differentiation always consists in establishing limiting *ratios* between increments of the independent variable and increments of the function, it will be clear at once from the above example that the dimensions of the variable must always enter negatively into the derived function, while the dimensions of the original function remain in the derived function positively.

Differentiating again, we shall obtain the rate at which the

rate of motion is increasing, or what is usually called the acceleration of the falling body. It is given in Fig. III. The dimension of the abscissas is still  $T$ ; but the variable of the function in Fig. II. having entered negatively once more into the ordinates, we shall now have  $LT^{-1} T^{-1}$ , or  $LT^{-2}$ , as the dimensions of the ordinates of Fig. III.

This indicates that if the unit of time be decreased, the numerical expression for acceleration must be decreased in the proportion of the *square* of the new unit to the *square* of the old unit. Thus an acceleration of 32 feet per second is an acceleration of 8 feet per half-second; *e.g.* if gravitation is adding 32

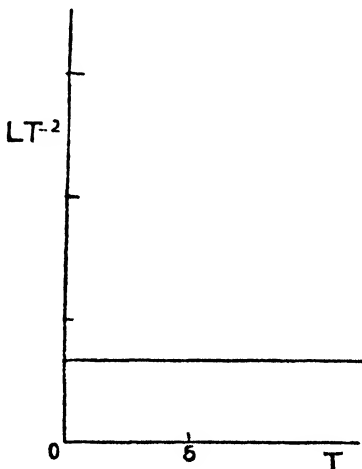

FIG. III.

feet per second to the velocity of a body, in each second, it is adding 16 feet per half-second, in each second, and 8 feet per half-second in each half-second. The new unit being half the old unit, the numerical expression for acceleration must be altered in the proportion of  $(\frac{1}{2})^2 : 1^2$ ; *i.e.* must be divided by 4.

Now note further that in these successive figures an *area* in one always represents the same kind of quantity, and has the same dimensions, as the *ordinate* of its predecessor.

Thus on Fig. III. if we take the area above the abscissa 2, or  $\int_0^2 f''(x) \cdot dx$ , we shall, of course, have a quantity of the dimensions  $LT^{-2}T$ , or  $LT^{-1}$ ; *i.e.* a velocity. But the ordinates



on Fig. II. are velocities. If, again, we take the area above the abscissa 2 in Fig. II., or  $\int_0^2 f'(x) \cdot dx$ , we shall have a quantity of dimensions  $LT^{-1}T$ , or  $L$ ; *i.e.* a length. But the ordinates on Fig. I. represent lengths.

It follows that there is no natural or inherent propriety in representing each actual dimension of the quantity we may be dealing with, by a dimension of space in a diagram, for we have seen that length and velocity may either of them be represented with equal propriety by a line or an area. In the same way area or volume itself may often be suitably represented by a line in a diagram. Again, there is no impropriety or inconvenience in making diagrams in which the same dimension enters positively or negatively into two or more axes. Thus, in our Fig. II.,  $T$  enters positively into the abscissas and negatively into the ordinates.

An apparent neglect of these considerations, which I am not able satisfactorily to explain, has, if I am not mistaken, introduced needless difficulty and obscurity into Jevons's investigations of the dimensions of economic quantities, and has robbed his results of lucidity, if it has not led him into positive error.

Instead of criticising in detail the passages in the *Theory of Political Economy*, in which this subject is treated, I will go over the ground which they cover, and ask the reader to compare my statements with those of Jevons.

We will begin with total utility. If we use capitals for dimensions and minuscules for the number of units (*e.g.*  $T$  for the dimension time, and  $t$  for the number of seconds or other units of time), we may indicate the units of total utility resulting from any consumption of commodity by  $u$ , and the number of units in the corresponding amount of commodity by  $q$ . The fundamental quantitative fact with which Economics have to deal may then be expressed in the thesis that  $u$  is always a function of  $q$ .

Now Jevons shows that,  $q$  being the variable, the final degree of utility of a commodity is the differential coefficient to  $q$  of its total utility; whence it follows that, taking  $U$  as the dimension of total utility, and  $Q$  as the dimension of commodity, we shall have the dimensions of final degree of utility  $UQ^{-1}$ .

Jevons uses the symbol  $U$  to signify final degree of utility

(cf. Jevons, p. 71), but I think this notation is calculated to mislead. I should suggest that when we wish to speak of final degree of utility without entering upon the analysis or history of the conception, we should indicate the number of units by  $v$ , and the dimension by  $V$ .

In comparing my formulæ with Jevons's, therefore, it must be borne in mind that his  $u$  corresponds to mine; his  $U$  as a dimension corresponds to my  $V$  or  $UQ^{-1}$ ; his  $U$  as a quantity to my  $v$ , which will be the differential coefficient of  $u$  to the variable  $q$ .<sup>1</sup>

Now final degree of utility determines exchange value, and we have: Exchange value determined by  $v$  (of dimensions  $UQ^{-1}$ ); that is, by *rate at which increments of commodity are increasing total advantage derived from consumption*. In this sense the dimensions of "value in exchange" may be said to be  $UQ^{-1}$ .

Jevons prefers to regard total utility as a quantity of two dimensions,  $MU$ , corresponding to my  $QV$ , and final degree of utility as a quantity of one dimension,  $U$ , corresponding to my  $V$ . If we adopt this view, it would be proper to make final degree of utility our starting-point, and begin with  $v$  as a function of  $q$ . We should then *integrate* to obtain  $u$ , of dimensions  $QV$ . My objection to this is twofold; for total utility is susceptible of direct measurement by any standard of effort or endurance that may be selected (such as foot-tons of work done under assigned conditions), whereas final degree of utility<sup>2</sup> is essentially a (limiting) *ratio*, and is therefore appropriately represented (like all ratios) as having two dimensions (whether simple or complex, homogeneous or heterogeneous) which enter the one positively and the other negatively.

<sup>1</sup> In substituting  $Q$  for  $M$ , I follow the indications of Jevons himself. Preface to 2nd edition, p. xi. On page 71 Jevons appears to use contradictory and inconsistent language with regard to "intensity of feeling," which he identifies in one place with "degree of utility" and more correctly defines two lines above as total instantaneous utility. The former of these quantities has the dimensions  $UQ^{-1}$ , the latter  $UQ^{-1}QT^{-1}$ , or  $UT^{-1}$ . *Vide infra*, I am indebted to Mr. W. E. Johnson, of King's College, Cambridge, for the elucidation of this point.

<sup>2</sup> It must be remembered that when we speak of the direct measurement of final degrees of utility or value it is not really these quantities we are measuring, but the product of final degree of utility into a small increment of commodity. It is not  $\frac{du}{dq}$ , but  $\frac{du}{dq} \cdot dq$  or  $du$ ; i.e. a small increment, of dimension  $U$ , which we measure.

Thus, if we say with Jevons that total utility has two dimensions,  $MU$  (our  $QV$ ), we must, I think, add that one of these dimensions,  $U$  (our  $V$ ), is a ratio, and not properly a dimension at all. In our notation it is equivalent to  $UQ^{-1}$ , and the dimensions  $QUQ^{-1}$  reduce to  $U$ .

In my view, it does not at all follow from this that there is any impropriety in representing total utility diagrammatically by area.<sup>1</sup> We shall do so whenever we draw curves of quantity and final degree of utility. The dimensions of abscissas will be  $Q$ , of ordinates  $UQ^{-1}$ , and of areas  $QUQ^{-1}$ , or  $U$ .

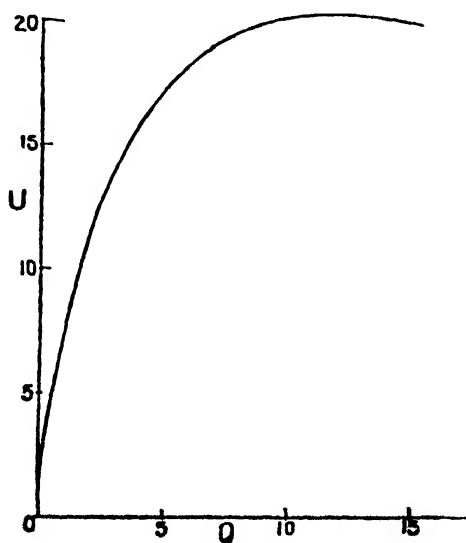

FIG. IV.

But Jevons points out that as a matter of fact it is not supply but rate of supply per unit of time, not total enjoyment but rate of enjoyment, with which we are concerned. Whether this is universally true in any fruitful and manageable sense or not, it is certainly true of all such commodities as food, water, etc. We must therefore take up the question again from this point of view. Regarding rate of supply per unit of time (dimensions  $QT^{-1}$ ) as the variable, and rate of enjoyment, relief, or

<sup>1</sup> Mr. Johnson informs me that writers on the Newtonian dynamics habitually represent linear space by area in their diagrams. This is obviously convenient.

advantage per unit of time (dimensions  $UT^{-1}$ ) as the function, and then differentiating, we shall find that the dimensions  $T$  cancel each other, and we have  $UT^{-1}Q^{-1}T$ , or  $UQ^{-1}$  again, as the dimension of the rate at which increase in rate of supply increases rate of enjoyment. And it is, in truth, sufficiently plain that this rate is a direct relation between the quantity of the commodity and the enjoyment it causes, and is not affected in its numerical expression by any change in the unit of time.

These results are summarised on Figs. IV.–VII. : in Fig. IV. we have dimension of abscissa  $Q$ , and dimension of ordinate  $U$ ; in Fig. V. of abscissa  $Q$ , of ordinate  $UQ^{-1}$ , of area  $U$ ; in Fig. VI. of abscissa  $QT^{-1}$ , of ordinate  $UT^{-1}$ ; in Fig. VII. of abscissa  $QT^{-1}$ , of ordinate  $UQ^{-1}$ , of area  $UT^{-1}$ ; where the areas in Figs. V.

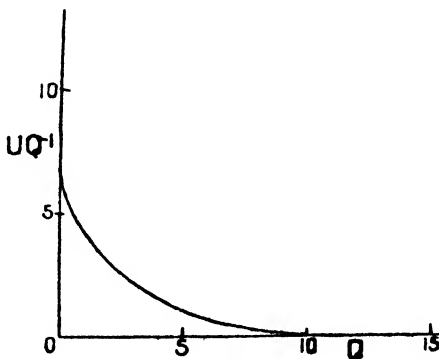

FIG. V.

and VII. have the same dimensions, respectively, as the ordinates in Figs. IV. and VI.

If we wished to represent, with the aid of Fig. VII., the total advantage derived from the consumption of a given quantity of commodity at the rate indicated, we should have to add a third axis perpendicular to the plane of the figure, on which to measure the time during which the rate of enjoyment represented by the area is maintained. Neither of Jevons's objections to this method are valid. There is no reason why an economic quantity of one or of two dimensions should not be represented by a figure of three dimensions; and there is no objection to introducing time positively on one axis and negatively on another.

It should be observed that this method renders a perfect

account of the fact that (under ordinary circumstances, and with due limitations) we must hold that the same amount of commodity yields a larger sum of satisfaction when consumed slowly than when consumed fast. The result of slackening the rate of supply would be to shorten the abscissas in Figs. VI. and VII., and proportionately to lengthen the perpendicular time-axis in the solid figure built on Fig. VII. This would obviously increase the volume of the solid that represents the total utility.

Such a figure would represent all the quantities with which we have to deal. Rate of supply on the axis of  $X$ , dimensions

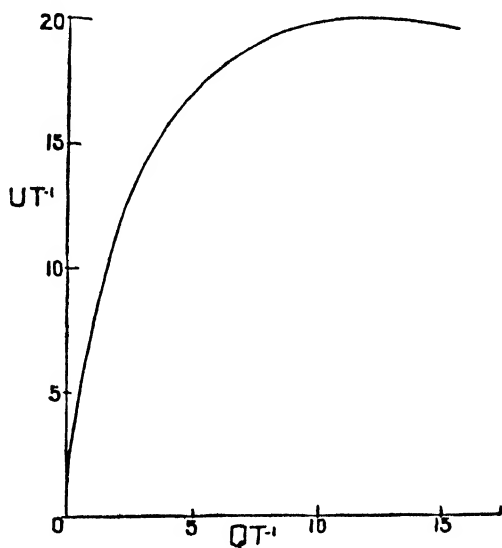

FIG. VI.

$QT^{-1}$ ; final degree of utility on axis of  $Y$ , dimensions  $UQ^{-1}$ ; time on perpendicular axis of  $Z$ , dimension  $T$ ; rate of enjoyment on area of plane figure, dimensions  $QT^{-1}UQ^{-1}$ , or  $UT^{-1}$ ; total enjoyment on volume of solid figure, dimensions  $QT^{-1}UQ^{-1}T$ , or  $U$ ; total supply on rectangle between axis of  $X$  and axis of  $Z$ , dimensions  $QT^{-1}T$ , or  $Q$ .

Of these quantities, the rate of supply and the final degree of utility are the most important, and these are the most easily read on the figure.

We have now considered the case of absolute quantity of

commodity yielding absolute quantity of enjoyment, and also the case of rate of supply of commodity yielding rate of enjoyment; but there is a third and equally important case, in which absolute quantity of commodity yields rate of enjoyment. Thus we are accustomed to think of furnished apartments as yielding so much advantage per week, month, or year, not as yielding a certain total advantage. The correctness, or at any rate the completeness, of this view may well be questioned, but in the case of imperishable articles, such as diamonds, it is difficult to regard the variable and function in any other light than that of absolute quantity and rate of advantage.

In the first place, then, we shall measure quantity of com-

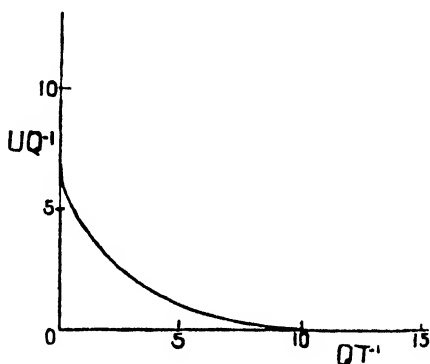

FIG. VII.

modity, as the variable, along the axis of  $X$ , with dimension  $Q$ , and rate of enjoyment, as the function along the axis of  $Y$ , with dimensions  $UT^{-1}$ . Differentiating, we shall get the rate at which increments of commodity are increasing the rate of enjoyment, as a function of  $q$  with dimensions  $UT^{-1}Q^{-1}$ . This is not final degree of utility (dimensions  $UQ^{-1}$ ), but a ratio between this quantity and time; and it is the measure, not of *value* and thence of *price*, but of *value-per-unit-of-time* and thence of *hire*.<sup>1</sup>

<sup>1</sup> Both price and hire to be understood as *per unit of commodity*. To establish a relation between hire and price, we must suppose the purchaser's estimate of distant enjoyment to be affected by uncertainty, or some other quality inherent in remoteness, in such a way as to make the successive anticipated yields of successive increments of time a convergent series. Price will then be the integral of  $dt$ . (hire), and will have the dimensions of hire and time; viz.  $UT^{-1}Q^{-1}T$ , or  $UQ^{-1}$ , as before.

Obviously the problem of interest, or hire of capital, must fall under this general case. Capital is a commodity and is measured in absolute units, whereas the advantage of capital is a periodic yield and is measured by a ratio between time and commodity. The peculiarity of the case is that here the advantage itself consists in the obtaining of commodity, so that the dimension  $U$  will itself be  $Q$ . Thus in the case of capital the dimensions of hire  $UT^{-1}Q^{-1}$  become  $QT^{-1}Q^{-1}$ , or  $T^{-1}$ . This must be the dimension of hire of capital (that is to say, of interest) considered as a rate; and we shall see presently that an independent investigation of the phenomena of interest leads to the same conclusion.

Jevons's objection to representing identical or similar quantities now by one and now by another kind of geometric quantity, and to introducing the same economic dimension upon two axes, leads him to criticise with quite needless severity, as I take it, Peacock's observations on the subject of interest (*Theory*, pp. 271 *sq.*), and further to undervalue his own diagrammatic representation of the phenomena in question, and to obscure his own results.

The problem may be attacked thus: Suppose an industrial concern in which a fixed amount of labour is employed to command  $c$  units of capital,  $c$  being variable. Obviously we may treat the capital as commodity, with the single dimension  $Q$ . Now consider the rate per unit of time at which that capital will wear out and disappear. We must suppose the stock always to be replaced as fast as it disappears, and may take  $\tau$  units of time (say years) as the period during which the whole will have been renewed. Measuring the annual wear not in percentage, but in absolute units of capital, we shall then have the annual wear equal to  $\frac{c}{\tau}$ , and its dimensions will be  $QT^{-1}$ . This quantity is a function of  $c$ . Probably  $\tau$  itself will vary according to the amount of  $c$ ; that is to say, the number of units in  $\tau$  will be a function of the number of units in  $c$ ; for we may suppose that for early increments of capital the annual wear will increase less than proportionately to the increase of the capital, but when the amount of capital becomes very large it will be difficult, with the fixed amount of labour at command, to look after it properly, and it will wear more rapidly. We may, however,

neglect this consideration and assume that  $\tau$  will be a constant, and  $y = \frac{c}{\tau}$ , the equation of a straight line. In Fig. VIII., then, the abscissas of points on the line  $OW$  might represent the quantity of capital, and the ordinates the amount of annual or other periodic wear, as a function of  $c$ . We have next to examine the productiveness of the capital; *i.e.* the number of units of commodity, per annum or other unit of time, which the use of the capital enables the fixed application of labour to produce. In estimating this we must subtract all the commodity which the capital actually consumes, such as coal, oil,

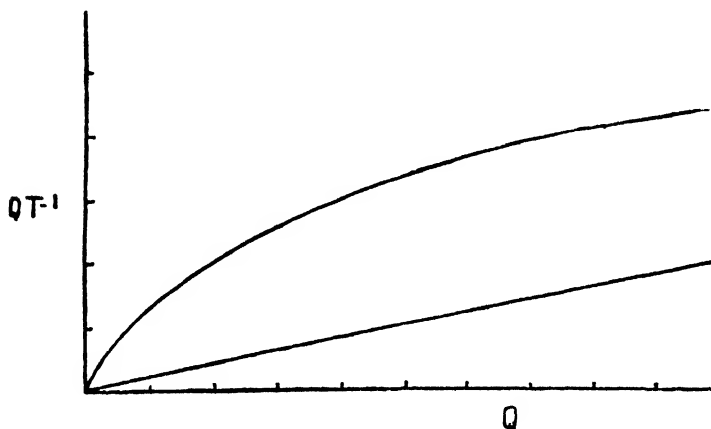

FIG. VIII.

etc. (supposing the capital to be in the shape of machinery).<sup>1</sup> We may take  $p$  as the amount of commodity which  $c$  enables the fixed application of labour to produce (over and above what  $c$  itself consumes) every year, or other period of time. Its dimensions will be  $QT^{-1}$ . Then  $p\tau$  will be total amount of commodity produced in the time  $\tau$  in virtue of the use of  $c$ . And if we put  $q$  for  $p\tau$  then the *annual* product, or  $p$ , may be written  $\frac{q}{\tau}$ . Its dimensions will be the same as those of  $\frac{c}{\tau}$ ; *viz.*  $QT^{-1}$ .

As the capital increases in amount, its annual yield,  $\frac{q}{\tau}$ ,

<sup>1</sup> I assume the existence of a common measure of all "commodities."



will at first increase rapidly, but after a time (the application of labour being fixed) increase in the amount of capital will but slightly increase the annual yield (since the labour is already supplied with its most urgently required aids), and at last, when the point has been reached at which the labour has all possible aids and is applied at the greatest possible advantage, further increments of capital will not increase the annual product at all. This quantity,  $\frac{q}{\tau}$ , having the same dimensions as  $\frac{c}{\tau}$ , may

be shown on the ordinates of the same figure. It is given, hypothetically, on the upper curve of Fig. VIII., as a function of  $c$ . This *gross* productiveness of  $c$ , as we have seen, reaches

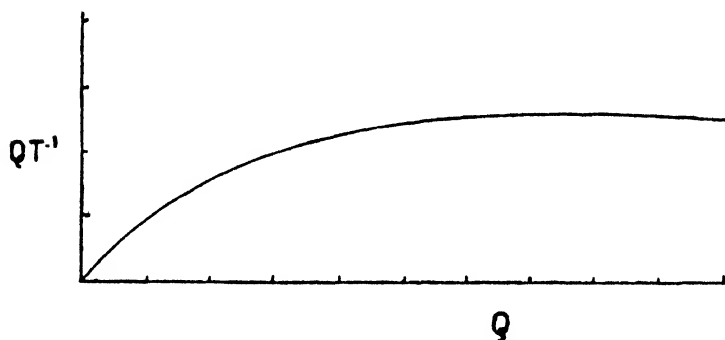

FIG. IX.

a maximum, or at any rate has a limit; but long before it reaches it, the *net* productiveness of  $c$  will have passed its maximum and will be tending to zero; for we must remember that as  $c$  increases, the annual waste of  $c$  also increases without limit, and since this annual waste must be made good, the *net* productiveness of  $c$  is represented by  $\frac{q}{\tau} - \frac{c}{\tau}$  (i.e. annual yield of capital minus annual waste of capital) in the figure the length of the intercept between the two curves. Now this quantity,  $\frac{q-c}{\tau}$ , is itself a function of  $c$ , and has the dimensions  $QT^{-1}$ . It is represented in Fig. IX.

If we now proceed to differentiate, to the variable  $c$ , we are in danger of having to deal with ordinates so small as to

defeat the object of diagrammatic illustration ; but this may be averted by the familiar artifice of lengthening the scale on the axis of *Y*. We will therefore represent the unit of *Q* by the same length as before on the axis of *X*, and by a length ten

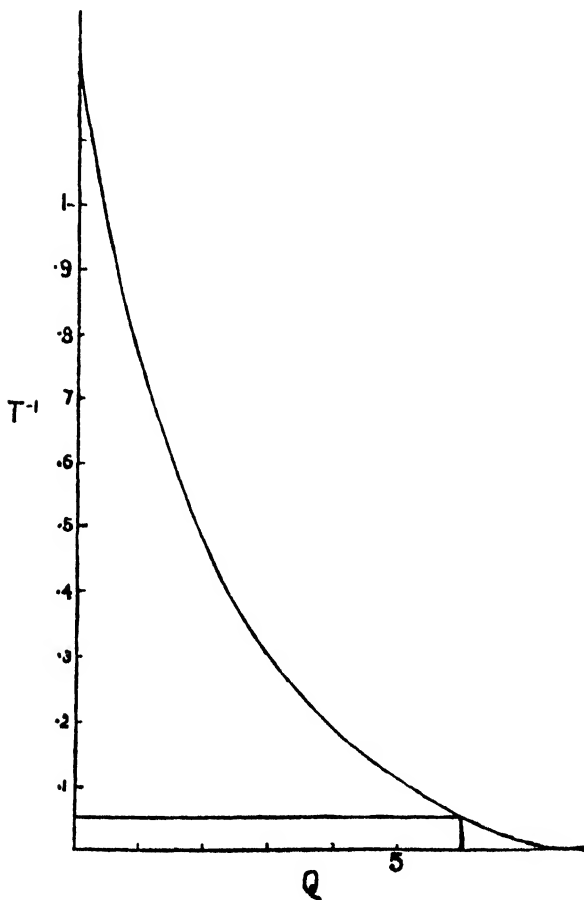

FIG. X.

times as great on the axis of *Y*. We shall then have a curve such as that of Fig. X., which will show us the *rate at which increments of capital are increasing the annual return made by the capital.*

Now we have seen that the rate of hire of anything follows

the ordinary laws of final degree of utility, and is determined by the rate of productiveness (in satisfaction or commodity) of the *last increment* of the thing hired. That is to say, if  $c$  is the quantity of capital, and  $f(c)$ , in Fig. IX., the net periodical productiveness of  $c$ , then  $f'(c)$ , in Fig. X., will be the *rate of hire* of capital; *i.e.* the *rate of interest*.

This quantity is a ratio between rate-of-supply-of-commodity (yield) and commodity (capital), and its dimensions therefore are  $QT^{-1}Q^{-1}$ , or  $T^{-1}$ ; and Jevons has shown, with great care and elaborateness, that  $T^{-1}$  is in truth the dimension of rate of interest (*Theory*, etc., pp. 268 *sq.*). In fact, the length of any ordinate in Fig. X. shows, in numerical units, without dimension, the *ratio* between the increase of the capital and the increase of the periodical yield or product. For  $x = 5\frac{1}{2}$  it is one-tenth, or ten per cent; for  $x = 6\frac{1}{2}$  it is one-twentieth, or five per cent. All that we need to know more is the *length of the period*, for which the periodic yield has been estimated. That is to say, the only dimension of rate of productiveness, or rate of interest, is  $T^{-1}$ . The numerical expression of a given rate of interest is only affected by a change in the unit of time, not by a change in the unit of commodity.

Proceeding, then, with the examination of Fig. X., we find that  $f'(c).c$  is the actual sum periodically paid as interest;

$\int_0^c f'(c).dc$ , or the total curvilinear area over  $c$ , the total net periodical yield of the given application of labour, backed by the quantity  $c$  of capital, and

$$\int_0^c f'(c).dc - f'(c).c,$$

or the curvilinear area over the rectangle of interest, the periodical return to the application of labour over and above the sum paid in interest. All these quantities have the dimensions  $QT^{-1}$ , and are periodical. To get the absolute sum of any one of them during a defined period  $\tau$ , we should have to multiply by  $\tau$  and reduce the dimensions to  $QT^{-1}T$ , or  $Q$ . This would involve a third axis, registering positively the dimension  $T$ , which appears negatively on the axis of  $Y$ . What are the grounds of Jevons's objection to this I have not been able to discover, and I am wholly unable to defend his position (cf. *Theory*, pp. 72 *sq.*).

If the view now set forth is correct, no great importance can be attached to the paragraph on pp. 266, 267 of the *Theory*, in which Jevons seeks a "general expression for the rate of interest." His fundamental hypothesis that the produce for the same amount of labour may reasonably be regarded as a continuous function of the time elapsing between the expenditure of the labour and the enjoyment of the result is not based upon a typical case of the use of capital, and in the cases to which it does apply it deals with derivative, not with primary facts and phenomena. The typical case of the use of capital is that in which the result is yielded continuously. All the great staple industries need a continuous renewal and expansion of capital, which capital, as it is invested, forthwith begins to yield a continuous product. This I take to be the primary and norm-giving fact. If, by way of exception, an investment of capital is proposed which will, after an interval, yield not a revenue, but an absolute utility; or if, as is extremely common, a gradual investment of capital is proposed, with the expectation that when the investment is complete the whole invested capital (in the shape of a ship or a machine, for instance) will be purchased by some one who has performed the process of integration indicated in the note on p. 747; or, lastly, if an immediate investment of capital is proposed in order that after an interval a periodic yield may be enjoyed by the investor,—in all these cases the investor has to consider what quantity of commodity he would command at the expiration of the given time, had he invested at first in one of the staple industries, and then continuously reinvested his continuously accruing return in the same industry again. If the proposed investment does not promise equal advantages, he will not enter upon it. Thus the basis of the estimate in every case of *deferred result* must be sought in the rate of *immediate yield* (cf. *Theory*, pp. 66-74, 90-91, 266-280).

In these notes I have made no attempt to carry the theory of capital and interest beyond the point at which Jevons left it. Very much remains to be done in this field, but my present object is only to clear away certain difficulties and rearrange the results already obtained, in order that the ground from which we are to advance may be better and more firmly occupied.

As an exercise we might trace the effect of any process which would make capital more durable. This would increase  $\tau$ , and so lower the curve of wear in Fig. VIII. But it probably would not lower the curve of productiveness, since it would increase the numerator as well as the denominator of the formula that gives the ordinate, and that, too, in something like the same proportion. Hence the ordinates of Fig. IX. will be lengthened, and so will those of Fig X. The immediate effect, therefore, if we could imagine the phenomenon taking place suddenly and simultaneously everywhere, would be to raise the rate of interest. But the increased net production would tend to increase accumulation, and so  $c$  would increase, and  $f(c)$  and  $f'(c)$  would decline again.

## ELEMENTARY MATHEMATICAL ECONOMICS

### 1.—DIMENSIONS OF ECONOMIC QUANTITIES <sup>1</sup>

A UNIT is a concrete magnitude selected as a standard by reference to which other magnitudes of the same kind may be compared. A derived unit is a unit determined with reference to some other unit. Thus the unit of area may be derived from the unit of length by being defined as the area of the square, erected on the unit of length. The unit of speed may be derived from the unit of length and the unit of time, by being defined as that speed at which the unit of length is traversed in the unit of time. In relation to the derived units of area and speed, the units of length and time would then be fundamental,—“fundamental” being a term correlative to “derived.”

The theory of dimensions is concerned with “the laws according to which derived units vary when fundamental units are changed” (Everett). A fundamental unit, together with the magnitudes of like kind referred to it, is regarded as having one dimension. Thus a length has the dimension L. The unit of length enters twice into the unit of area, first determining the base and then the altitude of the unit rectangle, and therefore the dimensions of an area are LL, usually written  $L^2$ . If we alter the unit of length, say from a foot to an inch (1 : 12), the unit of area will be reduced in the same ratio twice successively (1 : 144 in all). The variations of the unit of area, therefore, are directly as the squares of the variations in the unit of length. The units of length and of time enter once each into the unit of speed, but they do not enter on the same footing. If the unit of time be the minute, and the unit of length the foot, the unit of speed will be a foot per minute.

<sup>1</sup> [Reprinted from *Palgrave's Dictionary of Political Economy*, 2nd Ed., edited by Henry Higgs, Vol. I., pp. 583-585.]

This unit will become smaller if we make the unit of *length* smaller, since an inch per minute is a smaller speed than a foot per minute; but it will become larger if we make the unit of *time* smaller, a foot a second being a greater speed than a foot a minute. This is expressed by saying that the dimension of time  $T$  enters *negatively* into speed. The dimensions of speed, then, are expressed as  $LT^{-1}$ . A unit into which a dimension enters negatively is always a unit of rate, and measures amount of  $x$  per unit of  $y$ ,— $y$  being the quantity the dimension of which enters negatively.

We have now examined simple cases of the variations of derived *units*, but it is obvious that the *numerical values* of concrete magnitudes vary inversely as the units by reference to which they are estimated. The smaller the unit the greater the numerical value of any given magnitude. The numerical value of a magnitude, therefore, will vary inversely as the unit whose dimension enters into it positively, and directly as the unit whose dimension enters into it negatively. Thus, let the unit of speed (dimensions  $LT^{-1}$ ) be a foot per minute, and let the numerical value of a certain concrete speed be 10, *i.e.* let the speed be *ten* feet per minute. Then change the unit of length to an inch (1 : 12) and the unit of time to a second (1 : 60); the derived unit will now be an inch per second, and its relation to the former derived unit is obtained by altering directly in the ratio of 1 : 12 (dividing by 12) and inversely in the ratio of 1 : 60 (multiplying by 60), so that the new unit is five times as great as the old one, an inch per second being five times as great a speed as a foot per minute; but the numerical value of the concrete speed we had to express must be altered inversely as 1 : 12 and directly as 1 : 60, and is now only 2—*i.e.* the speed is *two* inches per second—or one-fifth of what it was before.

If we are measuring such a magnitude as feet of vertical motion per foot of horizontal motion in the path of a projectile, the dimensions will be  $LL^{-1}$  and will cancel each other. No change in the unit of length, then, will in any way affect the numerical value of this magnitude, and as no other dimension enters into it at all, it may be said to have no dimensions. Angular magnitudes, defined as ratios between arcs and radii, trigonometrical functions, and ratios generally are of this nature.

They have no selected units, and their numerical values are absolute.

When the elements of the theory of dimensions have been thoroughly grasped it will be easy to apply it to economic questions; and it will be found an invaluable check in the more intricate problems of co-ordination and analysis. Thus, if the unit of value-in-use or utility be taken as fundamental, and regarded as having the dimension  $U$ , and if the commodity we are considering be taken as having the dimension  $Q$ , then DEGREE OF UTILITY (*q.v.*) of the commodity, being the rate at which satisfaction is secured per unit of commodity consumed, will have dimensions  $UQ^{-1}$ , and will be readily distinguished from rate of enjoyment, accruing to the consumer, per unit of time, with dimensions  $UT^{-1}$ . Price, determined by marginal, or final, DEGREE OF UTILITY (*q.v.*), will have dimensions  $UQ^{-1}$  or  $P$ ; and hire, being price per unit of time, will obviously have dimensions  $PT^{-1}$  or  $UQ^{-1} T^{-1}$ . When the thing hired is money and is used commercially, the utility derived from it is a commodity of like nature with itself. The dimension  $U$  then becomes  $Q$ , and the dimensions of interest (as a rate) are  $QQ^{-1} T^{-1}$  or  $T^{-1}$ , which will be found on reflection and experiment to be correct.

The theory of dimensions should be applied to economics in close connection with the diagrammatic method. But of course the connection between dimensions, as now explained, and the geometrical dimensions of the diagrams is purely arbitrary. The physicist may, according to his convenience, represent the height of a projectile—a magnitude of one dimension—by a line, or by an area, and speed by a line or an inclination. So the economist may represent a magnitude measured by a complicated derived unit by a line, or a magnitude measured by a fundamental unit by an area or a solid; and if he keeps the theory of dimensions well before him he may vary his methods indefinitely without any danger of confusion. In all cases, however, the dimensions of those quantities represented by areas or solids will be compounded of the dimensions of those represented by the lines which determine them. Again, those who have any acquaintance with the elements of the calculus will see that if the equation of a curve be differentiated to  $x$ , then the area of the derived curve will have the same dimensions



as the ordinate of the fundamental curve; the ordinate of the derived curve will have the dimensions of the ordinates of the fundamental curve positively, and those of its abscissæ negatively; and the abscissæ of the two curves will have the same dimensions. In other words, differentiation introduces the dimensions of the variable to which we differentiate negatively, and integration introduces the dimensions of the variable to which we integrate positively.

By way of illustration take a figure, on the ordinate of which intensity of desire, or degree of utility, is represented, while supply of commodity per unit of time is measured on the abscissæ. Now imagine a third axis (of  $Z$ ) perpendicular to the page, along which time is measured. Such a figure will

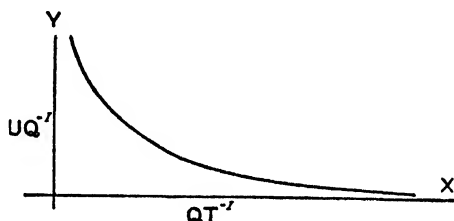

enable us to represent all the quantities we have to deal with in an ordinary problem of consumption. Rate of supply is represented on axis of  $X$ , dimensions  $QT^{-1}$ ; degree of utility on axis of  $Y$ , dimensions  $UQ^{-1}$ ; time on axis of  $Z$ , dimension  $T$ ; rate of enjoyment on areas parallel to plane of axes of  $X$  and  $Y$ , dimensions  $UQ^{-1} QT^{-1}$  or  $UT^{-1}$ ; total enjoyment on solid figure, dimensions  $UQ^{-1} QT^{-1} T$ , or  $U$ ; total supply on areas parallel to plane of axes of  $X$  and  $Z$ , dimensions  $QT^{-1} T$ , or  $Q$ , and in like manner price, hire, total sum paid, etc., may be read, and their dimensional relations seen at a glance.

[The theory of dimension was (according to Jevons, *Principles of Science*, 1887, p. 325) first clearly stated by Joseph Fourier. He expounded it with great lucidity in his *Théorie Analytique de la Chaleur*, 1822, §§ 159-162. An excellent popular statement of the theory, as it has since been elaborated, will be found in the beginning of Prof. J. D. Everett's *C.G.S. System of Units*, 1891. Jevons was the first to suggest the application of the theory to economics (*Theory of Political Economy*,

1888, pp. 232-252), but he unfortunately fell into some apparent errors and confusions which made the suggestion barren in his hands. A criticism of his treatment of the subject and an independent working-out of his suggestion by the writer of the present article will be found in the *American Quarterly Journal of Economics* for April 1889, pp. 297-314.]

## 2.—DEGREE OF UTILITY <sup>1</sup>

THIS phrase was first made current by Jevons in his *Theory of Political Economy*, 1871. Its precise significance will be best elucidated by an analogy. "Degree of utility" stands in the same relation to "total utility" as "velocity" to "space traversed." Suppose we have a body projected vertically upwards from rest, at a given speed. We may inquire *first* at what height the body will be found at any moment after its projection, and *second* at what rate it will be moving at any point of its course, and clearly the rate of its movement is the rate at which its height is increasing (whether positively as it rises, or negatively as it falls). This rate may be measured in feet per second, or in miles per hour, or in any other suitable unit, but in any case it varies from point to point and does not continue the same during any period, however short.

We must now extend the idea of measurement to such economic conceptions as "satisfaction" and "utility." Measurement consists essentially in determining the ratio of the magnitude investigated to some other magnitude adopted as a standard; and a "satisfaction" would accordingly be measured if we could determine its ratio to some standard satisfaction, or, which amounts to the same thing, some standard dissatisfaction. Thus if I wish to measure the satisfaction derived by a hungry man from the consumption of a certain quantity of bread, I may inquire how much labour he would perform, under stated conditions, rather than go without it; or what he would pay for it sooner than go without if an unscrupulous monopolist exacted from him the extreme famine price. Thus if we take any standard we choose we can, ideally at least, conceive of any concrete "utility" or "satisfaction" being measured in it. But we must remember that such measurements are based on the relative magnitudes of different satis-

<sup>1</sup> [*Op. cit.*, Vol. I., pp. 536-537.]

factions, etc., to one and the same person, and do not profess to give us means of comparing a satisfaction experienced by one mind with a satisfaction experienced by another; for no one can say that the standard unit of satisfaction selected means the same thing to two different men. Nor shall we find that any such absolute measurement is needed for the purpose in hand.

Having premised so much, we may now work out the economic analogue of the projected body. Suppose we take such a commodity as bread supplied to a hungry man. *Firstly*, we may inquire what amount of satisfaction the man has derived from the consumption of any given quantity of bread; in which case we shall be investigating the "total utility" or "value in use" of that quantity of bread, to that man, under those conditions. *Secondly*, we may inquire at what *rate* (per ounce, per pound, etc.) the consumption of the bread is conferring satisfaction upon the man at any point in the course of his meal; and in that case we shall be investigating the "degree of utility" of the bread. This "degree of utility" will of course vary from point to point. When the man was at his hungriest he would be deriving relatively great satisfaction per ounce of bread consumed, and towards the end of his meal, when nearly satisfied, his satisfaction per ounce would be relatively small; and, theoretically, it will not remain constant during any period, however short. Now this "degree of utility" is obviously the rate at which the "total utility" is increasing; just as the velocity of a rising or falling body is the rate at which "space traversed" or "height" is increasing.

The precise relation of velocity to space traversed, and of degree of utility to total utility, is expressed mathematically by saying that the former are the "differential coefficients," "first-derived functions," or "fluxions" of the latter; and, graphically, if the latter are expressed by areas the former will be expressed by lines. In the figure, if we imagine the line  $cd$  moving from  $O$  in the direction of the arrow-head, at a uniform rate, to represent the lapse of time, and if we imagine the area  $aOcd$  to represent the space traversed by the projected body in the time  $Oc$ , then the intercept  $cd$  will be the differential coefficient of  $aOcd$ , and will represent the velocity of the body, or rate at which it is rising, at the point of time

represented by  $c$ . Perhaps this will be sufficiently obvious to the non-mathematical reader if he reflects that velocity represents the rate at which height is increasing, as time lapses, and observes that the length of the intercept  $c d$  likewise determines the rate at which the area  $a O c d$  increases as the vertical line moves in the direction of the arrow-head.

Now let the movement of the vertical from  $O$  represent the consumption of the bread, so that  $O c$  represents the amount consumed up to any given point of the meal; and let  $a O c d$  represent the total satisfaction derived from the consumption up to the point reached, then  $c d$  will still be the differential coefficient of  $a O c d$ , and will represent the rate per unit (ounce, etc.) at which the consumption of the bread is now increasing the total satisfaction reaped by the consumer. That is to say

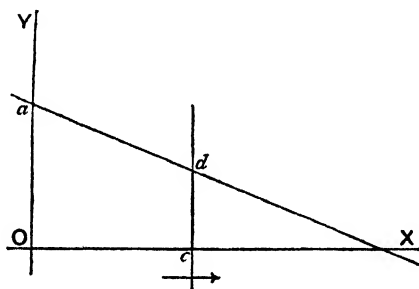

$c d$  represents the degree of utility of bread at the point  $c$ , the amount represented by  $O c$  having already been consumed.

It should be observed, however, that when we are dealing with economic quantities, the line  $a d$  will probably never be a straight line, but always a curve of more or less complexity; and it will seldom or never be possible to determine its actual form with any precision.

The main interest naturally attaches to the degree of utility of that increment of a commodity which the consumer expects to obtain next, or which he may have to relinquish, that is to say the last increment he has secured or the next he hopes to secure. This is called by Jevons the "final degree of utility" (*q.v.*). Under this heading, FINAL DEGREE OF UTILITY, references to the most important books on the subject will be found. All that need be said here is that the analogy of the moving

body insisted on above was developed by Professor Léon WALRAS of Lausanne, and was first suggested by his father, A. A. WALRAS (see FINAL DEGREE OF UTILITY).

### 3.—FINAL DEGREE OF UTILITY <sup>1</sup>

FINAL DEGREE OF UTILITY is the expression used by Jevons for the DEGREE OF UTILITY (*q.v.*) of the last increment of any commodity secured, or the next increment expected or desired. The increments being regarded as infinitesimal, the degree of utility is not supposed to vary from the last possessed to the next expected. It will be obvious, after a study of the article on DEGREE OF UTILITY, that it is the *final* degree of utility of various commodities that interests us commercially, not, for instance, their initial or average degrees of utility. That is to say (Fig. 1), if  $a$  is a small unit of the commodity  $A$ , and  $b$  a small unit of the commodity  $B$ , and  $q_a$  the quantity of  $A$  I possess, and  $q_b$  the quantity of  $B$  I possess, then, in considering the equivalence of  $a$  and  $b$  I do not ask whether  $A$  or  $B$  has the greater initial degree of utility, *i.e.* I do not compare the lines  $Oa$  and  $Ob$ , nor do I inquire which has the greater average degree of utility, *i.e.* I do not compare the height of the rectangle on base  $Ox$  which shall equal the area  $aOxa'$ , with the height of the rectangle on base  $Oy$  which shall equal the area  $bOyb'$ , but I compare the length  $xa'$  with the length  $yb'$ , and ask what are the relative rates at which increments of  $A$  and  $B$  will *now add* to my satisfaction. If  $xa'$  is twice the length of  $yb'$ , then (since  $a$  and  $b$  are supposed to be small units, throughout the consumption of which the decline in the curves  $aa'$ ,  $bb'$  may be neglected) it is obvious that  $2b$  will be equivalent to  $a$ , since either increment will yield an equal area of satisfaction.

Now suppose (Fig. 2) that some other possessor of the commodities  $A$  and  $B$ , either because he possesses them in different proportions, or because his tastes and wants are different, finds that the relative final utilities of the small units  $a$  and  $b$  are not the same for him (2) as they are for me (1). Say that for him  $3b$  is the equivalent of  $a$ , clearly the conditions for a mutually advantageous exchange exist. Let  $\delta$  be greater than 2 and less than 3, so that  $\delta - 2$  and  $3 - \delta$  are both positive. Now suppose (1) exchanges with (2), giving him  $a$  and receiving

<sup>1</sup> [*Op. cit.*, Vol. II., pp. 59-61.]

from him  $\delta b$ . Then, (1) receives  $\delta b$  in exchange for  $a$  (worth  $2b$  to him) and benefits to the extent of  $(\delta - 2) b$ , and by the same transaction (2) has received  $a$  (worth  $3b$  to him) in exchange for  $\delta b$ , and has benefited to the extent of  $(3 - \delta) b$ . The result of this exchange will be a movement of all the verticals that indicate the amount of each commodity possessed by each exchanger, in the directions indicated by the arrow-heads ; and

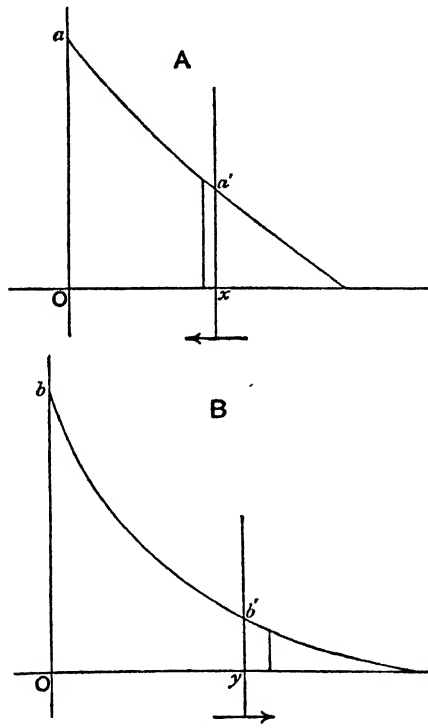

FIG. 1.

this again will (as is obvious from inspection of the figures) tend to reduce the difference between the ratio of equivalence between  $a$  and  $b$  in the case of the two exchangers. The process of exchange will go on ( $\delta$  not necessarily remaining constant) until the ratio of equivalence between  $a$  and  $b$  coincides for the two exchangers, the last exchange bringing about an equilibrium in accordance with that ratio. Such a ratio of equilibrium is a

limiting ratio of exchange ; that is to say, exchange constantly tends to approach such a ratio, perhaps by a series of tentative exchanges at various rates, and would cease were such a ratio actually arrived at.

Hence Jevons's fundamental theorem : " The ratio of exchange of any two commodities will be the reciprocal of the ratio of the final degrees of utility of the quantities of commodities

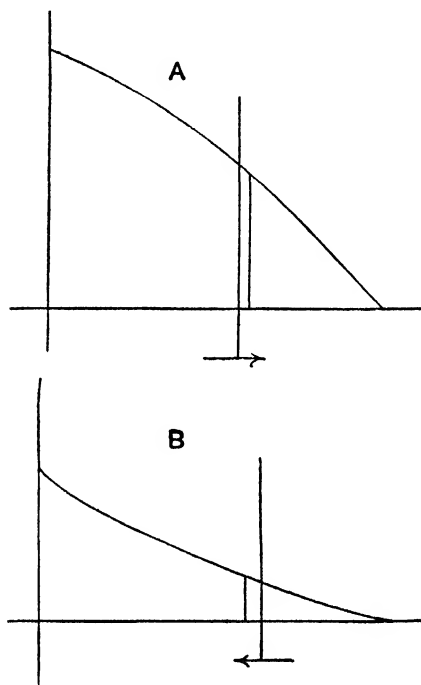

FIG. 2.

available for consumption after the exchange is completed," applies to an ideal ratio which would secure equilibrium at a stroke, rather than to the tentative bargains by which it is approached in the "actual market."

For the precise mathematical relation between final degree of utility and utility in use, see articles DEGREE OF UTILITY ; EXCHANGE, VALUE IN ; and UTILITY (*q.v.*)—the former being the differential coefficient of the latter.

The conceptions of "degree of utility" and "final degree

of utility" lie at the heart of the mathematical method of political economy, and their complete history would almost coincide with the history of mathematical economics. Incidentally the idea has been struck from time to time by sundry mathematicians, and it has been worked out independently by economists no fewer than four or five times. COURNOT (1838), DUPUIT (1844), GOSSEN (1858), and JEVONS (1862 and 1871) successively discovered and taught the theory, each one in ignorance of the work of his predecessors. In 1871 the Austrian Menger, and in 1874 the Swiss Walras (working on the basis laid down by Cournot), adopted essentially the same central conception, and since then the theory has not again sunk into oblivion. Many writers in Germany, Holland, Denmark, France, Italy, and England are now engaged in developing it. See the bibliographies and lists of writers in the appendix to Jevons's *Theory of Political Economy*, 3rd ed., and the Preface to Walras's *Théorie de la Monnaie*, 1886; and for far-reaching recent developments in America, England, and France, see Appendix.

[Jevons's "final degree of utility" is the *Grenznutzen* of the Austrian school, Gossen's *Werth der letzten Atome*, and Walras's *rareté*.]



## POLITICAL ECONOMY AND PSYCHOLOGY <sup>1</sup>

IF political economy is the science of wealth, then it deals with efforts made by man to supply wants and satisfy desires. "Want," "effort," "desire," "satisfaction," are each and all psychic phenomena.

It would therefore appear that psychology must be to political economy—like the deity of Boethius—"path, motive, guide, original, and end."

Yet it is obvious that the political economist as such is not engaged in the establishment of the ultimate principles of psychology. He has not, for example, to investigate the nature of a concept, or determine the relation of the Will to the Reason. So far it is clearly true (cp. Keynes, *Scope and Method of Political Economy*, pp. 87, 88) that although the laws of the political economist "rest ultimately upon a psychological basis," he accepts psychological principles as his data rather than establishes them as his conclusions; unless indeed he should be compelled to make excursions into the psychological field proper, because he does not find his premises sufficiently elaborated to his hand.

But this does not justify the reduction of the psychological factor of political economy to a level with the physical factor. Cairnes indeed (*Logical Method of Political Economy*, 2nd ed., pp. 37 and 38, quoted and apparently endorsed by Keynes, p. 85) instances the law of rent, and maintains that, in establishing this law, the economist no more undertakes to analyse the motives of self-interest which dictate the conduct of the landlord and the tenant than he undertakes to analyse the physical qualities of the soil which determine the law of decreasing returns. Now this is very true. The economist

<sup>1</sup> [Reprinted from *Palgrave's Dictionary of Political Economy*, 2nd Ed., edited by Henry Higgs, Vol. III., pp. 140-142.]

starts with both psychological and physical data, which he need not analyse, provided he has satisfied himself that they are true. But the difference is this, that whereas his *data* are partly physical and partly psychical, his *quæsitæ* are, in the last resort, wholly psychical. For if the law of rent is anything, it is a formulating of the principles which we may expect to regulate the *conduct* of men, secured in certain possessions and privileges, actuated by certain motives, and in the presence of certain physical facts and laws. The laws of political economy then, being ultimately laws of human conduct, are psychical and not physical; and therefore psychology enters into political economy on something more than equal terms with physical science and technology.

It therefore seems clear that, although the economist, as such, is not concerned with the ultimate analysis of his psychological data, his *quæsitæ* or conclusions are themselves of the order of psychic phenomena. But within the limits thus laid down there is still ample room for diversity of opinion. It may be contended that the economist has to receive, and test, his psychological and physical data alike, to deal with them by the universal methods of dialectic (*i.e.* inductive and deductive logic, or mathematics, if applicable), and then hand over his psychological results to the sociologist. Or it may be argued that political economy is largely, or even prevaingly, *applied psychology*, so that the economist must from first to last realise that he is dealing with psychological phenomena, and must be guided throughout by psychological considerations. In that case the relation of psychology to economics will be as close as that of mathematics to mechanics, though not in all respects analogous to it.

It is easy to see that the controversy as to the inclusion or exclusion of CONSUMPTION as a separate and acknowledged division of political economy has a decisive bearing upon this question. The whole theoretic study of consumption can be little else than the application of the great psychological law of diminishing returns of satisfaction or relief to successive increments of commodity or service supplied to the same subject. To admit "consumption" then as a branch of political economy is to admit that applied psychology has its conspicuous place in the science. So that if we are justified in say-

ing that the express study of "consumption" has now been definitively admitted as within the scope of political economy, we are thereby admitting psychological method, as well as psychological data and conclusions, as a part of the science; and the importance of dealing thus expressly with consumption and the psychological phenomena on which this branch of this study rests may be well shown by typical popular fallacies. For instance, there was no more common application of political economy a few decades back than the dictum that "what people want they will pay for," and that therefore all subsidising is a waste of effort, and is "against political economy." Here the datum is that if *one and the same man* wants *A* as much as he wants *B*, he will be willing to give as much for it, sooner than go without it. From this datum certain conclusions as to market values and the commercially wise direction of efforts and resources are reduced, and these in their turn are reinterpreted into the statement that if *one* of two men is unwilling to give as much for *A* as *the other* is willing to give for *B*, then the first man does not want *A* as much as the second wants *B*, and it would be a wasteful and mistaken philanthropy to supply No. 1 with *A* rather than No. 2 with *B*. Of course no economist would formulate such an absurdity, but if the economists exclude consumption from express and psychological treatment, they leave room for and almost invite such "applications."

So much then for "consumption." But EXCHANGE is so closely connected with consumption, and the laws of value are now seen to be so intimately dependent upon the psychological law of diminishing returns of satisfaction, that it must be impossible henceforth to exclude applied psychology from the problems of value and of exchange.

An excellent illustration is furnished by the problems of the currency. Of all branches of economic inquiry those that are concerned with MONEY and with FOREIGN EXCHANGES seem most nearly to approach the objectivity of natural phenomena; and what is known as the QUANTITY THEORY has been cited as a proof case of an economic law which is not psychological. But the truth is that no single step can be safely made in monetary science, unless the investigator keeps himself in conscious touch with his psychological basis during his whole

investigation. We cannot, without special examination, even say that, in virtue of the universal law of supply and demand, the more sovereigns there are the lower will be their exchange value. For in this universal law of supply and demand there is a psychological link. Why does an increased supply lower exchange value? Because an increased supply of any commodity satisfies the corresponding want more completely, and reduces the unsatisfied remaining want to a lower degree of importunity. Now in the case of money it is admitted that within wide limits the money function is exactly as well performed by  $x$  and by  $nx$  pieces, so that there is no unperformed money function and money want becoming less and less importunate for satisfaction as the number of sovereigns, but not the command of commodities in general, increases. Thus, if the law of demand and supply is regarded as objective and absolute, and the psychological link forgotten, its applications to monetary problems will have no demonstrative cogency.

We now turn to PRODUCTION and DISTRIBUTION, and here we note at once that the study of "production" must include the theory of labour, in which everything turns upon the law of the increasing irksomeness of successive increments of effort and the decreasing psychological value of successive increments of commodity, or other result of effort; and the same law invades the study of distribution at every point, allying itself with the better-known physical law of diminishing returns to successive increments of any one factor of production, the others remaining constant.

In all the four main divisions of political economy, then, we see that the direction taken by economic study in recent years tends to a more express and generous recognition of the close connection between psychology and political economy, and the necessity of constantly keeping in touch with our psychological basis even when pursuing those branches of economic inquiry which appear to be remotest from it.

But, especially in connection with "production" and "distribution," another aspect of the question forces itself on our attention. We have hitherto enquired whether the psychological data of economics can be accepted absolutely as results and dealt with by general dialectic methods, or whether they can only be considered as principles, to be applied with constant

reference to the psychological conditions of the special problem under investigation. We have now to ask further, are these psychological data, whether facts or principles, to include all the psychological considerations that actually bear upon the production, distribution, etc., of wealth, or are we artificially to simplify our psychology and deal only with the motives supposed to actuate the hypothetical "economic man"? In the latter case political economy will be a hypothetical science. In the former it will aim at positivity.

And here again it will hardly be doubted that the tendency of recent work has been in the direction of enlarging the psychological area from which the data of political economy should be drawn. This tendency is manifested in two characteristic movements in recent economic investigation, which have in their turn reacted upon it. Firstly, the field of economic study, like so many others, has been invaded by the passion for the concrete method of inquiry, whether applied to contemporary or remote conditions. Now the man who studies the history of a great strike or trade movement in Europe or America, of the land tenure or village industries of India, of middle-class or artisan budgets in England or France, of the growth and organisation of industry in the Hanseatic cities or the republics of Italy, of the fiscal systems of commercially related peoples, and so forth, finds himself studying the conditions of the production and distribution of wealth, but in a region in which the simplified psychology of Ricardo and Senior is wholly inadequate. So conspicuously is this the case that some economists are ready to admit that no general theory or science of economics is possible, but only a natural history of wealth, production, etc., while others are seeking to reconstruct the general theory of economics on broader and more universally applicable principles. And it is here that the second movement characteristic of recent times allies itself with the historical method. It is the much-discussed mathematical method, which from this point of view is the necessary complement of the historical or concrete method. For no sooner has the mathematical student given to the acknowledged psychological data of economics the form, at once rigorous and generalised, that his method demands, than he perceives that his formulæ really embrace the general theory

of the distribution of resources with a view to maximising a desired result, independently of the nature alike of the resources and the result in question. This brings the economic conduct of man under the same laws as his conduct in general, and promises to give us the wider basis of which we are in search.

Our conclusions throw a curious light on the much-debated but little-understood contention of Auguste Comte, *Phil. Pos.*, Vol. IV., pp. 193 *et sq.*, that there is no specific science of wealth, with its special laws and principles, and that the attempt to deal with the wealth-getting impulses of man in isolation must be essentially barren; but that special applications of general principles of philosophy to the industrial and commercial life may be prolific and illuminating in a high degree.

## THE SCOPE AND METHOD OF POLITICAL ECONOMY IN THE LIGHT OF THE "MARGINAL" THEORY OF VALUE AND DISTRIBUTION <sup>1</sup>

### I.

I ADDRESS myself primarily to those who already accept the marginal theory of Value and Distribution, inviting their attention to the modifications it is already introducing into current conceptions of Political Economy and of its relation to other studies, and urging the necessity of accepting the change more frankly and pressing it further. But at the same time I think we shall find that the best approach to our proper subject is through a summary exposition, if not a defence, of the theory itself.

Let us begin by attempting to determine the characteristic of the economic field of investigation. Naturally there is no sharp line that marks off the economic life, and we must not expect to arrive at any rigid definition of it; but I take it that if I am doing a thing because I want it done for its own sake (not necessarily *my* own sake, in any restricted sense, for it may primarily concern some one else in whom I am interested out of pure goodwill), or am making a thing that I require for the supply of my own desires or the accomplishment of my own purposes; if, in fact, I am engaged in the direct pursuit of my own purposes, or expression of my own impulses, my action is not economic. But if I am making or doing anything not because I have any direct interest in it, but because some one else wants it, and that other person will either do what I want done or put me in command of it, then I am furthering his purposes as a means of furthering my own. I am indirectly

<sup>1</sup> [Reprinted from *The Economic Journal*, Vol. XXIV., No. 93, London, March 1914, pp. 1-23. Presidential Address to Section F of the British Association, Birmingham, 1913.]

forwarding my purposes by directly forwarding his. This is the nature of the economic relation, and the mechanism or articulation of the whole complex of such economic relations is the proper subject of economic investigation. Thus, if a peasant adorns his ox-yoke with carving because he likes doing it and likes it when done, or if he carves a stool for his friend because he loves him and likes doing it for him and believes he will like it when done, the action is not economic ; but if he gets a reputation for carving and other peasants want his work, he may become a professional carver and may carve a yoke or a stool because other people want them and he finds that supplying their wants is the easiest way for him to get food and clothes and leisure for his own art, and all things else that he desires. His artistic work now puts him into an economic relation with his fellows ; but this example serves to remind us that there may be an indefinite area of coincidence between the economic and non-economic aspects of a man's occupations and relations. That man is happy indeed who finds that in expressing some part of his nature he is providing for all his natural wants ; or that in rendering services to friends in which he delights he is putting himself in command of all the services he himself needs for the accomplishment of his own purposes. A perfect coincidence of this nature is the dream of modern Utopias ; but my present subject is only the economic side of the shield.

The economic organism, then, of an industrial society represents the instrumentality whereby every man, by doing what he can for some of his fellows, gets what he wants from others. It is true, of course, that those for whom he makes or does something *may* be the same as those from whom he gets the particular things he wants. But this is not usual. In such a society as ours the persons whom a man serves are usually incapable of serving him in the way he desires, but they can put him in command of the services he requires, though they cannot render them. This is accomplished by the instrumentality of money, which is a generalised command of the services and commodities in the circle of exchange ; " money " being at once a standard in which all market prices are expressed, and a universal commodity which every one who wishes to exchange what he has for what he wants will accept as a medium, or middle term, by which to effect the transformation. Thus



in most commercial transactions one party furthers a specific purpose of the other, and receives in exchange a command, defined in amount but not in kind, of services and commodities in general; the scale of equivalence being a publicly recognised thing announced in current market prices. Every member of the community who stands in economic relations with others alternately generalises his special resources and then specialises his general resources, first directly furthering some one else's purposes and then picking out the persons who can directly further his. Thus each of us puts in what he has at one point of the circle of exchange and takes out what he wants at another. Being out of work is being unable to find any one who values our special service enough to relinquish in our favour such a command of services in general as we are prepared to accept in return.

Our economic relations, therefore, are built up on a recognised scale of equivalences amongst the various commodities and services in the circle of exchange; or, in other words, upon market values. And our first step must be to formulate the "marginal" theory of exchange, or market, values. It is capable of very easy and precise formulation in mathematical language; for it simply regards value in exchange as the first derived or "differential" function of value in use; which is as much as to say, in ordinary language, that what a man will give for anything sooner than go without it is determined by a comparison of the *difference* which he conceives its possession will make to him, compared with the difference that anything he gives for it or could have had instead of it will or would make; and, further, that we are generally considering in our private budgets, and almost always in our general speculations, not the significance of a total supply of any commodity—coals, bread, or clothes, for instance—but the significance of the difference between, say, a good and a very good wheat harvest to the public, or the difference between ten and eleven loaves of bread per week to our own family, or perhaps between ten days and a fortnight spent at the seaside. In short, when we are considering whether we will contract or enlarge our expenditure upon this or that object, we are normally engaged in considering the difference to our satisfaction which differences of adjustment in our several supplies will make. We are normally engaged, then, not in the consideration of totals, either of supplies

or of satisfactions, but of differences of satisfaction dependent upon differences of supplies.

According to this theory, then, what I am *willing* to give for an increase in my supply of anything is determined by the difference it will make to my satisfaction, but what I shall *have* to give for it is determined by the difference it would make to the satisfaction of certain other people; for if there is anyone to whom it will make more difference than it will to me, he will be ready to give more for it, and he will get it, while I go without. But again, since the more he has the less difference will a still further increase make to him, and the less I have the more difference will a still further decrease make to me, we shall ultimately arrive at an equilibrium; what I am willing to give and what I am compelled to give will coincide, and the difference that a little more or a little less of any commodity which I habitually consume makes to my estimated satisfaction will be identical with a similar estimated difference to any other habitual consumer.

Or we may attack the problem from the point of view of the individual. We have pointed out that to any individual the differential significance of a unit of supply of any commodity or service declines as the supply increases. In our own expenditure, we find that current prices (our individual reaction on the market being insensible) fix the terms on which the various alternatives offered by the whole range of commodities and services in the circle of exchange are open to us. Obviously, so long as the differential satisfaction anticipated from one purchase exceeds that which the same money would procure from another, we shall take the preferable alternative (thereby reducing its differential superiority) until we have so regulated our expanding or contracting supplies that the differential satisfactions gained or lost from a given small increase or decrease of expenditure upon any one of our different objects of interest is identical. Into the practical difficulties that prevent our ever actually reaching this ideal equilibrium of expenditure I will not here enter; but I must call attention to the identity in principle of this analysis of the internal economy of our own choice between alternatives, tending to a subjective equilibrium between the differential significances of different supplies to the same person, and the corresponding analysis, just given, of the

process by which an objective equilibrium is approached between the differential significances of the same supplies to different persons.

And this observation introduces another of extreme importance. In our private administration of resources we are concerned both with things that are and with things that are not in the circle of exchange, and the principle of distribution of resources is identical in both cases. The independent student who is apportioning his time and energy between pursuing his own line of research and keeping abreast of the literature of his subject is forming estimates of differential significances and is equating them to each other just as directly as the housewife who is hesitating between two stalls in the market. And when we are considering whether we will live in the country or the town, we may find, on examination, that we are carefully equating increments and decrements of such apparently heterogeneous indulgences as those associated with fresh eggs and friendship. Or, more generally, the inner core of our life problems and the gratification of all our ultimate desires (which are indeed inextricably interlaced with our command of exchangeable things, but are the ends to which the others are but means) obey the same all-permeating law. Virtue, wisdom, sagacity, prudence, success, imply different schemes of values, but they all submit to the law formulated by Aristotle with reference to virtue, and analysed by modern writers with reference to business, for they all consist in combining factors *κατ' ὀρθὸν λόγον*, in the right proportion, as fixed by that distribution of resources which establishes the equilibrium of their differential significances in securing the object contemplated, whether that object be tranquillity of mind, the indulgence of an overmastering passion or affection, the command of things and services in the circle of exchange, or a combination of all these, or of any other conceivable factors of life.

Now this dominating and universal principle of the distribution of resources, as we have seen, tends, by the instrumentality of the market, to secure an identity in the relative positions of increments of all exchangeable things upon the scales of all the members of the community amongst whom they are distributed. For if, amongst the things he possesses, A finds one, a given decrement in which would make less difference to him, as

measured in increments of other exchangeable things, than the corresponding increment would make to *B* (who is assumed to have a certain command of exchangeable things in general), obviously there is a mutual gain in *B* giving for the increment in question what is less than worth it to him but more than worth it to *A*. There is equilibrium therefore only when a decrement in any man's stock of any exchangeable thing would make more difference to him, as measured in other exchangeable things, than the corresponding increment (measured in the same terms) would make to any one else. Hence all those who possess anything must, in equilibrium, value it more, differentially or incrementally, than any one who does not possess it, provided that this latter does possess something, and provided that "value" is measured in exchangeable things.

But this last qualification is all-important. The market tends to establish an identity of the place of the differential value of any commodity amongst all exchangeable things on everybody's scale of preferences, and further to secure that it is higher on the scale of every one that has it than on the scale of any one who has it not; so that to that extent, and in that sense, things must always tend to go and to stay where they are most significant. But then exchangeable things are never really the ultimately significant things at all. They are means. The ends, which are always subjective experiences of some kind, whether of the senses or the will or the emotions, are not in any direct way exchangeable; and there is no machinery to secure that increments and decrements of exchangeable things shall in industrial equilibrium take the same place and have the same differential significance on the scales of any two men when measured not in terms of other means, but in terms of ends. If two men habitually spend a portion of their resources on food and on books, there is a presumption that to both of them the differential significance of a shilling's-worth of food and of a volume of *Everyman's* or the *Home University Library* is equivalent. But there is no presumption whatever that the vital significance of either one or the other is identical to the two men as measured, not each in terms of the other, but each in the degree to which it ministers to the ultimate purposes of its possessor or consumer; in the pain that its absence or the pleasure that its presence would give him; or in its ultimate

significance upon his life. Granted that  $x$  makes just as much difference, both to you and to me, as  $y$  does, it does not follow that either  $x$  or  $y$  makes the same difference to you that it does to me.

The ground is now clear for a step forward along the main line of our advance. The differential theory of exchange values carries with it a corresponding theory of distribution, whether we use this term in its technical sense of the division of a product amongst the factors that combine for its production, or whether we employ it as equivalent to "administration," and are thinking of the administration of our personal resources; that is to say, their distribution amongst the various objects that appeal to us; or again, the distribution, under economic pressures, of the sum of the industrial resources of a society amongst the objects that appeal to its members.

Land, manifold apparatus, various specialised faculties of hand, eye, and brain, are essential, let us say, to the production of some commodity valued by some one (it does not matter whom), for some purpose (it does not matter what). None of these heterogeneous factors can be dispensed with, and therefore the product in its totality is dependent upon the co-operation of each one severally. But there is room for wide variety in the proportions in which they are combined, and whatever the existing proportion may be each factor has a differential significance, and all these differential significances can be expressed in a common unit; that is to say, all can be expressed in terms of each other, by noting the increment or decrement of any one that would be the equivalent of a given decrement or increment of any other; equivalence being measured by the neutralising of the effect upon the product, or rather, not upon the material product itself, but the command of generalised resources in the circle of exchange for the sake of which it is produced. The manager of a business is constantly engaged in considering, for instance, how much labour such-and-such a machine would save; how much raw material a man of such-and-such character would save; what equivalent an expansion or reconstruction of his premises would yield in ease and smoothness in the conduct of business; how much economy in the shop would be effected by a given addition to the staff in the office, and so on. This is considering differential significances and their

equivalences as they affect his business. And all the time he is also considering the prices at which he can obtain these several factors, dependent upon their differential significances to other people in other businesses. His skill consists, like that of the housewife in the market, in expanding and contracting his expenditure on the several factors of production so as to bring their differential significances to himself into coincidence with their market prices. And note that the same principle can be applied without any difficulty to such immaterial factors of efficiency as "goodwill" or notoriety; but it would delay us too long to work this out or to anticipate possible objections. A hint must suffice.

Here, then, we have a firm theoretical basis for the study of distribution, independent of the particular form of organisation of a business. Whether those in command of the several factors of production meet and discuss the principles upon which the actual proceeds of the business shall be divided, when they are realised; or whether some one person takes the risks (on his own behalf or on behalf of a group of others), and discounts the estimated significance of the several factors, buying up their several interests in the product, by paying wages and salaries, interest, and rent, and by purchasing machinery and raw material, and so forth; or whatever other mechanism may be adopted, the underlying principle is the same. The differential equivalence of the factors of production reduces them to a common measure, and when they are all expressed in the same unit the problem of the division of the product amongst them is solved in principle.

Now I conceive that the application of this differential method to economics must tend to enlarge and to harmonise our conception of the scope of the study, and to keep it in constant touch with the wider ethical, social, and sociological problems and aspirations from which it must always draw its inspiration and derive its interest; for if we really understand and accept the principle of differential significances we shall realise, as already pointed out, that Aristotle's system of ethics and our reconstructed system of economics are twin applications of one identical principle or law, and that our conduct in business is but a phase or part of our conduct in life, both being determined by our sense, such as it is, of differential significances and their changing weights as the integrals of which they are the differences

expand or contract. Cæsar, "that day he overcame the Nervii," being surprised by the enemy, contracted his exhortation to the troops, but did not omit it. In his distribution of the time at his disposal the differential significance of prompt movement was higher than usual in relation to the differential significance of stirring words from their beloved and trusted commander addressed to the soldiers as they entered upon action. An ardent lover may decline a business interview in order to keep an appointment with his lady-love, but there will be a point at which its estimated bearing upon his prospects of an early settlement will make him break his appointment with the lady in favour of the business interview. A man of leisure with a taste for literature and a taste for gardening will have to apportion time, money, and attention between them, and consciously or unconsciously will balance against each other the differential significances involved. All these, therefore, are making selections and choosing between alternatives on precisely the same principle and under precisely the same law as those which dominate the transactions of the housewife in the market, or the management of a great factory or ironworks, or the business of a bill-broker.

A full realisation of this will produce two effects. In the first place, it will put an end to all attempts to find "laws" proper to our conduct in economic relations. There are none. Hitherto economists for the most part have been vaguely conscious that the ultimate laws of economic conduct must be psychological, and, feeling the necessity of determining some defining boundaries of their study, have sought to make a selection of the motives and aims that are to be recognised by it. Hence the simplified psychology of the "economic man," now generally abandoned—but abandoned grudgingly, by piecemeal, under pressure, and with constant attempts to patch up what ought to be cast away. There is no occasion to define the economic motive, or the psychology of the economic man, for economics study a type of relation, not a type of motive, and the psychological law that dominates economics dominates life. We may either ignore all motives or admit all to our consideration, as occasion demands, but there is no rhyme or reason in selecting certain motives that shall and certain others that shall not be recognised by the economist.

In the second place, when taken off the wrong track we

shall be able to find the right one, and shall understand that the proper field of economic study is, in the first instance, the type of relationship into which men spontaneously enter, when they find that they can best further their own purposes by approaching them indirectly. There is seldom a direct line by which a man can make his faculties and his specialised possessions minister continuously to all his purposes, or even to the greater part or the most importunate part of them. He must find some one else to whose purposes he can directly devote his powers or lend his resources in order that he may generalise his specific capacity or possession, and then again specialise this generalised command in the direction his tastes or needs dictate. The industrial world is a spontaneous organisation for transmuting what every man has into what he desires, wholly irrespective of what his desires may be.

And, in the third place, this truer conception of the economic field of investigation, coupled with the sense of the unity of fundamental law and fundamental motive that sways our economic and our non-economic action, will throw a constantly increasing emphasis upon the fact that our economic life is not and cannot be isolated, but is at every point combined with the direct expression of character and indulgence of taste, while the human relations into which it brings us are constantly waking in us a direct interest (whether of attraction or repulsion) in those purposes of others which we are directly furthering as an indirect means of furthering our own, purposes which we have indeed adopted, but beyond which we look whenever we reflect. There is no reason why means should not, to an undefined extent, be from the beginning, or become, in course of time, ends in themselves, while still continuing to be-means; nor, alas, is there any guarantee that they will not be, or will not become, negative and repellent as ends, either through physical weariness or moral repulsion. Perhaps most men's "occupations" combine both characteristics.

Again, the realisation of the exact nature of the economic organisation as a machinery for combining in mutual helpfulness persons whose ends are diverse, will drive it home to our consciousness that one man's want is another man's opportunity, and that it may serve a man's turn to create a want or a passion in another in order that he may find his opportunity in it. All



along the line, from a certain type of ingenious advertiser to the financier (if he really exists) who engineers a war in order that he may arrange a war loan, we may study the creation of wants and passions, destructive of general welfare, for the sake of securing wealth to individuals. And we may realise the deeply significant truth that to any individual the full discharge of his industrial function—that is to say, the complete satisfaction or disappearance, by whatever means, of the want which he is there to satisfy—must be, if he contemplates it, a nightmare; for it would mean that he would be “out of work,” that because no one wants what he can give no one wants him, and neither will any one give him what he wants.

Yet again, in our industrial relations the thing we are doing is indeed an end, but it is some one else’s end, not ours; and as far as the relation is really economic, the significance *to us* of what we are doing is measured not by its importance to the man for whom it is done, but by the degree to which it furthers our own ends. There can, therefore, be no presumption of any coincidence between the social significance of our work and the return we receive for it. We cannot say, “What men most care for they will pay most for, therefore what is most highly paid is most cared for,” for (sometimes to our positive knowledge, and generally “for all we know”) it is different men who express their eagerness for the different things we are comparing, by offering such-and-such prices, and those who offer little money for a thing may do so not because what they demand signifies so little, but because what they would have to give, or to forgo, for it signifies so much. They may offer little for a thing not because its possession matters so little but because their possession of anything, including this particular thing, matters so much.

These and other such considerations will not directly affect our exposition of the mechanism of the market, the central phenomenon of the industrial world, but they will profoundly affect the spirit in which we approach, and in which we conduct, our investigation of it. For we shall not only know but shall always feel that the economic machine is constructed and moved by individuals for individual ends, and that its social effect is incidental. It is a means and its whole value consists in the nature of the ends it subserves and its efficacy in subserving them. The collective wealth of a community ceases to be a

matter of much direct significance to us, for if one man has a million pounds, and a hundred others have ten pounds each, the collective wealth is the same as if the hundred and one men had a thousand each. What are we to expect from a survey made from a point of view from which these two things are indistinguishable? The market does not tell us in any fruitful sense what are the "national," "social," or "collective" wants, or means of satisfaction, of a community, for it can only give us *sums*, and the significance of a sum varies indefinitely according to its distribution.

If we reflect on these things—and the study of differential significances forces us to reflect upon them—we shall never for a moment, in our economic investigations, be able to escape from the pressure of the consciousness that they derive their whole significance from their social and vital bearings, and that the categories under which we usually discuss them conceal rather than reveal their meaning. We shall understand that this ultimate significance is determined by ethical considerations; that the sanity of men's desires matters more than the abundance of their means of accomplishing them; that the chief dangers of poverty and wealth alike are to be found in degeneracy of desire, and that the final goal of education and of legislation alike must be to thwart corrupt and degrading ends, to stimulate worthy desires, to infect the mind with a wholesome scheme of values, and to direct means into the channels where they are likeliest to conduce to worthy ends.

To sum up this branch of our examination, the differential theory of economics will never allow us to forget that organised "production," which is the proper economic field, is a means only, and derives its whole significance from its relation to "consumption" or "fruition," which is the vital field, and covers all the ends to which production is a means; and, moreover, the economic laws must not be sought and cannot be found on the properly economic field. It is on the vital field, then, that the laws of economics must be discovered and studied, and the data of economics interpreted. To recognise this will be to humanise economics.

The merit of our present organisation of industry is to be found in the extent to which it is spontaneous, and lays every man, whatever his ends, under the necessity of seeking some other

man whom he can serve, in order to accomplish them. So far it is social, for it compels the individual to relate himself to others. But the more we analyse the life of society the less can we rest upon the "economic harmonies"; and the better we understand the true function of the "market," in its widest sense, the more fully shall we realise that it never has been left to itself, and the more deeply shall we feel that it never must be. Economics must be the handmaid of sociology.

## II.

Let me now proceed to the consideration of a few points in which I think the traditional methods of technical exposition need reconsideration in the light of the differential theory.

At the root of all lies a profound modification of our conception of the nature and function of the "market" itself. The differential theory when applied to exchangeable things tells us that there is equilibrium only when an exchangeable commodity is so distributed that every one who possesses it assigns the same place to its differential value, amongst those of other commodities of which he has a supply; and that this place is a higher one than it occupies on the relative scale of any one who does not possess it. What this place is—that is to say, the differential equivalence of the commodity in terms of other commodities, when equilibrium is established—is fixed absolutely by two determinants. These are:—(1) The tastes, desires, and resources of the individuals constituting the society. When objectively measured and expressed, these individual desires for any one commodity can be represented by curves capable of being summed; and the resultant curve, objectively homogeneous but covering undefined differences of vital or subjective significance, is usually called, so far as it is understood and realised, the "curve of demand." This is one of the determinants we are examining, and it represents a series of hypothetically co-existing relations between given hypothetical supplies and corresponding differential significances. It is a curve representing a function. (2) The amount of the actual supply existing in the community. This is not a curve at all, but an actual quantity. It is not a series of co-existing relations, but one single fact, and it determines which of the series of hypothetical or potential relations represented by the curve shall be actually realised.

But what about the "supply curve" that usually figures as a determinant of price, co-ordinate with the demand curve? I say it boldly and baldly: There is no such thing. When we are speaking of a marketable commodity, what is usually called the supply curve is in reality the demand curve of those who possess the commodity; for it shows the exact place which every successive unit of the commodity holds in their relative scale of estimates. The so-called supply curve, therefore, is simply a part of the total demand curve which we have already described as factor (1). The separating out of this portion of the demand curve and reversing it in the diagram is a process which has its meaning and its legitimate function, as we shall see in a moment, but is wholly irrelevant to the determination of the price.

The intercourse of the market enables all the parties concerned to find their places with respect to each other on the general demand curve. Each individual, whether or not he possesses a stock of the commodity, brings his own individual curve of demand into the market, and there relates it to all the other individual curves of demand, thus constituting the collective curve, which (together with the amount of the commodity available) determines the price, *i.e.* the (objective) height of the lowest demand for a unit of the commodity which the available amount will suffice to reach.

The ordinary method of presenting the demand curve in two sections tells us the extent to which the present distribution of the commodity departs from that of equilibrium, and therefore the extent of the transactions that will be required to reach equilibrium. But it is the single combined curve alone that tells us what the equilibrium price will be. The customary representation of cross curves confounds the process by which the price is discovered with the ultimate facts that determine it.

Diagrams of intersecting curves (and corresponding tables) of demand prices and supply prices are therefore profoundly misleading. They co-ordinate as two determinants what are really only two separated portions of one; and they conceal altogether the existence and operation of what is really the second determinant. For it will be found on a careful analysis that the construction of a diagram of intersecting demand and "supply" curves always involves, but never reveals, a definite assumption as to the amount of the total supply possessed by

the supposed buyers and the supposed sellers taken together as a single homogeneous body, and that if this total is changed the emerging price changes too; whereas a change in its initial distribution (if the collective curve is unaffected, while the component or intersecting curves change) will have no effect on the market, or equilibrating price itself, which will come out exactly the same. Naturally, for neither the one curve nor the one quantity which determine the price has been changed.

The accompanying diagrams may suggest to the reader a method of testing the validity of the argument in the text.

$Ox$  in both figures represents the amount of the commodity,

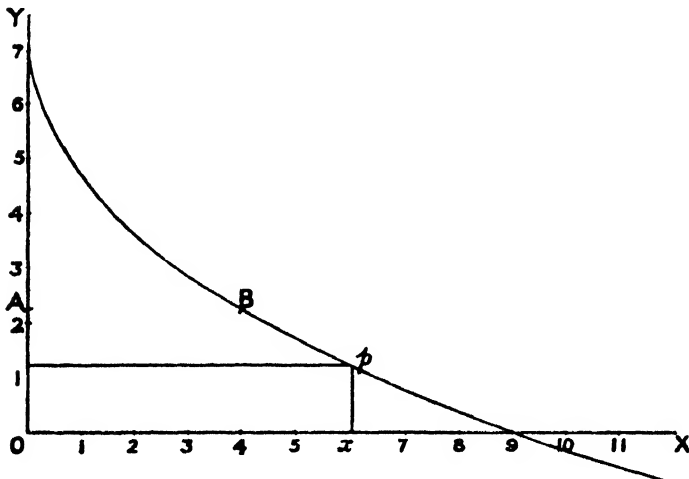

FIG. I.

and the curve in Fig. I. represents the total demand curve. The resultant price is  $px$ .

None of these data are altered in Fig. II, but the demand curves of the possessors (collectively) and the non-possessors (collectively) are separated out from each other, as representing the conditions under which the market opens. Two different hypotheses as to this initial distribution of the stock are represented by the dotted and the continuous lines. But in each case, of course, the condition of preserving the data of Fig. I. intact determines that at any price  $OA$ , the line  $AB$  (Fig. I.) shall be equal to the sum  $Ab + ab'$  or  $A\beta + a\beta'$  (Fig. II.). If

this condition is observed, the intersection must be at the height  $xp$ , when  $AB$  or its equivalent sum in Fig. II. equals  $Ox$ .

The dotted lines represent a market that opens with conditions nearer to equilibrium than those represented by the continuous lines; and in the one case only  $Ox'$  will change hands, whereas in the other  $Ox''$  will do so. But this has nothing to do with the price.<sup>1</sup>

The curve of supply prices, then, is a mere *alias* of a portion of the demand curve. But so far we have only dealt with the market in the narrower sense. Our investigations throw sufficient light on the distribution of the hay harvest, for instance,

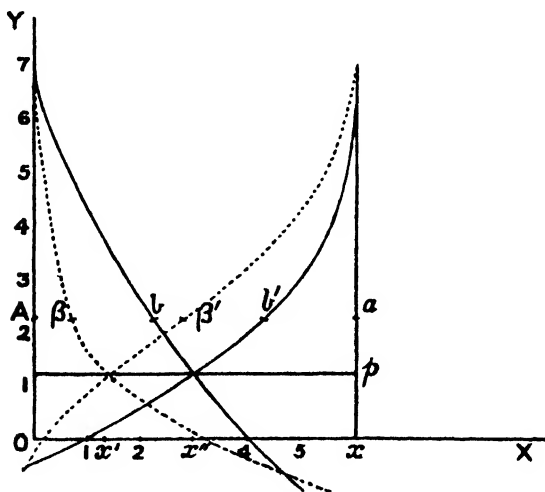

FIG. II.

or on the “catch” of a fishing fleet. But where the production is continuous, as in mining or in ironworks, will the same theory still suffice to guide us? Here again we encounter the attempt to establish two co-ordinate principles, diagrammatically represented by two intersecting curves; for though the “cost of production” theory of value is generally repudiated, we are still too often taught to look for the forces that determine the stream of supply along two lines, the value of the product, regulated

<sup>1</sup> For further details and the treatment of possible objections, see my *Common Sense of Political Economy*, Book II. Ch. IV.

by the law of the market, and the cost of production. But what is cost of production? In the market of commodities I am ready to give as much as the article is worth to me, and I cannot get it unless I give as much as it is worth to others. In the same way, if I employ land or labour or tools to produce something, I shall be ready to give as much as they are worth to me, and I shall have to give as much as they are worth to others—always, of course, differentially. Their worth to me is determined by their differential effect upon *my* product, their worth to others by the like effect upon *their* products (or direct fruitions, if they do not apply them industrially). Again we have an *alias* merely. Cost of production is merely the form in which the desiredness a thing possesses for some one else presents itself to me.<sup>1</sup> When we take the collective curve of demand for any factor of production we see again that it is entirely composed of demands, and my adjustment of my own demands to the conditions imposed by the demands of others is of exactly the same nature whether I am buying cabbages or factors for the production of steel plates. I have to adjust my desire for a thing to the desires of others for the same thing, not to find some principle other than that of desiredness, co-ordinate with it as a second determinant of market price. The second determinant, here as everywhere, is the supply. It is not until we have perfectly grasped the truth that costs of production of one thing are nothing whatever but an *alias* of efficiencies in production of other things that we shall be finally emancipated from the ancient fallacy we have so often thrust out at the door, while always leaving the window open for its return.

I now turn to some of the most obvious consequences of the differential theory of distribution. They are all included in the one statement that when fully grasped this theory must destroy the very conception of separate laws of distribution such

<sup>1</sup> I do not deny that, as we recede from the market and deal with long periods and the ultimate conditions on which nature yields her stores, cases may arise in which something like a "supply curve" seems legitimate. The terms on which nature yields increasing supplies of some raw material, for instance, cannot legitimately be regarded as the reserve prices in which she expresses her own demand! But even here in the last analysis, and when we consider the enormous range of the principle of "substitution" and the pressures that determine the directions taken by inventive genius, I believe we shall be thrown back in all important cases upon modifications in the demands upon human energy and expressions of human vitality and their distribution amongst all the utilities and fruitions that appeal to them.

as the law of rent, the law of interest, or the law of wages. It is by determining the differential equivalence of all the factors of production, however heterogeneous, that we reduce them to a common measure and establish the theory of distribution; just as it is by determining the differential equivalence of all our pursuits and possessions that we attempt to place a shilling or an hour or an effort of the mind where it will tell best, and so distribute our money or time or mental energy well. There can no more be a law of rent than there can be a law of the price of shoes distinct from the general law of the market. The way in which the several factors render their service to production differs, but the differential service they render is in every case identical, and it is on this identity or equivalence of service that the possibility of co-ordinated distribution rests. So the economist, though he may begin by giving precision to the student's idea of *how* "waiting," for example, or tools, or mere command of "extension" in space, or manual skill, or experience, or honesty, may affect the value of the product, must end by showing him that their distributive share of the product depends not upon *the way in which* they affect the product (wherein they are all heterogeneous), but on the differential *amount* of their effect (wherein they are all alike). The law of distribution, then, is one, and is governed not by the differences of nature in the factors, but by the identity of their differential effect. With this searchlight we must scrutinise the body of current economic teaching, and must cast out the mischievous survivals that deform it.

On the present occasion severe selection and limitation is, of course, necessary, and I think we cannot do better than take up a few of the current phrases, or conceptions and diagrammatic illustrations connected with the phenomenon of rent. Antecedently we must expect that as there is no theoretical difference between the part played by land and that played by other factors of production (or more direct ministrants to enjoyment), so there can be no general assertion about rent and land which is at once true and distinctive; for, if true, it must be based on that aspect of land which expresses its function in a unit common, say, to capital, and which brings its differential significance, upon which all depends, under the same law; and therefore it cannot be distinctive of land.



Let us test the truth of these anticipations. Ricardo's celebrated law of rent really asserts nothing except that the superior article fetches the superior price, in proportion to its superiority; and it is obvious that all "superiorities" in land, whether arising from "inalienable" properties or from expenditure of capital, tell in exactly the same way upon the rent.

Again, a diagram may easily be constructed in which different qualities of land are represented along the axis of  $X$  and their supposed relative fertilities to a fixed application of labour and capital along the axis of  $Y$ . The "marginal" land will occupy the extreme place to the right. This is not a functional curve; for the height of  $y$  does not depend upon the length of  $x$ , the units being expressly so placed on  $OX$  as to produce a declining  $y$ . It is applicable to land or to anything else of which typical units can be arranged in ascending or descending order of efficiency.

But the same figure has been used as a functional curve in connection with the theory of rent. Take a given fixed area of land of a certain quality and consider what would be its yield if it were "dosed" with a certain quantity of labour and capital represented by a unit on the axis of  $X$ . Increase the doses till a further increment of labour and capital would not produce as large an increment in the yield of this land as it would if applied to some other piece of land of the same or different quality, or if turned to some non-agricultural business. The last increment actually applied is the "marginal" increment, and it measures the distributive share of a unit "dose" in the product. The figure and the details of the argument are too familiar to need elaboration; nor can I stay to show that such a curve ought really to pass through the origin, for important as the point is, it does not affect our present investigation; but it is essential to point out that the descriptive and the functional curves just described both present the same appearance, both represent "rent" by a curvilinear surface, both use the term "margin," though in entirely different senses, as determining rent, and are both just as applicable to anything else as to land, and (specifically) ignore the difference between "economic" and "commercial" rent, being just as applicable to one as to the other.

The ambiguous use of "marginal" has naturally caused some confusion (a point to which I shall soon revert), but at present the descriptive curve and "margin" have only been introduced to be dismissed. In the discussion of the functional curve, which we must now continue, I have used the term "marginal" in the sense of "differential" as applied throughout our whole investigation. It is not any peculiarity of the "marginal" increment that makes it yield less than the others. It does not. They all have exactly the same differential effect on the yield, as to which none is after or afore the other. The height of this differential or marginal yield is dependent not upon the nature of each several dose, but upon their aggregate number. What we have here, then, is not a law or theory of rent at all, but the tacit assumption that the differential theory of distribution is true of every factor of production except land, and that rent is what is left after everything that is not rent is taken away. For, observe, land-and-labour is treated as a homogeneous quantity, so that the reduction of heterogeneous factors to a common unit is assumed, and how is this to be done except by comparing their several efficiencies on the product, and so combining them as to keep those efficiencies in differential equivalence to their market prices, *i.e.* their efficiencies on other land or in other industries? And thus the principle of marginal or differential efficiency as determining distributive shares in the product has long been quite definitely, though naïvely and unconsciously, asserted in saying that the "marginal" efficiency of this compound factor of production will find the same level in the specified industry and out of it, and will determine its remuneration.

This so-called statement of the law of rent, then, assumes our differential laws of exchange value and distribution, with all their implications, as ruling everywhere *except* in land and rent. Rent is merely what is left when everything except rent is taken away. This can hardly be called a "law," but, such as it is, it is again common to all factors of production. Wages are all that is left when everything that is not wages is taken out. And this is actually the statement of Walker's "law of wages." And so with the rest.

But this is not all. In the treatment of rent that we are examining the differential theory of distribution is avowed with

respect to every factor except land ; but it is implied with respect to land also. This can be rigidly proved mathematically, as is now beginning to be acknowledged ; and even the non-mathematical student can easily perceive that the forms of the figures representing the shares of "land" and "labour-and-capital" respectively are determined not by any peculiarity of land, but by the fact that land is supposed to remain constant, while labour-and-capital vary. But three pounds sterling applied to one acre is the same thing as a third of an acre coming under one pound's worth of culture, and five pounds per acre is a fifth of an acre per pound. Instead of taking an acre, therefore, and considering the difference of yield, as two, three, four, five pounds are expended upon it, let us take one pound and consider the differences of yield, as one-fifth, one-fourth, one-third, one-half of an acre come under it, or in other words, as it spreads itself over these different areas. You will then find that you have a figure in which the same identical data are presented and the same identical results obtained, but the return to land is represented as a rectangle cut off by a line parallel to  $OX$ , and the return to labour-and-capital by a curvilinear "surplus" or residuum. So that the supposed law of rent again turns out, in so far as it is true of land, to be true of all the other factors of production. But the unhappy confusion between the geometric properties of an arbitrarily selected constant factor in a diagram and the economic properties of land has brought dire confusion into economic thought and economic terminology. The Augean stables must be cleansed. We must understand that when the differential distribution is effected there is no surplus or residuum at all ; and that any diagram of distribution that represents the shares of the different factors under different geometrical forms is sure to be misleading, and is likely to be particularly mischievous in its misdirection of social imagination and aspiration.

And note, finally, that even in practical problems the supposed peculiar conditions introduced by the rigidly determined quantity of land in existence are non-existent. Any individual can have as much land as he likes if he will pay the price, and he is conscious of no difference in principle whether he is bidding for a certain quality and site of land, or a certain grade of labour or kind of ability, unless it be that in the latter

case he is *more* conscious of the limits of supply that no offer of remuneration can stretch.

In conclusion, I will revert to the point, incidentally raised in connection with rent, of the difficulties and confusions connected with terminology.

I have throughout spoken of *differential*, rather than *marginal* significances ; for there is a fatal ambiguity in the use of the word "marginal." And yet, after all, I have felt like the man who "did flee from a lion and a bear met him ; or went into the house and leaned his hand on the wall, and a serpent bit him," for by a singular perversity of fate or fashion a closely similar ambiguity besets the word "differential" itself, and yet another and equally appropriate term "incremental." All these words have been preoccupied ; and curiously enough it is speculations on the nature of rent or projects concerning land that have done the mischief in every case. "Increment," instead of suggesting a small homogeneous addition to any magnitude whatever, at once suggests to the reader of economic literature the "unearned increment of land," so that the "incremental value," "efficacy," or "significance" of anything cannot conveniently carry its proper meaning of the value attached to a small increment or decrement of anything, varying with the expansion or contraction of the supply. This is the conception I have indicated by the term "differential." But here again we are forestalled. "Differential payment," for instance, would generally be understood by readers of economic literature to mean payment made for some articles in excess of that made for others, in consideration of their superiority. Thus, if I were to say that "rent is a differential charge," I should be supposed to mean that what you pay for a certain piece of land as rent represents the superiority of that piece of land to another that you can get for nothing. In this use of the word everything depends upon the different *quality* of the things compared. But what we want is a word which shall always carry the underlying assumption that we are considering the expansion and contraction of a *homogeneous* supply, the "differential" value of that supply being a function of its breadth or magnitude.

Again, the same theory of rent which regards it as a differential charge, in the sense of a charge due to an inherent difference of quality in the things charged for, assumes that there is some

land which bears no rent at all. This is the land on the "margin" of cultivation. Hence "marginal" has come to be used in economic literature to signify the lowest grade or quality of any commodity, or service, or the least favourable set of conditions, that just hold their footing in any industry. Thus the marginal land would mean the worst land under cultivation, the marginal workman the least efficient man in actual employment, the marginal conditions of an industry the least advantageous conditions under which it is actually conducted, and, I suppose, the marginal grade of potatoes or wheat the worst quality actually in the market; or to the hungry individual the marginal mouthful of beef would be the one just not rejected and left on the plate because too largely composed of "veins" to be eaten, even if no more of any kind were to be had.

Now attempts have been made to erect a theory of distribution upon the consideration of "margins" in this sense. The "marginal" man, working on the "marginal" land, under the "marginal" conditions, and with the "marginal" appliances, is taken as the ultimate basis of the pile, and wages, rent and interest are explained as "differential" in their nature; that is to say, as due to the superiority in quality, position, or point of application, of such-and-such work, land, or apparatus, over the "marginal" specimens.

I do not stay to examine this theory on its merits; but it is necessary to insist on the almost incredible fact that there is constant confusion between it and what I have tried to expound as the "differential" theory of distribution, simply because they can both be described as "marginal," and the term "differential," though in quite divergent senses, may be introduced in the exposition of either.

Once again, then, if I speak of the differential or marginal significance of my supply of bread and milk, and say that it depends, *ceteris paribus*, upon how many loaves of bread and how many pints of milk I take, I am supposing all the bread and milk to be of the same quality. And if I speak of the differential or marginal significance of labour in a particular industry, I am either speaking of a uniform grade of labour or of different grades reduced to some common measure and expressed in one and the same unit, and I mean the significance which such a unit has when it is one out of so many others like itself. Thus, in

my use of the word, there is no ear-marked marginal unit, which is such in virtue of its special quality. Any one of 100 units has exactly the same marginal value; but as soon as one unit is withdrawn, all the remaining 99 have a higher marginal value; and when one is added, all the 101 a lower.

The only word I can think of free from misleading associations would be "quotal"; for *quotus* means (amongst other things) "one out of how many," and so *quotal* significance might mean the significance which a unit has when associated with such-and-such a number of others *homogeneous with itself*.

Here I must close these almost random indications of some of the directions in which I think that convinced apostles of the differential economics should revise the methods of economic exposition. For myself I cannot but believe that if this were accomplished, all serious opposition to the doctrine would cease, that there would once again be a body of accepted economic doctrine, and that Jevons's dream would be accomplished and economic science re-established "on a sensible basis."

It is impossible to exaggerate the importance of such a consummation. Social reformers and legislators will never be economists, and they will always work on economic theory of one kind or another. They will quote and apply such dicta as they can assimilate, and such acknowledged principles as seem to serve their turn. Let us suppose there were a recognised body of economic doctrine the truth and relevancy of which perpetually revealed itself to all who looked below the surface, which taught men what to expect and how to analyse their experience; which insisted at every turn on the illuminating relation between our conduct in life and our conduct in business; which drove the analysis of our daily administration of our individual resources deeper, and thereby dissipated the mist that hangs about our economic relations, and concentrated attention upon the uniting and all-penetrating principles of our study. Economics might even then be no more than a feeble barrier against passion, and might afford but a feeble light to guide honest enthusiasm, but it would exert a steady and a cumulative pressure, making for the truth. While the experts worked on severer methods than ever, popularisers would be found to drive homely illustrations and analogies into the general consciousness; and the roughly understood dicta bandied about in the name of Political

Economy would at any rate stand in some relation to truth and to experience, instead of being, as they too often are at present, a mere armoury of consecrated paradoxes that cannot be understood because they are not true, that every one uses as weapons while no one grasps them as principles.

## FINAL UTILITY<sup>1</sup>

THE principles and methods embodied in Jevons's doctrine of "final utility," together with the considerations suggested in the article on POLITICAL ECONOMY AND PSYCHOLOGY (*q.v.*), have received far-reaching developments in recent years. Hence a movement has arisen, variously described as "psychological" or "marginalist," which aims at unifying and simplifying economic theory, and at the same time affiliating its laws more closely to the principles that regulate human conduct in general.

Jevons has shown that the demand in a market in which there are no reserved prices can be represented by a collective curve. The amount of the commodity in the market is measured on the abscissa, and the equilibrating price on the ordinate. The next step is to point out that in so far as the sellers have reserved prices they ought to be regarded as themselves entering the market, with potential demands, on the same footing as the purchasers. Their intention to retain such and such quantities of their stock at such and such prices (whether for their own use or because they speculate on the demands of future purchasers) constitute *de facto* demands, and should be entered on the collective demand curve; which, together with the register of the amount of the commodity, will determine the price as before. It follows that the cross curves of demand and supply, so often employed by economists, are really no more than two sections of the true collective curve of demand, separated out from each other, and read, for convenience, in reverse directions. This separation is irrelevant to the determination of the equilibrating price (as may easily be shown by experiment), though it enables

<sup>1</sup> [Reprinted from *Palgrave's Dictionary of Political Economy*, 2nd Ed. edited by Henry Higgs, Vol. II., pp. 857-859. This was Wicksteed's last contribution to Pure Economics and he is said to have regarded it as containing, in a short compass, a statement of the chief points which it had been his life's work to emphasise.]



us to read off the volume of the exchanges that will be necessary in order to bring about the equilibrium, on any given supposition as to initial holdings. These cross curves, then, as usually presented, confuse the methods by which the equilibrating price is arrived at with the conditions that determine what it is.

Passing on to the problems of production and distribution, we note that in an industrially advanced community production rests upon the co-operation of a number of heterogeneous factors, the supply of which may be controlled by a number of independent individuals or combinations; and since it is obvious that the value of a means of production must be derivative from the value of the product, we have, theoretically, to determine the principle on which the value of the product when realised will be distributed amongst the various factors which co-operated in its production. Practically the factors will generally be brought together by a series of speculative transactions based on estimates made in advance. But in any case the value of the several factors must be determined by consideration of their productive effectiveness at the margin, and their equivalence to each other in fractional substitutions. For although the nature of the productive service rendered by such factors as land, labour, and tools, for instance, is different in each case, and no main factor could be replaced in its entirety by any other, yet every manager is constantly engaged in considering alternatives and equivalences between fractional additions or subtractions of them at the margin. It is so that he determines the proportions in which to distribute his resources over the improving or extending of a site, the modification of existing buildings, the replacing of machinery, the strengthening or reduction of this or that grade of labour, superintendence to reduce the waste of raw material, or the seeking of new openings, or maintenance of old ones, by advertisement. And all the time he has to convince his employers that his own skill in judging of these matters is as effectively productive as any increments in the more immediate factors of production that they could command for the salary that they pay him. The purchasers, then, in the great markets of the productive factors consider them under the uniform aspect of their relative productive efficiency at the margin, just as the purchaser in the retail market considers his heterogeneous purchases under the uniform aspect of their

relative efficiency at the margin, in gratifying his desires or expressing his impulses. In a word, there are not many laws of distribution but one, and that law is the law of the market.<sup>1</sup>

Thus it will be seen that the end dominates the means throughout. The direction and administration of all resources is ultimately determined by estimates of the value of some experience, or by the imperativeness of some expression of the human consciousness. If at any point the expectations based on these estimates should fail or wither, the breadth of the stream that has already flowed at their bidding is powerless to sustain their living significance. Anticipated value determines the cost and sacrifice that will be incurred in production, but the cost and sacrifice, when once incurred, cannot control the value of the product.

If we now return to our starting-point in Jevons's "final utility" and its control of the distribution of a man's pecuniary resources, we note that the term "final" has been generally abandoned. It seems to imply a succession of experiences, following each other in time, as when a man's hunger is gradually appeased and each morsel meets a decreasingly urgent need. It is therefore inapplicable, for instance, to the problems we have discussed under the head of "distribution," where the units of the same factor may be indistinguishable in quality and may all be running abreast of each other in the output of a continuous stream of efficiency, but where nevertheless the

<sup>1</sup> Thus "interest" is the price, reckoned in deferred payments, of present command of resources. The industrial, who expects this command actually to produce the future resources out of which he will make the payment, enters a market in which he will have to compete with the non-industrial who is willing to risk or compromise his future at the dictate of his present desires, and the ordinary consumer who, having a small revenue and no accumulations, is willing to pay a higher price for a possession, if he may spread the payment over a longer period, rather than cut deep into the quick of his other requirements at the moment.

"Rent" is a form of hire, the continuous purchase of a continuous revenue of services or enjoyments. The well-known figure of the rent curve, which represents the decreasing productive efficiency of successive applications of labour and capital to a fixed unit of land, is seen to owe its form not to any special characteristic of land but to the selection of a single factor of production which is not to increase while all the others do. The identical facts which such a curve represents, if read in the reverse order, would represent the same series of hypotheses as to the relative proportions of the several factors; but the rent would now be presented as a rectangular area, with its altitude determined by the alternative uses of land, and the return to labour and capital, as a curvilinear "residue," determined by the decreasing yield of a fixed constant of labour, etc., when spread over more and more land.

withdrawal from co-operation of one unit out of five would be a less serious matter than the withdrawal of one out of four, because it would create a less serious disturbance of the proportions between the factors and would require less serious readjustments or additions to compensate it. The term "marginal" has been very generally adopted, but it has the disadvantage of still suggesting (especially in connection with land) some intrinsic differentiating characteristic which earmarks and individualises a unit as "marginal" in virtue of its own nature. The term "fractional" may often be conveniently used.

Again, the word "utility" so conspicuously fails to include all the objects of wise or foolish, good or bad desire, to which the economic machinery ministers, that if it still sometimes retains its place (subject to careful explanation that it does not really *mean* utility) it is only for want of general agreement as to a substitute. The anomaly becomes more glaring and extends to the term "consumption," when we realise that the laws of political economy are but the application to a special set of problems of the universal laws of the distribution and administration of resources in general (whether of money, time, influence, powers of thought, or aught else) amongst all the objects that we deliberately pursue or to which we are spontaneously impelled, whether material or spiritual, private or social, wise or foolish. It is intolerable that "consumption" (with its subtle suggestion of a regrettable necessity that puts a drag upon the progress of "production") should continue to stand for the whole stream of "actualisings," in conscious experience, of the potentialities to the development of which human effort is devoted. It is the nature of these actualisings, contemplated or realised, that is the supremely significant thing in the life of a man or a community; for it is from them that all which leads up to them derives its worth or its worthlessness.

The psychological and philosophical bases and the historical evolution of the movement now characterised are exhaustively treated, with full bibliographical details, by Roche-Agussol in *La Psychologie économique chez les Anglo-Américains*, Montpellier and Paris, 1918, and the supplementary *Étude bibliographique des sources de la psychologie économique*, etc., 1919.

## REVIEWS AND BIOGRAPHICAL NOTES

### 1. STANLEY JEVONS <sup>1</sup>

JEVONS, WILLIAM STANLEY (1835-1882), one of the greatest English economists of the nineteenth century, was born at Liverpool. His father, Thomas Jevons, was in the iron trade, and interested in all the new engineering schemes of his time. His mother, Mary Ann Jevons, was the eldest daughter of William Roscoe, the author of the *Life of Lorenzo de Medici*, a man of much learning and refinement. Her mind had been cultivated by constant companionship with her father and by the intellectual society which she enjoyed under his roof. She was a person of considerable poetical talent and strong religious feeling. W. S. Jevons, the ninth child of these parents,—with other relations of much education and ability,—was thus early brought under influences which assisted to develop his mind and character. His mother encouraged her children in their love of drawing and music. She “carefully fostered,” W. S. Jevons wrote, “a liking for botany, giving me a small microscope and many books, which I have yet. Strange as it may seem, I now believe that botany and the natural system, by exercising discrimination of kinds, is the best of logical exercises. What I may do in logic is perhaps derived from that early attention to botany.”

Early in 1846 Jevons was sent to the Mechanics' Institute High School, Liverpool, of which Dr. W. B. HODGSON, afterwards professor of political economy in Edinburgh, was then headmaster. In 1850 he entered University College School, London, and in 1852 matriculated at the University of London, with honours both in chemistry and botany. Meanwhile the means of earning a livelihood had to be sought, and Professors Williamson and Graham, who had observed his great ability and power

<sup>1</sup> [Reprinted from *Palgrave's Dictionary of Political Economy*, 2nd Ed., edited by Henry Higgs, Vol. II., pp. 474-478.]

of work in the college laboratory, recommended his appointment as assayer to the new mint at Sydney. Further study in other directions had now to be checked. He studied assaying at the Paris mint, and in 1854, when not yet nineteen, sailed for Sydney. He remained five years in Australia, filling his post at the mint with skill and success. The study of meteorology attracted him strongly, and he devoted himself to it with his wonted thoroughness. His interest in later life in recording the periodicity of the "sun-spot" disturbances and the connection between these and changes in the seasons, the price of corn, and commercial crises, was doubtless quickened by these investigations. During this period, political economy also appears to have attracted his attention.

His position at Sydney was an honourable one. The income was considerable, the more creditable to him because attained at so early an age, and the more important because he was now entirely dependent on his own exertions. But an ardent desire for further opportunities of mental improvement overcame all other considerations. "Another year's regular hard study," he wrote to his sister Lucy (Mrs. John Hutton) in 1858, "especially at my increased age, will be invaluable, and its loss would be regretted to the end of my life." He returned to England in 1859, re-entered University College, took the B.A. degree 1860, the Ricardo scholarship the same year, the M.A. with a gold medal 1863. He was, 1866, appointed professor of logic and mental and moral philosophy and Cobden lecturer on political economy in the Owens College, Manchester, posts which he held till 1875, when the strain of increasing work, coupled with somewhat failing health, compelled him unwillingly to resign. In the same year, 1875, he was elected professor of political economy in University College, London, a post which he retained till 1880.

Jevons was elected Fellow of the Royal Society in 1872. He married, in 1867, Harriet Ann, third daughter of Mr. J. E. Taylor of Manchester, founder and proprietor of the *Manchester Guardian* paper. His marriage was an eminently happy one. His love for music was a constant solace. He had constructed himself a very well-toned organ for his house, and was an unusually accomplished musician.

Though reserved in character, he was a very pleasant companion and extremely instructive in conversation. One who had the advantage of knowing him, and frequently experienced the help which his powerful mind brought to the solution of any economic problem, remarked of his

conversation, "It was more like talking with an early Greek philosopher, if one can realise what that would have been, than with one of our contemporaries."

Perhaps the most remarkable feature in his life was his early and unwavering conviction that he was destined to do some great work, his entire devotion of himself to preparation for it, and afterwards his unhesitating renunciation of anything, however tempting, that seemed to stand in the way of it. Thus in 1851, when he was sixteen, he writes, "I began to think that I could and ought to do more than others,"—in 1857 when twenty-two, that he has "one wish, or one *intention*, viz. to be a *powerful good* in the world,"—in 1863, when twenty-seven, and saddened by want of immediate success on his return from Sydney, he still sees a hope in his "capacity of seeing the sameness and difference of things, which if history and . . . experienced men are to be believed, is a rare and valuable kind of power." His subsequent career was the carrying out of these convictions. He could let nothing draw him aside from the endeavour to carry out his scientific career to the utmost limit of his capabilities.

While it is primarily as an economist that Jevons claims attention in the *Dictionary of Political Economy*, his researches as a logician and a student of scientific method cannot be ignored. Indeed it will be convenient to begin with an examination of the *Principles of Science*, in which Jevons sums up and applies the results of his long and severe researches in logic. He bases his system upon the generally received axioms that "whatever is is," that "a thing cannot both be and not be," and that "a thing must either be or not be." But to these he adds the principle of "the Substitution of Similar," that is to say, the axiom that whatever is true of *A* is true of everything that cannot be distinguished from *A* in the relation contemplated. Thus if *B* is identical with *A* then *B* may be substituted for *A* in any assertion that has been shown to be true of *A*. The next and crucial step is to bring every proposition into the form of the assertion of an identity. Thus the proposition "men are mortal" becomes in Jevons's system "man" is the same as "mortal man." Therefore if anything can be said of "man" the same can be said of "mortal man," and if "man" can be predicated of any subject, "mortal man" can be predicated of the same subject. Now whatever may be thought of the psychological principle that a proposition is the assertion of an identity, it is unquestionable that it logically *involves* such an identity. Jevons can therefore throw his propositions into a form which at once admits of the

application of the principle of the "substitution of similars." Let us take the two propositions (1) "Cæsar" is the same as "the man Cæsar"; (2) "man" is the same as "mortal man." Now (2) enables us to substitute "mortal man" for "man" in (1), and we have "Cæsar" is the same as "the mortal man Cæsar"; or symbolically putting  $A$  for Cæsar,  $B$  for man, and  $C$  for mortal, we have (1)  $A$  is the same as  $AB$ , (2)  $B$  is the same as  $BC$ , whence by substitution  $A$  is the same as  $ABC$ . It is now possible to elaborate a system in which every proposition shall be convertible, and to found upon it a symbolical manipulation of terms, with its appropriate algebra, that constitutes an indefinite advance upon the "Barbara, Celarent, etc.," of Petrus Hispanus. Having reduced deductive reasoning to a mechanical process, Jevons found no insuperable difficulty in constructing a syllogising machine; but he regarded this triumph as possessing little practical though considerable theoretical significance. From his reconstruction of deductive reasoning Jevons goes on to contend that induction is an inverse process entirely dependent upon the laws of deduction for its validity. The next step is to show that mathematics is but a special application of logic and that the mathematical equation is subject to precisely the same laws as the logical identity, the apparent difference being due to the universal presence in the equation of certain limiting conditions which are not assumed unless expressly stated in the logical identity. The doctrine of chances is now developed in immediate dependence upon the law of "substitution of similars"; for the root principle of the doctrine of chances is that inasmuch as belief ought to depend upon the distribution of our knowledge and ignorance, therefore we should believe the same about one event as we believe about another, our knowledge or ignorance of which is the same. The doctrine of chances in its turn is made the basis of the whole system of scientific investigation and induction, in the development of which Jevons's genius finds a thoroughly congenial field, and in which the scope of his scientific reading becomes manifest.

We will pass from this treatise on method to a collection of writings on currency and finance, which forms an almost ideal application of the "principles of science" to a group of problems of equal complexity and importance. The volume contains papers written at every period of Jevons's literary life, and, as

Professor Foxwell remarks in his preface, it is not till they are read together that the impressive unity of conception, firmness of grasp, and tenacity of scientific purpose which they reveal can be adequately felt. With equal patience and sagacity Jevons separates out the sæcular from the periodic variations in the phenomena of price, discount, pressure on reserves, frequency of bankruptcies, and so forth. His elaborate logarithmic and other tabulations are models of sound method and laborious research illuminated by theory, not likely soon to be superseded. His brilliant attempt to bring the periodicity of commercial fluctuations into connection with that great physical period which is indicated, for instance, by the changes in the aspect of the sun-spots and the electrical condition of the earth, if not conclusively successful, is suggestive of the highest range of physico-economic law which we are ever likely to attain. From his examination of the actual phenomena of the currency, Jevons proceeds to the discussion of questions of monetary policy, both domestic and international. He deals with such questions as the possibility of an international coinage, the principles of note-issue, the best means of maintaining the standard weight of coins, and of securing (by the institution of a compound unit of value) an assured stability in the standard of deferred payments. On the now burning question of bimetallism, Jevons's position, though perfectly unequivocal, is almost certain to be misunderstood by those who know it only at second hand. He fully recognises the serious nature of the evils deplored by bimetallists, and the theoretical possibility of maintaining a fixed ratio between gold and silver by international agreement; but the precarious nature of such an agreement, and the danger of sudden disturbance to existing obligations, appeared to him to be fatal objections. Thus bimetallists and monometallists alike appeal, with perfect sincerity and justice, to the authority of Jevons at one point or another of the argument, and it may be confidently asserted that when the controversy is waged within the lines laid down by Jevons, the era of scientific discussion will have definitely begun, and a decision on scientific grounds will not be far distant.

In addition to his studies in finance, Jevons treated a great variety of questions relating to state control and management. On the broad principle of state socialism and individualism Jevons



was without prejudices. His determining principle was purely Benthamite. "Will a measure increase the sum of happiness?" was the only question which he would admit as ultimately relevant. But the evidence upon which we must rely for an answer is often ambiguous, always in large part indirect, and generally conjectural. Hence the necessity of extreme caution in arriving at conclusions, together with a considerable degree of boldness in hazarding experiments. Our only guides are experience and analogy; and wherever experience seems to contradict analogy, as will often be the case, our rule must be to analyse more carefully and so correct the analogy, instead of ignoring or denying the experience. Following these principles, Jevons collected a vast mass of information on social questions, and analysed it so scrupulously that his work is almost equally valuable when experience has confirmed and when it has contradicted his anticipations. In examining questions of state action, Jevons very carefully distinguishes between state *control* of private enterprise and state *management* of enterprise. With reference to the former, we can only say that there is a presumption against interference, in so far as unimpeded freedom must be held to be a source of happiness, and therefore any restriction of freedom an evil. But this presumption must yield in innumerable instances to the demonstrated fact that greater happiness has resulted from control. A conspicuous instance is furnished by the FACTORY ACTS, and Jevons would gradually extend their principle so as to prohibit altogether the employment of child-bearing women in factories. The conditions under which state management, as distinct from state control, is likely to be advantageous, were submitted by Jevons to a rigorous analysis, which ought to be the starting-point of all discussions of the subject. The conditions he held to be favourable to state management are as follows: (1) where numberless wide-spread operations can only be efficiently connected, united, and co-ordinated in a single all-extensive government system; (2) where the operations possess an invariable routine-like character; (3) where they are performed under the public eye or for the service of individuals who will immediately detect and expose any failure or laxity; (4) where there is but little capital expenditure, so that each year's revenue and expense account shall represent with sufficient accuracy the real commercial conditions

of the department. An exhaustive examination of the facts with reference to these criteria, led Jevons to pronounce in favour of the state management of telegraphs and telephones, and the establishment of a parcel post, none of them accomplished facts when he wrote ; but against the state management of railways, which however should be strictly controlled in the interests of the community. It may be mentioned that Jevons had a strong dislike and suspicion of trade unions, based on grounds of economic theory. But he looked for their gradual transformation into co-operative societies, and would leave them absolutely free. On similar grounds he placed small hope in methods of arbitration and conciliation, trusting rather to the free play of competition. It should be noticed in connection with labour questions that Jevons never lost sight of the vital distinction, so generally overlooked, between the horizontal cleavage of the industrial community into various grades of skilled and unskilled labour, managers, capitalists, landowners, and so forth, and the vertical cleavage into the agricultural interest, the coal interest, the iron interest, etc. Through neglect of this distinction a class movement and a trade movement may easily be confounded. Jevons had a profound faith in the future of industrial partnerships—a faith that survived rude shocks, for he frankly owned that English experience was against him, and that French experience is always unsafe ground for reasoning by analogy to England.

The mass of work already reviewed is great ; but we have still to notice the treatise by which Jevons's place in the history of economic theory will ultimately be determined. In his *Theory of Political Economy* he attempts nothing less than the reconstruction of the science of economics as the calculus of human satisfactions. Production derives its whole significance from consumption ; that is to say, from the satisfactions to which it ministers ; and the significance of any special unit of product is due to the increment of satisfaction which it is capable of producing. Hence the scale of equivalence of any two commodities is determined by the scale of equivalence of the increments of satisfaction which they are capable of producing. Exchange value then is determined by incremental efficiency as a producer of satisfaction. But this incremental significance is not absolutely fixed. It depends on the amount of the com-

modity already possessed or enjoyed by the individual or the community whose satisfaction we are considering. Thus we obtain the formula that if  $F(x)$  represents the whole significance, or value in use, of a commodity to its possessor, then  $F'(x)$  will represent the significance of an increment of it to him, or in other words, will be the gauge of its exchange value (see DEGREE OF UTILITY and FINAL DEGREE OF UTILITY). Should the incremental efficiency, and so the exchange value of the product of a given combination of productive efforts, be greater when such efforts are turned into one channel than when they are turned into another, this fact will determine the course they will actually take. The more significant product will therefore be increased in quantity, and the less significant decreased. Hence the incremental significance of the former will decline, and that of the latter will rise, until there is equilibrium. There will now be equivalence between the relative expenditures of productive effort and the relative values of the product; though it will not be the cost of production that has determined the value of the products, but the (anticipated) value of the products that has determined the direction of productive effort. These principles, together with the "law of indifference"—in reality a new application of the "substitution of similars"—enable Jevons to throw the theory of exchange into the form of systems of equations. From this we must inevitably proceed to the theory of distribution. Value had long been recognised as the cause and not the effect of rent. Jevons declared it to be the cause and not the effect of wages also. Hence the theory of distribution must be built up afresh, taking as the starting-point the significance of the product to the consumer. Jevons has left much for his followers to do in working out this theory. The form of his equations is open to just criticism. He seems hardly to have realised the full consequences of his method. But none the less his *Theory of Political Economy* has succeeded in its aim. When all its implications have been worked out the science will be reconstituted. On the questions of priority and originality, cp. arts. on COURNOT; GOSSEN; and the works of Walras and Menger.

In addition to the above, Jevons wrote a considerable number of technical and miscellaneous essays on scientific and social subjects, an industrial treatise, *The Coal Question*, dealing with

the possible exhaustion of our coal mines, which had a powerful influence in initiating the serious attempt to pay off the national debt, and a number of more or less elementary and popular books on logic, monetary science, problems of state management and control, and political economy.

In reviewing the whole work of this bold and patient thinker, it is impossible not to regard his death,—in the plenitude of his powers, and in the midst of works which promised to equal anything he had yet done in significance,—as one of the heaviest losses that science has suffered in our generation.

A full bibliography of Jevons's works appears in Appendix B to his *Letters and Journal*, 1886, edited by his wife, which contains a classified list of his principal works, with the dates of their first issue or collection. *Primer of Logic*, 1876.—*Elementary Lessons in Logic*, 1870.—*Pure Logic and other Minor Works* (collected), 1890.—*Principles of Science*, 2 vols., 1874.—*Studies in Deductive Logic*, 1880.—*The Coal Question*, 3rd ed. 1906.—*The State in Relation to Labour*, 1882.—*Methods of Social Reform* (collected), 1883.—*Money*, 1875.—*Investigations in Currency and Finance* (collected), 1884.—*Primer of Political Economy*, 1876.—*Theory of Political Economy*, 1871.—*Principles of Economics*, a fragment, 1905.—“Fall in Gold,” 1863, in *Investigations*.—Art. on “Cantillon,” *Contemp. Review*, Jan. 1881.—Art. on “Bimetallism,” *Contemp. Review*, May 1881.

## 2. JEVONS'S ECONOMIC WORK <sup>1</sup>

THE long-awaited publication of Jevons's posthumous and fragmentary treatise on the principles of Economics<sup>2</sup> naturally suggests considerations on the general character and effect of his economic work. His application of Mathematics to Economics was no accident, but stood in close relation to the general cast of his mind and scheme of his constructive thought. It was the same impulse that impelled him to contrive his logic machine, to attempt to ground the principles of science on the doctrine of chances, to look for the source of commercial crises in the supposed cycle of meteorological phenomena of which the spots on the sun were an indication, and to apply the principles of the differential calculus to the theory of value. In all these instances Jevons laid himself open to a superficial charge of materialism (in Comte's sense of attempting to treat the higher

<sup>1</sup> [Reprinted from *The Economic Journal*, Vol. XV., No. 59, London, 1905, pp. 432-436.]

<sup>2</sup> *The Principles of Economics*. By W. S. Jevons. Edited with a preface by Henry Higgs. (London: Macmillan and Co. 1905. Pp. xxxviii. 273.)

sciences by the methods of the lower), and in none of them was the charge justified. What Jevons did was not to degrade the higher sciences to mere applications of the lower, but to erect a hierarchy of science, not in name, but in fact, by actually building the higher on the assured basis of the lower, and ascertaining what elements in it could be, so to speak, precipitated and rendered amenable to the exacter treatment which they evaded when held in rhetorical or metaphysical solution. For example, Aristotle's rules for the syllogism are just as mechanical as Jevons's machine, and the mediæval *barbara celarent* are as much a logical abacus as Jevons's keyboard and pulleys are. But Jevons fully and clearly recognised the mechanical nature of the process, and consequently perfected its mechanism. By an odd linguistic error he called his logic machine a "logical" machine, as though the machine itself were logical and could reason; but, as a matter of fact, he showed with the most perfect cogency that whereas the formulation of the premisses is the all-important process, and is in no sense mechanical, yet when once they are formulated they can be manipulated mechanically, and all their implications rendered explicit without chance of error or omission, if the mechanism is rendered perfect. If it is not, the process will be no less mechanical but will be more liable to error. It will be worked by bad mechanics, but still by mechanics.

In precisely the same way, when Jevons recognised the quantitative nature of certain fundamental conceptions of Economics, and specifically that exchange value is, in the limit, the first differential co-efficient of value in use, he was rescuing from rhetorical and metaphysical treatment that portion of the subject which is *de facto* mathematical, and which must be treated either by explicit and accurate, or by loose and disguised mathematical methods. He was not, according to the vulgar reproach, attempting to treat the infinite complexity of human wants and impulses as if they could be dealt with by the *à priori* and deductive methods of pure mathematics. On the contrary, no man was more profoundly convinced of the necessity of wide and patient inductive researches in economic science, and no man brought subtler psychological analysis to bear upon its problems than did he; only he recognised that, when a certain class of abstract economic propositions are once made, being

essentially mathematical in their character, they rigidly involve or exclude certain other propositions ; and if their mathematical character is recognised, then we can make sure that we have lost nothing and inserted nothing on the road when we pass from the premisses to the conclusions. Here, as in the mechanism of Logic, you eliminate a source of error by the introduction of mathematical methods, but you can get nothing out at the end that you did not implicitly insert at the beginning, and what you insert can seldom be got by mathematics. It may indeed be true (and probably is) that Jevons hoped by the aid of statistics to obtain a larger number of exact formulæ than are ever likely to be actually secured, and that he, therefore, over-estimated the extent to which mathematics can penetrate the body of Economic Science. But if so, this was a mistaken estimate, not a mistake of principle. He was right in declaring that certain fundamental relations and conceptions in the theory of political economy are essentially mathematical, and that the only question is whether they are to be treated by sound or by unsound mathematics.

Now Jevons himself was convinced that the recognition of this fact involved a revolution. In June, 1860, he wrote to his brother : " I have fortunately struck out what I have no doubt is the *true Theory of Economy*, so thorough-going and consistent, that I cannot now read other books on the subject without indignation." He became more and more convinced as years went on that his discovery was destined to reconstruct the study " on a sensible basis," and that, after the work of Ricardo and Mill, economists were called upon " to pick up the fragments of a shattered science and to start anew."

To readers of the *Economic Journal* it is unnecessary to explain in detail what Jevons's " discovery " was. It was, of course, what he himself described as the principle of " final utility," and what may now be more broadly stated as the principle of variations in marginal significance. He was convinced, as we have seen, that this would revolutionise at any rate the abstract portion of economic theory ; and now, a full generation after the publication in 1871 of the *Theory of Political Economy*, we have to ask whether the revolution has taken, or is taking place. It is clear to the careful reader of Jevons that the universal application of the theory of margins was rather felt

by him as a presentiment than carried out and realised in its details. But the generation of economists that has followed him, especially in Austria and in America, whether directly inspired by his own work, or following out the parallel lines of other investigators, has done much towards carrying out his principles to their legitimate results. Under their analysis the conception of cost of production is being reduced from a position co-ordinate with that of marginal utilities to a secondary manifestation of that principle itself; and the whole group of laws of distribution has been, or is being, reduced to a variety of applications of the one principle of shifting marginal efficacies. But, on the other hand, parallel to this stream of thought there has flowed and flows another, of which we are far more effectively conscious in England. The school of economists of which Professor Marshall is the illustrious head may be regarded from the point of view of the thorough-going Jevonian as a school of apologists. It accepts, indeed, and applauds the Jevonian principles, but declares that, so far from being revolutionary, they merely supplement, clarify, and elucidate the theories they profess to destroy. To scholars of this school the admission into the science of the renovated study of consumption leaves the study of production comparatively unaffected. As a determining factor of normal prices, cost of production is co-ordinate with the schedule of demands registered on the "demand curve." And, however modified, the old distinctive categories of rent, interest, and earnings, still hold their place in the forefront of the study of distribution.

Such being the position of economic thought, one naturally turns to Jevons's posthumous work to learn, in the first place, whether the author had made any essential advance in his own apprehension of the significance of his principles, and in the second place whether he makes any essentially fresh contribution to the controversy itself, at the stage to which three and twenty years of arguments and investigations have now brought it. Broadly speaking, I think that both of these questions must be answered in the negative. But on the other hand, there is hardly a paragraph in the whole of this fragment which can be thought of as superseded, refuted, or rendered superfluous by the regrettable delay which has so long withheld it from the public.

Let us at least be thankful that we possess it at last. We cannot afford to lose even a fragment of the work of Jevons, and though his special mathematical method is not here pursued, yet the characteristics of his mind are everywhere manifest. His keenness of observation, his boldness and freedom from prejudice, his interest in out-of-the-way economic facts (such as the oscillation of cinders between small positive and small negative values, and his ingenious and humorous parallel between these same cinders in Manchester and wives in the Babylonian market), his wide and curious reading, and, lastly, his belief that all evil economic influences were incarnate in John Stuart Mill, all combine to make the man live again in these pages ; and the very fact that the work is fragmentary, if it robs it of the weight of a finished and systematic utterance, gives it something the charm of conversation.

The volume also contains reprints of the remarkable essay on Richard Cantillon, of an essay on the future of Political Economy, and of a highly interesting and stimulating pamphlet on Lowe's proposed and abandoned match tax, from which last may be culled the following characteristic psychological observation : " Many of the stamp duties, though really exceedingly troublesome, are patiently borne, because they become associated with agreeable incidents, such as the receipt of money, the completion of important business, the conferring of authority, etc."

It can hardly be said that the explanations or apologies in the preface succeed in justifying the long delay in the issue of this volume ; but it would be ungracious not to add that everything which affectionate reverence can do to present this final volume in a satisfactory form has been done by the patience, industry and acumen of the editor. We are thankful to have on our shelves at last the " complete works " of one of the most powerful, bold, and original thinkers that have devoted themselves to economic science.



3. PARETO'S *MANUALE DI ECONOMIA POLITICA*<sup>1</sup>

*Manuale di Economia Politica, con una Introduzione alla Scienza Sociale.* PARETO. Pp. xii. + 579. (Milan: 1906.)

“FAITH is the only powerful stimulant to human action, and therefore it is far from desirable, in the interests of society, that the majority of mankind, or even any large numbers, should handle social matters scientifically. Hence there is a conflict between the conditions of action and the conditions of knowledge, which furnishes a fresh proof of the lack of wisdom of the apostles of the universal and indiscriminate extension of knowledge.” These frank and characteristic words appear on p. 119 of Professor Pareto’s “Manuale,” and they are illustrated in a note, from which we gather that it is probably desirable for the majority of Englishmen, for instance, to think England superior to Germany, and for the majority of Germans to think Germany superior to England; whereas the co-existence of these two opinions (together with its beneficent results) is absolutely impossible in the light of science. If this were so, Professor Pareto need not be deprived of his rest by any dread lest his own manual should produce a practical disaster by too widely extending the area of economic and sociologic knowledge; for it is difficult to believe that even on the Continent there is any large number of students who will be able to master its extraordinarily condensed and abstract exposition of economic science. In any case, however, we cannot help thinking that the author himself stands identified with a deep and far-reaching principle that disarms the contrast he alleges between the conditions of enlightenment and those of efficiency; for Pareto, more, I suppose, than any other economist, has taught us to realise and keep in view the fact that the marginal significance of any object of desire is, as a general rule, a function not only of the quantity we possess of that object itself, but also of the quantity we possess of many, perhaps of all, other objects of desire. He has shown us, and in the present work he insists more than ever, that if we separate out any phenomenon *A* for examination, and pursue our specula-

<sup>1</sup> [Reprinted from *The Economic Journal*, Vol. XVI., No. 64, London, 1906, pp. 553-557.]

tions to a point at all remote from any given concrete position, we must at once check our results by examining the corresponding changes in *B*, *C*, *D*, etc., which will probably accompany it; or, in his own terminology, we must never carry our analysis far without checking it by synthesis.<sup>1</sup> Now in the present case it is surely grotesque to speculate on a condition of society in which the majority of mankind should be able to meet the exceptionally high demands which Pareto makes on those who pretend to scientific knowledge of economics, and should at the same time remain in essentially the same position which they now occupy with reference to stimuli to action. An educational and intellectual revolution such as no one (unless, indeed, it be Auguste Comte) has ever contemplated could not conceivably take place without being accompanied by other changes in the social organism which would induce a situation so unlike the present in all respects, that we have hardly a gauge by which to measure the relations and reactions which would then exist. But it seems safe to anticipate that action would no longer be dependent on gross national illusions. The attempt to spread economic knowledge may be vain, but it is hardly dangerous.

The present reviewer cannot venture on more than a provisional criticism of the "Manual" as a whole, for he is only too well aware that the novel and concentrated treatment of economic problems which it offers presents many points which he has not yet fully grasped or assimilated, and he looks forward to a long period of continued and intensified study, and probably to the exposition and comments of other students, before attempting to estimate its full significance; for it is a work which is likely to modify and stimulate economic thought to an extent quite disproportionate to the number of its readers. It will probably be understood by few, but every one who understands it will be influenced by it. The provisional judgment, however, which the perusal of the book suggests is already indicated in what we have said above. It is its strength that it

<sup>1</sup> By the direct application of this principle Prof. Pareto exposed (in his *Cours* and in his *Anwendungen der Mathematik auf Nationalökonomie*) the fallaciousness of some of the reasoning in my own "Co-ordination of the Laws of Distribution." And it was by an implicit application of the same principle that Prof. Edgeworth performed the same task elsewhere. I should like to take this opportunity of acknowledging the justice of both their criticisms.

carries Pareto's own principle a notable step further, and it is its weakness that it does not carry it far enough. The marginal significance of  $A$  is not a function of  $A$  alone, but a function of  $A, B, C$ , etc., and when this principle is driven through to its legitimate conclusion, we shall understand the impossibility of drawing a line between economic and non-economic phenomena; for it is impossible to carry an economic hypothesis far from existing facts without becoming aware that the reactions between economic and social conditions cannot be set aside as merely secondary; and it is impossible to raise the treatment of economic alternatives to any degree of abstraction (as by the diagrammatic or mathematical method), without perceiving that we are in reality dealing with a *psychology of choice*, the application of which extends far beyond economic problems. Both directly and indirectly, Pareto's book brings us a long way towards this conclusion. It opens with a general Introduction to Social Science; it goes on to a treatment of economic problems more abstract and general, probably, than has ever hitherto been presented, wherein we hear nothing of consumption or distribution, and very little of production, but in their place are led to examine the "balance of desires," the "obstacles" to their gratification, and the resultant equilibria. We find ourselves not exchanging and bargaining, but "ascending the hill of pleasure" by a "path" and to a "point" prescribed by the "obstacles." The whole scheme is sketched out in what may be regarded as the central chapter of the book, and it is further elaborated in three following chapters, in which more concrete illustrations and considerations are introduced. Then follows a chapter on "Population," dealing not only with the problems one would expect to find under that heading, but with the laws of movement and balance between the various strata of society, the range and distribution of incomes, and so forth. And finally, after some remarks on real and personal property, we reach the concluding chapter, in which the reactions between economic movements on the one hand and political and social movements on the other are carefully studied. Every page is original and suggestive. A mathematical appendix closes the work.

This sketch, however, taken by itself, would give a false impression in more respects than one. In the first place, the

opening chapter is designed to emphasise not the connection so much as the difference between the methods of sociology generally and of economics; and it is designed to lead up to a definition of economics which will enable us to submit them to closer and more scientific methods than are applicable to the other and vaguer branches of sociological study. Pareto, therefore, is by no means inclined to obliterate the boundaries of economic science. In economics, he says, "We shall study those actions of men which are logical, repeated, and numerous, and are undertaken to secure the things which satisfy their desires" (p. 142). The term "logical" indicates a mental connection between phenomena which has been brought into close approximation to the objective connection actually subsisting between them. But although our author repeatedly insists that all divisions and definitions are artificial, since the actual phenomena of life vary continuously (*natura enim non facit saltum*), yet he hardly seems to realise how very much this definition must be stretched if it is to include more than a very small part of the actual phenomena of the business; nor does he show any consciousness of what an immensely greater area is covered by his diagrams, his "curves of indifference," his "hills of pleasure," and his "paths of ascent," than is covered by his definition of economics. May it not, indeed, be doubted whether there is ever room for frequent repetitions of choice on a large scale while the objective relations (including in this connection those relations between subject and object which are *experienced*, as distinct from those which are *anticipated*) remain constant?

Again, the central chapters of the work are not so closely knit together as might be gathered from our sketch. The details and acute observations in later chapters are not brought to bear with sufficient directness upon the abstract formulæ of the general treatment. They often stand apart from them, much as was the case in the author's previous "Cours d'Économie Politique," and in general far too little is said by way of explanation and justification of the forms of the curves which are assumed in the text and sometimes expressly formulated in the appendix.

It must be added, in conclusion, that while the purely abstract portions of the book are written with dignity and

calmness, passion is but too clearly manifested elsewhere by the free use of sarcastic and pejorative epithets. And the facts cited to show the pernicious lengths to which certain modern tendencies may be carried would be more impressive were they not discounted, to the English reader, by the presence in their ranks of such items as the following: "When [in England] elections are coming on, the candidates do not blush to send their wives and daughters to beg for votes, and to offer their hands and lips to a gross and unwashed populace" (p. 140). In 1904, we are told, the Conservative Government, in expectation of an election, "gained the sanction of the House of Commons to a law relieving the Trade Unions of all responsibility connected with the strikes they promoted, and empowered the strikers to persecute blacklegs with impunity, giving it to be understood that this was but a small earnest of future and greater concessions" (p. 449).

#### 4. SIR SIDNEY CHAPMAN'S *POLITICAL ECONOMY* <sup>1</sup>

*Political Economy.* By S. J. CHAPMAN. (Home University Library of Modern Knowledge.) (London: Williams and Norgate. 1912. 1s.)

"THE explanations that will be presented are those which became current after the exact analysis begun by Jevons and Léon Walras had been perfected and applied to the whole field of economic phenomena by later writers, particularly by Dr. Marshall. Though the new generalisations were suggested at many points by mathematics, it is perfectly easy to represent them in simple language which implies no mathematical knowledge; and I shall try to do so" (pp. 7, 8).

If the implications of the first of these two sentences, and the statement embodied in the second, are accepted, criticism of Professor Chapman's book resolves itself into unqualified admiration of the judgment, skill, and subtlety which it displays.

But neither the implications nor the assertions seem to the present reviewer to be above challenge. To begin with the latter, which can be more briefly dealt with than the former.

<sup>1</sup> [Reprinted from *The Economic Journal*, Vol. XXIII., No. 89, London, 1913, pp. 72-75.]

On p. 75 we read, "the price of a commodity will be the price at which equal quantities are demanded and supplied, provided that a slight addition to the supply would mean a supply price above the demand price, and a slight reduction of the supply would mean a supply price below the demand price. There may be, but there is not likely to be, more than one such price. It is only possible when increasing returns rules, and if it does, is least likely when demand is highly inelastic." If the reader who has never seen or constructed a figure in which the (so-called) supply curve cuts the demand curve in three places, twice from below and once from above, understands the significance of the proviso contained in the above extract, and also perceives that a point of the unstable equilibrium, which that proviso excludes, must come between the two points of stable equilibrium which it allows to pass, Professor Chapman may call him as a witness in support of his assertion that it is "perfectly easy" to represent such conceptions effectively in non-mathematical language. *Fiat experimentum*. I would not for the world prejudge it.

The implications of the first sentence quoted above need more lengthened consideration. As interpreted by Professor Chapman's work, at any rate, they involve an approval of Dr. Marshall's deliberate (and very chivalrous) method of minimising and disguising to the utmost extent possible the revolutionary character of the new methods of which he is so eminent an exponent. This attempt to preserve as much as possible of the old terminology, and the traditional divisions and contrasts, in the face of the new principles, and to show how much substantial truth the admittedly imperfect statements of earlier writers contained is one of the leading characteristics of Dr. Marshall's work; and it stands in marked contrast with the somewhat truculent announcement made by Jevons to his brother, "In the last few months I have, fortunately, struck out what I have no doubt is *the true Theory of Economy*, so thorough-going and consistent, that I cannot now read other books on the subject without indignation." To find fault with Professor Chapman's handbook involves something very like a contention that, of the two, Jevons's indignation is likely to inspire a more fruitful treatment than Dr. Marshall's reverence!

And, indeed, the truth is that Professor Chapman constantly enunciates trenchant generalisations which cut across the classical traditions and reduce to mere practical differences of stress what they had taken as theoretical differences of principle ; and then forgoes all the simplifications these generalisations suggest in order to preserve as primary the distinctions which they have really reduced to a secondary position.

Thus on p. 172 we read, "Workpeople have a value to the employer because . . . they create what has . . . a value to the consumers. . . . Similarly, the value of every other agent in production is the transmitted value of what it adds to production at the margin." Now "cost of production" is simply the sum of the market values of the agents or factors of production, and their values are confessedly nothing but elements in the value of the product, dependent in its turn wholly upon the relative estimate formed by the consumers of that product in relation to others ; and yet "cost price" is made throughout Professor Chapman's book to figure as an independent and, in a sense, antagonistic force, generating curves of "supply price" co-ordinate with the curves of "demand price," from which, on his own showing, they must derive the whole of their vitality. Indeed, the most ingenious and original chapter in the book is devoted to an elaborate attempt to work out a complete parallelism between the two. It is perfect as a piece of deductive reasoning, but it rests upon the startling assumption that every firm has unrestricted command of capital and of markets, and determines its output solely on consideration of the dimensions best suited to "the strength of its central organs" (p. 81). At the end of his study Professor Chapman seems to confess that his initial hypothesis is quite remote from the facts. Could he not have remained in close touch with those facts throughout his investigation if he had carried the great principle he announces boldly through ? He would then, surely, have treated the whole direction of resources to ends as a continuous selection between alternatives, guided throughout by a weighing of the significance of the anticipated results, in which the "cost" of adopting any alternative is simply the relinquishing of some other alternative ; reward and sacrifice alike being measured and determined by the ultimate significance of the respective products, as anticipated by the producers ; the points

at which things are bought and sold simply registering the relative success or failure of the anticipations under which the alternatives were selected, and tending to correct them.

In the same way Professor Chapman perceives quite clearly that the conception of "diminishing returns" was originally arrived at by treating one of the factors (land) as constant, and applying successive "doses" of the other factors to it; and also that this method is equally applicable to any other factor (labour, for example), and further, that whereas "labour" in the mass is incapable of rapid increase, yet it may be diverted from one purpose to another to an indefinite extent, and that the same holds of land; and likewise that one factor of production may change its proportion to another and yet the two "doses" thus differently composed may be equated; and that all values of factors of production are derived from the value of their product. Nevertheless, he maintains the old dictum that rent does not enter into cost, keeps the distinction between increasing and diminishing returns as nearly as possible in its old place, and practically excludes land from his general formula of distribution. He defines rent as payment for differential values of any kind (whether of land or labour, for instance), and would admit apparently that it does not correspond to what the farmer pays his landlord any more than to what a rich man pays a fashionable surgeon, and yet he treats it in direct connection with land, and in doing so seems to conceal as far as he can all the theoretical identities he has recognised between land and other agents of production, burying them under insistence upon differences in degree which he utilises to maintain distinctions that no longer rest upon principle.

But it will be perceived that all this is a tilt against the authorised and current treatment of the subject, and not a criticism of Professor Chapman's book specifically at all. Granted that accepted methods are on the whole satisfactory, this book may be taken as an exposition that leaves nothing to be desired. Apart from all controvertible or controverted matter, too, it is particularly admirable in its insistence on the fact that "it is the impalpable subjective things in life, without a price, which give exchangeable goods their value" (p. 164), and in the firmness with which this central principle is held in



the luminous and judicious survey of "problems of distribution" which closes the volume.

##### 5. DAVENPORT'S *ECONOMICS OF ENTERPRISE*<sup>1</sup>

*The Economics of Enterprise.* By HERBERT JOSEPH DAVENPORT, Professor of Economics in the University of Missouri. (New York: Macmillan Company. 1913. Pp. xvi + 544.)

THE inspiration of this noteworthy book, not clearly revealed till we come to its closing pages, is a determination to deal a "knock-out" blow to the assumption of a rough coincidence between individually gainful and socially valuable occupations, privileges, or positions. No one, perhaps, would deliberately assert that such a coincidence exists, even in the large; but almost every one assumes it as normal, and reasons as if it were almost universal. And this optimism makes a great deal of economic literature little better than apologetics, welcomed by those whose consciences need a soothing syrup, and cursed by those who realise the "wounds and bruises and putrefying sores" skinned over by the use of such words as "productive," "useful," "the supply of human wants," and the rest.

Professor Davenport estimates that at least two-thirds of the capitalised wealth of the United States consists merely of "the present worth of the right to extract tribute from one's fellows or to plunder one's fellows" (p. 520). But this is not all. Those who are paid for "services" genuinely rendered are not necessarily paid for socially significant services. We live under an individualistically organised industrial system, and whatever produces a valued experience, for which a man will pay, counts as "service," even though it destroy the sources of experiences valued by others, and even though the experiences actually secured be destructive of character and permanent well-being.

On all this Professor Davenport is never weary of insisting with startling frankness and with abundance of illustration, always with the objective in view of demonstrating the necessity "for some one to construct an economic science adapted not only to the requirements of the facts, but to the needs

<sup>1</sup> [Reprinted from *The Economic Journal*, Vol. XXIV., No. 95, London, 1914, pp. 421-425.]

of their amelioration" (p. 528), inasmuch as we live "in a competitive society, most of the serious problems of which sum up into one great and inclusive problem: how to limit the receipt of private income to the rendering of social service" (p. 416).

By far the greater part of the book, however, is devoted to strictly economic problems, and is concerned with the consistent working out and application of economic principles now generally accepted but seldom applied with adequate firmness and thoroughness.

Underlying all is a destructive criticism of the old distinction between productive and unproductive occupations. The only ultimate "products" are necessarily psychic. Material things are means; experiences, in the widest sense of the term, are the ultimate and only product. Anything that is paid for, or that is undertaken for any deliberate purpose, is so paid for or undertaken because it is expected directly or indirectly to conduce to desired experiences. That is to say, because it is regarded as "productive." It is its desiredness, not its desirability, that counts, and that makes it productive in the only sense in which the term can find a place in the economic science of a competitive and individualistic society. The true distinction obscurely felt under the old discussions is the difference between the more or less rapidly disappearing commodities and the more or less permanent ones. A permanent good produces a revenue as long as it lasts, and it makes no matter to its productiveness whether the revenue is of material things that may in their turn produce experiences (as in the case of a tool) or a revenue of directly desired experiences (as in the case of a work of art—or an indecent book). As long as it exists it increases the revenue of desired things.

Independently, again, of this underlying contention, though not out of relation to it, is the analysis of the fundamental phenomenon of our industrial system, the market. Professor Davenport is to be congratulated on the precision and effectiveness with which he has demonstrated the ruling fact that the usual cross curves of supply and demand, with their point of intersection determining the price, rest on a superficial and misleading analysis. "The reservation prices of the sellers are, in the ultimate analysis, demands, and are as important to the fixation of price, and important *in precisely the same way*

[the italics are the reviewer's], as are the price-paying dispositions of the seekers for goods" (p. 55). The tabular demonstration of this principle on p. 51 ought to place it conclusively above challenge.

A precisely analogous line of investigation stubs out the very roots of the "cost of production" theory of value by showing that the "cost" of any factor of production is simply its estimated significance in other branches of production, so that (like the reserve prices of the holders of a commodity) it should be incorporated bodily in the demand curve. And, finally, we might "almost as well speak of the child who chases the wave up and down the shingle as fixing the wave-front, as speak of any margin as determining the price" (p. 94).<sup>1</sup>

It goes almost without saying that Professor Davenport abandons the doctrine of specific laws of distribution, and especially of the peculiarity of rent as a special category. There is the law of the market, and there is nothing else. The Law of Diminishing Returns yields nothing but confusions and ambiguities until we perceive that "the principle of disadvantage from a poor combination of factors, and of advantage from a wise combination, is applicable not only to the relations of land to the other factors in production, but also to the relation of all the other factors to land, and to the relations of all the other factors to one another" (p. 444). But, unlike many other economists, our author, having destroyed the theoretical basis for a special treatment of land, resolutely declines to reinstate it on technological and practical grounds. On the contrary, he exposes all such attempts to a merciless fire, and adds the luminous suggestion that they have their real origin in the legal distinction between real and personal property. "It would, then, be a most interesting investigation, if only one had the necessary learning, to trace out the manner and degree of connection between the legal distinction of realty from personalty and the economic distinction of land from capital. That the parallelism

<sup>1</sup> No more significant illustration of the insidiousness of the fallacies thus exposed could be found than is furnished by the fact that after all he has said Professor Davenport frequently allows himself (deliberately) to speak of the "intersecting curves," and is occasionally guilty of an unconscious lapse such as that on p. 481, where he says that "in the long average, price cannot fall below the marginal producer's sacrifice," instead of "the marginal producer cannot in the long average maintain a position in which his sacrifice exceeds the price of his product."

is more than merely fortuitous may be taken as beyond doubt" (p. 510).

The general exposition of the principle of distribution, though substantially sound, suffers, in point of clearness, from an attempt to make two meanings of "marginal" (recognised as distinct) run abreast, and from failure adequately to distinguish between the declining significance of homogeneous units *successively* consumed, and the varying significance of any unit as it forms a member of a larger or smaller group of homogeneous units *simultaneously* engaged in combination with some other factor or factors. Moreover, it is the doctrine of substitutions between productive factors which gives the finishing touch to the theory of distribution and shows the complete analogy between the process by which each individual entrepreneur adjusts the estimated significance which each factor has for himself to the market price, representing the (marginal) significance of the same factor as estimated by others, and the parallel process by which the individual consumer so regulates his expenditure as to bring the marginal significance of all the articles he consumes into coincidence with their prices. Yet it is not until long after he has finished his formal treatment of the problem of distribution that Professor Davenport gives us (on p. 428, for instance) his most luminous observations on this theory of marginal substitutions which is essential to it.

But in spite of such faults of arrangement and the like (our criticisms of which might in truth be considerably expanded), it is impossible not to be impressed by the sweep of the whole demonstration, the unifying of principle, and the absorption of apparent obstacles or contrasts into the one continuous movement from resources commanded to experiences desired.

Professor Davenport systematically starts from the point of view of the entrepreneur, looks at things first as they appear to him, and then goes on to show that the limitations of his point of view must be transcended before the economist can be satisfied. Hence, perhaps, the title of the book. But the central portions in which the special problems of currency, banking, the loan fund, credit, crises and depressions are discussed is the part which is most closely connected with "Enterprise." At the same time, it is the least satisfactory part. It contains many good suggestions and shrewd observations,

but an apparent want of mathematical precision vitiates some of the conclusions, and a clue is sometimes dropped when it seemed to have been firmly seized. Thus on p. 317 the "quantity law" is conclusively rejected. "As gold falls in the commodity market, it has to fall as money; prices go up." And, again, "The quantity of media is changed as a result—not a cause—of the changed level of prices." And yet on p. 329 we read, "It is evident that, with bimetallism once established, the supply of coin for money purposes will be greater and general prices higher than had either metal been used alone." Translate this by the formula just given, and it asserts that coining two metals at a fixed par will lower the price of both of them in the commodity market—for how else could it make more coin enter into circulation? But to detect this and other such apparent inconsistencies in a writer who has inspired so much confidence inevitably suggests to the reviewer the question whether he has really understood the author.

SELECTED SYLLABUSES OF EXTENSION  
LECTURE COURSES <sup>1</sup>

THE ELEMENTS OF POLITICAL ECONOMY (VALUE OR  
WORTH), 1891

*LECTURE I*

THE PLACE OF ECONOMICS IN SOCIOLOGY

DEFINITION of Political Economy or Economics, as the study of the "Laws of the production, distribution, exchange [and consumption] of [material] wealth." Better, perhaps, "the making, sharing, exchanging [and using] of [material] wealth."

Rival definition as "the art of disposing wisely the concerted labour of societies."

Is it an art, like Politics or Domestic Economy ; a science of conduct, like Ethics ; or a science of mere observation, abstraction, and deduction, like Physics ?

Mill and the "economic man." Ruskin's objections. Walker and Marshall.

The further development of this conflict of view will hinge upon the place assigned to "consumption" in economic studies.

Tendency to exclude "consumption," or regard it as significant only because it is assumed in "production."

Even so considered, Ricardo and Ruskin alike at fault in their theories of production and exchange, owing to a defective psychology of "consumption." This psychology an essential topic of Economics.

But accurate treatment of "consumption" spontaneously leads to discrimination between the "creation of wants" as

<sup>1</sup>[As explained in the Introduction, for a very long period Wicksteed was a lecturer under the University Extension system. The following syllabuses have been chosen as representative of the field covered by his lectures in Pure Economics and as indicative of the development of his views on this subject.]

a blessing, and the "creation of wants" as a curse, and so links Economics to Sociology in the wider sense.

Breakdown on all sides of the attempt to make the "economic man" the sole subject of economic science.

Relative justification of the objection to political economy as an "immoral study."

Well-grounded distrust of the study of man as a wealth-making and wealth-desiring animal, unless at the same time he is considered as a wealth-using animal, and therefore as an animal pursuing an end to which wealth is but a means.

Growing recognition, by recent economists, of the necessity of finding the directive principle of economic study in a social ideal.

Does this make Economics a science of conduct?

Relative justification of the isolated study of the "economic man."

The motives ascribed to him are real and efficient. In such societies as ours they will assert themselves and organise themselves. It becomes important to ascertain what they will lead to. When we know how men will act or will tend to act, and what relations and institutions will establish themselves or tend to establish themselves under the influence of the desires "to obtain wealth and to escape effort," we shall then know at what points, if any, it is desirable to interfere, by concerted effort, with the spontaneous organisation of the individual self-seeking and self-sparing impulses.

1. "Economy" means ruling or disposing of the house or establishment, and "political economy" means disposing or ruling the establishment of the city or state. What thoughts on the subjects discussed in the lecture are suggested by these etymologies?

2. "Wealth" means the state produced by "weal," as "dearth" means the state produced when things are "dear," and "health" the state of things that are "hale." Is any moral hurt likely to arise from confining the word to "utilities fixed in material objects," and if so, how far is "political economy," as taught by the orthodox school, responsible for it?

3. "Political Economy is a science in which there is much to learn, little to do." Draw out and criticise some of the philosophical or other assumptions that underlie this statement.

## LECTURE II

## THE ESSENCE AND THE FORMS OF INDUSTRY AND INDUSTRIAL-PHENOMENA

Many of the English economists appeared to regard their hypotheses as nearly corresponding to universal facts.

Hence a reaction discarding economic theory, and substituting historical, social, and statistical enquiry.

Doctrine of the relativity of economic truths, illustrated from England, India, and America.

Necessity of distinguishing between an absolute principle and its relative manifestation. The former universal and uniform. The latter conditioned by the moral, social, political and industrial circumstances under which it works itself out.

Economic theory must trace back every industrial manifestation to its ultimate principle, and so affiliate parallel manifestations under various social and industrial regimes to their common source.

Arithmetical illustration.

Random and misleading speculations resulting from failure to work out economic theory on these lines.

Illustrations. Phenomena of price and circulating medium carried back to diversity of tastes, and ultimately to universal phenomena and laws of preference. Phenomenon of rent carried back to differing nature of services rendered by land of various qualities and various sites. Importance of carrying back phenomenon of interest to a like ultimate principle. The test of our having done so will be our ability to explain the transformations of interest on Robinson Crusoe's island, under state socialism, in a perfectly altruistic community, etc. Or if it would disappear under any of these regimes, to say exactly why, and what parallel modification would make it disappear under our own regime.

Local or special phenomena, such as low wages, irregular employment, competition, over-production, etc., etc., must likewise be reduced to their ultimate and universal expression, and traced through their possible transformations, before they are fully understood.

By a parallel process we shall come to understand the motives supposed to actuate the "economic man" as them-



selves special manifestations of deeper psychological principles, and shall so estimate their true place in the philosophy of society.

1. In what form could the principle underlying "rent" appear in Robinson Crusoe's island? Has it ever appeared, or could it ever appear in the same form in an industrial community?

2. Has the author of *Looking Backward* confounded the suppression of money with the suppression of exchange?

3. What is the true function, and what are the necessary limitations and the chief dangers of economic "Utopias"?

### LECTURE III

#### VALUE IN USE AND VALUE IN EXCHANGE

Economic meaning of terms "useful" and "utility." Objections [cp. Lecture I]. Possible substitution of "desired" and "desiredness."

Adam Smith on value in use and value in exchange. Current criticism of his instances beside the mark.

Value in use, as a category, obviously independent of social or industrial institutions. Constituted by relations existing between men and things.

If a nation is wise in its desires, then to increase use-values is to increase well-being. In any case it is the goal of industry.

Wealth must have use-value to be wealth. But the converse is not true. Many valued things do not figure in a schedule of wealth and have no exchange-value.

Yet exchange-value is a form of desiredness. What is its relation to the other?

Instances in which decrease in supply diminishes total use-value, but increases exchange-value. Schedule of wealth shows better, but well-being is impaired.

Use-value seems only to refer to desiredness of the article in the eyes of its possessor. Exchange-value refers to its desiredness in some one else's eyes. But it is not that other's desire for *some*, but for *some more*, that determines exchange-value.

This leads to distinction between total use-value, average

use-value, and use-value of last available unit. Coincidence of use-value of last available unit with exchange-value.

Use-value of marginal unit governs exchange-value of all.

Further illustrations of the marginal unit controlling the whole series.

1. Give illustrations of your own of apparent contrasts between value in exchange and value in use.

2. Give instances of your own of the action of the "marginal" man or thing upon the whole series.

3. In what respects does the "income" of a nation fail to represent its annual "revenue of enjoyment"?

#### LECTURE IV

##### VALUE IN EXCHANGE A RATIO

All desires, or estimated enjoyments, ideally commensurable when existing in the same subject.

Value in exchange implies a ratio of equality.

Things exchanged must be heterogeneous or there would be no exchange, and must be homogeneous or there could be no ratio between them.

Obvious in what they are heterogeneous. Where is their homogeneity?

(a) Marx's answer. They are homogeneous as products of human labour.

(b) Jevons's answer. They are homogeneous as "commodities" or "utilities."

Against (a) it is urged: If I make a thing that no one wants, it will not exchange, in spite of efforts and sacrifices needed to produce it. Things that are wanted may exchange in the same ratio though they have cost different quantities of labour. Illustration of wheat grown in England and wheat grown in America. Many things not now produced, or never produced, exchange. Pictures by old masters, rare books, wine of special vintages, land, etc. "Labour" Theory of ratio of exchange cannot apply in those cases, and therefore is not true.

Against (b) it is urged: If, because of some invention, watches can be made with less "labour" than before, they will become cheaper, *i.e.* their ratio of exchange is altered, but they

are not less useful. Increased difficulty in getting a thing makes its exchange ratio rise, but cannot increase its usefulness. Water is more useful than wine, but not so valuable, because easier to get. Therefore it is not the usefulness of a thing that determines its ratio in exchange.

Objections to (b) not valid, when we bear in mind that the value in use of each successive unit varies, and that it is the value in use of the marginal unit that governs that of all the rest.

Further and more precise treatment deferred.

1. Are there any other uses of the word "value" than those dealt with in the lecture? If so, how are they related to them?

2. Is it legitimate to use such abbreviated expressions as "labour" for "sum of efforts and sacrifices," or "land" for "natural agents of production and primary sources of wealth"? Point out any advantages or dangers of the practice.

3. State, as concisely as you can, any phenomena of "value" not adequately met by the theory developed in the lecture; or any difficulties it has left in your own mind.

#### LECTURE V

##### GRAPHIC METHOD OF PRESENTING SERIES OF CONNECTED RATIOS

Both exchange-values and use-values are ratios. Total use-values are sums of series. Terms of series are magnitudes determined by ratios, referred to standard of measurement.

Graphic method of presenting series of connected ratios, based on representation of each ratio by two lines.

Nature of a function. Illustrations. If one quantity is a known function of another, the connection of the values they successively assume can be represented by a curve. Functional curve. Meaning of "variable."

But we may wish to register, in a convenient form, a series of successive or co-existing phenomena which are not functionally dependent on any variable represented in the chart. Descriptive curve.

1. Give instances of the actual use of descriptive curves, and the actual or possible use of functional curves, in the arts and sciences, history, etc., etc.

2. Give instances of quantitative functions incapable of exact measurement. Are there any which, in their nature, are incapable even ideally of being measured?

3. Discuss the question whether the desire for more money generally decreases as the quantity possessed increases.

### LECTURE VI

#### THE ECONOMY OF ROBINSON CRUSOE'S ISLAND

The value of "Robinsoniads" [cp. Lecture II]. Preliminary discussion of the theories of labour and of marginal equivalence.

Principles on which to construct Robinson's curves of "quantity possessed and marginal intensity of desire for more" with respect to articles he can secure by labour.

Principle of distribution of time between two occupations.

Introduction of a third occupation, and establishment of standard return to unit of labour.

Ratios determining marginal equivalence of heterogeneous products at every stage. These are potential ratios of exchange.

Why labour test and marginal desiredness test of equivalence of products yield the same result.

Hypothetical restrictions on ability to produce the commodities.

Diagrammatic representation of principle of division of labour between rival claims.

It remains to trace the action of these principles in industrial societies as we know them.

1. Imagine any circumstances you choose, and then try to construct your own curves of "quantity possessed and marginal intensity of desire for more" with respect to some two or three articles, as they would be under the supposed circumstances.

2. Construct accurately (from arbitrary data, if you prefer it) a diagram showing the principle of division of time between

two occupations. To what other economic phenomena may the same principle be applied?

3. It is often said that the exchange-value of articles is determined by the amount of labour they respectively contain. It can hardly be maintained by any one that the "marginal equivalence" of articles is so determined. What is the connection, or what the difference, you suspect or can establish between value in exchange and marginal equivalence?

### LECTURE VII

#### RELATIVE SCALES AND THE CONDITIONS OF THEIR COINCIDENCE

*A* enjoys supplies of commodities U, V, W, X, Y, Z, the customary units of which (supposed "small") are *u*, *v*, *w*, etc.

The marginal units will stand in certain definite ratios of desiredness to each other. And these ratios when tabulated will constitute *A*'s "relative scale."

*B* likewise has a "relative scale" on which some of the commodities U, V, W, etc., are represented.

In a freely exchanging and frictionless society, *A*'s and *B*'s relative scales of the commodities possessed by both must agree.

---

1. Compare your own expenditure, in respect of certain articles, with that of some friend whose tastes and needs differ from yours. What bearing (if any) have the facts on the truth or error of the contentions of the lecture?

2. If it is normal for us to satisfy all our wants down to the same point of urgency, how is it that we are nearly always conscious of wanting a little more money, not for everything, but some one thing?

3. What are the chief practical obstacles to our free exchanging of commodities? And what is the result on the correspondence of our "relative scales"?

### LECTURE VIII

#### THE MEDIUM OF EXCHANGE AND THE ABSOLUTE MEASURE OF THE RELATIVE IMPORTANCE OF COMMODITIES

Impossibility of making a bridge between intensity of *A*'s and *B*'s desires for a given object.

Genesis of desire for articles not of use to the person desiring them.

Genesis of a standard of measurement. The properties needed to establish it as such, and the properties it acquires by being so established.

Gold as a standard.

1. "A shilling has more value to a poor man than to a rich man." "A shilling has more value to poor men than to rich men." "A shilling has more value to a man when he is poor than when he is rich." In what sense is "value" used in these sentences? Distinguish between the assertions they make respectively; and say whether, in your opinion, any or all of them are warrantable assertions.

2. How would a "state of siege" affect the value of gold? And why and to whom would it retain any considerable value?

3. "The simple-minded suppose that it is a 'divine majesty' that makes the subjects; whereas in truth it is the subjects that make the 'divine majesty.' So the simple-minded think that things are valuable because they will change for money; whereas in truth money is valuable because it will change for things." Briefly analyse and criticise this dictum.

### LECTURE IX

#### LAW OF DISTRIBUTION OF PRODUCTIVE EFFORT AND POWER

Equating and comparing desires for same thing existing in different subjects. Necessity and danger of the process. Its relativity never to be lost sight of.

Construction of a communal curve of demand. Its equivocal character.

Digression on units. Reading of curves not affected by change in the unit. Examples and exercises.

Analogue of the "Robinsonian" law reappears in the industry of a community. Its practical significance.

Complete solution of coincidence of labour test and marginal utility test of exchange-value of freely produced commodities in a freely exchanging community.

In what sense do free production and free exchange secure maximum of enjoyment in return for given effort?

1. Analyse the dictum: "It is a mistake to subsidise anything, for political economy teaches that what men want they will pay for."

2. Construct a curve displaying any physical or economical phenomenon. Then change the units, reconstruct the curve, and show that its readings remain unaffected.

### LECTURE X

#### THE LAW OF INDIFFERENCE. EVASIONS

The "law of indifference" implied in all that has gone before.

Its explicit formulation. A good example of universality of psychological principle and diversity of concrete manifestation.

Embraces phenomena of marginal control, and the law of markets.

Its importance commercially. Its evasions sometimes beneficent and sometimes corrupting. Illustrations.

1. Give a brief account of the succession and connection of topics dealt with in this course. What subjects do you think should come next?

2. Give instances within your own knowledge of evasions of the law of indifference; and state whether they seem justifiable, as judged by current popular opinion, and as judged by yourself.

3. Formulate clearly any difficulties that remain in your mind, on any of the points dealt with in these lectures.

### OUTLINE OF A COURSE OF LESSONS<sup>1</sup>

#### ILLUSTRATING SOME ELEMENTARY CONCEPTIONS OF MATHEMATICS IN THEIR BEARING ON ECONOMIC REASONING

##### I

In Arithmetic.

$$(i.) \quad a + b = b + a.$$

$$(ii.) \quad ab = ba,$$

$$(iii.) \quad a(b + c) = ab + ac.$$

<sup>1</sup>[Originally printed as addendum to the lectures on *The Elements of Political Economy* (Value or Worth) 1891, reprinted above, pp. 827-836.]

$a, b, c$ , etc., being any numbers or fractions, however made up or arrived at.

Further, the formulæ—

$$(iv.) \quad a + b - c = a - c + b.$$

$$(v.) \quad a(b - c) = ab - bc.$$

never mean anything that is not true ; but, in arithmetic, (iv.) does not mean anything at all if  $c$  is greater than  $a$ , nor (v.) if  $c$  is greater than  $b$ .

Method of extending meaning of symbols so as to fit uses already intelligible, and at the same time interpret hitherto unmeaning formulæ.

How does a case of  $a - b$  where  $b$  is greater than  $a$  arise ?

Introduction of graphic method, in which every addition is represented by a step in one direction, and every subtraction by a step in the other.

Conception of "sense" now added to that of magnitude. Reconsideration of notation under this light. Meaning of  $-a$ .

Interpretation of "sense" in any definite problem supplied by its concrete terms ; but the processes of addition and subtraction always imply the determination of two opposite "senses." Thus, it would seem,  $a - b$  must always have a meaning, whether  $a$  is greater or less than  $b$ .

But consideration of (ii.) reminds us of distinctions between operator and operand, and shows us that we have not yet discovered the meaning of  $(a - b)$  as an operator when  $b$  is greater than  $a$ .

Following the same method as before ; when  $a$  is greater than  $b$

$$(a - b)c = ac - bc$$

i.e. the direction "multiply  $c$  by  $-b$ " is equivalent to "multiply  $c$  by  $b$  and then change the sense of the result."

Hence (iii.) may be extended thus—

$$\begin{array}{cccc} \pm & \pm & \pm & \pm \\ a \times b & = & b \times a & \end{array}$$

and  $ab = ba$  must be so understood hereafter.

Rule of Signs.



## II

$$(vi.) (x + a)(x + b) = xx + (a + b)x + ab.$$

Six forms of this identity, according as  $a$  and  $b$  are positive and unequal, negative and unequal, of opposite signs and unequal, positive and equal, negative and equal, or of opposite signs and equal.

Resolution of expressions of form  $xx + 2px + q$  into factors.

## III

Functions, constants, and variables.

Graphic representation of functions.

Graphic representations of expressions of the form—

$$xx + 2px + q$$

as functions of  $x$ , by means of rectangular co-ordinates.

Note points of intersection of curve and abscissa.

$$\begin{aligned} \text{If } xx + 2px + q &= (x + a)(x + \beta) \\ &= xx + (\alpha + \beta)x + \alpha\beta \end{aligned}$$

$$\text{then } x = -a$$

$$x = -\beta$$

represent the values of  $x$  for which the expression vanishes.

$\therefore -a$  and  $-\beta$  represent the lengths and senses of the intercepts between the origin and the two points of intersection with the abscissa respectively. And *vice versa*.

$$\therefore \text{ if } xx + 2px + q = (x - a)(x - \beta)$$

then  $a$  and  $\beta$  represent the lengths and senses of the intercepts in question.

$$\text{Then } \frac{\alpha + \beta}{2} = -p.$$

$$\alpha\beta = q.$$

Whence it may be shown from the figure that if  $\gamma$  be half the intercept between the two points of intersection,

$$pp - q = \gamma\gamma.$$

In such a case as

$$xx + 2x - 4$$

this gives

$$1 + 4 = \gamma\gamma.$$

$\therefore \gamma$  is that which, multiplied by itself, produces 5.

But no number or fraction does this ; 2 is too small, 3 is too great. No proper fraction multiplied by itself can yield a whole number.

$\therefore$  we have a definitely determined magnitude, standing in a quantitative relation to another magnitude homogeneous with itself, but such that it cannot be expressed as a number or a fraction in terms of that other magnitude.

## IV

What does the conclusion now reached mean ?

Multiple scales, and divisions into equal parts. Incommensurables. Relativity of magnitude.

Definition of ratio.

Proof of elementary rational properties of similar triangles. (Sixth book of Euclid.)

Graphic methods of compounding ratios by linear constructions.

Convenience of representing compound ratios by areas rather than lines. Automatic adjustment of figures to changes of unit.

Indication of systems of lines and systems of areas mutually referred to each other by reference to corresponding points and segments of abscissa ; foreshadowing principles of differentiation and integration.

Rules for compounding ratios proved, and shown as the general rules of which rules for multiplying and dividing numbers and fractions are special cases. (Second book of Euclid.)

## V

Definition of a limit. Limiting ratios. Limits not approximations. "Infinite" series. "Infinitely" distant points, etc.

Rates of increase as limiting ratios.

Simple cases of differentiating and integrating.

Infinitesimals and rules for handling them.

## VI

Theory of dimensions.

Change in significance of unit, after differentiating or integrating.

## HIRE AND INTEREST, 1892

## I

**HIRE** as a form of price. Existence of hire implies unsatisfied wants, and therefore insufficient provision.

What regulates rate of hire? Same considerations as in case of price. Begin with "consumer." Kind of goods that are hired. Horses. Pianos. Plates and spoons. Dress clothes. Houses. Lands (?). Intensity of desire for more depends on amount already in use.

Why hire instead of purchase? First group of cases: Land, etc. Production impossible. Second group: Intermittent need for commodities that can be used more or less continuously. Why produce such for hire? Hire a form of exchange. Equating production for hire with production for exchange or immediate consumption. Involves question of immediately available resources. Third group: Current earnings to meet current expenditure. What would be implied in purchase? Balance between present and future, rationally estimated, not coincident in the case of all members of the same society. The men at the margin. Fourth group: Long-lived commodities. The distant future. The heirs of the producer.

Analysis of hire: Replacement or maintenance. Wages. Compensation for disproportionate sacrifice involved in production owing to higher degrees of utility foregone. Compensation for remoteness of future.

## II

Is interest hire? Points of difference. Interest as an exchange between present and future goods.

The man who seeks to anticipate. The man who seeks to defer. Principles of bargain between them. The men at the margin.

Demand. The man in temporary difficulties, the man with expectations, the spendthrift and reckless, the industrial borrower, all compete for supply of present wealth and offer future wealth in payment. All will be supplied down to same degree of intensity of desire.

Industrial borrower's case easiest to examine. What does

he borrow? Amongst other things tools. The function of tools to render labour more efficient. Subject to universal law of declining efficiency. Marginal efficiency of tools will fix rate of industrial hire.

## III

Industrial hire, *de facto*, covers more than allowance for replacement and risk. This is interest, and indicates that the function of tools is not exhausted, and that to the men at the margin future wealth is less valued than present.

Law of distribution of tools amongst industries. Remuneration of labour of self-employed individual a differentially determined area. Interest a marginally determined area. Secondary effect of increased supply of tools upon prices.

## IV

Marginal tool actually yields a revenue, beyond replacement, etc. Thus there is a real means of converting present into future wealth. As relative estimate of future in terms of present wealth rises, supply of tools increases and interest falls. Can it reach zero or become negative?

Stock, loans under stress of need, etc., etc., must all stand at same level as industrial investment.

Effect of rate of interest on supply of tools, etc. Why low interest will never arrest accumulation. Possible effect on accumulation (1) of opening out new fields of industry, (2) of realising a more even distribution of wealth.

## V

Examination and criticism of Böhm-Bawerk's views on interest.

## THE THEORY OF EARNING AND SPENDING (SECOND COURSE), 1895

### LECTURE I

#### METHOD OF INVESTIGATION

To examine the principles that regulate our own conduct in the face of the facts that meet us, including human conduct and institutions.

Enquire how far the principles of our own conduct themselves explain the conduct and the institutions that control us.

The fulfilment of our desires involves certain conduct on the part of others ; therefore a part of our conduct is dictated by a wish to influence the conduct of others ; *i.e.* is itself influenced by such conduct. How far will the reciprocal nature of this influence give us the key to social and industrial phenomena ?

Distinction between acts prescribed or prohibited by Law, and free acts. Identity of underlying principle. Enforcement of Law dependent on the Authority having due command of resources for influencing conduct. What are these resources ?

## LECTURE II

### DEVELOPMENT AND EXPENDITURE OF RESOURCES

Our command of resources, intrinsic or legally secured. Distribution of resources between group of expression, enjoyment, self-development, and direct traffic with nature, and group of influence on and traffic with others, as a means. Possible and desirable overlapping.

Effect of influence exerted on others sometimes vaguely and sometimes precisely measurable. We desire to exercise such influence partly to secure services and commodities directly desired by us, and partly to increase our command of influence on others ; *i.e.* we want some things for ourselves and some because they will give us influence with those who want them. Repeat analysis *ad infinitum*.

Illustrations of tradesman, teacher, etc. Explanation not complete till we have found one who wants the thing, if not for *itself*, yet for *himself* or other defined person in whom he is interested, apart from contemplated transference to others.

Money desired by us because desired by others. No full explanation of this desire obvious at this point, but the facts clearly established. Follow out method of analysing our own conduct and ascertain how far it will take us. Special treatment reserved.

Money as a means of influencing others. Not the only means. In what sense is it "the universal commodity" ? Is it true that "every one will do something for money, and some one will do anything for money" ?

## LECTURE III

## GENERAL PRINCIPLE OF EQUILIBRIUM IN EXPENDITURE

Earning is acquiring command. We can only acquire command we have not by exercising the command we have. Therefore all earning comes under the general law of distribution of resources. Hence a complete enquiry into expenditure of resources includes the theory of earning.

On what principle do we expend resources, and (more narrowly) spend money? Desires gratified, in chunks or continuously, to such point as brings them into equilibrium with rival desires. Total resources administered in view of established prices. Conditions of effective demand. [Law of indifference and margins.] Change of our preferences or resources *tends* to modify prices. Change of many preferences, etc., sensibly modifies them.

## LECTURE IV

## VARIATIONS AND MAINTENANCE OF LEVELS

Buying things of multiform application. Equating applications within limits of stock secured. Anticipated wants (multiform or single) regulate stock acquired, and dictate level at which expenditure thereon equilibrates with other expenditures.

Possible failure of anticipations. Resultant failure of equilibration between marginal efficiency at which stock is consumed and general level of efficiency represented by its price.

Buying stores a specialising of resources. Purchases generally made with more or less precise reference to anticipated period of consumption. Perishable nature of goods may prevent extension of contemplated period; and difficulties of replenishing stores may obstruct its contraction.

In case of commodities that perish slowly (unless consumed) and are easily replenished at steady prices, failure of equilibration between efficiency of stock and efficiency represented by its price may be reduced to vanishing-point, because period of consumption may be indefinitely modified either way. [Illustrations of milk, stationery, and matches.]

## LECTURE V

## PRICE OF GOODS IN STOCK. ITS RELATION TO COST OF PRODUCTION

Summary of last lecture. Any desire  $a_x$  competes for gratification with the desires  $b_x, c_x \dots$  which draw on the same specialised resource  $X$ . The desires  $a_y, b_y, c_y \dots$  in like manner compete for the specialised resource  $Y$ , etc. But if  $X, Y, Z \dots$  are specialised from the same generalised resource  $\Phi$ , then  $a_x, b_x, c_x \dots$  compete (i) directly with each other for  $X$ , and (ii) indirectly (through  $Y, Z, \dots$ ) with  $a_y, b_y, c_y \dots a_z, b_z, c_z \dots$  etc., for  $\Phi$ . Range of possible variation of (i) from (ii). Marginal efficiency of *something* the thing to be considered in every case.

If I offer to purchase any article, I invite the seller to administer a portion of some resource of his in a certain way. His object may be to obtain the maximum command of influencing power (in the shape of money) by the administration of that resource. In any case it is to maximise something. Many or all of the rival desires to be directly satisfied by his stock are not his own but other men's, and reduce themselves to expression on the common scale of money, so far simplifying his problem and making him a reducing machine through which claims on the stock are equilibrated, an equation which is merely objective as between the customers, becoming subjective as well in him. Hence, so far as he is concerned, distribution becomes largely automatic.

The price at which a man offers his goods or services depends (i) upon his estimate of the relation between the present command thereof by himself and others, and the desires ministered to thereby; and (ii) the conditions under which that command can be increased, or the "cost of production," which "cost of production" is but the expression of the relation of less specialised resources to the sum of desires to which they indirectly minister.

Analogy, in principle and in detail, between the relations of (i) and (ii) in this case and in the case previously considered. Marginal efficiency of *something* still the sole thing to be considered.

## LECTURE VI

PRICE OF GOODS MADE TO ORDER, ETC. RELATION TO  
COST OF PRODUCTION

The (ii) of last lecture itself analysable into a corresponding (i) and (ii), and so on till we come to the ultimate resources of humanity.

When I order goods not yet made my claim is immediately equilibrated with the other claims on the material and skill that go to the making of such goods, and the levels at which all claims balance will be the marginal efficiency of such material and skill.

Hence the "tender" price of goods, or the "cost of production" to the contractor, may vary from the ultimate "cost of production" on the same principles on which (i) varies from (ii) in the last lecture. "Tender" prices are terms on which the offer is made to deflect relatively undetermined possibilities into given channels, and are determined by the marginal significance of the still unspecialised resources in question.

Each separate "factor of production" will enter into the "cost of production," immediately according to its own marginal efficiency, indirectly and ultimately according to the marginal efficiency of *its* "factors of production," but always according to the marginal efficiency of something.

## LECTURE VII

## COST OF PRODUCTION AND THE THEORY OF VALUE

"Cost of production" itself a form of marginal efficiency. Theory of marginal efficiencies therefore gives complete account of prices and values.

"Cost of production," as history, without influence on any prices, except by errors of judgment and association.

"Cost of production" as an estimate, the form under which the supposed marginal efficiency of the "factors of production" expresses itself.

Bad economy, in private life, of trying to want things because we have paid for them; *i.e.* valuing them at their cost of production. Bad economy of similar tendency in busi-



ness to cling to erroneous estimates and act on them after they are exploded.

Distinction between biding our time and crying over spilt milk.

### LECTURE VIII

#### PRIMARY RESOURCES AND THEIR DIFFERENTIATION

Climbing up to the ultimate resources of humanity, we find them to be Human Faculty (mental and bodily) and the Naturally Produced Substances and Creatures. These are loosely spoken of as Labour and Land.

Man's direct action consists entirely in moving things. He learns to modify or apply the movements of animals and of things that move themselves; and also forces that can be made to move things.

Every modification of natural substances and creatures with a view to making them directly or indirectly satisfy the wants of man is a specialising and is often irreversible. Determining of undetermined faculties may be the same.

Industry and education thus mark off relatively isolated areas within which competition may raise or depress the level of marginal efficiency and urgency; such level varying, in greater or less degree, from the anticipation that dictated the deflection of primary resources.

Force of tradition in determining what alternatives shall be recognised and ignored.

### LECTURE IX

#### HISTORICAL GROWTH OF INSTITUTIONS

All material resources (primary or specialised) absolutely limited, many limited relatively to the desire for them. Institutions that regulate the control of such resources.

The control of human faculty may be more or less effectively secured by institutions to the person exercising it or to some other.

[“Institutions” only effective so far as supported by control of the resources for influencing human conduct; and by the *vis inertiae*.]

The special character of the Institutions of any Society determine the economic categories under which the universal law of distribution expresses itself.

With us the historical evolution has produced classes that have faculties without control of materials, and classes that have control of material far in excess of their faculties to work. Hence Rent, Hire, Interest, Wages, become important Economic Categories.

The law of Rent and the law of Wages (or, more generally, of Earnings) are immediately deducible from the general theory of expenditure. The law of Interest presents some difficulties.

### LECTURE X

#### INTEREST

Man a fore-looking animal. Future satisfactions may enter into competition with present satisfactions. Equilibrating in case of storing, preserving seed, rearing cattle, etc.

Exchange between two men, one giving and the other taking promise of future wealth in exchange for present wealth, obeys the general law of exchange-values.

A tool, owing to its fertility or periodic yield, is a means of actually transforming a volume of present resources into a stream of future resources. Promises of future wealth cannot buy present wealth cheaper and need not buy it dearer than at the rate of actual transformation; this competitor taking its place amongst the rest and like them being subject to reductions of keenness as it is more fully satisfied.

The purchaser of future by present wealth will get a premium as long as tools are fertile. Conversely tools will be kept fertile as long as any man is able and willing to bid for present in future wealth above par.

#### QUESTIONS

*[The Lecturer will indicate which Questions are to be answered in connection with each Lecture.]*

1. Give instances of the partial or complete coincidence of Production and Consumption in your own experience; and instances of their complete failure to coincide.

2. I buy something "for a present," and the person I give it to does not value it. Who, if any one, can be said to

have "wanted it for himself" in this case? If no one, is the whole transaction unexplained on the theory of the lectures?

3. Give instances of things which their possessors *cannot* give for money; of things which *could* be given for money, if their possessors chose to give them, but which in specific cases the people who want them cannot get for any money; of things which really can be got for money, though one's first impression would be that they could not.

4. Give instances in which you are consciously restrained by the Law; in which you deliberately break the Law; in which you reckon upon the conduct of others being restrained by Law.

5. Examine any cases you know in which perishable goods are, or seem to be, sold at fixed prices.

6. Give instances of change of fashion (in time) or variety of fashion (in place) affecting prices, permanently or temporarily. Analyse the process by which the result is brought about.

7. Give instances in which you habitually do and instances in which you habitually do not think of the price of a thing as you use it.

8. Give instances of different ways of spending money which you usually think of as alternatives. Are there "non-competing groups" within your budget?

9. Give instances in which Tradesmen or other Dealers might raise their prices on occasions of temporary and local scarcity, but do not. Analyse the situation.

10. Is it true that generally speaking a man's sole object in doing business is to "make money"? Is it true that no man enjoys business unless he is making money by it? Are the two questions practically identical?

11. Can the phrase "cost of production" be applied to literary or artistic creations? What would it mean or what would be the nearest analogue to it in the case of a lecture, a picture, a scientific discovery? Has it any connection with price?

12. Examine instances in which factors of production enter into "tender" prices at levels widely variant from that of their own cost of production.

13. Instances, within your own experience and observation, of confused ideas as to what constitutes "waste"; and attempts

to make use of things because of the price paid for them. Is there ever a sound principle behind such attempts ?

14. Illustrations of the danger of speaking of "Labour" and "Land" as the sole primary sources of wealth.

15. Analyse some relatively complex industrial operation into its ultimate elements ; shewing the part that intentional movement of material substances takes in it.

16. Instances in which a special training closes and in which it opens alternative possibilities.

17. What is the equivalent of Wages under a Slave system of Industry ?

18. Examine any current objections, from the moral and social side, to living on Interest. How far are they really proper to interest, and how far do they logically apply to other receipts ?

## GETTING AND SPENDING, 1905

### PART I

#### CHOOSING AND EXCHANGING

##### LECTURE I

#### THE LAWS OF THE MARKET AND THE LAWS OF LIFE

**METHOD** of study. The principle of proceeding from known to unknown universally admitted. But what is the "known" ? Aristotle's distinction between "first in nature" and "first to us." We may proceed from the "intellectually precise" to the "practically familiar," or *vice versa*. Illustrations.

The classical theory of Political Economy tries to isolate the main motives of business actions, and to substitute precise and systematic conceptions for the contents of such terms as "capital," "rent," etc. From these "precisely intelligible" data it forms by deduction a hypothetical science that they may be expected to give a first approximation to the actual effects of industry. Corrections may be introduced subsequently.

Objections to this method. The simplified psychology is too remote from fact ; and the systematised conceptions establish a dangerous divergence between technical and popular use of terms.

The method has led to no such triumphant success as to prelude the attempt to begin with the "familiar" and work back to the "precisely intelligible." Such an attempt to be made in this course of lectures.

Taking the phenomena of industrial and commercial life as we find them, we see that they constitute a branch or branches of *conduct*, and therefore belong to the same group of subjects as ethics, politics, etc.

May be studied historically, psychologically, or didactically, though it may not be possible to follow any of these lines without reference to others. The theoretical or abstract treatment (here contemplated) must begin with the psychology (or study of the motives and principles) of men's actual conduct in the relations in question.

Take a familiar incident of practical economic life, such as "marketing." Current phraseology shows that its principles are analogous to those of other branches of conduct. "You cannot have it unless you are willing to *pay the price*." "Is it *worth it*?" etc. The psychology of marketing an application of the psychology of choice.

Qualifications of a good marketer, special and general. Different types of bad marketing. The principle of good marketing. What is a thing "worth"? Worth in money, worth in time, in effort, in influence, etc.

Process of choosing between purchases at two stalls in the market analogous to that of choosing between two courses of life. The market. The home. Life. Common measure of unlike things and motives.

What is "waste"? Using for one thing what was "worth" reserving for another thing. Distribution of any commodity amongst the various claimants upon it.

Relation of expenditure on different commodities. Failures of correspondence between the worth of an article as consumed and the price paid for it.

### *Questions*

1. Do you notice any differences in the economies of old and young people that can be accounted for by changes in price imperfectly realised by the former?

2. Examine the following phrases: "Each competitor in

the race was given a pailful of water, and he who first brought the pail to the goal having spilt least water gained the prize." "If you give us any option, I should propose that our walk be to the nearest and lowest hill." "A benevolent man attempts so to regulate his conduct as to secure the greatest good to the greatest number." "A hypothesis must explain the facts; and that hypothesis is best which explains (i) the most important, and (ii) the most numerous facts." "Cheese is as nutritious as a pound and a half of beef." "I prefer leisure to money." "I have never hesitated to sacrifice elegance of rendering to literal accuracy."

3. Give instances in which you and others have refused to buy a thing at an "unreasonable" price, though conscious of incurring disadvantages by such conduct. On what principle was the refusal based?

## LECTURE II

### ALTERNATIVES AND THE CONSIDERATIONS THAT MODIFY CHOICE

We hesitate between two alternatives and finally select one of them. What are the conditions a change in which would affect our choice?

1. Change of "price" affects the nature and character of our purchases, *i.e.* affects our selection between the two alternatives open to us. The generalised form of "price" is "terms on which the alternatives are offered to us." Tendency of current forms of speech to ignore this quantitative factor in acts of choice.

2. "Second helps are never as good as first." The terms on which I am willing to secure a thing affected by the stock I already possess. The phenomenon of "diminishing returns" as a psychic principle.

Use of expression "as much as I want" for "as much as I want *at the price.*" Significance of a given quantity of any commodity dependent upon supply already secured.

Consideration of stock or supply already secured combines with consideration of prices or "terms" to decide choice.

The psychology of choice has led us to the psychology of "consumption." But the study of "consumption" is the key to the whole study of Political Economy. Significance of in-

creased attention paid to this branch of the study. Incompatible with the maintenance of the old simplifications and restrictions. Study of the law of "diminishing returns," *i.e.* the "psychology of consumption," gives us our commanding principle and commanding point of view. Not till we understand it in its generality can we safely apply it to the study of special branches of conduct.

### *Questions*

1. First think who, of all the persons you have personally known, strikes you as having been wisest in general conduct and practical conception of life. Then give some account of his character and way of life.

2. A taste for reading is usually regarded as a desirable disposition, often as a virtuous one. Give your own opinion, and its reasons.

3. Do you ever say, "I shall have to buy such and such a thing, but I do not want to"? Do you ever say, "I do want to buy this, but I must not"? Why, under such circumstances, do you buy what you do not want to buy, and not buy what you want to?

### *LECTURE III*

#### ADMINISTRATION OF VITAL RESOURCES

Universality of psychological principle of "decreasing returns." Returns decrease only "after a certain point." Extreme theoretical importance of this fact. Reason why it seldom engages our practical attention.

Alleged exceptions to psychological law of "decreasing returns." Money. Artistic and literary enjoyment. Distinction between immediate satisfaction and the cultivation of capacity for enjoyment.

Craving and capacity for enjoyment. Typical case. Characteristics of ruinous enjoyment. Characteristics of "vicious" indulgence. "Unsuccessful luxury." Significance of the habit of self-control.

Getting more of a thing desired may mean getting less of some other independent object of desire, or getting more of

some undesired result inherent in the securing of it. Aristotle's doctrine of the mean. The mean as a maximum. Illustrations.

Relation of the material to the mental life. Means and ends. Area of coincidence. Distinction between the most necessary and the most essentially significant things.

Direct and indirect pursuit of the ultimately desired experiences. Morality and religion ; socially as registers of accumulated experience and as traditions ; personally as attempts to vindicate a general solution against a special escape or dodge.

Personal wisdom. Relation of wisdom to goodness. Area of coincidence.

Interest in the well-being of others as a motive. Is it subject to the law of diminishing returns ?

Are considerations of duty and of religion absolute, *de facto* and *de jure* ? Confused use of words veils a quantitative element. The *minimum pensabile*.

### Questions

1. Give instances of different ways of spending money which you usually think of as alternatives. Are there " non-competing groups " within your budget ?

2. What is there in common between gambling and insurance ? What is the essential difference ?

3. In the Dutch towns there are many old houses, very substantially built. This has been explained by the fact that interest was as low as two per cent in the latter part of the eighteenth century. What is the connection ?

## LECTURE IV

### ADMINISTRATION OF PECUNIARY RESOURCES

Things purchasable and things not purchasable. No sharp line between them. There are many things which cannot be had for money ; nothing ultimately desired can be secured by it ; but there is nothing that can be had or enjoyed without money.

Special consideration of the administration of pecuniary resources raises no new questions as to the principle of diminishing returns, but the precision of its quantitative measure forces



into prominence a number of problems as to the equating of quantities, the common measure of which is not at first obvious.

Establishment of equilibrium between competitors for available pecuniary resources. Intermediary transformations. Revocable and irrevocable specialisings of resources.

Balance between relatively imperishable things (books, etc.) and perishable ones (food, etc.).

Balance between investing money and expending it on relatively imperishable commodities.

Balance between borrowing money for permanent conveniences and paying for services.

Balance between deferred and immediate satisfactions.

Balance between satisfactions and dissatisfactions. Cases in which the same things (*e.g.* clothes) are bought by one man directly to secure satisfaction; and by another indirectly to avert dissatisfaction.

Variations and maintenance of levels. Question of convenient units and discontinuity.

Buying things of multiform application. Equating applications within limits of stock secured.

Anticipated wants (multiform or single) regulate stock acquired, and dictate level at which expenditure thereon equilibrates with other expenditures.

Possible failure of anticipations. Resultant failure of equilibration between marginal efficiency at which stock is consumed and general level of efficiency represented by its price.

Buying stores a specialising of resources. Purchases generally made with more or less precise reference to anticipated period of consumption. Perishable nature of goods may prevent extension of contemplated period; and difficulties of replenishing stores may obstruct its contraction.

In case of commodities that perish slowly (unless consumed) and are easily replenished at steady prices, failure of equilibration between efficiency of stock and efficiency represented by its price may be reduced to the vanishing-point, because period of consumption may be indefinitely modified either way.

### *Questions*

1. Is it true that, generally speaking, a man's sole object in doing business is to "make money"? Is it true that no

man enjoys business unless he is making money by it? Are the two questions practically identical?

2. "It can never be right for me to provide a man with what he requires in order to do what it would be wrong for me to do in his circumstances." Is this a sound principle?

3. Discuss the ethics and hedonics of field sports and of athletic and other games of skill.

### LECTURE V

#### BUSINESS AND THE ECONOMIC MAN

Importance and persistency of "economic motive" justifies its special treatment, but the hypothesis of the "economic man" inadmissible and unnecessary.

The "law of continuity" and the "second law of motion" embrace all that is needful, and exclude all that is hurtful in the hypothesis of the "economic man."

Place of the "economic motive" in a general social scheme. Free working of principle "To him that hath shall be given" offers no guarantee for a system of distributive justice. Has been thought to do so, partly on the strength of a now superseded system of psychology and partly because of the observed mistakes and failures of administrators.

Administrators must reckon with the "economic motive" and must therefore study and understand it, but not necessarily in order to leave it uncontrolled. Examples of Free Trade and of Factory Legislation.

Practical confusions that rise from inadequate realisation of these principles. Confusions between the intensity of a human want and the price commanded by the means to supply it. Examination of phrases:—"What people want most they will pay most for." "Capital and labour will flow where they are most wanted," etc.

Collective and personal attempts to minimise the conflict between "economic" and social motives.

The "business" nexus. Its initial independence of any specific personal interest or relation.

Impossibility of keeping it isolated. The principle, "business is business" and the humanities of business. The personal

element in business relations and the business element in personal relations.

Money-making as an object and as a condition. Business as an occupation. Business as a game.

### *Questions*

1. Examine any cases you know in which perishable goods are, or seem to be, sold at fixed prices.

2. Examine the statements—"every one can be made to do something for money"; "somebody can be made to do anything for money."

3. What are the most important cases you can think of, of sustained work, identical with or akin to that of business, inspired by other than economic motives?

## LECTURE VI

### MARKETS AND MARKET VALUES

Market values. Value in use and value in exchange. The relative scale of price and consumption in each individual. The collective scale. Constitution of market prices.

"Price" and "quantity sold" functions one of the other. Conditions under which one or the other may be controlled. Impossibility of independently controlling both.

Purely objective character of the collective scale. Widest diversity of subjective significance concealed beneath it.

Markets of labour, business ability, professional skill, capital, etc. Working out of supply and demand through all varieties and complications.

### *Questions*

1. "Bread has great value in use, and little value in exchange." "Diamonds have little value in use, and great value in exchange." Criticise.

2. The "law of indifference" formulates the principle that "there cannot be two prices for the same article in the same market." Give instances in which its effect is apparently or really evaded.

3. What can you ascertain or conjecture as to the fixing

of the retail price of fish, the grounds on which it ultimately rests, and its effect on the conduct of the various persons concerned ?

## PART II

### MAKING AND SHARING

#### LECTURE VII

##### THE FLOW OF PRODUCTIVE RESOURCES

The direction taken by the resources of society under the economic impulse follows the analogy of individual expenditure.

The speculative element in all specialising of resources. Tendency of miscalculation to produce readjustment on the principle of mechanical "governors."

Maintenance of level between the values of specialised resources and the value of the alternatives sacrificed in the process of specialising, subject to conditions and limitations analogous to those already investigated in the case of the individual.

Market prices of natural products and of manufactured articles. (The difference between them only a difference of degree.) Tenders. Investment of capital.

#### *Note on the Controversy as to "Cost of Production" and "Exchange Value"*

Cost of production only influences exchange-value so far as it is another name for the advantage that may be secured by giving some alternative direction to the productive resources concerned. Only as far as such alternatives are still open can it affect value.

No new principle involved in discussion of this problem.

#### *Questions*

1. Do you ever deliberately foster the belief that you will find something useful which your reason tells you will only be an encumbrance, in order to encourage yourself to buy it? Analyse this state of mind. Do you ever "use" things to your

own conscious inconvenience because you have paid for them ?  
If so, why ?

2. " If there were fewer cab-drivers, cab-drivers would be better off ; if there were fewer doctors, doctors would be better off ; and so with others. Therefore, if there were fewer of us altogether, we should all be better off." Examine this argument. Is it ever seriously used ?

### LECTURE VIII

#### THE GENERAL PROBLEM OF DISTRIBUTION

Meaning of " distribution " as a term of Political Economy. The general problem already solved by anticipation in treatment of " markets." The shares of the product that fall to each of the producing factors analogous to the prices of commodities.

Each " concern " estimates labour, tools, land, ability, etc., according to their " worth " as increasing its effective output. Immediate questions—" Is an increase of such a factor worth the cost ? " " Is the (money) saving on a decrease of such factor worth making ? " Ultimate question—" Will an increase or decrease in one factor more or less than compensate the corresponding decrease or increase in some other factor ? "

Those who command the supply of the factors of production are in the position of the holders of commodities in ordinary markets. Current prices of raw material and of labour, for example, determined by similar considerations.

What an increase of a thing is worth to me decides what I am willing to give for it ; what it is worth to others determines what I can get for it.

General law of distribution : Any factor of production can command as much as represents its marginal efficiency in increasing the effective output of the concerns which demand it. Equilibration between industrial and non-industrial application of any agent or commodity.

#### *Questions*

1. A great quantity of iron stone has recently been found a few feet below the surface of the soil in parts of England.

How should you expect this to affect the industrial and financial aspects of deep iron mining?

2. What is the distributive equivalent of Wages under a Slave system of Industry?

### LECTURE IX

#### SPECIAL STUDY OF LAWS OF DISTRIBUTION EARNINGS

Current description of factors of production as Land, Labour, and Capital, and assignment of Rent, Wages, and Interest as their respective revenues. Criticism of this terminology. Ambiguities, especially in the use of the word "Capital."

Popular use of these terms fairly consistent, and convenient, but has little or no scientific value. Attempts to give them the needful precision by definition. Wide resultant divergency between the popular and the technical use of the same terms. Resulting dangers and difficulties.

Our method absolves us from entering into the controversies concerning these terms and conceptions. Their delimitation not vital to our enquiry.

Broad distinction between what we receive in return for something we do, and what we receive for allowing others the use of something we own.

Earnings. The economic paradox.

#### *Questions*

1. Are you familiar with the phrases "Rent of Ability," "Consumer's Rent," in books? If so, criticise them. If not, say what (if anything) they seem naturally to suggest.

2. Is there any sense in which you can speak of the "laws of distribution" and their "co-ordination" in Robinson Crusoe's island before the arrival of Friday? Which of the fundamental conditions and relations that are manifested as earnings, rent or interest, in our community are present in the island? How do they manifest themselves?

### LECTURE X

#### RENT AND INTEREST

Popular distinction between Rent and Interest. Rent and hire. Mortgage. Attempts to distinguish scientifically between

Rent, Interest, Insurance against risk. Great difficulty of making the distinctions answer to economically significant phenomena. Corresponding difficulty as to Land and Capital. Value of such attempts open to question.

Current statements of the Law of Rent. "Decreasing Returns" and Rent as a residuum. Analysis and transformation of the formula.

Owner of land employed as a productive agent shares in product according to general law. Productive and non-productive uses of land as competitors. Necessity of establishing the dividing-line between Land and Capital, and so between "Economic Rent" and Rent as known to practical life, does not arise in this enquiry.

### *Questions*

1. Have you known instances of what you regarded as excessive dread of poverty in old age? How did it manifest itself?

2. Under what circumstances do you think saving is the most suitable way of providing against old age, sickness, or disaster, and under what circumstances is insurance better?

3. Tennyson speaks of the "far off interest of tears." Are you in the habit of using the word "interest" otherwise than for money payments? What is the common underlying idea?

## LECTURE XI

### INTEREST

Though the line between Interest and Rent, between Capital and Land cannot be fixed to any good purpose in this enquiry, yet the ideas currently associated with the terms Capital and Interest raise questions of great importance in Political Economy that do not immediately suggest themselves in connection with the terms Land and Rent.

Element of mystery about Interest that does not characterise Rent. Hot discussions as to whom Rent should go to; but comparatively little discussion as to what it is; and no doubt that it corresponds to some actual fact in the nature of things. With respect to Interest there is the additional con-

flict of opinion as to what it is, and whether it corresponds to any reality in nature. Hence special care and attention should be given to its study.

Tools a characteristic form of "Capital" whether as currently understood or as defined in books of Political Economy. Why do we use tools at all? Revenue in increased efficiency of labour that accrues from the use of tools. Economic point of vantage occupied by the man who can supply you with tools. Decreasing rate of increase. Marginal efficiency of tools determines their market rate of hire.

Equilibration between hire of tools, rent, etc. Also between industrial and non-industrial competitors for present wealth to be paid for in future wealth.

What would zero rate of interest imply? What would negative interest imply? Forces that tend to lower interest and forces that tend to raise it. Analogies with phenomena of individual consumption.

Interest as the "reward of abstinence." Phrase open to ridicule, but directs us to a truth. Wealthy man who cannot use up his wealth, but yet is abundantly "rewarded" for not doing so, only an extreme illustration of the principles that rule every market.

### *Questions*

1. Suppose in a primitive community the peasants turn out for a fortnight every year after harvest to carry on a road towards a neighbouring district, now only approachable by water-way. It takes them many years to complete it. What advantages or disadvantages strike you in this method as against borrowing money to make the road in a few weeks, and raising the interest by taxation?

2. "The first condition of progress is dissatisfaction." "To civilise people is to make them conscious of their wants." "A contented heart is a continual feast." "To rule over a contented people must be the desire of every monarch." What truth can you find in these statements, and how far can you reconcile them?



## LECTURE XII

## CO-ORDINATION OF LAWS OF DISTRIBUTION

The problem of indicating the principles on which an industrial product will be divided amongst those who command the several factors of production is not completely solved unless we can either show that the product will suffice to meet all the claims, according to the principles established, and that when it has done so it will be wholly "distributed"; or else can give a satisfactory account of the excess or defect.

No attempt to submit the theory of distribution to this test, or even to put it into a form to which the test can be applied, is usually made in books on Political Economy. The problem can (apparently) only be dealt with mathematically; and the solution (such as it is) is too technical to be examined here. But some more or less precise idea may be given of the nature of the problem.

Explanation of the formulæ  $P = f(a, b, c \dots)$ .

$$A's \text{ distributive share of } P = \frac{df}{da}$$

Query: Can we be sure that normally

$$\text{the sum of } \frac{df}{da} + \frac{df}{db} + \dots \text{ will equal } P?$$

General result of investigation so far as it has yet been carried is to make it seem probable that in proportion as we approximate to the state of things usually assumed in the Theory of Political Economy (*i.e.* free competition, in which each individual competitor does only a small fraction of the total business of his market) we approximate to the result indicated. So far as we recede from these conditions (for instance, in a great monopoly or trust) we recede from this result and give the persons who control the concern something more than their distributive share in the product as measured by their marginal industrial efficiency.

This result does not vitiate our formula of distribution.

## APPENDIX

### BIBLIOGRAPHY OF WRITINGS ON ECONOMICS AND SOCIOLOGY

- "Das Kapital." *To-Day*, vol. II., pp. 388-409 (Oct. 1884).
- "The Jevonian Criticism of Marx" (reply to G. B. Shaw's criticism of "Das Kapital," in *To-Day*, Jan. 1885). *To-Day*, vol. III., pp. 177-9 (April 1885).
- The Alphabet of Economic Science* (pp. xv, 142). London: Macmillan, 1888.
- The following articles in *Palgrave's Dictionary of Political Economy*, London: Macmillan, 1894, etc.: "Degree of Utility," "Dimensions of Economic Quantities," "Final Degree of Utility," "W. S. Jevons," "Political Economy and Psychology."
- Getting and Spending* (pp. 36). London, 1888. Reprint of twelve special articles entitled "Money" in *Inquirer*, May 19-Sept. 29, 1888. Further unaltered reprint (pp. 52), 1897.
- "On Certain Passages in Jevons's 'Theory of Political Economy.'" *Quarterly Journal of Economics*, vol. III., pp. 293-314 (April 1889).
- What Does the Labour Church stand for?* 1892.
- An Essay on the Co-ordination of the Laws of Distribution* (pp. 56). London: Macmillan, 1894. This Essay has now been issued as No. 12 of the "Series of Reprints of Scarce Tracts in Economics and Political Science," published by the London School of Economics.
- "The Advent of the People" in *The New Party, described by some of its Members*, 1894.
- A Symposium of Value*. Ed. J. H. Levy. London: P. S. King & Son, and The Personal Rights Association, 1895. No. VI. by Philip H. Wicksteed (pp. 38-40).
- "Land Nationalisation." *Transactions of the National Liberal Club Political and Economic Circle*, vol. III., pp. 214-238 (1901).

- "Note on Jevons's Economic Work." *Economic Journal*, vol. XV., pp. 432-436 (Sept. 1905).
- Review of H. Stanley Jevons's "Essays on Economics." *Economic Journal*, vol. XV., pp. 570-573 (Dec. 1905).
- Review of Professor V. Pareto's "Manuale di Economia Politica." *Economic Journal*, vol. XVI., pp. 553-557 (Dec. 1906).
- "The Social Ideals and Economic Doctrines of Socialism." An Address . . . given at Nottingham, under the auspices of the National Conference Union for Social Service. *Inquirer*, Nov. 28, 1908. Reprinted by the Union (pp. 16).
- The Common Sense of Political Economy, including a Study of the Human Basis of Economic Law* (pp. xiv, 702). London: Macmillan, 1910.
- Review of S. J. Chapman's "Political Economy." *Economic Journal*, vol. XXIII., pp. 72-75 (March 1913).
- "The Distinction between Earnings and Income, and between a Minimum Wage and a Decent Maintenance: A Challenge." In *The Industrial Unrest and the Living Wage*. Converging Views of Social Reform, No. 2. Being a series of lectures . . . given at the Inter-Denominational Summer School at Swanwick, 1913. London: The Collegium, 1913.
- "The Scope and Method of Political Economy in the Light of the 'Marginal' Theory of Value and Distribution." Presidential Address to Section F of the British Association. In *Report of the British Association for the Advancement of Science*, 1913, pp. 560-573. Also in a revised form with diagrams, *Economic Journal*, vol. XXIV., pp. 1-23 (March 1914).
- Review of H. J. Davenport's "Economics of Enterprise." *Economic Journal*, vol. XXIV., pp. 421-425 (Sept. 1914).
- "The Mission of the Churches in War Time," in *International Relationships in the Light of Christianity*. Lectures at the Inter-Denominational Summer School at Swanwick, 1915.
- "Who Said 'Barren Metal'?" A Symposium by Prof. E. Cannan, W. D. Ross, Dr. J. Bonar, and Dr. P. H. Wicksteed. *Economica*, No. 2, pp. 105-111 (June 1922).
- "Church and State in Conflict," by Romolo Murri; trans. by P. H. Wicksteed, *Hibbert Journal*, vol. XX., pp. 643-656 (July 1922).
- "Final Utility" in *Palgrave's Dictionary of Political Economy*, 2nd Ed., ed. by Henry Higgs, vol. II., pp. 857-859.

## INDEX

### A

Accumulation—see *Saving*  
 Administration of resources—by individuals, 293, 300, 776, 780, 852 ff.; —difficulties, 96 ff.; —effect of interest, 300; —entrepreneurs, 367, 778; —errors in, 88 ff., 264; —housewives, 18 ff., 80, 89, 176, 262, 459; —human effort, 333; —limited effort, space and time, 77 ff.; —through time, 268 ff.; —waste in, 114 ff.  
 Aristotle, 776, 779, 810, 853  
 Auctions, 252

### B

Bank of England, 603 ff., 612  
 Banking—advantages of, 583, 585; —origin of, 581; —reserves, 584, 601, 606  
 Bills of exchange—see *Exchange*  
 Böhm-Bawerk, viii, xvii, 841  
 Borrowing—unproductive, 683 ff.  
 Business—economic relations, 16, 166, 179; —transactions, 170, 174

### C

Cairnes, J. E., vii, 725, 726, 766  
 Capital—and land, 365, 574; —functions of, 343; —hire of, 748 ff.; —issues of, 238 ff.; —raised by taxation, 681  
 Carruthers, John, 733  
 Chances—doctrine of, 120  
 Chapman, S. J., xvi, 818-822  
 Choice between alternatives—habit, 28 ff.; —irrational, 29 ff.; —mistakes in, 114 ff.; —negative satisfactions, 25, 26; —present

and future, 112 ff., 268; —psychology of, 2, 3, 816, 849; —spending and saving, 22; —unconscious, 34 ff.  
 Clark, J. B., x, xxi  
 Collective bargaining, 690 ff.  
 Commodities—complementary, 478; —exchangeable, 151; —influences affecting purchase, 21 ff.; —long and short service, 105 ff., 268; —not exchangeable, 132; —supply in the market, 261; —theory of the market, 7  
 Communal scale, 143, 144, 488, 497 ff.  
 Competition—between present and future, 292; —in the market, 220  
 Comte, Auguste, 771, 809, 815  
 Consols, 240  
 Consumer's rent, 570  
 Consumption, 101 ff., 767, 783, 800, 827, 851  
 Continuity—principle of, 205  
 Co-operation—advantages and disadvantages, 186 ff.; —economic relations, 171; —fraudulent, 184  
 Cost of production—and demand, 535 ff.; —and factors, 820; —and price, 380, 382-391, 844; —and rent, 540, 821; —and value, 89, 373, 380, 382-391, 845; —choice between alternatives, 394; —curves of, 535, 539; —determinants of, 540; —effect of increased output, 534; —increasing and diminishing, 532; —“relinquished alternatives,” xviii, 382, 788, 820, 824

Cost price, 380, 820  
 Cournot, 725, 765, 808  
 Currency—see *Media of Exchange and Money*  
 Curves—abuse of, 437; —accuracy of, 452 ff.; —communal, 488, 494; —controversy *re*, 475; —general discussion, 415-438; —interactions of, 476; —intersection of, 498 ff.; —limitations of, 464; —of cost, 535, 539; —of demand, 785 ff.; —of marginal significance, 415 ff., 443 ff., 735 ff., 744 ff.; —of productivity of capital, 749 ff.; —of supply, 785 ff., 797; —personal, 474; —summation of, 494

## D

Davenant, 735 ff.  
 Davenport, H. J., 822-826  
 Debt, National, 684 ff.  
 Deferred payments, 107  
 Degree of utility, 759-761  
 Demand—and cost, 535 ff.; —curves, 785 ff.; —derived, 261; —effect of changes of, 520, 648  
 Desire—ultimate objects of, 152  
 Diagrams—abuse of, 8, 437; —accuracy of, 452 ff.; —general discussion of, 415-438, 734; —limitations of, 464  
 Dimensions of economic quantities, 738-752, 755-758  
 Diminishing marginal significance—applicable to interest, 284; —continuous process, 48 ff.; —diagrams, 415 ff., 443 ff.; —examples, 415 ff.; —general discussion, 39 ff., 86; —inapplicable to experiences, 402; —in exchange, 128 ff.; —objections answered, 82 ff., 404-414; —occurs only "after a certain point," 82; —of different commodities, 71 ff.; —of factors, 382, 546; —of leisure, 76; —universal application, 155 ff., 159, 403 ff., 529  
 See also *Significance and Marginal Significance*

Diminishing returns—and rent, 550-574; —psychic, 86; —to labour, 546

See also *Diminishing Marginal Significance*

Distribution—and final utility, 798; —and psychology, 769; —coordination of laws of, ix, xiii, xxi, 373 n., 815 n., 862; —of productive effort, 835; —of wealth, 650 ff.; —one law of, 6, 778, 788, 798 ff., 824; —problem of, 359, 858; —summation of factors, 369

Division of labour—advantages and disadvantages, 133 ff., 186 ff., 346; —for exchange, 133; —general discussion, 167; —promoted by money, 140; —saving, 278; 294

Dumping, 253 ff.

## E

Earnings, 319 ff., 344, 841 ff.  
 Economic—definition of, 162 ff.; —forces, 167, 189, 191, 199, 201, 207 ff., 392-398; —"harmonies," 184, 784; —laws, 161, 780; —man, 4, 163, 770, 780, 828, 829, 855; —motives, 163, 175, 181; —quantities, 738-752, 755-758; —relations, xxi, 4, 5, 165 ff., 170-211, 772 ff., 781  
 Economics — and psychology, 766 ff., 827; —and sociology, 817, 827; —definition of, 17, 827; —scope of, xiv, 4, 15, 16, 160, 772-796  
 Edgworth, F. Y., ix, xi, xx, 373 n., 725, 815 n.  
 Education, 335, 345, 663, 700  
 Ends—and means, 14 ff., 154, 777, 782, 783; —economic relations, 165 ff., 170 ff.; —mutually destructive, 396; —outside circle of exchange, 152, 154  
 Entrepreneurs, 367, 371  
 Equilibrium—adjustment of resources, 88 ff.; —between present and future, 112 ff.,

- 270 ff. ; —between price and marginal significance, 76, 94, 96 ; —definition, 216 ; —for an individual, 65 ff. ; —in an exchanging community, 141 ff. ; —in expenditure, 775, 843 ; —in the market, 213 ff., 219, 776 ; —value, 213
- Estimates—accuracy of, 453 ff.
- Everett, J. D., 755, 758
- Exchange—advantages of, 133 ff. ; —against claims, 578 ff. ; —and marginal significance, 128 ff. ; —and psychology, 768 ; —between present and future, 270 ; —between two individuals, 128 ff. ; —bills of, 590 ff., 606 ; —circle of, 4, 151 ff. ; —conditions of, 128 ff. ; —limits of, 130 ff. ; —media of, 135 ff., 585 ff. (see also *Money*) ; —objects of, 151 ff. ; —objects outside, 152 ; —production for, 133 ; —purchase an indirect form of, 127 ff. ; —rates of, 131, 593 ; —sometimes impossible, 132 ; —terms of, 130 ff.
- Exchanges—see *Foreign Exchanges*
- Expenditure—advantages of anticipating or postponing, 270 ; —continuous and discontinuous, 101 ff. ; —conventional, 115 ff. ; —economy of, 13, 106 ff. ; —equilibrium of, 775 ; —large items of, 105 ; —sudden changes in, 648 ; —unproductive, 683
- F
- Factors of production—common measure of, 369 ; —differential equivalence of, 779 ; —difficulty of classification, 365 ; —diminishing marginal significance, 362, 546 ; —substitution at margin, 361 ff. ; —summation of, 369, 820 ; —value of, 541
- Famine—economic effects, 736 ff. ; —funds, 642 ff.
- Final utility, 762 ff., 797 ff.
- Foreign exchanges, 580, 768
- Foxwell, H. S., 805
- Futures, 237
- G
- Gambling, 628 ff.
- George, Henry, vi
- Gifts *inter vivos*, 647
- Gold—distribution between uses, 596 ff. ; —flow of, 588, 608 ; —medium of exchange and standard of value, 137 ff., 577, 587, 600 ; —minting of, 601 ff., 607 ; —points, 594 ; —price of, 605 ; —reserves, 601
- Gossen, H. H., 765, 808
- Gresham's Law, 610 n.
- H
- Herford, C. H., v, vi
- Hire—and interest, 276, 840 ; —and rent, 312 ; —economic aspect, 108 ff., 311 ; —of capital, 748 ff. ; —purchase by, 107
- Hobson, J. A., 507-513
- Housewives, 18 ff., 80 ff., 89, 176, 262, 459
- Housing problem, 634 ff.
- I
- Income—and scales of preference, 483 ; —distribution of, 650 ff. ; —earned and unearned, 342 ; —national, 649 ff. ; —when small, 106
- Increasing returns, 529
- Indifference—Law of, 715, 719, 721, 836
- Insurance, 237, 312, 630
- Interest—and administration of resources, 300, 799 n. ; —and hire, 276, 748, 840 ; —and marginal significance, 284 ; —and rent, 314, 859 ; —decline of, 309 ; —effect of saving, 307 ; —general meaning of, 314 ; —Law of the Market, 6, 287 ; —negative, 310 ; —sources of the phenomenon, 274, 281

## J

- Jevons, W. S., vi, viii, x, xii, xv, xvi, xvii, xviii, 1, 2, 3, 611, 708 n., 715, 716, 721, 724, 725, 726, 730, 734-753, 758, 759, 761, 762, 764, 765, 795, 797, 799, 801-813, 818, 819, 831  
 Johnson, W. E., 743 n., 744 n.

## K

- Keynes, J. N., 766  
 King, Gregory, 734, 735

## L

- Labour—division of—see *Division of Labour*: —marginal significance of, 546, 554 ff.; —market, 338; —meaning of, 338; —supply of, 522 ff.;  
 Land—and capital, 365, 574; —as a tool, 290; —fertility of, 540, 790; —marginal significance of, 554 ff.; —nationalization of, 686 ff.; —supply of, 533  
 Law of diminishing marginal significance—see *Diminishing Marginal Significance*  
 Law of the market, 7, 228, 262, 287, 325, 516, 544  
 Laws of economics, 161  
 Leisure, 76, 524  
 Limiting rate, 60, 446  
 Loans—unproductive, 683

## M

- Malthusian theory, 706  
 Margin—ambiguous use of, 572, 790, 793, 794, 800  
 Marginal—adjustments, 114, 774; —increments and decrements, 47 ff., 56  
 Marginal significance—accurate estimate impossible, 50 ff.; —and cost of production, 380; —and distribution, 573; —and exchange, 128 ff.; —and interest, 284; —and market price, 91, 92, 143; —and total

significance, 45 ff.; —commodities compared, 63 ff.; —communal scale, 143 ff.; —continuous diminution of, 48 ff.; —definition, 62; —diminishes only “after a certain point,” 82; —effect of alternatives relinquished, 93; —effect of distribution of wealth, 227; —effect of emergencies, 90 ff.; —effect of price paid, 91, 92; —function of all commodities, 479, 482; —general discussion, 39 ff.; —in equilibrium, 76, 216; —in exchange, 128 ff.; —in terms of money, 137; —limiting rate, 60; —of gold, 618; —of labour, 339, 554 ff.; of land, 554 ff.; —of leisure, 525; —rates of, 57 ff., 71 ff.; —ways of increasing, 344

See also *Significance and Diminishing Marginal Significance*

Margins—doctrine of, 39 ff.; —substitution at, 360 ff.

Market—*anticipations* of wealth, 272; —closed and open, 482; —competition in, 220; —definition of, 213; —distribution of crops, 215; —equates wants *objectively*, 189; —equilibrium in, 216, 776; —for advances, 291; —for entrepreneurs, 372; —for human effort, 319 ff.; —for raw materials, 258; —for stocks and shares, 238 ff.; —functions of, 236, 784; —Law of, 6, 228, 262, 287, 325, 516, 544, 788, 789; —monopolistic, 256; —price—see *Price*; —price discrimination in, 253 ff.; —speculative holding essential, 234; —supply of commodities, 261; —wholesale and retail contrasted, 250

Marshall, A., vii, xii, xvi, xvii, xviii, 513, 725, 812, 818, 819, 827

Marx, Karl, vii, 705-733, 831

Means and ends, 14 ff., 154, 777, 782, 783

Medium of exchange, 135 ff., 585 ff., 834

See also *Money*

Menger, C., x, xvi, 2, 765, 808  
 Mill, J. S., xvi, 725, 811, 813, 827  
*Minimum sensible*, 406  
 Mises, L. v., xxii  
 Money—a symbol, 115; —circle of exchange, 152 ff.; —functions of, 141 ff., 773 ff.; —medium of exchange, 135 ff., 585 ff.; —necessity of, 153, 155; —paper, 618 ff.; —promotes division of labour, 140; —Quantity Theory of, 610 ff., 768; —significance of, 486  
 Monopolies, 256, 327, 677  
 Motives—economic, 4, 163, 181; —for co-operating, 171 ff.; —mixed nature of, 194  
 Municipal enterprise, 675 ff.

## O

Over-production, 640

## P

Pareto, V., viii, ix, xi, xviii, xix, 373 n., 479, 814-818  
 Political Economy—definition, 13, 14; —special laws of, 161  
 See also *Economics*  
 Preference, scales of—see *Scales of Preference*  
 Prices—and cost of production, 380, 382-391, 844; —and equilibrium value, 214; —and marginal significance, 91, 92, 143; —and size of stocks, 231; —and speculative holding, 234; —collectively fixed, 218; —determinants of, 503, 516, 784; —discriminating, 253 ff.; —equilibrating function, 143; —erroneous estimates, 224 ff.; —examples of fixation, 507-516; —express economic relations, 5; —generalised conception, 27 ff.; —index of alternatives, 21 ff.; —inertia of, 599; —monopolistic, 256; —of gold, 605; —of services, 319 ff.; —reservation, 229 ff., 323, 324, 327; —retail, 250; —traditional, 249

Production—and psychology, 769; —factors of—see *Factors of Production*; —for exchange, 133  
 Provision for the future—see *Saving*  
 Psychology—and Economics, 766 ff.; —of choice, 2, 3, 816, 849  
 Purchase—an indirect form of exchange, 127 ff.; —by hire, 107; —by long-period sacrifice, 105

## Q

Quantities, economic, 738-752, 755-758  
 Quantity Theory of Money, 610 ff., 768

## R

Raw material markets, 258  
 Relative scale—see *Scales of Preference*  
 Rent—and cost of production, 540, 821; —and hire, 312, 799 n.; —and interest, 314, 859; —consumer's, 570; —law of, 790 ff.; —not a residuum, 568, 570; —of ability, 569; —Ricardian Theory, xx, 568, 574, 790; —theory of the market, 6  
 Retail trade, 250  
 Ricardo, D., xvi, xvii, xx, 568, 574, 724, 725, 770, 790, 811, 827  
 Robinson Crusoe, 522, 716, 722, 829, 833  
 Royal Mint, 603

## S

Satisfaction—accuracy of estimates, 452, 454; —capacity for, 423; —curve of total, 447, 463, 467 ff., 476 ff.; —diagrams of, 442 ff.; —from work, 198 ff.; —general discussion of, 415-435; —of wants, 350 ff.; —positive and negative, 25 ff., 415 ff.; —present and future, 112 ff., 299; —ruinous, 423; —summation of, 479; —"superior," 432; —surplus, 479 ff.; —unit of, 440; —wasteful, 424



- Saving—advantages of, 343; —and interest, 307; —causes of, 309; —competition for use of, 285 ff.; —division of labour in, 278, 294; —effect of, 281, 306 ff.; —excess of, 298; —hindrances to, 305; —nature of, 283; —process of, 277 ff.; —rate of, 309; —tools a result of, 282; —waste of, 308; —wise and unwise, 294
- Scales of preference—automatic, 35; —changes of income, 483; —co-incident of, 834; —communal, 143, 144, 488, 497 ff.; —exchange, 128 ff.; —general discussion, 32 ff.; —importance of, 122 ff.; —objective, 147; —psychological or vital, 147
- Sellers—at reserve prices, 229; —combinations among, 256; —retail, 250
- Services—exchangeable, 151, 316 ff.; —fluctuations in demand, 330; —lack of communal administration, 333; —market for, 319 ff.; —perishable nature of, 321; —price of, 319 ff.; —reserve prices, 323, 324, 327; —speculation in, 328; —supply of, 332, 522 ff.; —theory of the market, 7; —worth of, 339 ff.
- Shaw, G. B., viii, 731, 732, 733
- Significance—effect of distribution of resources, 281; —effect of remoteness, 112 ff.; —for different individuals, 189; —objective, relative, 147; —of money, 486; —total and marginal, 45 ff.; —vital and objective, 148
- See also *Marginal Significance* and *Diminishing Marginal Significance*
- Smith, Adam, xvii, 725, 830
- Socialism, 675 ff.
- Speculation—general discussion, 633; —in futures, 237; —in markets, 234 ff.; —in services, 328; —in stocks and shares, 238, 245 ff.
- Standard of value, 137 ff., 577 ff.
- See also *Money*
- Stock markets, 238 ff.
- Substitution at the margin, 365 ff.
- Superposition—principle of, 203
- Supply—and interest, 309; —curves of, xx, 506, 516, 785 ff., 797; —determination of, 517; —in market for advances, 291; —of commodities, 261, 719; —of human effort, 332, 522 ff.; —of land, 533
- Surplus value, 43 ff., 487

## T

- Tariffs, 641, 664, 666 ff.
- Taxation—general discussion, 660 ff.; —local, 675; —to raise capital, 681
- Theories of wages, etc., unnecessary, 6, 788
- Theory and Practice*, 202
- Theory of the Market—see *Law of the Market*
- Tools, 282, 290, 299
- Trade—fluctuations in, 639 ff.; —home and foreign, 589; —Unionism, 690 ff.

## U

- Uncertainty, 113
- Underpayment, 340
- Unemployment, 637 ff., 666 ff.
- Units—"at the margin," 573; —effect of size, 56, 97; —fractional consumption of, 311; —of satisfaction, 440
- Utility—ambiguous use of, 800; —and value, 715-733; —degree of, 759-761; —final, 762 ff., 797 ff.; —Jevonian use of, 742 ff.; —variation of, 715, 721, 811
- See also *Marginal Significance*

## V

- Value—and antecedent efforts, 93; —and conventions, etc., 115 ff.; —and cost of production, 89, 373, 380, 382-391; —and market price, 214; —and relative scales, 141 ff.; —and value in use, 45 ff., 830; —a ratio, 831;

- dependent on scarcity, 347 ;  
 —fixed supply, 309 ; —Jevon-  
 onian Theory, 716 ff., 724 ff.,  
 —marginal theory, 774 ; —  
 Marxian Theory, vii, 705-733 ;  
 —of factors, 541 ; —of money,  
 610-623 ; —of services, 339 ff. ;  
 —of tools, 290 ; —standard of,  
 137 ff., 577 ff. ; —surplus, 43 ff.,  
 487, 710, 722, 733
- Variation of Utility—Law of, 715,  
 721, 811
- W
- Wages—and rent, 550-574 ; —cross,  
 331 ; —inertia of, 599 ; —  
 minimum, 682, 693 ; —pay-  
 ment for services, 320 ; —theory  
 of the market, 6 ; —under State  
 control, 682 ff.
- Walker, F. A., 707 n., 791, 827
- Walras, Léon, x, xviii, 2, 725, 736,  
 762, 765, 808, 818
- Wants—and economic relations,  
 781 ; —changing nature of,  
 349 ; —equated in market, 189 ;  
 —of different individuals,  
 148 ff., 782 ; —recurrence of,  
 101
- Waste—and worth, 14 ; —due to  
 mental habits, 114 ff. ; —of  
 resources, 114 ff. ; —of savings,  
 308
- Wicksell, K., xvii, xx
- Wieser, F., xii, xvi, xviii
- Worth—and economy, 14 ; —of  
 commodities, 713 ff., 718 ; —of  
 labour, 339 ff. ; —remuneration  
 in excess of, 341, 343 ; —ways  
 of increasing, 344

## DATE OF ISSUE

This book must be returned  
within 3, 7, 14 days of its issue. A  
fine of ONE ANNA per day will  
be charged if the book is overdue.

PRESCRIBED AS A

# TEXT BOOK

Not to be issued without permission.

LIBRARIAN.