

CENTRAL LIBRARY

**Birla Institute of Technology & Science
PILANI (Rajasthan)**

660

Call No.

M 36 I

V. I. Pt II

Accession No

59542

Acc. No

59542 ISSUE LABEL

Not later the latest date stamped below.

--	--	--

**INDUSTRIAL AND MANUFACTURING
CHEMISTRY (INORGANIC)**

VOLUME I.

Uniform with the Present Volume
Royal 8vo. Price 28s. net

INDUSTRIAL AND MANUFACTURING CHEMISTRY

INORGANIC

A PRACTICAL TREATISE

BY

GEOFFREY MARTIN, D.Sc., Ph.D., F.I.C.

TECHNOLOGICAL CHEMIST AND CHEMICAL ENGINEER, FORMERLY LECTURER AND
DEMONSTRATOR IN CHEMISTRY AT UNIVERSITY COLLEGE, NOTTINGHAM; LATE OF THE
CHEMICAL RESEARCH DEPARTMENT OF THE CO-OPERATIVE WHOLESALE SOCIETY LTD.

ASSISTED BY EMINENT SPECIALISTS

VOLUME II

LIST OF SECTIONS

Disinfectants and Antiseptics.	Furnace Linings.
Artificial Manures.	Glass.
Insecticides, Fungicides, and Sheep Dips	Enamels.
Industry of Aluminium Compounds.	The Asbestos Industry.
Artificial Zeolite or Permutite In- dustry.	The Mica Industry.
Artificial Gem Industry.	The Thorium and Cerium Industry, including the Manufacture of Incandescent Mantles and Pyrophoric Alloys.
Alumino-Thermics.	Titanium.
The Calcareous Cement Industry.	Zirconium.
Sorel Cement.	Tantalum.
Artificial Stone.	Tungsten.
Sodium Silicate, Water Glass, and Soluble Glass.	The Incandescent Glow Lamp In- dustry.
Lutes and Miscellaneous Cements.	Industry of Radio-active Materials.
Clays and Allied Materials.	Electric Furnace Products and their Industrial Applications.
Pottery.	Compositions for Grinding and Polish- ing.
Earthenware.	Phosphorus.
Porcelain.	Matches.
Stoneware and Sanitary Ware.	Miscellaneous Cements.
Bricks.	
Lime-Sand Bricks.	
Tiles.	

Complete Index to Volumes I. and II.

THE TECHNICAL PRESS LTD.

INDUSTRIAL AND MANUFACTURING CHEMISTRY

PART II INORGANIC

A PRACTICAL TREATISE

BY

GEOFFREY MARTIN, D.Sc., Ph.D., F.I.C.

TECHNOLOGICAL CHEMIST AND CHEMICAL ENGINEER;
AUTHOR OF "THE SALT AND ALKALI INDUSTRY," "INDUSTRIAL GASES,"
"NITROGEN PRODUCTS AND EXPLOSIVES," "SULPHURIC ACID,"
ETC., ETC.

LATE DIRECTOR OF RESEARCH TO THE CO-OPERATIVE WHOLESALE
SOCIETY LTD. OF MANCHESTER;
LATE DIRECTOR OF RESEARCH TO THE BRITISH PORTLAND CEMENT
RESEARCH ASSOCIATION.

VOLUME I

Original Contributors

G. W. CLOUGH, D.Sc.

JOHN M. DICKSON, B.Sc.

H. H. HODGSON, M.A., B.Sc.,
Ph.D.

E. JOBLING, B.Sc.

FRANK MILSOM, B.Sc.

C. AINSWORTH MITCHELL,
D.Sc., B.A., F.I.C.

H. STANLEY REDGROVE, B.Sc.

ALFRED B. SEARLE.

JAMES SHELTON, F.I.C.

STANLEY SMITH, M.Sc.

FIFTH EDITION, REVISED

BY

GEOFFREY MARTIN

LONDON
THE TECHNICAL PRESS LTD.
5 AVE MARIA LANE, LUDGATE HILL, E.C.4

1935

[*All Rights Reserved*]

Uniform with the Present Volume

Sixth Edition, Revised. Nearly 750 Pages, with 250 Illustrations.
Royal 8vo. Price 36s. net.

INDUSTRIAL AND MANUFACTURING CHEMISTRY

ORGANIC

A PRACTICAL TREATISE

BY

GEOFFREY MARTIN, D.Sc., Ph.D., F.I.C.

TECHNOLOGICAL CHEMIST AND CHEMICAL ENGINEER, FORMERLY LECTURER AND
DEMONSTRATOR IN CHEMISTRY AT UNIVERSITY COLLEGE, NOTTINGHAM; LATE OF THE
CHEMICAL RESEARCH DEPARTMENT OF THE CO-OPERATIVE WHOLESALE SOCIETY LTD.

LIST OF SECTIONS

1. The Oil, Fat, Varnish, and Soap Industry (by Dr Newton Friend, Dr Goodwin, Dr Martin, Mr C. A. Mitchell, Mr W. H. Stephens).
 2. The Sugar Industry (by Dr Druce Lander).
 3. The Starch Industry (by Dr G. Martin).
 4. The Cellulose Industry (by Mr A. J. Carrier and Dr G. Martin).
 5. The Fermentation Industries (by Mr C. H. Griffiths, Dr G. Martin, Dr A. Slator, and Mr W. H. Stephens).
 - (1) Ferments, Enzymes, Bacteria, Moulds, Yeasts, etc.
 - (2) The Rate of Alcoholic Fermentation by Living Yeast.
 - (3) Wine.
 - (4) Beer.
 - (5) Spirits and Industrial Alcohol. Parts I. and II.
 - (6) Vinegar, Lactic and Butyric Acids.
 6. The Charcoal and Wood Distilling Industries (by Dr G. Martin).
 7. The Turpentine and Rosin Industry (by Dr G. Martin).

Appendix—Natural and Synthetic Camphor.
 8. Industrial Gums and Resins (by Dr Newton Friend).
 9. The Rubber Industry (by Mr A. J. Carrier, B.Sc., Dr G. Martin, and Mr G. H. Martin).
 - (1) Natural Rubber, Gutta-percha, and Balata.
 - (2) Synthetic Rubber.
 10. The Industry of Aliphatic Chemicals (by Dr G. Martin).
 11. The Illuminating Gas Industry (by Mr E. A. Dancaster, B.Sc., including a section on Acetylene by Mr F. B. Gatehouse).
 12. The Coal Tar and Coal Tar Product Industry (by Dr G. Martin).
 13. Industry of Synthetic Colouring Matters (by Mr T. Beacall, B.A., and Dr G. Martin).
 14. Industry of Natural Dye Stuffs (by Dr G. Martin).
 15. The Ink Industry (by Dr G. Martin).
 16. The Paint and Pigment Industry (by Dr Newton Friend).
 17. The Textile Fibre, Bleaching, and Waterproofing Industries (by Dr G. Martin).
 18. The Dyeing and Colour-Printing Industry (by Dr Henry S. Sand).
 19. The Leather and Tanning Industry (by Mr Douglas L. Law, B.Sc., F.I.C.).
 20. The Glue, Gelatine, and Albumen Industry (by Dr G. Martin).
 21. The Industry of Modern Synthetic and other Drugs (by Dr F. Challenger).
 22. The Modern Explosives Industry (by Mr Wm. Barbour, M.A., B.Sc.).
 23. The Industry of Photographic Chemicals (by Dr G. Martin).
 24. The Tobacco Industry (by Mr S. E. Hodgkinson).
- Appendix I. Useful Tables.
Appendix II. Index List of Trade Names of the Newer Synthetic Drugs, etc.

THE TECHNICAL PRESS LTD.

P R E F A C E

A TREATISE on technical Inorganic Chemistry, which includes accounts not only of the more important industries, but also details of the minor ones, has been a long-felt want amongst practical business men interested in chemical processes of manufacture.

The present work forms a continuation, or supplement, to the Editor's "Treatise on Industrial Organic Chemistry," which has evidently filled a gap in chemical literature. It embraces both British and American practice, and affords, so far as is ascertainable in view of the many secret processes employed, thoroughly up-to-date information regarding the various branches of chemical industry and of manufactures having a chemical basis.

The work, which has been carried out on the lines of the previous treatise, has been written under very formidable difficulties, for not only have several years been spent in its compilation, but before its completion the Great War broke out and dispersed many of the contributors in the fighting ranks throughout the world, one at least, the late Major L. Foucar, having been killed in action before his article could be completed. It is a great satisfaction to the Editor that he has been able to bring his task to a conclusion in spite of these obstacles.

The immensity of the subject, and the large number of industries embraced under the comprehensive title "Industrial Inorganic Chemistry," has necessitated the division of the work into two volumes.

The Editor has been fortunate in securing the co-operation of a distinguished body of contributors, all of whom are experts in their particular subjects; their names and attainments, as enumerated on the title-pages of the two volumes and more specifically in the list of contents, are a guarantee that the minutest care has been exercised to ensure accurate descriptions of the industries concerned, and to these gentlemen the Editor owes a considerable debt of gratitude, and to many other professional friends who have supplied information or given help in subjects in which they have specialised.

One great difficulty in compiling such a treatise is the extraordinarily rapid advance in scientific invention in many industries. Almost overnight (so to speak) new industries arise out of improvements or inventions, the details of which it is almost impossible to procure.

In carrying out the work, however, special pains have been taken to ensure that the most recent available data, and the most modern processes, have been described. Much of the information is published in book form for the first time, and many of the descriptions of new processes and modern plant have been supplied by the courtesy of industrial chemists and leading firms of Europe and America.

Patent literature has been utilised to the fullest extent, since many patents, although impracticable, often contain the germs of valuable ideas. Indeed the Editor ventures to claim that such a copious reference given to the technical and patent literature of all countries has not appeared in any similar work published in English, and he hopes that by this means a reader who desires further details respecting any process described will be enabled, without difficulty, to refer to the original source.

The Editor's aim is to cover the whole range of subjects with which the industrial chemist and manufacturer are usually concerned, and to present a book which would serve either as a text-book or as a work of reference to meet the requirements of business men interested in chemical processes, chemists, chemical engineers, patent workers, inventors, students, and others. He trusts the work will be found to carry out this object, and that it may prove of real utility to all interested in chemical manufacture.

It should be mentioned that while the title indicates that only Inorganic Compounds are dealt with, it has been found advisable to include, in the sections on Disinfectants and Antiseptics, a number of Organic Compounds which fall naturally under these headings, since the removal of them from such sections would largely destroy their value.

Although every care has been taken in the production of the work, yet, in view of the mass of detail involved, it is impossible that all errors have been eliminated, or that in every case the best processes have been described. The Editor will, therefore, be grateful if readers will kindly inform him of any erroneous statements, or will call his attention to any serious omissions.

On the other hand, he would be pleased to help such readers who have difficulty in carrying out various processes described if they would communicate their difficulties to him.

LONDON, *December* 1916.

PREFACE TO FOURTH EDITION

THE fact that four Editions of a large work like the present have been called for after such a comparatively short interval of time indicates that the book still retains its popularity among technologists. The reason, no doubt, is due to the very great trouble which has been taken in order to keep the book thoroughly up to date. The Editor hopes that practical men will continue to favour him with suggestions for improving the work, so as to keep it as closely as possible in touch with altering practice in technology.

GRAVESEND, *July* 1922.

PREFACE TO FIFTH EDITION

THE popularity of the book continues undiminished. An attempt has been made to keep the book up to date, and the Editor hopes that practical men will continue to favour him with suggestions.

The work aims at giving a brief survey of Chemical Industry. Obviously (so extensive has technological literature become) an exhaustive account of Modern Industry would require unlimited space and defeat the object of this work.

GEOFFREY MARTIN.

LONDON, 1935.

TABLE OF CONTENTS

SECTION I SOLID FUELS

By ALFRED B. SEARLE

	PAGE
Literature—Classification of Fuels—Wood—Peat—Lignite—Coals—Bituminous Coal—Anthracite—Cannel Coal—Impurities in Coal—Valuation of Coals—Calorific Power—Mahler-Cook Calorimeter—Calorific Power of Various Fuels—Calorific Intensity—Cleaning Coal—Washing—Types of Washers—Blackett Washer—Robinson's Washer—Air Separators—Prepared Solid Fuels—Charcoal—Firelighters—Properties of Charcoal—Peat Charcoal—Coke—Coalite—Briquettes—The Weathering of Fuel—Spontaneous Combustion of Coal—Storing Coal—Hydrogenation of Coal	1

SECTION II THE MANUFACTURE OF BRIQUETTES

By GEOFFREY MARTIN, D.Sc.

Methods of Briquette-Making—Binders—Process of Manufacture—Briquetting of Anthracite—Armstrong-Mordan Process—Pitch Cancer, Pitch Ulcers	21
------------------------------------------------------------------------------------------------------------------------------------------	----

SECTION III LIQUID FUELS

By ALFRED B. SEARLE

Literature—Natural or Mineral Oils—Prepared Oils and Spirits—Distilled Mineral Oils—Heavy Oils—Alcohol—Furnaces for Burning Liquid Fuels—Burners—Kermode Burner—Air-Jet System—Other Uses of Liquid Fuels—Advantages of Liquid Fuels—Drawbacks—Costs of Liquid Fuels	25
----------------------------------------------------------------------------------------------------------------------------------------------------------------------------------------------------------------------------------------------------------------------	----

SECTION IV FURNACES

By ALFRED B. SEARLE

Literature—Utilisation of Fuel—Construction of Furnaces—Fireplace—Combustion Chamber—Hearth—Draught-Producer	29
Furnaces for Solid Fuels—Primary Air Supply—Introduction of Hot Air (Secondary Air)—Grates—Automatic Stokers—Conditions for Good Combustion and Economical Heating—Domestic Fireplaces—Pan Boilers—Steam Boilers—Water-Tube Boilers—Reverberatory Furnaces—Crucible Furnaces—Blast Furnaces—Shaft Kilns—Kerott Furnaces—Coke Ovens—Kilns and Pottery Ovens—Muffle Furnaces	31

	PAGE
Dust-Firing	42
Furnaces for Liquid Fuels—Burners—Gas-Fired Furnaces—Principles—Gas-Firing—Advantages of Gas-Firing—The Regenerator Principle—Recuperators	42
Chemistry and Physics of Combustion—Temperature of Ignition—Amount of Available Heat—Heat Units—Calorific Power—Highest Temperature Attainable—Excess of Air—Weights of Oxygen and Air Required for Combustion—Sources of Loss of Heat in Burning	44
Smoke and Smoke Prevention—Causes of Smoke—Smoke Preventers—Soot	47
Production of Superheated Steam—Nature of Superheated Steam—Superheaters	49

SECTION V COKE OVENS

By GEOFFREY MARTIN, D.Sc.

Coke Ovens—Beehive Oven—Coppée Oven—Otto Oven—Regenerators—Otto-Hilgenstock Oven—Brunck Oven—Kopper's Oven—Recovery of By-Products—Recovery of Ammonia—Recovery of Benzene	51
---------------------------------------------------------------------------------------------------------------------------------------------------------------------------------------------	----

SECTION VI SURFACE COMBUSTION

By Lieut. E. JOBLING, A.R.C.Sc., B.Sc., F.C.S.

Literature—Introduction—Types of Apparatus—Observations Applicable to all the Modifications—Refractory Material—Gases—Lighting Up—Utilisation of Liquid Fuel	57
Industrial Applications—Steam Generation and the Heating of Liquids Generally—Melting of Metals and Alloys—Production of Nitrogen and Carbon Dioxide—Crucible Furnaces—Smith's Hearth—Advantages of the Method	59

SECTION VII PYROMETRY AND PYROSCOPY

By ALFRED B. SEARLE

Literature—Measurement of Temperatures below 360° C.—Measurement of Temperatures below 600° C.—Measurement of Temperatures between 500°-1,600° C.—Platinum Resistance Pyrometer—Thermo-Electric Pyrometer—Air Pyrometer—Optical Pyrometers—Absorption Pyrometer—Photometric Pyrometer—Cornu-Chatelier Optical Pyrometer—Wanner Pyrometer—Féry Radiation Pyrometer—Pyroscopes—Sentinel Pyroscopes—Seger Cones—Holdercroft's Thermoscopes—Wedgwood's Pyroscope—Siemen's Water Pyrometer—Krupp's Pyrometer	65
--------------------------------------------------------------------------------------------------------------------------------------------------------------------------------------------------------------------------------------------------------------------------------------------------------------------------------------------------------------------------------------------------------------------------------------------------------------------------------------------------------------------------	----

SECTION VIII REFRIGERATING AND ICE-MAKING MACHINERY

By GEOFFREY MARTIN, D.Sc., Ph.D.

Literature—Industrial Uses of Artificial Cold—Compression Refrigerating Machinery—Vapour Tensions of Liquid Carbon Dioxide, Sulphur Dioxide, and Ammonia—Theory of Compression Machines—Efficiency of Refrigerating Machines—Absorption Machines—Cold Air Machines	77
-------------------------------------------------------------------------------------------------------------------------------------------------------------------------------------------------------------------------------------------------------------------------------------	----

SECTION IX

THE LIQUEFACTION OF GASES

Including the Manufacture of Oxygen, Nitrogen, and Hydrogen from Liquefied Gases

By Lieut. JOHN M. DICKSON, B.Sc.

	PAGE
Literature—Patents—Theoretical Considerations—Principle of the Temperature Exchanger—Types of Air-Liquefying Machines—Hampson's Apparatus—Linde Process—Theory of Linde Process—The Claude Process—The Separation of the Constituents of Liquid Air—Linde's Apparatus for Pure Oxygen—Production of Nitrogen by the Linde System—New Linde Apparatus for the Production of Pure Oxygen and Nitrogen—Claude's Apparatus for the Production of Pure Oxygen and Nitrogen—Pure Nitrogen by the Claude Process—Hildebrandt's Process for Preparing Oxygen and Nitrogen	83
The Liquefaction of Hydrogen—Hampson's Apparatus—The Linde-Frank-Caro Process for the Production of Hydrogen from Water-Gas—Properties of Industrial Gases	100

SECTION X

INDUSTRIAL OXYGEN

By GEOFFREY MARTIN, D.Sc., Ph.D.

Manufacture from Liquid Air—Brinn Process—Jaubert Process—Electrolytic Oxygen—Properties—Uses—Statistics	105
--------------------------------------------------------------------------------------------------------------------	-----

SECTION XI

INDUSTRIAL NITROGEN

By GEOFFREY MARTIN, D.Sc., Ph.D.

Manufacture from Liquid Air—Copper Process—Properties of Nitrogen—Uses	107
----------------------------------------------------------------------------------	-----

SECTION XII

INDUSTRIAL HYDROGEN

By H. STANLEY REDGROVE, B.Sc. (Lond.), F.C.S.

Literature—Properties— Manufacture —By Action of Water on Metals—By Action of Water on Non-Metals—By the Deoxidising Action of Carbon Monoxide—By Electrolysis—By the Decomposition of Hydrocarbons—By the Action of Acids on Metals—By the Action of Alkalis on Metals—Special Methods—Jaubert's Process—Teissier and Chaillau's Method	109
Industrial Uses of Hydrogen —Use as a Combustible—Use as an Inert Atmosphere—Use in Aeronautics—Use for Synthesis of Ammonia—Use for Hydrogenation of Fats	117

SECTION XIII

PRODUCER-GAS

By H. STANLEY REDGROVE, B.Sc. (Lond.), F.C.S.

Literature—Definition of "Producer-Gas"—Varieties of Producer-Gas— Production of Carbon Monoxide —Dixon's Experiments—Baker's Work—Rhead and Wheeler's Experiments—Properties of Carbon Monoxide	119
-------------------------------------------------------------------------------------------------------------------------------------------------------------------------------------------------------------------	-----

	PAGE
Air-Gas —Description of Gas-Producer—Thwaite's Cupola Producer—Analysis of Air-Gas	121
Water-Gas —Theory of Production—Bunte's Experiments on Action of Steam on Carbon—Dellwik and Fleischer's Water-Gas Producer—Composition of Water-Gas	123
Semi-Water-Gas —Theory of Production—Composition of Water-Gas—Bone and Wheeler's Experiments	126
Types of Gas-Producers —(1) <i>Diagonal Grate Producers</i> —Duff Producer—Thwaite Simplex Producer	129
(2) <i>Circumferential Grate Producers</i> —Mond Producer	129
(3) <i>Central Blast Producers</i> —Taylor "Revolving Bottom" Producer—Talbot Producer—Kerpeley Producers	130
Uses and Advantages of Producer-Gas —Employment in Furnaces—Employment in Gas Engines—Advantages of Producer-Gas Over Solid Fuel—Bone and M'Court's Method of Surface Combustion—Abolition of Smoke Nuisance—Gas Distribution—Carburetted Water-Gas	131
Ammonia Recovery in the Manufacture of Semi-Water-Gas —Mond System—Composition of Mond Gas	133
Suction Gas-Producers —Advantages of System—Mond Suction Producer—Dowson Suction Gas Producer	135
Blast-Furnace Gas —Composition—Utilisation—Ammonia Recovery from Blast-Furnace Gas	136

SECTION XIV

THE CARBON DIOXIDE (CARBONIC ACID) INDUSTRY

By H. STANLEY REDGROVE, B.Sc. (Lond.), F.C.S.

Literature —Occurrence—Properties— Manufacture —Collection and Purification of Natural Carbon Dioxide—As a By-Product in the Manufacture of Beer—By the Action of Acids on Carbonates—As a By-Product in the Burning of Limestone—Recovery of Carbon Dioxide from Furnace Gases—Recovery of the Exhaust Gas of Gas Engines (Suerth System)	139
Liquid Carbon Dioxide —Properties—Manufacture	142
Solid Carbon Dioxide —Manufacture—Properties	143
Technical Uses of Carbon Dioxide —Use in Sugar Manufacture—Use in White Lead Manufacture—Use in Ammonia Soda Process—Cryolite Process—Use in Beer and Aerated Water Industry—Use as Refrigerating Agent—Use in Steel Manufacture—Other Uses	144

SECTION XV

INDUSTRIAL OZONE

By E. JOBLING, A.R.C.Sc., B.Sc., F.C.S.

Literature —Introduction—Thermal Method of Manufacture—Electrolytic Method—Photo-Chemical Method—Electrical Method—Siemen's and Halske's Process—Otto System—Tindal-de Vrise System—Abraham Marmier System—Vosmaer System—Howard-Bridge System—Gérard System—Ozonair System	145
Detection and Determination of Ozone —Application of Ozone—Water Purification—Surface Contact Process—Emulsification Process—Injection Process—Air Purification—Miscellaneous Applications	150

SECTION XVI

THE TECHNOLOGY OF WATER

By HERBERT H. HODGSON, M.A., B.Sc., Ph.D.

Literature —Introduction—Impurities in Water—Rain Waters—Ground Waters—Spring Waters—River Water—Self-Purification of Water	157
----------------------------------------------------------------------------------------------------------------------------------------------	-----

CONTENTS

xi

	PAGE
Drinking Water —Unsuitability of Rain Water—Value of Running Brooks—Ground Water—Spring Water—Artesian Wells—Properties of Drinking Water—Hygienic Valuation of Drinking Water—Hardness—Chlorine Content—Nitric Acid Content—Nitrous Acid Content—Ammonia Content—Pollution by Decaying Nitrogenous Matter—Oxygen Consumption Value—Albuminoid Ammonia—Proteid Ammonia—Phosphoric Acid—Lead Content—Bacterial Content	159
Purification Methods for Drinking and Domestic Water —Sedimentation—Small House Filters—Large Scale Filters—Sand Filtration Process—Quick Mechanical Filters—Open Gravity Filters—Closed Pressure Filters—Reisert's Rapid Filter, Air Cleaned Type—Royle's Pressure Filters	161
Chemical Methods of Sterilisation of Drinking Water —Purification by Chemical Precipitation—Excess Lime Method for Sterilisation of Water—Purification by Oxidation—Use of Hydrogen Peroxide—Use of Permanganate—Addition of Chemicals which Destroy Bacteria—Use of Bleaching Powder—Use of Hypochlorites of Lime and Soda—Use of Electrolytic Chlorine—Use of Other Disinfectants—Removal of Lead and Iron by Treatment with Lime and Calcium Carbonate—The "Red Plague"—Addition of Copper Sulphate—Effect of Disinfectants on Bacterial Growths in Water—Rideal's Experiments—Ozone Treatment of Water—Sterilisation of Water by Ultra-Violet Rays—The R. U. V. Steriliser—Advantages of Use of Sterilised Water in Manufacture of Butter, Beer, Mineral Waters, etc.	166
Solvent Action of Water on Lead —Dangers of Soft Water—Treatment of Soft Waters	172
Feed Water for Boilers and other Technical Purposes —Properties of Good Water for Boilers—Alkaline Waters—Degrees of Hardness—Total Hardness—Permanent Hardness—Temporary Hardness—Alkalinity—Scale-Forming Constituents of Natural Waters—Corrosive Action of Chlorides and Nitrates—Acid Waters—Disadvantages of Hard and Impure Water—Use of Sea Water—Corrosion Due to Unsuitable Lubricants—Removal of Oil from Water—Lassen and Hjert's Standard Purifier—Influence of Calcium Sulphate on Scale Formation—Prevention of Scale Formation—Anti-Incrustators—Boiler Compounds— Water-Softening Plants —Lassen and Hjert's Water Softener—Royle's Plants—The Permutite Water Softening Plant—Advantages of the Permutite System— Removal of Iron from Water —Royle-Reisert's Type Iron-Removing Filter—Chemical Precipitation of Iron—Permutite Process for Removal of Iron— Advantages of Using Soft Water —In Laundry Work—In Dyeing Industry—In Paper Industry—In Textile Factories—In Sugar Refining—In Fermentation Industries—In Dairies	172
Effluents, including Sewage Disposal —Nature of Effluents—Effluents from Textile Industries—Treatment of Effluents—Solvent Scouring—Waste Liquors after Grease Recovery—Precipitation Process	183
Sewage Disposal —Constituents of Domestic Sewage—Sedimentation—Septic Tanks—Ammoniacal Fermentation—Dibdin's Process—Travis and Truhoff Process	186
Final Purification of Sewage —Sewage Beds—Filtration—Contact Bed Treatment—Trickling or Percolating Filters	188
Local Government Board's Requirements —Sewage Treatment—Necessary Analyses	190
Sludge Disposal —Salford Plant—Oldham Plant—Bradford Plant—Standard Effluent for Discharge into Non-Tidal Waters—Limiting Quantities of Harmful Substances in Waters—Haselhoff's Experiments	191
Analytical Methods for Water —Drinking Water—Technical Water—Sewage and Effluents—Total Nitrogen—Free Ammonia—Albuminoid Ammonia—Proteid Ammonia—Nitrites—Nitrates—Oxygen Consumption Value—Total Solids—Hardness and Alkalinity—Temporary Hardness—Permanent Hardness—Acidity—Lime Factor—Chlorine—Metals in Solution—Dissolved Oxygen—Putrescibility	193

SECTION XVII

ARTIFICIAL MINERAL WATERS

By C. AINSWORTH MITCHELL, F.I.C., B.A.

Literature —Aerated Waters—Machinery—Geneva Process—Continuous Process—The Gas Supply—The Pressure of Saturation—Counter-Pressure Bottling Machines—Natural Mineral Table Waters—Imitation Mineral Waters—Soda Water—Potash Water—Lithia Water—Radio-Active Mineral Waters—Brewed Goods—Bacteriological Conditions—Objectionable Fermentations—Metallic Contamination	195
------------------------------------------------------------------------------------------------------------------------------------------------------------------------------------------------------------------------------------------------------------------------------------------------------------------------------------------------------------------------------	-----

SECTION XVIII

THE SULPHUR INDUSTRY

By GEOFFREY MARTIN, Ph.D., D.Sc., and J. LOUIS FOUCAR, B.Sc. (Lond.)

	PAGES
Literature—Natural Sulphur—Extraction—The Gill Kiln—Frasch Process—Statistics	201
Recovered Sulphur—Chance and Claus Process—Thiogen Process—Other Processes	204
Properties of Sulphur—Solubility—Uses	205

SECTION XIX

SULPHURIC ACID

By GEOFFREY MARTIN, D.Sc., Ph.D.

Literature—Introduction—Statistics	207
General Methods of Production —From Sulphur—From Iron Pyrites—From Zinc Blende—From Galena—From Spent Oxide—Analysis of Raw Materials	208
Roasting Processes for Producing Sulphur Dioxide for the Manufacture of Sulphuric Acid	211
The Roasting of Iron Pyrites —Lump Kilns—Herreshoff Mechanical Furnace—Wedge Mechanical Furnace—Harris Furnace—Other Furnaces	211
The Roasting of Zinc Blende —Rhenania Furnace—Hegler Mechanical Furnaces—Lurgi Furnaces	214
The Roasting of Lead Ores (Galena) —Huntington and Heberlein Furnace—Savelsberg Furnace—Dwight and Lloyd Furnace—von Shippenbach Furnace	216
The Roasting of Copper Pyrites —Types of Furnaces	217
Sulphur Burners —Tomblee and Paul's Burner—Sachsenberg Burner—Other Burners	217
Sulphuretted Hydrogen Burner —Claus Furnace	220
Flues, Dust Removal Appliances, Burner Pipes, and Draught Pipes	220
The Lead Chamber Process for Sulphuric Acid Manufacture —General Description—Recent Improvements—Yield of Sulphuric Acid	221
Constructional Details of the Lead Chambers —Reaction Towers—Moritz Chambers—Meyer's Tangential Chambers—Falding Chamber—Brown Tower Chamber	225
Gay-Lussac Towers —Construction—Packing	227
Glover Towers —Construction—Systems of Packing—Function of Glover Tower—Cooling the Glover Acid	227
General Theory of Towers	229
Lunge-Rohrman Reaction Towers —Other Reaction Towers—Packing of Reaction Towers	230
Methods of Inducing Draught	231
Pumping the Acid —Kestner's Acid Elevators—Schütze's Automatic Elevator—Acid Centrifugal Pumps—Acid Plunger or Bucket Pumps	231
Introduction of Water Spray instead of Steam —Haughton's Sprays—Benker and Millberg Sprays	233
Methods of Introducing Nitric Nitrogen —Nitric Acid Sprays—Nitric Pots	233
Chemical Control of the Chamber Process —Waste Gases	235
Purification of Sulphuric Acid —Production of Arsenic-free Acid	235
Concentration of Sulphuric Acid —Cascade System—Gaillard Towers—Kessler's Apparatus—Concentration in Platinum Vessels	238
Transport of Sulphuric Acid	238
Tower Systems for Producing Sulphuric Acid —Griesheim System—Opl Process—Other Processes	239
The Contact Process for Sulphuric Acid Manufacture	239
Theory —Nature of Catalysts—Conditions for Technical Success—Badische Anilin Process (Knietsch-Herreshoff)—Purification of the Gases—Use of Iron Oxide as Contact Substance—Other Processes—Arrangements for Cooling and Condensing the Sulphur Trioxide—Production of Anhydrous Sulphur Trioxide and Fuming Acids—Advantages of Contact Process—Costs of Manufacture—Properties of Sulphuric Anhydride or Sulphur Trioxide—Hydrates with Water—Pyrosulphuric Acid—Ordinary Sulphuric Acid—Dehydrated Sulphuric Acid—Trihydrated Sulphuric Acid—Non-Fuming Sulphuric Acids—Impurities in Non-Fuming Sulphuric Acids—Fuming Sulphuric Acids—Conveyance and Handling of Sulphuric Acid—Uses of Sulphuric Acid—Detection and Estimation of Sulphuric Acid	240-52

SECTION XX

MANUFACTURE OF SULPHUR DIOXIDE
AND SULPHITES

By GEOFFREY MARTIN, D.Sc., and J. LOUIS FOUCAR

	PAGE
Manufacture of Anhydrous Sulphur Dioxide—Hanisch and Schroder's Process—Manufacture of Aqueous Solutions of Sulphur Dioxide (Sulphurous Acid)—Methods of Burning Sulphur for Production of Sulphur Dioxide—Tomblee and Paull's Furnace—Sachsenberg Burner—Humphries' Sulphur Burner—Properties of Sulphur Dioxide and Sulphurous Acid—Uses—Calcium Bisulphite—Sodium Bisulphite—Analysis	253

SECTION XXI

MANUFACTURE OF OTHER SULPHUR
COMPOUNDS

By GEOFFREY MARTIN, D.Sc., Ph.D.

Carbon Disulphide—Manufacture—Purification—Transport and Storage—Properties—Uses	257
Sodium Thiosulphate—Manufacture—Properties—Uses	259
Sodium Hyposulphite—Manufacture—Properties—Uses	259
Sulphuretted Hydrogen—Properties—Uses	260

SECTION XXII

THE SALT INDUSTRY

By GEOFFREY MARTIN, D.Sc., Ph.D.

Literature—Occurrence of Salt—Composition of Rock Salt—Sea Salt—Extraction of Rock Salt—Manufacture of Salt from Sea Water—Manufacture of Salt from Brine—Manufacture of Fine-Grained or Lump Salt—Table Salts—Common Salt—Fishing Salt—Bay Salt—Hopper Salt—Manufacture of Salt by Multiple Effect Vacuum Evaporators—Properties of Salt—Statistical	261
-----------------------------------------------------------------------------------------------------------------------------------------------------------------------------------------------------------------------------------------------------------------------------------------------------------------------------------------------------------------	-----

SECTION XXIII

THE MANUFACTURE OF HYDROCHLORIC
ACID

By GEOFFREY MARTIN, D.Sc., Ph.D.

Literature—Process of Manufacture—Transport and Storage—Purification of the Acid—Technical Uses of Hydrochloric Acid—Properties of Aqueous Hydrochloric Acid—Specific Gravity of Hydrochloric Acid Solutions	275
------------------------------------------------------------------------------------------------------------------------------------------------------------------------------------------------------------------------	-----

SECTION XXIV

THE MANUFACTURE OF SODIUM SULPHATE
(SALT CAKE)

By GEOFFREY MARTIN, D.Sc., Ph.D.

	PAGE
Literature—Salt Cake Process—Mechanical Salt Cake Furnaces—Hargreave's Process for Manufacturing Sodium Sulphate—Properties of Sodium Sulphate—Glauber's Salt—Sodium Hydrogen Sulphate, Sodium Bisulphate—Sodium Sulphide	281

SECTION XXV

GENERAL SURVEY OF THE SODIUM
CARBONATE INDUSTRY

By GEOFFREY MARTIN, D.Sc., Ph.D.

Natural Sodium Carbonate—Rise and Development of the Manufacture of Artificial Sodium Carbonate—Statistics of the Sodium Carbonate Industry	287
---------------------------------------------------------------------------------------------------------------------------------------------	-----

SECTION XXVI

THE MANUFACTURE OF SODIUM CARBONATE
AND CAUSTIC SODA BY THE LEBLANC
PROCESS

By GEOFFREY MARTIN, D.Sc., Ph.D.

Literature—Manufacture of Sodium Carbonate (Soda) and Caustic Soda by the Leblanc Process—Melting Process—Process of Lixivation—Working the Black Ash Liquors for Sodium Carbonate (Soda)—Working the Black Ash Liquors for Caustic Soda—Summary of the Leblanc Process—Treatment of Alkali Waste—Sulphur by the Chance and Claus Process	291
-------------------------------------------------------------------------------------------------------------------------------------------------------------------------------------------------------------------------------------------------------------------------------------------------------------------------------------------	-----

SECTION XXVII

MANUFACTURE OF SODIUM CARBONATE BY
THE AMMONIA SODA PROCESS

By STANLEY SMITH, M.Sc. (Birmingham)

Literature—Present Position of the Ammonia Soda Process—Historical—Theoretical Considerations—Operations on the Industrial Scale—Preparation of the Saturated Solution of Salt—Saturation of the Brine with Ammonia—Carbonating Apparatus—The Solvay Apparatus—The Honigmann Apparatus—Filtering Plant—Distillation of the Ammoniacal Liquors—The Lime-Kilns—Calcination of the Bicarbonate of Soda—The Compressing Engines—Content of the Carbon Dioxide in the Various Gases—The Content of Carbon Dioxide in the Lime-Kiln Gas—Content of Carbon Dioxide in the Furnace Gases—Content of Carbon Dioxide in the Mixed Gas—Summary of the Operations—Control of the Process—The Yield of Soda Ash—Consumption of Raw Materials and Costs—Modifications of the Ammonia Soda Process—By-Products of the Ammonia Soda Process—Soda Crystals—Crystal Carbonate—Bicarbonate of Soda—Concentrated Crystal Soda, Sodium Sesquicarbonate	299
-----------------------------------------------------------------------------------------------------------------------------------------------------------------------------------------------------------------------------------------------------------------------------------------------------------------------------------------------------------------------------------------------------------------------------------------------------------------------------------------------------------------------------------------------------------------------------------------------------------------------------------------------------------------------------------------------------------------------------------------------------------------------------------------------------------------------------------------------------------------------------------------------------------------------------------	-----

SECTION XXVIII

THE STASSFURT INDUSTRY

By FRANK MILSOM, B.Sc. (Lond.)

	PAGE
Literature—The Stassfurt Industry—Carnallite—Kainite—Kieserite—Glauber Salt—Boracic— Boric Acid—Treatment of Carnallite	329

SECTION XXIX

POTASSIUM SALTS

By FRANK MILSOM, B.Sc. (Lond.)

Technical Potassium Salts—Potassium Chloride—Potassium Sulphate—Potassium Carbonate— Potassium Bicarbonate—Potassium Chromate—Potassium Bichromate—Other Potassium Salts	335
------------------------------------------------------------------------------------------------------------------------------------------------------------------------------------------	-----

SECTION XXX

CALCIUM AND MAGNESIUM SALTS

By GEOFFREY MARTIN, D.Sc., Ph.D.

Lime (Calcium Oxide)—Properties—Uses	341
Slaked Lime (Calcium Hydroxide)—Properties—Uses	341
Calcium Carbonate —Properties—Uses	341
Calcium Chloride —Occurrence—Properties—Uses	341
Magnesium Chloride —Magnesium Oxide—Magnesium Carbonate (Magnesium Alba)	343

SECTION XXXI

THE GYPSUM INDUSTRY

By JAMES SHELTON, F.I.C.

Literature—Properties of Gypsum—Statistics—Alabaster—Selenite—Anhydrite—Plaster of Paris —Formation—Properties—Analysis—Determination of Flooring Plaster—Physical Tests —Slip—Setting Time—Tensile Strength—Specific Gravity—Apparent Specific Gravity— Uses	345
----------------------------------------------------------------------------------------------------------------------------------------------------------------------------------------------------------------------------------------------------------------------------------	-----

SECTION XXXII

BARIUM SALTS

By FRANK E. MILSOM B.Sc.

Natural Barium Compounds— Witherite (Barium Carbonate)— Barytes (Heavy Spar, Barium Sulphate)— Barium Chloride —Manufacture—Properties— Barium Nitrate —Preparation —Properties— Barium Oxide —Barium Hydrate—Barium Peroxide—Other Barium Compounds	351
------------------------------------------------------------------------------------------------------------------------------------------------------------------------------------------------------------------------------------------------------------------------------------------------------------	-----

SECTION XXXIII STRONTIUM SALTS

By FRANK E. MILSOM, B.Sc.

	PAGE
Strontium Carbonate (Strontianite)—Celestine (Strontium Sulphate)—Strontium Oxide—Strontium Hydroxide—Strontium Dioxide—Strontium Chloride—Strontium Nitrate—Application of Strontium Compounds	353

SECTION XXXIV COMPOUNDS OF BORON

By FRANK E. MILSOM, B.Sc.

Literature—Introduction—Chief Boron Minerals—Boric Acid—Raw Materials—Manufacture—Properties—Borax—Varieties—Raw Materials—Manufacture	355
Lead Borate—Perforates—Complex Boron Compounds—Corosalicylates—Cadmium Borotungstate	357

SECTION XXXV THE MANUFACTURE OF CHLORINE BY THE WELDON AND DEACON PROCESSES

By GEOFFREY MARTIN, D.Sc., Ph.D.

Literature—Statistics—The Weldon Process—The Deacon Process—Preparation of Chlorine and Hydrochloric Acid from Magnesium and Calcium Chlorides	359
----------------------------------------------------------------------------------------------------------------------------------------------------------	-----

SECTION XXXVI ELECTROLYTIC CHLORINE AND ALKALI

By GEOFFREY MARTIN, D.Sc., Ph.D.

Literature—General Principles—Electrolysis of Alkali Chlorides for Preparing Chlorine and Alkali	367
I. Diaphragm Processes—Griesheim Cell—Hargreave's Bird Cell—Townsend Cell—Le Sueur's Cell—Outhenin-Chalandre Cell—Billiter-Siemen's Cell—Billiter-Leykam Cell—Finlay Cell	368
II. Quicksilver Processes—The Castner-Kellner Cell—Solvay-Kellner Cell—Rhodin Cell—Advantages and Disadvantages of Mercury Cells	374
III. The Bell Process—The Aussig-Bell Cell—Theory of the Process—Advantages and Disadvantages	375
IV. The Fused Electrolyte Process—The Acker Cell	377
Evaporation and Concentration of the Caustic Soda and Potash—Magnitude of the German Industry—Properties of Chlorine Gas	378

SECTION XXXVII LIQUID CHLORINE

By GEOFFREY MARTIN, D.Sc., Ph.D.

Literature—General Observations—Apparatus for Liquefying and Storing Chlorine—Properties of Liquid Chlorine	381
-----------------------------------------------------------------------------------------------------------------------	-----

SECTION XXXVIII

MANUFACTURE OF CHLORATES AND PERCHLORATES

By GEOFFREY MARTIN, D.Sc., Ph.D.

	PAGE
Literature—Manufacture of Sodium and Potassium Chlorate—Old Milk of Lime Process—Modern Electrolytic Processes—Gall and Montlaux Cell—Gibb's Cell—Lederlin and Corbin's Cell—Manufacture of Perchlorates—Sodium Perchlorate—Potassium Perchlorate—Ammonium Perchlorate—Analysis	385

SECTION XXXIX

BLEACHING POWDER AND HYPOCHLORITES

By GEOFFREY MARTIN, D.Sc., Ph.D.

Literature— Bleaching Powder —Composition—Properties—Application—Manufacture from Concentrated Weldon or Electrolytic Chlorine—Manufacture from Dilute Deacon Chlorine—Manufacture of Pure Calcium Hypochlorite—Valuation of Bleaching Powder—Use as a Disinfectant	391
Electrolytic Bleaching —Theory of Process—Kellner's Electrolytic Cell—Siemen's and Halske's Apparatus for Electrolytic Bleaching—Haas' and Ottel's Apparatus—Schuckert's Apparatus—Schoop's Apparatus—Hypochlorites as Disinfectants—Solid Sodium Hypochlorite	396

SECTION XL

THE BROMINE INDUSTRY

By GEOFFREY MARTIN, D.Sc., Ph.D.

Literature—Occurrence of Bromine—Manufacture—Old Processes—Electrolytic Processes—Purification—Properties—Uses—Bromine of Iron—Bromine Salt—Potassium Bromide—Properties—Uses—Statistics	402
----------------------------------------------------------------------------------------------------------------------------------------------------------------------------------------------------	-----

SECTION XLI

THE IODINE INDUSTRY

By GEOFFREY MARTIN, D.Sc., Ph.D.

Literature—Occurrence—Manufacture from Caliche—Electrolytic Iodine—Manufacture of Iodine from Seaweed—Iodine from Phosphates—Purification—Properties—Test—Alkali Iodides—Potassium Iodide—Sodium Iodide—Statistics Relating to Iodine	407
-------------------------------------------------------------------------------------------------------------------------------------------------------------------------------------------------------------------------------------------------	-----

SECTION XLII

THE HYDROFLUORIC ACID INDUSTRY

By GEOFFREY MARTIN, D.Sc.

Literature—Manufacture of Hydrofluoric Acid —Purification—Properties—Table of Specific Gravities—Storage and Transport—Uses— Hydrofluoroallic Acid —Preparation—Properties—Uses	413
---------------------------------------------------------------------------------------------------------------------------------------------------------------------------------------------------------	-----

SECTION XLIII PEROXIDES AND PERACIDS

By G. W. CLOUGH, D.Sc.

	PAGE
I. PEROXIDES —Definition— Sodium Peroxide —Manufacture—Properties—Uses— Barium Peroxide —Manufacture—Properties—Uses— Calcium Peroxide —Manufacture—Properties—Uses— Magnesium Peroxide —Manufacture—Properties—Uses— Zinc Peroxide —Manufacture—Properties—Uses— Hydrogen Peroxide —Manufacture—Properties—Uses—Estimation	421
II. PERACIDS AND THEIR SALTS —Literature—Nature of Peracids— Persulphuric Acid —Preparation—Properties— Permonosulphuric Acid —Preparation—Properties— Ammonium Persulphate —Preparation—Properties— Potassium Persulphate —Preparation—Properties—Uses	424
III. Sodium Perborate —Preparation—Properties— Perborax —Properties—Uses— Ammonium Perborate —Preparation—Properties—Uses	425
IV. PERCARBONATES — Potassium Percarbonate —Preparation—Properties—Uses— Sodium Percarbonate —Preparation—Properties—Uses	426

SECTION XLIV THE CIRCULATION OF NITROGEN IN NATURE

By GEOFFREY MARTIN, D.Sc., Ph.D.

Literature—The Nitrogen Cycle—Elimination of Nitrogen from Plants and Animals—Nitrification—Denitrification	427
-------------------------------------------------------------------------------------------------------------	-----

SECTION XLV THE NITRATE INDUSTRY

By GEOFFREY MARTIN, D.Sc., Ph.D.

Literature— Sodium Nitrate or Chile Saltpetre —Occurrence—Extraction—Properties—Statistics—Uses— Potassium Nitrate —Manufactures—Properties— Calcium Nitrate — Ammonium Nitrate — Sodium Nitrite	431
-------------------------------------------------------------------------------------------------------------------------------------------------------------------------------------------------------------------------------------	-----

SECTION XLVI THE NITRIC ACID INDUSTRY

By GEOFFREY MARTIN, D.Sc., Ph.D.

Literature— Nitric Acid —Manufacture from Chile Saltpetre—Manufacture from the Atmosphere—Birkeland-Eyde Furnace—Pauling Furnace—Schönherer Furnace—Other Furnaces—General Plant for the Manufacture of Nitrate by Electrical Oxidation of the Air—Manufacture of Nitric Acid from Ammonia (Ostwald's Process)—Properties of Nitric Acid—Statistics	437
------------------------------------------------------------------------------------------------------------------------------------------------------------------------------------------------------------------------------------------------------------------------------------------------------------------------------------------------------------	-----

SECTION XLVII THE AMMONIA AND AMMONIUM SALTS INDUSTRY

By GEOFFREY MARTIN, D.Sc., Ph.D.

Literature— Ammonia and Ammonium Salts —Sources of Ammonia—Statistics—Manufacture of Ammonium Sulphate from Gas-Water or Ammoniacal Liquor—Ammonia Stills—Treatment of Waste Exit Gases from the Ammonium Sulphate Plant—Manufacture of Ammonium Sulphate from Mond Gas—The Direct Process of Making Ammonium Sulphate—Kopper Ammonia Recovery Plant—Otto-Hilgenstock Ammonia Recovery Process—The Coppee Company's Semi-Direct Process	453
------------------------------------------------------------------------------------------------------------------------------------------------------------------------------------------------------------------------------------------------------------------------------------------------------------------------------------------------------------------------------------------------------------------------------------------------	-----

CONTENTS

xix

	PAGE
Manufacture of Caustic Ammonia (Liquor Ammonia)—Concentrated Ammonia Water—Manufacture of Pure Aqueous Solutions of Ammonia—Specific Gravity of Ammonia Solutions	463
Technical Ammonium Salts —Ammonium Sulphate—Ammonium Chloride—Ammonium Carbonate—Ammonium Nitrate—Ammonium Perchlorate—Ammonium Phosphate—Ammonium Persulphate—Ammonium Thiosulphate—Ammonium Acetate—Ammonium Fluoride—Ammonium Sulphocyanide—Ammonium Chlorate—Ammonium Bromide—Ammonium Oleate—Dry Ammonia—Solid Ammonia—Anhydrous Ammonia (Liquid Ammonia)	466

SECTION XLVIII

SYNTHETIC AMMONIA

By GEOFFREY MARTIN, Ph.D., D.Sc.

Literature—Ammonia by Direct Union of Nitrogen and Hydrogen by Means of a Catalyst—Ammonia from Cyanamide—Ammonia from Nitriles—Serpek Process—Other Processes	469
----------------------------------------------------------------------------------------------------------------------------------------------------------------	-----

SECTION XLIX

THE CYANAMIDE INDUSTRY

By GEOFFREY MARTIN, D.Sc., Ph.D.

Literature— Calcium Cyanamide (Nitrolime, Kalkstickstoff)—Manufacture—Uses— Dicyandiamide—Urea—Ferrodur —Nitrogen Products Derivable from Calcium Cyanamide	475
---------------------------------------------------------------------------------------------------------------------------------------------------------------------------	-----

SECTION L

THE CYANIDE AND PRUSSIATE INDUSTRY

By GEOFFREY MARTIN, D.Sc., Ph.D.

Literature—Statistics— Manufacture of Sodium and Potassium Cyanide —From Ferrocyanides (Prussiate)—From Ammonia, Carbon, and Alkali Metal or Alkali Salt—Siepermann's Process—Bielby Process—Castner Process—Manufacture of Cyanide from Sulphocyanides—Cyanides from "Schlempe" or Sugar Residues—Bueb's Process—Manufacture of Cyanides from Calcium Cyanamide—Manufacture of Cyanides from Atmospheric Nitrogen	483
Ferrocyanides—Potassium Ferrocyanide —Properties—Old Process of Manufacture—Modern Processes of Manufacture from Coal-Gas	491
Potassium Ferricyanide—Prussian Blue—Sulphocyanides or Thiocyanates —Recovery from Coal-Gas—Synthetic Sulphocyanides from Carbon Disulphide and Ammonia	493

SECTION LI

THE MANUFACTURE OF NITROUS OXIDE (Laughing Gas, Nitrogen Monoxide)

By GEOFFREY MARTIN, Ph.D., D.Sc.

Processes of Manufacture—Properties—Analysis—Transport	496
--------------------------------------------------------	-----

MANUALS OF CHEMICAL TECHNOLOGY

Edited by GEOFFREY MARTIN, D.Sc., Ph.D., F.I.C., Etc.

*(Reprinted from the most part from Articles in his Complete Treatise on
"Industrial and Manufacturing Chemistry.")*

Each Volume is in Royal 8vo, cloth, fully illustrated where necessary.

DYESTUFFS AND COAL-TAR PRODUCT: Their Chemistry, Manufacture, and Application. By THOMAS BEACALL, B.A.; F. CHALLENGER, Ph.D., B.Sc.; GEOFFREY MARTIN, D.Sc., Ph.D., B.Sc., and HENRY J. S. SAND, D.Sc., Ph.D. [Net 9s.]

THE RARE EARTH INDUSTRY. A Practical Handbook on the Industrial Application and Exploitation of the Rare Earths. By SYDNEY J. JOHNSTONE, B.Sc.(London); with a Chapter on **The Industry of Radioactive Materials**, by ALEXANDER RUSSELL, D.Sc., M.A. [Net 9s.]

CHLORINE AND CHLORINE PRODUCTS. By GEOFFREY MARTIN, D.Sc., Ph.D., with a Chapter on Recent Oxidising Agents, by G. W. CLOUGH, B.Sc. [Net 9s.]

SULPHURIC ACID AND SULPHUR PRODUCTS. By GEOFFREY MARTIN, D.Sc., Ph.D., and J. LOUIS FOUCAR, B.Sc. [Net 9s.]

THE SALT AND ALKALI INDUSTRY. By GEOFFREY MARTIN, Ph.D., D.Sc., and STANLEY SMITH, M.Sc.; with Chapters on the Stassfurt Industry and Potassium Salts, by F. MILSOM, B.Sc. [Net 9s.]

INDUSTRIAL GASES: INCLUDING THE LIQUEFACTION OF GASES. By GEOFFREY MARTIN, D.Sc., Ph.D.; J. M. DICKSON, B.Sc.; E. JOBLING, A.R.C.Sc.; H. STANLEY REDGROVE, B.Sc.; ERNEST A. DANCASTER, B.Sc., and F. B. GATEHOUSE. [Net 9s.]

ANIMAL AND VEGETABLE OILS, FATS, AND WAXES: Their Manufacture, Refining, and Analysis, including the Manufacture of Candles, Margarine, and Butter. By GEOFFREY MARTIN, D.Sc., Ph.D., etc., etc. [Net 12s. 6d.]

PERFUMES, ESSENTIAL OILS, AND FRUIT ESSENCES. Used for Soap and other Toilet Articles. A Concise and Practical Account, including their chief Constants, Methods of Analysis, and numerous practical Recipes for the chief Perfuming Mixtures. By GEOFFREY MARTIN, D.Sc. [Net 12s. 6d.]

THE TECHNICAL PRESS LTD.

INDUSTRIAL & MANUFACTURING CHEMISTRY (INORGANIC)

SECTION I SOLID FUELS

BY ALFRED B. SEARLE

LITERATURE

THE literature of fuels is extensive, but it is chiefly in trade journals and in the transactions of learned societies and not in book form.

- S. R. ILLINGWORTH.—“Analysis of Coal and its Products.” London.
A. H. WHITE.—“Technical Gas and Fuel Analysis.” New York.
F. H. WAGNER.—“Coal and Coke.” New York.
C. H. DRAPER.—“Text Book of Heat.” London, 1897.
A. H. SEXTON.—“Fuels and Refractory Materials.” London, 1909.
C. N. ARBER.—“Natural History of Coal.” Cambridge, 1910.
G. LUNGE.—“Industrie des Steinkohlenteers.” Braunschweig, 1838.
PECLET.—“Traité de la Chaleur.” Paris, 1878.
F. FISCHER.—“Chemische Technologie der Brennstoffe.” Braunschweig, 1897.
JUEFTNER VON JONSTORFF.—“Die Heizstoffe und Wärmelchre.” Vienna, 1890.
—“Heat Energy and Fuels.” London, 1908.
J. B. C. KERSHAW.—“Fuel, Water, and Gas Analysis for Steam Users.” London, 1919.
H. POOLE.—“The Calorific Power of Fuels.” London, 1903.
PERCY.—“Fuel.” London, 1864.
J. S. S. BRAME.—“Fuel: Solid, Liquid, and Gaseous.” London, 1924.
F. J. BRISLEE.—“Introduction to the Study of Fuels.” London, 1912.
H. J. PHILLIPS.—“Fuels: Their Analysis and Valuation.” London, 1903.
GREENWELL and ELSDEN.—“Analysis of British Coals.” London, 1909.
E. E. SOMERMEIER.—“Coal: Its Composition, Analysis, etc.” London, 1912.
MILLS and ROWAN.—“Fuel and its Applications.” London, 1889.
W. W. F. PULLER.—“Combustion of Fuels.” London, 1900.
WILLIAMS and CLARK.—“Combustion of Fuels.” London, 1891.
F. T. GISSING.—“Commercial Peat.” London, 1909.
BJÖLING and GISSING.—“Peat.” London, 1907.
BYROM and CHRISTOPHER.—“Modern Coking Practice.” London, 1913.
See also references in text.

The *Journal of the Society of Chemical Industry*, the *Journal of Gas Lighting*, the *Journal of the Institute of Fuel*, together with the chief engineering and colliery journals, have the most recent information, especially as regards plant and processes. For statistics see the *Mineral Industry of Great Britain* (Imperial Institute, 1933) and *Dept. Sci. Ind. Res. Fuel Res. Survey Papers*.

FUELS are materials whose chief value lies in their use for the production of heat. They may be solid, liquid, or gaseous in form, and of great diversity of composition. Most fuels, however, owe their value to their content of carbon or hydrogen, or to both these elements. In some instances, fuels are of mineral origin exclusively, as the sulphur used in Sicily in smelting sulphur ores, or the combined sulphur in pyrites which assists in the roasting of that ore. The silicon, manganese, and phosphorus in iron used in the Bessemer process of steel manufacture also act as fuels, and in a few cases the heat produced by chemical reactions is sufficient to raise the products to the desired temperature without the use of additional fuel. The use of magnesium and aluminium as fuels is the essential feature of “thermite” welding and similar processes in which an intense local heat is required. The temperature attainable by this means is estimated at 3,000° C. It is not customary to regard an electric current as a fuel, though the use of it in electric furnaces and in radiators effects all the usual results demanded of a fuel, and frequently permits temperatures to be obtained which would otherwise be impossible. In other cases also the use of electricity as a source of heat is more convenient than that of a fuel.

Classification of Fuels.—The following classification of fuels is usually

adopted, and, although it omits silicon, sulphur, phosphorus, and other special fuels, it answers almost every purpose :—

I. *Solid Fuels*—

(a) Natural—

- (1) Wood.
- (2) Peat.
- (3) Lignite.
- (4) Coal.

(b) Prepared—

- (1) Charcoal.
- (2) Charred Peat.
- (3) Coke.
- (4) Semi-coke (Coalite).
- (5) Briquettes.

II. *Liquid Fuels* (Section III.)—

(a) Natural oils.

(b) Distilled oils and spirit.

III. *Gaseous Fuels* (Section XIII.)—

(a) Natural gas.

(b) Prepared—

- (1) Coal-gas.
- (2) Producer-gas.
- (3) Water-gas.
- (4) Oil-gas or air-gas.
- (5) Acetylene.
- (6) Hydrogen.

Wood.—Wood is the partially hardened vegetable tissue of trees and bushes, the smaller pieces being distinguished as brushwood. It is principally composed of cellulose, $C_6H_{10}O_5$, its composition being practically the same in every kind of plant producing it. Some variations are naturally observable, but a fair average is :—

	Pure Cellulose.	Average Wood (Dried).
Carbon	44.4	50.3
Hydrogen	6.2	6.2
Oxygen	49.4	40.4
Nitrogen	1.0
Ash	2.1
	100.0	100.0

Wood usually contains a large proportion of water ; in freshly felled wood it may amount to 50 per cent., or more, and wood which has been laid aside to dry without heat ("air-dried wood") will usually contain 20 per cent. of water. When the wood is burned, this water is converted into steam, the evaporation absorbing a large proportion of the heat in the fuel.

The ash or mineral matter in wood is not an impurity, but an actual constituent of the plant, the elements in the growing plant being in a highly complex state of combination which is destroyed when the wood is burnt. If the burning has been complete, the ash will usually be white, or slightly reddish in woods containing iron compounds. Black particles are usually pieces of incompletely burnt wood. Wood ash consists principally of potassium carbonate with variable quantities of calcium, magnesium and sodium carbonates, and lesser quantities of iron oxide, alumina and silica.

In spite of its convenience and extended use, wood is not a good fuel, as it contains so large a proportion of water and but little available hydrogen relative to the total hydrogen present. The calorific or heating power of wood is only 5,600 B.T.U. when air dried, and 7,000 B.T.U. when kiln dried at 140° C. There is but little difference in this respect between the harder and softer woods.

The chief value of wood as a fuel lies in (a) its ready inflammability, which makes it useful in starting the burning of other fuels, (b) the length of flame

produced on burning, and (c) the small amount of ash and soot produced. This last quality makes wood specially useful in certain industries, as in the melting of glass in small works and in the firing of porcelain and some other kilns and furnaces where a "clean heat" is essential. The maximum temperature attainable with wood alone is not great, and is largely dependent on the amount of water present in the fuel. Wood should, therefore, be dried carefully before being burnt, the best results being obtained by drying it at a temperature of 125°-140° C. This is usually effected by storing it in "a warm place." If wood is heated to 160° C. or more, it is decomposed, forming a number of volatile products and (if air is excluded) a black residue of charcoal.

The decay of wood-forming plants under suitable conditions of moisture and temperature leads to the production of a number of other fuels, of which peat, lignite, and the various kinds of coal are the most important.

Peat.—When vegetable matter is allowed to decay it forms a light brown material bearing some resemblance to peat, but its nature depends largely on the nature of the original plant and on the manner of its decomposition. Most of the British peat deposits are due to the decay of certain mosses (*Sphagnum*), but in other lands it has a different origin. The older deposits are naturally the furthest from the surface, and are usually much darker in colour and considerably more dense. The usual source of peat is the peat-bogs which abound in some localities, as in Cheshire and in central Ireland. The material is cut with small spades, and is dug out in the shape of blocks not unlike an ordinary building brick. These blocks are then piled one above the other so as to permit them to dry as much as possible. Freshly dug peat contains 90 per cent. or more water, and even after drying in the open air it contains 20 per cent. of water. Drying by heat in hot chambers is found to be unprofitable. On the Continent—where more attention is paid to the use of peat as fuel than is the case in this country—steam navvies are employed in some localities for its removal, and various other elaborate devices are employed for draining moors and bogs in order that the peat they contain may be obtained in a state of dryness sufficient to permit of its convenient treatment. The chief feature of these machines is the distance from the wheel-base at which they can work. Peat-bogs do not permit of a good foundation for a heavy machine, and even the construction of rafts involves great difficulties; hence the most successful machine for getting the softer and wetter peats consists of a very long arm provided with buckets, driven from the portable engine which forms the main part of the machine, so that the whole acts somewhat like a dredger used for the removal of silt from navigable rivers. The wet turf or peat obtained in many Continental bogs is too soft to be piled up, and must be compressed into briquettes before it can be stacked out to dry.

A method proposed by Engelhardt for the removal of most of the water from peat consists in heating the peat with water under slight steam pressure in a boiler. The heat causes some decomposition of the slimy constituents of the peat, and the heated material may easily be pressed mechanically into blocks which contain considerably less moisture than the best air-dried peat. Unfortunately, this process has not been developed, as its inventor died shortly after the publication of the outline of his method. In those instances where it was tried under his supervision it appeared to hold great prospects of success.

Solidified peat may also be prepared by a process patented by Gwynne in 1853, which consists in drying the peat in a hydro-extractor, grinding it to powder, and then pressing it into blocks in presses, the dies of which are heated.

Peat is very variable in composition, but bears a considerable resemblance to wood, though usually containing much more ash (average 3-5 per cent.). Peat ash is largely contaminated with the soil from the site in which the mosses originally grew, and it is usually richer in iron oxide than the ash of living plants of the present day.

Peat has a low calorific power—seldom exceeding 5,000 B.T.U.—so that weight for weight it is not half as valuable as coal. When burning, peat falls to powder

and tends to extinguish itself unless frequently stirred; it is, therefore, an unsatisfactory fuel, and should only be used after the most careful consideration.

Many patents have been obtained for the drying and utilisation of peat, but most of them are of little or no commercial value. In many instances the drying of the peat in the manner suggested in the Patent Specification would prove technically impossible under the conditions prevailing in the peat-bogs, or financially unremunerative. It is, of course, possible that some of the processes which are now unsatisfactory may be developed in some unexpected manner and become a source of profit, though it is, at present, impossible to see how this can occur. The application of new methods may also prove to be of greater importance than they now appear to be: the patents taken out in Germany by Graf Bothe Schwerin und Farbwerke vorm Meister Lucius & Brüning in 1900-1904 are of this class. They are based on Quincke's discovery that when a solid is suspended in water (particularly if it is of a colloidal nature) and subjected to a suitable electric current, the solid portion will travel to one pole and the water will travel towards the other. Hence a wet substance will tend to lose some of its contained water, and will be obtainable in a drier form than that in which it originally occurs at the positive pole. This electro-osmosis process has been used in a Prussian peat plant for several years, and is successful in reducing the water-content of the peat from 85.60 per cent. The product is then dried by steam until it only contains 20 per cent. of water, the drying being facilitated by the previous electrical treatment. Such treatment is scarcely applicable to British peats, as they do not possess the peculiarly fluid nature of the Prussian one, and consequently can be air dried to an extent which is impossible with the latter.

There is greater promise of usefulness in Gercke's process, in which the peat is heated in a boiler, the steam produced being used for engine-driving, and the hot peat being removed and used for fuel. The process is made continuous by means of a screw conveyer in the boiler, which pushes the hot peat out of the latter in a small but steady stream. The difficulty which is the chief factor against this process is the unsuitability of peat-bogs as sites for industrial purposes.

It has already been stated that the drying of peat by artificial heat is unremunerative. For this reason the use of gas engines driven by "peat-gas" is not likely to be useful except in the immediate vicinity of the peat-bogs, and as these are situated in localities unfavourable for large industries, the use of such peat-gas must be extremely circumscribed.

A suggestion which seems worthy of greater consideration than it has hitherto received, advocates the erection of an electric power station on an edge of a peat-bog, and driving the dynamos by engines whose source of power is peat. This problem is not as simple as appears at first sight, but it holds out more possibilities than many other suggestions, inasmuch as electricity can be carried over great distances without serious loss in transport—a characteristic which is possessed by no other form of power.

The production of peat charcoal is described later.

Lignite.—In the various stages of transformation of living plants into coal, the various materials classed together as lignites or **Braunkohle** are important as being intermediate in character between the plant and the final product of coal. The lignites may, in fact, be regarded as incompletely formed coals.

In Central Europe, lignite deposits form an important source of fuel, but in Great Britain they are comparatively unimportant, the chief deposit being at Bovey Tracey in Devonshire.

There are several varieties of lignite, including **brown coal**, **pitch coal**, **moor coal**, **jet**, etc., but they are of no commercial value in Great Britain, as they are all inferior to ordinary coal and are only used in those countries where the latter is inaccessible or inordinately costly.

In composition, lignites vary greatly, particularly as regards their ash-content. If their composition is calculated on the assumption that they are free from ash and water, most lignites conform fairly closely to the following average composition:—

Carbon	-	-	50.77 per cent., averaging 63 per cent.
Hydrogen	-	-	3.5 per cent.
Oxygen	-	-	25.36 per cent., averaging 32 per cent.
Nitrogen	-	-	0.2 per cent.

Like peat, the lignites contain a large proportion of water—from 18.60 per cent.—which must be removed either by drying in the open air or by artificial means. On the Continent, they are used chiefly in the form of briquettes and then ignite easily, burning with a long, smoky flame. They are also used in the manufacture

of a form of peat charcoal (p. 18). Their calorific power is intermediate between that of peat and coal.

Coal.—By far the most important solid fuel is coal, and it is one of the curiosities of technology that there is, at present, no really satisfactory definition of this material. One of the least objectionable definitions states that “Coal is a mineral substance of a dark brown or black colour, composed of the remains of plants and containing such proportions of carbon and hydrogen that it can be used as a fuel.” Its origin is by no means fully understood, much that has been written in various geological and other text-books being purely conjectural and not accepted by those living scientists who have given most attention to the subject. The general consensus of opinion is best appreciated by reading Dr Arber’s “Natural History of Coal” (Cambridge Manuals of Science).

The literature of the geology of coal and the methods of mining it is very extensive, and the number of different coals now known is very large; the following are, however, the most important :—

Bituminous coal (ordinary coal).
Anthracite.
Cannel coal (gas coal).

Bituminous Coals burn with a yellow, luminous flame resembling that of bitumen from which they derive their name. They are usually black in colour, and those in Great Britain belong almost exclusively to what is known geologically as the Coal Measures of the Carboniferous period. When examined in the form of thin slices under the microscope they are found to consist of a yellow, semi-transparent material due to the spores in the plants from which the coal is derived, together with a darker, opaque material, the nature of which is imperfectly understood. These coals are widely distributed in Great Britain, and though their general occurrence is well known, the boundaries of some coalfields cannot be defined with certainty as they are hidden by rocks of a more recent formation. This is particularly the case with the eastern and south-eastern extremities of some of the Midland coalfields. Generally speaking, the largest industrial centres are situated conveniently near the coalfields, though this is not invariably the case, London being a prominent exception.

As the precise nature of coal is far from being completely understood, it is impossible to classify it satisfactorily. The chemical composition of coals only affords an approximate idea of their nature, for in spite of extensive investigations, the identity of the chemical compounds which constitute coal has not been identified. The ease with which these compounds are decomposed by heat, the complex nature of the decomposition products and the difficulty of isolating any compounds without first destroying the original composition of the material all unite in rendering the chemistry of coal one of the most complex branches of science. The results of an ordinary analysis lead to no definite conclusions as to the actual compounds present, and it is therefore convenient to classify coals by their technical uses rather than in accordance with their composition. The following classification is convenient, though not free from objection on the score of overlapping :—

1. **Long-Flamed, Non-Coking Coals**, abundant in Scotland, Derbyshire and Staffordshire, and used for blast furnaces. These coals produce a considerable quantity of gas and tar on distillation. In blast furnaces, the gas produced yields 20-25 lbs. of ammonium sulphate per ton of coal burned, and is therefore worth recovery.

2. **Gas Coals** burn with a long, luminous flame, and yield a soft caked coke. Their chief characteristic is the proportion of gas produced on distillation, this being seldom less than 18 per cent. or 10,000 cub. ft. per ton. These coals are also in great demand for reverberatory furnaces, where a long flame is required, and for a variety of other purposes.

3. **Furnace Coals** are somewhat less expensive than the coals previously mentioned, and are used for general purposes. They are also known as **house coals**

and **steam coals** from the fact that they are suitable for domestic purposes and for heating steam boilers. They produce a good coke of moderate compactness, but do not evolve so much gas or burn with so long a flame as the coals in the two former classes. They are, therefore, less suitable for reverberatory furnaces, but excellent for other furnaces and kilns. They cannot be used in blast furnaces, as the coking is detrimental to the movement of the ore in the latter.

4. **Coking Coals** are those which are specially suitable for the production of coke of a solid, hard, and coherent nature. They burn with a relatively short flame, and produce very little gas. Whilst primarily used for coke-making, they are also suitable for domestic purposes and for furnaces in which a short flame is required.

5. **Anthracites or Smokeless Coals** are more highly carbonaceous than other coals, and are more difficult to burn. They give an intense local heat, little flame, and are not particularly adapted for general use. They are chiefly employed for heating boilers and occasionally for smelting iron. Anthracites appear to be coals which have undergone a further decomposition and condensation. They occur chiefly in South Wales, at the western end of the ordinary coalfields in that country.

6. **Cannel Coals**—used almost exclusively for gas-making—form a distinct class, and cannot be included among the bituminous coals, as their mode of formation and general characteristics are different. They burn with a long, luminous, and smoky flame, with a crackling sound, and for this reason are often called **parrot coals**. The poorest cannel coals bear a close resemblance to shales, and are of little value.

The various classes of useful coal are shown in the following table, but for further details some of the larger books on Coals and the publications of the Geological Survey should be consulted.

	Carbon per cent.	Hydrogen per cent.	Oxygen per cent.	Proportion of Oxygen to Hydrogen.	Products of Distillation.			Coke per cent.	Nature of Coke.
					Ammonia Liquor.	Crude Tar.	Gas.		
1. Non-caking coal, long flame -	75	5.5	19.5	4	12	18	20	50	Pulverulent or only slightly coherent.
	80	4.5	15	3	5	15	30	60	
2. Gas coal -	80	5.8	14.2	3	5	15	20	60	Caked, but with many crevices, soft.
	85	5.0	10	2	3	12	17	68	
3. Furnace coal -	85	5.0	11	2	3	13	16	68	Caked, moderately compact.
	89	5.5	5.3	1	1	10	15	74	
4. Coking coal -	88	5.5	6.0	1	1	10	15	74	Caked, very compact and hard.
	91	4.5	5.5	1	1	5	12	82	
5. Anthracitic coal -	90	4.5	5.5	1	1	5	12	82	Pulverulent or slightly adherent.
	93	4	3	1	0	2	8	90	
6. Cannel coal -	84	5	8	{ 8 to 5 }	25	50	Slightly adherent.

Impurities in Coal consist chiefly of water, ash, sulphur, chlorine, and phosphorus compounds.

The water found in freshly mined coal will usually evaporate if the coal is allowed to dry in the air, but excessive exposure should be avoided as oxidation changes occur which reduce the heating power (see p. 19). Coal which is moist and stored in closed spaces is liable to become heated in consequence of internal chemical reactions of an obscure nature. It must, therefore, be watched to see that it does not set itself on fire—a danger to which it is particularly prone on board ships.

The ash, left when coal is burned, is objectionable in some industries, because of its reaction with the materials or articles being heated. It varies greatly, both in amount and composition, but should not ordinarily exceed 5-8 per cent. In all cases a large percentage of ash is objectionable as involving a heavier cost for transport, and the necessity of putting a larger quantity of coal on the fire and of removing the excessive amount of ash. Some firms insist on the coal merchants making an allowance proportionate to these additional costs, when the ash is above 5 per cent. It is obvious that a coal with 10 per cent. of ash involves an additional cost of about 8 per cent. as compared with the same coal containing only 5 per cent. of ash. This may not matter on a single ton, but for a firm using only 300 tons per year it means a waste of 24 tons.

The sulphur, chlorine, and phosphorus in coal are important in some industries. The first and last are objectionable in metallurgical work, and the chlorine is liable to cause corrosion of boiler tubes. The proportion of these elements cannot be determined by an analysis of the ash as they are to some extent volatile under the conditions under which coal is burned. They may be retained by mixing the finely ground coal with powdered lime, heating the mixture in a muffle and analysing the residue.

Valuation of Coals.—The usual methods adopted in purchasing coal are crude in the extreme, and are based on a failure to recognise that coal is a material which should be bought, like other chemicals, on its composition, or like other forces on the work which it will accomplish. The fact that it is a naturally occurring substance does not relieve purchasers from the necessity of ensuring that it is of the quality they require for their work, nor does it justify colliery proprietors in charging the same price for coals of different heating powers.

Coal is usually valued by its appearance, hardness and size of particles. What is termed "run of mine" is the coal which is brought direct out of the pit and delivered to the customer. For most purposes, however, the coal is sorted by passing it over screens with holes of various sizes. The largest lumps are thus separated and are sold at higher prices, though they do not necessarily have a higher heating power than some of the smaller pieces. Where the coal is to be stacked, it will be wisest to purchase the large lumps, but for ordinary furnace and boiler purposes it is more satisfactory to use pieces which are not more than 5 in. or less than 1 in. diameter. These are known by various names in different localities, but they are characterised by the fact that most of the earthy material (which would form ash) has been removed by screening out the finer particles, whilst the necessity of breaking up the unduly large pieces is avoided. Moreover, the prices obtainable for the large lumps enable the colliery proprietors to sell the smaller pieces at a lower price.

"Small coal" is that which has passed through the smallest screen and contains a large proportion of ash-forming material. It is sold at a low price, but is not as economical as appears at first sight for it is usually difficult to burn, is low in heating power and contains ash of a nature which is liable to give a great amount of trouble. The large quantities of small coal produced have, however, made it of commercial importance, and various ingenious devices have been invented for its efficient combustion. Where such can be used, the value of the coal will be determined by the cost of installation and maintenance and by the amount of labour involved in the handling of the ash and the cost of its disposal by tipping or otherwise.

In all fuels, the essential characteristic is the heating power under the conditions in which they are to be used, or under such modified conditions as are applicable to any particular case. The value of a fuel should therefore be based on this fact, though this is seldom done. The nearest approach to it is the comparison of the costs of burning various test samples under "average conditions," but this is, at best, a crude process and depends too much on the idiosyncrasies of the fireman to be really reliable.

Earnest endeavours have been made in various directions to base the value of a coal on its **calorific power**, that is on the amount of heat which it will develop under certain experimental conditions. These conditions vary according to the form of instrument used, but at the present time it is customary to burn 1 g. of the coal in an atmosphere of oxygen in a closed vessel surrounded by cold water. The coal is ignited electrically, the combustion is almost instantaneous, and the heat evolved raises the temperature of the containing vessel or "bomb" and of the surrounding

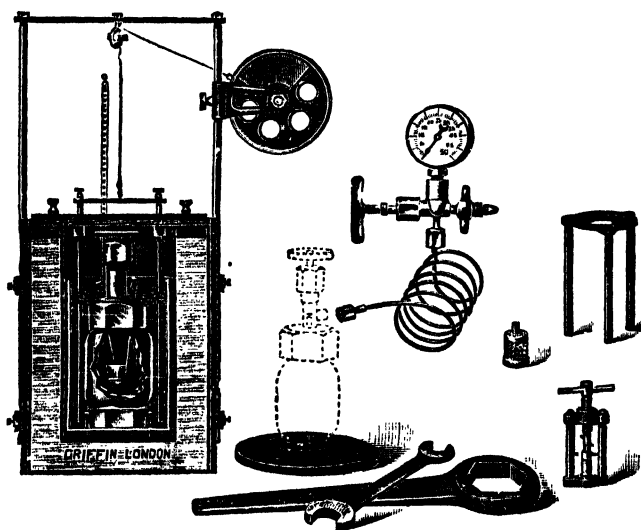


FIG. 1.—Mahler-Cook Calorimeter.
(By the courtesy of Messrs J. J. Griffin & Son Ltd.)

water. The weight of the bomb and the water being known, the amount of heat evolved is measured by multiplying these by the specific heats of the materials and by the rise in the temperature of each.

Fig. 1 shows the Mahler-Cook calorimeter. The bomb or combustion chamber is made of steel 8 mm. thick, enamelled inside, nickel-plated outside. The oxygen enters through a valve in the cover, and the fuel, placed in a platinum capsule inside the apparatus, is surrounded by a very fine platinum or iron wire. The fuel is weighed, placed in the combustion chamber, the igniting wire is weighed and adjusted, the top is screwed down, and oxygen from the oxygen cylinder is then allowed to enter until the pressure gauge registers 25-30 atmospheres. The valves are then closed, the oxygen cylinder and gauge are removed, and the bomb is placed carefully in an accurately measured volume of water (about 2,500 c.c.) contained in a copper-lined vessel with an aluminium cover and stirring gear. A Beckmann thermometer, reading to one-hundredth of a degree, is adjusted so that it will read slightly above zero at the temperature of the water in the calorimeter. The stirring gear is set in motion, and ten readings are taken at half-minute intervals so as to determine accurately the temperature of the water before the combustion. The stirring is then stopped, and the fuel is ignited by passing an electric current from an accumulator through the wire. The stirring is then resumed, and the maximum rise of temperature of the water in the calorimeter is noted, by taking readings at intervals of half a minute until the maximum temperature is reached. Corrections have to be introduced for the amount of nitric acid formed by combustion (which is determined by washing out the bomb, and estimating

volumetrically the nitric acid), the heat capacity of the vessel, etc.; they are best ascertained by burning 1 g. of naphthalene, which has a calorific power of 9667.8 calories per gramme. The true maximum temperature is higher than the observed maximum, and should be ascertained by extrapolation on a graph.

$$\text{Then} \quad \text{calorific power required} = \frac{T(W + W^1) - (0.23n + 1.6f)}{F}$$

Where T = corrected rise of temperature.
 W = weight of water in calorimeter.
 W^1 = water equivalent of apparatus (which must be determined by experiment).
 n = weight of nitric acid produced, f = weight of spiral wire.
 F = weight of fuel used.

A simpler calorimeter, which consists of a modification, by Rosenhain, of the calorimeter invented by Lewis Thomson many years ago, is shown in Fig. 2. It consists of an outer case of wood, provided with two windows for observation purposes. In this case is the calorimeter vessel containing a weighed or measured amount of water, and in the water (when the apparatus is in use, but shown at the side in Fig. 2) is the combustion chamber, consisting of a glass cylinder closed at the top and bottom by brass plates, the upper plate carrying the electric ignition apparatus, a holder for the sample of fuel, and a small tube through which oxygen can be passed through the apparatus. A ball-valve permits the oxygen and gaseous products of combustion to escape and bubble through the water, but prevents any water entering the combustion chamber. Exactly 2 g. of the sample are placed in a small silica dish in the holder, the combustion chamber is lowered into the water, and oxygen is passed through the apparatus. The fuel is ignited electrically, and when combustion is complete the passage of the gas is continued until a maximum temperature has been reached in the water. No stirring of the water is needed, as the mixing is effected by the gases bubbling through it. The temperature reached by the water is then used to calculate the amount of heat developed in the combustion of the given weight of fuel. The loss of heat due to that absorbed by the instrument, escaping gas, etc., is determined by burning a standard fuel which has been tested under stringent conditions.

In the **Roland Wild** calorimeter the combustion of the coal is effected by mixing the fuel with sodium peroxide, and starting the combustion by means of an electrically heated wire.

It is obvious that, no matter how accurately the determination is made, the result obtained can supply no information as to the useful value of the coal in an ordinary boiler or furnace where the conditions of its combustion are entirely different. In fact, the calorific power of a coal merely shows the maximum heat which can be developed by its combustion under the most favourable conditions. It is not surprising, therefore, that coals valued by this method do not agree with the results of actual experience when the same coals are burned in boilers or furnaces of standard design, and unfortunately there is no means of correlating the two. As furnaces are improved, the discrepancies are materially reduced, but even with the best furnaces now in use there is no clearly established relationship between the calorific power of a coal, as determined in a calorimeter, and the amount of heat actually available in a furnace or boiler. It is, indeed, very questionable whether such a relationship will be found, for the conditions in each case are so different. Consequently, the calorific power of a coal is only of value in sorting out coals of different qualities, and it cannot be used to determine which of two similar coals will be most satisfactory in a given boiler or furnace.

The nearest approach to the calorific power, as ascertained in a calorimeter, is obtained when dry coal dust is burned in a special form of injector (see Section IV., p. 42).

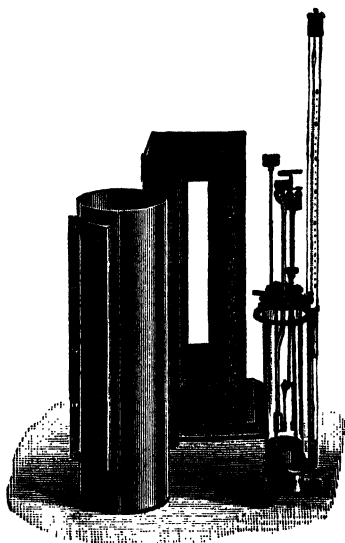


FIG. 2.—Rosenhain Calorimeter.
 (By the courtesy of the Cambridge Scientific Instrument Co. Ltd.)

The following table shows the calorific powers of a number of fuels and fuel constituents:—

CALORIFIC POWER OF VARIOUS FUELS.

	Calories.	B. T. U.
Carbon solid to carbon dioxide - - -	8,080	14,554
Carbon gaseous to carbon dioxide - - -	11,368	20,388
Carbon to carbon monoxide - - - - -	2,416	4,350
Hydrogen - - - - -	34,180	61,524
Marsh-gas (CH ₄) - - - - -	13,349	24,021
Ethylene (C ₂ H ₄) - - - - -	11,823	21,343
Sulphur - - - - -	2,220	3,996
Wood (air dried) - - - - -	2,900	5,220
Wood (stove dried) - - - - -	3,750	6,750
Peat (air dried) - - - - -	3,600	648
Peat (stove dried) - - - - -	5,000	9,000
Steam or furnace coal - - - - -	7,800	1,404
Inferior coal - - - - -	7,000	14,400
Anthracite - - - - -	8,000	12,780
Coke - - - - -	7,100	...

Attempts have also been made to estimate the value of a coal from its composition, and various formulæ have been devised with a view to calculating the calorific power from the composition of the coal. These calculations cannot be quite correct as they are based on several erroneous assumptions; for instance, it is assumed that the chemical compound is the same in all coals, that the elements evolve the same amount of heat as if they were burned in the free state, and that the combustion of the carbon is complete, only carbon dioxide being formed.

The most frequently used of these formulæ is a modification of that of Dulong, viz:—

$$\text{Calorific power} = \frac{\{\% \text{ C.} + 4.265 (\% \text{ H.} - \frac{1}{8} \text{ O. \%})\}}{100} \times 14,544 \text{ B.T.U.}$$

$$\text{Calorific power} = \frac{\{\% \text{ C.} + 4.265 (\% \text{ H.} - \frac{1}{8} \text{ O. \%})\}}{100} \times 8080 \text{ calories.}^1$$

In many instances this formula agrees with the results of a calorimetric test, but this is of small value to the actual user of the coal, for the reasons already explained, and consequently the results of an analysis of the coal are of similarly small value. The chief value of an analysis is that it shows the proportion of deleterious substances present, and so enables coals high in ash and in unavailable hydrogen, etc., to be distinguished from others. It does not enable the actual value to the user to be determined in several coals of different origin and texture, but of similar composition as regards the proportion of ash, carbon, hydrogen, and oxygen.

Unfortunately, there is no reliable method of determining the relative value of two similar samples of coal, so far as the user is concerned, and the best that can be done is to gain what small information is to be learned from the data already mentioned. There is, however, another method of analysis which will often serve to differentiate between two fuels of similar ultimate composition but of different characteristics, namely, the determination of the proportion of volatile matter and of coke left when the coal is heated in a closed vessel into which no air can enter. The test is ordinarily carried out in a crucible, the lid of which is lightly luted on, the crucible with its contents being exposed to the heat of a Bunsen burner for a definite time (with a crucible of 30 c.c. capacity, containing 1 g. of coal in the form of powder, it is usual to allow half an hour's heating). As ordinarily carried out, the coking test is a very crude one, and the same coal will yield widely differing results on different occasions, if the conditions are not precisely similar. It is, therefore, necessary to

¹ A British Thermal Unit and a Calorie are defined on p. 45.

standardise the method of procedure. It is the present writer's practice to carry out this test in the following manner so as to eliminate as many variable factors as possible :—

The crucible used has a capacity of 30 c.c., and is made of silica or porcelain. It is provided with a Rose's lid with a porcelain tube, so as to convert the crucible into a small retort. The sample is reduced to powder, and exactly 5 g. is placed in the crucible. If the lid fits well there is seldom any need for any luting, provided the heating is not too rapid. The coal is then ignited by heating the crucible with the full heat of a Bunsen burner for a few seconds, but as soon as combustible gas is produced, and issues from the tube in the lid of the crucible, the burner is removed, and a very small Bunsen burner is substituted. The gases issuing from the tube must pass out at such a rate that they can be ignited by a small flame held to the end of the tube, but not so rapidly that they will continue to burn when the flame is removed; this means a slow but fairly constant development of gaseous matter. When the inflammable gases have all been distilled off, the crucible is heated with the full flame of the original Bunsen burner for exactly one minute, after which the crucible is cooled and its contents are weighed. It is seldom necessary to weigh the lid of the crucible, or any tarry matter adherent to it.

This method is admittedly crude, but it does give the user of the coal some indication of its nature which is not otherwise obtainable, and in various forms this test has long been used by purchasers of large quantities of coal for industrial purposes.

Indeed, in spite of its crudeness, the following well-known scheme of assay is still the best for the general valuation of most furnace coals :—

Determination of the percentage of ash.

Determination of the fixed carbon per cent. (This is the residue in the crucible, as described above.)

Determination of volatile matter per cent. (This is the loss of weight when the sample is heated in the closed crucible as described above.)

An examination of the coke and of the ash is valuable in some instances, and for special purposes a determination of the proportion of sulphur, chlorine, etc., must be made. It is also important to observe whether the ash is pulverulent or partially fused (clinker), as the latter increases the labour of the fireman, and tends to cause imperfect combustion when the coal is burnt.

The length of flame, the amount of gas, and other special properties of a coal must be determined by special tests, usually on a scale which is too large for the ordinary laboratory.

The **calorific intensity** of a solid fuel is an expression used to indicate the maximum temperature which the fuel can develop when burned under ideal conditions. This is quite different from the total heat evolved and has no simple relation to the latter. It is a purely theoretical expression, as the temperatures it represents can never be obtained in practice by the combustion of solid fuels. If the fuel could be burnt with exactly the right amount of oxygen, under such conditions that the combustion was quite perfect, and that no loss of heat occurred on account of the conductivity of the walls of the vessel in which the combustion occurred, the calorific intensity would have an experimental value, but as it is, it is deduced theoretically by multiplying the theoretical weight of the products of combustion of the elements of the fuel by their respective specific heats and dividing this product into the calorific power as determined in a calorimeter.

The calorific intensity of 1 lb. of carbon is $10,170^{\circ}$ C., and that of hydrogen is $6,660^{\circ}$ C., the figures given being the rise in temperature above the melting point of ice in each case.

According to Haase the highest temperatures attainable experimentally are, for carbon $2,400^{\circ}$ C., and for hydrogen $3,140^{\circ}$ C., though the dissociation of water at high temperatures reduces the maximum temperature of hydrogen to $2,000^{\circ}$ C. in actual work on a large scale.

The calorific intensity or pyrometric heating effect (as it is sometimes termed) is, therefore, only of use as a theoretical standard, quite unattainable in practice, with which actual results of combustion may be compared. Its actual value, even as a standard, is exceedingly small at the present time, as the difference between it and the attainable results for solid fuels is much too large. With gaseous fuels the expression has a greater value on account of the more complete combustion obtainable with gases (see pp. 44-46).

Cleaning Coal (see "Cleaning Coal," by Chapman and Mott (Chapman and Hall)).—The small particles of coal are usually separated from the larger ones by means of screens, and by removal of the larger pieces by hand-sorting and classification according to appearance, but this method of working results in the production of large quantities of fine material which is comparatively rich in coal dust, yet contains too much ash to be used satisfactorily as a fuel. Cleaning processes also permit the removal of the coal from shale containing seams of coal which are too thin to be worked separately. During recent years many attempts have been made to recover the coal from this earthy mixture, and various methods of separation have been used. In some localities there is a definite demand for small coal recovered in this manner for direct use as a fuel in cement kilns, etc., but the greater part of the small coal thus obtained is converted into coke, for which it is fully as suitable as the larger pieces. Not only is the coal recovered from such a material, but the pyrites may also be separated, and this has a distinct marketable value. The methods of separation may be arranged in three groups: (a) separation by special grates, (b) separation in the wet way by jigs, and (c) separation by centrifugal action.

The first of these methods has the advantage of keeping the coal dry. It is based on the fact that most of the coarser impurities in coal are relatively heavier than the coal itself, and that they will travel less rapidly along plates with a vibratory motion. These plates or troughs are made of metal, and are mounted on flat springs in such a manner that they can be given a slow forwards and a sharp backwards movement, whilst at the same time they are sufficiently elastic to vibrate in a vertical direction. By making the troughs very long, it is possible to separate a large proportion of the earthy material simply because it travels at a different rate of speed. This method only effects a rough separation. It has been improved by making the troughs into grates, formed of long bars (**riffle bars**) along which the dirty coal travels, the dirt falling through the grates, whilst the coal travels along to the end. The separation is, in this case, based on the tendency of the earthy material to be of a flaky character, and therefore able to fall through narrower slots than the particles of coal of the same volume, owing to the latter being more spherical in form. For very fine coal this process is unsuitable.

Treatment by **washing** is effected in various ways; one of the best consists in using classifying jigs similar to those used for dressing ores. Several firms make machines of this type, each having some distinctive advantage over the others, so that before installing any one of them it is necessary to make extensive trials with the coal it is desired to treat (see the *Fuel Economist*, May 1931 (Supplement); see also **R. Lessing**, *Chem. and Ind.*, 1931, 84).

The principle on which this method of separation of the coal from the earthy materials in the slack depends is based on the fact that the rate at which particles of solid matter settle in water depends on their size and density. If the particles are all of the same size they will sink in proportion to their density, the heaviest falling first, whilst if they are of the same density the rate of deposition will depend on the size, the largest sinking first (see the *Fuel Economist*, May 1931 (Supplement); see also **R. Lessing**, *Chem. and Ind.*, 1931, 84).

The use of a solution of **calcium chloride** is preferable to water (see **R. Lessing's** patents).

The shape of the particles also exerts an influence, as thin flat pieces sink more slowly than spherical ones of the same volume, but this is neglected in coal washing.

According to Rittinger's experiments for approximately spherical particles:

$$V = 1.28\sqrt{D(d-1)}$$

when V = the velocity of deposition in feet per second, D = the diameter of the particles (usually the diameter of the holes in the riddle is taken as D), and d = the specific gravity of the material.

As the size of the particles is important, it is necessary for a clean separation that all the particles should be as uniform in size as possible; this is effected by the use of screens or riddles of different meshes, the smaller particles being treated in a different jig from the coarser ones.

If the water is given an upward flow, the rate of fall will be diminished, and by this means the lighter particles can be carried away from the heavier ones. If the

water has a horizontal flow, the lighter particles will be carried forward in the direction of the flow.

Two types of washing machine are therefore possible : (a) long troughs through which the material is conveyed by means of a stream of water of known velocity, the coarse and heavy material (dross) being removed at one end of the trough, whilst the coal is carried away at the other end, and (b) jigs in which the water is contained in compartments, and is given a vertical or centrifugal movement. The second type of washer is by far the best for the treatment of coal, whilst the troughs or separating tables are more suitable for certain ores, or for a preliminary treatment of the coal. One of the best of the first type is the **Blackett Washer**.

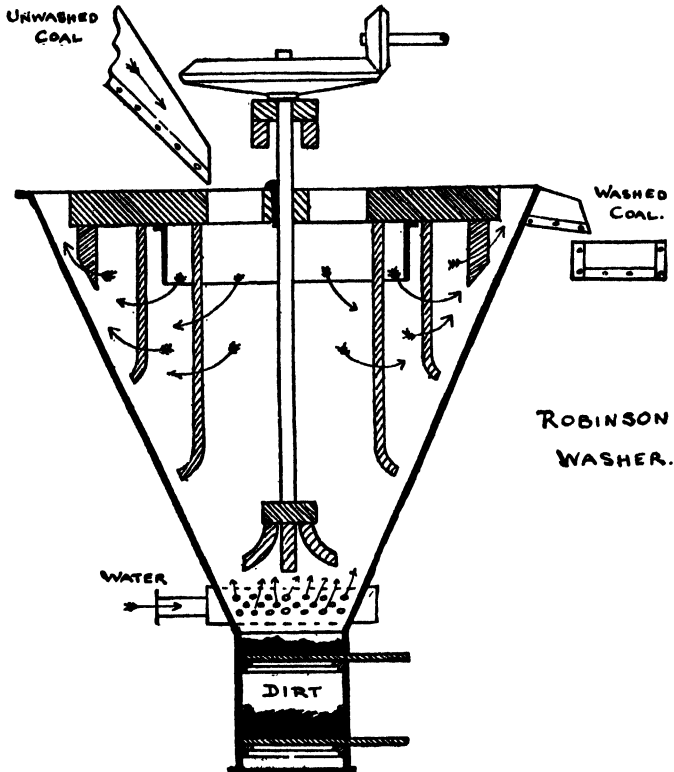


FIG. 3.—Robinson's Coal Washer.

This consists of a long cylinder, at an incline of about 1 in 10, and rotated about nine times per minute. The inside of the washer is fitted with a spiral like the thread of a female screw, with the result that when the washer is in use the heavier particles of "dirt" travel up the cylinder and are discharged at the top, whilst the lighter particles of coal are washed over the spiral by the down-flowing water and are discharged at the lower end of the cylinder. When skilfully adjusted to suit the coal to be treated this gives an excellent separation of coal and dirt.

In Robinson's washer (Fig. 3) the water and coal enter at the bottom of a funnel-shaped vessel, and flow out at the top. A horizontal frame rotates about a vertical shaft in the funnel, and a series of vertical rods or stirrers depend from it. The water is therefore kept in a state of rotary as well as vertical motion, and the coal is carried away over the top of the washer, whilst the dross is removed at intervals from the bottom. This arrangement is somewhat crude and does not give nearly so good a separation as the more modern jigs.

These jigs have recently undergone considerable improvements, and the most modern ones effect a much sharper and more satisfactory separation than did the older ones. In the early forms of jig, there were two compartments, connected together at the base. In one of these was a plunger which forced the water downwards, so that it passed into the next partition and flowed upwards therein in a steady stream. In the more modern jiggers this plunger has been replaced by other devices. Thus, in Baum's classifier (Fig. 4) there are two or more compartments, each divided horizontally by means of a fine gauze. The compartments are filled with water which is given a rising and falling movement by means of compressed air applied to its surface by means of a series of valve-controlled pipes. The coal to be treated flows in at one end of the machine

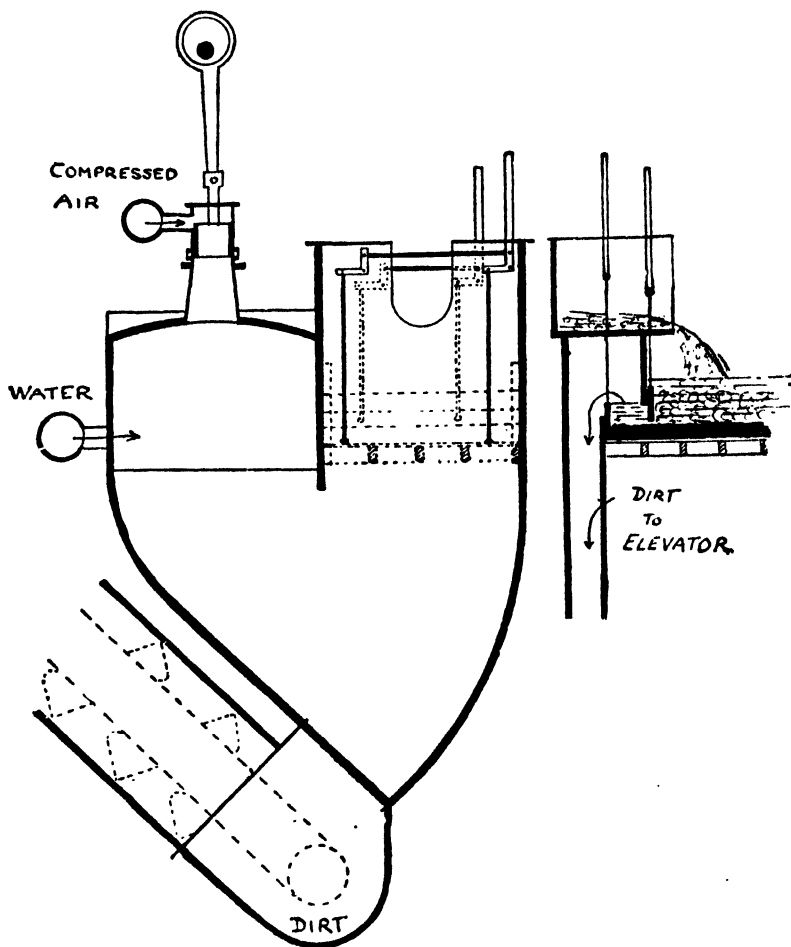


FIG. 4.—Baum's Coal Washer.

and is washed by the moving water acting under the influence of the compressed air. The heavy mineral particles accumulate near the inlet, the medium pieces near the outlet, and the fine dust passes through the gauze into the trough below. The coal, largely freed from mineral matter, passes away through the outlet of the machine and may be treated in a subsequent compartment or sent direct to the drying plant as desired. The drawback to this machine and of all with two compartments, lies in the irregularity of the flow of the water. This is overcome and a simplification in the design of the machine is effected by placing the plunger directly under the grid so that the material will pass uniformly through every portion of the latter. By this means Baum secured several advantages, and in his washing jig the piston slopes towards the outlet, the piston-rods of a series of jigs being connected in pairs to a beam driven by an eccentric. The withdrawal of the product from neighbouring washers is effected in the ordinary manner by valve-controlled pipes. The jigs work reciprocally: as a piston in one section rises and forces the water

uniformly through the grid, the piston in the next chamber falls, and the combined action delivers the slurry to the next jig for further treatment, the action of the first piston assisting the second, so that the machine requires very little power to drive it.

Among other advantages to be derived from using Baum's washers, the following deserve special attention:—

1. The most complete use of the available space, on account of there being no separate piston chamber. The whole of the interior of the washer is used for dressing the material. At the same time the washer is simple, strong, and inexpensive.
2. An absolutely uniform action over the whole surface of the grid is secured as the piston lies directly under it, and for this reason the water is forced through the grid with perfect uniformity through each part.
3. The washing is highly efficient, because the ore is treated uniformly over its whole surface throughout the whole period of treatment.
4. The construction is very simple and the durability of the washer is thereby assured.
5. The washer operates extremely easily, thereby saving power.

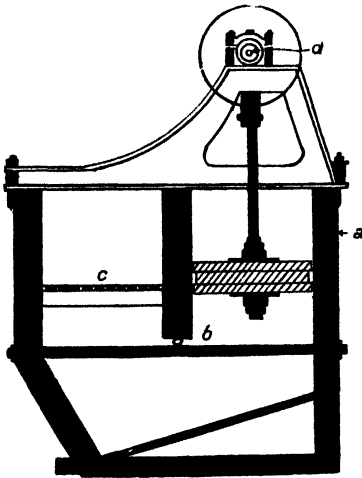


FIG. 5.
Schuchtermann and Kremer's Jig.

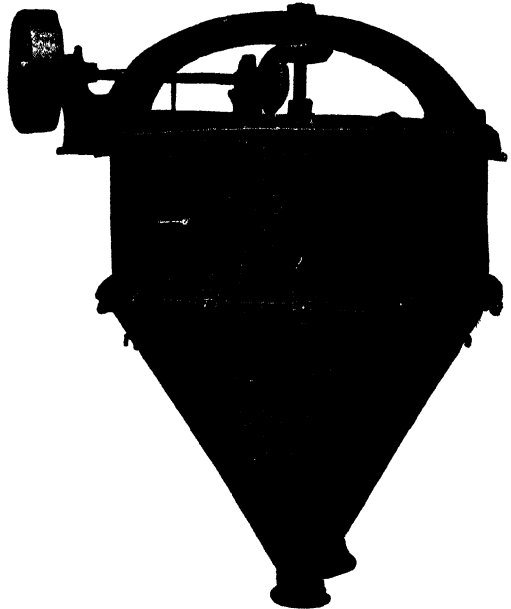


FIG. 6.—Air Separator (Selektor).

6. The movement of the material is efficiently and easily effected. The fine particles fall through the grid on to the sloping piston, and the finest of these are washed off by the movement of the water.

7. For the same space they have double the output of ordinary jigs.

8. There is a marked reduction in first cost, as the saving in space not only lessens the cost of buildings, but also greatly reduces the expenditure on troughs, pipes, channels, and shafting.

For fine coal it is often convenient to use a coarse grid and to place a layer of spar on it. This acts as an efficient sieve which does not choke so readily as one made of metal with small perforations, as the specific gravity of the felspar and dirt in the coal is almost identical, so that when they are raised by the downward motion of the piston in the jig they both settle at approximately the same rate. The "dirt" thus becomes enmeshed in the felspar and gradually falls through it into the bottom of the jig. Fig. 5 shows a section of Schuchtermann and Kremer's jig for fine coal, *a* being the piston driven by the eccentric *d*, whilst *b* is the partition which partially separates the piston chamber from the settling chamber which contains the grid *c*.

Separation by centrifugal action may be effected either by a dry or wet

process; the former consists in allowing the dirty coal (which must be fairly dry) to fall on a rapidly rotating plate in an "air separator" (Figs. 6 and 7). The particles are driven off this plate at a speed which depends upon their size and specific gravity, the denser particles travelling the farthest. Receiving chutes are placed at convenient distances from the rotating plate, and a separation is effected in a simple manner, though it is by no means quantitative. In the wet process, the dirty coal is fed with a stream of water into a rapidly revolving vertical cylinder provided with vertical paddles which rotate at a slower speed. The combined action of the paddles and the cylinder is to effect a separation according to the density of the particles, the lighter coal adhering to the walls of the cylinder, whilst the dross flows out of the machine (Gee's patent).

This device has been found to give a more complete separation than any of the foregoing methods, but it is still in a development stage, and depends on the coal being in the form of a powder. The ingenious manner in which the action of gravity is magnified about a hundred times in this machine renders it worth the attention of colliery owners and others interested in the separation of minerals of widely different specific gravity.

When the coal has been cleaned by the aid of water it must be drained of its adherent water; this is usually effected by passing it over fine grids with a vibratory movement, so that they act simultaneously as conveyers and yet permit the water to flow away from the coal without losing any of the latter. The drying of coal

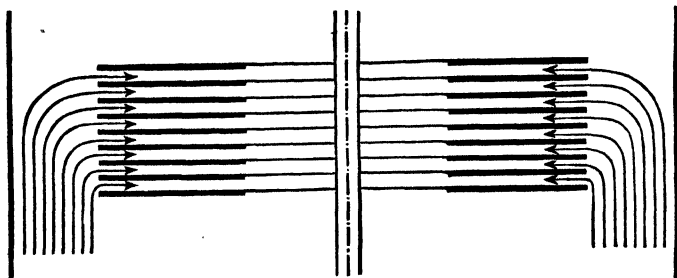


FIG. 7.—Separator Plates in Selektor.

dust is a more complex matter, and is usually effected in rotary drums through which a current of warm air is caused to circulate. Where coke ovens exist on the site of the washing plant, the waste heat from them may be utilised in this manner, and the powdered coal (if of a suitable quality) may be employed for the manufacture of coke.

Prepared Solid Fuels.—These are produced from the foregoing solid fuels by methods of consolidation in which the volatile matter and water in the natural fuel is removed by heat, the resulting product being richer in carbon and poorer in hydrogen than the material from which it is made. A different method of preparing solid fuels, in which the natural properties of the original fuel are largely retained, consists in the formation of briquettes by the action of pressure. This is described in detail in Section II., p. 21.

The chief prepared solid fuels (apart from briquettes) are charcoal, charred peat, charred lignite and coke; these are all produced by heating the raw fuel under such conditions that only a limited amount of combustion can occur, the essential feature of the process being the distillation of all the volatile matter without the combustion or removal of other carbonaceous matter.

Charcoal is prepared by heating wood without access of air. It was at one time an important metallurgical fuel, but is now used to only a limited extent. The amount produced depends to some extent on the nature of the wood, and on the construction of the kiln or other arrangement in which the wood is heated, but it seldom exceeds 25 per cent. of the weight of the original wood.

Charcoal is prepared in the South of England by arranging the logs of wood almost vertically around a central shaft or chimney, and covering the pile thus obtained with sods or turf. Each heap is usually 6 ft. or more in diameter, and 8 ft. high. The central chimney is made of three or four upright poles kept a suitable distance apart by cross-pieces. This chimney is filled with dry brushwood, and a ring of similar brushwood is placed around the base of the pile, just beneath the cover. The brushwood in the centre of the shaft is ignited, and is fed with more brushwood until it is well alight. The opening above it is then covered with turf. As the heat spreads throughout the pile it drives off the water, which escapes partly as steam and partly in the form of drops of water around the outer edge of the pile. When this "sweating stage" is complete two series of openings are made in the pile; the lower one, near the ground, is for the admission of air, and the upper one, about half way up, is for the exit of the gases formed. At first the smoke which comes out of the upper holes is strongly coloured, but in due course it diminishes, and finally becomes almost invisible. This is a sign that the hydrocarbons are almost completely volatilised, and that carbonation in one part of the heap is complete. The upper openings are therefore closed, and a fresh series is made lower down. These operations are repeated until the whole of the heap is properly carbonised. The heap is then left for a few days, and is finally taken to pieces and quenched with sand or water. The opening is best performed at night, as it is then easier to observe the sparks.

In some parts of the Continent (notably in Scandinavia) the heaps are rectangular in shape, and bear a close resemblance to the clamps used in this country for burning bricks.

In each case it is necessary to exclude air wherever it is not required, and as the volume of the heap is reduced during the burning, the cover must be repaired from time to time.

Considerable skill is needed in the erection of the piles and in the control of the burning, if a good yield is to be obtained. An unskilled burner will only produce 15 per cent. of charcoal, whilst a skilled one will obtain a yield of about 25 per cent.

Charcoal is also burned in kilns similar to those used for burning lime (*q.v.*), this method having the advantage that the rain does not interfere with the burning. The argument that the cost of the kiln is less than that of providing a turf cover may be apposite in a country like America—where kilns for charcoal are chiefly used—but the few investigations made in England seem to show that if a charge is made for interest on capital and for the depreciation of the kiln, little or no advantage is gained in this country. If the kilns are arranged in series so that the waste gases, due to the decomposition and distillation of the hydrocarbons, may be used in heating up subsequent kilns, there is a distinct gain in employing permanent structures. This is the essential feature of the Pierce process now largely used in the United States. The kiln is charged with wood and closed. It is then heated with gas from another kiln, and the gases and tarry matters evolved are passed through condensers for the recovery of the by-products. The gas, being incondensable, is available for use in another kiln. There is usually more gas than is actually needed for the charring, and this can be profitably employed in heating boilers for the production of power for other purposes. Sixteen kilns form a convenient unit, each kiln being about 30 ft. in diameter and 12-16 ft. high.

The charcoal produced in these kilns is somewhat denser than that burned in clamps or heaps, and weighs about 20 lbs. per bushel, as compared with 16 lbs. for ordinary charcoal. Some users object that it is not as good in quality as the charcoal burned in the older method, but it is difficult to decide impartially on this matter, the experimental data available being insufficient for this purpose.

In Norway continuous tunnel kilns are used (Gröndahl's Patents). The wood is carried on small cars through the furnace.

In Great Britain the bulk of the charcoal now produced is a by-product obtained in the manufacture of acetic (pyroligneous) acid. For this purpose the wood is heated in iron retorts, and the volatile acid and other products are distilled off and collected by condensation. The charcoal so produced is very inferior, because the wood used and the conditions of distillation are such as will secure a large yield of the various by-products desired, little or no attention being paid to the quality of the charcoal. This method is very similar in principle to that devised by Pierce and described above. The plant employed is fully described in **Martin's** "Industrial Chemistry: Organic," p. 323 *et seq.*

The production of sawdust and other waste wood has led to many devices being patented for its effective utilisation. It cannot be made into a good charcoal as it does not bind well together, and if used in the raw state as a fuel it gives off an inconveniently large amount of water. The manufacture of briquettes of charred wood-waste is not a satisfactory solution of the problem as these briquettes are too dense to burn properly. The addition of resin or tar as a binding material is too expensive except for the manufacture of firelighters. Apart from the direct combustion of the wood in specially devised fire-boxes, it is best utilised by distillation in iron retorts provided with an internal spiral conveyer; this permits the recovery of the volatile products, and the low grade or charcoal can usually be sold at a price which leaves a slight margin of profit. There have been many patented arrangements for the production of charcoal from sawdust, but in no case is the resulting charcoal of much value; the only way is to utilise the by-products and regard these as the main source of any profit which may accrue from the process of charring.

The *properties of charcoal* as a fuel depend on the special manner in which it burns, and on the freedom of its ash from deleterious substances. Carefully prepared charcoal should show distinctly the characteristic markings of the wood from which it has been produced. It should be sufficiently hard to resound when struck. It should ignite readily, and when once glowing it should continue to burn until it is completely consumed. It should be noted, however, that the temperature at which charcoal ignites is dependent on that at which it has been prepared.

The ready combustion of charcoal is, in part, due to the porosity of the material, as air is able to enter freely into the pores. Some idea of its porosity may be gained from the statement that the specific gravity of charcoal is only 0.2, whilst that of the same material, when the effect of the pores has been excluded, is about 2.0. This great porosity gives charcoal its valuable property of absorbing gases such as ammonia and sulphuretted hydrogen.

When burning normally, charcoal simply glows, but when combustion is forced it burns with a blue flame and forms large quantities of carbon monoxide (CO), the flame being really due to the combustion of this gas and not to the charcoal itself. On account of the cleanliness of the flame and its freedom from smoke, charcoal is a valuable fuel in metallurgy, and particularly in the reduction of metallic ores, but its use is confined to blast furnaces, where it heats by direct contact, as the flame is too short for its satisfactory use in reverberatory furnaces. Unfortunately, it is too friable to be used in large blast furnaces, as it is crushed by the weight of material above it. For this reason it is only used to a limited extent, its place having been taken by non-coking coals.

The burning of charcoal in open grates is objectionable, as the carbon monoxide (CO) produced is very poisonous; ample draught facilities must therefore be provided.

Details of the distillation of wood and the substances obtained thereby will be found in **Martin's** "Industrial Chemistry: Organic," p. 323 *et seq.*

Peat Charcoal is of no commercial value as a fuel, though many attempts have been and are being made to produce a good charcoal from it at a remunerative rate. None of these methods can be regarded as successful, inasmuch as the charcoal produced cannot compare in either quality or price with other forms of solid fuel in Great Britain.

Coke is the residue obtained when coal is heated in closed retorts without access of air. The *methods* of its manufacture have been outlined in **Martin's** "Industrial Chemistry: Organic," p. 390, and coke ovens and furnaces in Section V., on p. 51, but it must be remembered that where the coke is regarded as the chief product of the distillation of coal, the conditions will differ from those in which tar and other by-products or coal-gas are the primary object of the distillation. Generally speaking, the better the quality of the coke, the poorer will be that of the gas and by-products and vice versa, and it is technically impossible to obtain first-class coal-gas of a high calorific and illuminating power and a large yield of valuable by-products from a single distillation; one or more of these substances will suffer in quality or quantity according as attempts are made to improve the quality of the others.

The *properties of coke* vary greatly according to the manner of its preparation and the nature of the coal from which it is made. Coke used for furnace work must be sufficiently strong to bear the weight of the ore or metal above it in the furnace without crushing. Good coke for blast furnace work should have a crushing strength of about 1,000 lbs. per square inch, though this is greatly reduced when the coke becomes hot. Its apparent density varies according to the manner of its production, but is usually about 0.9 or a little higher when produced in the more recent types of coke oven; this corresponds to about 50 per cent. of pores in the coke.

Coke contains all the ash of the coal from which it has been derived, less a

small proportion which has been volatilised, and it has therefore a higher proportion of ash than the original coal. Whilst varying greatly in composition, good coke for furnace work should not contain less than 85 per cent. of carbon, and its ash should not exceed 10 per cent.; the lower the proportion of ash the better will be the coke. Selected samples frequently contain as much as 95 per cent. of carbon and only 4 per cent. or even less ash. The reactivity of coke is much affected by the addition of chemicals (see, for example, *Ann. Repts. Soc. Chem. Ind.*, 1933, 18, 35, also Fieschi and Lubovitch, French Specification, No. 736377, 1932).

Gas coke may be improved greatly by washing it in a similar manner to coal (p. 12).

Coke for blacksmiths' forges and for heating in fire-boxes need not be so pure as that used for blast furnace work, as the crushing is not so great and the effect of the coke on the product to be heated is less important. Hence the coke sold as a by-product by gas companies may be used with advantage.

Coke is an excellent fuel where it is required to heat by contact or radiation, but it has so short a flame that it cannot be used for reverberatory furnaces and for some kilns. It is difficult to keep alight, but when once fully burning, it gives off a greater heat than the same weight of coal. It is specially useful for heating air, where the latter is used for warming or drying goods, as it burns free from smoke or soot; it is also used for heating crucibles and other articles requiring a direct heat.

The sulphur in coke is frequently considered an objection to its use, but if the coke is made from suitable coal it will not necessarily contain more sulphur than the original coal. The most satisfactory means of keeping the proportion of sulphur low is to wash the coal before use and to quench the coke by drenching it with water whilst in a red-hot condition. This treatment causes an evolution of some of the sulphur as H_2S . Many other methods have been suggested for removing the sulphur completely, but none have been successful.

Smokeless Fuel (including coalite and other proprietary materials) is made by imperfectly coking coal, so that it ignites more readily than coke but burns with less smoke than coal; its use is extending. It may also be made by blending suitable proportions of small coal and crushed coke (see F. S. Sinnatt, *Fuel Econ. Rev.*, 1933, 12, 4; C. Berthelot, *Chim. et Ind.*, 1933, 29, 18; also *Reports of Fuel Research Board*).

Briquettes are made by compressing a mixture of coal dust and pitch or tar into blocks or bricks. Such briquettes burn similarly to coal, but do not keep alight so readily (see pp. 21-24).

The Weathering of Fuel

(See Parr and Mitchell, *Ind. Eng. Chem.*, 1930, 22, 1211; Bassett, *Railway Eng.*, 1931, 52, 99.)

The value of fuel is usually diminished by exposure to the weather, as some of the more readily oxidised constituents are converted into gaseous products, which escape, or into less combustible ones, which make the fuel difficult to ignite and reduce its calorific power.

Wood, when freshly gathered or cut, is improved by exposure to dry air, as much of the moisture present then dries out, rendering the wood easier to ignite and removing a large amount of the heat-absorbing water. When the wood has become thoroughly air-dry, however, further exposure will usually do harm rather than good, as oxidation of the more readily ignitable constituents then occurs.

Coal is spoiled by too long a storage, even in a dry and warm place, as under such conditions the air between the particles is able to effect sufficient oxidation to bring about such a rise in temperature as may set the whole mass of coal on fire. This is particularly liable to occur in the holds of ships, and in large silos in which coal is stored with a limited supply of air. It is known as the **spontaneous combustion** of coal. Precisely what occurs is not known, but investigations have indicated that the more readily oxidisable hydrocarbons are the most affected, for though the weathered coal loses more hydrogen than carbon, the effect on

the ignition temperature suggests that the greatest action occurs in connection with the lighter hydrocarbons present (see **B. Moore**, *Fuel*, 1931, **10**, 205, 394).

The best means of preventing this oxidation is to allow plenty of ventilation and to keep the coal as cool as possible. It has been found that boring large holes into the coal heap will often prevent serious damage by supplying so much air that the fuel is cooled and kept below its ignition point.

Coal rich in pyrites (FeS_2) is particularly liable to spontaneous ignition if kept in a moist state as the sulphur in the pyrites oxidises readily under such conditions, with a marked evolution of heat. So also are coals which are stored in warm and unventilated places in which the coal is subject to a rocking movement, such as in the hold of a ship. By packing the coal tightly and securing ample ventilation the damage by storage is greatly reduced.

Coal which is stored in the open air and wetted by frequent rains followed by intense sunshine—as in semi-tropical countries—is especially damaged by such exposure. The damage is lessened by covering with a roof, so that the coal may be kept dry and shielded from the direct rays of the sun.

Powdered Coal.—Coal in a finely divided condition has long been used for firing rotary cement kilns and similar furnaces. It may also be used in internal combustion engines (see **L. O. Harvey**, "Pulverised Coal Systems in America," *Fuel Research Board, Special Report*, No. 1, 1919; see also **Coffin**, *Gen. Elect. Rev.*, 1918, **21**, 337; **R. Pawlikowski**, 6th, 8th, 15th, and 16th Report of Kosmas, G.m.b.H., Gorlitz, Sept., 1931). The coal is ground in ball mills or attritors so that 80 per cent. passes through a screen of 200 meshes to the linear inch and 95 per cent. through a 100-mesh screen; 18 to 27 kw. hours per ton are required to grind the coal. The coal is blown into the furnace by a current of air. Full descriptions are given in modern books on cement-making which the reader should consult (see also **Tollemache**, *Journ. Inst. Fuel*, 1932, **6**, 69; **Heywood**, *loc. cit.*, 1932, **6**, 241; **B.**, 1933, 416; *Institution of Mining Engineers*, Memorandum 9, 1933; **O. Haller**, "Glückauf," 1933, **69**, 82; **E. H. Tenney**, *Amer. Soc. Mech. Eng. Fuels Div.*, 10-14, Feb. 1931); *Ann. Repts. Soc. Chem. Ind.*, 1932, **17**, 36; 1933, **18**, 32; 1934, **19**, 38.

Colloidal Fuel is a suspension of a solid fuel in a liquid one, e.g., coal in oil (see **Coal-Oil Fuel**, p. 27).

Hydrogenation of Coal.—Coal is hydrogenated with the object of producing oil therefrom. For economic considerations see **J. Brass**, Presidential Address, Institution of Mining Engineers, 1933; **Sir John Cadman**, *Journ. Inst. Fuel*, 1933, **7**, 8; see also *Fuel*, 1931, **10**, 481; **B.**, 1932, 52. For a general description of the plant see **G. Knox**, *S. Wales Inst. Eng.*, 1932, **48**, 359; **B.**, 1932, 1062. For an excellent summary see *Ann. Repts. Soc. Chem. Industry*, 1932, **17**, 46; 1933, **18**, 92; 1934, **19**, 39.

SECTION II

THE MANUFACTURE OF BRIQUETTES

BY GEOFFREY MARTIN, D.Sc. (Lond.)

Member of the Institute of Fuel

LITERATURE

- G. FRANKE.—“Briquetting.” London, 1912.
 P. B. BJÖRLING.—“Briquettes and Patent Fuel.” London, 1903.
 I. L. BLUM.—*Proc. III. Int. Conf. Bit. Coal*, 1932, 2, 646.
 H. SUSTMANN.—*Brennstoff Chem.*, 1932, 13, 287.
 SWIENTOSLAWSKI, ROGA, and CHORAZYL, *Fuel*, 1930, 9, 421.
 A. SPILKER.—*Brennstoff Chem.*, 1930, 11, 307.
 HOMER.—*Iron and Coal Trade Review*.
 L. VERTU.—*Chem. and Ind.*, 1930, 24, 27.

BRIQUETTES consist, essentially, of coherent masses of uniform size made by the application of pressure to any powdery material placed in a suitable mould, with or without a binder.

Briquetting is extensively employed for the utilisation of dusty ores and of flue dust from blast and other metallurgical furnaces, and for metal turnings and borings. The process is usually cheaper than the nodulising-sintering method referred to under Sulphuric Acid. The vast accumulations and deposits of such residues (*e.g.*, pyrites, dust, cinders) and ores, formerly useless, are now being turned to good account. This article is only concerned with the manufacture of fuel briquettes.

Briquettes possess many advantages over other fuel; of these the following are the most important: (1) They burn better and more evenly, (2) they occupy less space in storing (5-10 per cent.), (3) they usually possess a higher calorific value, (4) the material is of uniform size, with a resulting higher heat efficiency, (5) good briquettes of the proper shape disintegrate less easily than the coal from which they are made. The chief difficulty is the cost of manufacture. The slack from which they are usually made is only some 3s. to 5s. per ton cheaper than the corresponding coal, so that only a small margin is left for working expenses—1s. 6d. to 2s. per ton—and the cost of the binder, 2s. to 4s. per ton. Owing to the heavy demand for coal-tar pitch as a road binder the price has very much increased (from under £1 per ton in January 1909, to over £2 in January 1914); there would therefore appear to be much room in this industry for further experiment and invention. Experiments seem to show that with greater pressure less binder need be employed, and that by suitably modifying the temperature the same result may be obtained. Good briquettes are said to have been recently obtained by the U.S. Bureau of Mines without the use of a binder.

Also Nigerian coals have been successfully briquetted without the use of binders. The process is to heat the material to a sufficient temperature, and while of exactly the right degree of temperature, to apply a heavy pressure. The process requires expert manipulation of the temperature and plant, but for certain kinds of coal it is especially efficient.

Binders.—A great variety of binders have been tried including water-glass, molasses, starch, blast-furnace pitch, wood-tar pitch, sulphite pitch, water-gas pitch, petroleum pitch, asphalt, wax tailings, various kinds of tars, naphthalene, creosote and other oils. Of these only coal-tar pitch has been used to any great extent, by far the bulk—perhaps over 95 per cent.—of that produced being employed in the manufacture of “patent fuel.”

The pitch has to be fairly hard as it will otherwise cake together in the ship's hold, clog up the pitch crackers or melt in the fire and run out of the fuel before intumescence takes place, resulting in the disintegration of the briquette. It should, however, be as low as possible in ash, free carbon, and non-volatile matter

(ash and free carbon + coke) as is consistent with the requisite hardness. A typical coal-tar pitch should give

Ash not exceeding 0.5 per cent.

Softening point, 60°-75° C.

Soluble in aniline or pyridine bases, 70-75 per cent.

Volatile matter, not less than 55 per cent.

Free carbon, about 30 per cent.

Process of Manufacture.—Fig. 1 shows a Yeadons' briquette machine, and Fig. 2 the arrangement of plant. The pitch, broken small in a "pitch cracker"

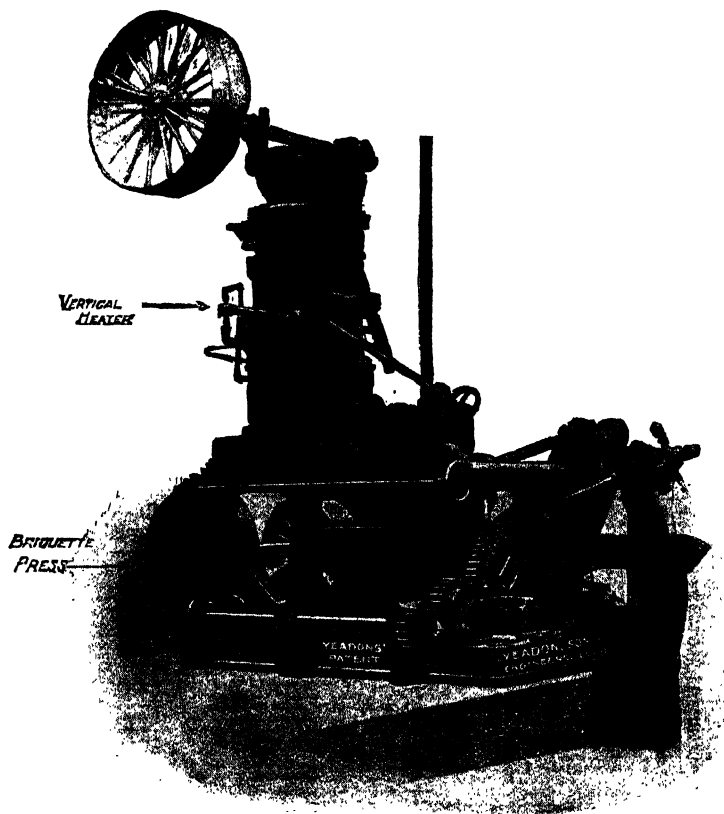


FIG. 1.—Yeadons' Briquette Machine.

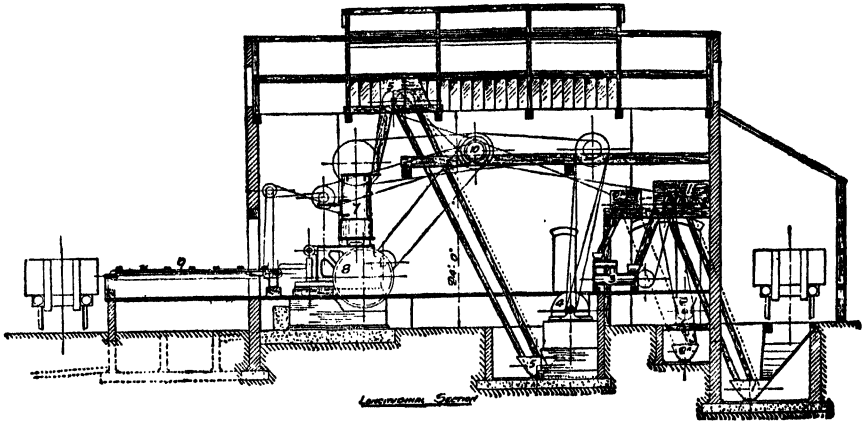
(2, Fig. 2), is fed along with the slack coal into a "mixer" (3, Fig. 2) where the proper proportions of the two materials are accurately measured. The materials then fall into a disintegrator (4, Fig. 2), where they are ground together to the proper fineness.¹

This ground material (coal and pitch) is then elevated and delivered into a "vertical heater" (7, Fig. 2; see also Fig. 1) where, in its downward passage through the same, it is subjected to the action of superheated steam, of a suitable temperature, by means of which the pitch becomes plastic and adhesive. This

¹ 50-60 per cent. should be retained by a $\frac{1}{4}$ -in. mesh; the particles should not be too uniform.

“heater” is fixed just above the briquette press (8), which is fitted with a vertical mould plate with intermittent motion, having often eight moulds in it.

At each stroke of the machine the plastic material is pushed by a horizontal ram into one of the moulds. When the full mould reaches the other side (the mould being in intermittent motion) the material is powerfully compressed from **both sides simultaneously** by two rams working horizontally. A minimum pressure of **2 tons per square inch** on the surface of the briquettes is thus



References.

- | | |
|-----------------------------|----------------------|
| 1. Coal Elevator | 6. Superheater |
| 2. Pitch Cracker | 7. Vertical Heater |
| 2a. Pitch Elevators | 8. Briquette Machine |
| 3. Mixer | 9. Endless Conveyor |
| 4. Disintegrator | 10. Main Shafting |
| 5. Coal and Pitch Elevators | 11. Engine |

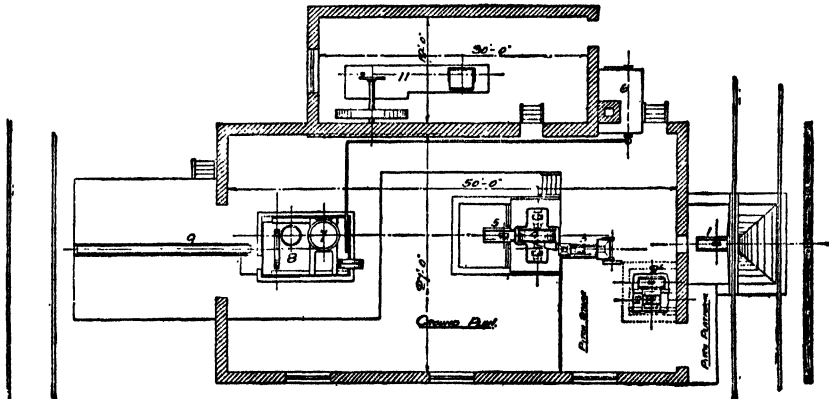


FIG. 2.—Arrangement of Coal Briquette Plant.

(By Yeadon, Son & Co., Engineers, Leeds, London.)

exerted, this great pressure being obtained by an ingenious application of compound levers and a heavy flywheel.

A fourth ram pushes out the finished compressed blocks, which are then conveyed to the stacking ground or loaded into trucks.

When properly made and cold, the briquettes are as dense and hard as the large coal itself.

The latest presses will turn out 320 tons per day of 25 lbs. bevelled-edge briquettes or 10-15 tons per hour of nuts, and only require some 15-20 H.P.

The size and shape of fuel briquettes are of very great importance. Large blocks burn slowly, and if rectangular pack closely together and do not allow of the proper circulation of air; they have usually to be broken. The tendency is, therefore, to produce an "ovoid," "eggette," "bonlet" or "nut" weighing only some 1.4 oz.

Briquetting of Anthracite.—Anthracite dust is now successfully briquetted both in Scotland and in the U.S.A. In the former locality it is mixed with a proportion of bituminous coal. Anthracite dust passing $\frac{3}{32}$ -in. mesh is still practically unsaleable, though it can be successfully briquetted by the Armstrong-Mordan process.

Immense accumulations of anthracite culm and dust, coke dust, etc., still await briquetting, particularly in the U.S.A. There are also numerous deposits of friable coal and lignite, particularly in the U.S.A. (where they extend for 150,000 sq. miles), in Canada, in Kent and elsewhere, which crumbled to dust on exposure to air, but which can now be successfully briquetted.

The industry is chiefly located in Western Europe, Belgium possessing 42 factories, France 35, and England 20. Factories also exist in Germany, Spain, China, Japan, and the U.S.A. In the States a great development must be expected in the near future.

Of the many attempts to produce briquettes without the use of a ready-made pitch only two will be mentioned. Professor Le Matre treats tallow with nitric acid, pours it into soda lye, and mixes with lime and mineral oil. He obtains a product somewhat like pitch, and proposes to employ it for the manufacture of briquettes.

The second process to be mentioned is the **Armstrong-Mordan**. It was originally applied to the problem of the solidification of oil. Much work has been done in this direction, but nearly all the proposed methods have broken down in practice. The method employed, which the writer has investigated, is the emulsification of the oil by mixing it with a certain proportion of sulphate of iron (green copperas) and glue. A solid emulsion results, which heat only breaks down slowly, and which stands sufficient pressure to allow of the briquettes being rough handled and stored to any reasonable height. Crude oil may be used, and the proportion need not exceed 5 per cent. Thus a practicable method has been evolved of employing all kinds of waste and cheap combustible materials, such as anthracite, coke, and coal dust, slack, culm, and druff, friable lignites and coals, paddy husk, Nile sudd, dried sewage, peat, etc., etc. The calorific value of the oil being high, that of the waste fuel is, of course, raised in proportion.

Pitch Cancer : Pitch Ulcers.—The handling of coal-tar pitch frequently causes peculiar and unpleasant sores and local inflammation of the skin known as pitch ulcers, pitch warts, or pitch cancer. They appear to be caused by some basic substance present only in coal-tar pitch (or anthracene oil) and can be practically prevented by distilling up to about 350° C. and softening the pitch down with a suitable oil. The addition of a small quantity of formaldehyde to the tar before distillation is also said to render the resulting pitch innocuous. The Home Office has investigated the whole question and has issued two Reports and a set of Draft Regulations.

Statistics.—

PRODUCTION OF COAL BRIQUETTES

Producing Country.	1930.	1931.	1932.
	Tons.	Tons.	Tons.
Great Britain	1,130,962	869,542	908,467
Belgium	1,845,594	1,821,136	1,299,890
France	6,725,791	4,924,129	5,356,693
Germany—			
Coal briquettes	5,094,870	5,104,651	4,405,405
Brown-coal briquettes . .	33,451,366	31,910,150	29,282,278
Netherlands—			
Coal briquettes	930,999	1,193,469	1,152,437
Brown-coal briquettes . .	48,096	40,246	43,330
Spain	915,052	899,680	640,339
United States	918,629	623,496	392,170

SECTION III

LIQUID FUELS

BY ALFRED B. SEARLE

LITERATURE

- W. N. BEST.—“The Science of Burning Liquid Fuel.” London, 1913.
 J. S. S. BRAME.—“Fuel.” London, 1914.
 E. BUTLER.—“Oil Fuel.” London, 1914.
 V. B. LEWES.—“Liquid and Gaseous Fuels.” London, 1907.
 B. REDWOOD.—“Petroleum.” London, 1913.
 W. SCHEITHAUER.—“Shale Oils.” London, 1913.
 G. LUNGE.—“Coal Tar and Ammonia.” London, 1916.
 W. H. BOOTH.—“Liquid Fuel and its Combustion.” London, 1903.
 ——— “Liquid Fuel and its Apparatus.” London, 1911.
 BOOTH and KERSHAW.—“Smoke Prevention and Fuel Economy.” London, 1911.

The chief liquids used as fuel are:—

Natural or Mineral Oils of the petroleum series, found in many countries, but chiefly obtained for use from Galicia, Russia, and the United States.

Prepared Oils and Spirits, made by treating the natural mineral oils and other materials in such a manner as to produce a suitable combustible fluid. The chief of these prepared liquid fuels are:—

(a) **Distilled Mineral Oils**, including petrol, benzene, petroleum spirit, kerosene, gasolene, and other “light oils.”

Shale Oils, prepared by the destructive distillation of shales, and resembling very closely the distilled mineral oils just mentioned.

(b) **Heavy Oils** obtained in the distillation of various substances, including **Petroleum Residues**, and also **Tar Oils** obtainable as a by-product in the distillation of coal for the manufacture of coal-gas, also from blast furnaces used for smelting metal, when coal is used as a fuel. The product of some coke ovens is also used in a similar manner.

(c) **Alcohol**, including **methylated spirit**, prepared by the fermentation of various vegetable substances, including potatoes, malt, etc.

The **methods of manufacture** and **general properties** of all the foregoing liquid fuels are described in “Industrial Chemistry: Organic,” pp. 4, 11, and 279. For **motors, engines, and small burners** the “light oils and alcohol are preferable, though large Diesel engines run satisfactorily on tar oils.

It should be noted that alcohol gives the cleanest results and burns with the least smoke, but it is somewhat more costly than the light oils. As the price of alcohol tends to diminish and that of the light oils to increase, there is a great probability that in the near future alcohol may be used increasingly as a fuel, on account of its many advantages.

For **furnaces** the heavier mineral oils are largely used in the United States, but in Great Britain they cannot compare with coal burned in an equally intelligent manner and with the most suitable appliances. Indeed, the chief use of heavy oils as fuel depends on the facilities offered for transport from the place of manufacture to that of use, on the uniform temperature readily attainable, and the small amount of attention required. Heavy oils require specially con-

structed burners, and are apt to prove troublesome unless they are well designed.

In the Kermode burner the oil is partially vaporised and sprayed by means of hot air at a pressure of $\frac{1}{2}$ lb. to 4 lbs. per square inch. The oil controlled by the valve E and pinion L, entering at A, is met by hot air passing through B and C. Both air and oil travel on together, the oil being rapidly vaporised in its passage and completely commingling with the air. As the oil passes the nozzle beyond the valve it is swept forward by a sharp current of air which envelops the nozzle; this current can be regulated with great exactitude by pinion M. A further supply of compressed air is given at the point of combustion, and a third supply is caused by the induction of the flame or by the draught.

Both air and oil are under complete control and can be accurately regulated. To substitute oil for coal, no change is required in the arrangement of the furnace; it is only necessary to cover the fire-bars with broken fire-bricks to a depth of from 6-8 in., the greater depth obtaining towards the bridge.

The burners are hinged on the air- and oil-valves, and may be withdrawn from the furnace when desired.

The air-jet system offers great economy in fuel, as 83 per cent. of the calorific value of the oil is recovered in actual work. Less than 2 per cent. of steam is used to drive the air-compressing plant, and if the steam is condensed no fresh water is lost.

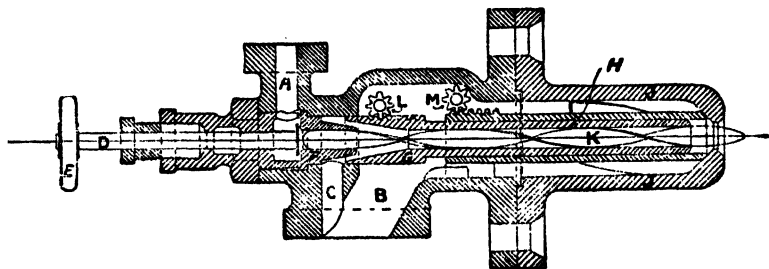


FIG. 1.—Burner for Liquid Fuel.

(By the courtesy of Kermode's Ltd.)

Other Uses.—Liquid fuels are suitable for core drying, iron foundry furnaces, retorts, bakers' ovens, brewing and distilling plants, for malt drying, timber seasoning, cloth-singeing machines, refuse destructors, and for other purposes where dry heat, cleanliness, and definite temperatures are required. They have proved specially suitable for boilers in warships, for glass-melting furnaces, and for fire engines on account of the rapidity of heating, the cleanliness of the fuel, and the ease of using.

The chief liquid fuels for these purposes are light or heavy oils, such as tar, tar oil, creosote, green oil, crude petroleum, pure petroleum, or "residues."

Liquid fuels have several advantages over solid ones, of which the most important are:—

- (a) Lesser weight and volume, thereby effecting a saving in transport and storage.
- (b) Less labour required in use, as the oil can be fed to the burner at a definite rate, whereas solid fuel has to be charged at intervals.
- (c) Less detriment to the articles being heated or to the heating plant, as liquid fuels contain less ash than solid ones, and do not produce a dust.
- (d) Prompt attainment of any desired temperature within the limits of the plant.
- (e) Simple and rapid extinction of the flame so that there is less waste of fuel by the necessity of allowing the (solid) fire to "die out."

On the other hand, liquid fuels are subjected to certain important drawbacks:—

- (f) They must, in most cases, be imported from abroad, so that supplies are not quite as reliable as with a native fuel.

(e) The lighter oils must be stored under special (legal) conditions, on account of their tendency to explode.

(f) They must not be purchased in very large quantities on account of the loss by evaporation, though with some of the heavier oils this is trifling.

(g) The odour of the oil is objectionable in some industries on account of the goods made becoming scented by absorption, even though kept out of direct contact.

(h) Most works are fitted for the use of solid fuels, and the cost of replacing existing plant would, in many instances, create an interest and sinking fund charge which would more than counterbalance any saving effected by the use of a liquid fuel. In extensions of plant, or in the installation of a new plant, this objection does not hold to the same extent.

The cost of liquid fuels appears to be much higher than that of solid ones, but in order that an accurate comparison may be made it is necessary to take all the necessary factors into consideration. It is *not* correct to compare the calorific powers of various fuels and to assume that because more units of heat can be obtained in a calorimeter from a shilling's worth of one fuel than from another that, therefore, the first fuel is the cheaper to the user. The only true basis of comparison for the user must be based on burning the various fuels under the same conditions as would apply in actual use. Failure to recognise this, and the undue insistence of calorimetric tests of the fuel when burned in oxygen, have led to serious misconceptions and to considerable waste of money. For the same reason, theoretical estimations of the evaporative power of various fuels give results of very small actual value, and their reiterated publication in various text-books does more harm than good, because care is seldom taken to point out the wide divergence between them and the results obtainable with actual plant.

Coal-oil Fuel.—Powdered coal intimately mixed with fuel oil (40/60 mixture) has been successfully used in steamships (see J. S. S. Brame on "Colloidal or Coal Fuel Oil," *Chem. and Ind.*, 1932, 855, 879; B., 1932, 1014; 1933, 902; see also British Patent, 369,432; also Tollemache, *Proc. S. Wales Inst. Eng.*, 1933, 49, 163; A. B. Manning, *Iron and Coal Trade Review*, 1933, 127, 133.) Lessing summarised the general position in *Proc. World Petroleum Congress*, 1933, 2, 809.

The stabilising agents used are important; they include sodium stearate, calcium resin soap, starch, gelatin, melted rubber, etc.

Statistics.—In 1932 the following amounts of fuel oil were exported:—

	Tons.
U.S.S.R. (Russia)	1,894,486
Mexico	954,819
U.S.A.	7,837,740
Venezuela	622,645
Netherlands East Indies	1,238,000
Persia	2,789,692

SECTION IV

FURNACES

BY ALFRED B. SEARLE

LITERATURE

- OSCAR NAGEL.—“Gas-Fired Furnaces.” New York, 1909.
 HAASE.—“Die Feuerungsanlagen.” Leipzig, 1893.
 BYROM and CHRISTOPHER.—“Modern Coking Practice.” London, 1910.
 J. B. C. KERSHAW.—“Boilers and Boiler Control.” London, 1911.
 W. INCHLEY.—“Steam Boilers and Accessories.” London, 1912.
 R. D. MUNRO.—“Steam Boilers.” London, 1910.
 T. W. TRAILL.—“Boilers, Marine and Land.” London, 1908.
 W. D. WANSBROUGH.—“The Lancashire Boiler.” London, 1914.
 J. J. MORGAN.—“Blast Furnace Practice.” London, 1913.
 A. PUETSCH.—“Gas and Coal Dust Firing.” London, 1910.
 J. BRONN.—“Der Elektrische Ofen.” Halle, 1913.
 RODENHAUSER and SCHOENAWA.—“Electric Furnaces in the Iron and Steel Industry
 London, 1914.
 H. SCHNURPFEL.—“Glassmelzöfen und Feuerungsanlagen.” Leipzig, 1915.
 A. B. SEARLE.—“Kilns and Kiln Building.” London, 1916.
 —“Refractory Materials.” London, 1916.
 RAMDOHR.—“Die Gasfeuerung.” Leipzig, 1881.
 E. SCHMATOLLA.—“Gaserzeuger und Gaststeuerungen.” Hanover, 1908.
 —“Rauchplage und deren Verhütung.” Hanover, 1902.
 A. LEDEBUR.—“Die Gasfeuerungen für Metallurgische Zwecke.” Leipzig, 1891.
 C. HÄUSSERMANN.—“Industrielle Feuerungsanlagen.” Stuttgart, 1897.
 G. A. SCHULTZE.—“Theorie und Praxis der Feuerungskontrolle.” Berlin, 1905.
 GEOFFREY MARTIN.—“The Cement Rotary Kiln.” London, 1932.
 DAVY and SPARKS.—*Journ. Inst. Fuel*, 1933, 7, 13.
 BURGE.—*Journ. Inst. Elect. Eng.*, 1933, 73, 369.

The *Annual Reports of the Society of Chemical Industry*, 1932, et seq., contain valuable information on furnaces.

Utilisation of Fuel.—Different fuels are suitable for different purposes, and it is necessary to use every kind of fuel in a suitable manner. By far the most extensive use of fuel is in furnaces for heating purposes, as described later in this section, but an increasingly important use of gases and liquid fuels is in the direct production of power. In a gas or oil engine the combustion of the fuel is arranged to take place in the form of an explosion, the force of which moves a piston and so converts the energy of the fuel into mechanical work. According to the first law of thermodynamics, heat produces mechanical energy in the proportion of 772 ft.-lbs. for each unit of heat. Hence 1 lb. carbon, if burned under ideal conditions producing a calorific power of 14,500 B.T.U., should produce over 11 million ft.-lbs. of mechanical energy. As 1 H.P. = the expenditure of energy at the rate of 33,000 ft.-lbs. per minute, 1 lb. of carbon should produce 5.6 H.P. hours. The necessity of keeping the walls of the engine cylinder cool and other causes prevent more than a small proportion of this heat being available for driving an engine, so that under normal conditions a gas engine will require the equivalent of 1 lb. of solid fuel per horse-power hour, which is only one-sixth of the power theoretically producible from the fuel itself. Nevertheless, gas engines are much more economical in fuel than are steam engines, particularly for powers under 200 H.P. Weight for weight, oil fuel is slightly more economical than coal, only $\frac{3}{4}$ lb. being required for each horse power developed, but the cost of oil being greater than coal counterbalances this advantage where the coal can be gasified,

or where cheap town's gas is available. In other cases, and particularly in country districts and for marine purposes, the use of oil engines is perfectly satisfactory and economical.

A furnace is a heating device in which fuel is used; it is composed of four essential parts:—

(a) The **fireplace**, comprising the portion where the fuel is heated until it reaches a temperature at which it can burn (Fig. 1; see below).

(b) The **combustion chamber** or place in which the gases obtained from the fuel unite with air and burn, producing a high temperature. The combustion chamber is usually close to, and may form part of, the fireplace.

(c) The **furnace proper** or **hearth** in which are the goods or materials to be heated. It is quite distinct in its functions from the foregoing, and in most cases the combustion of the fuel should be complete before it reaches the furnace proper. In smelting ores, where the reducing action of the incompletely burned fuel is necessary, the flames are allowed to enter this portion of the structure at an early stage of burning, but this is different from the case of simple heating.

(d) The **draught producer**, consisting of a chimney or fan which is connected to the foregoing by a series of flues. The shape of some furnaces is such that no separate draught-producing device is necessary, as the furnace forms its own chimney. The chimney creates a draught by virtue of the lower specific gravity of the hot gases contained in it, as compared with that of the atmosphere. If the

temperature inside the chimney falls much below 300°C ., a poor draught will be obtained. The exit of gases at this temperature represents a waste which cannot be avoided, unless it is profitable to replace the chimney by a mechanically-driven fan, and to use the hot gases for drying or heating other goods.

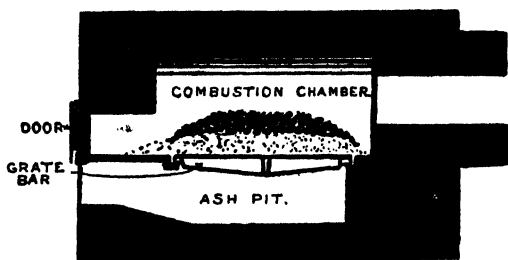


FIG. 1.—Diagram of Fireplace.

ordinary reverberatory furnace, Fig. 15 a retort furnace, Fig. 12 a blast furnace. The more complex gas-fired furnaces, with regenerators (*i.e.* arrangements for heating the entering air), and separate inlets for primary and secondary air are indicated in Fig. 15, and in Section V, Figs. 4, 5, 6.

In order properly to understand the nature of combustion, and the best means of effecting it economically, it is necessary to consider each of the foregoing parts of a furnace quite separately, as much confusion has arisen from want of paying sufficient attention to their separate purposes.

Of whatever nature the fuel may be, the furnace or fireplace must be constructed in such a manner that the combustion shall be as complete as possible, as otherwise there will be a serious loss of heat, and a great wastage of fuel. Differences in the design of a furnace are necessary according as the fuel is a solid, liquid, or gas.

In many of the existing furnaces and fireplaces this elementary requirement has been overlooked, or the designer has not known how to provide for it, with the result that many furnaces work in a manner which is far from economical. The amount of fuel wasted in the form of smoke is evidence of this, although in certain metallurgical operations the production of smoke is necessary as a means of reducing or preventing the oxidation of the metal.

In the heating of any substance with a solid fuel it is usually necessary to burn the fuel in one part of the apparatus, whilst the material or articles to be heated are contained in another. The only exceptions to this are where the heat required is very great, and the goods will not be damaged by contact with the fuel. Thus lime is burned and iron ore is reduced by filling the kiln with alternate layers of the

material and coal; in primitive countries pots are baked by placing them in the middle of the fire, and so on, yet in the majority of cases the fuel is burned in a separate fireplace or furnace, so arranged that only the hot gases have access to the material to be heated.

FURNACES FOR SOLID FUELS

Solid fuels are in two forms: (a) Fragments, such as coal and coke; (b) dust obtained by grinding the larger pieces to powder.

Most fireplaces consist primarily of a grate on which the fuel rests, a combustion chamber or space in which the burning occurs, and an ashpit or space into which the ashes and uncombustible matter fall.

The process of combustion is such that air enters between the grate bars and comes into contact with the hot fuel; the air and fuel combine together, and combustion occurs. If the fuel is elementary and consists of almost pure carbon (coke being a sufficiently good example), the gas

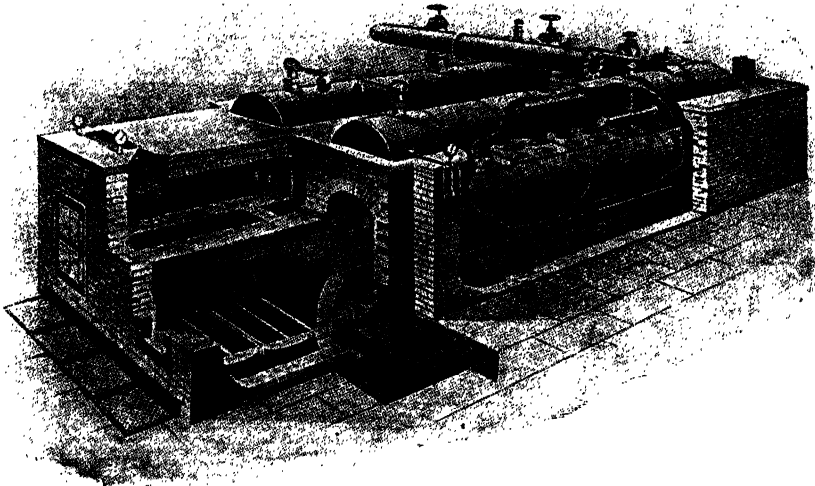


FIG. 2.—Galloway Boiler with External Furnace.
(Galloways Ltd., Manchester.)

produced will burn with a blue flame, but without smoke. If the supply of air is so regulated that no excess is present above that needed to burn the fuel, the combustion of such a material will approach perfection, and it is for this reason that coke and anthracite are such valuable fuels.

If, on the contrary, the fuel used contains other ingredients, or if it is a mixture of highly complex compounds (as is coal), the combustion will occur in quite a different manner. The lower portion of the fuel will burn completely and without smoke, when the fire has been properly managed, and in time a clear, smokeless coke-like fire will be produced. The moment some fresh coal is thrown on, however, the conditions are changed; the fresh coal begins to decompose, throwing off a dark-coloured smoke, which becomes increasingly dark as the temperature of the coal rises, and the distillation and decomposition proceed with greater rapidity. A considerable amount of tarry matter and soot are produced, and in the course of time the gases liberated take fire and burn with a brightly luminous but sooty flame. As the flames rise they carry with them particles of tar and soot, and may take these away through the chimney in the form of smoke, or a portion may be deposited inside the chimney or among the goods to be heated. As soon as this volatile matter has disappeared, the fire burns clearer, the smoke eventually ceases, and the approximately perfect combustion of the residual coke occurs. The problem of the furnace-builder, therefore, consists in deciding how far the production of such smoke is necessary, and how far it is a preventable waste of fuel, and in building his furnace accordingly. See also pp. 47, 48 for further remarks on smoke production and prevention.

Primary Air Supply.—If the fuel is elementary, like coke, all that is

needed is the provision of a sufficient quantity of air through the grate bars to provide for the proper combustion of the fuel, but without supplying an undue excess of air. If, on the contrary, the fuel is coal, the furnace must be designed to provide for the combustion of the volatile matter quite separately from that of the coke which will be produced when the volatile matter has been driven off.

To do this is a difficult and at times almost impossible task. The volatile matter is so voluminous, it requires such enormous volumes of hot air for its combustion, and it is produced so rapidly that unless special methods are employed for dealing with it, most of the heat in it will be lost. This is one reason why fuels never approach the calorific power shown when they are burned in the state of fine powder in compressed oxygen (p. 8).

Where the fuel is small or seriously contaminated with mineral matter, it may be made to burn better by closing the front of the ash-pit and blowing air under pressure into the latter. The simplest method of introducing the air is by means of an injector or blower operated by steam. The current of steam and air keeps the bars cool and prevents the formation of clinker, and it enables

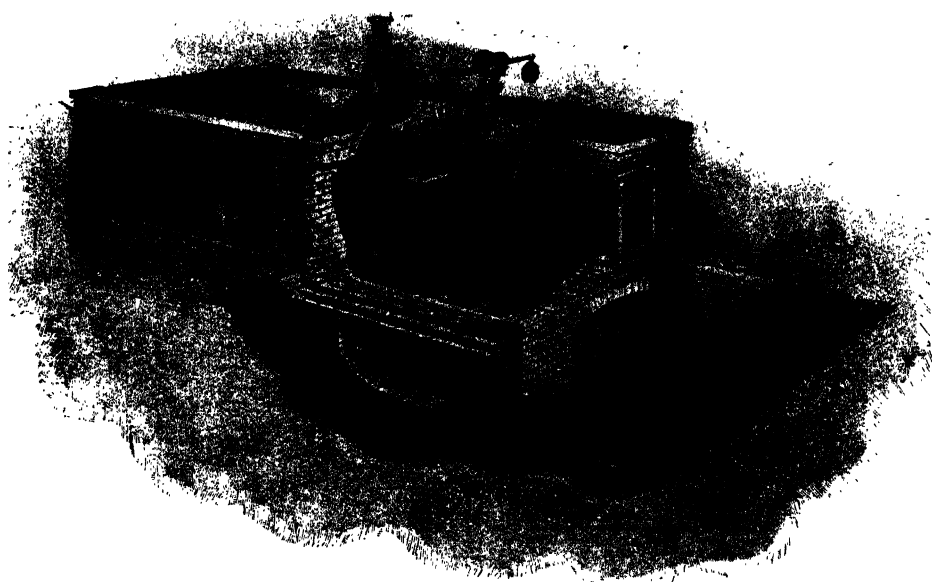


FIG. 3.—Multitubular Boiler.
(Galloways Ltd., Manchester.)

sawdust, spent tar, colliery refuse, and other low grade fuels to be burnt. Care must be taken not to confuse this primary air—all of which is introduced through the fire-bars—with the secondary air which is introduced into the upper part of the furnace.

Introduction of Hot Air (Secondary Air).—A little consideration will show that the most suitable means of burning the volatile portion of the coal consists in the supply of a sufficient quantity of hot air during the whole of the time that the volatile matter is being produced. Moreover, this hot air must be introduced at the front of the furnace, so that it may meet the volatile matter at the moment of its production, and may travel along with it, burning it more and more completely as the two travel together. The admission of cold air, by opening the furnace doors as is usually done, is of very small value; rather does it chill the volatile matter, and cause the production of more smoke, whilst at the same time introducing a supply of cold air into the furnace at a point where it can do the most harm and the least good. If the fire is well distributed over the grate, it will be almost impossible to pass sufficient hot air through the bars, though by keeping

the fire very thin and porous, much may be done by a skilled fireman who does not mind the trouble. This method is, however, inadvisable for two reasons: it places too much responsibility on the fireman, and tends to waste fuel by admitting too much air.

There are numerous patents for the introduction of air at the **back** of the fire—in a boiler furnace the use of a hollow bridge is common—but whilst this effects some relief, it is obviously

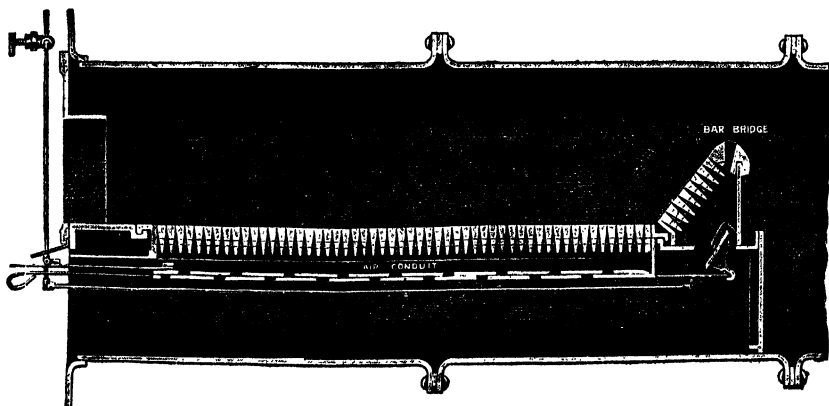


FIG. 4.—Gal'oway-Hill Smoke-Preventing Furnace (Longitudinal Section).
(Galloways Ltd., Manchester.)

not the best place for the introduction of this hot air. A typical arrangement of this kind is shown in Figs. 4 and 5, representing the furnace in a Galloway-Hill boiler. The air passes along the conduits immediately below the grate bars, a further supply being admitted through the hollow bridge. The use of the very numerous patented split bridges and similar devices must, therefore, be regarded as merely palliative and not complete remedies.

The most suitable place in which to heat the air used for the combustion of the volatile matter and soot is to pass it along the sides of the fireplace, from the rear

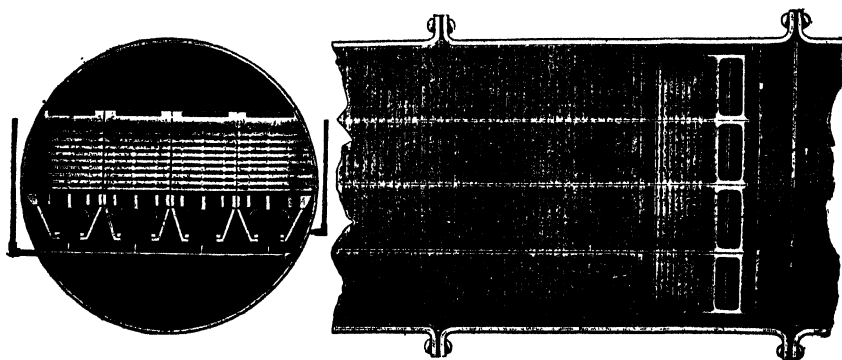


FIG. 5.—Transverse Section and Plan of Fig. 4.
(Galloways Ltd., Manchester.)

towards the front—even carrying it through small flues placed in the larger ones, if this appears to be the best way of making it sufficiently hot—and eventually discharging it through numerous small holes in the front of the fire, so that it may travel over the whole length of the fuel in the grate. By breaking this stream of secondary air into a large number of small streams, and giving it ample time to mix with the volatile matter of the coal, the best possible conditions are provided for the complete combustion of the latter, and the prevention of smoke.

That this arrangement has not been more widely adopted is chiefly due to the lack of attention to what actually occurs when fuel is burned, and to a desire on the part of many inventors not to interfere with the general arrangement of the furnace.

To give an example, if the reader will refer to Fig. 2, showing the furnace employed for heating an ordinary Galloway boiler, it will be noticed that the secondary air needed for burning the **smoke** (the primary air comes up through the grate) must be introduced cold through the door in front of the furnace, in order that it may mix with the volatile matter at the moment of its production, and so travel with it and burn it. No attempt, therefore, is made to preheat the "secondary" air, except for a brief passage of a few inches over the burning coal in the front part of the grate. If, however, this entering "secondary" air were not thus directly introduced cold from the front, but instead was first introduced at the opposite end of the furnace, and made to pass down flues in the brickwork surrounding the boiler (where it would become very hot), and then discharged **intensely hot** through a series of flues placed just in front of the furnace, so as to introduce it to the smoke and volatile matter just as these were being formed (and not—as in the use of a split bridge—when they have had time to condense into a solid soot), the hot secondary air would instantly burn the volatile matter and so check the production of smoke and the waste of fuel this represents.

The preliminary heating of the entering air is always used in large modern gas-fired furnaces, the heating arrangements (known as "Regenerators," "Recuperators," or "Heat-Restorers") being described in detail on p. 43, under the heading "Regenerator Principle." Unfortunately, in ordinary steam boilers no attempt is usually made to preheat the air sufficiently to secure the proper combustion of the fuel.

Many boiler furnaces are provided with an opening in the doors, and behind this, at a distance of about 2 in., is a perforated plate which is supposed to admit fresh air, to divide it into numerous streams and to heat it before it reaches the volatile matter of the fuel. Such an arrangement cannot be satisfactory, for the simple reason that it cannot provide one-tenth of the amount of hot air necessary, with the result that the fireman opens the furnace door and admits cold air in a single stream instead of innumerable small streams of intensely hot air.

No fuel can begin to burn until it is raised to its **ignition temperature** (see p. 44), which (for coal) lies between 330° and 750° C., according to the nature of the constituents, the more solid portions igniting more readily than the gases. In order to secure smokeless combustion, it is necessary to provide the secondary air at a temperature not far short of that at which iron becomes red hot (700° C.).

The amount of secondary air depends upon the volatile matter in the fuel. It will be not less than twelve times the total weight of volatile matter present, and in a coal containing 30 per cent. of volatile matter no less than 50 cub. ft. (measured cold) for each 1 lb. of coal burned. Hence if a ton of coal is burned in ten hours, no less than 11,200 cub. ft. of air must be admitted per hour above the grate, and quite apart from that admitted below it. As the volatile matter is not driven off steadily, but in great rushes each time fresh coal is put on the fire, the actual supply of hot secondary air must be delivered at a greater rate than that just mentioned, but there will be corresponding intervals when no hot air is needed. It is usually possible to utilise a dash-pot arrangement, so that each time the furnace door is opened a definite quantity of hot secondary air will be admitted to the furnace at a suitable rate, the supply being stopped as soon as the volatile matter has been removed. If the damper in the main flue is simultaneously lowered during the time that the door is opened, the loss of heat and the waste of fuel will be considerably reduced.

The **grates** used in furnaces vary according to the nature of the fuel employed, a clinkering fuel containing much ash being more easily burned on a sloping grate than on an ordinary flat one. Poor fuels are also burned on sloping grates in order that a larger amount of surface may be exposed at a time. There is an enormous number of different patterns of grates, but they may be included in the following groups:—

Plain flat grates arranged horizontally, for ordinary furnace coal.

Plain sloping grates, for small or poor coal.

Grates with ribbed bars, either level or sloping, for small fuel, supposed to admit more air through the grate to the fuel.

Grates with hollow bars, to permit air being warmed by passing through the bars before reaching the fuel.

Stepped grates, so arranged that the fuel falls from one step to another; specially useful for very poor fuels.

Grates with rocking bars, for fuels which form much clinker.

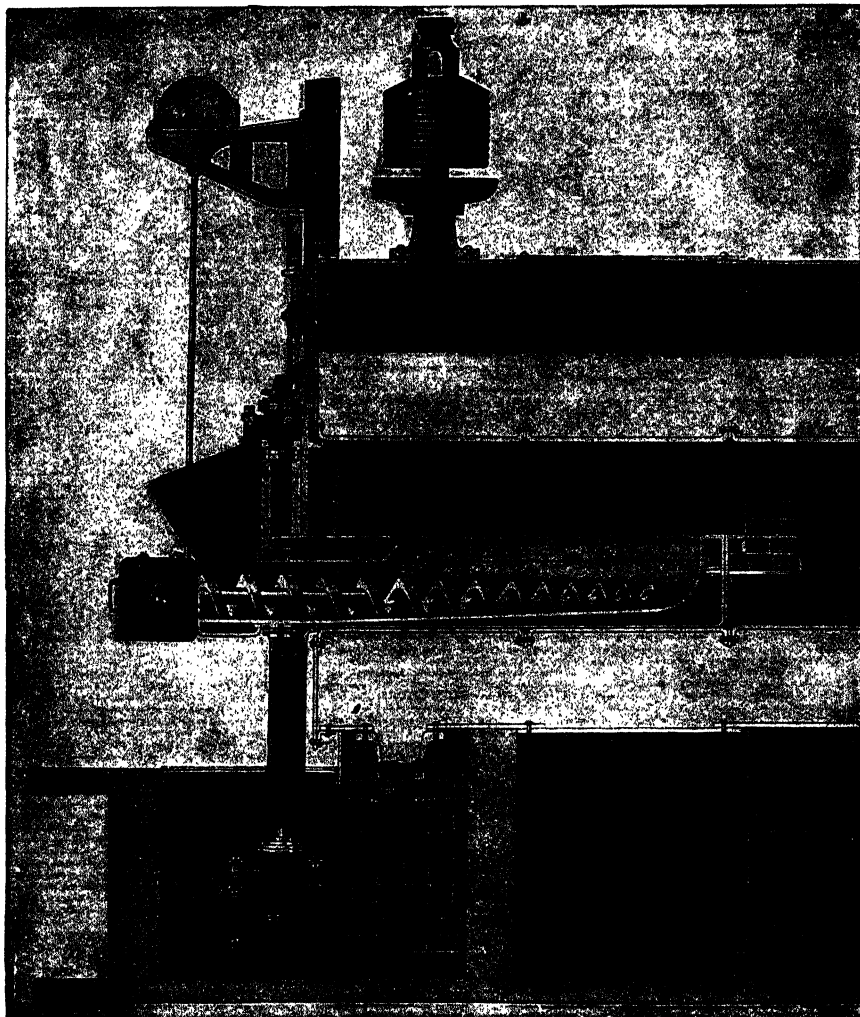


FIG. 6.—Longitudinal Section of the Gear-Driven Underfeed Stoker in Flue of a Lancashire Boiler.

Travelling grates, which carry the fuel forward and discharge the ash at the further end of the furnace; for small coal (slack).

Grates with automatic stoking devices, specially suitable for poor fuel burned in large quantities.

Automatic Stokers are mechanical devices for providing a uniform and steady supply of fuel to the furnace. They are of many patterns, some being much better than others. They depend for their success on the fact that if the fresh

fuel can be added in sufficiently small quantities at a time no smoke will be produced, as sufficient hot air can be admitted in a constant stream to secure the adequate combustion of the more volatile portions of the fuel. In hand-fired boilers it is the fact that a considerable quantity of fuel is added at a time that causes the bulk of the smoke. Automatic stokers are provided with means for delivering the fuel from a hopper into the furnace; rams, screw conveyers, or grates in the form of an endless band being used for this purpose.

Simplicity of working parts, non-liability to be affected by the heat, and the delivery of a small but constant supply of fuel are the chief requisites in an automatic stoker. In the *underfeed* system the fresh fuel is supplied below the fuel on the grate, so that the volatile matter has to pass through a layer of glowing fuel; this retains the sooty particles, and raises the temperature of the gaseous matter to its ignition point, thus giving a smokeless combustion.

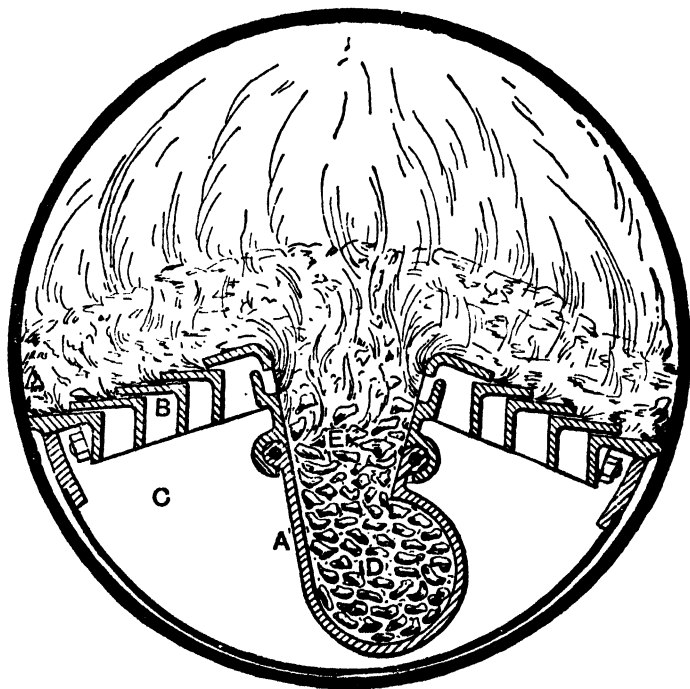


Fig. 7.—Cross Section of Underfeed Stoker in Flue of Lancashire Boiler.

Fig. 6 shows the longitudinal section of the Underfeed stoker as fitted in the flue of a Lancashire boiler, and Fig. 7 a cross section of the same. By means of a screw conveyer, fuel is fed in continuously to an inclined or terraced grate. The action is made clear by Fig. 7, which shows a cross section of the stoker in the flues of a Lancashire boiler.

A is the retort or fuel magazine, in the lower or circular part of which revolves a taper feeding worm which conveys the coal. B shows the terraced grates, C the wind box, and D the green coal, which, being gradually pushed up to the burning point, commences to ignite at the point E, where it meets the incoming air from the tuyeres.

At E the coal is coked, *i.e.*, deprived of its volatile hydrocarbon gases. These being mixed with air introduced at this point through the air inlets of the fuel magazine, and escape being possible only by rising through the glowing coke above, they are heated to such a high temperature that they are completely consumed without smoke, while the combustion of the fixed carbon of the coal is completed by the air introduced through the apertures in the sides of the terraced grates B.

The effect of this method of underfeeding is to keep a perpetually clear, bright surface of incandescent fuel, which always produces its maximum steaming effect upon the boiler without the inevitable fluctuations of furnace temperature consequent upon hand-firing.

Thus, smoke is practically impossible with the most highly bituminous coals, and as the combustion of the gases is all but complete by the time they have passed through the ever-present superincumbent layer of glowing coke, a clear, short flaming fire results, so that the final and

perfect burning of the gases is not prejudiced by their inevitable contact with the comparatively cold heat-absorbing tubes or plates of the boiler.

In the "Koker Stoker," another well-known automatic stoker (manufactured by Meldrums Ltd., Manchester), the fuel is fed in small quantities to the furnaces through a hopper by means of a ram (see Fig. 8).

In the "Bennis" patent machine stoker (Fig. 9), made by Ed. Bennis & Co. Ltd., Bolton, the fuel falls from a hopper on to the bottom of a feeding box and is pushed intermittently by a pusher plate on to another plate, from which it is thrown into the fire at suitable intervals by means of an angular shovel, actuated by a coiled spring and air cylinder. The shovel scatters the fuel on to the fire in four divisions, each about 18 in. long, so that in a 6-ft. furnace the fuel is only thrown on a quarter of the fire at a time. The grate consists of tubes covered with interlocking bars to protect them from direct contact with the fuel. The grate moves forward about 2 in., and is then drawn back by means of cams on a transverse shaft. This action carries the fuel forward until the clinker and ash drop over the end of the grate into a closed chamber, from which they are emptied once or twice daily. Air is forced through the grate by means of fine jets of superheated steam, so that the draught is uniform over the whole grate area. The rate at which the fuel and air are supplied can be regulated with great accuracy in a simple manner, thus securing the satisfactory combustion of almost any kind of solid fuel.

The Babcock & Wilcox Chain Grate Mechanical Stoker (Fig. 13) is of the coking type, its working being based on burning the coal in such small quantities that the combustion of the gas from each charge is completed by passing it over the incandescent fuel. The grate consists of an endless chain of short, interlocking cast-iron bars, linked together and driven by a revolving drum at the front of the stoker, any required variation in speed being effected by a patent gear box. Any small repair, such as replacing a link, can be carried out with the stoker in place, but in case of need the whole stoker can be brought out clear of the boiler. The rate of combustion can be regulated to suit the class of fuel and varying demands for steam by altering the depth of the fire (by means of a vertically moving fire door), and by increasing or diminishing the speed of the grate. The makers claim that this is the only form of stoker in which the undue admission of air at the back is prevented.

From what has been previously stated, it will be understood that for good combustion and economical heating it is essential that the following conditions shall be observed with solid fuel:—

- (1) The fireplace must be so constructed that the fuel is heated to its ignition point and is supplied with sufficient air.
- (2) The combustion chamber must be of such a size, and at such a temperature, that when the gaseous fuel and air enter it they can at once combine in the most desirable proportions. No matter what temperature may be needed in the goods or materials to be heated, the combustion chamber must be at a sufficiently high temperature to ensure the complete combustion of all the constituents and distillation products of the fuel.
- (3) The furnace proper must be constructed in such a manner that the hot gases arriving from the combustion chamber may be used as efficiently as possible. For this purpose they must be distributed uniformly in this portion of the structure, and must be retained in it (either by its shape or by the use of baffles) until they have lost so much heat as to cease to be useful.

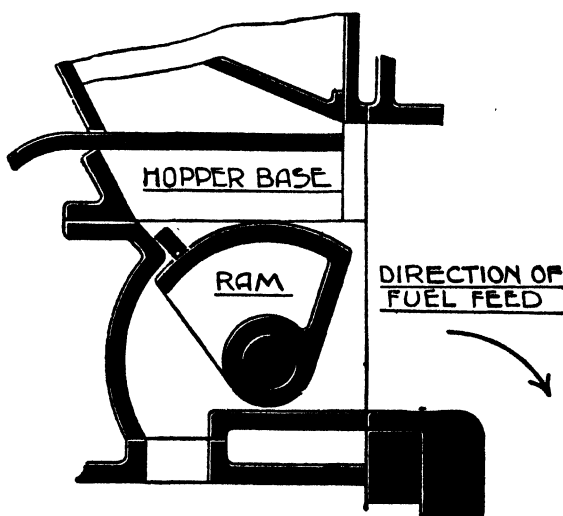


FIG. 8.—Diagram of Meldrum's Koker Stoker.
(Meldrums Ltd., Temperley, Manchester.)

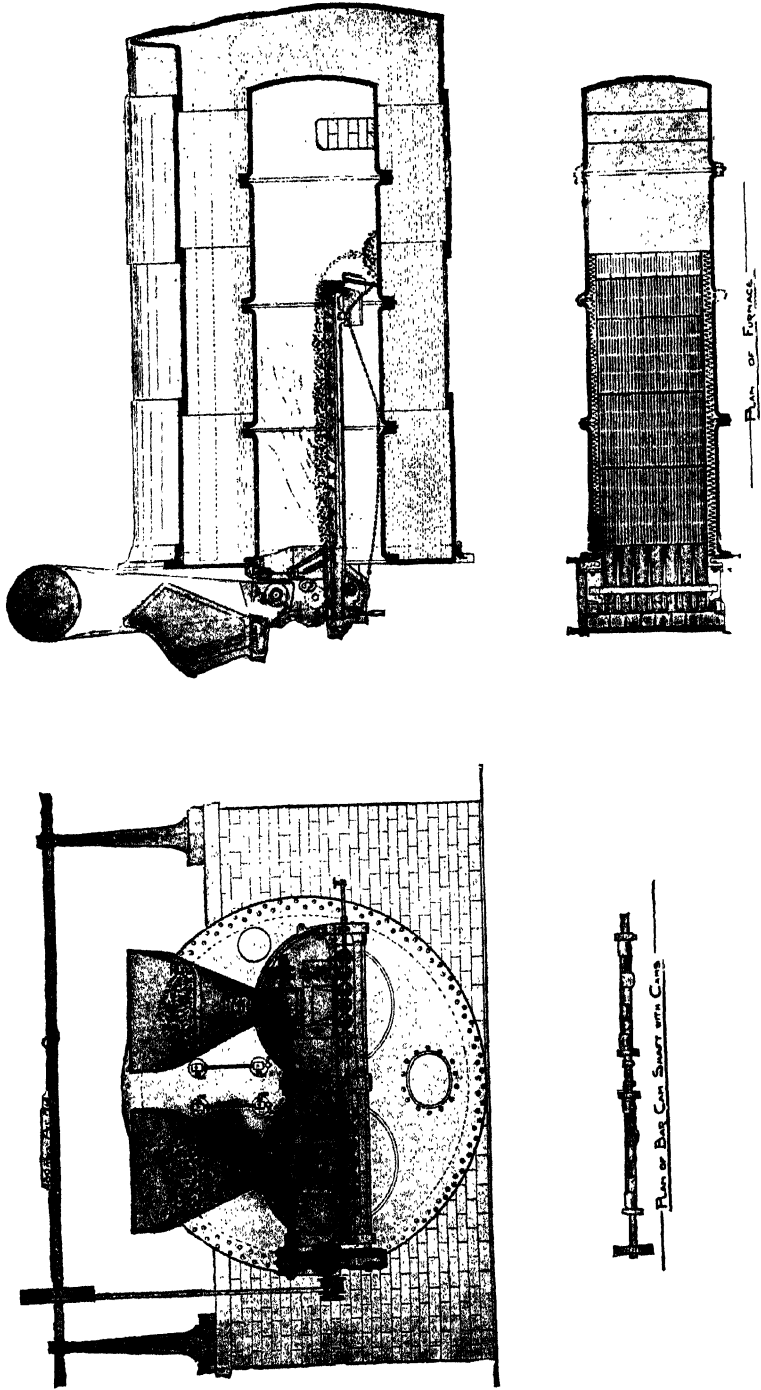


FIG. 9.—Application of Bennis Machine Stoker and Compressed Air Furnace to Lancashire Boiler.

- (4) The draught producer (fan or chimney and connecting flues) must be of ample power, and under such control as to secure the correct mixing of the gases and air and their right distribution in the combustion chamber and in the furnace proper.

These principles are often applied carelessly, as will be seen in the following instances :—

In **domestic fireplaces** no proper combustion chamber or furnace is provided, so that the combustion takes place under conditions which are extremely wasteful in fuel, and highly productive of soot. The greater part of the heat used in heating the room is that radiated from the glowing fuel, the burning gases contributing very little to the heat usefully employed. A much better use of the fuel for the same purpose would be effected by burning it in a closed stove either of the pattern used in this country for small halls, or that used on the Continent for domestic warming, but the British idea of comfort requires the bright appearance of the open fireplace in spite of its admitted drawbacks and expense. By tilting the back forward, so as to leave a narrow throat or exit to the chimney, the rate of combustion is lowered, the volatile matter escapes less rapidly and is more thoroughly consumed, whilst the effective radiation of heat is not seriously affected. In these **slow combustion** fireplaces a saving of about 20 per cent. of the fuel is effected, but even with them at least half the fuel is burned without its heat being used to warm the room.

In **pan-boilers** the vessel containing the liquid to be heated is fixed above a grate on which the fuel is burned, a small chimney being provided to carry off the gases at the level of the mouth of the pan. This arrangement is more economical than the domestic fire, but is far from satisfactory so far as its efficiency is concerned. The fire ought to be placed at one side of the pan, and the latter ought to be fixed so that it is heated by gases which have undergone complete combustion. This would increase the cost of construction very greatly, and such an arrangement is, for that reason only, employed when the boiler is to be in constant use, and the waste of fuel is considerable. For domestic "coppers" the older arrangement is used. These may be made more efficient by burning as large a proportion as possible of coke or cinders with the coal, so that the pan is heated by radiation rather than by hot gases.

In **steam boilers** (see Fig. 3), used for the production of steam for engines and other purposes, a horizontal cylinder is placed above a grate on which the fuel is burned, the heat from the fire acting partly on that portion of the boiler immediately above it, and partly being carried by the gases through a series of flues (termed the boiler "setting") before reaching the chimney. In such an arrangement the fireplace is under the boiler, which results in the combustion chamber being too short and, therefore, unduly cooled by the metal of the boiler. Consequently the fuel is incompletely burned, and soot is deposited on the metal of the boiler, thereby reducing its effective heating surface. The flues comprising the "setting" form the "furnace proper" in this case, and in them the most effective part of the heating is carried out. This is the reason for making these flues of a zigzag design; it increases the surface of the metal which is heated by the gases passing through the flues.

Water-tube boilers resemble retort furnaces, and the same conditions apply to them, the water tubes taking the places of the metal retorts.

A common defect in the furnaces used for boilers (see Figs. 2 and 3 for ordinary boiler furnaces) is the omission of a heat-resisting cover for the part of the furnace immediately above the grate, and for a short distance beyond it at the back of the fire. The absence of such a cover is one of the commonest sources of loss of heat and the production of smoke. The necessity of maintaining the fuel at a sufficiently high temperature until it is completely burned has already been mentioned; if it cools below its ignition point it cannot burn properly, and must therefore escape unburned or it will produce soot and smoke. Anything which cools the upper part of the furnace unduly will, therefore, produce imperfect combustion. Of all the cooling agents, that consisting of a metal vessel containing water is the most effective, and yet in most boilers it is customary to find that the front of the furnace immediately over the grate is covered by part of the boiler—thereby providing the best possible means for wasting fuel and making smoke. In existing boilers, it is not easy to avoid this serious difficulty, as there is scarcely sufficient head-room, but where there is sufficient space the provision of a fire-brick arch immediately under the boiler, so as to keep the fire-gases from coming into contact with it until they have passed the bridge, will prove a great aid to complete combustion, and will not, if the boiler is properly mounted, reduce the effective heating surface. A good plan in some instances is to pull the fire-grates forward for several feet, and to build a fire-brick arch and fireplace in front of the boiler so as to secure a combustion chamber of adequate size and temperature (see Fig. 2). Fire-bricks being poor conductors of heat do not cool the flames like metal, and so enable the combustion to proceed to a conclusion. In a water-tube boiler (see Fig. 3) a fire-clay slab or slabs should be fixed over the grate and below the lowest tubes, for the same reason. The erroneous construction of the top of the furnace is largely due to a desire to keep boilers as short as possible, and to a failure to realise what occurs in the combustion chamber; too many designers of boilers fail to realise that the heating of the boiler should not take place in the combustion chamber, but in the "furnace proper," which, in the case of a boiler, is the flue system immediately behind the fire.

In **reverberatory furnaces** (Fig. 10) the most obvious feature is the hearth or furnace proper. The fireplace is built at one end of the structure, and the air supply is so arranged that the fuel

burns with a long flame which extends over a large part of the hearth. The combustion chamber thus occupies a portion of the fireplace, but combustion occurs chiefly in the hearth, which is made long for this purpose. If such furnaces are to be used for roasting ores, the conditions must be oxidising and there is no need to produce any smoke, but if the reduction of ores is to be effected, a smoky flame is required, and the production of soot and smoke cannot be avoided. In itself, a reverberatory furnace is excellent for the combustion of the fuel, but the top of the furnace becomes

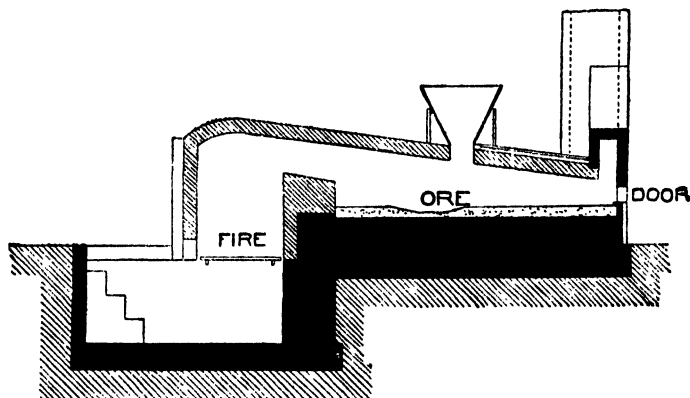


FIG. 10.—Reverberatory Furnace (after Middleton).

intensely hot, and the heat there is not utilised, so that these furnaces are not really economical, unless heated by gas, when the hot top may be utilised for heating the secondary air.

Crucible furnaces are heated by direct radiation of heat from the fuel, so that a non-flaming fuel such as coke is used. The combustion takes place between the pieces of fuel surrounding the crucibles to be heated, and no special combustion chamber or hearth is required. A number of **brass furnaces, cupolas, etc.**, are based on this principle, and the production of smoke is avoided by the use of coke. This is made possible by the fact that the articles to be heated can be placed in direct contact with the glowing fuel, which is not the case with boilers, etc.

In **blast furnaces and gas producers** (see Fig. 12 and Section XIII.) the structure is in the form of a wide chimney, somewhat enlarged about one-third its height. A mixture of fuel and materials to be heated is introduced through the top, and air is forced in below. The fuel in the lower part burns, and any volatile matter distils off, and is retained in large part by the mass of fuel above. In the upper part of the structure the more volatile portions and the unburned gas pass away,

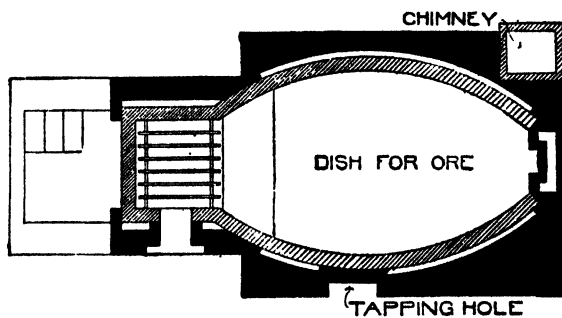


FIG. 11.—Plan of Reverberatory Furnace (after Middleton).

and if properly worked, no smoke is produced. Such furnaces produce large quantities of gas and, if this be burned in suitable burners, a large amount of heat can be obtained, and smokeless combustion assured (see p. 47). In such furnaces and producers there is no hearth or combustion chamber, so that the greater part of the fuel is gasified without being burned; such furnaces are, in fact, large fireplaces, and if the heat from the fuel is to be fully utilised, the gas produced must be burned in a separate combustion chamber connected with a hearth or furnace proper, containing some other goods or materials to be heated. However valuable a blast furnace may be for the smelting of metals from their ores, as a furnace it is quite incomplete for the reasons just given. Hence the utilisation of the so-called waste gases is an important feature in the economical working of such furnaces.

Shaft (Lime) kilns are similar, but the CO_2 from the limestone prevents the gas being used as a fuel. The reduction of this gas to carbon monoxide by passing the kiln gases through a bed of glowing coke and utilising the revived gas is not, as yet, a commercial success.

Retort furnaces (see Fig. 15) consist of a series of closed vessels—retorts—containing the material to be heated, a fire placed below them being used for this purpose. According to the nature of the heat required, the retorts may be surrounded by a non-flaming fuel, such as coke (*cf.* Crucible Furnaces), or they may be fixed above the fire and heated by the gases. If the retorts are made of fire-clay (as in the distillation of coal), they may be fixed immediately above the fire and heated by the fuel on the grate, for they will not materially lower the temperature of the volatile products undergoing combustion, but if metal retorts are used, a slab of fire-clay should be placed beneath them, and the retorts heated solely by the gases. In a retort furnace, the furnace proper is the part where the retorts are placed, the gases being led around the retorts so as to heat them as uniformly as possible. By placing metal retorts too close to the fuel they effect a cooling of the volatile matter, interfere with complete combustion, and produce a deposit of soot, which means a waste of fuel.

Coke ovens consist of chambers or kilns in which coal is heated so as to distil off the gas, tarry and volatile constituents, leaving a residue of coke. By utilising the waste heat from one oven to heat others in a series, a great saving of fuel is effected and the by-products are recovered more completely. For further details see p. 51.

A water-tube boiler of well-known design is shown in Fig. 13. It consists of a horizontal cylinder, below which are a number of parallel tubes placed in and above the combustion chamber of the furnace. The water, being divided into a series

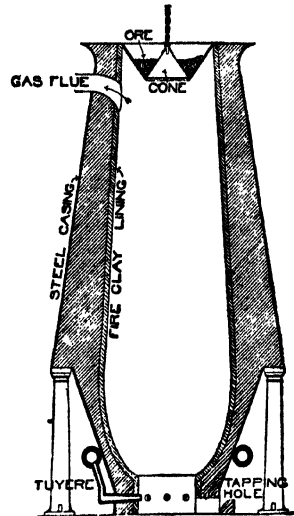


FIG. 12.—Blast Furnace.

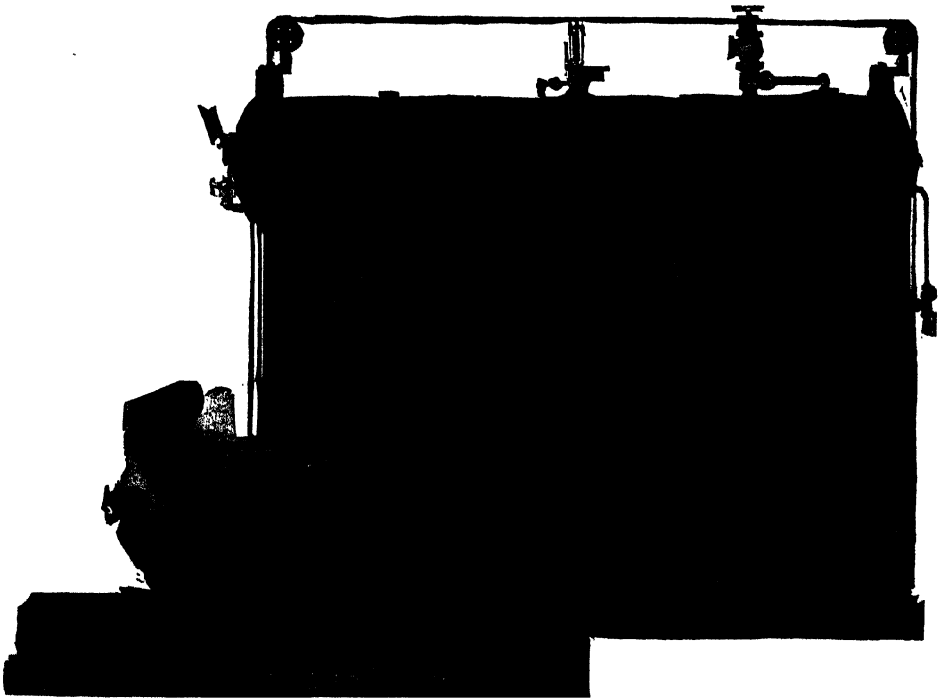


FIG. 13.—Babcock & Wilcox Water-tube Boiler, with Superheater and Mechanical Chain Grate Stoker.

(Babcock & Wilcox Ltd., Glasgow.)

of small portions in the tubes, is rapidly converted into steam and rises up the vertical tubes to the cylinder above. Any water present in the steam returns to the tubes and is reheated. A mud collector is attached to the lowest part of the tubes to collect any boiler deposit which may be formed. A superheater is fitted between the water tubes and the cylinder, and the steam from the boiler, when passed through this, can be superheated to any desired temperature. An independent superheater may be used if desired.

Kilns and pottery ovens consist essentially of a large structure in which the goods are placed (forming the furnace proper), this being surrounded by a series of fireplaces in which the fuel is burned and volatilised. The combustion chamber is made by the space between the exits of the fireplaces and the goods to be heated, so that a kiln must not be filled too full. In a dome-shaped, down-draught kiln, the dome forms a most efficient combustion chamber, the burned gases from which pass downwards among the goods, and raise them to the desired temperature.

In the **Hoffmann continuous kiln** the fuel is burned in specially constructed fireplaces inside the kiln, the great space above the fuel, together with that between the fuel and the bricks or lime to be burned, forming the combustion space, and the remainder of the kiln the hearth. This type of kiln is very efficient, as if properly managed the combustion is almost perfect, and the utilisation of heat is such that the gases can be withdrawn by a fan at a temperature of only 150°-200° C.

Muffle furnaces are a form of kiln provided with a lining of refractory material, so as to prevent flame from reaching the goods being heated. Apart from this, they closely resemble other kilns.

Electric Furnaces.—For those see "Treatises on Electricity," and also Vol. I., pp. 441 *et seq.*

Dust Firing has greatly increased in popularity in recent years on account of its two chief advantages—efficiency of combustion and cleanliness in the furnace.

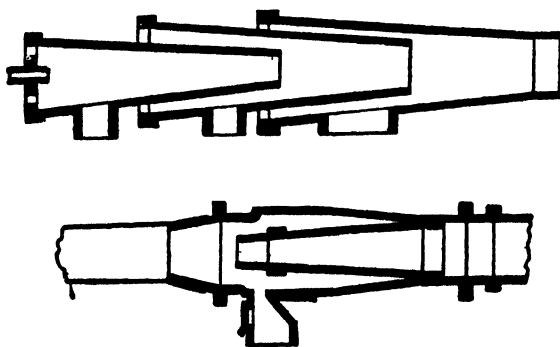


FIG. 14.—Burner for Dust Firing.

The fuel used is coal, which is dried and ground so finely that 90 per cent of it will pass through a sieve with 200 holes per running inch. This dust is then blown into the kiln through a specially designed nozzle (Fig. 14), when it catches fire and burns with a peculiarly long and intensely hot flame. It is specially used in the burning of cement in rotary kilns (*q.v.*), but is capable of a much wider application.

It approaches more nearly to ideal combustion than any other method of burning coal, and is about 20 per cent. cheaper than producer-gas, which is its chief rival.

FURNACES FOR LIQUID FUELS

Liquid fuels, when used for heating purposes on a large scale, are first broken up into minute drops ("atomised") by passing them through an injector with a current of air. In this form they may readily be ignited and burn with a long, flaring flame of great intensity, the heating power of which depends on the size of the drops and the air pressure. A typical burner for this purpose is shown in Fig. 1, p. 26.

This arrangement is much better than that sometimes adopted for burning tar and very thick oils, *viz.*, allowing the liquid to drop on to a mass of hot coke and so burning it. After a time the tar forms its own coke, and the burning may be continued indefinitely with tar alone. This method of working always produces some smoke, and it is difficult to burn the tarry residue produced, so that it is only used for primitive furnaces where tar is very cheap, and compressed air is not available.

Liquid fuels are little used in Great Britain, but in the United States they are extensively employed. Where it can be obtained cheaply, oil is intermediate in convenience between coal and producer gas, and for some furnaces is preferred to the latter on account of the simplicity of its use, no "producer" being needed.

For the advantages of liquid fuels in furnaces, see p. 26.

GAS-FIRED FURNACES

The combustion of gaseous fuels is quite different in many respects from that of solid fuels. If the gas is sufficiently inflammable to burn on simple admixture with air, it will usually produce a flame of noticeable length, the direction of which will depend on that of the gas and air entering the furnace. By varying the direction of each, flames of very different character may be obtained. For most purposes, a Bunsen burner is used, or the gas and air enter through ports made of fire-brick and immediately mix together and then commence to burn a short distance from the ports. The length of flame and the intensity of the heat are regulated by turning on more or less gas or air as the case may be, this part of the operation being much simpler than when coal is used direct as a fuel.

Fig. 15 shows diagrammatically how gas-firing is employed for heating the retorts in ordinary coal-gas manufacture.

A complete drawing of a modern gas-fired retort, fitted with regenerators, is given in Fig. 168, *Martin's "Industrial Chemistry: Organic,"* p. 391.

A typical modern gas-fired furnace, in which the burners act on the Bunsen principle, is described in this volume under *Coke-Ovens,* p. 53 (*Otto Furnace*).

Provided that sufficient space is supplied for the mixing and combustion of the gases, a perfectly smokeless flame is produced, but if the supply of air is too limited, or the mixture is not allowed to burn properly, a luminous, smoke-producing flame may be formed. Gas-fired furnaces are built on precisely the same lines as those used for burning coal, but as the fuel is already gaseous, no fireplace is needed. Where some designers of gas-fired furnaces have erred is in omitting to provide sufficient space for the combustion of the gas and air.

The chief difference between a furnace fired by gas and one fired by coal is the necessity for providing a supply of hot air. The heating of this air is effected in flues placed in convenient parts of the furnace (see Figs. 2 and 6, pp. 52 and 54), so that only waste heat is used. This gives to drawings of gas-fired furnaces a different appearance from those for burning coal, but the difference, as explained, is more apparent than real; more especially as many coal-fired furnaces would be increased in efficiency if flues for heating a supply of secondary air were provided.

Owing to the greater ease with which the relative proportions of gas and air can be regulated, it is possible to attain much higher temperatures with less injury to the furnaces than when coal is used. Hence the use of gas is rapidly extending, as it is easier to manage, is cleaner, and fewer spoiled goods are produced.

The Regenerator Principle.—The great importance of supplying hot air for combustion in the furnaces has already been alluded to at some length on p. 32.

In large furnaces, such as those used in iron works, this is provided by allowing the hot gases passing away from the furnace to heat the incoming air, so that the former are cooled in passing from the furnace to the chimney, while the cold incoming air is raised to a very high temperature.

Siemens, in his famous **Regenerative Furnace**, achieved this by fitting each furnace with at least two chambers, called **Regenerators**, filled with a chequer-work of bricks, through which gas or air can readily pass. The regenerators are usually placed underneath the furnace as shown (Fig. 6, p. 54), and by means of suitable valves the hot waste gases coming directly from the furnace are allowed to pass through one regenerator, while the air needed for combustion passes through to the other in the furnace. The hot gases from the furnace gradually heat the brickwork of the regenerator to a very high temperature, and as soon as this is achieved the valves are altered so as to deflect the incoming air into the hot

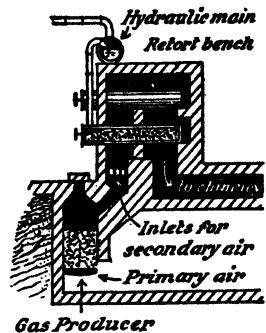


FIG. 15.—Heating Retorts by Gas.

regenerator, and the hot waste gases from the furnace into the cool one. The result is that, before reaching the furnace, the incoming air must pass through a layer of very hot brickwork, and so become intensely heated, while the heat carried off by the waste gases is usefully employed in heating the regenerator, which has been cooled by imparting its heat to the incoming air. The alternation of the gas and air through the regenerators is made four or five times per hour.

This is the process which first made gas furnaces a practical success, enabled very high temperatures to be attained therein, and effected a very great fuel economy.

Recuperators are another form of appliance designed to utilise the waste gases for heating a supply of air. There are numerous patterns, but the most important consist of a series of pipes placed in a chamber, flue, or another series of pipes. The hot gases pass through the latter in one direction, whilst the air passes inversely through the former. Recuperators have the advantage of keeping the air free from the products of combustion, but its temperature is not quite as high as when a regenerator is used. Recuperators work continuously and require no reversing valves.

In furnaces such as Ponsard's the air to be heated passes through channels in perforated bricks on its way to the furnace, while the hot gases from the furnace circulate around the outside of these bricks, and so heat them (and the air passing through their interior) to a high temperature.

Again, in Gorman's "Heat Restoring Furnace" the incoming cold air for the furnace passes through a system of fire-clay tubes, while the hot burnt gases from the furnace circulate around these tubes and heat them. See also Martin's "Industrial Chemistry: Organic," Vol. I., Fig. 168, p. 391, for an arrangement whereby the waste gas flues and the flues of the incoming cold air run parallel to each other, and so interchange their heat, the air entering the furnaces at a high temperature and the waste gases escaping to the chimney at a temperature of only 300° C., or just sufficient to create an adequate draught.

CHEMISTRY AND PHYSICS OF COMBUSTION

Complete combustion is said to occur only when the whole of the fuel has been oxidised or burnt to the most complete extent possible. With the fuels ordinarily used this occurs when all the hydrogen present has been converted into water and all the carbon into carbon dioxide. In this state, the maximum amount of heat possible has been developed, as the conversion of the original substances in the fuel into the two oxides named is the end of a series of reactions of a chemical nature, the total effect of which is the evolution of a definite amount of heat. That the whole of the heat so liberated may not have been usefully employed has, of course, nothing to do with the case. An extended series of investigations has shown that when any element burns, *i.e.*, enters into combination with another to form an oxide, a definite amount of heat is liberated, and this amount is constant, no matter what are the conditions under which the reaction occurs. This fact furnishes a definite means of ascertaining how much heat is produced in a given case, and by comparing this with the heat actually measurable, the efficiency of the plant or of the fuel may be measured.

Unfortunately, no actual results on a commercial scale come anywhere near the figures realisable by perfect combustion under ideal conditions—gaseous fuel being the nearest—so that the comparison is somewhat disappointing, and its actual value is problematical.

It is an essential condition of combustion that the fuel and air (or oxygen) must be at a suitable temperature for the reaction to take place. This is known as the **temperature of ignition**, and varies with different fuels and with their physical form.

O. Dammer gives the following as average figures :—

For peat	-	-	-	-	225° C.
„ pine wood	-	-	-	-	295°
„ coal	-	-	-	-	326°
„ wood charcoal	-	-	-	-	400° to 800°, according to temperature of preparation.

Dixon and Coward give the following ignition temperatures for gases in air, those for ignition in oxygen being slightly lower :—

Hydrogen -	-	-	-	580 to 590° C.
Carbon monoxide	-	-	-	644 ,, 658°
Ethylene -	-	-	-	542 ,, 547°
Methane -	-	-	-	650 ,, 750°
Ethane -	-	-	-	520 ,, 630°
Acetylene -	-	-	-	406 ,, 440°

The upper limit of combustion is fixed by the temperature at which water and carbon dioxide begin to dissociate ; this is just above 2,200° C.

The amount of available heat produced by the combustion of a fuel under given conditions is measured by ascertaining the rise in temperature of a known weight of a suitable substance, which is heated under the given conditions by a known weight of fuel. In the case of coal used for boiler firing, the amount of available heat is measured by finding the number of lbs. of water evaporated by each lb. of the fuel. For this purpose the boiler is filled with water, and when this is boiling properly the fire is cleaned out and the heating is continued with a weighed quantity of fuel. The steam produced is condensed, and the water thus produced is weighed ; its weight represents that of the water evaporated by the weight of fuel used.

To obtain accurate results it is necessary to continue the heating for several hours, so as to use a sufficiently large quantity of fuel ; short tests are often very misleading.

1 lb. of good coal should evaporate 15.2 lbs. of water at 100° C., or 212° F. ; coke will only evaporate 14 lbs. ; dry wood, 11 lbs. ; petroleum oils, 28 lbs. of water per 1 lb. of the fuel.

The evaporative power of a fuel may also be calculated from its composition by assuming that each 1 lb. of carbon has a calorific power of 14,544 B.T.U., and dividing this by the latent heat of water (967). This gives 15.0 as the evaporative power of pure carbon, and a similar calculation shows that of hydrogen to be 54.6 lbs.

Heat Units.—For many purposes the evaporative power of a fuel is an inconvenient unit, and the amount of heat is therefore measured by ascertaining the weight of water which 1 lb. (or 1 kg.) will heat sufficiently for its temperature to be raised 1° F. (or C.). For very accurate work, the temperature must be raised from 60°-61° F. (or 0°-1° C.). The amount of heat thus produced is termed a **British Thermal Unit** (B.T.U.) if it suffices to heat 1 lb. of water 1° F., or a **Calorie** if it suffices to heat 1 kg. of water 1° C.

To convert a quantity of heat in (kilogramme) calories into B.T.U., multiply by 3.968.

To convert a quantity of heat given in B.T.U. into (kilogramme) calories, multiply by 0.252.

The measurement of these heat units is effected by burning the fuel in a calorimeter (p. 8). The number of units of heat produced by a unit of weight of fuel is termed its **calorific power**, so that the thermal value of the reaction which takes place between the fuel and the oxygen of the air when the fuel is burned is the same as the calorific power of the fuel, provided that the combustion is complete.

In the case of carbon, the product of combustion may be either carbon monoxide (CO) or carbon dioxide (CO₂). The former may also burn and form the latter, the heat units evolved being as follows :—

C + O ₂ = CO ₂	-	-	174,528 B.T.U.	96,960 Cals.
CO + O = CO ₂	-	-	122,328 ,,	67,960 ,,
∴ CO =	-	-	52,200 ,,	29,000 ,,

which, divided by 12 (the atomic weight of carbon), gives :—

Calorific power of C to CO	=	4,350 B.T.U.,	or 2,416 Cals.
,, ,, C to CO ₂	=	14,544 ,,	8,080 ,,

It is important to notice that the second atom of oxygen combining with the carbon evolves more than double the heat of the first. This is probably due to the advantage gained from the use of gaseous fuel, heat being used in the vaporisation of the solid fuel.

As already explained, the calorific power of solid fuels gives but little indication of their practical value, but that of gaseous fuels is of great importance. This is due to the gases being burned under conditions much more closely resembling each other than when solid fuels are burned in a calorimeter and a furnace respectively.

The calorific power of a fuel is always less than that of the sum of its constituent elements, as some heat is absorbed in the formation of the fuel itself. This heat of formation can be ascertained when required. In the case of Marsh-gas (methane) the heat of formation is 25 per cent. of the total heat of combustion of the constituent elements. Hence the use of formulæ for calculating the calorific power of fuels must always be unsatisfactory.

The **highest temperature attainable** by the combustion of a fuel is termed the **calorific intensity**, and is necessarily of a somewhat theoretical nature, as so much allowance has to be made for various factors affecting it.

Theoretically, the maximum temperature attainable is found by dividing the calorific power of the fuel by the product of the weight of the products of combustion and the specific heat, but such high results are never attained in actual work. Such a calculation does not sufficiently take into account the cooling effect of the walls of the furnace or other arrangement in which the fuel is burned, nor of the diluting effect of the excess of air which must be admitted in practice to secure a complete combustion of the fuel.

With coal it is seldom that a temperature higher than 1,600° C. can be reached by goods in a furnace without a blast, nor more than 1,800° C. by goods in a furnace where a blast is used. Some materials heated in direct contact with the fuel may attain higher temperatures locally, but the figures just mentioned represent the highest available over any considerable part of the furnace. With gaseous fuels, on the contrary, considerably higher temperatures may be attained, especially if the gas is rich and both it and the air are heated. Using ordinary town gas and hot air, both under pressure, the author has succeeded in obtaining a uniform temperature of 1,980° C. in a furnace of rather more than 3 cub. ft. capacity, but the ordinary furnace linings are useless at this temperature, and pure alumina bonded with a little fire clay will only resist it for a few hours. This temperature may therefore be taken as the practical limit for gas-firing with air (see p. 11).

When oxygen and coal-gas are used the temperature at the extreme tip of the flame has been found by Féry to be 2,200° C., and it is doubtful whether any higher temperature can be obtained by the use of fuel. Much higher temperatures can be obtained in small electrically heated furnaces.

Excess of air is one of the most frequent causes of low calorific intensity in a furnace, for each unit of air in excess of that required for the combustion absorbs heat in being raised to the temperature of the gases with which it is mixed. Air may be regarded as a mixture containing 21 per cent. of oxygen by volume and 23 per cent. by weight. The remaining constituents may, for all practical purposes, be regarded as nitrogen, and inert except as a diluent. Hence the weight of air required for a fuel can be calculated from the percentage of its constituents by means of the following table.

WEIGHTS OF OXYGEN AND AIR REQUIRED FOR COMBUSTION

	Oxygen.	Air.
One part by weight of—		
Carbon - - - - -	2.66	11.56
Hydrogen - - - - -	8.00	34.8
Carbon monoxide (CO) - - - - -	0.57	2.5
Methane - - - - -	4.0	17.4
Ethylene - - - - -	3.43	14.9
Acetylene - - - - -	2.86	12.4

At ordinary atmospheric temperature and pressure, 1 cub. ft. of air weighs 0.07639 lb., and the volume of air in cubic feet for most fuels will be

$$V = 1.57c + 4.71h,$$

where c = the percentage of carbon and h = the percentage of available hydrogen in the fuel.

In actual work an excess of air must be employed. This is found by experience to differ with different furnaces. For gas furnaces, the amount of air actually needed will be found by multiplying V (p. 46) by 1.5, for good coal-fired furnaces by 2.0, and for defective firing arrangements by 3, or even by a higher figure.

The excess of air actually present may be ascertained by an analysis of the flue gases, as this will show the amount of carbon and hydrogen burned. In practice, the hydrogen may be omitted, and attention confined to the carbon. If the carbon is completely burned to carbon dioxide, the percentage of this gas present in the flue gases will show what excess of air is present. Thus, if only just the right quantity of air had been used, the flue gases would contain 21 per cent. of carbon dioxide. Hence the smaller the percentage of CO_2 the greater will be the excess of air present. If the number 21 be divided by the percentage of CO_2 in the flue gases, the quotient will be the amount of air used relative to each volume which should have been employed. Thus, if the gases contain 10.5 per cent. of CO_2 , then $\frac{21}{10.5} = 2$, or twice as much air as is theoretically necessary.

As the temperature of the flue gases affects the result, Siegert prefers the following formula :

$$V = \frac{0.72(T - t)}{\text{CO}_2}$$

where V = the volume in cubic yards, T is the temperature of the flue gases in $^{\circ}\text{C}$., and t the temperature of the atmosphere in $^{\circ}\text{C}$.

The foregoing formulæ assume the complete combustion of the carbon to CO_2 and the absence of CO . This must be determined by testing the gases. As, however, the formation of CO is unusual in flue gases, it is generally sufficient to determine the proportion of CO_2 , and this may be done automatically by an Ados or similar instrument, particularly in association with a recording draught gauge and a recording pyrometer.

The use of such an appliance has been found to effect very considerable savings in the quantity of fuel burned, particularly in steam boilers.

Sources of Loss of Heat in Burning are very numerous even under the best conditions obtainable in practice. They may be summarised as follows :—

1. Heat absorbed or radiated by the furnace.
2. Loss through imperfect combustion.
3. Loss through excess of air admitted.
4. Loss in chimney, including (a) the heat required to produce the draught. (b) additional heat passing up the chimney.
5. Loss through imperfect application of heat to the goods to be heated.
6. Loss of heat in the ashes.

The remedies for most of these losses are fairly obvious, but it is difficult to carry them out unless the workmen are strictly supervised. Some of the losses can never be avoided completely, but they can be reduced to a minimum by care and skill.

SMOKE AND SMOKE PREVENTION

Smoke is unburnt carbonaceous material suspended in air, and it is formed as a result of incomplete combustion of the fuel. The chief causes of smoke are too low a temperature in the combustion chamber (p. 30) or in the furnace proper (p. 30), or the lack of sufficient air. If an ample supply of air is provided, and the temperature of the burning materials is sufficiently high until the combustion is complete, no smoke will be formed. If, on the contrary, the air is sufficient in quantity, but is not allowed to mix with the burning material until the latter has become too cool for complete combustion, smoke will be formed. Hence in the prevention of smoke, *i.e.*, in the provision of perfect combustion, there are three essential factors :—

1. Ample air supply (usually in excess of that theoretically required for combustion).
2. The air and burning fuel must be thoroughly mixed.
3. The mixture must be maintained at the right temperature until combustion is complete.

The majority of cases where smoke is produced are due to the last two conditions remaining unsatisfied, premature cooling of the gases being an even

greater cause of smoke than is lack of capacity of the combustion chamber. Some methods of avoiding these defects are given on pp. 32-37, but the difficulty in applying them lies partly in the fact of increased cost of construction of the furnaces, and partly in the apparent necessity for a luminous flame for some purposes.

In a steam boiler of the Lancashire type, for example, many engineers who have given some attention to the subject consider that a luminous flame is essential because of its high radiation, a luminous flame being able to carry more radiant heat than a non-luminous one. In view of the high efficiency reached in furnaces in which much higher temperatures are required than in boilers, the necessity for a luminous flame does not appear to be well founded; rather should economy be sought in the better combustion of the fuel and in a corresponding modification of the boiler setting. Even admitting the advisability of a luminous flame, however, this could be made far more efficient by a proper gasification of the coal than by the arrangement usual in boilers at the present time.

In some industries the prevention of smoke is impossible; these are the ones in which the heat must be accompanied by a reducing atmosphere—the conditions in which smoke is almost essential so long as coal is used as fuel. By the employment of gas (producer-gas with or without enrichment with oil) the same conditions may be obtained with a much smaller proportion of smoke, but the risks involved in altering the furnaces, providing that they do not prove satisfactory, or in case the men do not use the same skill as formerly, make the owners of existing furnaces very loth to change. When a failure with the furnace means a loss of several hundred pounds worth of material, whilst the existing furnace continues to give satisfaction, it requires a man of more than usual perspicacity to make the necessary changes in his plant.

Far exceeding the damage wrought by works, however, is that due to the smoke emitted by countless domestic chimneys. The ordinary house grate and kitchen range are peculiarly objectionable as smoke producers, and cannot be altered without fully changing their character and robbing them of the peculiarly "comfortable" appearance which is the chief reason for their existence.

Smoke Preventers of various kinds have been patented in large numbers. They chiefly aim at producing a better combustion by the introduction of a further supply of air—usually in an unsuitable part of the furnace. In the majority of cases, the best means of preventing smoke is to ensure that the furnace is of suitable construction to meet the three conditions mentioned above, but when structural alterations of an extensive character are not practicable, much may be done by introducing more air by means of an injector or a sliding damper controlled by a dash-pot, the air being admitted only during the time when smoke is likely to be formed. Means for increasing the draught of the kiln may also prevent smoke, as may the introduction of hot air in various parts of the flues, though preferably in the combustion chamber.

As a rule, whilst a smoke preventer of a patented nature will usually do much good in cases where its aid is desirable, it will generally be found that equal benefit will be obtained by the use of an unpatented arrangement designed to secure the three essential conditions previously mentioned.

Gas-firing, by being under better control and free from the chief cause of smoke when coal is burned, viz., the imperfect mixture of air and volatile matter and too low a temperature in the combustion chamber, is usually smokeless. Unless a gas-fired furnace be properly constructed, however, it can produce a large volume of smoke, though not as much as a coal fire. The gasification of coal before burning is, therefore, one of the best methods for preventing smoke, and in many cases it will also be found to effect a considerable saving in the amount of fuel used.

Soot is the deposit formed when products of combustion carrying smoke are brought into contact with a cool surface. It is also formed when a luminous flame impinges on a surface much cooler than itself, as when a saucer is placed in the flame of a candle, or a bright flame strikes a cooler metallic plate.

The formation of soot is a clear indication of undue cooling, and can best be prevented by placing a poor heat conductor (such as a fire-clay slab) between the gases or flame and the object on which they impinge. By not conducting the heat, the fire-clay will soon become sufficiently hot at

the surface for the slight film of soot deposited to be burned away, and will remain too hot for any further deposition to occur. In some cases it is impossible to avoid the formation of soot without radically altering the construction of the heating arrangement.

Soot is itself a bad conductor of heat, and objects on which it is deposited cannot be heated so rapidly as those which are free from this material. Hence, where economy in heating is desired, no pains should be spared to so arrange the furnace or heating appliance that there is no deposition of soot on the objects to be heated.

It is quite a mistake to suppose that soot consists entirely of carbon; in most cases it usually contains 16-35 per cent. of ash and 5-15 per cent. of hydrocarbons, the latter being the chief cause of its oiliness.

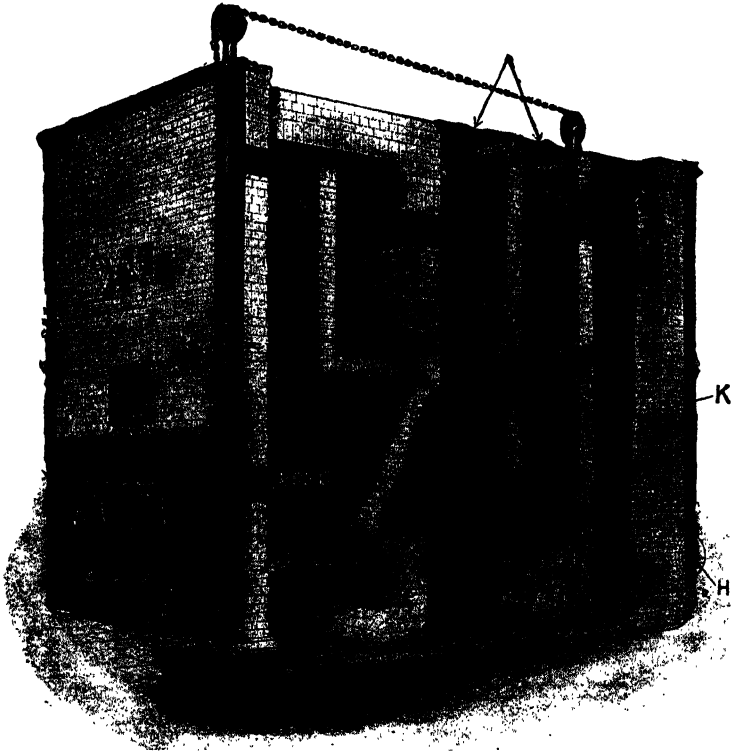


FIG. 16.—Perspective View of Independently Fired Superheater, with Side Wall Removed.
(Babcock & Wilcox Ltd., Glasgow.)

The Production of Superheated Steam.—Superheated steam plays a very great part in many chemical industries (as, for example, in Frasch's process of sulphur extraction, in sugar refineries, briquette making, etc.).

Superheated steam, as its name implies, consists of ordinary steam which has been raised to a still higher temperature out of contact with water in the boiler. It forms the final stage in the production of steam which is quite dry when it reaches the engine or other appliance where it is required, whereas ordinary saturated steam usually contains an objectionable proportion of water, which greatly detracts from its value. The degree of superheating varies with the local conditions, but it is quite usual for the superheated steam to be 100° C. higher than the steam in the boiler, and for turbines it may be 350° C. higher.

Usually, the superheater is made a part of the boiler, as in Fig. 13, p. 41, in which a series of pipes, carrying steam from the boiler, run through the furnace itself, and so become raised to a very high temperature.

Sometimes, however, it is necessary to use a separately fired superheater, as in Fig. 16. Steam enters at A, passes through a number of horizontal manifold pipes interconnected by tubes G, so that a thorough circulation of the steam is obtained, and the superheated steam passes out by the pipe H.

The hot gases from the fireplace pass through a perforated wall L into a muffling chamber O, thence into the superheater chamber containing the steam-pipes, the hot furnace gases passing round the flame baffles M, and away by the damper K into the main flue.

One serious objection to the use of superheaters is the risk of damaging them when first heating up the boiler. To avoid this it is customary to flood the superheater, but this is a troublesome procedure which is not wholly free from danger. By shrinking a series of cast-iron discs on the superheater pipes (as in the Foster superheater manufactured by the Worcester Engineering Works, Worcester), the risk of overheating the superheater is prevented, and no flooding is necessary.

Flue Gases.—For large-scale methods of purifying and removing sulphur and dust see **Hewson, Pearce, Pollitt, and Rees**, *Chem. Eng. Group*, 11th July 1933; B., 1933, 735.

SECTION V

COKE OVENS

BY GEOFFREY MARTIN, D.Sc., Ph.D.

LITERATURE

- BURKE, SCHUMANN, and PARRY.—*Fuel*, 1931, 10, 148.
 O. HUPPERT.—*Technique Moderne*, 77.
 C. E. FOXWELL.—*Chem. and Ind.*, 1933, 49.
 F. H. WAGNER.—“Coal and Coke.” New York.

COKE OVENS.—We have not space to give more than a sketch of the construction of these, and for further particulars reference must be made to works devoted specially to the purpose (see pp. 1 and 29). The ordinary **Beehive Oven** is built of fire-brick lined with clay, being about $8\frac{1}{2}$ ft. high and $11\frac{1}{2}$ ft. in diameter at the base (see Fig. 1). The ovens are built in blocks of twelve or twenty-four. The oven is charged with about 7 tons of coal in the form of a coarse powder, and an inner or false door of fire-brick set in clay is built up so as to prevent the coal from running out.

Usually the furnaces are at a dull red heat when the coal is poured in, and so

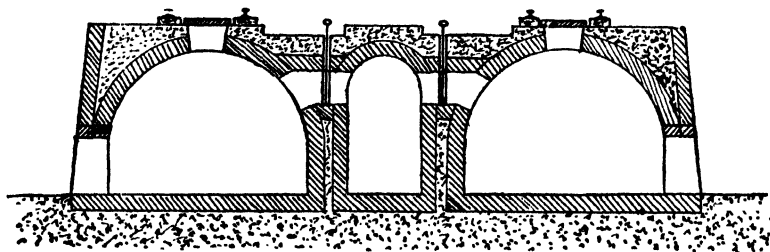


FIG. 1.—The Beehive Oven.

combustion soon starts, the supply of air being regulated by dampers. Sometimes, however, combustion is started by lighting a fire on top of the charge.

The combustion is allowed to proceed in a gradually diminishing supply of air, until the whole of the charge inside has become quite red hot. On the fourth day the oven is luted up, and on the fifth day it is discharged, the coal being converted into coke. The coke is withdrawn by means of long rakes or hoes (“cleeks”) through the front door.

Seven tons of coal yield 4.5 tons of coke.

These ovens are very wasteful, no attempt being made to recover the ammonia or utilise the combustible gas.

The Coppée Oven—extensively used on the Continent and in this country—is an improvement on the “Beehive.” The retorts are horizontal chambers, 30 ft. long, and $1\frac{1}{2}$ ft. wide and 4 ft. high, built of fire-bricks in stacks of twenty-two to fifty as shown, and are worked in pairs, one retort being charged while its neighbour is half-coked. When the coking is complete the doors at both ends are opened, the coke forced out by a ram carried on a truck running on rails, and quenched with cold water (see Figs. 2 and 3). Time of charging, eight minutes; coking, twenty-four to forty-eight hours.

With the increasing demand for **Ammonia** and **Tar**, coke ovens have now come into existence in which these products are recovered. While the coal tar and the ammonia (through cooling the gases and washing them with dilute

sulphuric acid) were at first the only products recovered, since 1887 benzene has been extracted in large quantities from the tar and ammonia-free gases by washing them with heavy oils, which retains the benzene (benzol), so that, especially in Germany, more benzene (benzol) is abstracted than the colour industries and the carburetting gas installations require.

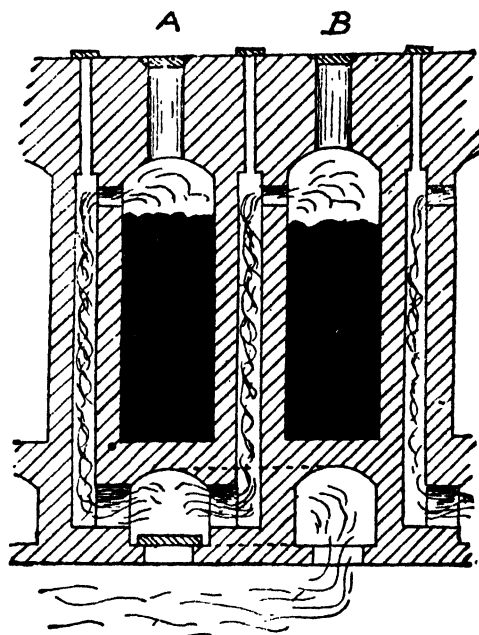


FIG. 2.—Coppée Retorts, showing Circulation of Hot Gases about them.

In Germany there was obtained :—

	1909.	1930.
	Tons.	Tons.
Coke with recovery of by-products	17,400,000	32,992,018
Coke without recovery of by-products	4,000,000	
Ammonium sulphate	280,000	448,000
Tar	600,000	1,394,558
Benzene (benzol)	80,000	330,000

We have only space to describe a few of the several excellent "Recovery" coking ovens such as are now extensively used on the Continent.

The Otto Oven.—This, like the Coppée oven, consists of horizontal retorts placed side by side. They are charged through openings in the roof, and discharged by a ram from one end of the retort. Regenerators are used for heating the air before the combustion of the gas, and gas firing is employed. Figs. 3 and 4 show a longitudinal and cross section of the furnace. Fig. 3 shows a half-longitudinal section C D, corresponding to the cross section C D (Fig. 4) going through the oven *a*, while the half-longitudinal section A B (Fig. 3) corresponds to cross section A B (Fig. 4) through the heating flues running between two ovens.

The cross section (Fig. 4) shows several ovens both in cross section (A A) and as they appeared from a front view (C C).

The ovens, united in a long row of batteries, are about 10 yds. long, 6½ ft.

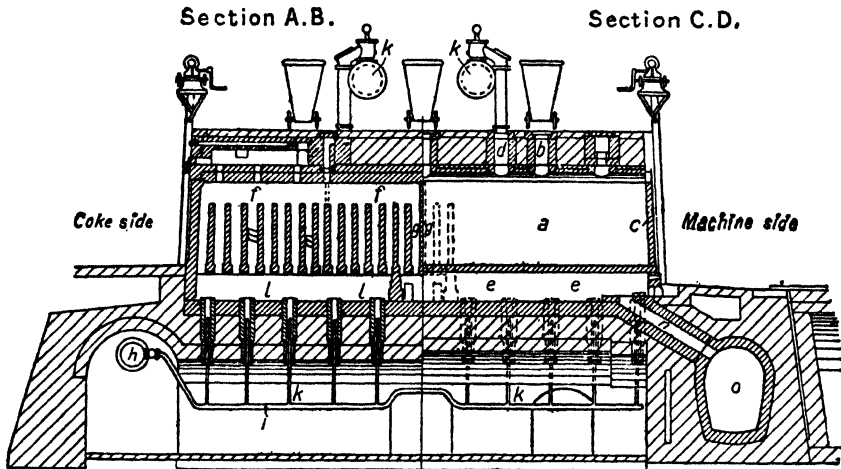


FIG. 3.—The Otto Oven (Longitudinal Section).

high and only 20 in. wide. The ovens must be narrow in order that the heat should thoroughly penetrate the coal contained in them. The higher the ovens the denser the resulting coke, but if the ovens much exceed 6½ ft. the coke becomes difficult to force out by means of a ram.

The gas for heating the ovens enters through the main tube *h*, and then passes into a series of branching tubes *i i*. Thence it passes up through a series of ten burners *k k k*, which are arranged along the length of the furnace as shown. These burners, arranged after the manner of Bunsen burners, suck in air from below, and the burning gases then stream through the flues *l m*, intermediate between every pair of ovens, passing upwards between a series of vertical masonry baffles *m m* (Fig. 3). The burning gas then escapes through the space *f f* to the middle of the furnace, then away through *g g* into the longitudinal flues *e e*, which lie just under the coke ovens, then out of these, through *n*, and through the flue *o*, to the chimney (or regenerators if they are employed).

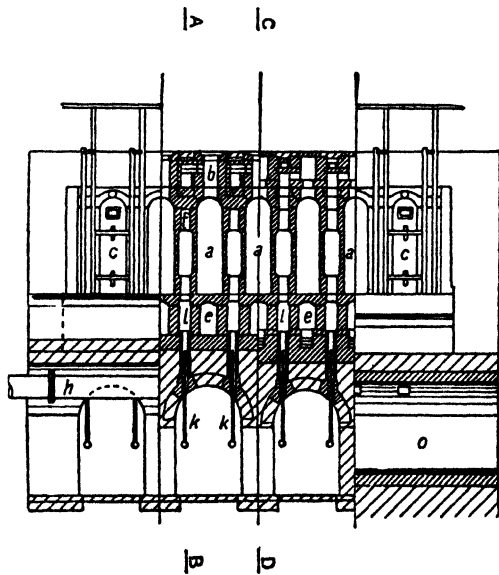


FIG. 4.—The Otto Oven (Cross Section).

The ovens are charged through three openings in the roof, *b b b*. Certain kinds of small coal are made wet, stamped into solid cakes in iron vessels, and pushed into the ovens in the form of solid cakes. The gas tar and ammonia escape

through the two openings *a*, into tar hydraulic mains *kk*, thence the gases are forced by exhausters into coolers and washers, where the ammonia, benzene, and tar are completely extracted. The gases not condensed are combustible and are first stored up in gas holders, and thence drawn off for heating the coke ovens by means of the tubes *h*. Much more gas is obtained than is required to work the ovens, and can be utilised as a source of energy or for illuminating gas.

In the newer types of ovens **Regenerators** are employed to heat the incoming air for the burners. These consist of chequered brickwork, and the hot gases from the furnace are first passed through one of these on their way to the chimney. When the bricks are thoroughly heated (which takes about an hour), the direction of the air and gas is changed, so that the regenerator, which before was heated by the products of combustion, now heats the air on its way to the combustion chamber, while the combustion products are now turned into a second regenerator

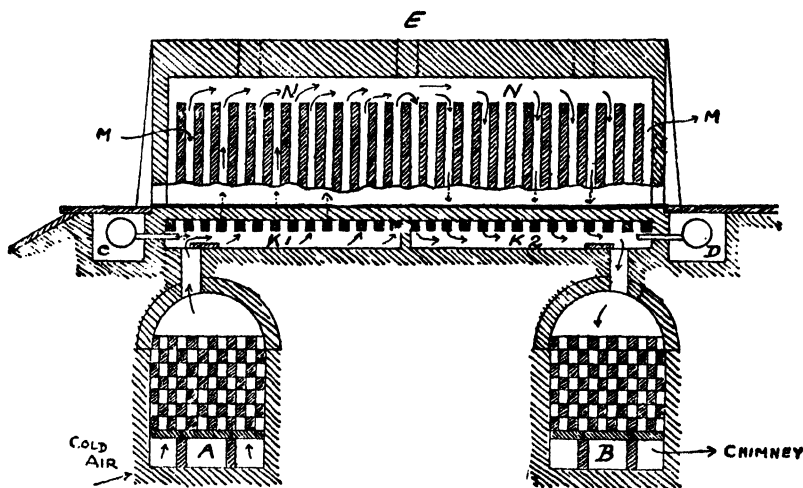


FIG. 6.—Coking Furnace, showing Regenerators, A and B.

in order to heat it up to the required temperature. Fig. 6 shows a furnace so fitted, A and B being the regenerators.

By use of these regenerators a very high temperature can be obtained.

Other ovens, all fitted with regenerators and all of a somewhat similar type, are the **Otto-Hilgenstock Oven**, the **Brunck Oven**, and the **Koppers Oven**. The latter oven has heating flues so arranged that the gas in the different stages of the heating process can be separately led off, and the richer sorts of gas used for illuminating purposes.

The coke formed in these forms is in dense and compact masses. To withdraw it the iron doors of the coke ovens are raised, and an iron plate forced through by machine power, whereby the glowing coke is forced out and immediately quenched by sprinkling water on it—obviously a great waste of heat. Some sulphuretted hydrogen, H_2S , escapes at this stage.

An oven yields 6-8 tons of coal every thirty hours; 100 parts of dry coal yield 70-80 parts of coke.

Before leaving the subject of coke ovens, it should be pointed out that the excess of gas available (after supplying the gas for working the ovens) has, with improved methods of construction, increased from 20 per cent. to nearly 45 per cent., and so the coke ovens have become centres of power, the gas being laid on for producing electrical power, driving engines, and even for illuminating purposes.

Of course the gas from the coke ovens is nothing like so rich in heavy hydrocarbons as is ordinary coal-gas, and so has not the illuminating nor heating power of this latter gas.

However, it has been found that if the gas which comes over during the first eleven to twelve

hours of the distillation be separately collected and stored without extraction of benzene, this "rich" gas has a heating value (5,000 to 6,000 calories per cubic metre) which is quite as good as that obtained from the best retort gas, and is quite the equal of the latter as regards illuminating power.

Consequently in Germany (*e.g.*, at Essen, Gelsenkirchen, etc.) coke ovens often supply the neighbouring towns with their illuminating gas. Some other towns add to their coal-gas some 25-50 per cent. of coke-oven gas.

Already in 1909 in Germany some 25,000,000 cub. m. of coke-oven gas in the Rühr district alone were consumed for illuminating purposes, and the consumption is rapidly extending.

Glover-West Vertical Retorts.—Over 9,750 retorts were in operation in 1933, producing 19,000 tons of dry vertical coke.

For details the makers, **West's Gas Improvement Co. Ltd.**, of London, should be consulted.

Recovery of By-Products.—The gases and volatile products escaping from the coke ovens are worked for tar, ammonia, and benzene. At present little cyanogen is recovered, but large amounts could be recovered were the market conditions more favourable.

The gases coming from the coke ovens are first led into the tar-sealed mains, much as described for gas works (see **Martin's** "Industrial Chemistry: Organic"), where the bulk of the tar is deposited. Then follow a series of coolers, water coolers, tar separators, and naphthalene washers. Then the gas is scrubbed for ammonia by passing through dilute sulphuric acid, and last of all comes the benzene extraction.

From 100 tons of coal some 2-4 tons of tar are obtainable, considerably less than is derived from ordinary coal-gas plant.

The yield of ammonia is slightly greater than is obtained in gas making, 100 tons of coal yielding about 1.2 tons of ammonium sulphate.

The **direct production of ammonia** by the Kopper process from these coke gases is described under ammonia.

As regards **benzene (benzol)** extraction, the gases are sent through a series of iron towers, some 18-20 ft. high, the gases passing in beneath, and there meeting a descending spray of heavy oils (coal-tar oils, B.P. 200°-300° C.). A low temperature for complete absorption of the benzene is absolutely essential, and sometimes the oils are, before spraying, sent through refrigerating machines where they are cooled to 0° C. and below, before they are sprayed into the towers. The streams of heavy oils are sent against the current of gas in the usual way, and the benzene distilled out of them as in ordinary tar stills. After distilling off the benzol the heavy oils are once more used for spraying.

One hundred tons of coal yield in gas works about 1 ton of benzene. In coke ovens, however, the yield is much less. About 7-8 per cent. of the benzene is condensed in the tar, while 92-93 per cent. passes on with the gas in the form of vapour.

If the gas is to be used for illuminating purposes, naturally the benzene must be allowed to remain in it (see **Martin's** "Industrial Chemistry: Organic"), but in coke-oven gases, which are usually used merely for heating furnaces, etc., the benzene may be recovered by the process above described. In the plant above described, from 1,000 tons of coal burnt in the coke ovens, about 5-8 tons of benzene are usually obtained. It is estimated that were all the coke ovens in Germany alone fitted with benzene-recovery plant, some 160,000 to 200,000 tons of benzene would be annually recovered.

PRODUCTION OF COKE

Producing Country.	1930.	1931.	1932.
BRITISH EMPIRE			
Great Britain—	Tons.	Tons.	Tons.
Gas works - - - - -	12,316,709	12,107,372	11,800,826
Coke ovens—Coke - - - - -	11,514,021	8,470,709	8,480,196
Breeze - - - - -	664,332	550,252	573,280
Canada—			
Gas works—Coke - - - - -	288,598	256,298	246,979
Breeze - - - - -		29,701	26,710
Coke ovens—Coke - - - - -	1,841,754	1,236,179	1,057,924
Breeze - - - - -		114,161	130,621
India—			
Hard - - - - -	62,487	55,484	...
Soft - - - - -	745,564	724,176	...
Australia—			
Gas works—			
New South Wales - - - - -	421,093	370,234	336,846
Victoria - - - - -	260,436	211,224	181,746
Queensland - - - - -	53,805	54,680	47,282
South Australia - - - - -	67,422	51,126	45,618
Western Australia - - - - -	12,496	12,316	10,361
Tasmania - - - - -	5,787	4,288	5,946
Coke ovens—			
New South Wales - - - - -	400,164	285,064	398,860
FOREIGN COUNTRIES			
Austria (gas works) - - - - -	560,497	547,087	578,000
Belgium—			
Metallurgical - - - - -	5,202,131	4,799,827	4,405,405
Breeze - - - - -	492,507	478,511	...
Czechoslovakia - - - - -	2,671,796	2,014,051	...
France—			
Saar - - - - -	2,519,300	1,910,000	...
Other districts—			
Metallurgical, etc. - - - - -	9,124,715	7,814,000	5,746,000
Gas works - - - - -	2,229,483	2,343,000	2,067,000
Germany - - - - -	32,992,018	23,617,836	18,825,580
Italy (metallurgical) - - - - -	800,480	728,575	702,862
Netherlands—			
Gas works - - - - -	700,000	700,000	700,000
Coke ovens - - - - -	2,558,349	2,696,079	2,479,862
Poland - - - - -	1,557,013	1,333,223	1,074,000
Spain (incomplete figures)—			
Metallurgical - - - - -	664,877	495,169	410,922
Gas works - - - - -	229,141	243,801	...
Switzerland—			
Gas works - - - - -	358,816	382,507	...
U.S.S.R. (Russia) - - - - -	6,097,000
United States—			
Coke ovens—Coke - - - - -	42,832,162	29,896,327	19,564,742
Breeze and screenings	3,948,870	2,835,462	1,938,509

SECTION VI

SURFACE COMBUSTION

By E. JOBLING, A.R.C.Sc., B.Sc., F.C.S.

LITERATURE

- Ber. deutsch. Chem. Gesell.*, 46, 5 [1913].
Cassier's Engineering Monthly, 42, 56 [1912]; 44, 25 [1913].
Chemical World, 2, 198 [1913].
Engineering, 43, 632, 701 [1912].
Journ. Franklin Inst., 173, 101 [1912].
Journ. Gas Lighting, 114, 22, 98, 914 [1911].
Journ. Ind. and Eng. Chem., 5, 801 [1913].
Met. and Chem. Engineering, 9, 628 [1911]; 10, 409 [1912].
Moniteur Scientifique, 79, 279 [1913].
- English Patents, particularly:—25,808, 1909 (diaphragm heating); 29,430, 1909 (furnaces); 625, 1911 (melting metals, etc.); 2,404, 1911 (steam generators); 4,362, 1911 (steam generators); 5,936, 1912 (steam generators); 6,732, 1912 (preheating); 6,738, 1912 (back-firing prevention); 19,490, 1912 (back-firing prevention); 23,536, 1912 (furnaces); 25,629, 1912 (nitrogen, etc., manufacture); 28,477, 1912 (utilisation of liquid fuel). All belong to the Boncourt Surface Combustion Co., whilst others are pending.

For those interested in the subject, the Boncourt Surface Combustion Co. Ltd. supply booklets relating to the system. From these booklets the diagrams illustrating this article have been taken, and the author wishes to express his indebtedness for the kind permission to reproduce them.

INTRODUCTION

THE revolution in gaseous heating brought about by the application of the principle of accelerated combustion by hot surfaces, described in the following pages, is almost entirely due to the investigations of Prof. W. A. Bone and Mr C. D. M'Court (see, however, *Journ. Ind. and Eng. Chem.* (1912), 4, 77; and *Engineering* (1912), 93, 657). Several of the industrial applications which have already been patented have been put upon the market, where their efficiency and economy have been practically demonstrated, but others are as yet in the experimental stage, and further development for some time to come must necessarily lie along the lines of the design of apparatus capable of establishment on an engineering basis.

The importance of the surface combustion process can hardly be over-estimated. Its utilisation of combustible gases, and especially of liquid fuel, is in accordance with the general tendency of present-day power production, which is towards the substitution of gaseous or vaporous fuel for solid fuel (see Gaseous Fuels). The time will come when coal will be no longer burned in furnaces or under boilers, but will be gasified, its valuable constituents removed, and the remaining gases used for power production either directly in gas engines or indirectly in other ways. It is in the latter field that the surface combustion process may be expected to play the leading rôle.

Surface Combustion depends primarily on the accelerating influence which hot surfaces are known to exert upon gaseous combustion, and the method consists, briefly, of burning an explosive mixture of gas and air in contact with a granular incandescent solid. Under suitable conditions the combustion is

a flameless one, and develops a large amount of heat in the radiant form. The necessary conditions are: (1) The mixture of combustible gas and air must be in the proper proportions for complete combustion, or preferably with the air in slight excess, and (2) the mixture must be injected on to the granular material at a velocity greater than that of back-firing.

Two simple examples will make clear the *modus operandi*, as well as illustrate the two fundamental types of apparatus employed.

Types of Apparatus.—In the first, shown diagrammatically in Fig. 1, and known as the "Diaphragm" adaptation, the gaseous mixture, in approximately the proportions for complete combustion, is forced under slight pressure from the chamber B through the porous diaphragm A of refractory material, and is ignited on the exit-face, where it burns flamelessly, raising the surface to incandescence. The layer in which combustion takes place is only several millimetres in depth, but the temperature produced there is estimated at about 850°C . (using coal-gas). Being operable in any position, the apparatus finds ready application to the evaporation of liquids, industrial heating, and domestic cooking, toasting, etc.

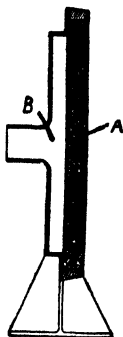


FIG. 1.

Section of Porous Diaphragm with Mixing Chamber at Back.

The coarseness or fineness of the diaphragm is graded to suit the quality and pressure of the gas employed. Generally speaking, with a rich gas a fine grade is used, while for poor gases and moderate temperatures a coarser grade only need be employed. The degree of porosity in all cases is such that the question of back-firing is almost out of consideration.

In the second and more important form of the apparatus, known as the "Cavity Cobble" or "Granular Bed," the diaphragm is replaced by a bed of granular refractory material, and it is then on the surface of these granules that incandescence occurs, rendering the whole bed of material a hot glowing mass. Thus in Fig. 2 is shown a muffle surrounded by refractory granules to which a mixture of combustible gas and air in their combining proportions is supplied through an aperture, the cross section of which is such that the speed of injection is in excess of the speed of inflammation of the mixture. The combustion in the bed of material is so rapid that very high temperatures are developed. The maximum naturally depends upon the working conditions, but temperatures in the neighbourhood of $1,500^{\circ}\text{C}$. in a muffle furnace can readily be attained.

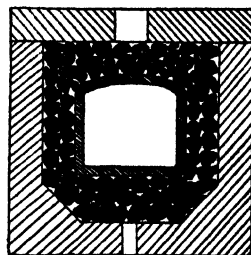


FIG. 2.—Diagram showing Arrangement for the Heating of a Muffle Furnace.

This latter method is clearly capable of a vast number of industrial modifications. The refractory material, in the form of a bed, may function as a hearth or a furnace; or it may be packed into tubes which are bodily immersed in water for steam-raising purposes, or in metals and alloys which it is desired to melt, etc. These and other purposes will be dealt with more fully later.

Observations Applicable to all the Modifications

Refractory Material.—For gases of low calorific value—blast-furnace gas, producer-gas, etc.—a large number of refractory materials are available, e.g., calcined fire-clay, ganister, etc. But where high temperatures are concerned, the choice of refractory material is limited. Indeed, the material practically determines the limit of temperature, for platinum can be melted and carborundum decomposed by this method. However, the best materials available for high-temperature work are carborundum and pure calcined magnesia, the use of both being subject to certain conditions. The selected material is used in the form of granules, meshed to a suitable size.

Porous diaphragms are made in one or two ways. Either fire-clay is mixed with finely-divided combustible material, such as fine seed or bran, and the latter then burned out, or burnt fire-clay is coarsely ground and meshed, and then mixed with a powder adapted to serve as a cementing material. Where a certain amount of form is necessary, a framework of wire is employed.

Gases.—It is one of the great advantages of the process that it is adapted for a large variety of combustible gases—blast-furnace gas, producer-gas, water-gas, coke-oven gas, coal-gas, petrol-air gas, natural gas, etc.

The combustible gas and air are delivered to the refractory material by two valved pipes, or by an adjustable injector or blower, or may be drawn through the apparatus by means of a fan.

The combustible gas and air should be as thoroughly mixed as possible, in order to reduce to a minimum two sources of heat loss, viz., that due to excess of air and that due to incomplete combustion.

To avoid the clogging of the pores of the refractory material, and the consequent necessity for its repeated renewal, it is advisable that the gases should be freed from dust before injection.

The air or the combustible gas, or both, may be heated before being delivered to the granular material.

Suitable devices for the prevention of back-firing are preferably incorporated with all apparatus.

Lighting Up.—The general method of starting the process is as follows: The combustible gas is first turned on and ignited; then air is introduced until the flame previously produced strikes back and the porous material is raised to a suitable degree of incandescence. The proportions of gas and air are finally adjusted to produce the desired conditions. Where a combustible gas of too poor a quality to admit of the above is employed, the bed of refractory material is previously raised to incandescence by using a richer gas or vapour.

Utilisation of Liquid Fuel.—Though, hitherto, the fuel employed in the surface combustion process has been in the gaseous or vaporous conditions, experiments are now in progress with a view to the burning of liquid fuel. The most practicable method so far has been found to lie in the atomising of the liquid fuel by the incoming air and the delivery of the mixture to the combustion bed. The difficulties arising from condensation on the walls of the pipes are overcome by delivering the mixture of liquid fuel and excess of air to the granular bed at or during the time of mixing the constituents. For the purposes of explanation, the modification necessary in the case of such a furnace, as is illustrated by Fig. 3, will be described.

The delivery end of the fuel supply pipe A is disposed within a very short distance of the lower face of the combustion bed, and the liquid is allowed to flow in by gravity or under pressure, air being supplied at a low pressure through the surrounding pipe B. The fuel, escaping in the form of a film, is broken up by the passing air, and is delivered to the furnace in a state of division. An atomiser may be employed instead, the fuel being sprayed by steam or compressed air. In all cases it is necessary to preheat the refractory bed by means of combustible gas. The arrangement just described may be applied to practically all the forms of "surface combustion" apparatus yet designed.

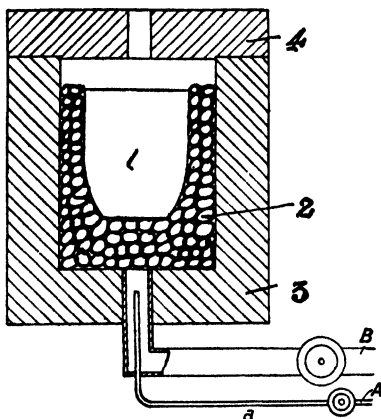


FIG. 3.—Utilisation of Liquid Fuel.

INDUSTRIAL APPLICATIONS

I. Steam Generation and the Heating of Liquids Generally

The most important commercial application of surface combustion is that of steam raising in multitubular boilers. At present the variations in the process are three in number.

(a) The first method consists of passing the mixture of combustible gas and air in suitable proportions, at a speed greater than that of ignition of the mixture, and under a pressure sufficient to overcome the resistance to gaseous flow, into contact with a bed of refractory granules disposed in tubes traversing the body of water to be converted into steam.

The boiler (Fig. 4) is constructed with tubes of iron or copper running lengthwise across it (or vertically if desired) in the manner of smoke tubes, each tube being packed with refractory granules. One end of each tube is closed with a plug of fire-brick through which is a passage for the entrance of the combustible gas and air, drawn in by a fan from a mixing chamber of special design on the front plate of the boiler. The mixture is ignited, and burns at or about the entrance of the tube, lined at this part with fire-brick.

The efficiency of the boiler may be increased by directing the escaping hot

products of combustion through return tubes, also filled with refractory granules ; or, as shown in the figure, the hot gases may instead be utilised for raising the temperature of the feed water by passage through similar packed tubes arranged in the feed-water heater. These devices serve the additional purpose of cooling down the products of combustion to a temperature at which they can be dealt with by the fan employed to suck the mixture through the boiler.

The variation in steam demands is effected either by valves on the tubes carrying the incoming gases, or by electrical or other control of the fan-motor, or by arranging the boiler tubes in groups which can be fired or stopped as required. By these means a wide variation of load can be dealt with within the limits of a percentage or two of efficiency.

The boiler tubes are usually about 4 ft. long and 3 in. internal diameter, and are fitted with a fire-clay plug of about 4 in. in length with a $\frac{1}{4}$ -in. diameter hole in the centre. Complete com-

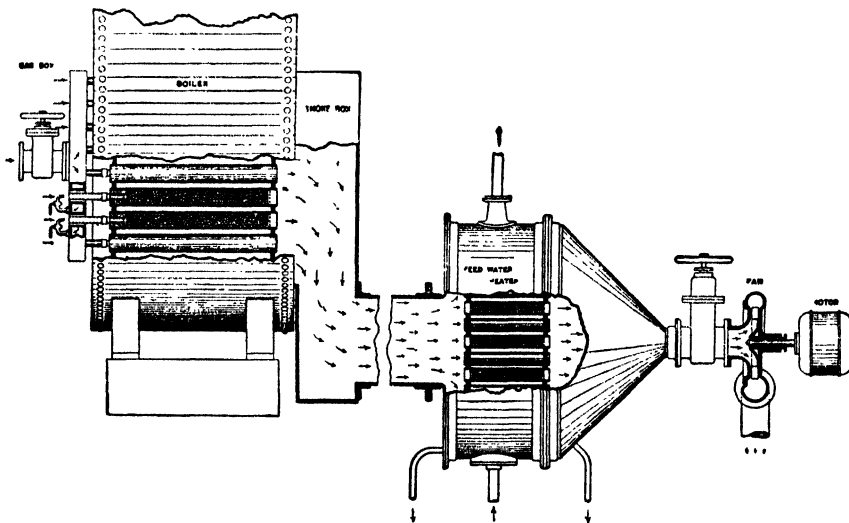


Diagram illustrating Bonecourt Combustion working with Suction Principle.

FIG. 4.

bustion takes place within about 6 in. to 1 ft. of the travel of the mixture, the remainder of the tube being useful for extracting the sensible heat of the products of combustion.

The rapid combustion develops a steep drop in temperature, and this causes a violent circulation of the water in the boiler, which is found to be unfavourable to sealing.

Test.—The details of a five hours' test upon a 110-tube boiler will furnish some of the details of the method, and give an idea of the high efficiency obtainable.

Average suction throughout apparatus	= 11 in. water gauge.
Temperature of water entering boiler	= 55° C.
" products leaving boiler	= 188° C.
" water entering feed-water heater	= 17.5° C.
" products leaving	= 90° C.
Gas metered, corrected to N. T. P.	= 40,162 cub. ft.
Calorific value of gas per cubic foot at N. T. P.	= 521 B. T. U.
Steam gauge pressure	= 98 lbs. per square inch.
Barometer	= 14.4 " "
Total absolute pressure	= 112.4 lbs. per square inch.
Dryness of steam	= 99.3 per cent.
Water evaporated	= 16,869 lbs.
Heat units in 1 lb. of wet steam	} = 1146.8 B. T. U.
Evaporated at 112.4 lbs. per square inch	
Efficiency	= 92.5 per cent. unlagged.
Power taken by fan equivalent to	110.3 lbs. of steam.
Nett efficiency of boiler and feed-water heater after deducting power required by fan	= 90.4 per cent. unlagged.

(b) In the second method, liquid or gaseous fuel is burnt in a combustion chamber situated within or in close proximity to the shell of the boiler. The products of combustion then pass through boiler tubes charged with the refractory material. The granular material facilitates the heat transmission through the walls of the tube to the surrounding water by mixing the gases in transit, by assisting the combustion of any fuel not fully burnt originally, and by radiating heat to the walls. The principle of the method is therefore similar to that of the feed-water heater of Fig. 3, though it is not the residual heat which is being extracted from the hot products of combustion, but the primary energy. This method lends itself particularly to the utilisation of the hitherto waste product of a gas engine.

(c) The third method applies to the firing of boilers of all kinds. Inside the flue of the boiler are laid down rails upon which run carriages carrying flat trays or hearths of fire-clay, fire-brick, or other suitable material. The floors of these trays are pierced by narrow apertures through which an explosive mixture is delivered at various points to a bed of refractory fragments on the hearth. Each supply pipe for the mixture is connected, as shown in Fig. 5, to a valved pipe for the combustible gas and a valved pipe for the air. The rails, preferably adjustable in height, are provided for the withdrawal at any time of the trays from the flue; and, to facilitate the discharging of the granular material for purposes of renewal, the trays are adapted for tipping. If, now, the combustible mixture be ignited on

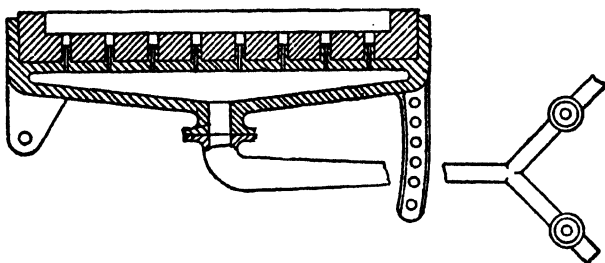


FIG. 5.—Arrangement of Heating Boilers.

the granular material, and the proportions of the constituents suitably adjusted, an incandescent hearth is produced which serves to heat the boiler. When flames are desired, the proportion of air in the mixture is reduced, and a further supply of air admitted to the flue to complete the combustion.

II. Melting of Metal and Alloys

Inside an asbestos-lagged tank is arranged a tube stopped at the bottom by a fire-clay plug and filled with fragments of refractory material. A small hole in the plug admits the combustible mixture, which is fed in through a down tube. If desired, only the packed tube may be employed, the products of combustion, instead of escaping from the top as in Fig. 6, being allowed to bubble through the liquid to agitate it. In either form the whole heating arrangement is readily withdrawn. The apparatus is especially useful for keeping metal in a molten state for galvanising purposes, or for the production of type-metal blocks, but can also be adapted for the evaporation of liquids, water heating for domestic purposes, and the concentration of solutions.

III. Production of Nitrogen and Carbon Dioxide

Recently a patent has been taken out for the commercial production of nitrogen and carbon dioxide by this process. The explosive mixture in the proper proportions for complete combustion is caused to burn in contact with a granular

incandescent solid, and the product, which contains none of the original products, is separated in a suitable way into its constituent nitrogen and carbon dioxide.

IV. Crucible Furnaces

A tilting crucible furnace is shown in Fig. 7, but no description is necessary, for the general arrangement is the same as that of the muffle furnace already mentioned.

V. Smith's Hearth

Here again the arrangement is evident, being that of the third method of steam generation above described.

The remaining applications are, like those of Figs. 7 and 8, merely variations of the preceding types, and as numerous other uses will occur to the reader, it is unnecessary to subjoin more, for no list could pretend to be exhaustive.

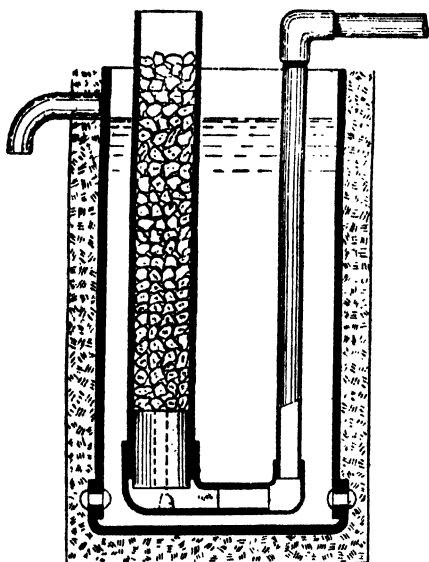


FIG. 6.—Melting Tank for Alloys.

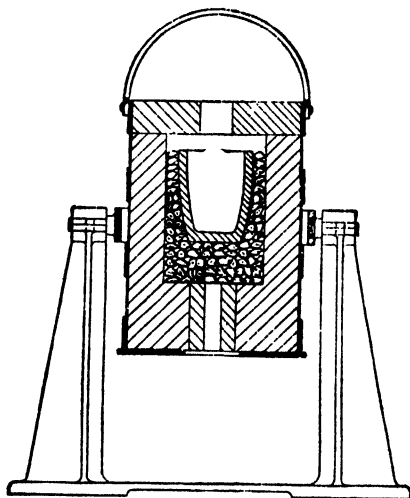


FIG. 7.—Crucible Furnace.

Advantages of the Method

The advantages claimed for this system are:—

1. The heat is generated within the mass of material to be heated, and consequently can be concentrated at any desired point.
2. The heat is emitted in the radiant form, which is superior to that transmitted by conduction from passing hot gas streams, in that it readily passes through the insulating "dead-gas" film clinging to the absorber.
3. The combustion is perfect with a minimum excess of air, which means that the loss of energy entailed by the escape of unburnt gases, or by the employment of a large excess of air, is almost eliminated. It also implies the complete absence of smoke.
4. The method is capable of absolute and easy control, whilst the personal element is reduced to a minimum.
5. Owing to the large amount of radiant heat developed, the transmission of heat from the seat of combustion to the object to be heated is very rapid, ensuring, among other things, no lag in the temperature response.

6. Very high temperatures can be obtained without the use of elaborate "regenerative" devices.

7. The development of incandescence is in no way dependent upon the outer atmosphere.

8. The various devices work well with any gaseous or liquid fuel, or even with waste gases.

9. The high efficiency renders the system very economical.

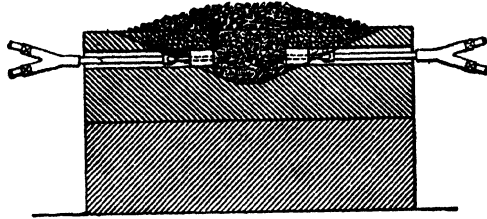


FIG. 8.—Smith's Hearth.

In the case of steam generation, undoubtedly the most useful application, still further advantages accrue. Thus the floor space is reduced as compared with coal, fuel boilers, for no brickwork setting is required. Also, no chimney stack is employed, since the necessary pressure difference throughout the system is maintained by the fan. Moreover, the boiler tubes are found to shed their scale in flakes as soon as formed, so that this source of trouble is diminished, if not even removed.

SECTION VII

PYROMETRY AND PYROSCOPY

BY ALFRED B. SEARLE

LITERATURE

C. H. DARLING.—“Pyrometry.” London, 1911.

G. K. BURGESS and H. LE CHATELIER.—“The Measurement of High Temperatures.” London, 1912.

See also *Ann. Repts. Soc. Chemical Industry*, 1933, 18, 22, 62.

The most valuable pyrometers are described in the catalogues of such firms as the Cambridge Scientific Instrument Co. Ltd., Cambridge. Much information contained in the older textbooks and copied into some modern ones is now almost obsolete.

THE measurement of higher temperatures than those for which mercury thermometers can be employed has made great strides within the past ten years, though even now there is a great need for a simple and accurate means of measuring the temperatures inside furnaces.

For temperatures below 360° C., mercury thermometers are generally the most convenient, and are obtainable in various forms for bakers' furnaces, etc., as well as in the ordinary patterns in general use and in chemical laboratories.

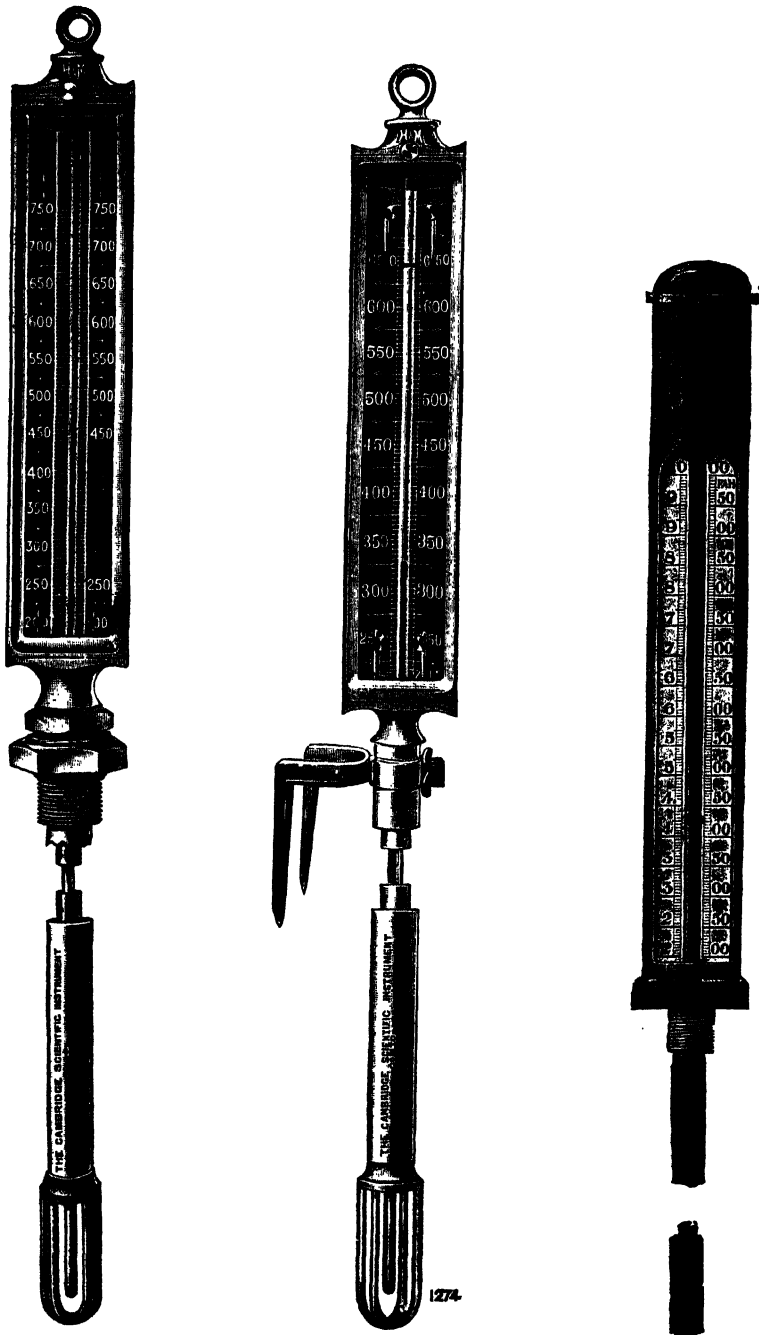
Figs. 1, 2, and 3 show ordinary mercurial thermometers such as are used for registering the temperatures of steam-pipes, bakers' ovens, etc. The glass bulb is usually protected by being enclosed in a steel chamber, usually filled with mercury or metallic packing.

Fig. 4 shows a steel tube mercury thermometer, the instrument consisting of a cylindrical steel vessel about 8 in. long, filled with mercury, and communicating by means of a capillary steel tube with the spring of a special type of steel tube pressure gauge. When the free end is exposed to heat the mercury expands, and imparts motion to the pointer of the gauge. By attaching a long flexible steel tube to the bulb, and a suitable recording mechanism, the varying temperatures may be continuously recorded by a pen on a dial.

Electric resistance pyrometers are also used extensively at low temperatures.

For temperatures below 600° C., instruments based on the difference in the expansion of two metals, such as iron and copper (Schaeffer and Budenberg's pyrometer), are convenient, but are too slow to be used for accurate work. Thermometers in which the liquid is an alloy of sodium and potassium may also be employed, also thermometers in which air or some gas (usually nitrogen) occupies a bulb, A (Fig. 5), its expansion moving a small column of liquid contained in a U-tube, B, D, outside the heated area. Such air thermometers are very sensitive and accurate up to the temperature at which the material of which the instrument is made becomes porous (with porcelain this is about 1,000° C.), but the heated portion must be as close as possible to the fluid which indicates its expansion, and the effect of a long intermediate tube is serious.

For temperatures of 500°-1,600° C., electrical thermometers are practically the only ones which give a direct reading of the temperature. These are of two types—those in which the variation of the resistance of a platinum wire to an electrical current is measured, and those in which the amount of current produced at the junction of a platinum wire with one of a platinum alloy is measured. In each case the measurement is a direct function of the temperature, and as electrical measurements can be made with great accuracy the temperatures may be measured



FIGS. 1, 2, 3.—Mercury Thermometers.

(Figs. 1 and 2 by courtesy of the Cambridge Scientific Instrument Co. Ltd.
Fig. 3 by that of Alex. Wright & Co. Ltd., Westminster.)

with equal exactitude. The **platinum resistance pyrometer** consists of a battery producing an approximately constant current, a galvanometer for measuring the resistance, and a wire (Fig. 6) (usually coiled) made of a metal of sufficiently high melting point to be resistant to the temperature to which it is to be exposed. This wire, being usually of a costly metal (like platinum), is connected to the other parts of the instruments by leading wires of copper. The coil is usually enclosed in a tube of porcelain or other refractory material to prevent it being damaged.

In one suitable method of using a **platinum resistance pyrometer**, the thermo element is placed in a furnace (Figs. 7 or 8) and is connected so that the temperature is read off on a "Whipple temperature indicator" (Fig. 9). This instrument must be connected to the pyrometer by means of four-way leads, which may be of any length desired.

To take a reading with it the key F is pressed and the movement of the pointer at A is observed. The

pointer will be deflected one way or the other, but by turning the handle H in the corresponding direction the pointer can be brought back to its zero position in the centre of the window A. When this is the case, the temperature can be read off directly from the scale in this window. The scale is extremely open, being divided every 1° C. on the standard temperature scale from -10° to +1,200° C. The necessary current is obtained from the two dry cells E, so that the instrument is entirely self-contained. Where preferred, a recorder (Fig. 8) may replace the indicator.

For medium and low temperatures the platinum coil of a resistance pyrometer may advantageously be replaced by one of nickel and iron.

The **thermo-electric pyrometer** is simpler to use, as it does not require a battery, but as the amount of current produced by heating the junction of the two metals is only feeble, the measuring instruments have to be of very delicate construction, and are only suitable for high temperatures.

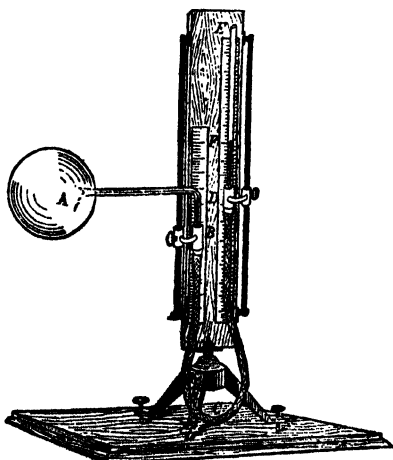


FIG. 5.—Air Thermometer.

usefulness depends on no part of the instrument being exposed to the temperature to be measured, and this, at the same time, constitutes their chief liability to error. These optical pyrometers are of various patterns, but three types are in fairly general use: (a) The **absorption pyrometers** in which the light emitted by the heated substance is received in a polariscope, and the angle through which the polariser must be turned to produce a characteristic neutral

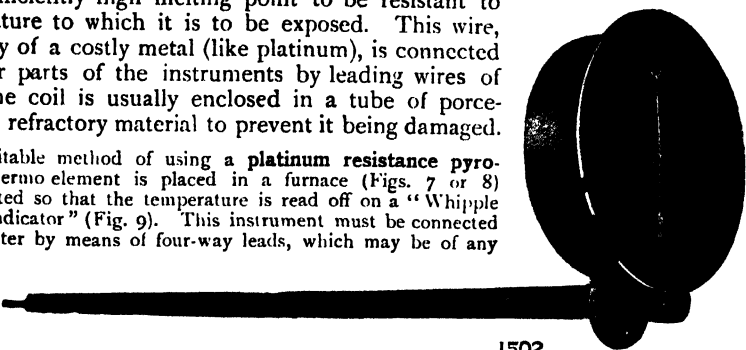


FIG. 4.—Baker's Oven Thermometer.
(Cambridge Scientific Instrument Co. Ltd.)

Fig. 7 shows a method of measuring the temperature of a furnace by a thermo-electric recording pyrometer.

Both platinum resistance and thermo-electric pyrometers are accurate to 1/10° C. at 1,000° C., if properly managed, though in many works an accuracy of even 5° C. is considered sufficiently accurate, and somewhat less sensitive instruments may then be used. These instruments can both be made self-recording by providing the measuring instrument with a rotating roll of paper on which to record the measurements of temperature at various intervals of time. They are, however, too sensitive to be used by rough workmen, and they require to be standardised from time to time.

For temperatures above red heat, optical pyrometers offer several advantages, as they can be made without any limit to the highest temperature reached. Their

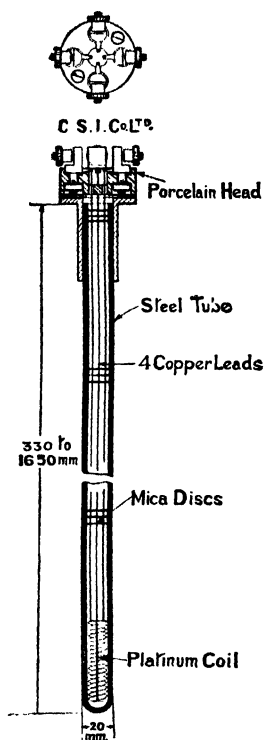


FIG. 6.—Thermo-Element of Electric Resistance Pyrometer.

(Cambridge Scientific Instrument Co. Ltd.)

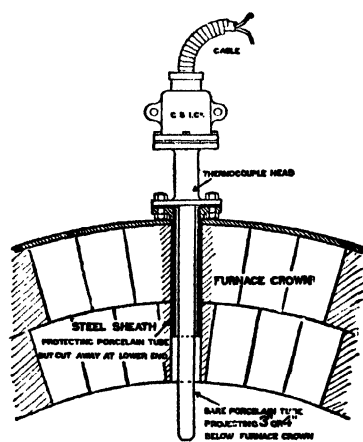


FIG. 7.—Thermo-Element in Furnace.
(Cambridge Scientific Instrument Co. Ltd.)

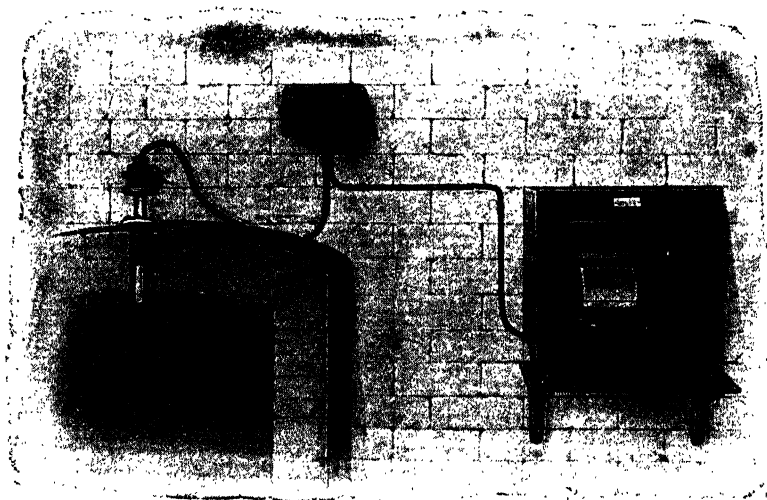


FIG. 8.—Recording Pyrometer in Use in Furnace.

(Cambridge Scientific Instrument Co. Ltd.)

tint is measured; (b) **photometric pyrometers**, in which the light from the heated object is compared with that from a standard lamp, by noting the relative distances of the object and the lamp from the eye of the observer when the light



FIG. 9.—Whipple Temperature Indicator.
(Cambridge Scientific Instrument Co. Ltd.)

from each appears to be of equal intensity. Another form consists of a series of cells through which the hot body is viewed. The light is absorbed more or less completely, and the temperature indicated is the mean between two cells, one of which absorbs all the light and the other does not.

In the **Cornu-Chatelier** instrument the lamp burns pentane, and is provided with a red screen so as to make the light monochromatic.

Fig. 10 shows the instrument. Two telescopes, *ML* and *MA*, are placed at right angles, *MA* being for observing the body, and *ML* for viewing the standard lamp. In front of the object glass of the observing telescope *MA* is an adjustable diaphragm or stop *e*. *O* is the eye-piece, which is covered with a monochromatic red glass screen. The rays from the standard lamp *L* are reflected by the mirror *M* into the eye-piece *O*, so that the two sources of light are viewed together as two bright spots, one of which will usually be brighter than the other. Next, the diaphragm or stop *e* is adjusted until the two spots look equally bright; the size of the opening in the diaphragm is read off, and the corresponding temperature is obtained from a table supplied with the instrument.

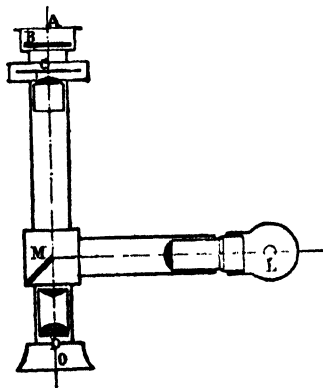


FIG. 10.—Cornu-Chatelier Optical Pyrometer.

In the **Wanner** pyrometer an electric lamp is used in combination with a set of prisms, so that what is actually compared is the polarised light from the object and from the standard light, the angle through which the analyser is rotated in order to make these two lights appear to be of equal intensity being a measure of the temperature. (c) The **Féry radiation pyrometer**, in which the heat radiations are received on a delicate thermo-couple. This instrument resembles

the thermo-electric pyrometer previously mentioned (p. 67), but instead of the junction being placed inside the furnace, it is kept outside, and only the radiation from the hot substance is allowed to act on it. It has been proved repeatedly that these radiations are directly proportional to the temperature, and are unaffected by the distance of the pyrometer within large limits. This is due to the use of a concave mirror, which brings the radiations to a focus, at which the junction of the thermo-couple is placed. This instrument can be employed for any temperature above the darkest visible red, and it is claimed by M. Féry to be more accurate than those in which the radiation is compared with a standard lamp, as the heat radiations and not those of light are measured.

Fig. 11 shows a workman taking the temperature of a gas retort furnace with a Féry radiation pyrometer, while Fig. 12 shows the same instrument mounted for taking the temperature of a pottery kiln. Fig. 13 shows a multiple switch whereby twelve parts of the same furnace or refrigerator or twelve different kilns may be connected to the same indicator. A test-plug to ensure the accuracy of the instrument is also included on the switchboard.



FIG. 11.—Use of Féry Pyrometer to take Temperature of Furnace.

From Fig. 11 it will be seen that the pyrometer consists of a telescope mounted on a tripod and connected by leads to a millivoltmeter.

A section through the instrument is seen in Fig. 14. The heat rays *A* from the furnace fall on the concave mirror *C*, and are brought to a focus at *s*. Looking through the eye-piece *E*, this image of the furnace is seen in the small mirror *M*, and by turning a screw-head attached to the pinion *F*, can be exactly focussed on any part of the furnace whose temperature is required, a special optical device, explained later, being employed for this purpose. A small sensitive thermo-couple *s*, which is situated just behind a small hole in the mirror *M*, is therefore heated, and delivers a current to the millivoltmeter, which is usually calibrated to read directly the temperature of the body at which the telescope is pointing.

The focussing arrangement is carried out by means of two small semicircular mirrors fixed inside the telescope, and the observer, looking through the telescope, sees the reflection of the furnace or hot body in these mirrors, the two half-images coinciding when the instrument is correctly focussed. The sensitive element of the pyrometer must be exactly covered by the image of the sighted body.

Turning a screw-head attached to *F* (Fig. 14) causes the upper and lower half-images to slide on one another, so that it is easy to get the exact focus.

Where the temperature of parts of the furnace are required which cannot be got at by opening doors or making an opening in the wall, a cast-iron or fire-clay pipe about 4 ft. long is built into the furnace (see Fig. 15), the tube being closed at the end *A* which is inside the furnace, and

open at the other end. The end of the tube A takes up the temperature of the furnace, and on sighting the pyrometer on the blind end A the temperature is ascertained without allowing any cold air to find its way into the furnace, or flame to come out.

A slightly cheaper and more portable but less sensitive instrument is **Féry's spiral pyrometer**, in which the radiations are received on a small spiral composed of two different metals. The difference in the relative expansion of these two metals is made to operate an indicator. Though this instrument is useful for rough indications, the electric radiation pyrometer should be used for accurate work

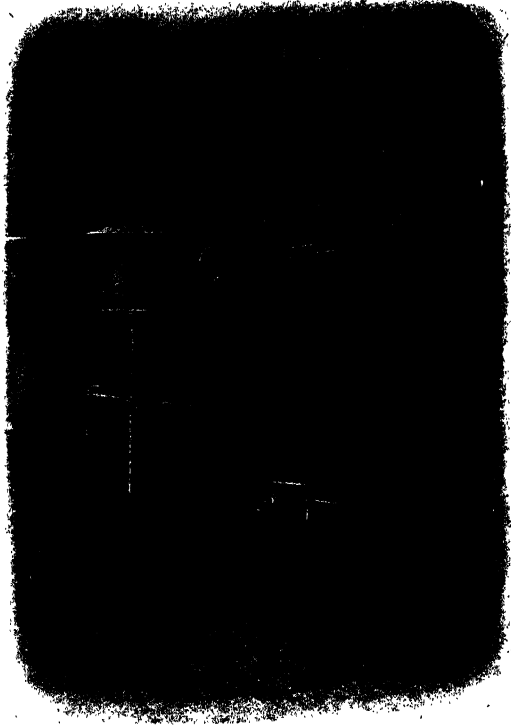


FIG. 12.—Féry Radiator Pyrometer in Use at a Pottery Kiln.

(Cambridge Scientific Instrument Co. Ltd.)

The method of receiving the radiant heat in this instrument, and focussing it to form a heat image, which covers a sensitive element in the telescope, is exactly the same as for the Férr electric pyrometer, but instead of using a thermo-couple connected to a graduated millivoltmeter outside the instrument, a very small bi-metallic spiral is used which controls the movements of a pointer over a dial marked directly in temperature degrees, the instrument being thus self-contained. The spiral is shown in Fig. 16. It is built up of two dissimilar metals, rolled flat and very thin, and coiled into a spiral shape. The one metal expands at a different rate to the other, which causes the spiral to uncoil as the temperature rises.

The reason why the Féry pyrometers are **independent of distance** is due to the fact that so long as the heat image formed by the concave mirror in the telescope is large enough to completely cover the sensitive element, then the element is really measuring the intensity of the heat image, and not the total heat reflected, and it is a law of optics that this intensity is independent of the distance. For example, if the distance of the telescope from the hot body is doubled, then the total amount of radiant heat received by the concave mirror is reduced to a quarter (law of inverse squares), but the area receiving this heat, *i.e.*, the optical image, is simultaneously reduced to a fourth, so that the actual heat intensity of the image remains the same.

Pyrosopes are instruments which show the effect of heat rather than the actual temperature, and usually consist of substances of known melting points.

Serious errors are sometimes made when attempting to compare the indications of pyrosopes with those of the pyrometers just described, because of failure to recognise that these pyrosopes do not register temperature.

The simplest pyrosopes are thin strips of metal which are placed in the furnace in positions where they will not be acted upon chemically by the gases or contents of the furnace. As each elementary metal has a definite melting point, it is reasonable to suppose that if any given metal has not been melted when placed in the kiln or furnace, the temperature at which it melts has not been attained.

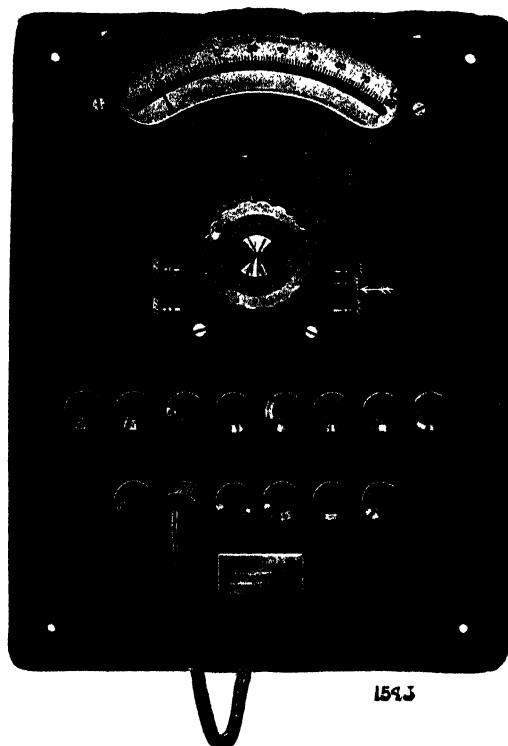


FIG. 13.—Multiple Switch for Resistance Pyrometers.
(Cambridge Scientific Instrument Co. Ltd.)

Various considerations affect the matter, and whilst such an indication may be sufficient for some purposes, it cannot be used for accurate work. Thus the influence of time is an important factor, and the melting temperature of the metal may have been reached, but it may not have been maintained for a sufficient time for the test metal to be melted. Moreover, it is extremely difficult to prevent oxidation and other changes occurring in the metals used.

Sentinel pyrosopes consist of alloys whose melting point under favourable conditions is known, and are useful for temperatures between 200° and 1,000° C. Small pieces of these alloys are placed on porcelain saucers in various parts of the furnace; those that melt indicate that the temperature exceeding their melting point has been reached. In this way the maximum temperature may be known within a range of about 20° C. For temperatures from 700° to 2,000° C., **Seeger cones** are the most useful pyrosopes. They consist of china clay mixed with various fusible materials, such as felspar, or with marble, which combines with the

clay and makes it more fusible. These materials are made into tetrahedra about $2\frac{1}{2}$ in. high, with a base about $\frac{1}{2}$ in. across its widest part, and when heated to the temperature they are supposed to indicate they bend over and eventually collapse, owing to the partial fusion of their mass. The critical point is usually taken as that at which the apex has bent over until it comes almost on a level with the base, *i.e.*, between cone 1 and cone 2 in Fig. 17.

Under some conditions these cones give a useful indication of temperature, but no one has insisted more than Seger himself that what they measure is the heat effect of certain treatment,

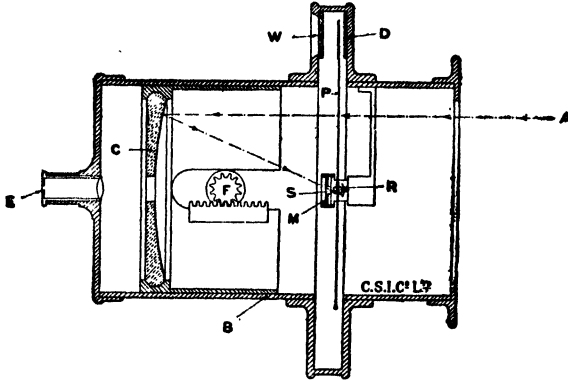


FIG. 14.—Section through Fery Radiation Pyrometer.
(Cambridge Scientific Instrument Co. Ltd.)

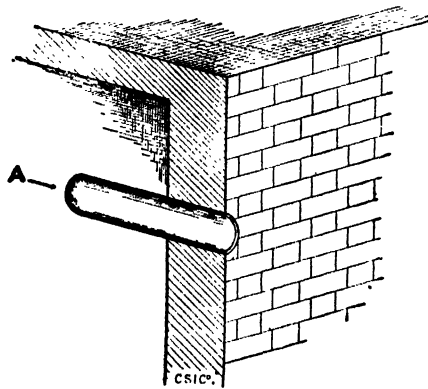


FIG. 15.—Fire-Clay Pipe in Furnace.
(Cambridge Scientific Instrument Co. Ltd.)

and not the effect of temperature alone. If, for instance, a Seger cone indicating $1,000^{\circ}\text{C.}$ is maintained for an excessively long time (at least forty-eight hours are needed) at a temperature of 900°C. , and is then subjected to a higher temperature, it will not bend until a temperature of $1,200^{\circ}\text{C.}$ is reached, on account of the volatilisation of some of its contained alkali. On the other hand, if the temperature is reached too rapidly, it may be found that a cone corresponding to $1,150^{\circ}\text{C.}$ is bent, whereas the actual temperature may not be much above $1,000^{\circ}\text{C.}$ Such behaviour does not show that these pyrosopes are inaccurate, but merely that the information which they give must be fully understood if their indications are to be relied upon.

Holdcroft's thermoscopes resemble Seger cones in many respects, but are supported horizontally instead of being kept vertical. Their critical point is indicated by the bar sagging in the centre (Fig. 18).

Pyrosopes are often of much greater value than direct measurements of temperature in industrial operations, for they show exactly what is required to be known, namely, the effect of the heat

treatment ; they are extensively used in many industries, and have proved highly beneficial for all cases in which their indications have been sufficiently understood.

A special form of pyroscope used in the pottery and allied trades consists of what are known as "trials"; these consist of a small piece of clay covered with a suitable glaze. The trials are placed in various parts of the kiln, and a suitable number is withdrawn at intervals ; if the trial piece is glossy, and the glaze is clear, a sufficiently high temperature has been reached in that part of the kiln ; if not,

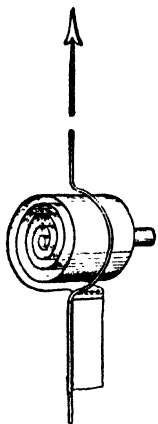


FIG. 16.
Féry Spiral (4 times
natural size).

(By courtesy of the Cambridge Scientific
Instrument Co. Ltd.)

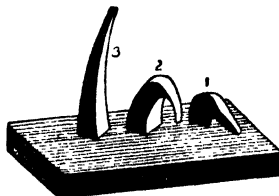
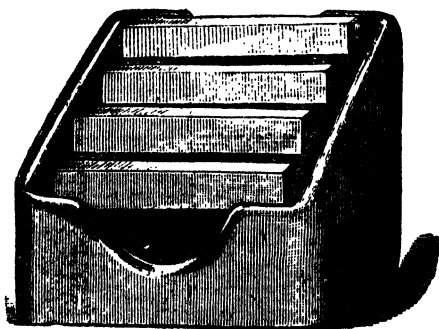
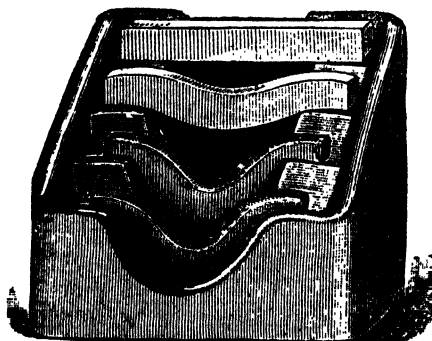


FIG. 17.—Seger Cones.



Before using.



After using.

FIG. 18.—Holdcroft's Thermoscopes.

the heating must be continued. The composition of the glazes used depends on the conditions it is desired to obtain within the kiln ; in most cases there is some clear relation between the glaze on the trials and that on the goods, but this is by no means essential. Another special form of pyroscope used in the Potteries is one devised by Wedgwood (Fig. 19) ; it consists in placing small pieces of a suitable clay in the kiln, and withdrawing these one at a time as the heating of the kiln proceeds. The drawn "bits" are allowed to cool, and are then measured by means of a specially designed scale, when the amount of shrinkage they undergo is taken as some indication of the conditions existing inside the kiln. Such an instrument does not indicate the temperature, but merely the effect of the heating on the

clay of which the "bit" was made, but it has long served as a useful indication, the simplicity of which causes it to be used extensively, even though its defects are now recognised more clearly than they were by the great potter who invented it. A modification of this device is useful in other industries where the effect of prolonged heating or annealing cannot well be determined without such an aid, though the tendency in works at the present day is to use electrical pyrometers of the self-recording type.

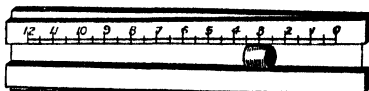


FIG. 19.—Wedgwood's Pyroscope.

Where an approximation of the temperature of a very hot substance is desired, and no pyrometers or pyroscopes are available, it is sometimes possible to apply the method of mixtures which forms the essential features of **Siemen's water pyrometer** (Fig. 20). This consists of a can with double walls to reduce the loss by radiation. In the can is placed a known quantity of water, the temperature of which is carefully ascertained by means of a sensitive thermometer. A small piece of iron, copper, or other suitable metal is placed in the furnace alongside the body whose temperature it is desired to measure, and when the two are at the same temperature, the cylinder is lifted out and carefully yet very rapidly dropped into the can of water. The water is stirred with the thermometer, and its temperature, when steady, is noted. The heat lost by the cylinder is the product of its weight, specific heat, and fall in temperature. This is exactly equal to the heat gained by the water, which is equal to the weight, specific heat, and rise in temperature of the water. From these factors an equation can be constructed, and the temperature of the hot cylinder when in the furnace can be calculated.

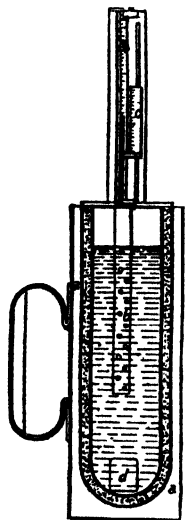


FIG. 20.—Siemen's Pyrometer.

This method is complicated by a variety of losses, for all of which allowances must be made, so that it is exceedingly difficult to get reliable results; it is, however, useful, in the absence of more convenient appliances, in spite of its inaccuracy.

Krupp has adopted the same principle in a pyrometer devised for estimating the temperature of blast-furnace gases.

In Krupp's instrument the hot gas passes into a special form of injectors where its pressure is measured; it there draws in a definite quantity of air, with which it mixes and becomes cool enough for its temperature to be measured with a thermometer. It is, however, both more convenient and more accurate to use an electric pyrometer.

There is great scope for an accurate pyrometer for temperatures between 900° and 1,800° C. at a price not exceeding £2 or £3, provided that such an instrument really indicates temperatures and not heat effects, and that it is not too delicate to be placed in the charge of workmen, and without the necessity for frequent and skilled calibration. For some purposes Féry's spiral pyrometer is the nearest to the ideal instrument, but it is far too costly. Electrical pyrometers are, generally speaking, admirable except for two reasons—they are too delicate, and cost too much to be used in the large numbers which modern conditions render desirable in

many works. The absorption pyrometers formed of two or more cells containing liquids of different intensities of colour are convenient, but are open to the objection that they measure radiation, of light rather than of heat, and it is the latter which are really required.

Precautions.—Pyrometers are very delicate instruments and the following precautions are important :—

1. Frequent calibration is essential or serious errors may arise.
2. Zero-point pyrometers or potentiometers are often more satisfactory for industrial use than thermo-couples and resistance thermometers in simple circuit.
3. In taking the temperature of gases a suction-pyrometer is advisable in order to minimise the error due to radiation from the walls. A quartz tube, in which the pyrometer is placed central and through which the gases are sucked, is a satisfactory form.
4. The pyrometer must be placed in such a position that its indications are of real significance. If placed in the path of a flame or near the crown of a furnace it may be unable to give any indication of the temperature of the goods or materials being heated.

SECTION VIII

REFRIGERATING AND ICE- MAKING MACHINERY

BY GEOFFREY MARTIN, D.Sc., Ph.D.

LITERATURE

See Industrial and Engineering Chemistry, June 1932.

- A. J. WALLIS-TAYLOR.—“Refrigeration, Cold Storage, and Ice-Making.” London, 1912.
 A. EWING.—“Mechanical Production of Cold.” London, 1908.
 J. W. ANDERSON.—“Refrigeration.” London, 1908.
 H. WILLIAMS.—“Mechanical Refrigeration.” London, 1903.
 A. R. LEASK.—“Refrigerating Machinery.” London, 1895.
 N. SELFE.—“Machinery for Refrigeration.” Chicago, 1900.
 J. E. SIEBET.—“Mechanical Refrigeration.” Chicago, 1903.
 G. T. VOORHEES.—“The Absorption Refrigeration Machine.” Chicago, 1911.
 H. LORENZ.—“Neuere Kühlmachines.” Munich, 5th Edition, 1913.
 R. STETEFELD.—“Eis u. Kälteerzeugung's Maschinen.” Stuttgart, 1912.
 G. BEHREND.—“Eis u. Kälteerzeugung's Maschinen.” Halle, 1900.
 E. REIF.—“Kühlmaschinen f. Kriegs- u. Handelsschiffe.” Wittenberg, 1912.
 M. COOPER.—“Practical Cold Storage.” Chicago, 1905.
 L. M. SCHMIDT.—“Artificial Ice-Making and Refrigeration.” Philadelphia, 1908.
 M. J. DE LOVERDO.—“L'industrie du Froid en France.” Paris, 1910.
 United States Patents 1,878,276, 1,879,893, and 1,817,983.
 D. BURKS.—*Univ. Ill. Eng. Exp. Stat. Bull.*, 1933, No. 253.

ARTIFICIAL cold is used industrially: (1) **To stop or greatly diminish chemical and physiological change**, e.g., for preserving meat, food, etc., in slaughter-houses, butcher shops, food factories, etc. The frozen meat trade of New Zealand, Australia, and South America depends upon artificial cold, for (together with dryness) cold is one of the best agents for preventing the development of bacteria and fungi in perishable foods. In Continental breweries artificial cold is used for cooling the fermenting wort and also the maturing beer.

(2) **To aid the progress of certain chemical changes**, e.g., oils are cooled (see *Martin's "Industrial Chemistry: Organic"*) in order to separate solid paraffin and stearin; glauber salt, $\text{Na}_2\text{SO}_4 \cdot 7\text{H}_2\text{O}$, is separated from a strongly cooled solution of magnesium sulphate, MgSO_4 , and common salt, NaCl .

(3) Air is often artificially cooled in theatres, hospitals, and dwelling-rooms.

(4) To remove moisture from the air forced into the furnaces used in iron making.

(5) For freezing quicksands when sinking shafts in engineering operations

Formerly the only method of producing cold was by use of natural ice or snow. However, as supplies of these commodities are difficult to obtain in summer, artificial ice is now manufactured solely by refrigerating machines; breweries and slaughter-houses usually employ, however, not ice, but cooled brine or calcium chloride solutions, which are cooled to -10°C . (and below), and circulated through the beer-cellars and slaughter-houses by means of a system of circulating pipes. At the present time the use of ice for artificially cooling large rooms has been abandoned in favour of cooling by pipes conveying strongly cooled salt solutions. Sometimes the air of the rooms is directly cooled by passing through refrigerating machines.

Compression Refrigerating Machinery.—Artificial cold is now almost invariably produced by the evaporation of a volatile liquid. An easily condensable gas is compressed by a pump until it liquefies. The liquid is then allowed to gasify again by the suction action of a pump. In evaporating to a gas, the liquid abstracts large amounts of heat (its heat of evaporation) from a surrounding solution of salt, thereby causing a considerable lowering of temperature.

Almost invariably anhydrous ammonia (NH_3) is the substance used, although carbon dioxide, CO_2 , and (very seldom) sulphur dioxide, SO_2 , are employed to some

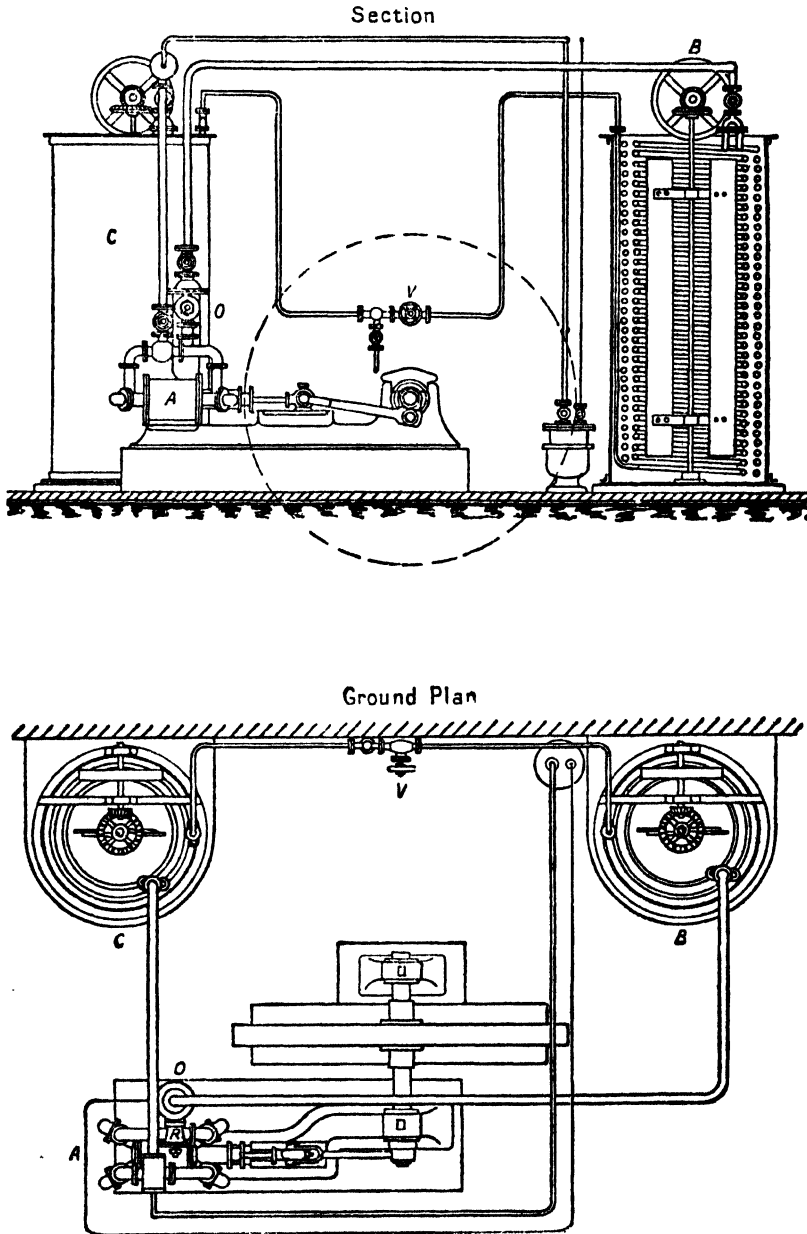


FIG. 1.—Compression Ammonia Refrigerating Plant.

extent. Ammonia is favoured mainly on account of the large amount of heat absorbed in turning from liquid to gas.

Fig. 1 is a diagrammatic sketch of a "compression" ammonia plant, designed by Linde.

A is the compressing pump ("compressor"), B the "condenser," and C the "refrigerator." The pump A forces the anhydrous NH_3 into the condenser B, where it is surrounded by a stream of cold water, and there liquefies under the pressure. The liquid NH_3 flows through the valve V into the "refrigerator" C containing the liquid to be cooled (usually brine). Here the liquid NH_3 gasifies again, owing to the lower pressure caused by the suction action of pump A; in gasifying great cold is produced and the salt solution in C surrounding the coils is thereby greatly cooled, sometimes to -7° or even to -20°C . A much higher pressure prevails in the condensing coils in B than in the evaporating coils in C, the connection between the two pressures being regulated by the expansion valve V.

The pump A is usually a double-action, suction, and pressure pump, provided with four valves, through one pair of which ammonia gas is sucked in, and through the other pair simultaneously expelled in a highly compressed condition, this occurring with each rotation of the driving wheel. This pump is usually driven by a steam engine, gas engine, or similar source of power, either by direct coupling or by means of bands, etc. In this apparatus both the condenser and the refrigerator consist of several iron coiled tubes welded together without flanges or other joints. The condenser coils are immersed in cooling water contained in a tank B; the water is kept agitated by means of a stirring arrangement, and serves to take up the heat developed in compressing and liquefying the ammonia. The evaporating coils (refrigerator) are contained in a similar tank C filled with a saturated brine or calcium chloride solution, which can be cooled from -10° to -20°C ., without solidification taking place. This strongly cooled salt solution is pumped away from C through a second system of pipes (not shown in figure) arranged throughout the place to be cooled. The cooled brine, after traversing these pipes and so producing the required cooling effect, finally pours back into C once again, is once more cooled and pumped forth again.

In German breweries sometimes the wort itself is used as the cooling liquid.

When ice is to be made the refrigerator coils dip into a rectangular tank filled with a concentrated brine or calcium chloride solution, which is kept in steady motion by means of a stirring arrangement. Into this tank dip a number of boxes, made of thin galvanised sheet iron, which are filled with water. The water contained in these "ice cans" soon freezes, and the solid blocks of ice are obtained by removing the ice cans, dipping them for an instant into warm water (which melts ice adhering to the sides) and then dumping out the block of ice contained therein. The sheet-iron ice vessels are placed in and withdrawn from the refrigerating tank by means of cranes, or similar machinery.

The physical properties—principally the boiling point, the latent heat of evaporation and the heat of liquefaction—decide the fluid chosen as the working substance of refrigerating machines. However, the substance must be inert chemically, and not attack the metallic pipes, pumps, etc. Anhydrous CO_2 and SO_2 do not attack metals, whereas anhydrous ammonia, NH_3 , attacks copper in the presence of oxygen, but has no action on iron. Ammonia plants, therefore, are made solely out of iron.

The following figures give the vapour tensions of liquid NH_3 , CO_2 , and SO_2 , as determined by Lorenz :—

VAPOUR TENSION IN ATMOSPHERES = KILOGRAMS PER SQUARE CENTIMETRE

Temperature.	NH_3 .	CO_2 .	SO_2 .
° C.	Atmospheres.	Atmospheres.	Atmospheres.
-20	1.90	20.3	0.65
-10	2.92	27.1	1.04
0	4.35	35.4	1.58
+10	6.27	45.7	2.34
+20	8.79	58.1	3.35
+30	12.01	73.1	4.67
Boiling Points - -	- 32° C.	-78° C.	-8° C.
Critical Temperatures -	+136° C.	+31.4	...

From this table it will be seen that if the temperature in the condenser is 20°C ., the pressure of the liquid ammonia is 8.79 atmos.; if 30°C . the pressure is 12.01 atmos. In the refrigerating coils at -10°C ., the pressure of the ammonia would be 2.92 atmos., while at -20°C . the pressure would be 1.90 atmos.

With sulphur dioxide, SO_2 , machines the pressures are much less, while with

carbon dioxide, CO_2 , the pressures are very great, although in modern engineering practice these pressures do not cause serious difficulties.

The latent heat of evaporation and also the specific heat of the above-mentioned liquids vary very considerably with the temperature. In the case of the ammonia plant it must be remembered that the **available heat absorption** corresponds to the **heat of evaporation** of the liquid (at the average temperature of the refrigerating coils—*e.g.*, about -10°C .) less the heat required to cool the liquid ammonia from the temperature of the **condensing coils** (*e.g.*, $+20^\circ \text{C}$.) to that of the refrigerating coils (-10°C).

The following table gives the **cold** obtainable per cubic metre of compressor cylinder space per kilo of liquid evaporated to 1 cub. m. of vapour (at -10°C .):—

	NH_3 .	SO_2 .	CO_2 .
Latent heat of evaporation per kg. at -10°C .	322.3 cal.	93.4 cal.	61.5 cal.
Heat absorbed per kg. in cooling the liquid from $+20^\circ \text{C}$. to -10°C .	27.5 ,,	9.8 ,,	17.8 ,,
Cold producible per kg. at -10°C .	294.8 ,,	83.6 ,,	43.7 ,,
Weight of each cub. m. of gas at -10°C .	2.32 kg.	3.04 kg.	69.9 kg.
Cold producible per cub. m. (-10°C .)	at 2.92 atmos. 683 cal.	at 1.04 atmos. 254 cal.	at 27.1 atmos. 3,055 cal.

It will be seen, therefore, that for equal amounts of cold production, the SO_2 will require the largest compressor cylinder and the CO_2 the smallest.

An average ammonia compression machine, cooling brine to -7°C . (20°F .), driven by a steam engine using 7 kg. of steam per I.H.P., will abstract 316 cal. per kilogram of steam (B.T.U.).

As regards the theory of refrigerating machines it will be noted that the working gases undergo a cycle of changes, returning after certain series alterations of temperature, pressure, and volume,

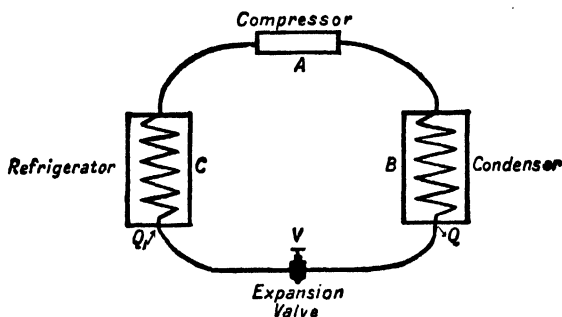


FIG. 2.

back to their original condition. Referring to Fig. 2 the heat Q_1 absorbed in the refrigerator by the evaporation of the liquid into gas is obviously equal to the heat Q evolved in the condenser by the condensation of the same amount of vapour to liquid (this heat being given up to the cooling water), less the amount of heat Q_2 corresponding to the work done by the compressor in compressing the vapour to the pressure required to condense it to liquid—

$$\text{i.e., } Q_1 = Q - Q_2, \text{ or } Q = Q_1 + Q_2.$$

A refrigerating machine is simply a reversed heat engine, which takes in heat Q_1 from a body below the normal temperature and imparts it to a hotter body (*i.e.*, the cooling water of the condenser). The second law of thermodynamics asserts that this can only be brought about by the expenditure of mechanical work, which is changed into heat. This work Q_2 is done by the **compressor**, and the smaller the amount of work Q_2 expended in abstracting the quantity of heat Q_1 , the greater the efficiency of the machine. The greatest theoretical efficiency of a refrigerating machine is given by the equation—

$$\text{Efficiency} = \frac{\text{Heat absorbed}}{\text{Work done}} = \frac{Q_1}{Q_2} = \frac{T_1}{T_2 - T_1}.$$

Where Q_1 is the quantity of heat taken in at the lower absolute temperature T_1 , Q_2 =the amount of work done by the compressor in abstracting this heat, T_2 the higher absolute temperature at which this heat is given out to the cooling water of the condenser.

The following table gives the coefficient of efficiency for several temperature differences:—

Temperature ° at which Heat is Abstracted.	Temperature ° at which Heat is Rejected.					
	10° C.	15° C.	20° C.	25° C.	30° C.	35° C.
- 20° C.	8.43	7.23	6.32	5.63	5.06	4.61
- 15° C.	10.32	8.61	7.38	6.45	5.74	5.16
- 10° C.	13.15	10.51	8.77	7.52	6.57	5.85
- 5° C.	17.86	13.4	10.72	8.93	7.66	6.70
- 0° C.	27.30	18.2	13.65	10.92	9.10	7.80
- 5° C.	55.60	27.8	18.53	13.90	11.12	7.29

For example, a refrigerating machine abstracting heat at - 10° C. from brine and giving it up at + 10° C. to the cooling water, has a maximum theoretical efficiency of 13.15, *i.e.*, by expending one unit of mechanical work (expressed as calories) we abstract 13.15 cal. from the brine.

In practice, however, such an efficiency is never realised, because work must be expended in agitating the cooling water of the condenser and in driving the cooled liquids through the pipes, etc., also losses occur through defective valves, etc.

In general it is found that 1 H.P. applied per hour will abstract 2,000 cal., corresponding to the formation of about 20 kg. of ice (latent heat of ice = 79 cal.).

Absorption Machines.—These are the oldest ice-producing machines, and are still used to some extent. In the ammonia absorption machine a concentrated solution of aqueous ammonia is heated in a chamber called the “generator,” and the gaseous NH_3 thus expelled is condensed by its own pressure to a liquid state in another chamber called the “condenser.” A third chamber containing a cold aqueous solution of salt or calcium chloride is now put in communication with the liquefied ammonia in the “condenser.” The latter is rapidly absorbed, and the liquefied ammonia evaporates, thereby producing cold. The solution of ammonia thus obtained is now once more heated, and the NH_3 expelled, and the latter is once more absorbed in aqueous salt solution. The process is thus continuous and no compressor is needed. When the external temperature is high, as in the tropics, only a small amount of energy is necessary to work the plant.

One kilo of steam supplied to the regenerator will abstract about 280 cal. from the refrigerator, when cooling brine to - 7° C. (20° F.), and using cooling water at 15.5° C. (60° F.).

In Carré and Winhausen’s “vacuum ice machine” water is caused to rapidly evaporate by evacuating the chamber in which it is contained and absorbing at the same time the evolved vapour in concentrated sulphuric acid; about 80 per cent. of the water is thereby converted into ice. This machine—only capable of producing ice—is now seldom met with.

Cold Air Machines.—These abstract heat by first compressing air (or other gas), cooling the compressed air, and then allowing it to expand, thereby producing cold. For example, if air is compressed suddenly (without allowing any heat to escape) to 3 atmos., a temperature of 100° C. is attained.

Suppose now this hot compressed gas is cooled by cooling water, and then allowed to expand to atmospheric pressure in a fluid vessel, a cooling effect of - 100° C. will be produced.

For economical use all moisture should be mechanically extracted from the compressed air before expansion, otherwise the valves of the machine block up with frozen moisture. Cole’s Patent “Arctic” cold air machine is stated to be successful. Windhausen and Bell-Colemann’s machines are also well known. It is stated that these machines require a much greater cylinder space for the production of a given degree of cold than do “compression” machines, and so cannot compete with the latter type of engine. However, within recent years great improvements have been made in cold air machines.

SECTION IX

THE LIQUEFACTION OF GASES,

Including the Manufacture of Oxygen,
Nitrogen, and Hydrogen from Liquefied GasesLIEUT. JOHN M. DICKSON, B.Sc. (Lond.), *Chemical Engineer*

LITERATURE

HORDING.—“ Rise and Development of the Liquefaction of Gases.”

SLOANE.—“ Liquid Air and the Liquefaction of Gases.”

EWING.—“ Mechanical Production of Cold.”

TRAVERS.—“ Study of Gases.”

CLAUDE (translated by Cottrell).—“ Liquid Air, Oxygen, and Nitrogen.” See also
Zeit. Angew. Chem., 1930, 43, 47.

KAUSCH.—“ Die Herstellung, Verwendung und Aufbewahrung von Flüssiger Luft.”

THE following are the chief patents:—

English.—*Aumont*, 11,306, 1911. *Bobrick*, 25,829, 1908. *Claude*, also *Soc. L'air Liquide*, 12,905, 1900; 28,682, 1903; 26,435, 1905; 27,658, 1902; 29,733, 1906; 12,358, 1904; 17,216, 1909; 7,305, 1910; 16,298, 1903; 20,349, 1907; 7,175, 1910; 3,302, 1907; 3,326, 1911; 22,316, 1909; 11,710, 1907; 5,395, 1909. *Cases*, 18,386, 1911. *Code and Knudsen*, 19,838, 1901. *Dumars*, 11,126, 1903. *Flüssige Luft Heylandt*, 16,615, 1909. *Goldschmidt*, 12,743, 1908. *Hampson*, 10,165, 1895; 7,559, 1896; 7,773, 1898. *Hazard and Flamand*, 26,720, 1908; 27,592, 1908; *Hers*, 21,191, 1901. *Hildebrandt*, 11,212, 1905; 13,790, 1907; 25,517, 1907; 6,515, 1909; 13,034, 1907; 26,186, 1907; 3,316, 1910; 15,999, 1910; 19,336, 1910; 1,828, 1907. *Jänecke*, 23,107, 1909. *Joly*, 21,861, 1899; 12,918, 1901; 15,511, 1901. *Knudsen*, 23,646, 1902; 6,087, 1903; 19,033, 1906. *Lake*, 11,609, 1902. *Leptien*, 2,497, 1910. *Leslie*, 11,902, 1906. *Levy*, 16,615, 1902; 5,649, 1903. *Levi and Hellbronner*, 20,053, 1902. *Linde*, also *Ges. für Linde Eismaschinen*, 12,528, 1895; 14,111, 1902; 11,221, 1903; 7,205, 1911; 9,260, 1911. *Lilienfeld*, 22,930, 1911. *Loumet*, 17,605, 1902. *Marks*, 25,829, 1908. *Merves*, 24,144, 1905; 21,780, 1906. *Ostergreen and Burger*, 26,361, 1898. *Parkinson*, 4,411, 1892. *Pictet*, 14,303, 1903; 2,713, 1901; 19,254, 1900; 21,120, 1902; 14,431, 1904; 27,463, 1910. *Place*, 11,609, 1902; 13,529, 1907; 3,685, 1908. *Ramsay*, 26,981, 1907. *Roettger*, 7,858, 1910. *Schneider*, 2,496, 1910; 11,461, 1910. *Schmidt*, 13,304, 1909; 6,515, 1909. *Siemens*, 2,064, 1857. *Strong*, 9,142, 1900. *Sueur*, 10,722, 1900; 4,828, 1901. *Thrupp*, 26,767, 1898; 1,913, 1900. *Tofehn*, 21,085, 1898. *Tripler*, 15,235, 1899. *Wiart*, 26,052, 1907.

German.—*Blau*, 223,843. *Chemische Fabrik Greisheim-Elektron*, 240,876. *Claude*, also *Soc. L'air Liquide*, 173,276, 177,519, 179,950, 192,594, 193,008, 202,778, 234,308, 235,422, 237,438. *Drägerwerk*, 179,793. *Flüssige Luft Heylandt*, 191,659. *Hecker*, 204,807. *Hildebrandt*, 169,331, 179,132, 181,115, 183,410, 193,007, 197,071, 198,503, 214,264, 223,064, 228,487, 229,345, 247,581, 249,996.

Jänecke, 220, 270, 246, 341. Lachmann, 167, 931. Levy, 191, 916. Levi Cases, 243, 031. Levi and Hellbronner, 158, 838. Linde, also *Ges. für Linde Eismaschinen*, 88, 824, 173, 260, 180, 014, 203, 814. Metz, 119, 943. Merves, 174, 362, 179, 782, 195, 754, 199, 035, 209, 074, 209, 848, 222, 840, 227, 100, 229, 276, 230, 002, 233, 897, 238, 690, 242, 867, 249, 997, 251, 584. Mix, 124, 376, 142, 918. Pictet, 162, 323, 162, 702, 165, 268, 159, 934, 164, 382, 169, 359, 178, 246, 169, 564, 200, 053. Solway, 39, 280. Thrupp, 115, 421, 142, 935. Tripler, 135, 728.

French.—Aumont, 427, 266. Bobrick, 399, 416. Claude, also *Soc. L'air Liquide*, 296, 211, 299, 051, 328, 245, 352, 856, 322, 107, 324, 097, 370, 850, 381, 790, 338, 842, 416, 556, 401, 496, 410, 967, 322, 702, 324, 460, 329, 839, 338, 964, 423, 224, 376, 270, 381, 866. Dumars, 332, 662. Hellbronner, 376, 154. Hildebrandt, 355, 206, 373, 894, 384, 139, 403, 630, 420, 903, 417, 537. Jänecke, 407, 852. Joly, 318, 153. Levy, 328, 770, 330, 258. Levi Cases, 433, 639. Levi and Hellbronner, 328, 984. Linde, also *Gesell. für Linde Eismaschinen*, 312, 811, 322, 811, 333, 205. Merves, 360, 427, 358, 236, 425, 546, 426, 908. Pictet, 322, 600, 295, 002, 324, 715, 409, 787. Place, 321, 860, 379, 605, 391, 326. Roettger, 413, 958. Schneider, 416, 122. Thrupp, 307, 941.

Andrews, in 1868, found that each gas has a "critical temperature" above which it was unliquefiable whatever the pressure. It is only necessary, in order to liquefy the "permanent gases," to find this "critical temperature" and go below it.

The commercial realisation of this was due to Carl Linde, who in 1895 inaugurated a system which to-day shares with the Claude system practically the monopoly of the liquid air industry.

Theoretical Considerations.—The production of extreme cold in modern processes is obtained by the expenditure of mechanical work, namely by compressing a gas or vapour, and then allowing it to expand in such a manner that owing to the cooling produced it will absorb heat from the substance to be cooled.

When a gas is allowed to expand from a volume v_2 to a volume v_1 against an external pressure, the gas performs external work—

$$\int_{v_2}^{v_1} p \, dv,$$

which results in the abstraction of an equivalent amount of heat from the gas or its surroundings.

There should, however, be no heating or cooling of a perfect gas on free expansion, i.e., when no external work is performed. Kelvin and Joule, however, found that air, oxygen, nitrogen, and carbon dioxide were all cooled on free expansion, the cooling being most noticeable in the case of carbon dioxide, the least perfect of these gases. This cooling is explained by the fact that internal work is performed during the separation of the molecules, which occurs during the expansion of the gas. In the case of hydrogen a small heating effect was noticed, but it is now known that hydrogen, on expansion, is cooled like any other gas, provided the temperature is below a certain value. The fall in temperature in degrees Centigrade in the case of air on free expansion was given by Thomson and Joule as:—

$$0.276 (p_2 - p_1) \left(\frac{273}{T} \right)^2,$$

where T is the initial absolute temperature of the gas, and p_2 and p_1 the pressures before and after expansion. Thus the fall in temperature of air expanding at ordinary temperature (15°C.) from 100 atmospheres to atmospheric pressure is about 25°C.

Emil Vogel has recently shown¹ that as the pressure increases, the cooling per atmosphere drop decreases, so that at ordinary temperatures the limit is reached if the pressure is raised to about 300 atmospheres. The formula expressing the cooling effect is given as

$$dt = (0.268 - 0.00086p) \left(\frac{273}{T} \right)^2 dp.$$

The Principle of the Temperature Exchanger.—The fall of temperature of 25°C. , due to a fall in pressure of 100 atmospheres (see above), is of course entirely inadequate for the spontaneous production of liquid air, the boiling point of which at atmospheric pressure is -193°C. In modern

¹ "Über die Temperaturveränderung von Luft und Sauerstoff" Berlin, 1910.

practice, therefore, the principle of the *temperature interchanger* is applied. The essence of this principle, first suggested by Wilhelm Siemens in 1857, is as follows:—

The compressed air passes through the tube A (Fig. 1) into the expansion apparatus B, where it is consequently cooled. The expanded and cold air passes out by means of the tube C concentric

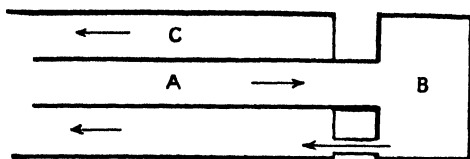


FIG. 1.—Temperature Interchanger.

with A, and thus cools the ingoing compressed air. A cumulative fall in temperature therefore results, which theoretically is only limited by the actual production of liquid air. By this means it is ensured that when the expanded air escapes into the atmosphere it is only slightly inferior in temperature to that of the compressed air entering the exchanger. In good modern exchangers the difference in temperature between the ingoing and escaping air is only 3° or 4° C.

Types of Air-Liquefying Machines.—Liquid air appliances are divided broadly into two groups—(1) those, such as the Linde and Hampson systems, which depend on *internal work*, i.e., on the Joule-Thomson effect, and (2) such as the Claude process, which is a solution of the problem of expansion with *external work*.

1. The principle of machines depending on *internal work* is as follows:—

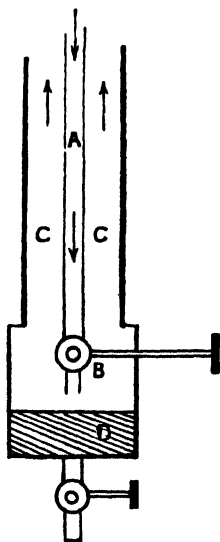


FIG. 2.—Principle of Machines depending on Internal Work.

The air, compressed to a high pressure and freed from moisture and carbonic dioxide by circulating through purifying tubes, is allowed to pass by means of a tube A (Fig. 2) (in reality in the form of a long thin spiral) to the valve B, where expansion by simple outflow takes place. Cooling takes place according to the Joule-Thomson effect, and the cooled air is led back through a tube C concentric with A, and finally is discharged into the atmosphere or back to the compressor. Owing to the exchange of heat from the compressed to the expanded air, the temperature of expansion

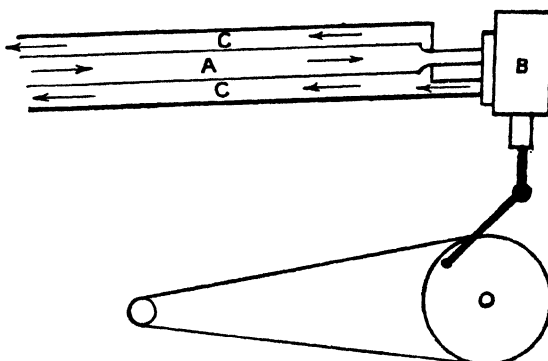


FIG. 3.—Principle of Machines depending on External Work.

is rapidly lowered, until finally the temperature of liquid air at the pressure to which the air expands is reached. From this moment some air will liquefy at the expansion valve and will collect in vessel D.

2. The second method of liquefaction, i.e., that depending on *external work*, is an application of the suggestion made by Lord Rayleigh in 1898, that if the simple expansion described above were effected against the vanes of a turbine, by

thus utilising external work done by the expanding gas an increase of efficiency would result.

In actual practice the compressed air is delivered through a pipe A (Fig. 3) to the expansion machine B, which in this case is a compressed air motor working against an external resistance. The expended air returns to the compressor by means of the tube C concentric with A. By this means the gas on expansion performs external work against the external resistance, thus regaining a large proportion of the work employed in compression, and, theoretically at least, there should be a large increase in efficiency.

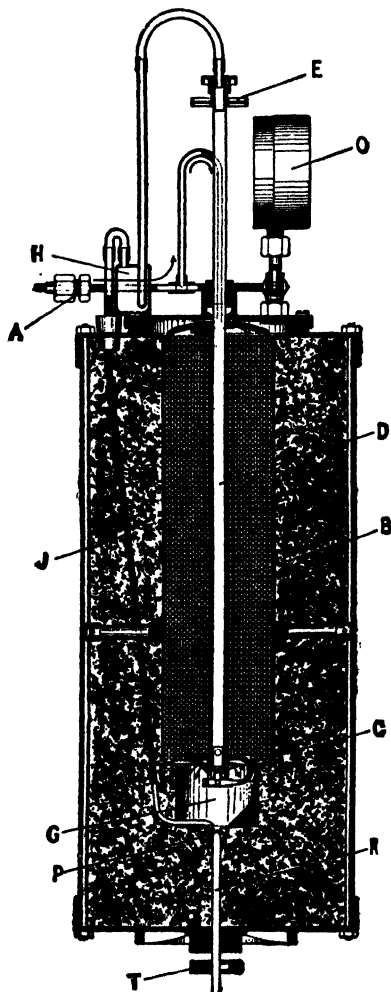


FIG. 4.—Hampson's Apparatus. Section (British Oxygen Co.).

It is of the utmost importance in all liquid air appliances that the air supplied be purified and dried as perfectly as

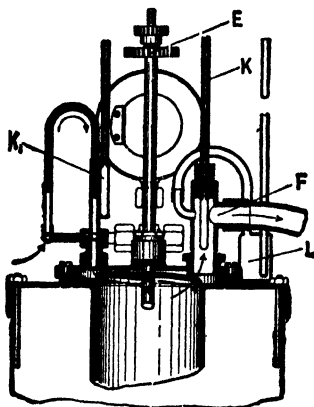


FIG. 5.—Hampson's Apparatus. Details of Upper Part. Section at Right Angles to Fig. 4.



FIG. 6.



FIG. 7.

Hampson's Apparatus. View of Expansion Coils from above (British Oxygen Co.).

possible. It can easily be seen that the least trace of impurity or moisture slowly accumulating and condensed in the liquefying apparatus will be fatal in a short space of time by causing a blockage of the tubes.

Hampson's Apparatus.—This apparatus, although only a laboratory appliance and of low efficiency, has the merit of simplicity and handiness. It begins to liquefy air after ten minutes' working, and produces about a litre of liquid air per hour with an expenditure of 6 H.P. on the compressor.

Figs. 4, 5, 6, 7 give sectional views of this liquefier. Air is drawn into a compressor through a purifier containing slaked lime, which removes carbon dioxide. The compressed air at a pressure of about 200 atmospheres then passes through a vessel in which most of the water picked up in the

compressor is separated out, and afterwards through caustic potash, which removes the last traces of moisture and carbon dioxide.

The purified compressed air passes through the inlet A into the regenerator coils B. It travels down the coils, and escapes at the valve C, which is regulated by a hollow spindle D, provided with a hand wheel E. The air expanded down to atmospheric pressure passes back over the regenerator coils, and escapes by the pipe F (Fig. 5) back to the compressor. After about ten minutes' working, liquid air collects in the receiver G, and can be run off through the tube R by opening the valve P by means of the handle T.

The outlet air pressure is indicated by the glycerine gauge L, while a pressure gauge O registers the pressure of the compressed air. K and K₁ are thermometers indicating the temperatures of outgoing and incoming air.

The liquid receiver holds about 100 c.c. The level of the liquid in it is shown by the small gauge H, which communicates with the receiver by means of a pipe J and the hollow spindle D.

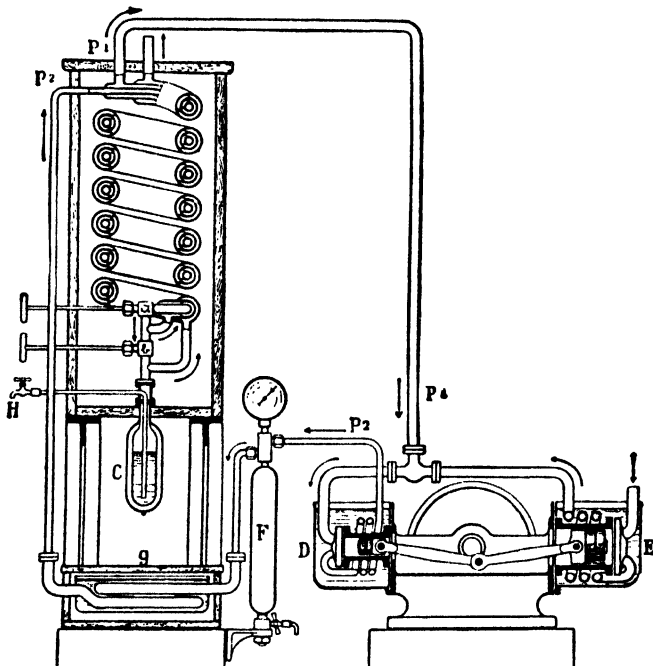


FIG. 8.—Linde's Apparatus for Liquefying Air. Laboratory Type.

When liquid air collects in the receiver G, it compresses the air in the pipe J, and so displaces the coloured liquid in the gauge glass H.

All the cold parts are carefully protected against the penetration of external heat by a thick covering of insulating material.

The advantage of this apparatus, which is absolutely practical and used in a large number of laboratories, is its extreme simplicity, there being only one gauge to watch and one valve to control. It is sold by the British Oxygen Co.

The Linde Process.—In this process, the expansion of the compressed gas takes place by simple outflow. Fig. 8 gives a diagrammatic representation of the laboratory type of Linde machine.

The compressor takes air from the atmosphere, and first compresses it to 40 atmospheres in E, and further to 200 atmospheres in D. The compressed air passes first into the iron bottle F, where most of the moisture and impurities are deposited, then through a coil *g*, placed in a refrigerating mixture, where it is cooled and deprived of the rest of its moisture by solidification. The dry compressed air then passes through the pipe P₂ into the inner tube of the temperature exchanger, which is in the form of three concentric spiral tubes. Expansion down to 40 atmospheres takes place at the needle valve *a*, which is regulated by a cock. The expanded and thereby cooled air returns by means of the middle tube of the temperature exchanger and the pipe P₁ to the compressor, where it

is again compressed to 200 atmospheres. Progressive cooling is thus produced until a sufficiently low temperature is attained to liquefy some of the air expanding through the valve *a*. This liquid is allowed to pass at intervals through the valve *b* into the vessel *c*, where the pressure is atmospheric. This fall in pressure of the liquid produces a considerable evaporation, and therefore the evaporated gases are caused to pass through the outer tube of the exchanger into the atmosphere, thus ensuring that on their exit into the atmosphere all their cold is given up to the incoming compressed air. The amount of liquid air in the container *c*, which is in the form of a double-walled vacuum vessel, gradually increases, and can be run off through a tap *h*. The whole of the exchanger is covered by a wooden casing, filled with sheep's wool lagging, to prevent the entrance of heat from the surroundings.

A machine of this type producing 50 litres per hour requires 2 H.P. per litre, and begins to produce liquid after about ninety minutes' working. The following table indicates the increase in efficiency produced by the initial cooling of the compressed gas:—

Output, litres per hour	With previous cooling - -	0.5	1.25	2	3	5	10	20	50	100
	Without previous cooling - -	5.5	12.5	35	70
Power used, H.P.	- - - - -	3.5	5.5	8.5	12	19	30	52	105	190
Cooling water used, litres per hour	- - - - -	250	400	600	850	1,400	2,300	3,800	8,000	15,000

This cooling in the smaller machines is obtained by a refrigerating bath as shown above, which also solidifies the moisture and thus dries the air. In the larger machines an ammonia compressor is used to cool the air, which is first dried by passing over calcium chloride. Such an installation is shown in Fig. 9.

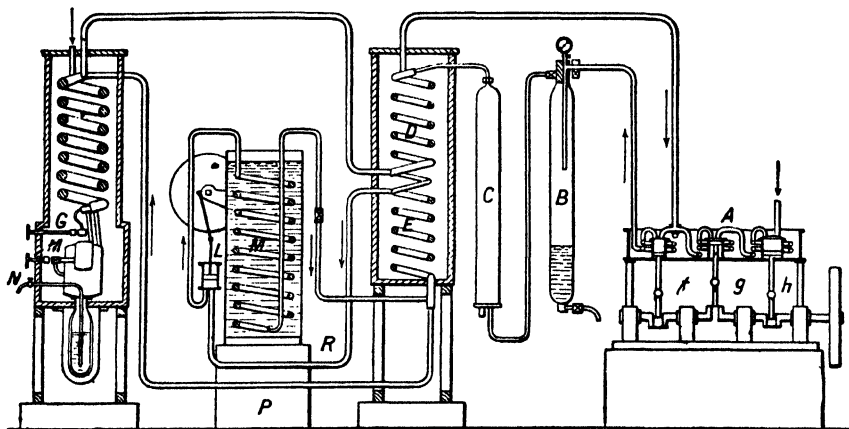


FIG. 9.—Linde Process—Large Installation.

(From Claude's "Liquid Air, Oxygen, and Nitrogen." Translated by Cottrell, and published by J. & A. Churchill, London. Reproduced with kind permission.)

For large installations a three stage compressor is used. The air compressed to 200 atmospheres in the high pressure cylinder *f* loses most of its moisture in *B* and is completely dried over calcium chloride in *C*. It then passes through the inner tube of the cooler *DE* by means of the pipe to the inner tube of the exchanger *F* which has been described above, p. 87. The air at about 50 atmospheres coming from the middle tube of the exchanger *F* is passed through the outer tube in the top half of the spiral cooler *D*, thus producing a preliminary cooling of the compressed air, and so to the compressor where it is again compressed to 200 atmospheres. The auxiliary cooling is effected by an ammonia compressor *L*. The compressed ammonia is cooled and liquefied in the water bath *M*. The liquid ammonia expands through the outer tube of the cooler *E*, thus cooling the compressed air passing to the exchanger *F*. The expanded gaseous ammonia is then returned to the ammonia compressor through the pipe *N*.

Carbon dioxide is removed from the air by passage over lime or caustic soda.

Recently Professor Linde has used another method of desiccating the air by means of cold. The rime is condensed in the exchangers which are changed over every twenty-four hours, thus allowing the apparatus to work continuously for twelve days or more.

Theory of the Linde Process.—In the case of the expansion of a perfect gas by simple outflow without sensible velocity from a pressure p_1 to a pressure p_2 , the work done is always against the pressure p_2 , and thus the work involved in the expansion is—

$$\int p dv = p_2 \int dv = p_2 v_2,$$

where v_2 is the expanded volume.

From a consideration of Boyle's Law it can be shown that this work is not translated into cooling.

Air, however, is far from being a perfect gas, and instead of assuming that the relation of temperature, pressure, and volume is given by Boyle's Law, viz., $p v = RT$, where P_1 is a constant, the facts are far more closely expressed by Van der Waals' equation—

$$\left(p + \frac{a}{v^2} \right) (v - b) = RT,$$

where a , b , and R are constants.

If, therefore, an imperfect gas expands from a volume v_1 to a volume v_2 , the work done due to internal pressure of the molecules is—

$$\int_{v_1}^{v_2} p dv = \int_{v_1}^{v_2} \frac{a}{v^2} dv = \frac{a}{v_1} - \frac{a}{v_2}.$$

If, as is the case, practically the volume v_2 is great compared to v_1 , the "internal work" due to expansion is $\frac{a}{v_1}$.

A full consideration of the problem shows that the whole practical cooling effect or expansion by simple outflow is due to this external work.

This conclusion is somewhat modified in practice by the fact that the compressed gas before expansion first passes through the temperature exchanger, but a complete analysis of the facts supports the view that the whole cooling effect depends on the state of the compressed air at entry to the exchanger, the cooling effect being equivalent to $\frac{a}{v_1}$, where v_1 is the volume of the gas at the entry to the exchanger. In order to increase the yield the quantity $\frac{a}{v_1}$ should be increased as much as possible. Obviously in order that v_1 shall be small the pressure of the gas before expansion must be high. This is the case in the Linde process, the air being compressed to about 200 atmospheres. A considerable increase in efficiency is obtained by expanding down only to about 50 atmospheres instead of right down to atmospheric pressure, for as by this means the work of compression from 50 to 200 atmospheres is far smaller than is the case from 1 atmosphere to 200 atmospheres the cooling effect on expansion in the two cases is practically the same. Thus the work of compression from a pressure of 1 atmosphere to 200 atmospheres is proportional to $\log \frac{200}{1} = 2.3$, whereas the work of compression from 50 atmospheres to 200 is proportional to $\log \frac{200}{50} = 0.6$ only.

Linde, therefore, expands from 200 to 50 atmospheres, the expanded gas being returned to the compressor at this pressure.

As the cooling effect depends on the state of the gas at entry to the exchanger, an increase in efficiency is also obtained by cooling the compressed gas before it enters the exchanger, thus decreasing v_1 and increasing the value $\frac{a}{v_1}$. The Linde process actually employs an auxiliary cooling machine which cools the gas after compression, and before passing into the exchanger.

The Claude Process.—In 1902, after several years of experiment, Claude first liquefied air by allowing compressed air to expand in an ordinary compressed air motor, thus producing extreme cooling effects due to the external work done by the expanding gas on the piston of the motor.

One of Claude's greatest difficulties during his work was the lubrication of the moving parts of the machine when at the low temperatures attained. This difficulty was at first obviated by the use of petroleum ether, which at these low temperatures acts as an excellent lubricant. When the

machine was started up, ordinary lubricating oil was used, this being gradually mixed with increasing quantities of petroleum ether as the temperature fell. In 1912, however, Claude succeeded in abolishing all lubrication by the use of suitably prepared leather stampings on the working parts. This leather was found to retain its ordinary properties at these low temperatures, and required no lubrication whatever.

Claude's first attempt met with ill-success, owing to the fact that, as air becomes more and more imperfect as the temperature decreases, he was obtaining only a slight expenditure of external work due to the expansion of the cooled gas. This imperfection is also enhanced by the increase of specific heat of air with decrease of temperature, which limits the fall of temperature due to the expansion.

The solution of this difficulty was found in slightly raising the initial temperature of expansion. Claude's method of obtaining this result is shown in Fig. 10.

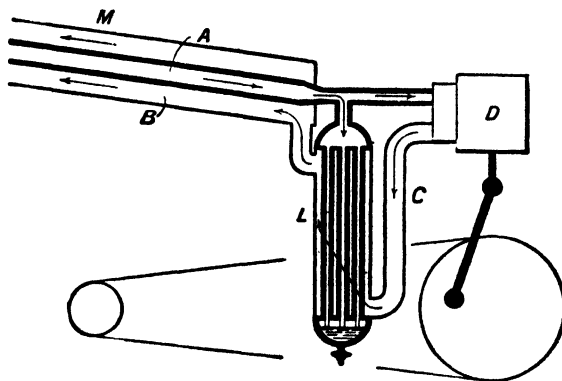


FIG. 10.—Claude Process.

(Reproduced from Claude's "Liquid Air, Oxygen, and Nitrogen," with kind permission of the publishers, Messrs J. & A. Churchill.)

The compressed air at a pressure of 40 atmospheres passes through the inner tube A of the exchanger M to the expansion machine D. The expanded and cooled air then passes upwards round the outside of the tubes of the liquefier L. These tubes are supplied with the compressed air at 40 atmospheres from the tube A. This compressed air is thus progressively cooled by the expanded gases circulating upwards until the temperature of liquefaction at 40 atmospheres, viz., about -140°C ., is attained. Liquefaction then commences in the bottom of the liquefier from which it can be run off by means of a cock. The expanded gas passes round the tubes of the liquefier and thus attains the temperature of liquefaction of the compressed gas; it then passes into the outer tube B of the exchanger, and thus cools the incoming compressed gas, which, therefore, reaches the expanding machine at this temperature. In this way it is ensured that the initial temperature of expansion does not fall so low that the gas becomes too imperfect to produce liquefaction. In order that this temperature should remain at the desired height the liquid formed in the liquefier must be run off at intervals.

In more recent machines (see Fig. 11) the advantages gained by the above procedure are increased by the method of compound liquefaction in which the expansion takes place in two stages. The compressed air passes through the tubes of the exchanger into the first expansion machine. The partially expanded gas then circulates round the top part A of the liquefier tubes which are fed with compressed gas by means of the tube s. On leaving the top of the liquefier the partially expanded gas undergoes a second expansion in c_2 , on exit from which it flows round the bottom half of the tubes of the liquefier, then by means of the outside tubes of the exchanger M back to the compressor. The liquid formed in the tubes of the liquefier collects in the vessel D. The compound expansion machine is arranged with the two expansion cylinders on the same shaft, using a single piston, thus obviating difficulties due to leaks on the high pressure cylinder.

TABLE OF OUTPUT OF CLAUDE MACHINES.

Output. Litres per hour.	H. P. used.
5	15
50	60
65	75

The advantages of the Claude process are :—

1. The use of comparatively low pressures of the compressed gas.
2. Short time necessary to attain the temperature of liquefaction.

Consequently the process is increasingly in favour.

The Separation of the Constituents of Liquid Air.—The basis of the separation of the elements of air by the method of liquefaction was first suggested by Parkinson in 1892 and depends on the difference in their volatility, the boiling points under atmospheric pressure being -182.5°C . for oxygen and -195.5°C . for nitrogen. The problem, therefore, is not very different from the separation of a mixture of alcohol and water, although the simple fractional evaporation of liquid air gives very poor yields, and it was not until Linde in 1902 utilised the method of rectification that the process became one of commercial importance.

The following table of Linde's experimental results gives the composition of the liquid and gaseous states as liquid air slowly evaporates.

Per Cent. Liquid Evaporated.	Per Cent. Oxygen in Liquid Phase.	Per Cent. Oxygen in Gaseous Phase.	Per Cent. Oxygen Left in Liquid.
0	23.1	7.5	100
50	37.5	15.0	80
70	50.0	23.0	65
80	60.0	34.0	52
85	67.5	42.0	43
90	77.0	52.0	33
95	88.0	70.0	19

From this it will be seen that in ordinary evaporation to obtain an oxygen residue of 50 per cent. purity, 70 per cent. of the liquid must be evaporated with a loss of 35 per cent. of the total available oxygen.

Similar results were obtained by Baly in 1900.

Temperature.	Per Cent. Oxygen in Liquid.	Per Cent. Oxygen in Vapour.	Temperature.	Per Cent. Oxygen in Liquid.	Per Cent. Oxygen in Vapour.
-195.46	0	0	-188	72.27	44.25
-195	8.10	2.18	-187	77.80	52.19
-194	21.6	6.8	-186	82.95	60.53
-193	33.35	12.0	-185	87.60	69.58
-192	43.38	17.66	-184	91.98	79.45
-191	52.17	23.60	-183	96.15	89.80
-190	59.55	29.93	-182	100	100
-189	66.20	36.80			

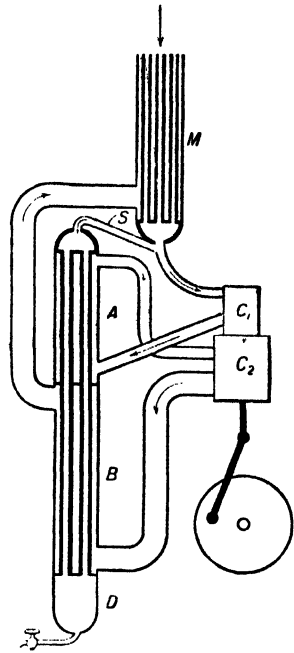


FIG. 11.—Claude Process, with Expansion in Two Stages.

(Reproduced from Claude's "Liquid Air, Oxygen, and Nitrogen," by kind permission of the publishers, Messrs J. & A. Churchill.)

From this table it will be seen that the vapour phase is richer in nitrogen than the liquid phase. For instance, when liquid air (21 per cent. O, 79 per cent. N) evaporates, the vapour contains some 7 per cent. oxygen. Thus in simple rectification, although all the nitrogen can be expelled from the liquid, the nitrogen itself will contain at least 7 per cent. oxygen.

In order to produce the evaporation of the liquid air economically, it is essential that no cold should be lost either from the liquid or from the cold evaporated gases. In modern processes this is ensured as follows:—

The liquid air to be evaporated is contained in the vessel *v* (Fig. 12), containing a series of tubes *F* through which the cold compressed air is passed. The cold from the evaporating liquid air in *v* causes liquefaction of the compressed air in the tubes, this air having already been cooled by passage through the exchanger *H* in a reverse direction to the cold vapours from the evaporating liquid. The liquid formed in *c* is passed into the evaporating vessel *v* by means of the tube *r*.

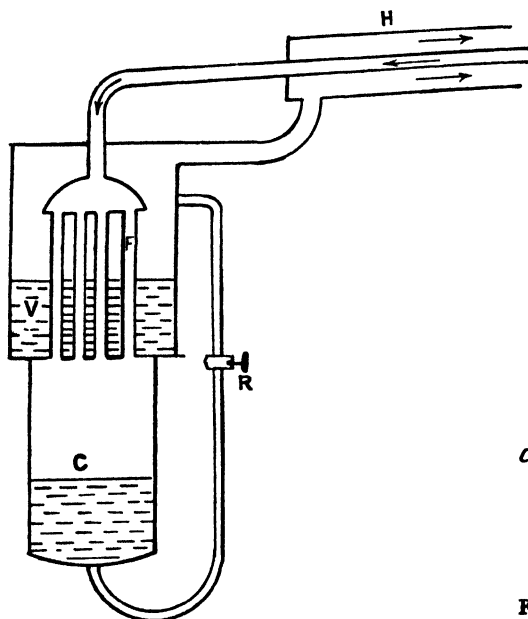


FIG. 12.—Apparatus for Evaporating Liquid Air.

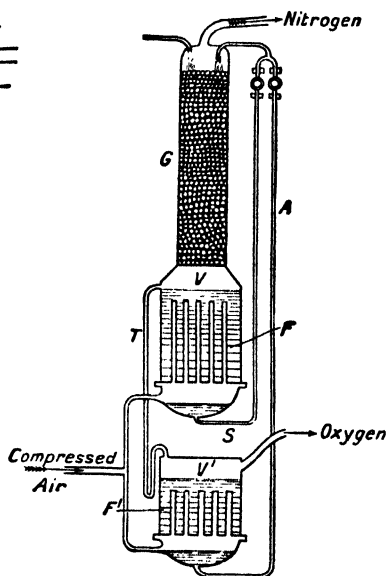


FIG. 13.—Linde's Apparatus for Oxygen.

(From Claude's "Liquid Air, Oxygen, and Nitrogen," by kind permission of the publishers, Messrs J. & A. Churchill.)

Although by this means evaporation is produced with the penetration of very little heat from the surroundings, yet the amount of liquid formed from the compressed air is necessarily not equivalent to that evaporated, and therefore it is necessary to make up the loss by the continuous addition of liquid air.

Linde's Apparatus for Pure Oxygen.—Linde's method of rectification is shown in Fig. 13. The liquid air to be evaporated is contained in *v* and its evaporation is produced by the liquefaction of the compressed air in the tubes *F* contained in *v*. The liquid air thus formed is discharged by the tubes *A* at the top of the rectifying column up which the vapour from the evaporating liquid in *v* ascends. The descending liquid, containing about 21 per cent. oxygen, loses its nitrogen easier than its oxygen and thus becomes colder. It therefore condenses the oxygen in the ascending gases and thus gets richer in oxygen as it descends. When the apparatus is working normally, therefore, the liquid in *v* is practically pure oxygen. When this is the case there will be a temperature gradient established in the column, the maximum cold being at the top. The liquid in *v* can overflow

continuously into a second evaporator v^1 from which it evaporates through a pipe s with a purity of about 98 per cent., the cold produced by the evaporation causing liquefaction of compressed air in the tubes F^1 , this liquid being also passed to the top of the rectifying column. The nitrogen, which, as already explained, must contain at least 7 per cent. oxygen, escapes at the top of the column.

A Linde separator capable of producing large quantities of oxygen of about 99 per cent. purity is shown in Fig. 14.

Air at 2,000 lbs. square inch pressure passes by means of the pipe D through the three small tubes of the temperature exchanger and the spiral tube d_1 in the vaporiser to the expansion valve G . The air expands here and is discharged by means of the pipe d_2 at the top of the rectifying column. The expanded air then passes by means of the tubes c_1 and e_1 through the pipes c & e of the temperature exchanger in the reverse direction to the incoming compressed air. As soon as the temperature at the expansion valve falls to the liquefaction temperature, liquid air is produced which collects in the vaporiser B . As this accumulates it evaporates, due to the heat from the compressed air in the tube d_1 , and the vapour ascends against the downward flow of liquid air from the pipe d_2 . Rectification takes place until finally the liquid in B is practically pure oxygen. The excess of this oxygen is continuously drawn off by means of the pipe e_1 , through the tube e of the exchanger to the exit E . The nitrogen passes by means of F through the tubes c_1 and c to the exit C .

The whole of the apparatus is cased in with wood, all spaces being filled with sheep's wool to prevent penetration of heat from the surroundings.

The nitrogen still contains 7 per cent. oxygen, and therefore in this system at best only 74 per cent. of the available oxygen is obtained.

A complete oxygen plant on the Linde system is shown diagrammatically in Fig. 15.

The air enters the purifier B at A . Here it is decarbonised by means of milk of lime. The purified air compressed in the compressors D , and then cooled in water, passes through the pipe E to the driers F . Here drying is effected first by chloride of lime and finally by potash. The dried air is then cooled in G by means of the refrigerating machine H , and passed into the separating apparatus K . As the desiccation of the air is never complete, it is necessary for continuous working to duplicate the separator K . The oxygen escapes by means of the tube L .

Of late Linde has desiccated the air by means of the auxiliary refrigerating machine. In this case the exchangers in which the moisture is deposited as rime are duplicated and changed over about every twenty-four hours.

The various sizes of oxygen machines working on the Linde system are given in the following table:—

	I.	II.	III.	IV.	V.	VI.	VII.	VIII.	IX.	X.
Output of oxygen, cubic metres per hour	1	2	5	10	20	50	100	200	500	1,000
Power used, H.P.	6	10	20	35	55	100	185	350	800	1,500
Cooling water used, cubic metres per hour	0.25	0.5	1.0	1.6	2.4	4.0	7.0	13.0	29.0	54.0

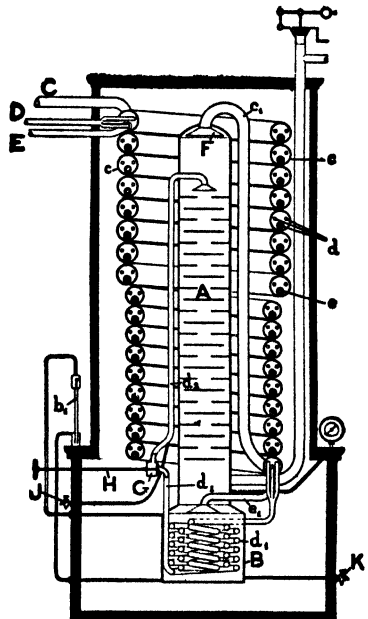


FIG. 14.—Linde Separator.

(Taken from Thorpe's "Dictionary of Applied Chemistry," by kind permission of the publishers, Messrs Longmans & Co.)

Production of Nitrogen by the Linde System.—The nitrogen obtained from the foregoing apparatus contains at least 7 per cent. oxygen. In order to produce pure nitrogen Linde has modified the method of rectification. In the earlier apparatus the liquid produced in the worm d_1 (Fig. 14), instead of being discharged at the top of the column, is discharged at a point half-way down. Thus in the top half of the column the gas consists of nitrogen containing some 7 per

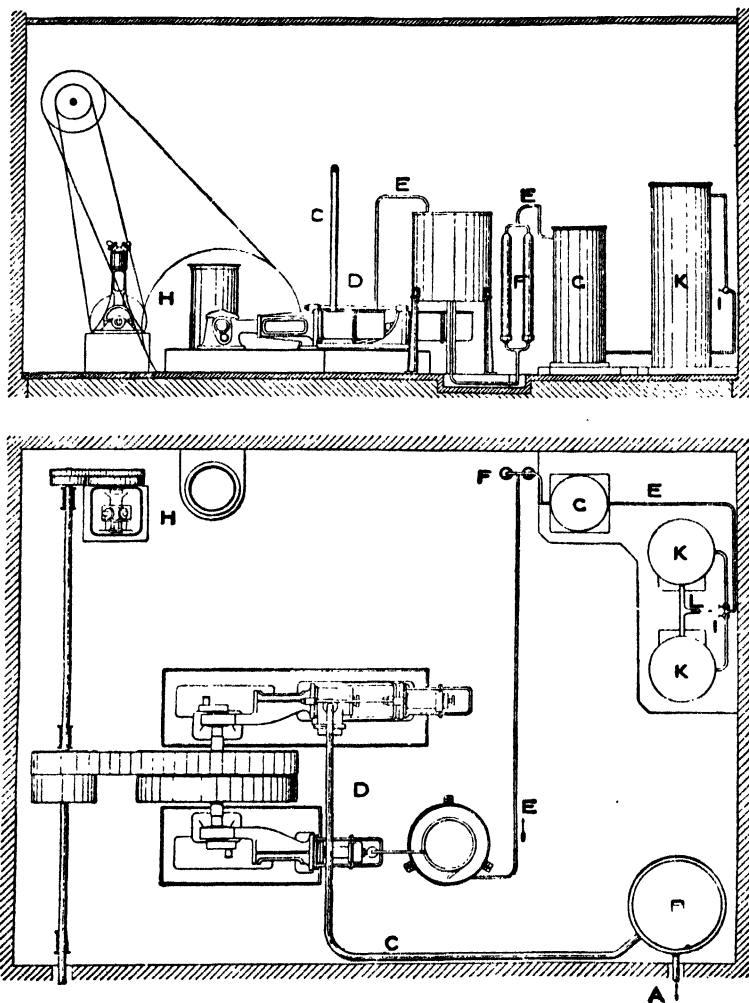


FIG. 15.—Linde Complete Oxygen Plant.

cent. oxygen. The liquid oxygen in the vaporiser is drawn by suction through a worm situated in this nitrogen. The cold produced by the evaporation of this oxygen causes part of the vapours ascending the reclining column to condense, thus reducing the amount of oxygen, and producing practically pure nitrogen at the top.

Although this method allows the waste oxygen to carry away some 40 per cent. nitrogen, it is still used owing to its simplicity in smaller plants.

A more economical method is shown in Fig. 16.

The apparatus consists of the exchanger C, the rectifying column A, and the vaporiser B. The whole apparatus is cased in with wood, and filled with sheep's wool to prevent the entrance of external heat.

The temperature exchanger, which is in the form of a spiral, consists of three small pipes, *e d f*, encased in a large tube C. The bottom end of the external tube C is carried up to the top of the rectifying column.

The cooled and purified air at a pressure of about 2,000 lbs. per square inch is passed by means of the tube *f* through the exchanger, then through the coil *f*₁ in the vaporiser, to the expansion valve H. The air here expands, and passes into the rectifying column. It flows out at the top of the rectifying column back through the temperature exchanger by means of the pipe C. On exit, part of this air is led back to the compressor, and is again compressed. The usual progressive cooling effect is thus produced, and eventually liquid air is produced, and collects in the vaporiser B. Owing to the process of rectification in the column A the liquid in B will become nearly pure oxygen, and the nitrogen escaping at the top of the column, owing to the fact that it is traversing a closed circuit, will tend to become purer and purer. The additional supply of air necessary for the continuous working of the apparatus is supplied by a subsidiary compressor working at 60 lbs. per square inch. This cooled and purified air passes through the exchanger by means of the pipe *d*, is liquefied in the coil *d*₁ situated in the vaporiser, and is discharged, by means of the pipe *d*₂, into the lower part of the rectifying column. This falling liquid will become rectified by the ascending gases from the vaporiser to a purity of 7 per cent. oxygen, the descending liquid becoming nearly pure oxygen. The nitrogen containing 7 per cent. oxygen passes in part, as already described, back to the compressor by means of the pipe C, is compressed, liquefied, and discharged at the top of the rectifying column. A reference to Baly's figures will show that this liquid, containing 7 per cent. oxygen, will purify the ascending gases to 2 per cent. oxygen. These purified gases again traverse the high compression circuit, and so on. Thus pure nitrogen will eventually pass from the exit of the tube C. The oxygen can be obtained from the tube *e*.

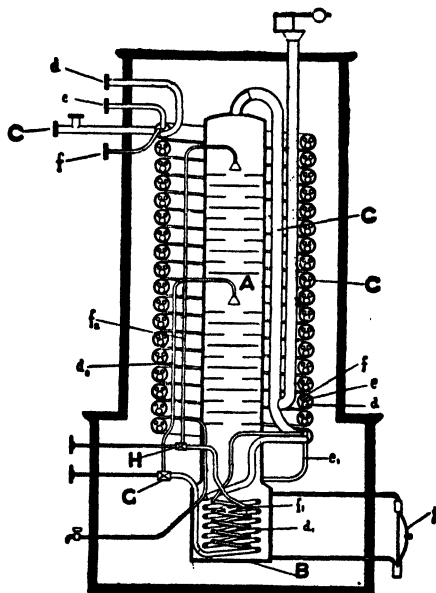


FIG. 16.—Linde Nitrogen Separator.
(From Thorpe's "Dictionary of Applied Chemistry."
By the courtesy of Messrs Longmans & Co.)

Sizes of the Linde nitrogen machines are as follows :—

Size of Machine.	I.	II.	III.	IV.	V.	VI.	VII.	VIII.	IX.	X.
Output, cubic metres nitrogen per hour	6	12	30	60	120	300	600	1,200	3,000	6,000
Power used, H.P. - - - -	9	15	30	52	80	150	275	500	1,100	2,000
Cooling water used - - - -	0.75	0.9	1.5	2.6	4	7.5	12	20	38	75

The amount of liquid used in the closed circuit can be made as large as is desired, and in consequence the purity of the nitrogen can be raised from 99.8-99.9 per cent. An apparatus working on this system has the advantage over the apparatus described previously in that it yields a gas of more constant purity. These plants take a comparatively large amount of power (about 0.5 K.W. per cubic metre of nitrogen), as the energy required for compressing the nitrogen is only partially utilised for the separation of the components.

The largest nitrogen plant which is run on the Linde system is at Odda. This plant, erected in 1908, is run by a 200 H.P. electric motor, and produces 3,000 cub. ft. of nitrogen per hour.

New Linde Apparatus for the Production of Pure Oxygen and Nitrogen.

—In the oxygen apparatus described above the nitrogen leaves the apparatus with at least 7 per cent. of oxygen, so that only about 74 per cent. of the total oxygen in the air can be extracted. In order to obtain a better yield in this respect another type of apparatus has been built which subjects the air to a pre-rectification under a pressure of 4 atmospheres (see Fig. 17).

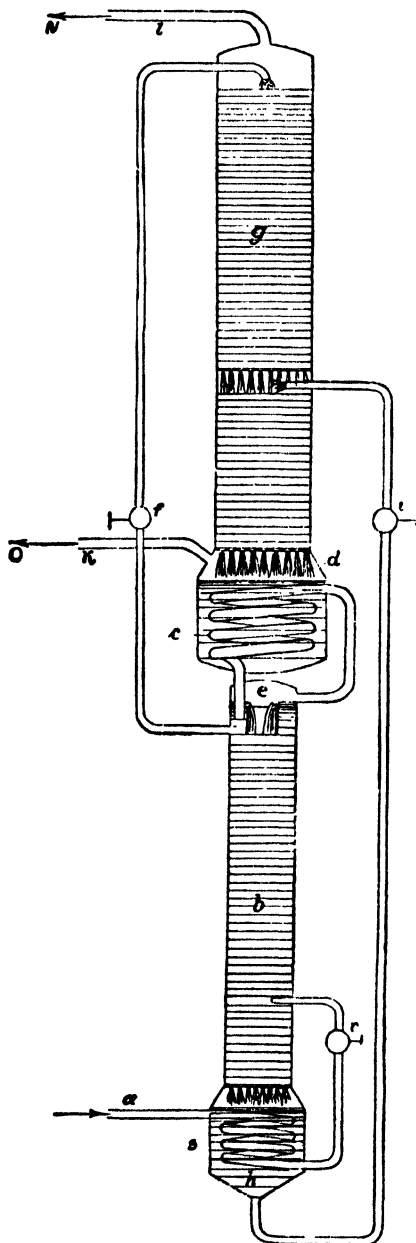


FIG. 17.—New Linde Apparatus for Oxygen and Nitrogen.

This apparatus consists of two columns, one above the other, the lower of which works at 4 atmospheres' pressure, the upper at atmospheric pressure. The compressed air entering at *a* is liquefied in the evaporator *s*, and is discharged about half-way up the lower column. The vapours rising from the evaporator *s* are purified to about 10 per cent. oxygen content by this falling liquid (the conditions of equilibrium between liquid and vapour under higher pressure being different from those at atmospheric pressure), and are further purified by the liquid which is produced in the coil situated in the evaporator *c*, so that eventually nearly pure liquid nitrogen is produced in the coil in *c*. About half of this liquid trickles back into the lower column, the other part being expanded through the valve *f* and discharged at the top of the low pressure column *g*. About half-way down this column the liquid in *s*, containing 50-60 per cent. oxygen, is discharged by means of a valve *i*. Thus in this column the final rectification takes place, the nitrogen escaping at *l*, the oxygen at *k*.

Although theoretically it should be possible to produce simultaneously pure oxygen and pure nitrogen, only 85-90 per cent. of the total oxygen is actually obtained by this means. This arrangement is capable of producing oxygen with an expenditure of energy of 1.3 K.W.H. per cubic metre.

This two-column process has also been adapted to the production of pure nitrogen. The nitrogen with a purity of 99.6-99.8 per cent. requires an expenditure of energy of 0.4 K.W. per cubic metre.

Claude's Apparatus for the Production of Pure Oxygen and Nitrogen.—In Claude's apparatus a method is employed which is styled by the inventor as the method of the "backward return," by which means a separation into a liquid rich in oxygen and one poor in oxygen is obtained. This method is illustrated in Fig. 18. The compressed air passes through the inner tube of the exchanger *m* to a vessel *c*. It then passes up the tubes of the vaporiser *v*, back through the outer tubes of the exchanger. The vaporised gas contains evaporating

the vaporiser *v*, back through the outer tubes of the exchanger. The vaporised gas contains evaporating

liquid air, the vapours of which also pass through an outer tube of the exchanger. The compressed air entering the lower end of the tubes in the liquefier becomes liquefied. Now a reference to Baly's results will show that in order that evaporating liquid air should furnish a gas of 21 per cent. oxygen content it must itself be of an oxygen content of 47 per cent. Conversely, if atmospheric air of 21 per cent. oxygen content is progressively liquefied, the first drops which are formed will be of 47 per cent. oxygen content. The liquid formed in the lower part of the tubes is therefore of 47 per cent. oxygen content. Thus the remaining air rich in nitrogen ascends the tubes, and in ascending is further robbed of its oxygen, until finally at the top of the tubes the gas is practically pure nitrogen. The liquid

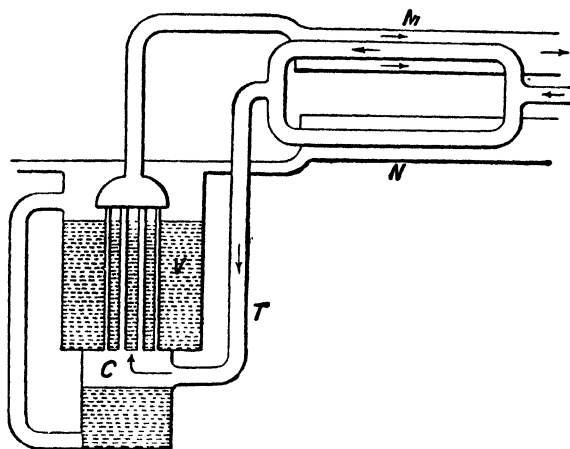


FIG. 18.—Claude's Apparatus for Pure Oxygen and Nitrogen.

(From Claude's "Liquid Air, Oxygen, and Nitrogen," translated by Cottrell. By kind permission of the publishers, Messrs J. & A. Churchill.)

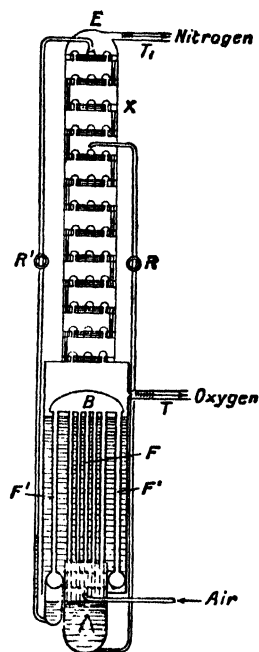


FIG. 19.—Claude's Complete Apparatus, combining the Process of Rectification with Backward Return.

(From Claude's "Liquid Air, Oxygen, and Nitrogen," translated by Cottrell. By kind permission of Messrs J. & A. Churchill.)

falling downward through the tubes at the same time gives up its nitrogen in exchange for the oxygen which is condensed in c. This liquid of 47 per cent. oxygen content is continuously discharged into the vaporiser v, the gases passing through the outer tube N of the exchanger.

The complete arrangement of Claude's apparatus, combining the process of rectification with the backward return, is shown in Fig. 19. The compressed air cooled in the exchangers enters at the bottom of the series of concentric tubes F immersed in liquid oxygen and is liquefied, yielding a liquid of 47 per cent. oxygen content, which collects in A, and practically pure gaseous nitrogen. This gaseous nitrogen, passing through the concentric tubular space F¹ is, owing to its pressure liquefied in c. This liquid nitrogen is discharged at the top of the rectifying column, while the liquid from A is discharged from the middle of the column. This liquid of 47 per cent. oxygen content will exhaust the ascending gases to 21 per cent. oxygen content. The rectification will be completed by the liquid nitrogen descending from the top of the column. Pure nitrogen will therefore pass from T₁ and pure oxygen from T. The additional liquid air necessary to compensate for the continued loss of cold is added from a separate liquid air machine.

In later machines Claude has succeeded in performing the separation of the gases and the production of the additional liquid necessary in a "single cycle."

The cooled compressed air passes through the temperature exchangers *E* and *E'* (Fig. 20) traversed by the cold separated gases, and divides into two portions at the point *X*. One portion expands in the motor *O* with production of external work, is liquefied and separated into liquid rich in oxygen and nitrogen in the vessels *A* and *A'* respectively, as explained above, these liquids being supplied to the rectifying column, as shown at different heights. Cold nitrogen, passing off through the pipe *G*, traverses the temperature exchanger *L* and liquefies the second portion of the compressed air, thus forming the supplementary liquid which is admitted to the vessel *A* to make up for mechanical imperfections. The nitrogen then passes through the exchanger *E*. The oxygen from the vessel *B* is passed through the exchanger *E'*.

Pure Nitrogen by the Claude Process.—Although in principle the process of the backward return achieves the complete separation of the air into

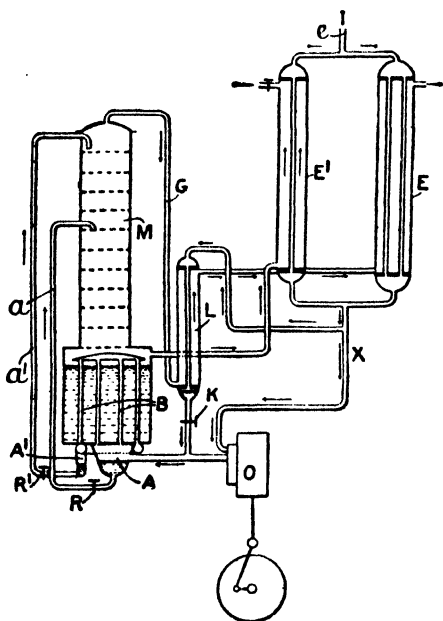


FIG. 20.—Claude's "Single-Cycle" Apparatus for producing Pure Oxygen and Nitrogen.

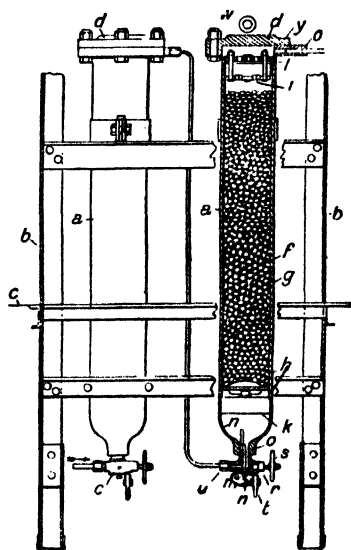


FIG. 21.—Drying Battery for Hildebrandt's Process.

pure oxygen and nitrogen, yet in practice, especially if it is desired to produce pure oxygen also, the nitrogen is only about 3 per cent. pure.

Claude has got over this difficulty by arranging that the liquefaction of the residual nitrogen at the top of the tubes of the liquefier *v* (Fig. 18), is facilitated by a supplementary liquefier supplied with liquid from the bottom of the rectifying column. In this way nitrogen containing not more than 0.2 per cent. of oxygen can be obtained.

In the installations working on the Claude principle the desiccation of the air is obtained by passage through soda towers, or through baffle boxes filled with hydrated lime, and finally by chloride of lime. Claude has recently succeeded in producing desiccation by cold obtained by expansion with external work in which the special exchangers are charged over every twenty-four hours as in the Linde system.

The present installations are based upon the "backward return" and double rectification, and are worked on the "single cycle" system. Recently the

apparatus has been made more compact by combining the whole apparatus in a single column.

The most usual sizes in Claude's system are from 5-20 cub. m. per hour capacity, which at present are at work in some forty installations.

Hildebrandt's Process for Preparing Oxygen and Nitrogen.—This system is also coming rapidly into use, and, like Linde's process, depends on intensive cooling.

The air before entering the apparatus is freed from carbon dioxide (CO_2) and water vapour by passing over caustic soda or caustic potash (preferably the last), and then over calcium chloride in

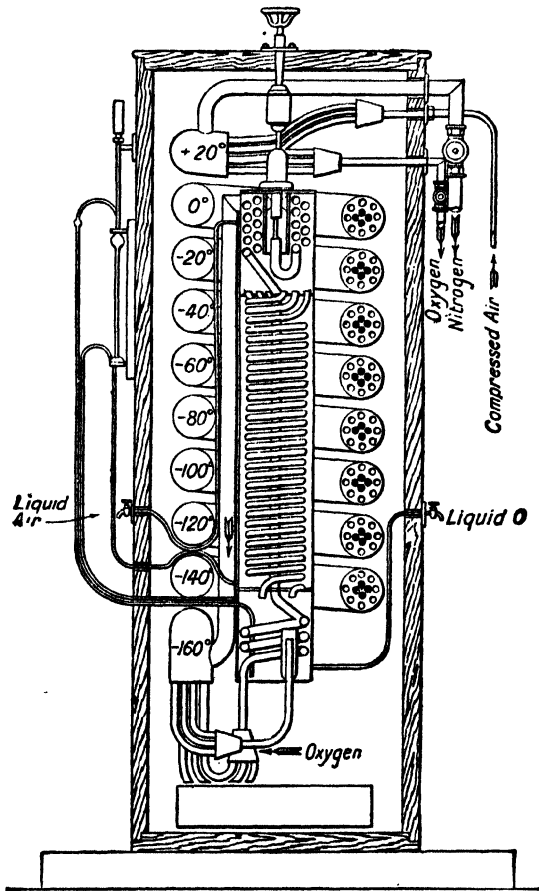


FIG. 22.—Hildebrandt's Process for Oxygen and Nitrogen.

the drying battery shown in Fig. 21. Next the air is compressed to 200 atmospheres, cooled, and then sent into the upper end of the apparatus (Fig. 22), where it is cooled by intensive self-cooling until the air liquefies.

Then by evaporation and fractional boiling it is separated into its components, oxygen and nitrogen. The nitrogen usually escapes as a by-product into the air, while the oxygen, of 98 per cent. purity, is conducted into a gas holder, and there by means of the oxygen compressor compressed into steel bottles or cylinders.

Further details should be sought in Hildebrandt's patents (see list, p. 83).

THE LIQUEFACTION OF HYDROGEN

The principle of self-intensive cooling has now been applied to the production of liquid hydrogen, and Fig. 23 shows diagrammatically such an apparatus manu-

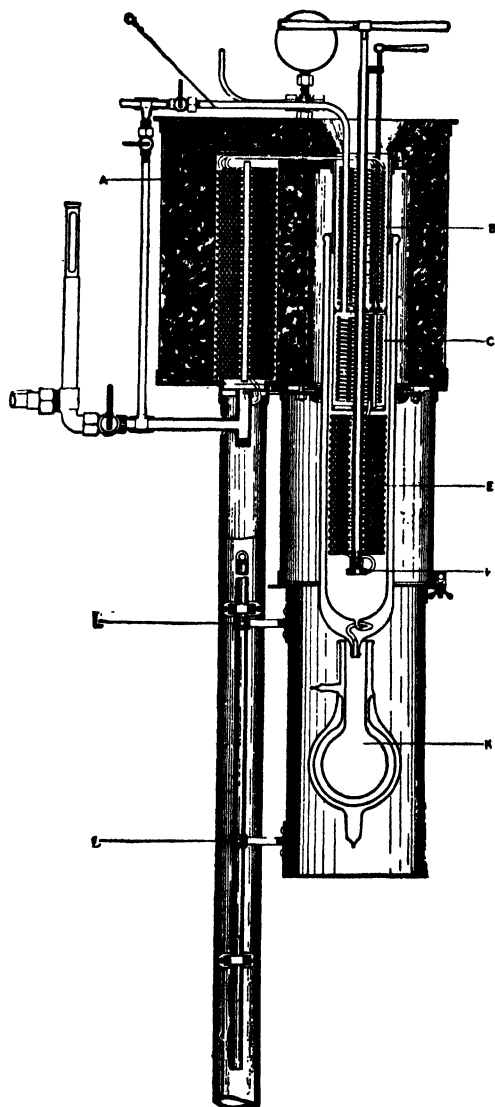


FIG. 23.—Hampson's Apparatus for Liquid Hydrogen, showing attachment of Glass Vacuum Jacketed Collecting Vessel (British Oxygen Co.).

factured by the British Oxygen Co. Hydrogen from a gas holder is compressed to about 200 atmospheres, and after purification over caustic potash enters the lower end of the coils in the chamber A. It then passes down through the coils B, which are immersed in liquid air. The compressed hydrogen, thus cooled to about -190° C., passes through the coils C. Liquid air is allowed to drop into the chamber round these coils through a small valve regulated by a spindle at the top

of the apparatus. A partial vacuum is maintained in this chamber by means of a small pump connected to the pipe *o*, so that the temperature of the evaporating liquid air is lowered to below -200°C ., and the compressed hydrogen is thus farther lowered in temperature. The compressed hydrogen then flows through the coil *e*, and expands through the valve *f*. The expanded gas then passes back over the coils *e*, round the chambers enclosing *c* and *B*, over the coils *A*, and back to the holder. After only a few minutes working part of the expanding hydrogen is liquefied, and can be collected in the vacuum vessel *K*, which can be removed at

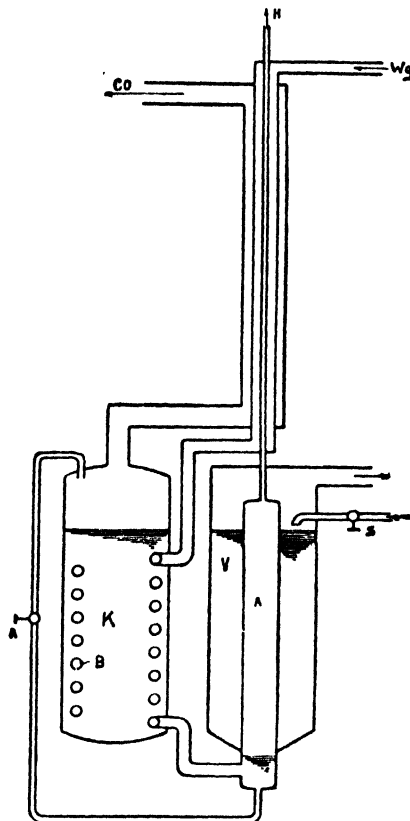


FIG. 24.—Linde-Frank-Caro Process for producing Hydrogen from Water-Gas.

will. This apparatus is capable of producing about 2 litres of liquid hydrogen per hour with an expenditure of 10 litres of liquid air.

The Linde-Frank-Caro Process for the Production of Hydrogen from Water-Gas (see also p. 113, under **Hydrogen**).—In the separation of gaseous mixtures, in which the boiling points of the constituents are very different, the liquefaction of the whole mixture is not necessary. The separation can be effected by condensing the less volatile constituent by suitable temperature and pressure, while the more volatile constituent remains in the gaseous state. A process on these lines has been applied to the separation of hydrogen from water-gas. The low temperature required is obtained by the aid of liquid nitrogen supplied from a separate apparatus. The construction of the separator is shown diagrammatically in Fig. 24.

The water-gas from the producer is first washed by water. The average composition of water-gas is by volume :—

	Liquid, B.P.	Per Cent.
Hydrogen	- 253° C.	48.54
Carbon monoxide	- 192° C.	42.44
Carbon dioxide	- 80° C.	5.2
Nitrogen	- 196° C.	5.3

The water-gas is then compressed, cooled, and treated with water under pressure, which removes practically all the carbonic acid, the remainder being absorbed by caustic soda. This dried compressed water-gas then passes through the temperature exchanger of the separator to the coil *в* (Fig. 24) immersed in a bath *к* containing liquid carbon monoxide.

In this coil the carbon monoxide is almost entirely condensed, and collects in the bottom of the liquefier *А*, whence it can be discharged by means of the cock *г* into *к*. The remaining gas passes through the liquefier *А*, surrounded by liquid nitrogen evaporating under vacuum. In this way more carbon monoxide is condensed, and the gas issuing at the top is composed of about 97 per cent. hydrogen. The remaining carbon monoxide can be removed by passage over soda lime.

After purification the gas contains :—

CO ₂	0 per cent.
Heavy hydrocarbons	0 "
Oxygen	0 "
CO	0 "
Hydrogen	99.2-99.4 "
Marsh-gas	0 "
Nitrogen	0.8-0.6 "

with a specific gravity of .077 to .079.

The waste carbon monoxide gas can be used to generate power. In plants from 100 cub. m. per hour upwards the waste carbon monoxide is sufficient to drive the whole plant.

Size of Plant.	I.	II.	III.	IV.	V.
Cubic metres of hydrogen per hour	25	50	100	200	500
Water-gas required per hour	70	125	250	500	1,250
Cubic metres cooling water required per hour	2.25	3.80	7.60	13.50	32.50

Inventors in large numbers have applied themselves to the problem of the production of gases from mixtures by means of liquefaction, but the processes already described are still the only ones established on a large commercial basis. For details of other methods a perusal of the various patents (above) is recommended. Among others, which may contain the basis of a commercially sound process, may be mentioned those of Hampson, Thrupp, Pictet, Hildebrandt, and Levy. A patent by Levy and Hellbronner in 1902 applies the process of lixiviation by liquid rich in nitrogen by somewhat different means to the foregoing. The process consists of carrying out the fractional distillation under pressure in order to produce reliquefaction of the vapours, and thus obtaining rectification by washing with increasingly cold liquid.

Hildebrandt has produced a large number of patents, chiefly dealing with improvements of special parts of liquefying apparatus (see pp. 83 and 84).

PROPERTIES OF INDUSTRIAL GASES

The following table gives the properties of the chief liquefied gases :—

TABLE OF PHYSICAL CONSTANTS OF LIQUEFIED GASES (Dickerson).

Substance.	Symbol.	Physical Constants.										
		Critical Temperatures.		Critical Pressure.	Boiling Points under Atmospheric Pressure.		Freezing Point.		Pressure at which Freezing Point was Determined. mm.	Density of Gas.	Density of Liquid at Temperature Given.	Colour of Liquid.
		Degs. Cent.	Degs. Fahr.		Degs. Cent.	Degs. Fahr.	Degs. Cent.	Degs. Fahr.				
Water	H ₂ O	365	689	200	100	212	0	32	760	...	1 at 4° C. { 0.6364 } { at 0° C. }	Colourless
Ammonia	NH ₃	130	266	115	-33	-27	-77	-107	...	8.5	{ 0.6364 } { at 0° C. }	"
Propane	C ₃ H ₈	97	206.6	44	-45	-49	{ Still liquid } { at -151° C. }		...	20.95	...	"
Acetylene	C ₂ H ₂	37	98.6	...	-85	-121	-81	-113.8	950	12.97	...	"
Nitrous oxide	N ₂ O	35	96	75	-89	-128	-115	-175	760	21.99	...	"
Ethane	C ₂ H ₆	34	93.2	50.2	-93	-135.4	{ Still liquid } { at -151° C. }		...	19.97	...	"
Carbon dioxide	CO ₂	31	88	75	-80	-112	-56	-69	760	21.94	0.83 at 0° C.	"
Ozone	O ₃	-93	-135.4	23.89	...	"
Ethylene	C ₂ H ₄	10	50	51.7	-102	-150	-169	-272	...	13.97	...	{ Dark blue, easily } { exploded } { Colourless }
Methane	CH ₄	-81.8	-115.2	54.9	-164	-263.4	-185.8	-302.4	80	7.98	{ 0.415 at } { -164° C. }	"
Nitric oxide	NO	-93.5	-135	71.2	-153.0	-254	-167	-369	138	14.98	{ 1.124 at } { -181.4° C. }	"
Oxygen	O ₂	-118.8	-182	50.8	-181.4	-294.5	15.96	{ about 1.5 } { at -187° C. }	Blue
Argon	A	-121	-185.8	50.6	-187	-304.6	-189.6	-309.3	...	19.9	{ 0.933 at } { -191.4° C. }	Colourless
Carbon monoxide	CO	-139.5	-219.1	35.5	-190	-310	-207	-340.6	100	13.96	{ 0.885 at } { -194.4° C. }	"
Air	...	-140	-220	39	-191.4	-312.6	Light blue
Nitrogen	N ₂	-146	-231	35	-194.4	-318	-214	-353.2	60	14.01	...	Colourless
Hydrogen	H ₂	-234	-389	20	-243	-405	1	...	"
Helium	He	{ Below } { -264 }	-443.2	2.02	...	"

SECTION X

INDUSTRIAL OXYGEN

BY GEOFFREY MARTIN, D.Sc., Ph.D.

Manufacture.—The main method is from liquid air in the manner described in the preceding article by Lieut. Dickson.

The following processes may be mentioned in addition to the method already described :—

1. **The Brinn Process.**—By means of barium peroxide. No longer worked.
2. **The Jaubert Process.**—Potassium permanganate is mixed with sodium peroxide. When water is added oxygen gas is spontaneously evolved. Somewhat cheaper is the process (patented in 1902) of mixing together and compressing into tablets sodium peroxide and bleaching powder (100 parts of bleaching powder with available Cl=33.35 per cent., to 39 parts of Na₂O₂). On bringing this into contact with water, oxygen is evolved according to the equation :—



Convenient for use on a small scale. Sold under name "Oxygen Cubes."

3. **Electrolytic Oxygen.**—This is obtained as a by-product in the manufacture by electrolysis of caustic soda, etc. (see p. 114, also p. 370), hydrogen being also obtained at the same time.

It can, however, only be produced economically at places where electrical power is very cheap.

Properties of Oxygen.—The main physical properties of oxygen are set forth in the table on page 103.

Its main characteristic is the intensity with which it supports combustion.

Uses of Industrial Oxygen.—The main use of industrial oxygen is the autogenous welding and cutting of metals.

To give some examples—the ease and rapidity with which the most extensive and massive iron structures can be cut through in almost any position by a few workmen in a few minutes, work which in the ordinary way can only be effected by many workmen in a great many days. Its use for demolishing iron structures, etc., has been demonstrated in innumerable cases. The cutting out of a manhole in a boiler of average size will employ two workmen seven to eight hours. By means of oxygen the work can be done in about eight minutes.

Industrial oxygen is at present principally employed :—

1. **In the Motor Car Industry.**—For welding together autogenously metals like cast iron, steel, magnalium, aluminium, and for effecting rapid repairs of broken parts.
2. **For Illuminating Purposes,** a jet of oxygen being impinged on lime, etc.
3. **In Mining and Tunnelling and Iron Smelting,** e.g., stoppages in blast ovens are often melted through.
4. **In the Tinning and Enamelling Industry,** for melting and welding different metals.
5. **In the Manufacture of Varnishes, etc.,** manufacture of SO₂, etc.
6. **The Gas Industry.**—Enriching the air with oxygen allows the smokeless burning of certain fuels in furnaces, also the burning of wet peat, wood waste, etc., in the production of combustible or producer-gas, water-gas, etc.
7. **The Glass and Ceramic Industry** use oxygen for cutting through glass plates, cylinders, etc., also for increasing the temperature of certain small furnaces.
8. **Medicinal use of Oxygen.**—For saving life for "gassed" workmen, and for administering to those suffering from lung complaints.
9. **In Lead Work,** for making leaden vessels, sulphuric acid chambers, etc.

As an Explosive when Mixed with Coal Dust.—The advantage is lack of poisonous nitrogenous gases. For details of use, etc., see *U.S. Bureau of Mines, Rept. Invest.*, No. 3169.

Innumerable other uses are growing up for oxygen gas, but the above suffices to give the reader an idea of the enormous extent to which oxygen is now being employed in industry.

If oxygen could be manufactured cheaply enough it would revolutionise the gas and smelting industry (see **Borchardt**, *Zeit. Ver. deut. Ing.*, 1930, **74**, 1002; **A. E. R. Westman**, *Canad. Chem. and Metall.*, 1930, **14**, 229; **F. C. Clark**, *Amer. Electrochem Journ.*, 1929.)

Statistics.—Germany in 1905 used only about 40,000 cub. m. of oxygen.

The following table shows the amount of oxygen supplied from Linde plants *alone* in 1911:—

	Cub. Metres.		Cub. Metres.
Germany	6,000,000	Sweden	80,000
England	2,230,000	Roumania	80,000
France	1,550,000	Russia	80,000
Italy	680,000	America	2,676,000
Austria-Hungary	660,000	India	144,000
Spain	220,000	China	80,000
Switzerland	180,000	Australia	220,000
Denmark	110,000		

SECTION XI

INDUSTRIAL NITROGEN

BY GEOFFREY MARTIN, Ph.D., D.Sc.

Manufacture.—Nitrogen is now manufactured almost exclusively from atmospheric air by the liquefaction process, as described in Section IX. on the **Liquefaction of Gases**.

In some Continental works the nitrogen is produced by passing air over hot

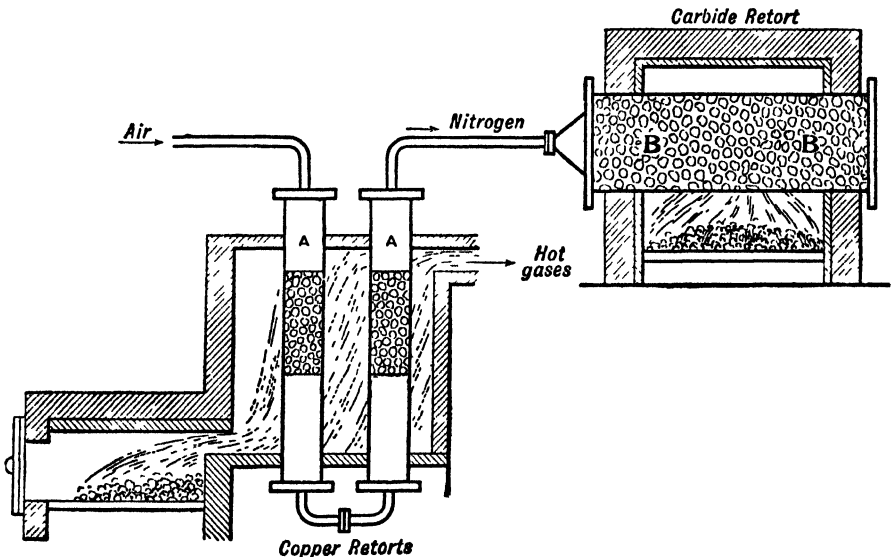


FIG. 1.—Production of Nitrogen by passing Air over Copper.

copper, which retains the oxygen as copper oxide, and allows the nitrogen to pass on, as explained above. The copper is regenerated by passing water-gas over the treated copper :—



Fig. 1 represents a diagrammatic sketch of the apparatus employed for making nitrogen for the manufacture of calcium cyanamide. Air is forced through the iron tubes AA, which are filled with granulated copper. The oxygen is absorbed and the nitrogen passes on, to be absorbed, say, in the calcium carbide in the retort B.

Crude nitrogen, contained in the waste gases from furnaces, is also used for making aluminium nitride (see p. 473).

Properties.—Pure nitrogen is a colourless, tasteless, and inodorous gas. It does not support combustion, it is non-inflammable, and does not turn lime-water

milky (distinction from carbon dioxide). It combines directly with substances such as calcium, barium, magnesium, titanium, silicon, etc., forming compounds known as "nitrides." Chemically pure nitrogen possesses the following properties:—Critical temperature, -146° C.; critical pressure, 35 atmospheres; boiling point at atmospheric pressure, -194.4° C.; freezing point, -214° C.; density of gas, 14.01 ($H = 1$), or 0.96717 (air = 1); specific gravity of liquid nitrogen at its B.P. is 0.8042; solid nitrogen has a specific gravity of .0265. The weight of a litre is 1.25107 g. (Rayleigh). Atmospheric nitrogen contains argon, and so its density is somewhat greater than that of chemically pure nitrogen, the density of "atmospheric" nitrogen being 0.97209, and one litre at 760 mm. weighs 1.25718 g. (Rayleigh).

Uses.—Nitrogen is now being manufactured on an enormous scale for the production of **Synthetic Ammonia** (see p. 469), calcium cyanamide (nitrolim) (see p. 475). It is also used for making aluminium nitride, and other nitrides (see Serpek Process, p. 473).

When nitrogen gas (or ammonia or even nitrogen-containing substances) is brought into contact with white-hot iron, some nitrogen is absorbed by the surface, and an extremely hard surface is thus produced (case-hardening).

The nitrogen gas industry is as yet in its infancy, but is rapidly developing.

SECTION XII

INDUSTRIAL HYDROGEN

BY H. STANLEY REDGROVE, B.Sc.(Lond.), F.C.S.

LITERATURE

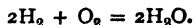
- CARLETON ELLIS, S.B.—“The Hydrogenation of Oils, Catalysers, and Catalysis, and the Generation of Hydrogen.” London, 1915.
- A. W. CROSSLEY.—“The Preparation and Commercial Uses of Hydrogen,” *The Pharmaceutical Journal*, London, 1914, Vol. XCII., pp. 604, 637, 676. Reprinted in *The Journal of the Society of Chemical Industry*, London, 1914, Vol. XXXIII., p. 1135.
- F. BERGIUS.—“Production of Hydrogen from Water and Coal from Cellulose at High Temperatures and Pressures,” *The Journal of the Society of Chemical Industry*, London, 1913, Vol. XXXII., p. 462.
- CARL LINDE and R. WUCHERER.—“Lowest Temperatures in Industry.” Munich, 1913. Volume presented to the members of the Third International Congress of Refrigeration, Chicago, 1913.
- A. FOURNIOLS.—“La Fabrication de l'Hydrogène pour le Gonflement des Ballons,” *Revue générale des Sciences pures et appliquées*, Paris, 1915, Vol. XXVI., p. 339.
- Sir H. E. ROSCOE, F.R.S., and C. SCHORLEMMER, F.R.S.—Article on “Hydrogen” in their “A Treatise on Chemistry,” Vol. I. London, 1911.
- G. CLAUDE.—*Zeit. Angew. Chem.*, 1930, 43, 47.
- Also the numerous Patent Specifications quoted in the text.

PROPERTIES

HYDROGEN is a colourless, odourless, and tasteless gas. It is the lightest element known, its atomic weight (O = 16) being 1.008, and its density, compared with air as unity, being 0.06949. It has been liquefied by **Dewar** and others, and boils at -252.5° C. Liquid hydrogen is a clear, colourless fluid, part of which may be solidified by rapid evaporation of the rest. Solid hydrogen is also colourless and has a melting point of -257° C., according to **Dewar**, or -258.9° C., according to **Travers**.

Hydrogen is a very widespread element, since it forms about one-ninth part by weight of water. It occurs free in nature in the gas of certain volcanoes, and in combination with other elements in petroleum and most organic bodies, as well as in water.

Hydrogen combines vigorously with oxygen to form water, according to the equation:—



Mixtures of hydrogen and oxygen combine with explosion when ignited. Hydrogen burns readily in the air, with an almost colourless flame (faintly green, tinged with violet-blue). The colour may be altered by changing the pressure. The heat evolved in the combustion of hydrogen is very great. At constant pressure and temperature t° C., the heat liberated per gram-molecule of water produced is $57.9 + 0.00165t$ cals., when the water is in the gaseous state, or $68.5 - 0.0077t$ cals., when, the water being liquefied, its latent heat is also obtained.¹

Hydrogen will not support the combustion of bodies which we usually regard

¹ Julius Thomsen, “Thermo-Chemistry,” translated by K. A. Burke, B.Sc., 1908, p. 193.

as combustible, nor will it support life. It is not, however, poisonous, and certain bodies, for instance oxygen and chlorine, will burn in it.

It is very slightly soluble in alcohol, and still less soluble in water.

Certain metals, palladium in particular, have the remarkable property of absorbing large quantities of hydrogen at high temperatures and pressures, with very little alteration in their physical properties and appearance. Such "occluded" hydrogen, as it is called, exhibits increased chemical activity. The hydrogen is evolved when the metal containing it is placed under reduced pressure. Palladium will absorb over 900 times its volume of hydrogen when heated in an atmosphere of the gas, whilst black platinum will absorb about 100 volumes under similar conditions.

Recent experiments have shown that certain bodies (for example, unsaturated fats) will readily enter into combination with hydrogen if palladium, black platinum, or especially nickel, or an oxide of nickel, is present. This phenomenon is, no doubt, closely connected with that of occlusion, but its exact nature, whether the hydrogen chemically combines with the metal to form a definite compound, or merely "alloys" with it in the manner that two metals may be alloyed, is still a matter of debate. In its combinations hydrogen certainly appears to be capable of acting both as a metal and as a non-metal.

MANUFACTURE

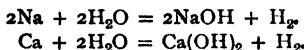
Water is by far the cheapest raw material for the manufacture of hydrogen. Next in point of cheapness come hydrocarbons. There are a few processes making use of other sources of hydrogen, but they are in all cases much more expensive, and are either being superseded, or have only a limited application for special purposes. The various processes may be roughly classified as follows:—

1. By the Action of Water on Metals.
2. By the Action of Water on Non-Metals.
3. By the Deoxidising Action of Carbon Monoxide.
4. By the Electrolysis of Dilute Sulphuric Acid Alkali, or certain Salt Solutions.
5. From Hydrocarbons.
6. By the Action of Acids on Metals.
7. By the Action of Alkalis on Metals.
8. Special Methods.

These will now be considered in detail.

1. By the Action of Water on Metals.

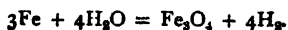
The alkali metals (*e.g.*, sodium) and the metals of the alkaline earths (*e.g.*, calcium) decompose water at ordinary temperatures, the first violently and the second readily, as under:—



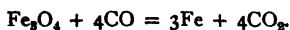
Certain metals which, in a pure condition, will attack water only at high temperatures, will react at lower temperatures if alloyed with some other metal, *e.g.*, zinc, if first coated with a thin layer of copper, will readily decompose warm water ($\text{Zn} + 2\text{H}_2\text{O} = \text{Zn(OH)}_2 + \text{H}_2$).

These processes are only applicable for the preparation of pure hydrogen in the laboratory. A somewhat similar process has, however, been patented by Ujeno (English Patent, 11,838, 1912; United States Patent, 1,118,595, 1914), in which an alloy of aluminium with small proportions of zinc and tin, together with a trace of mercury, is used to decompose hot water. The method seems well adapted to the preparation of hydrogen for aeronautical purposes; but such an alloy would be too expensive for manufacturing hydrogen for industrial use, and iron is practically the only metal used industrially for the decomposition of water.

When steam is passed over hot iron, in a suitable furnace, hydrogen is produced in accordance with the equation—



The iron can be revived by reducing the oxide formed by means of gas containing carbon monoxide (for example, producer-gas, *q.v.*), thus :



This is **Lane's** process.

The two reactions are carried out alternatively so long as they are found to take place with sufficient speed, ten minutes being allowed for the first ("gassing" or oxidation period), and about twice as long for the second (reduction period). A temperature of from about 900°-1,000° C. is used for both. In order to make the process practically continuous, two or more furnaces may be run alternatively (see **Lane's** Patents, English Patents, 10,356, 1903; 17,591, 1909; 11,878, 1910, etc.).

The process has been found very efficient when a suitable type of iron is employed, though there are a good many technical difficulties connected with it, which a number of patents taken out during the last few years claim to have obviated. Spongy iron appears to be far more reactive than the compact form, which is apt to become only superficially oxidised (**Badische Anilin und Soda Fabrik**, English Patent, 27,735, 1912; French Patent, 453,077, 1913; **Anton Messerschmitt**, United States Patent, 971,206, 1908). However, compact iron will decompose steam, and **H. Dicke** (German Patent, 280,964, 1913) proposes that the scrap-iron that accumulates in iron and steel works be utilised for this purpose. **Messerschmitt** (English Patent, 18,028, 1913; French Patent, 461,480, 1913; United States Patent, 1,109,448, 1914) states that good yields of hydrogen can be obtained at about 700°-800° C. by using a mixture of iron and manganese produced by the reduction of ores containing both these metals; whilst **W. Näher** and **M. Nöding** (German Patent, 279,726, 1913) pass the steam first over copper and then over iron.

Messerschmitt is responsible for a large number of improvements in apparatus, etc., for the manufacture of hydrogen by the deoxidation of steam by means of iron, for which see German Patents, 263,391, 268,062, 268,339, 1912; French Patents, 444,105, 444,106, 1912; 461,623, 461,624, 461,625, 462,379, 1913; English Patents, 12,117, 12,242, 12,243, 1912; 17,690, 17,691, 17,692, 18,942, 1913; United States Patent, 1,109,447, 1914. For improvements in apparatus the following patents should also be consulted—**Badische Anilin und Soda Fabrik**, English Patent, 2,096, 1913; and **Berlin Anhaltische Maschinenbau A.-G.**, English Patents, 28,390, 1913; 6,155, 1914; French Patent, 465,474, 1913; United States Patents, 1,118,595, 1914; 1,129,559, 1915. Purification of the reducing gas employed is essential in order that the efficiency of the iron shall be preserved. With due precautions the hydrogen obtained is in an almost chemically pure condition, containing only traces of nitrogen. According to **Bergius** ("Production of Hydrogen from Water and Coal from Cellulose at High Temperatures and Pressures," *The Journal of the Society of Chemical Industry*, Vol. XXXII, 1913, p. 462; German Patent, 254,593, 1911; French Patent, 447,080, 1912; English Patents, 19,002, 19,003, 1912; United States Patents, 1,059,817, 1,059,818, 1913), water is more reactive in the liquid state than in the gaseous state. Consequently he carries out the reaction between water and iron at a sufficiently high pressure to prevent the vaporisation of the water. The resulting hydrogen is particularly pure, owing to the fact that under the conditions of the method the water does not attack the impurities in the iron. One specimen of hydrogen obtained by this method gave the following results on analysis:—

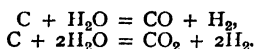
Hydrogen -	-	-	-	-	99.95 per cent.
Carbon monoxide -	-	-	-	-	0.001 "
Saturated hydrocarbons -	-	-	-	-	0.042 "
Unsaturated hydrocarbons -	-	-	-	-	0.008 "

The speed of the reaction rapidly increases with a rise in the temperature, and it is facilitated by the presence of a trace of an electrolyte, such as ferrous chloride, and of a metal more electro-positive than iron, as shown by the following table:—

	Temperature, ° C.	Volume of Hydrogen Evolved per Hour.
Iron and pure water -	300	c. cs. 230
„ + FeCl ₂ - -	300	1,390
„ + FeCl ₂ + Cu -	300	1,930
„ + FeCl ₂ + Cu -	340	3,450

The iron oxide (Fe₃O₄) is obtained in the form of a finely divided powder, which can be readily reduced by means of carbon or carbon monoxide. Another advantage of the method lies in the fact that the hydrogen is obtained under sufficiently high pressure for filling into cylinders without further compression. The process is worked at a factory in Hanover, and it is claimed that the method is so rapid that a generating vessel of 10 gallons will produce about 3,000 cub. ft. of hydrogen per day at a cost of about $\frac{3}{4}$ d. per cubic metre.

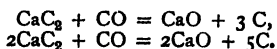
2. By the Action of Water on Non-Metals.—Certain of the non-metals can be made to react with water so as to yield an oxide and free hydrogen. The only one of industrial importance is carbon. When steam acts on heated coke the following reactions take place :—



The mixture of carbon monoxide and hydrogen obtained in the first case is known as “Water-Gas” (see the present writer’s article on “Producer-Gas” in this volume). Efforts have been made to cause the second of these reactions to take place exclusively. **O. Dieffenbach** and **W. Moldenhauer** (English Patent, 8,734, 1910) claim that this may be accomplished by impregnating the coke with 10 per cent. of potassium carbonate, and mixing it with five times its weight of lime, which absorbs the carbon dioxide produced. A temperature of 550°–750° C. is employed. **F. Bergius** (German Patent, 259,030, 1911) uses a sufficiently high pressure to prevent the vaporisation of the water (see above). In these circumstances he states that the formation of carbon monoxide may be prevented by the use of certain catalytic agents, of which he prefers thallium chloride (1 per cent. of the weight of the coke). He uses a temperature of 340° C., and the carbon dioxide produced is absorbed by lime.

The manufacture of hydrogen from water-gas is now one of considerable importance, and several methods have been proposed for the separation of the carbon monoxide from the hydrogen.

Thus **A. Frank** (French Patent, 371,814, 1906; English Patent, 26,808, 1906) suggested the use of cuprous chloride solution, which absorbs most of the carbon monoxide. The dried gas is then passed over calcium carbide at a temperature exceeding 300° C., when the following reactions take place :—



The carbon dioxide and nitrogen present are also absorbed, with the production of calcium carbonate and calcium cyanamide respectively. The process, however, proved too expensive to work for industrial purposes, which led to further investigation, resulting in the **Linde-Frank-Caro** process, dealt with below.

Physical methods have also been proposed for the separation of water-gas into its constituents. Centrifugation (see English Patent, 12,194, 1902, **E. N. Mazza**) has not proved satisfactory (see also English Patent, 17,946, 1905; **C. Clamond**). Diffusion has also been proposed, **Jouvier and Gautier** (French Patent, 372,045, 1906) claiming that a single passage through a partition of unglazed porcelain reduces the amount of carbon monoxide by nearly 82 per cent.

In consequence of the great difference between the boiling point of hydrogen (–252.5° C.) and the boiling points of carbon monoxide (–190° C.) and nitrogen (–195.5° C.), liquefaction has proved to be by far the most important

method industrially for the separation of hydrogen from the carbon monoxide of water-gas, and the nitrogen usually present as an impurity. **Linde's** work, cited above, should be specially consulted. The main principle in **Linde's** method for the liquefaction of gases is that of expansion without external work at low temperatures and high pressures, in which circumstances the Thomson-Joule effect becomes sufficient to produce a large lowering in the temperature. This method is combined with the use of counter-current interchangers. In the **Linde-Frank-Caro** process¹ for the separation of water-gas, worked by the **Ges. für Lindes Eismaschinen**, water-gas, having approximately the composition H₂ 48.54 per cent., CO 42.44 per cent., CO₂ 2.5 per cent., N₂ 3.5 per cent., with traces of other impurities, is first freed from its carbon dioxide by means of water under pressure, a final purification being effected by means of alkalis. It is then dried and passed into a special cooling apparatus. Most of the carbon monoxide is liquefied by passing the gas through a coil in a vessel containing liquid carbon monoxide already produced by the process. The liquid carbon monoxide thus formed is expanded and poured into this vessel. The hydrogen passes on, and a further separation of carbon monoxide and nitrogen is effected by cooling the gas in boiling nitrogen. The separated hydrogen and carbon monoxide gases issuing from the apparatus pass through a counter-current interchanger, and thus facilitate the cooling of the water-gas which enters the apparatus through the interchanger.

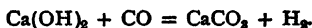
The hydrogen thus obtained is 97-97.5 per cent. pure, the impurities being carbon monoxide 1.7-2 per cent., nitrogen 1-1.8 per cent. Other impurities are practically nil. The cost of production is 1½d. per cubic metre. The gas may be further purified, at an additional cost of ¾d. per cubic metre, by means of soda lime, which removes the whole of the remaining carbon monoxide, giving a product containing 99.2-99.4 per cent. hydrogen, the remainder being nitrogen. The gas is claimed to be free from such impurities as would interfere with its use in aeronautics or in the synthesis of ammonia. Further, it is obtained under pressure, which is important for the latter process. The carbon monoxide obtained may be used as a fuel.

In **Claude's** process for the separation of the constituents of water-gas by means of refrigeration (French Patents, 329,839, 1903; 469,854, 1913; English Patent, 13,160, 1914) the main point is that cooling is effected by expansion of the hydrogen with external work in a motor lubricated with light petroleum.

See also *Zeit. Angew. Chem.*, 1930, 43, 47.

See also **Jaubert's** auto-combustion process under "Special Methods" below.

3. By the Deoxidising Action of Carbon Monoxide.—Other processes for the manufacture of hydrogen from water-gas utilise the deoxidising action of carbon monoxide, in virtue of which the latter gas can be absorbed by suitable bodies and replaced by an equal volume of hydrogen. Thus the **Chemische Fabrik Greisheim-Elektron** have patented a process (English Patents, 2,523, 1909, and 13,049, 1912) in which hydrogen is produced by means of the following reaction:—



The water-gas, together with steam, is passed over lime at a temperature of about 500° C., which is below that of the dissociation of calcium carbonate. As the process is exothermic, extraneous heating is not required once it is started. 5 per cent. of powdered iron is added as a catalyst. Calcium oxide is regenerated from the carbonate produced. The cost of the hydrogen, containing as an impurity the nitrogen present in the water-gas, is stated to be about 1d. per cubic metre. It is probable that the reaction takes place in two stages, calcium formate being first produced (see below). **La Soc. l'Air Liquide** makes use of the same reaction in connection with **Claude's** liquefaction process (French Patent, 453,187, 1912;

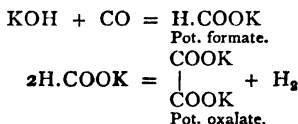
¹ See Section IX. by Lieut. Dickson on "The Liquefaction of Gases," p. 101.

English Patent, 7,147, 1913; United States Patent, 1,135,355, 1915). (See also **H. Strache**, German Patent, 253,705, 1910.)

A number of patents based on the reaction $\text{CO} + \text{H}_2\text{O} = \text{CO}_2 + \text{H}_2$ have been taken out in recent years:—

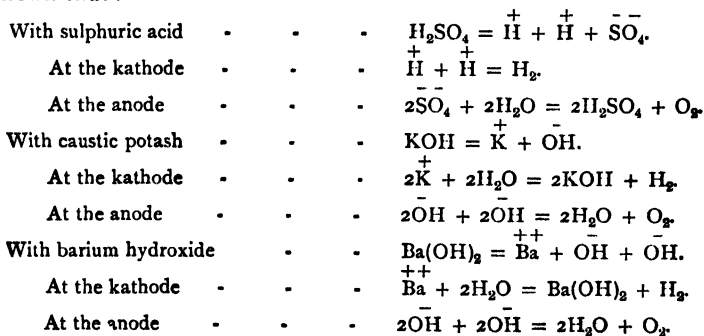
The **Badische Anilin und Soda Fabrik** (English Patents, 26,770, 27,117, 27,955, 1912; 8,864, 1913; 16,494, 1914; French Patent, 459,918, 1913) employ as catalysts finely divided iron (prepared below 650° C.), nickel, or similar bodies. The gases are kept under a pressure of 4 to 40 atmospheres, and the temperature, which is a factor of importance, is maintained at about 400°-500° C. The requisite heat may be obtained by the admission of oxygen. The carbon dioxide is removed by absorption. In German Patent, 279,582, 1913, they state that the addition of oxygen compounds of chromium, thorium, uranium, beryllium, antimony, etc., to the iron increases its reactivity as a catalyst (see also German Patent, 282,849, 1913). **Buchanan and Maxted** (English Patent, 6,477, 1914) suggest the use as a catalyst of iron-copper couple made by the reduction of copper nitrate by means of reduced iron (see also English Patent, 6,476, 1914).

In this connection the formation of hydrogen as a by-product in the manufacture of oxalates may be mentioned. Oxalates are now largely manufactured from formates, the latter being obtained by the action of carbon monoxide (producer-gas) on alkalis under pressure, thus:—



(See United States Patent, 1,098,139, 1914; cf. **Badische Anilin und Soda Fabrik**, English Patent, 1,759, 1912.) A full description of manufacture is given in **Martin's** "Industrial Chemistry: Organic," pp. 369-370.

4. By Electrolysis.—When an electric current is passed through water containing a small quantity of sulphuric acid or an alkali, the water is decomposed into its elements, the oxygen being liberated at the anode or positive pole, and the hydrogen escaping at the kathode or negative pole. The process is sometimes called "the electrolysis of water," but the expression is a misnomer, since the acid or alkali plays an essential part in the reaction, pure water being practically a non-electrolyte and a non-conductor of electricity. The changes involved may be shown thus:—

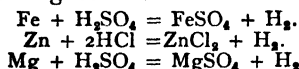


By using a platinum plate as kathode, and a platinum wire immersed in an amalgam of zinc and mercury (to absorb the oxygen) as anode, very pure hydrogen may be obtained in the laboratory, especially if thoroughly purified barium hydroxide is used (**Baker**, *Journal of the Chemical Society*, Vol. LXXXI., 1902, p. 400).

Under manufacturing conditions, hydrogen produced by the electrolysis of dilute sulphuric acid and alkalis usually contains oxygen (1-2 per cent.), an impurity liable to produce dangerous explosions in certain of the industrial applications of hydrogen (e.g., the synthesis of ammonia). To obviate this, diaphragms are introduced between the electrodes, though this increases the electrical resistance of the

Maschinenbau A.-G. (German Patent, 267,944, 1913; French Patent, 466,040, 1913; English Patent, 2,054, 1914) obtain gases suitable for heating or lighting, and, under suitable conditions, hydrogen, by passing vaporised petroleum oils over incandescent coke, whilst **C. Ellis** (United States Patent, 1,092,903, 1914) treats coke, rendered white hot by an air blast, with heavy petroleum oil. The gas produced during the blowing period, and the hydrogen formed during the gassing stage, are removed by means of steam passed over, but not through, the bed of coke (see also British Patents, 360,618 (1932), 343,435 (1931), 376,358; United States Patents, 1,799,452, 1,826,974, 1,830,010, 1,834,115, 1,834,116, 1,837,254, 1,736,065).

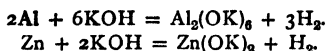
6. By the Action of Acids on Metals.—Certain acids, *e.g.*, dilute sulphuric and hydrochloric acids, readily generate hydrogen by their action on certain metals, for instance iron, zinc, and magnesium. Thus :—



These methods are employed in the laboratory to prepare hydrogen. The last is used when a very pure gas is required. The earliest industrial methods of manufacturing hydrogen made use of the action of sulphuric acid on such metals as scrap iron, zinc distillation residues, etc., and a very large number of patents have been taken out (*e.g.*, English Patents, 16,277, 1896; 15,509, 25,084, 1897; 17,516, 1898; 6,075, 18,930, 1905; 21,440, 1906); but such processes are now practically obsolete owing to the enormous quantity of material requisite. Thus, as **Crossley** points out (*loc. cit.*), a small military airship of 250,000 cub. ft. capacity would necessitate the use of 18 tons of iron and 31 tons of sulphuric acid to inflate it.

(*Cf.* also English Patent, 5,577, 1911, **G. Wannschaff** and **J. Savelsberg**, hydrogen and zinc oxide obtained by the action of zinc chloride solutions on waste zinc.)

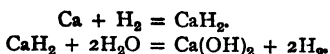
7. By the Action of Alkalis on Metals.—Certain metals, *e.g.*, aluminium and zinc, have the power of liberating hydrogen from solutions of the caustic alkalis, thus :—



Very pure hydrogen may be obtained in the laboratory by either of these processes. In the case of aluminium the evolution of hydrogen is very rapid. (*Cf.* **Uyeno's** patent above.)

Silicon behaves similarly with caustic alkalis, and **G. F. Jaubert** (French Patent, 454,616, 1912; English Patent, 7,494, 1913) proposes to obtain hydrogen by the interaction of powdered silicon, aluminium, or their alloys, with an emulsion of a concentrated solution of caustic soda or potash with a non-saponifiable oil or grease, such as paraffin. See also English Patent, 17,589, 1911, and the same author's "Hydrogenite" process dealt with in "Special Methods" below.

8. Special Methods.—**Jaubert** has patented several ingenious processes by which hydrogen may be very rapidly and easily generated for military purposes. In French Patent, 327,878, 1902, he describes the preparation of calcium hydride. The hydrogen which is evolved as a by-product in many processes, such as the electrolytic production of soda (see above), is freed from oxygen, dried, and passed over pieces of calcium heated in an iron tube in an electric furnace. When brought into contact with water the calcium hydride thus obtained evolves hydrogen with violence, thus :—



The 90 per cent. pure calcium hydride prepared by the above method is known as "Hydrolith." One kg. of it yields 1 cub. m. of hydrogen, the evolution of the gas being so rapid that an average sized dirigible can be filled in about four hours. It is a very expensive method of generating hydrogen, but on account of its extreme rapidity has been adopted by the French army, and, as **Fourniols** (*loc. cit.*) points out, the saving in the cost of transport effected by using "hydrolith" in place of cylinders of hydrogen more than compensates for the expense of this material. See also English Patent, 25,215, 1907.

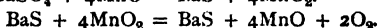
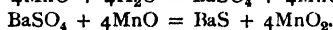
Jaubert has also patented mixtures which, when heated at one point, react violently in a manner like "Thermit" with the evolution of hydrogen.

"Hydrogenite," for example, consists of five parts of ferro-silicon, containing

90-95 per cent. of silicon, twelve parts of caustic soda, and four parts of slacked lime. It may be ignited by means of a hot iron ball, in a special apparatus, and 1 kg. yields about 320 litres of hydrogen (English Patent, 153, 1911).

Jaubert's auto-combustion methods are also of interest (French Patents, 427, 191, 1910; 438,021, 1911; English Patents, 9,623, 1911; 5,005, 1912; United States Patent, 1,099,446, 1914). According to the first, a mixture consisting of a combustible body able to decompose water at a high temperature, and an oxidising agent able to support its combustion, is kindled in a closed vessel in the presence of water. The latter may be obtained by introducing a hydrated body which will give up its water at the temperature of the reaction. Suitable mixtures, for instance, may be made from iron filings, potassium perchlorate, and slacked lime, or from ferro-silicon, litharge, and soda lime. In the second method, water (in the form of steam) is the only oxidant, and a highly heated metal, metalloid, or alloy, preferably ferro-silicon, is used as a combustible, the reaction being started in a closed vessel with a pinch of gunpowder.

Teissier and Chaillau (French Patent, 447,688, 1912) suggest the manufacture of hydrogen by passing steam under pressure over a mixture of barium sulphide and manganous oxide. The resulting mass of barium sulphate and manganous oxide is converted into a mixture of barium sulphide and manganese dioxide by the action of a red heat, from which the mixture of barium sulphide and manganous oxide is regenerated by the action of a white heat. Thus:—



INDUSTRIAL USES OF HYDROGEN

Hydrogen has recently assumed great industrial importance, chiefly owing to the creation of two entirely new industries—the synthetic production of ammonia, and the hydrogenation of fats. Aeronautics are responsible for another demand, and hydrogen finds some other important and useful applications.

1. Use as a Combustible.—Water-gas consists of hydrogen mixed with carbon monoxide, and semi-water-gas also contains hydrogen. Both of these are very important fuels (see the present writer's article on "Producer-Gas" in this volume). When hydrogen, undiluted with other gases, is burned with oxygen, a temperature as high as 2,800° C. can be reached.

The oxy-hydrogen flame has one application in the production of the Drummond limelight. The hot flame, impinging on a cylinder of burnt lime, heats it to incandescence, and produces a dazzling white light. The effect is almost equal to that of the electric arc. The flame has other applications, namely, for fusing and welding platinum, in working fused quartz, and in the production of autogenous joints in lead and other metals. Such joints, that is to say, those formed by melting the metal itself for the purpose of welding, are found to be more durable than soldered joints.

The usual form of blow-pipe consists of a nozzle, fed by two tubes, fitted with stop-cocks. One tube leads from a hydrogen-generator or cylinder, the other runs to a bellows, or may be fed with oxygen, the best proportion of the gases being one volume of oxygen to four volumes of hydrogen. The oxy-acetylene flame, however, is now replacing the oxy-hydrogen flame, owing to the higher temperature produced by the former, and to the fact that less gas is required.

2. Use as an Inert Atmosphere.—Hydrogen, purified from traces of oxygen by passage over heated copper, may be used in certain processes which require an atmosphere free from oxygen, such as in the manufacture of tungsten filaments for electric lamps. These filaments have to be heated to a high temperature, when they are very sensitive to the action of oxygen. An atmosphere consisting of equal parts of hydrogen and nitrogen is usually employed.

3. Use in Aeronautics.—Owing to its extreme lightness, hydrogen is

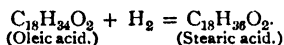
superior to all other gases for balloons and dirigibles. The gas must be dried and freed from compounds of arsenic and phosphorus, as these latter are liable to produce arsenic and phosphoric acids, which may corrode the fabric of the balloon with disastrous results.

The lifting power of hydrogen prepared from zinc and sulphuric acid, and dried with lime, is given by **Walker** ("Aerial Navigation," 1902) at 68.5 lbs. per 1,000 cub. ft., whilst **Baden Powell** (paper read before The Royal United Service Institution, 1893) puts the figure at 60.70 lbs.

Specially rapid methods of preparing hydrogen for military purposes have been dealt with above.

4. Use for the Synthesis of Ammonia.—Ammonia is now largely manufactured synthetically from its elements ($N_2 + 3H_2 = 2NH_3$), which combine together with ease at high pressures and temperatures (500° – 600° C.), in the presence of suitable catalysts, such as uranium containing uranium carbide. A full description of the processes is given in Section XLVIII., p. 469.

5. Use for the Hydrogenation of Fats.—Under suitable conditions hydrogen will combine with unsaturated organic compounds, thus:—



The saturated fatty acids and their glycerides have higher melting points than the corresponding unsaturated compounds, so that by this means various soft oils and fats, such as whale-oil, fish-oil, linseed-oil, etc., may be hardened, and their commercial value correspondingly increased. Moreover, the colour of such saturated fats and oils is rendered lighter by the process, and their characteristic odours and tastes are destroyed. The high melting-point products can be used for candle-making, soap-making, and in the manufacture of edible fats, etc. Consequently, enormous amounts of hydrogen are now used for the hardening of fats and oils. Full details of the processes are given in **Martin's** "Industrial Chemistry: Organic," p. 100a *et seq.*

In order to carry out the reaction satisfactorily, attention must be paid to the temperature, and means must be taken to ensure intimate mixing of the oil and the hydrogen gas, preferably by spraying the oil into an atmosphere of hydrogen under pressure. The reaction takes place only in the presence of a suitable catalyst such as palladium, reduced nickel (prepared at a low temperature), or nickel oxide. The hydrogen must be free from impurities, sulphur being especially deleterious. The reaction is in many ways a mysterious one, and seems to be extremely sensitive to small details. (See English Patents, 1,515, 1903; 2,520, 13,042, 1907; 9,112, 1908; 3,752, 7,726, 18,969, 29,612, 30,014, 30,282, 1910; 8,147, 15,439, 15,440, 1911; 72, 4,702, 5,773, 18,282, 18,310, 18,998, 23,377, 23,643, 28,754, 1912; and "Reports on Patent Cases," 1913, Vol. XXX., p. 297; United States Patents, 1,004,034, 1,004,035, 1911; 1,026,156, 1,040,531, 1,040,532, 1,043,912, 1912; 1,058,738, 1,059,720, 1,060,673, 1913, etc.)

SECTION XIII

PRODUCER-GAS

By H. STANLEY REDGROVE, B.Sc. (Lond.), F.C.S.

LITERATURE

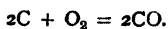
- NISBET LATTA.—“American Producer-Gas Practice and Industrial Gas Engineering.” New York and London, 1910.
- PHILIP W. ROBSON.—“Power-Gas Producers: their Design and Application.” London, 1908.
- L. S. MARKS and S. S. WYER.—“Gas and Oil Engines and Gas Producers.” Chicago, 1908.
- J. E. DOWSON and A. T. LARTER.—“Producer-Gas.” London, Second Edition, 1907.
- SAMUEL S. WYER.—“A Treatise on Producer-Gas and Gas-Producers.” New York and London, 1906.
- A. HUMBOLDT SEXTON.—“Producer-Gas: A Sketch of the Properties, Manufacture, and Uses of Gaseous Fuel.” Manchester, N.D.
- C. ALFRED SMITH.—“Suction Gas Plants.” London, 1909.
- W. ROBINSON.—“Gas and Petroleum Engines.” London and New York, Second Edition, 1902.
- W. A. BONE.—Article “Fuel,” in Sir E. THORPE’s “A Dictionary of Applied Chemistry.” London, 1912, Vol. II.
- F. C. FOGG.—“Gas Producers and Gas-Fired Furnaces,” *Chemical World*, 1912, Vol. I., pp. 385, 419.
- B. BLOUNT and A. G. BLOXAM.—“Chemistry for Engineers and Manufacturers,” Vol. I., London, Second Edition, 1911.
- “Mond Gas for Power and Heating,” and other pamphlets published by The Power-Gas Corporation Ltd., Stockton-on-Tees, also article in *Chemical World*, London, 1912, Vol. I., p. 235.
- T. F. E. RHEAD and R. V. WHEELER.—Papers on the combustion of carbon, *Journal of the Chemical Society (Transactions)*, London, 1910, Vol. XCVII., p. 2178; 1911, Vol. XCIX., p. 1140; 1912, Vol. CI., pp. 831, 846.
- W. A. BONE and R. V. WHEELER.—Papers on producer-gas in *Journal of the Iron and Steel Institute*, London, 1907, Vol. LXXIII., p. 126; 1908, Vol. LXXVIII., p. 206.
- O. HAHN.—Papers on the reaction $\text{CO} + \text{H}_2\text{O} = \text{CO}_2 + \text{H}_2$ in *Zeitschrift für physikalische Chemie*, Leipzig, 1903, Vol. XLII., p. 705; Vol. XLIV., p. 513; 1904, Vol. XLVIII., p. 735.
- L. LOGAN.—*Bull. Dept. Gas Eng., Johns Hopkins Univ.*, 1930.
- Joint Committee of the Institute of Gas Engineers*, 31st Report and earlier reports record much progress.

CARBON MONOXIDE

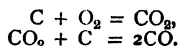
THE term “**producer-gas**” is applied to any gaseous fuel obtained from solid fuel in a “gas producer,” in which the solid fuel is, as far as possible, completely consumed by means of partial oxidation, so as to give a combustible gas and leave no combustible residue. In actual practice the oxygen required for the combustion of the solid fuel in making producer-gas is obtained either from the air, from water, or (more frequently) from both sources. Hence three main varieties of producer-gas may be distinguished—**air-gas**, **water-gas**, and **semi-water-gas**—and as the essential component of each of these gases is carbon monoxide (or carbonic oxide), CO, some information may first be given concerning this gas.

Carbon Monoxide is obtained when carbon, or carbonaceous material, is

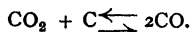
burnt in a supply of oxygen or air insufficient to convert it into the dioxide, according to the equation—



The reaction is very frequently considered to take place in two stages. Firstly, according to this view, part of the carbon is converted into the dioxide, which then reacts with the remaining carbon to produce the monoxide, thus:—



On the other hand, **Dixon**¹ has found that small quantities of the monoxide are produced by the action of oxygen on carbon at 500° C., whereas the reduction of carbon dioxide by carbon does not appear to take place below 600° C. Further, **Baker**² has found that perfectly dry oxygen will combine with carbon only with difficulty, and that the chief product is then the monoxide. Possibly both reactions take place simultaneously between carbon and oxygen, as indicated by the more recent work of **Rhead** and **Wheeler**. At any rate a state of equilibrium is established through the reversible reaction—



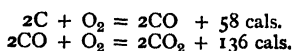
This reaction has been fully studied by **Rhead** and **Wheeler**, who found, in accordance with **Le Chatelier's** theorem, that—

$$\frac{19,500}{T} + \log_e P + \log_e \frac{C_1^2}{C_2} = \text{a constant,}^3$$

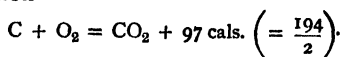
where T is the temperature, P the pressure, C₁ the concentration of CO, and C₂ the concentration of CO₂. This formula shows that both increase in temperature and decrease in pressure favour the formation of the monoxide, which is only to be expected from the fact that the reduction of carbon dioxide by carbon is accompanied by the absorption of 39 cal. per gram-molecule of dioxide

Carbon monoxide is a colourless, tasteless, and almost inodorous gas.⁴ It is almost insoluble in water, but is readily absorbed by an acid or ammoniacal solution of cuprous chloride.

Carbon monoxide readily burns in oxygen or air with a lambent blue flame, forming the dioxide. A trace of moisture, however, must be present, such as is always the case with ordinary air, otherwise combustion will not take place. On combustion, carbon monoxide liberates heat amounting to 68 cal. per gram-molecule. The formation of carbon monoxide from carbon is also exothermic (*i.e.*, heat-producing), the heat liberated being 29 cal. per gram-molecule. The following thermic equations may, therefore, be written—



and for complete combustion—



It is obvious, therefore, that in the conversion of carbon into carbon monoxide about 30 per cent. of the heat obtainable by complete combustion is evolved. Thus, for 1 lb. of carbon the theoretical yields are as under—

	C	→	CO	→	CO ₂
Weight,	1 lb.	→	2½ lbs.	→	3½ lbs.
Heat,		→	1,096 cal.	→	2,571 cal.
			Total	→	3,667 cal.

Carbon monoxide is a very poisonous gas, even the presence of very small quantities in the air giving rise to unpleasant and dangerous symptoms. These effects are due to the fact that the carbon monoxide combines with the hæmoglobin of the blood. Traces of the gas may be detected

¹ *Journal of the Chemical Society (Transactions)*, 1899, Vol. LXXV., p. 630.

² *Philosophical Transactions of the Royal Society*, 1888, Vol. CLXXIX. (A), p. 571.

³ A slight increase in the value of the constant was noted with rise in the temperature, and accounted for on theoretical grounds. See the reference given under "Literature."

⁴ Generally said to be odourless, but see **Roscoe** and **Schorlemmer's** statement in their "A Treatise on Chemistry," Vol. I.

by shaking the suspected air (after freeing, if present, from ammonia and sulphuretted hydrogen) with a solution of palladium chloride. 0.05 per cent. of the gas is sufficient to produce a precipitate. Cases of carbon monoxide poisoning should be treated by removing the patient into warm, fresh air, application of warmth, artificial respiration, and the administration of oxygen. Medical aid should be called in at once.

AIR-GAS

The following general description of a "gas-producer" is quoted from **Bone**:—
 "A modern gas-producer consists of a cylindrical furnace, 6-12 ft. internal

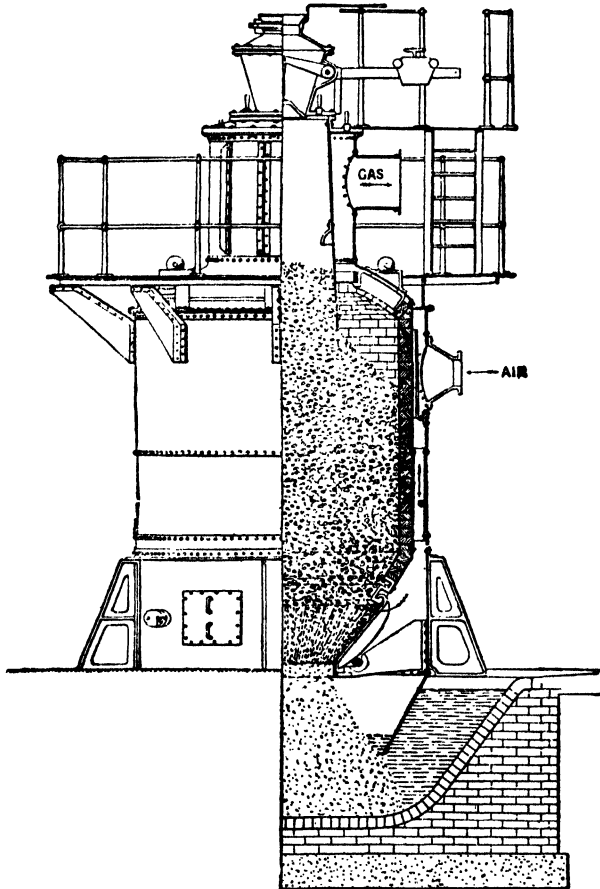


FIG. 1.—Water-Sealed Mond Producer. Showing how air is blown in through the circumferential grate at the bottom.

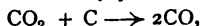
(Power-Gas Corporation Ltd., Stockton-on-Tees.)

diameter, and 10-15 ft. high, lined with fire-brick with an outer mild steel casing, and usually water-sealed at the bottom. Means are provided (1) for the introduction of the blast through some form of grate or twyer fixed immediately above the level of the water in the seal, and its regular distribution through the bed of incandescent fuel (usually 3-5 ft. in thickness) which rests upon a lower bed of ashes; and (2) for the charging in of the raw fuel through (usually) some form of bell hopper fixed centrally on the top of the producer, round which are

arranged a number of equidistant poking holes closed by iron balls. The gas outlet is fixed near the top of the cylindrical furnace."¹ (See Fig. 1.)

When such an apparatus having, however, a solid, not water-sealed bottom, is charged with any carbonaceous fuel (e.g., coal or coke) and worked **with an air blast only**, the resulting gaseous fuel is known as "**air-gas**."² The amount of air supplied must not, of course, be sufficient to oxidise the fuel to the fullest extent, since what is aimed at is the production of the maximum amount of carbon monoxide and the minimum amount of dioxide. The air, meeting with the hot fuel at the bottom of the grate, may be considered to oxidise it mainly to carbon dioxide, but this, passing through the higher layers of hot fuel, is reduced to the monoxide. Thus in Fig. 2, which is a diagrammatic sketch of a producer, the hot air, entering at E, and passing through the fire-bars, burns mainly to carbon dioxide in the lower part of the furnace. Then, passing through the upper layers of red-hot fuel, it takes up more carbon and is reduced to the monoxide. The resulting air-gas passes through the exit C. A is the charging-hopper for the fuel, s s s are holes for poking, etc., and D is a door for cleaning the fire-bars.

From what has been said above, it follows that two things are necessary to the production of a good air-gas:—(1) The fuel must be stacked high; and (2) the temperature of the fuel must be kept high, since, in agreement with the results of **Rhead** and **Wheeler's** experiments already quoted, the reversible reaction,



takes place more rapidly in the direction of the arrow at high temperatures. Experiments carried out by **Rhead** and **Wheeler**, in which the carbon dioxide employed was diluted with nitrogen so as to approximate to the actual conditions holding in the manufacture of air-gas, show that "a temperature of over 1,100° C. must prevail in the fuel-bed if the fairly complete reduction of carbon dioxide desired is to be obtained." Owing to the high temperature needed, it is necessary to take precautions against clinkering troubles. These may be overcome by the addition of limestone to the fuel. This device is employed in the **Thwaite** cupola producer³ (Fig. 3). The limestone forms a liquid slag which is tapped at intervals.

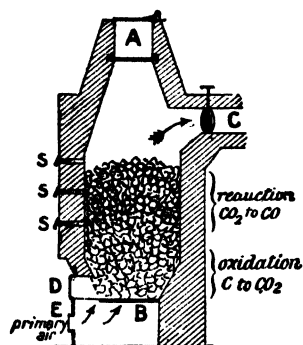


FIG. 2.—Section through a Producer.

(With permission of Messrs Longmans, Green & Co.)

It will be seen from the equations given under "carbon monoxide" that in the production of air-gas, nearly one-third of the total heat available from the fuel is converted into sensible heat. When the gas is to be burned in large furnaces, for which purpose preliminary cleaning is not necessary, most of this sensible heat may be utilised if the gas has only to travel a short distance to the furnace. Otherwise the sensible heat of the gas may be employed, by a system of regeneration, to heat the air with which it is to be burned; or it may be used for other purposes, according to the nature of the industry using the gas plant—the effecting of evaporation and the working of sulphur dioxide engines may be mentioned as two cases in point.

The composition of air-gas will, of course, largely depend upon the nature of the fuel used. The ideal gas obtained from pure air and pure carbon would consist by volume of 34.7 per cent. carbon monoxide and 65.3 per cent. nitrogen.⁴ In actual practice, however, it is not possible to avoid a small percentage of carbon dioxide, and when coal (not coke) is used as the solid fuel, a small amount of methane (which is, however, valuable as a fuel) is always present owing to the distillation of the coal of the top layers in the producer.

The following may be given as two typical analyses. No. 1 refers to air-gas made in a

¹ Art. "Fuel" in Thorpe's "A Dictionary of Applied Chemistry." (Quoted by permission of the publishers, Messrs Longmans, Green & Co.)

² The name "air-gas" is also sometimes used for air charged with the vapour of a light hydrocarbon, e.g., pentane, which has a limited use both as an illuminant and as a fuel. (See **Mr Dancaster's** article on "The Illuminating Gas Industry" in **Martin's** "Industrial Chemistry: Organic.")

³ English Patent, 16,986, 1902.

⁴ Here, as elsewhere, by "nitrogen" is meant "nitrogen including argon, etc."

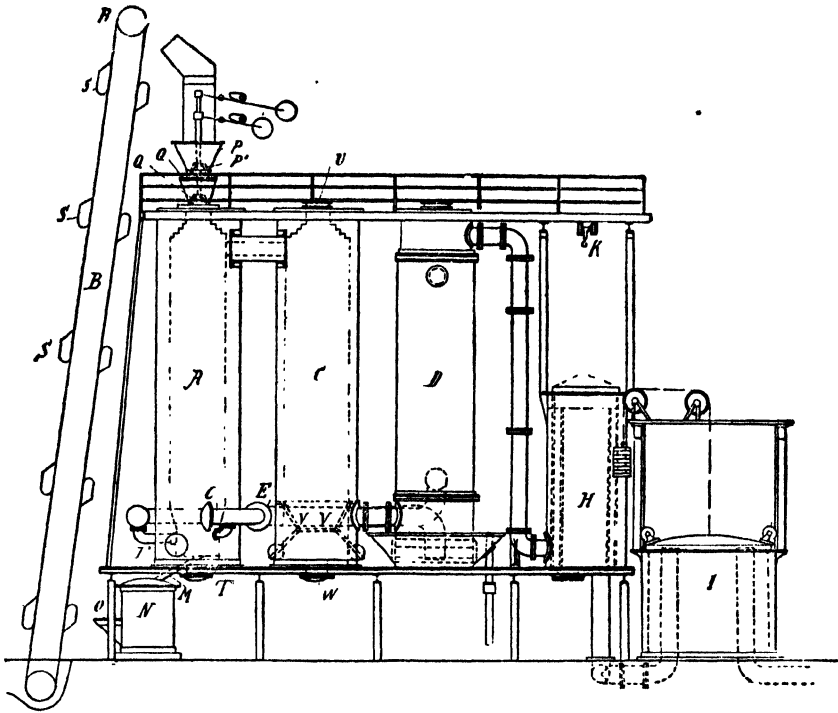


FIG. 3.—Thwaite Cupola Producer.

Thwaite producer from Lancashire slack coal, and is given by Bone. No. 2 refers to air-gas made from coke in a small Dowson plant, and is from Dowson and Larter's work referred to under "Literature."

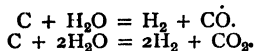
	No. 1.	No. 2.
	Per Cent.	Per Cent.
Carbon monoxide - - - - -	29.0	32.6
Hydrogen - - - - -	5.35	1.0
Methane - - - - -	2.05	...
Total combustible gases - - -	36.4	33.6
Carbon dioxide - - - - -	2.0	1.4
Nitrogen - - - - -	61.6	65.0
Total incombustible gases - -	63.6	66.4
Caloric power, B. T. U. per cubic foot -	130.8-138.7 ¹	114.5-115.0

WATER-GAS

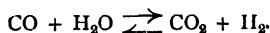
In the manufacture of water-gas, the oxygen needed for the combustion of

¹ These are what are termed respectively the "net" and "gross" calorific powers. The "gross" value gives the amount of heat obtained when the products of combustion are cooled, so that liquid water is obtained; the "net" value gives the amount of heat obtained when (as in most cases of actual usage) the water is reckoned to be present wholly as steam. The percentages in these and following analyses refer to the volumes of the gases.

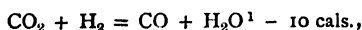
the solid fuel is obtained, not from the air, but from steam. Steam reacts with carbon according to one or other of the following equations:—



It is a matter of uncertainty which reaction takes place first: perhaps both carbon monoxide and carbon dioxide are formed simultaneously, as in the simple combustion of carbon. But in any case a final condition of equilibrium is reached through the reversible reaction:—



Both of the former reactions are strongly endothermic: the first absorbing about 29 cal. per gram-molecule of carbon, whilst the second requires about 19 cal. It is obvious, therefore, that these reactions will only take place when heat is supplied from without, and since it follows that

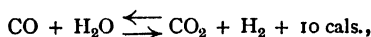


it is obvious that high temperatures will favour the occurrence of the first reaction. These conclusions are borne out by experiment. The following results, due to Dr Bunte, are quoted from Robinson's work referred to under "Literature" (p. 119):—

TABLE SHOWING THE ACTION OF STEAM ON CARBON (BUNTE).

Temperature in Degrees C.	Per Cent. of Steam Decomposed.	Composition, by Volume, of Gas Produced.		
		H ₂	CO.	CO ₂
674	8.8	65.2	4.9	29.8
758	25.3	65.2	7.8	27.0
838	41.0	61.9	15.1	22.9
954	70.2	53.3	39.3	6.8
1,010	94.0	48.8	49.7	1.5
1,060	93.0	50.7	48.0	1.3
1,125	99.4	50.9	48.5	0.6

Hahn has more recently studied the reversible reaction,



and has found, in agreement with the law of mass-action, that the ratio, $\frac{\text{CO} \times \text{H}_2\text{O}}{\text{CO}_2 \times \text{H}_2}$ (where the symbols stand for the concentration of the gases present), is constant for any given temperature; and further, in accordance with the above conclusion, that the value of the constant increases with a rise in the temperature, from 0.81 at 786° C. to 2.49 at 1,405° C.

In order, therefore, to prevent the formation of more than a negligible proportion of carbon dioxide in the manufacture of water-gas, the reacting materials should be maintained at a temperature not below 1,000° C. In actual practice it has been found altogether unsatisfactory to supply the heat necessary to maintain this temperature by any system of external heating, owing to the loss of heat in transmission from without to within the producer. This method was at first attempted, but now the necessary heat is invariably obtained by combustion in air of part of the solid fuel employed. The process is intermittent; and in the earlier forms of it air-gas is produced alternatively with water-gas in the following manner:—The producer must be supplied with two outlets. First of all air is blown in, which produces air-gas and heats the fuel to the requisite temperature. This is known as the "hot-blow," "air-blow," or simply as the "blow," and lasts about ten minutes. The air-gas is taken off from one outlet, and is used to produce steam for the "cold-blow," "steam-blow," or "run," lasting about four minutes. Water-gas is meanwhile

¹ In this, as in all other thermo-chemical equations which follow in which water figures, the water is assumed to be in the state of vapour.

taken off at the other outlet. When the temperature has fallen below that at which the reaction can be advantageously carried out, the steam is cut off and air is again blown in to heat the fuel. However, the production of air-gas during the "blow" has now been given up, in preference to plants in which the whole of the heat obtainable from a portion of the fuel is used to produce the desired temperature. This has led to a great reduction in the time of the "blow."

In Messrs **Dellwik** and **Fleischer's** water-gas producer,¹ the layer of fuel is less deep than in the older forms. The object of this is that during the "blow" that portion of the fuel consumed is burnt completely to carbon dioxide. By this means the requisite temperature is obtained far more quickly—the blow lasts only about one minute—and at the expense of less fuel. The apparatus is shown diagrammatically in Fig. 4. Of course, when carbon dioxide instead of air-gas results from

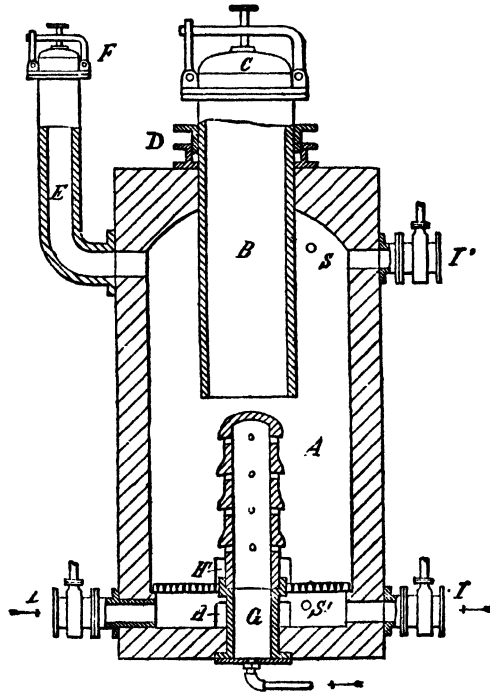


FIG. 4.—Dellwik and Fleischer's Plant.

the "blow," extra fuel must be burnt to produce the steam required for the "run," but it is found that there is a considerable saving in fuel on the whole, as well as a considerable saving of time.

In order to render the production of gas continuous, plants have been devised in which two producers are worked together, one being "blown," whilst the other is "run," and vice versa.

"A is the generator provided with a coal receptacle B . . . of cast iron; this coal receptacle passes through a stuffing box D placed on the cover or top of the generator. Under the grating is arranged the main air inlet L, and the gas outlet I, and steam inlet s'. The generator is also provided with cleaning doors H and H'. In the upper part there is an outlet pipe E, for the combustion products, which pipe is closed during the period of the production of water-gas by the valve or cover F. I' is an outlet for water-gas and s is a second steam inlet. The coal receptacle B is charged with coal, coke, or other suitable fuel, and then closed by the door or cover C. The air inlet is arranged under the grate and preferably continued into the layers of fuel by an appropriate pipe G, provided with numerous air nozzles or apertures, so that a thorough contact of the air with the whole mass of fuel is obtained. When the proper height of a given description of fuel for a given amount of air pressure has been determined by testing by means of the adjustable receptacle B shown in the figure, the cast-iron receptacle is advantageously replaced by one made of fire-bricks."

¹ English Patent, 29,863, 1896.

Ideal water-gas should consist of 50 per cent. of carbon monoxide and 50 per cent. of hydrogen by volume. But in actual practice, of course, small amounts of carbon dioxide and nitrogen cannot be avoided.

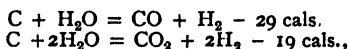
The following may be given as typical analyses:—No. 1 refers to water-gas made at Essen from coke by the older process in which air-gas is produced during the "blow," and is taken from Fischer's "Handbuch der Chemischen Technologie" (15th ed.), Vol. I, p. 50. No. 2 refers to water-gas made in the improved plant of Dellwik and Fleischer. The two samples differ in composition very slightly from one another.

	No. 1.		No. 2.	
	Per Cent.		Per Cent.	
Carbon monoxide - - - -	44.0		43.0	
Hydrogen - - - -	48.6		49.0	
Methane - - - -	0.4		0.5	
Total combustible gases - -	93.0		92.5	
Carbon dioxide - - - -	3.3		4.0	
Nitrogen - - - -	3.7		3.5	
Total incombustible gases - -	7.0		7.5	
Calorific power, B. T. U. per cubic foot -	295.5	323.5	290	340

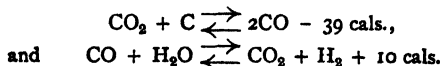
SEMI-WATER-GAS

Semi-water-gas is produced by blowing simultaneously steam and air through red-hot coke or other carbonaceous material, and is by far the most important type of producer-gas, so much so that it is frequently meant when the term "producer-gas" is employed without further qualification.

It was pointed out under "Air-Gas" that in manufacturing this from carbonaceous fuel, about 30 per cent. of the available heat was converted into sensible heat. This, of course, is a source of waste, though, as already pointed out, a good deal of this heat may be utilised by means of various devices. Now if steam is passed through the fuel in the producer as well, it is obvious that one or other of the endothermic reactions between it and carbon,



will take place at the expense of this sensible heat. In other words, one or other of these reactions will convert the sensible heat into potential chemical energy, which will be obtainable again as sensible heat by combustion of the resulting gaseous fuel. The exact order in which the various reactions between the carbon, oxygen, and water take place is rather uncertain, but in any case a condition of equilibrium is obtained through the two reversible reactions dealt with under "Carbon Monoxide" and "Water-Gas" respectively, namely—



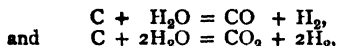
And the result is the same as if one or other of the above reactions took place between carbon and steam concomitantly with the combustion of another portion of the carbon in the air to carbon monoxide, *i.e.*,



By adjusting the ratio between the amounts of steam and air, it ought to be possible to absorb all the heat given out by this last reaction, by that between the steam and the carbon. And for this purpose the two forms of this reaction are almost as good as one another, since that in which carbon dioxide is produced gives an additional amount of hydrogen, with a heat of combustion but little less than that of the carbon monoxide otherwise formed (58 cal. net per gram-molecule in the first case, to 68 cal. in the second), though the formation of carbon dioxide serves to dilute the gas somewhat, giving a larger volume of gas, but decreasing the calorific power of a given volume. But, of course, this is not actually possible, since there is a temperature below which the reactions will not take place at all, and to maintain this it is necessary that the sum total of the

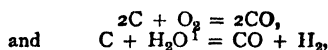
reactions should be exothermic. Moreover, in actual practice an additional amount of carbon dioxide is always produced. But an approximation to the ideal condition of things is made, and the addition of the steam blast to the air blast increases the economy of production enormously, and yields a gas at a less high temperature than with air blast alone, and of a considerably increased calorific power. When it is necessary to cool the gas (*e.g.*, for use in gas engines), its sensible heat may be used, by a system of regeneration, to heat the air blast.

The extent to which the reactions,

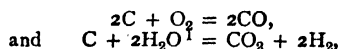


take place depends upon the ratio of the steam blast to the air blast. For furnace purposes the hydrogen content of the gas should not exceed 14 per cent., hence it is desirable that the first and not the second of these reactions should occur. On the other hand, this is not of importance if the gas is to be employed for power purposes; and by the use of an excess of steam, in which case the second rather than the first of these reactions takes place, it is possible to recover, in the manner described below, much of the nitrogen of the fuel as ammonia.

Ideal producer-gas made by the reactions—



would have a composition by volume of CO, 39.9 per cent.; H₂, 17.0 per cent.; and N₂, 43.1 per cent.; whereas that made by the reactions—



would have a composition by volume of CO, 19.8 per cent.; H₂, 28.7 per cent.; CO₂, 14.4 per cent.; and N₂, 37.1 per cent.

The following typical analyses by **Sexton** of various samples of producer-gas show an approximation to the first of these ideal gases, except No. 4, which approximates to that of the second type; but in every case, as might be expected, the nitrogen content is much in excess of the theoretical.

ANALYSIS OF SEMI-WATER-GAS (Sexton)

	No. 1.	No. 2.	No. 3.	No. 4.	No. 5.
	Per Cent.	Per Cent.	Per Cent.	Per Cent.	Per Cent.
Carbon monoxide . . .	24.40	26.40	27.00	16.15	20.40
Hydrogen	8.60	12.13	10.90	19.43	12.60
Methane, etc.	2.40	2.00	1.28	2.66	3.50
Carbon dioxide	5.20	9.16	4.50	11.53	5.50
Nitrogen	59.40	50.31	56.32	50.23	58.00

In 1906-7 **Bone and Wheeler** (*loc. cit.*) carried out a series of experiments to determine the influence of varying blast steam saturation temperatures upon the composition and yield of the gas from a Lancashire bituminous coal, the results of which are tabulated on p. 128.

¹ Steam raised by part of the heat of the accompanying exothermic reaction.

RESULTS OF EXPERIMENTS BY BONE AND WHEELER.

	3½ ft.					7 ft.				
	22.5 cwt.					11.5 cwt.				
	45°	50°	55°	60°	70°	60°	65°	70°	75°	80°
Average depth of incandescent fuel										
Average rate of gasification (day-shift) per hour per producer										
Steam saturation temperature of blast										
Composition of gas, per cent.—										
Carbon monoxide	31.60	30.60	28.10	27.30	0.85	27.30	25.40	21.70	18.35	16.05
Hydrogen	11.60	12.35	15.45	15.50	19.75	15.50	18.30	19.65	21.80	22.65
Methane	3.05	3.00	3.00	3.05	3.45	3.05	3.40	3.40	3.35	3.50
Carbon dioxide	2.35	2.50	4.40	5.10	9.25	5.10	6.95	9.15	11.65	13.25
Nitrogen	51.40	51.55	49.05	49.05	46.70	49.05	45.90	46.10	44.85	44.55
Caloric power in B. T. U. } per cubic foot at 0° and } 760 mm. } Net	180.0 170.5	178.5 168.7	180.8 169.1	178.7 166.9	175.5 161.0	178.7 166.9	185.4 172.0	177.5 163.3	172.0 157.3	169.5 154.3
Yield of gas, cubic feet at 0° and 760 mm. per ton coal	133,700	132,500	132,700	135,000	...	138,250	134,400	141,450	145,800	147,500
Steam added to blast, pounds per pound coal	0.2	0.21	0.32	0.45	...	0.45	0.55	0.80	1.10	1.55
Per cent. steam decomposed	All	All	All	76.0	...	76.0	80.0	61.0	52.0	40.0

TYPES OF GAS-PRODUCERS

It will be impossible here to attempt to give a description of the very many different kinds of gas-producers now in use. A great deal of attention has recently been devoted to the subject, and very many patents have been taken out in recent years, though a large proportion of these are concerned only with improvements in matters of detail. For consideration of such matters the reader should consult the special books dealing exclusively with the subject noted under "Literature." All that can be done here is to give a brief description of the most important and typical producers.

The simple form of gas-producer with a flat grate near the bottom is now practically obsolete, owing to the difficulty of removing the clinker when such a

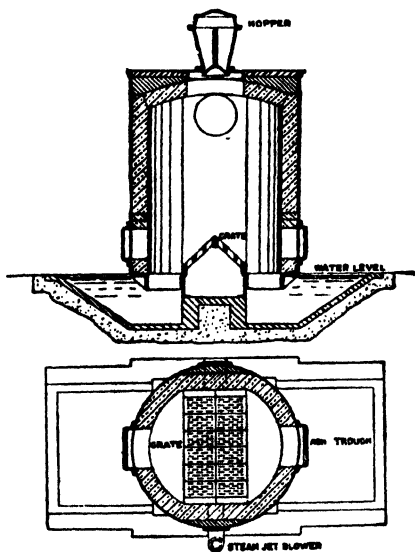


FIG. 5.—The Duff Producer (two views).

(Taken from Mr F. G. Fogg's article in "The Chemical World" of Nov. 1912, and reproduced with kind permission of the editor, Mr Dreyer, and the publishers, Messrs J. & A. Churchill.)

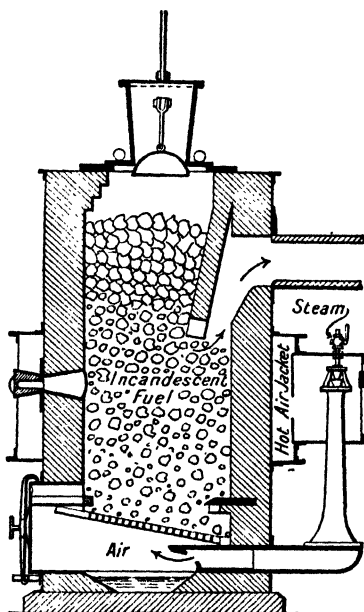


FIG. 6.—Thwaite "Simplex" Producer.

grate is employed. The chief aim of modern producers is to effect the various stages of gas-production by mechanical means as far as possible, and thus render the whole process continuous. Modern gas-producers may be roughly classified according to the type of grate used and the manner in which the air blast is admitted, as under :—

1. **Diagonal Grate Producers.**—In the Duff producer (Fig. 5) the grate bars, as will be noticed from the diagram, run across the bottom of the producer, not, however, occupying the whole area, forming in section an inverted "V." The air blast enters beneath the grate, whose form ensures that the air is uniformly distributed over a large area of fuel, and readily admits of the clinker being pushed into the water trough below. In the Thwaite "Simplex" producer (Fig. 6) the grate, underneath which the air blast and steam enter, slopes in one direction only. This producer is also water-sealed.

2. **Circumferential Grate Producers.**—The Mond producer belongs to this type, the grate being made of an inverted truncated cone of fire-bars through which the blast enters. The shape admits of the ready removal of the ash. The

producer is made both with a water-seal for fuels giving a small percentage of ash (Fig. 1) and with a mechanical dry ash discharge, which automatically delivers the ash from the bottom of the apparatus for use with fuels having a high ash content (Fig. 7). For the special advantages of the **Mond** apparatus see below, "Ammonia Recovery in the Manufacture of Semi-Water-Gas."

3. **Central Blast Producers.**—In producers of this type the blast enters through a louvred cone (*i.e.*, a cone consisting of a number of plates) placed centrally near the bottom of the producer, the grate bars being usually dispensed

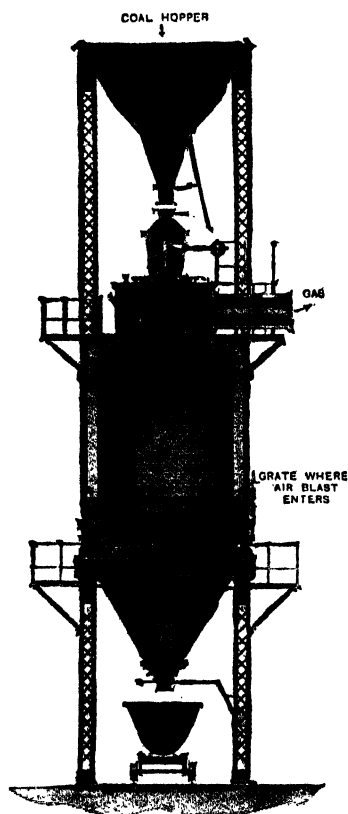


FIG. 32.—The Mond Producer, with Mechanical Dry Ash Discharge.

(The Power-Gas Corporation Ltd., Stockton-on-Tees.)

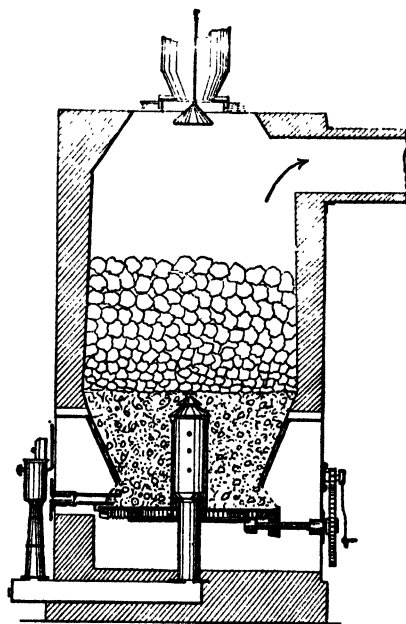


FIG. 33.—The Taylor Revolving Bottom Gas Producer (internal diameter, 6 feet).

with. The **Taylor** "Revolving Bottom," **Talbot** and **Kerpeley** producers may be instanced as well-known examples of this type. In the **Taylor** producer (Fig. 8) the mixture of steam and air is delivered by means of a pipe, fitted with a conical distributor, rather high up in the apparatus. The fuel and clinker rest upon a revolving plate, underneath which is a closed ash-pit. By rotating the bottom when necessary, the height of the clinker is maintained at about six inches above the level of the steam and air inlet, and, by this means also, air-passages that may have been formed by the action of the blast are closed up. The **Talbot** producer (Fig. 9) is provided with a central blast of the usual type, and a double mechanical feed, as shown in the diagram. The apparatus is water-sealed and the clinker is removed by hand from the water trough. The **Kerpeley**

producer (Fig. 10) has a revolving grate and hearth. The blast distributor, which is fixed to the grate, is in the shape of a cone with its apex rounded. The lower portion of the apparatus is cooled by means of a water jacket. This obviates the clinker adhering to the sides, which would interfere with the rotation of the grate. The ashes in the rotating water trough are deflected over the side by means of a

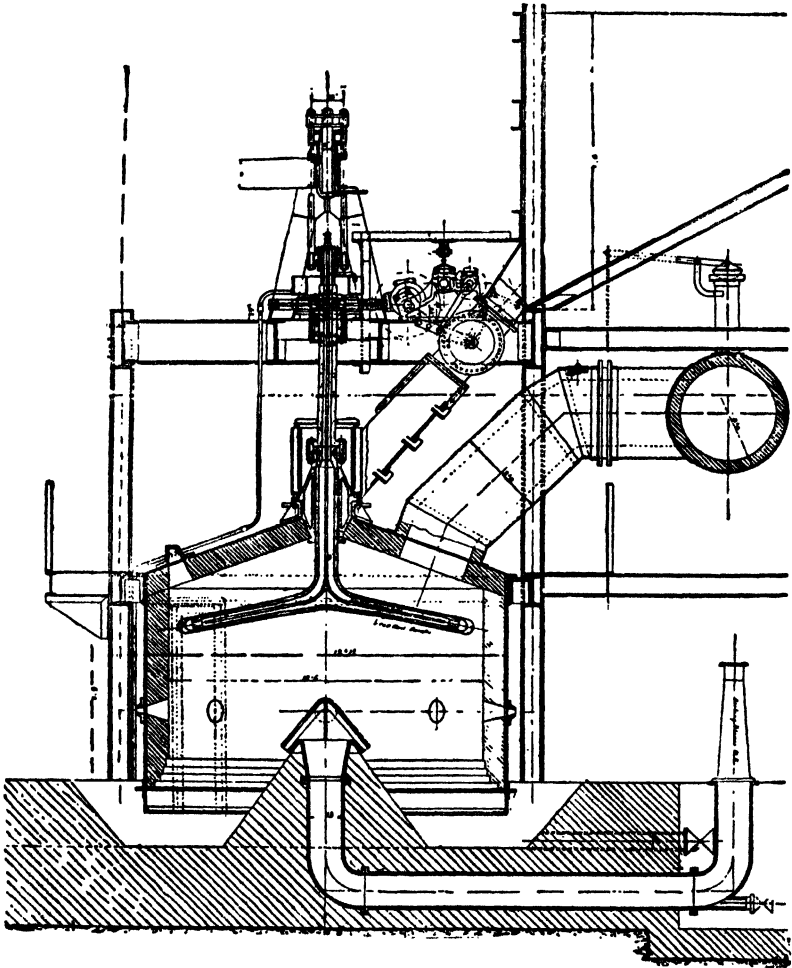


FIG. 9.—The Talbot Producer.

(Taken from Mr F. G. Fogg's article in "The Chemical World," Dec. 1912, and reproduced with kind permission of the editor, Mr Dreaper, and the publishers, Messrs J. & A. Churchill.)

fixed blade set at a convenient angle. (For a description of suction gas-producers see p. 135.)

USES AND ADVANTAGES OF PRODUCER-GAS

Semi-water-gas is employed both in furnaces and in gas engines. For the former purpose, when the furnace is a large one, the gas need be neither cooled nor scrubbed clean. In the case of small furnaces, where there are small stop-cocks, etc., it is desirable, to avoid clogging, to scrub the gas free from tarry matter; and for use in gas engines the gas must be both clean and cool. Many improve-

ments have been effected in gas-fired furnaces since **Siemens** patented his regenerative furnace in 1861; and great advances have been made in the construction of gas engines in recent times. Such subjects, however, lie without the domain of this work.

The advantages of producer-gas over the direct consumption of solid fuel are numerous. Of course, it is not possible to obtain more heat from a given quantity of fuel than is given out when it is burnt to carbon dioxide, and, in fact, there is a loss of heat in the manufacture of producer-gas (even of the semi-water type) owing to the fact that the sum of all the chemical reactions involved is exothermic. But such losses as actually occur through this source in practice are amply made

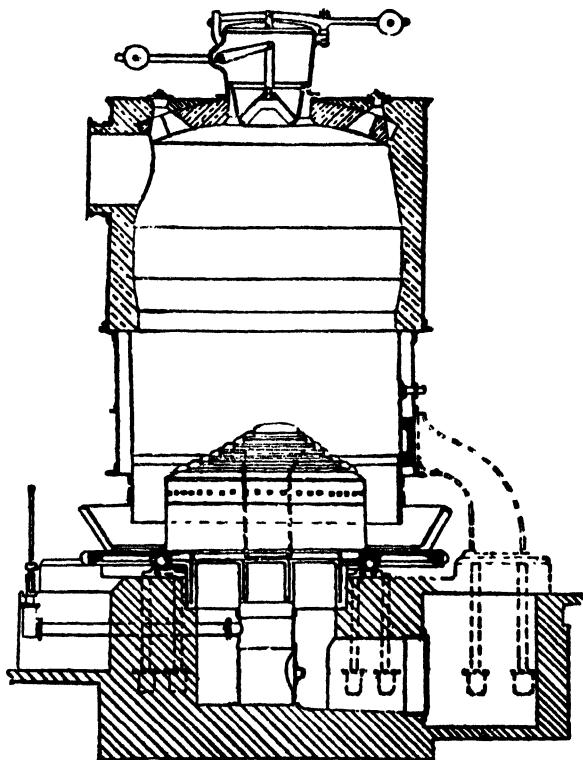


FIG. 10.—The Kerpeley Producer.

(Taken from Mr F. G. Fogg's article in "The Chemical World," Dec. 1912, and reproduced with kind permission of the editor, Mr Dreaper, and the publishers, Messrs J. & A. Churchill.)

up for by the economic manner in which gas can be burned as compared with solid fuel. There are no losses in the case of gas furnaces through smoke or convection currents. The amount of air required for combustion is not much above the theoretical, whereas in furnaces burning solid fuel far more air is necessary than actually takes part in the combustion, so that there is in the latter an extra large volume of gas to carry away sensible heat through the chimneys. Moreover, in gas-fired furnaces the sensible heat of the escaping gases is not wasted but is used on the "regenerative" principle to heat the air for combustion, and **Bone** and **M'Court's** method of surface combustion promises still further advantages in the economic combustion of gaseous fuels (see Section VI., p. 57).

Furthermore, gas is more easily transmitted than solid fuel, gas furnaces may

be maintained at a constant temperature, and a gas fire may be more easily applied in metallurgical work than one burning solid fuel. It is important to notice, also, in connection with metallurgical work, that with gas an oxidising or reducing flame may be obtained at pleasure.

Nothing can be urged against the use of producer-gas as compared with coal on the grounds of efficiency or economy. One objection is that the gas is very poisonous, and that deadly quantities of it may escape into the air without betraying their presence by their odour. But so long as due care is exercised, especially with suction plants to be described later, nothing need be feared on this score. One way out of the difficulty is to flavour the gas, as is done in Germany in the case of water-gas, by bubbling it through mercaptan, a compound which has a pungent and most disagreeable odour.

Something in favour of the use of producer-gas as against solid fuel may be said from another point of view. There can be no doubt that the smoke nuisance is one of the evils of modern times, and renders every great manufacturing town unsightly and unhealthy. **Sir Oliver Lodge**,¹ as well as other writers, have written eloquently on this subject, and dream of the days when coal will invariably be converted into either coal-gas or producer-gas at the pit's mouth, and conveyed to consumers in the form of a clean, non-smoke-producing fuel. Little has been done as yet to supply producer-gas in the way that coal-gas is supplied, it being usual for consumers to make their own gas. But in February 1905 an installation was built by **The Power Gas Corporation Ltd.** (the holders of the **Mond** patents) for **The South Staffordshire Mond Gas Co.**, formed for the purpose of manufacturing and distributing producer-gas throughout a district of about 120 square miles. The plant has run continuously day and night, distributing gas in steel pipes to a large number of consumers using the gas for many different purposes—power, annealing, enamelling, japanning, oxide burning for paint, heating, galvanising, etc.

Finally, as will appear below, producer-gas may with advantage be produced from fuels of too poor a quality to be worth utilising otherwise.

The above remarks apply mainly to gas of the semi-water type. Air-gas is by no means so economical, and is used far less extensively, though some engineers prefer it owing to its freedom from hydrogen, for reasons which seem by no means obvious.

The uses of water-gas depend to some extent upon its greater calorific power as compared with other types of producer-gas, which greater calorific power is due to the fact, of course, that water-gas contains only small quantities of nitrogen, whereas nitrogen is present in large quantities in air-gas and semi-water-gas. It is used in Germany, on this account, for steel-plate welding. Another use for the gas is found in the fact that, although when pure it burns with a pale blue, non-luminous flame, after being carburetted with the decomposition products of petroleum, it gives a satisfactory luminous flame. Such gas is called "carburetted water-gas," whilst the non-carburetted variety is distinguished as "blue water-gas." Water-gas is also used as an illuminant by systems in which "mantles" (e.g., the **Welsbach** mantle) or rods (**Fahnehjelm** system) of refractory material are heated by the combustion of the "blue" non-luminous gas to such a temperature that they emit a strong white light. (For further details see **Mr Dancaster's** article on "Illuminating Gases" in **Martin's** "Industrial Chemistry: Organic.") More recently water-gas has become very important as a source for the manufacture of hydrogen. (See the present writer's article on "Hydrogen" in this volume.)

AMMONIA RECOVERY IN THE MANUFACTURE OF SEMI-WATER-GAS

As mentioned in the section on "Semi-Water-Gas," it is possible, by means of certain modifications in the method, to recover the nitrogen of nitrogen-containing

¹ See "The Smoke Nuisance" in "Modern Problems," 1912.

fuels as ammonia. The **Mond** system was specially devised for this end, though **Mond** plants may also be used for manufacturing producer-gas without nitrogen recovery. It is claimed that by the **Mond** process as much as 70 per cent. of the nitrogen present in the solid fuel may be recovered, and as there is a large demand for ammonium salts as fertilisers, the process is exceedingly profitable in the case of large plants working with fuel of good nitrogen content. Fig. 1, p. 121, shows the construction of the **Mond** producer for ammonia recovery.

The producer, as stated on p. 130, is water-sealed, and the grate is circumferential. The blast must contain a large excess of steam—1 lb. of bituminous fuel requires 3 lbs. of air and $2\frac{1}{2}$ lbs. steam—which serves to keep the temperature down, and thus prevents the decomposition of the ammonia formed, whilst at the same time it minimises the formation of clinker, and so allows of the continuous working of the apparatus. Only about one-fifth part of the steam is actually decomposed, the rest escaping with the gas, part of the heat of which is recovered by means of a tubular regenerator, and is used to raise steam (about 40 per cent. of the total) for the blast. The blast is further heated by being circulated around the producer within an outer casing. The gas is further cooled down to about 90° C. by means of a water spray, which frees it from tar (which may be recovered from the washings). It then passes into a lead-lined tower, where it meets with a stream of ammonium sulphate solution containing about 4 per cent. of free sulphuric acid. The acid extracts the ammonia from the gas,



giving ammonium sulphate. The gas is finally washed with cold water before being used.

For further details regarding Ammonia Recovery, see this volume under **Ammonia**.

Owing to the large proportion of steam used, the reaction between the steam and the carbon of the fuel takes the form—



Consequently the gas differs considerably in composition from ordinary semi-water-gas, containing more hydrogen and carbon dioxide and less carbon monoxide. Moreover, it has a smaller calorific power. But with very large plants working with highly nitrogenous fuels, the gas may be obtained practically without cost owing to the value of the ammonia recovered.

The process, moreover, can be applied with success to peat containing as much as 60 per cent. to 70 per cent. of water, and brown coal containing 50 per cent. to 60 per cent. of water, which cannot be gassified by other processes without being first dried—which cannot be economically effected. For smaller consumers **Mond** plants are made without ammonia recovery, in which case less steam is employed, and a gas containing less hydrogen and carbon dioxide, and more carbon monoxide is obtained.

The following analyses of "**Mond gas**" are published by **The Power Gas Corporation**.¹ No. 1 refers to bituminous fuel with ammonia recovery. No. 2 refers to bituminous fuel without ammonia recovery.

	No. 1.	No. 2.
	Per Cent.	Per Cent.
Carbon monoxide - - - - -	11.0	23.0
Hydrogen - - - - -	27.5	17.0
Methane - - - - -	3.0	3.0
Total combustible gases - - - - -	41.5	43.0
Carbon dioxide - - - - -	16.5	5.0
Nitrogen (and moisture) - - - - -	42.0	52.0
Total incombustible gases - - - - -	58.5	57.0
Calorific power, B. T. U. per cubic foot -	147.4-164.3	157.5-169.2

¹ To whom my thanks are due for kindly supplying me with pamphlets descriptive of the various types of **Mond** producers, etc.

SUCTION GAS-PRODUCERS

In ordinary producer-gas plants the gas is made under a pressure somewhat above the atmospheric, the blast being forced into the apparatus. For furnace purposes the gas may be taken direct from the producer, but when required for gas engines it must first be stored in a gas holder and then delivered under very slight pressure. To avoid the expense of a gas holder, producers have been devised in which the gas is produced moment by moment, as required, by the sucking action of the gas engine driven by the gas produced. Each movement of the piston draws a fresh supply of gas from the producer, and an equal volume of air and water-vapour is consequently sucked into it.

The generation of gas must be initiated by means of a blower, and the engine is not started until the gas is found to burn satisfactorily at the test-cock. The gas is cleaned in a scrubber, and preferably dried in a dryer before entering the engine. The production of gas continues so long as the engine is working, and ceases when the engine stops and, thus, no longer sucks air and water-vapour into the producer. Suction plants, of course, give most satisfactory results when the

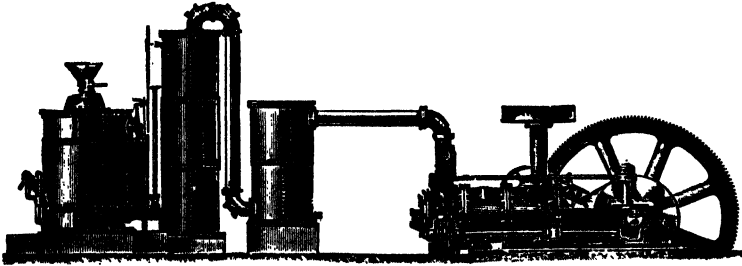


FIG. 11.—Mond Suction Plant and Engine.

(Power-Gas Corporation Ltd.)

engine is running at full load, as otherwise the quality of the gas is liable to deteriorate.

A further economy is effected by the fact that no boiler is required in conjunction with these plants, its place being taken by a "vaporiser" or "evaporator," of which perhaps the best form is that of an internal annular boiler, as in the Mond suction producer (Fig. 11), the Dowson plant, and others. This raises steam by means of the waste heat of the producer, the needed air also being sucked into the apparatus through the vaporiser.

The details of the Dowson (30 B. H. P.) plant, as a modern and fairly typical suction producer, are shown diagrammatically in Fig. 12, and the following description of the apparatus and the manner of working it is quoted from Dowson and Larter's work referred to under "Literature." "A is the grate on which the fuel rests; B is the container holding a store of fuel which is admitted through the hopper and valve at the top; C is a chamber filled with loose pieces of fire-brick; D is a circular pipe with holes in the top, which receives water from the feed-pot E; F is the air inlet, and G the gas outlet, with test-cock at H; I is a chimney or waste pipe; J is a coke scrubber with water-seal at the bottom; K is the gas outlet. . . . A small hand-power fan (not shown in the figure) [is used] for blowing up the fire at the start. When the plant is to be worked, a little oily waste and some wood are put on the grate A, and the producer is filled with anthracite or coke in small pieces. The feeding hopper is then closed, and the cock on the waste pipe I is opened; the fire is then lighted through a door on the level of grate A; the fan is set in motion, and the products are in the first instance allowed to escape through the pipe I. The water supply is turned on, and as soon as gas will burn well at the test-cock H, it is ready for use in the engine; the waste pipe I is then closed, and the gas is blown off through a waste pipe near the engine until good gas from the producer reaches the gas-cock on the engine. The engine is then started and the fan is stopped. From this time the engine itself draws in the air required for the producer, as well as the water to be vaporised in the chamber C, the mixture of steam and air passing downwards from C, through L, to the underside of the grate A."

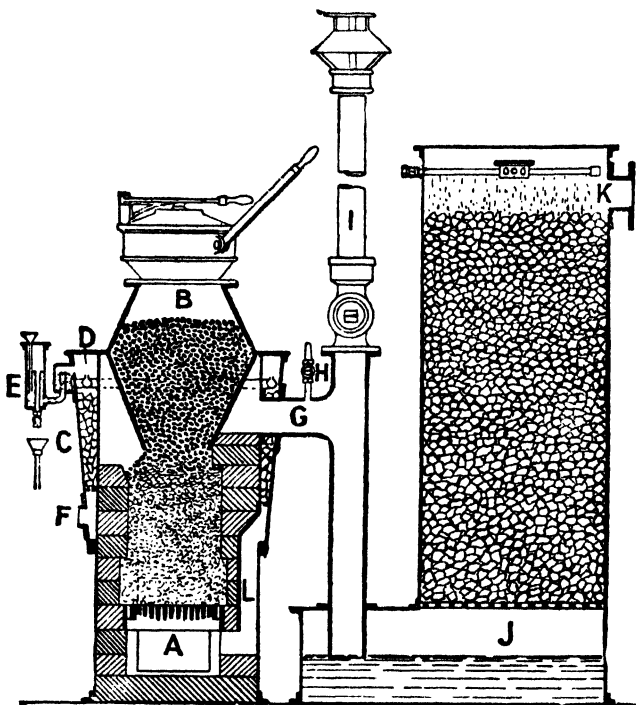


FIG. 12.—Dowson Suction Gas-Producer.

BLAST-FURNACE-GAS

The name "blast-furnace-gas" is given to the waste gas derived from furnaces used in the smelting of iron and other ores. In composition the gas is the same as a low grade producer-gas, its calorific power varying from about 90 to 100 B.T.U. per cubic foot. It is frequently employed as a gaseous fuel, and thus, as it resembles producer-gas in its composition and its industrial uses, it may be dealt with in the present place.

The composition of the gas is variable, but the following figures are given by **Blount** and **Bloxam** as typical analyses, on the authority of **Turner**.

In the case of No. 1 coke was the fuel employed, whilst bituminous coal was used in the case of No. 2:—

	No. 1.	No. 2.
	Per Cent.	Per Cent.
Carbon monoxide - - - -	25	28.0
Hydrogen - - - - -	2	5.5
Methane - - - - -	2	4.4
Total combustible gases - -	29	37.9
Carbon dioxide - - - - -	12	8.6
Nitrogen - - - - -	59	53.5
Total incombustible gases - -	71	62.1

In some cases, however, the content of carbon monoxide may be as high as 30 per cent.

Until 1837, when attention was called to the matter by *Dufaur*, this valuable source of energy had been entirely neglected. Plants were then devised and erected whereby about 50 per cent. of the blast gases were employed to heat the blast, being burnt in furnaces of the "regenerative" type, and about 40 per cent. were used for boiler firing to produce steam, the remaining 10 per cent. being wasted. But the efficiency of such boilers was unsatisfactorily low.

Nowadays the improvements that have been effected in gas engines and the introduction of large gas engines have rendered possible the more efficient utilisation of blast-furnace-gas, and it is now extensively used for this purpose. Before entering the engine the gas must be cooled to about 19° C., and the dust, which, of course, is usually present in such gas in considerable quantities, must be reduced to not more than 0.01 g. per cubic metre—a quantity which is negligible. To effect this the gas is first passed through one or other of the usual forms of dry-cleaning apparatus. It is then washed with water, a centrifugal apparatus being employed, either alone or after ordinary water-washing, in which the gas is thoroughly agitated with water in the form of fine spray. Ammonia, as well as tar, can be recovered from the water used for washing gases from blast furnaces in which raw coal is burnt.

SECTION XIV

THE CARBON DIOXIDE (CARBONIC ACID) INDUSTRY

BY H. STANLEY REDGROVE, B.Sc.(Lond.), F.C.S.

LITERATURE

- J. C. GOOSMANN, M.E.—“The Carbonic Acid Industry.” Chicago, 1907.
- Dr E. LUHMANN.—“Die Kohlensäure.” Vienna and Leipzig. Second Edition, N.D. [1906].
- Dr E. LUHMANN.—“Die Fabrikation der flüssigen Kohlensäure.” Berlin, 1904.
- C. AINSWORTH MITCHELL.—“Mineral and Aerated Waters.” London, 1913.
- Sir EDWARD THORPE, C.B., LL.D., F.R.S.—Article on “Carbon Dioxide” in his “A Dictionary of Applied Chemistry,” Vol. I. London, 1912.
- Sir H. E. ROSCOE, F.R.S., and C. SCHORLEMMER, F.R.S.—Article on “Carbon Dioxide” in their “A Treatise on Chemistry,” Vol. I. London, 1911.
- Dr E. LUHMANN.—Article on “Kohlensäure” in Dr Otto Dammer’s “Chemische Technologie der Neuzeit,” Vol. I. Stuttgart, 1910.
- Prof. R. T. STEWART.—Article on “The Physical Properties of Carbonic Acid, and the Conditions of its Economic Storage for Transportation.” *Trans. American Society of Mechanical Engineers*, New York, 1909, Vol. XXX., p. IIII.
- Dr VON HELMOLT.—Article on “Kohlensäure” in Dr Otto Dammer’s “Handbuch der Chemischen Technologie,” Vol. I. Stuttgart, 1895.
- H. C. LITTLER.—*Chem. and Ind.*, 1933, 533, 749.

OCCURRENCE

CARBON dioxide is invariably present in the atmosphere, being formed by the respiration of animals as well as by the decay of organic matter. The amount varies from about 0.03 per cent. in “fresh” air to as much as 0.3 per cent. in crowded rooms. For the same reason it is invariably to be found in the soil, from which it is taken up by rain and spring water.

Enormous quantities of carbon dioxide are evolved from volcanoes, and from fumaroles in volcanic districts, the Grotto del Cane near Naples being specially noted in this respect. Large amounts are also present in many natural mineral waters, especially those coming from springs of volcanic origin, as in Germany, Java, etc.

The bulk of the world’s content of carbon dioxide occurs stored up in rocks and minerals, such as chalk, limestone, marble (CaCO_3), magnesite (MgCO_3), dolomite ($\text{MgCO}_3 \cdot \text{CaCO}_3$), etc.

PROPERTIES

Carbon dioxide is a binary compound of the formula CO_2 , and having a molecular weight of 44 (O=16). It contains 27.27 per cent. of carbon, and 72.73 per cent. of oxygen by weight. It is a colourless gas, possessing a slightly pungent smell and an acid taste. It is very heavy, and can readily be poured from one vessel to another, its specific gravity at N.T.P. being 1.529 (air=1, Rayleigh and Leduc independently), so that 1 litre of the gas at N.T.P. weighs 1.977 g.

The gas is non-combustible, and will not support the combustion of other bodies, with certain exceptions, such as magnesium, which will burn in carbon dioxide, yielding magnesium oxide and free carbon. The presence of 4 per cent. of carbon dioxide in air is sufficient to extinguish a burning candle. It is not poisonous, but it will not support respiration, so that air containing much carbon

dioxide asphyxiates; hence asphyxiating air is often found in wells, cellars, mine shafts, etc.

Carbon dioxide is sometimes known as carbonic acid gas. It is, correctly speaking, the anhydride of carbonic acid (H_2CO_3), which acid is formed when carbon dioxide is dissolved in water ($\text{H}_2\text{O} + \text{CO}_2 = \text{H}_2\text{CO}_3$). This is shown by the fact that the solution exhibits a weakly acid reaction to litmus, which reaction is given by neither the dry gas nor by dry liquid carbon dioxide (*q.v.*). This acid forms two series of salts, the carbonates (M_2CO_3) and the bicarbonates (MHCO_3) (where M is any univalent metal), which evolve carbon dioxide when acted on by acids less volatile than that gas.

The solubility of carbon dioxide in water is high, the "absorption coefficient" (the volume of gas measured at 0°C . and 760 mm. which is absorbed by 1 c.c. of water at $t^\circ\text{C}$. and 760 mm.) being $1.7967 - 0.07761t + 0.0016424t^2$, so that at ordinary temperatures the gas is soluble in about its own weight of water. The solubility for a few temperatures is given in the table below:—

Temperature, Degrees C.	0.	5.	10.	15.	20.
Solubility (volume CO_2 at N.T.P. absorbed by 1 c.c. water at 760 mm.)	1.7967	1.4497	1.1847	1.0020	0.9014

The solubility is increased by pressure, but not quite to the extent demanded by **Henry's law** (according to which the ratio between the solubility and the pressure should be constant). According to **Wroblewski** (Wiedemann's "Annalen der Physik und Chemie," Vol. XVIII., 1883, p. 290), the solubilities at 12.4°C . for various pressures are as under:—

Pressure in atmospheres - -	1	5	10	15	20	25	30
Solubility at 12.5°C . - -	1.086	5.15	9.65	13.63	17.11	20.31	23.25

On removing the pressure, and especially in the presence of a porous body like bread or sugar, the additional volume of the gas is briskly evolved, causing effervescence, as in the case of soda water, beer, etc. The solution has a sharp, refreshing taste.

Liquid and solid carbon dioxide will be dealt with below.

MANUFACTURE, ETC.

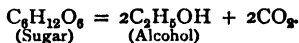
1. Collection and Purification of Natural Carbon Dioxide.—In order to collect the carbon dioxide escaping from mineral springs, borings are made in suitable regions, and round each boring a basin is excavated. The basin is kept filled with the water escaping from the bore-hole, the excess of water running away by means of an overflow channel. Over the bore-hole is placed a metallic gas-collecting vessel, or gasometer, which is provided with a counterpoise. The escaping gas collects under the gasometer, and is led away by a tube passing out of the upper part. The gasometer is automatically raised or lowered in the water by the counterpoise, according as the quantity of gas collecting in it increases or decreases. A similar apparatus is in use for collecting the carbon dioxide evolved from dry earth fissures.

The escaping gas is cleaned in a spray apparatus, in which it is absorbed by water under pressure in the presence of coke. A small quantity of potassium permanganate may be added more effectively to oxidise such impurities as

sulphuretted hydrogen. The gas is then dried in towers containing calcium chloride, and is finally liquefied and stored in steel cylinders.

South Germany has many important carbon dioxide springs, from which enormous quantities of the gas are obtained. The Saratoga Springs, New York, U.S.A., must also be mentioned as of considerable importance.

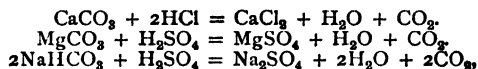
2. **As a By-product in the Manufacture of Beer, Etc.**—Enormous quantities of carbon dioxide are evolved in the manufacture of beer, wines, spirits, etc., owing to the sugar undergoing alcoholic fermentation—



The gas thus evolved has a flavour like fusel oil, and is, therefore, unsuited for many of the purposes for which carbon dioxide is in demand; but fermentation carbon dioxide is certainly suitable for carbonating and raising beer, and many methods have been devised for economically collecting it, which have, however, met with but little success. **Stead and Palmer** (English Patents, 27,396, 1904, and 23,763, 1907), for instance, collect the gas by means of counterbalanced gasometer bells, so constructed as to operate by their vertical movement means for throttling the flow of gas, effected by the use of a sleeve fitting a perforated vertical pipe.

For further particulars see **Mitchell's** "Mineral and Aerated Waters."

3. **By the Action of Acids on Carbonates.**—Carbon dioxide is usually prepared in the laboratory by the action of dilute acids on various carbonates:—



and the same method is used industrially, though to a very much less extent now than formerly.

Both sulphuric acid (oil of vitriol) and hydrochloric acid are used, but the former more especially, because the volatile impurities contained in the latter acid render the purification of the resulting gas more difficult. The sulphuric acid must, however, be free from arsenic (a frequent impurity) in the case of carbon dioxide for mineral waters, etc.

As concerns the carbonates, whiting (purified chalk, CaCO_3) or sodium bicarbonate (NaHCO_3) has been usually employed in England, whilst powdered marble (CaCO_3) has been used in America. In Germany the mineral water manufacturers have generally employed magnesite (MgCO_3). Sodium bicarbonate with sulphuric acid yields very pure carbon dioxide, and has the advantage of leaving a soluble salt in the generator, but its use is very expensive. Marble frequently contains bituminous matter and iron, so that the evolved gas needs careful purification. Whiting, on the other hand, requires to be mixed with more water than powdered marble, so that a larger generator is required for the same amount of carbon dioxide; the action is somewhat violent, and the gas contains impurities. Both marble and whiting, with sulphuric acid, leave in the generator a troublesome mass of insoluble calcium sulphate or gypsum (CaSO_4), thus—



Magnesite has the advantage of giving a high yield of carbon dioxide (52 per cent. by weight), and the mother liquors can be worked for magnesium sulphate or Epsom salts (MgSO_4).

Concentrated acid to an amount generally less than that sufficient completely to neutralise the carbonate is run into a generator containing the carbonate mixed with water. The generators are usually constructed of lead, or cast iron lined with lead. Their form is that of a cylinder, either upright or, preferably, horizontal. The acid is admitted from an acid tank by means of a syphon tube, which acts also as a safety valve. An additional safety valve may be provided, especially in the case of cast-iron generators for use with sodium bicarbonate. A stirrer is also provided, which rotates within the vessel and keeps its contents well mixed. The driving rod of the stirrer passes through a stuffing box, which renders it gas-tight, thus preventing the escape of carbon dioxide.

Carbon dioxide generated by these methods needs a certain amount of purification, which is effected by means of water-scrubbers. If, after this treatment, it still possesses an unpleasant odour, it is further purified by leading through a solution of potassium permanganate, which destroys organic compounds and sulphuretted hydrogen, and one of sodium bicarbonate, which retains acid fumes. The gas may finally be filtered through wood charcoal.

Sometimes manganese dioxide or potassium permanganate is directly added to the generator, when sulphuric, but not hydrochloric, acid is used.

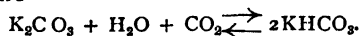
4. **As a By-product in the Burning of Limestone.**—Large quantities of carbon dioxide are evolved in the burning of limestone and marble for lime—

$\text{CaCO}_3 = \text{CaO} + \text{CO}_2$ ¹—and several patents have been taken out for collecting and purifying the gas from this source.

The evolved gas, which contains about 30 per cent. of carbon dioxide, the remainder being mainly carbon monoxide and nitrogen, is drawn off from the upper portion of the furnace, and water-scrubbed. It is then sufficiently pure for the purpose of sugar refining. If pure carbon dioxide is required the gas may be absorbed by potash-lye (potassium carbonate solution), and re-evolved as described below.

5. Recovery of Carbon Dioxide from Furnace Gases.—Furnace gases resulting from the combustion of coke or charcoal contain about 20 per cent. by volume of carbon dioxide, and several processes have been patented for recovering this product from them.

The usual method (Stead's process) is to absorb the gas by means of potash-lye (potassium carbonate solution), and afterwards to liberate it by heating the carbonated lye under reduced pressure—



The plant consists essentially of a lye boiler, directly fired with coke. The combustion gases, after washing and cooling, are forced through towers containing hard coke, in which they are absorbed by cold lye passed down the towers, reaction taking place in the direction of the upper arrow in the equation given above. The carbonated lye is then pumped into the boiler and boiled, when the reverse reaction takes place, and the carbon dioxide is expelled. The lye is then used over again. Heat interchanges are arranged in the paths of the lye, so that part of the heat of the hot decarbonated lye from the boiler may be given up to the cold carbonated lye on its way to the boiler. The evolved carbon dioxide is dried by means of calcium chloride, and either passed into a suitable gas holder, or immediately liquefied.

Carbon dioxide of a high degree of purity can be obtained by this method, comparing favourably with that produced from sodium bicarbonate. The gas is much purer than that obtained from acid and whiting, and as the process is considerably cheaper, it has to a very large extent supplanted the former method.

Knowles (English Patent, 1,744, 1907) provides means for the dilution of the carbonated lye, which he finds facilitates its decomposition. For other improvements see English Patent, 3,106, 1907, and French Patent, 387,874, 1908.

6. Recovery from the Exhaust Gas of Gas Engines (Suerth System).

—In North Germany, carbon dioxide is obtained in a somewhat similar manner to the foregoing from the exhaust gas of gas engines. Producer-gas, after being scrubbed, is exploded in the cylinders of the engine. The issuing gases, which are very hot, are used to heat the carbonated lye in a special boiler. The gas is then passed through scrubbers containing limestone over which water trickles. Sulphur dioxide and dust are thereby removed. Next the gas is pumped, under a pressure of three to five atmospheres, through a vessel containing potash-lye, provided with a number of baffle plates, under each of which the gas accumulates in turn, and is thus exposed for a long time to the action of the lye. The carbon dioxide is thus absorbed ($\text{K}_2\text{CO}_3 + \text{CO}_2 + \text{H}_2\text{O} = 2\text{KHCO}_3$), the process being completed in an absorption tower. The carbonated lye is then pumped into the boiler, the carbon dioxide is expelled by boiling ($2\text{KHCO}_3 = \text{K}_2\text{CO}_3 + \text{CO}_2 + \text{H}_2\text{O}$), and the purified gas is dried and liquefied.

LIQUID CARBON DIOXIDE

Carbon dioxide has a critical temperature of (approximately) 31.0° C., the corresponding pressure being 73 atmospheres. It follows, therefore, that the gas

¹ A further quantity of carbon dioxide is, of course, obtained from the coke used for burning the limestone.

can be liquefied at ordinary temperatures by pressure alone. About 50-60 atmospheres are required, whereas at 0° C. 36 atmospheres are sufficient. At 760 mm. pressure the boiling point of the liquid is -78.2° C.; this is shown in the following table, as well as the vapour pressures corresponding to other temperatures :—

Temperature, Degrees C.	-78.2	-25	-15	-5	+5	+15	+25	+35	+45
Pressure in atmospheres (1 atmos. = 760 mm.)	1.0	17.1	23.1	30.8	40.5	52.2	66.1	82.2	100.4

Faraday was the first to succeed in bringing about the liquefaction of carbon dioxide, which he did by allowing sulphuric acid to act on ammonium carbonate in a sealed tube bent so as to form an inverted "V," the gas being liquefied by its own pressure. **Thilorier**, in 1839, first prepared liquid carbon dioxide on a large scale. He used two cast-iron cylinders, in one of which the carbon dioxide was formed by the action of sulphuric acid on sodium bicarbonate. The gas was liquefied by means of its own pressure, and then distilled into the second cylinder. The apparatus was dangerous, several fatal explosions occurring. A similar apparatus, in which lead cylinders surrounded by copper jackets (**Mareska** and **Donny**) were employed, was found to be more reliable.

Liquid carbon dioxide is a colourless mobile fluid, having a specific gravity of 1.06 at -34° C., 0.947 at 0° C., and 0.726 at +22.2° C. It will be seen from these figures that the coefficient of expansion of the liquid is greater than that of any gas. It is almost insoluble in water, but readily dissolves in alcohol or ether.

Owing to its convenience and the speed with which it can now be manufactured, carbon dioxide is nowadays usually stored and sold in the liquid form. Since the temperature rises when the gas is subjected to pressure, most modern compressors are of the multi-stage type, in which the gas is submitted successively to two, three, or even four different and increasing pressures, being cooled by means of cold water between each stage.

The most efficient type of cooling apparatus is constructed of double pipes. The water flows through the inner tubes, and the gas passes along the annular space between the pipes in the opposite direction. A submerged condenser is usually employed for the final stage.

The cylinders in which the liquid is stored are not completely filled, a space being left for the liquid to expand, otherwise there is a danger of explosion. The presence of air also greatly increases the risk of explosion, only 1 per cent. of air left in the cylinder increasing the pressure in it by over 3 per cent., in the most favourable circumstances (see **Stewart**, *loc. cit.*).

SOLID CARBON DIOXIDE (DRY ICE)

When liquid carbon dioxide is allowed suddenly to evaporate, part of it solidifies owing to the decrease in temperature produced by the evaporation.

The solid can be most readily prepared by tying a bag of coarse canvas around the outlet tube of a cylinder of liquid carbon dioxide, which is inverted so that the valve is underneath. On opening the valve, the liquid very rapidly blows into the bag, part vaporises and escapes through the pores of the canvas, whilst the remainder solidifies owing to the decrease in the temperature, and collects inside the bag in the form of a white bulky crystalline powder resembling snow (**Landolt**, *Berichte*, 1884, Vol. XVII., p. 309).

On compression in a wooden mould a compact mass is obtained, which, owing to the very large heat of vapourisation required, does not readily evaporate in the air. It may be retained in a cardboard or wooden box, or preferably wrapped round with indiarubber tissue, then with cotton-wool and paper. The specific gravity of the solid is about 1.2. Its temperature is -79° C., but it may be gently touched by the hand without sensible cold, owing to the protective atmosphere of gaseous carbon dioxide around it. If, however, it is pressed to the skin it forms a blister. On mixing with ether or chloroform the temperature falls to about -90° C., the mixture forming an excellent one for refrigerating purposes. On reducing the

pressure the temperature falls still further to about -110° C. Liquid carbon dioxide immersed in a tube in this mixture solidifies to an ice-like solid (**Mitchell** and **Faraday**), having a specific gravity, at -79° C., of 1.56.

TECHNICAL USES OF CARBON DIOXIDE

The uses of carbon dioxide in commerce are many and increscent. The more important are noted below.

Carbon dioxide is used extensively in the manufacture of sugar for removing lime from the limed sugar-cane juice. It finds important application in the manufacture of various carbonates, especially white lead (France and Germany) and sodium bicarbonate, and in the manufacture of alkali both by the **Solvay** or ammonia soda process, and the cryolite process, in the latter of which carbon dioxide is used to decompose the sodium aluminate produced.

Carbon dioxide is also used for carbonating and raising beer, and in the manufacture of aerated waters. Liquid carbon dioxide, purchased in cylinders, has largely displaced the use of gas prepared at the works from whiting and sulphuric acid in the latter, as well as in other, industries. As **Mitchell** points out (*loc. cit.*), this substitution has eliminated the employment in the factory of sulphuric acid with its attendant dangers. It has considerably reduced the labour bill, owing to the ease with which the cylinders may be handled, and has cut down the cost of materials by about 10 per cent. Moreover, the liquid carbon dioxide on the market is purer than that usually obtained from whiting and sulphuric acid.

Carbon dioxide has been found useful for protecting wines from moulds, etc. A method of preparing carbon dioxide with antiseptic properties, in which it is sterilised by means of ozone, has been described by **Bourchaud-Praceig** (French Patent, 388,970, 1907).

Liquid carbon dioxide is also now extensively used as a refrigerating agent, especially in the manufacture of mineral waters, which need to be thoroughly cooled for saturation with gas during the bottling process. Liquid carbon dioxide has several advantages over both ammonia and sulphur dioxide as a refrigerant. It cannot impart, like ammonia or sulphur dioxide, any objectionable flavour to mineral waters with which it may come in contact, but can be used to carbonate them after it has done its work as a refrigerant. It does not attack copper, and its cost is very much less than that of liquid ammonia. Consequently carbon dioxide refrigerating machinery is rapidly displacing ammonia plant and sulphur dioxide plant.

Still colder temperatures can be produced by means of solid carbon dioxide prepared from the liquid as described above.

By allowing liquid carbon dioxide to come in contact with molten steel in strong gas-tight chambers, enormous pressures are produced, which free the casting from bubbles and increase the density of the metal. Liquid carbon dioxide is, therefore, used for hardening steel, especially by the firm of **Krupp** in Germany.

Liquid carbon dioxide has further applications in the removal of boiler-scale (see German Patent, 55,241, 1890), and as a fire extinguisher.

Liquid carbon dioxide may be used for raising sunken ships, etc. **Dr W. Raydt** was the first to carry out experiments in this direction, and in 1879 succeeded in raising an anchor weighing 316 cwt. (German) from a depth of 40 ft. in the sea at Kiel, by means of a carbon dioxide balloon.

Carbon dioxide possesses therapeutic properties, baths of water supersaturated with the gas having been found to be mildly stimulating, and thus useful in treating nervous diseases. Such baths are most readily prepared by means of liquid carbon dioxide.

The rapid extension of the solid carbon dioxide industry (dry ice) is remarkable. First produced on a commercial scale in Montreal in 1924, the output in the United States has enormously increased, where in 1933 nearly 100,000 tons were produced (see *Chem. and Ind.*, 1933, 533, 749).

SECTION XV

INDUSTRIAL OZONE

BY LIEUT. E. JOBLING, A.R.C.Sc., B.Sc., F.C.S.

LITERATURE

Among recent publications, the following will be found to be of value:—

- Bull. de la Société Belge d'Electriciens*, 26, 449. 1909.
 DAMMER.—“Chemische Technologie der Neuzeit,” I., 70. 1910.
 THORPE.—“Dictionary of Applied Chemistry,” IV., 56. 1913.
 ZIEGENBERG.—“Die elektrische Ozontechnik.” 1910.
Elektrochemische Zeitschrift, 16, 95, 129, 161; 1909-10. 18, 187, 222, 248; 1911-12.
Engineering, 87, 160; 1909. 91, 136, 656; 1911.
 ERLWEIN.—“Herstellung und Verwendung des Ozons.”
Journ. Franklin Institute, 163, 355. 1907.
 ERLWEIN.—“Les methodes d'épuration de l'Eau par l'électricité.” 1912.
Mett. and Chem. Engineering, 11, 375. 1913.
 DE LA COUX.—“L'Ozone et ses Applications industrielles.” 1910.
 DOUGAL.—“Production Electrique de l'Ozone.”
 Recent works on “Water Purification,” e.g., that by Don and Chisholm.
Scientific American Supplement, 71, 84; 1911. 73, 268; 1912.
Times Engineering Supplement of 20th and 27th September 1911.

THE importance of ozone, or *triatomic* oxygen, depends upon the extreme readiness with which it parts with its third atom of oxygen, particularly when in contact with oxidisable substances, to give ordinary or *diatomic* oxygen. Ozone is therefore an energetic oxidising agent, and as such has met with extensive industrial application—a circumstance which is to be attributed as much to the non-formation of any troublesome after-product as to the nascency of the liberated oxygen.

Though always prepared and used in a very rarefied form, ozone may be condensed from the gas containing it as a deep blue liquid of B.P. -119° C. (the pure gas is itself blue), which is dangerous to handle on account of its tendency to explosive decomposition. It has a characteristic odour, perceptible even in extreme dilution with air (1 part O_3 in 1,000,000 air). Gaseous ozone in the rarefied condition spontaneously decomposes, the rate of decomposition depending both on the temperature and the concentration. At 270° C. ozone cannot exist; at ordinary temperatures, though, air charged with ozone is fairly stable. Like air and oxygen, ozone is almost insoluble in water.

1. **Thermal Method.**—Since heat is absorbed by the formation of ozone from oxygen—



it follows that increase of temperature is favourable to ozone formation. Nernst utilises this as the basis of a process in which a current of carefully dried air is brought into contact with an electrically-heated non-metallic body, e.g., a Nernst filament (D.R.P., 195,985 of 1906). To minimise the decomposing effect of temperature upon the product, the velocity of the air must be such that it is only momentarily exposed to intense heat and is then suddenly cooled. The method, however, is not a practicable one owing to the low ozone concentration developed. The most productive thermal method appears to be that of immersing a glowing Nernst filament into liquid oxygen (F. Fischer).

2. **Electrolytic Method.**—If, in the electrolysis of aqueous liquids, the conditions are arranged for a very high current density at the anode, the oxygen liberated there is found to be ozonised. Sulphuric acid has been shown to be the best adapted for the purpose (Kremann). To obtain a good yield, as well as to prevent destruction of the anode, the latter must be cooled, either by rotation or by means of internally flowing water or salt solution (F. Fischer). The yield is further increased by partly enclosing the anodes with non-conducting material so as to leave only long thin lines of the platinum or other metal exposed (F. Fischer).

For the above electrolysis, direct current of course is employed, but in a new method for large scale ozone production recently described by Archibald and Wurtemberg, both direct and alternating current are employed in the electrolysis of dilute sulphuric acid. The alternating current is found to act as a depolariser, leading to highly increased yields of ozone. In one instance, the production of ozone was 300 times greater than with direct current only. The higher the frequency of the alternating current, the greater the yield of ozone.

3. **Photo-chemical Method.**—Lenard discovered that air or oxygen is "activated" by ultra-violet light. For the production of this light of very small wave-length, mercury vapour or Uriol lamps are employed, the lamp itself being entirely or in part of quartz, since quartz, unlike glass, is transparent to ultra-violet rays. Potter (American Patent, 845,965) takes advantage of these facts for the construction of an ozoniser in which a quartz mercury-vapour lamp is surrounded by a sheathing of ordinary glass, between which and the quartz of the lamp air is spirally conducted.

4. **Electrical Method.**—For industrial purposes, the only practicable method of producing ozone is that of passing dry air through a chamber where it can be subjected to the influence of a silent high-tension electric discharge.

It is not certain whether the production of ozone by silent discharge is fundamentally an electrolytic phenomenon, dependent upon the electric stress developed, or whether it is to be attributed to the ultra-violet rays developed. The latter is the more probable (Harries), in which case the preceding photo-chemical method is only a modification of the present one and vice versa.

In its simplest form the apparatus employed is the well-known Siemens ozone tube, comprising two concentric cylinders of glass connected to the poles of an induction coil, and between which passes a current of air. Commercial ozonisers are constructed on the same principle, the different systems being distinguished chiefly by the arrangement and material of the electrodes, and the presence or absence of a solid dielectric.

The tension of the current employed depends upon the thickness of the dielectric (if any), the nature of the electrodes and their disposition, and varies between 10,000 and 90,000 volts. The higher the tension, the greater the output of ozone, the latter being theoretically proportional to the potential difference. A high frequency, at least 100 alternations per second, is found necessary.

A solid dielectric between the electrodes is now generally considered a more efficient arrangement than reliance only upon the air or oxygen passing between the plates, as it both increases the regularity of discharge, and diminishes the tendency to sparking.

The current has a deozonising effect which increases with the concentration of the ozone. The concentration must therefore be kept low. There is a limit to which it may be pushed, but this maximum is far above the workable concentration level, since the energy then demanded is out of all proportion to that required at lower concentration.

In most of the technical apparatus afterwards to be described, the concentration of ozone in grams per cubic metre of ozonised air amounts to an average of about two. At this concentration, 30-60 gr. of ozone per kilowatt-hour are produced at a cost of $\frac{1}{2}$ d. to 1d. For higher concentrations, implying a slower air

current, the yield is less, and vice versa. This efficiency of production is still far distant from that theoretically obtainable.

Heat and humidity are unfavourable to the generation of ozone. The influence of the former in causing a reversion of the ozone to oxygen has already been remarked. To minimise it, the electrodes are cooled by any suitable means, though the ideal generator would naturally be that in which non-production of heat is attained rather than its elimination by cooling means. To prevent the very considerable loss which moisture introduces, the air delivered to an ozoniser is always first dried by contact with a hygroscopic solid or by refrigeration. Dust is undesirable, so that the incoming air is usually also filtered.

Sparking in the discharge must be rigorously prevented, for it leads to the formation of oxides of nitrogen which are harmful to the apparatus, and usually detrimental to the quality of the ozonised air produced.

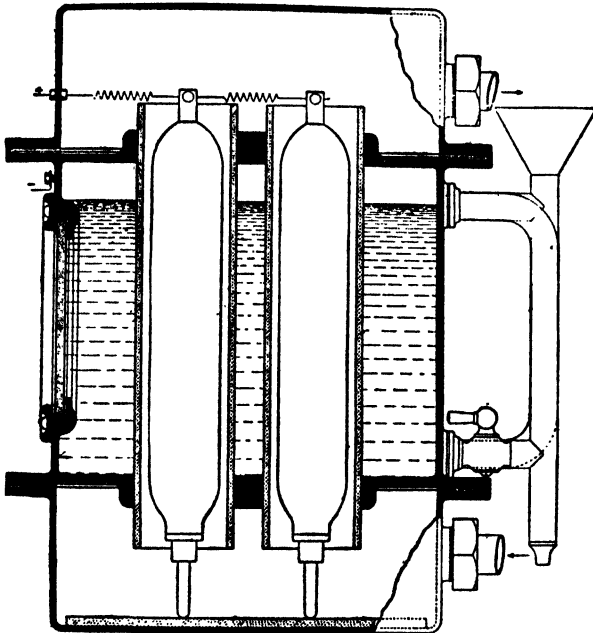


FIG. 1.—Siemens and Halske Process.

The following include the most important of the ozonising plants now in vogue:—

1. **Siemens and Halske Process.**—As shown in Fig. 1, each ozone tube comprises a cylinder of glass surrounding a cylinder of aluminium, and six or eight of these elements are usually mounted, vertically or horizontally, in a metal case through which water flows for cooling purposes. The cylinders are connected to the A.C. mains, the glass cylinders being put to earth through the surrounding water and case to reduce the risk of shock. Air enters the lower chamber, passes through the ozone tubes, and is drawn off as ozonised air from the upper chamber. As viewed through a glass window, the discharge is seen to be blue, and to enable the attendant, therefore, to see at a glance whether the ozonisers are working properly, they are kept in a dark room.

2. **Otto System.**—In the earlier form of this ozoniser (Fig. 72) one electrode consisted of a fixed iron cylinder, while the other comprised a large number of aluminium discs arranged perpendicularly to a central axle of the cylinder. The

rotating discs were provided with two opposite segmental openings, those of each disc being staggered with respect to adjacent discs, whereby any spark that was formed was drawn out and ruptured by the rotation of the discs. No dielectric was employed.

In the latest form, however (see Fig. 3), glass is employed as a dielectric, and the ozoniser now consists of an outer casing in which are arranged a number of sheets

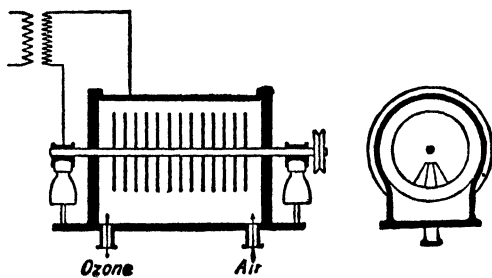


FIG. 2.—Otto System.
(Old Form.)

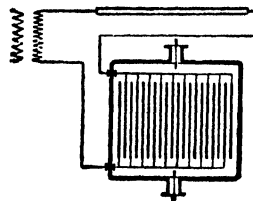


FIG. 3.—Otto System.
(New Form.)

of glass coated on alternate sides with tin-foil, each sheet being separated by a strip of insulating material so as to leave a space between for the passage of the air.

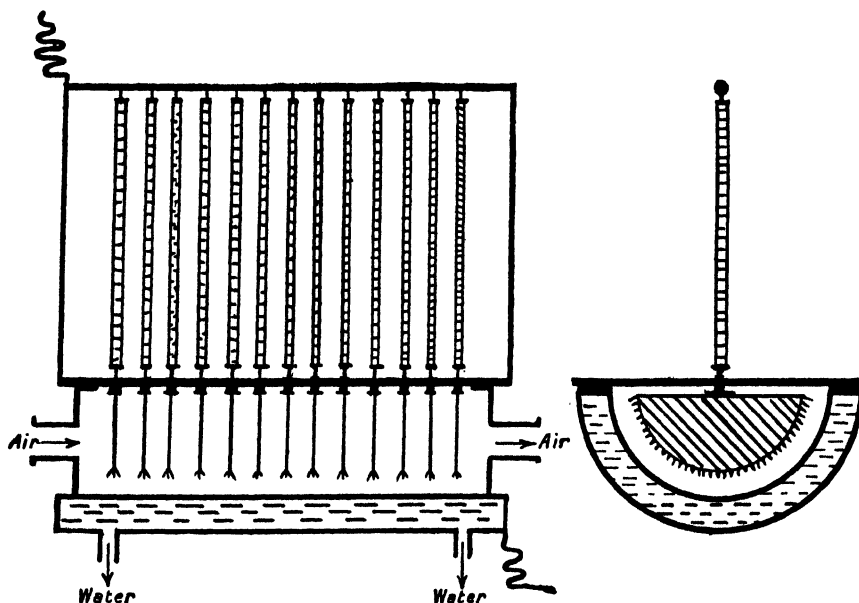


FIG. 4.—De Vrise System.
Longitudinal Section.

Cross Section.

3. Tindal-de Vrise System.—No solid dielectric is here employed. Each ozoniser (Fig. 4) comprises a horizontal semicylindrical metallic trough, fitted hermetically with a glass cover and provided externally with a water jacket. Semi-discs of metal, having serrated edges, are suspended from the cover at short intervals and form one electrode. The metal trough is earthed and forms the other electrode. To prevent sparking, a series of high liquid resistances, consisting of tubes filled with glycerine and water, are arranged in the circuit. The silent discharge takes place between the semicircular high-tension poles and the water-cooled inner surface

of the trough, and between the poles the air to be ozonised is circulated. Five or six such cells are arranged in series.

A similar ozoniser, due to Tindal, is shown in Fig. 5. The arrangement is self-explanatory from the diagram given.

4. **Abraham-Marmier System.**—In this ozoniser the discharge surfaces consist of glass plates whose outer surfaces are cooled by water circulating in the

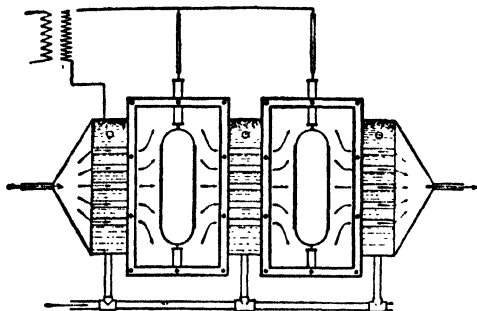


FIG. 5.—Tindal's System.

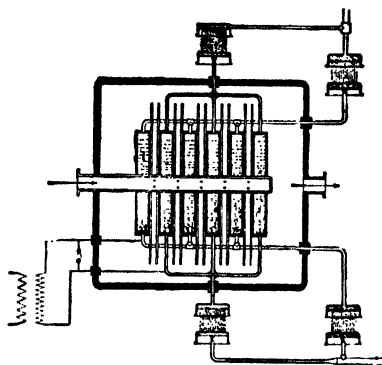


FIG. 6.—Abraham-Marmier System.

surrounding air-tight metal tank. Since the water serves as a conductor, being in contact with the high-tension poles, a high resistance, in the form of a number of water showers, is employed to prevent short-circuiting through the water (Fig. 6).

5. **Vosmaer System.**—Dielectrics are dispensed with in this system also. The ozoniser comprises a series of parallel tubes, each of which contains one flat

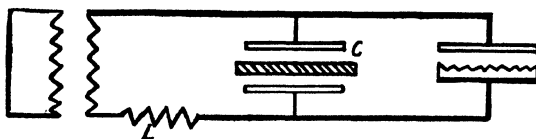


FIG. 7.—Vosmaer System.

and one saw-edged electrode held at a fixed distance apart by porcelain insulators. Sparking is suppressed by the insertion of a condenser *C* and induction coil *L* in the circuit (see Fig. 7).

6. **Howard-Bridge System.**—The discharge space in this case is bounded by two concentric cylinders, the outer of glass lined with aluminium and the inner

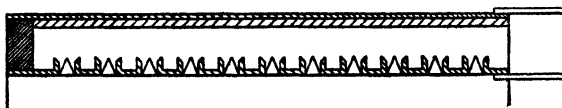


FIG. 8.—Howard-Bridge Ozoniser.

of metal pierced by a large number of holes for the passage of the air. Concentration of the discharge is effected by raising the rims of the holes above the level of the inner cylinders (see Fig. 8).

7. **Gérard System.**—This ozoniser consists essentially of two concentric glass cylinders of about a metre in length, which thus form a double dielectric, whilst the electrodes are formed of metallic sheathings affixed to the outer surface of the outer tube and to the inner surface of the inner tube. Air is passed down the

inner tube (see Fig. 9), rises between the dielectrics, and escapes charged with ozone. Several, usually ten, of these elements are arranged vertically in a refrigerator consisting of a tank containing oil, and each element is surrounded by a wide cylinder of zinc, considered by the inventor both to increase the circulation of the oil, and, by acting as a condenser, to promote the formation of ozone. The advantage of oil over water as a cooler lies in its insulating properties, for on

the accidental breakage of a tube it prevents short-circuiting as it cuts the tube off from the remainder.

8. Ozonair System.—In this ozoniser a series of mica plates are mounted side by side in a case, each plate being covered on both sides by a sheet of aluminium-alloy gauze which serves as the electrodes. The air passes into the box and between the plates in a direction parallel with them. The use of gauze is claimed to promote the formation of a sparkless discharge, whilst the open arrangement of plates is said to be sufficiently preventive of heating without the aid of water-cooling (see p. 155).

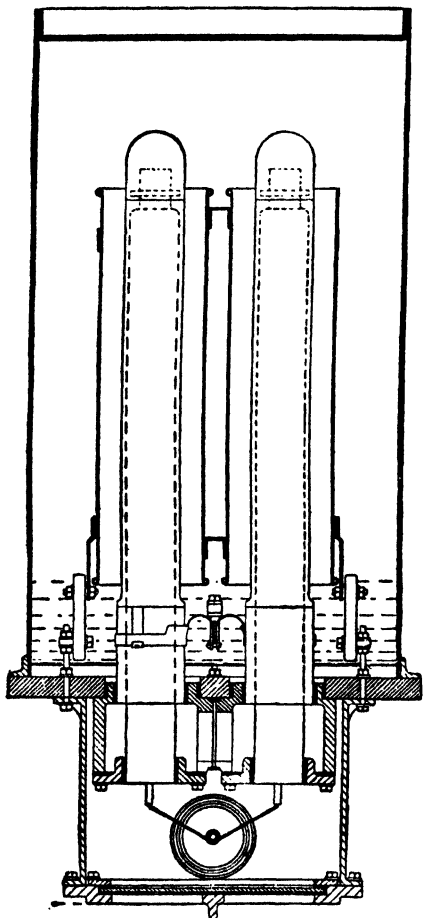


FIG. 9.—Gérard System.

“tetramethyl-base” paper, *i.e.*, paper soaked in an alcoholic solution of tetramethyl-di-*p*-aminophenylmethane. The moist paper is turned violet by ozone, stray yellow by nitrous oxide, deep blue by chlorine or bromine, and is not affected by hydrogen peroxide (Clement, *Ann.*, [4], 14, 334, 1902).

Estimation.—The standard industrial method is that of absorption by neutral potassium iodide solution, and after acidifying, by titration in the usual way with sodium thiosulphate and starch.

Satisfactory results have also been obtained by Ladenburg (*B.*, 36, 115, 1903) for a method in which the ozone was passed into sodium hydrogen sulphite and then titrated. In either of the above cases if the presence of other oxidising agents is suspected, a duplicate estimation should be made after the gas has been heated above 270° when the difference in the results gives the amount of ozone.

Detection and Determination of Ozone

Detection.—Ozone is most readily detected by the “blueing” of starch-potassium iodide paper. Unfortunately, however, other substances, *e.g.*, nitrous oxides, chlorine, etc., produce the same effect.

A more conclusive test is obtained by using a litmus or phenolphthalein paper moistened with neutral potassium iodide solution. Chlorine, nitrous acid, etc., if present, form the neutral salt, and therefore give no reaction. Ammonia is the only likely substance to disturb the reaction, and this can be detected by the use of a separate litmus paper. Ozone oxidises the potassium iodide to caustic potash and turns the litmus blue.

The most sensitive qualitative test is obtained by the use of the so-called

For the separation from small quantities of the usual impurity, namely, nitrous oxides, the gaseous mixture should be passed into liquid air when the ozone dissolves, whilst the nitrous oxides separate as blue flocks. On filtration and evaporation both constituents are determinable (Fischer and Marx, *B.*, 39, 2556, 1906).

Application of Ozone

Water Purification.—Ozone is known to exert a destructive action upon many of the micro-organisms found in water, particularly those which are deleterious to health, and in consequence of this, it has been utilised on a very large scale for purposes of water sterilisation. The method simply amounts to a cold combustion of the bacteria and organic matter present.

The present methods of water purification¹ comprise :—

1. The use of antiseptic chemicals, usually chlorine or bromine in some form.
2. Sand filtration.
3. The employment of ultra-violet radiation.
4. Ozonisation.

Of these, sand filtration has long been relied upon, and is still employed for all ordinary waters. Treatment by chemicals has not found much favour industrially; whilst purification by ultra-violet light, though making rapid strides, is still in its infancy. Further consideration of these methods cannot be undertaken here.

Ozonisation finds its greatest usefulness in the purification of those waters, usually of superficial origin, which are more or less discoloured or contaminated. Its advantage lies in the fact that it leaves no objectionable residue, is non-toxic, its comparative insolubility prevents "over-dosing," and it does not attack the usual dissolved salts which give taste to potable water.

The salts of the alkalies and alkaline earths remain unattacked, as also do ferric salts, but ferrous and manganous salts are oxidised and precipitated. Organic matter is completely destroyed. To minimise the consumption of ozone, however, all organic and inorganic impurities must first be removed by mechanical or chemical means.

A modern ozonising plant consists of (1) ozonisers, (2) sand filter, (3) ozonising towers, and (4) a reservoir for the purified water. The various ozonisers have already been described. It only remains to deal with the various types of ozonising towers employed.

Since ozone is only very slightly soluble in water, satisfactory sterilisation is only obtained by the intimate contact of the two. This is accomplished in the following ways :—

1. **Surface Contact.**—In the Siemens and Halske tower, which illustrates this type of apparatus and of which a diagram is shown in Fig. 10, the previously filtered water is allowed to trickle down one or more towers filled with stones or gravel, while at the same time a current of ozonised air is forced through the tower in the opposite direction. The ozone not absorbed is returned to the ozoniser.

The Abraham-Marmier tower is of the same type.

This system is being replaced by a system which employs :—

2. **Emulsification.**—Otto's apparatus is the most important in this connection and constitutes a kind of injector in which the filtered water is forced into a small chamber provided with holes through which ozonised air is sucked in and churned into the water (Fig. 11). To complete the mixing action the apparatus terminates in a long piece of piping, 15 ft. or so in length, whereby the ozonised air is more readily absorbed by the water by being subjected to the increased pressure of the lower part—a method known as "self-contact."

¹ See p. 169.

Another form of ozonising apparatus, in which the ozonised air is sucked in by the flow of the water, is that of the Howard-Bridge system, shown in Fig. 12. In travelling through the first U tube, partially used ozonised air is drawn in from the pipe *a*, the ozone absorbed leaving the air to escape through a hole at *b*.

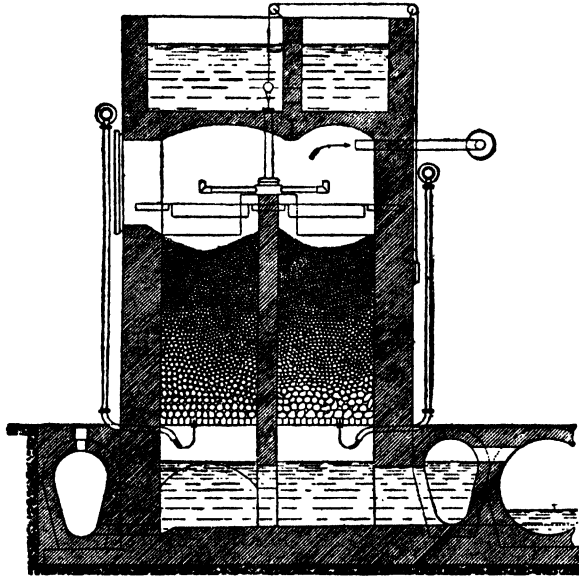


FIG. 10.—Siemens and Halske Tower for Ozone Treatment of Water.

Fresh ozonised air is then sucked in from the ozoniser *c*, and accompanies the water along the second U-tube round the baffle plates and escapes into the reservoir. Any

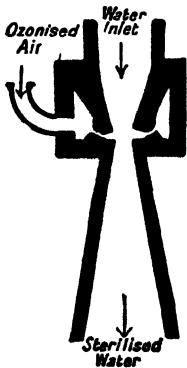


FIG. 11.—Otto's Apparatus for Ozone Treatment of Water.

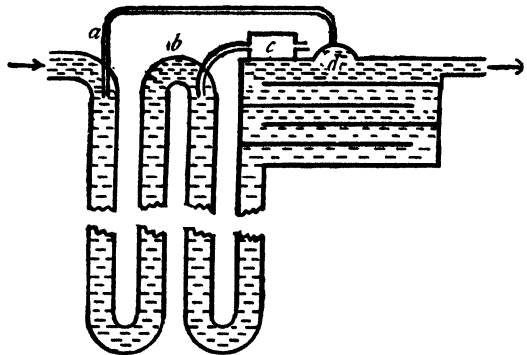


FIG. 12.—Howard-Bridge System for Treatment of Water.

unused ozonised air collects in the chamber *d* and is drawn back into the incoming water through the pipe *a*. This method effects considerable economy, for no power is required to compress the ozonised air into the steriliser. Incidentally it removes all difficulties connected with ozonised air pumps due to the lubricant being attacked by the ozone, for the pumps are dispensed with.

3. **Injection.**—Yet a third method is illustrated by the Siemens-de Vrise ozonising tower (Fig. 13). The towers are of iron, internally enamelled, and are divided into compartments by perforated lateral partitions of celluloid. The ozonised air is forced into the tower at the bottom, along with the water to be sterilised, and the ascending bubbles, by contact with the partitions, are suitably broken up for absorption of the ozone. By regulation of the speed of the water as it passes up the tower, the time of contact of the ozone with the water can be readily controlled.

The Vosmaer, Gérard, and Tindal towers are of the same type.

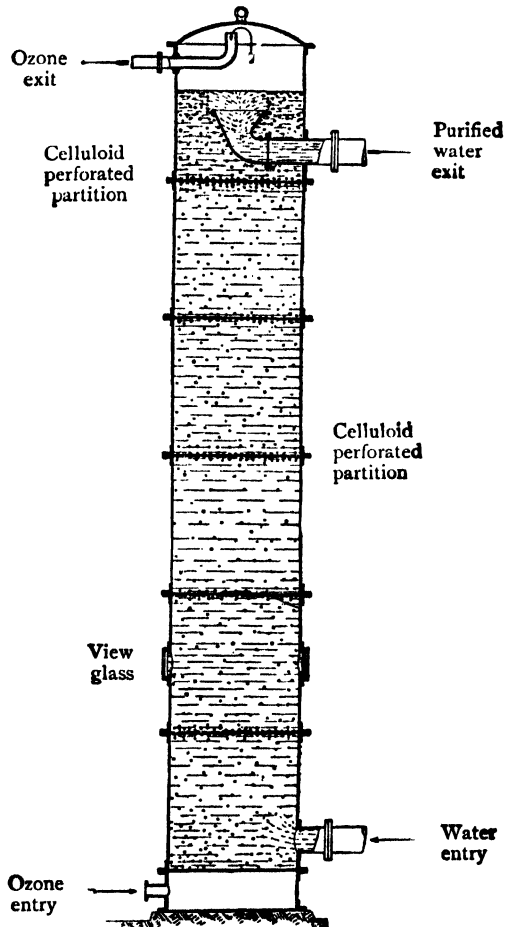


FIG. 13.—Siemens-de Vrise Water Ozonising Tower.

In the Ozonair type of apparatus the above three methods are combined in order to ensure satisfactory contact. The water is first atomised in the presence of ozonised air in the upper portion of the apparatus, and the particles of water are then allowed to fall upon a pile of glass spheres packed in a tower, where they meet an ascending stream of ozone. At the bottom of the tower the water falls into a tank, through which ozonised air is blown from nozzles arranged beneath the surface of the water, the last process being continued for any desired period.

In the case of all the ozonising towers above-mentioned, the ozonised water

is discharged on to the top of a series of steps, down which it cascades into the storage tank and, by contact with the atmosphere, gives up its excess of ozone.

Recently, small ozonisers for domestic purposes have been placed upon the market. They are designed to fit on the ordinary water main, and are operated from the house supply, the ozonisers only functioning when the tap is turned on.

As to the amount of ozone required for complete sterilisation in water purification plant, it is not possible to say precisely. The amount varies with the water under consideration, and should be made the subject of preliminary research in each case. The average amount of ozone supplied in grams per cubic metre of water is about 2, though it may sink to $\frac{1}{2}$ or rise to 8. The concentration of ozone in the ozonised air delivered from the ozoniser also lies in the neighbourhood of 2 g. per cubic metre, so that it may be stated broadly that a bulk of ozonised air equal to that of water to be purified is required. The cost of working, in the case of large installations, runs to about $\frac{1}{2}$ d. per 1,000 galls. of water treated.

On the Continent, water purification by ozonisation is largely practised, installations having been erected at Petrograd, Paris, Florence, Nice, and other large towns. The systems employed are usually the Siemens and Halske, de Vrise or Otto systems, or combinations of these. In England, the Ozonair apparatus has the widest application, but so far has not been adopted by any large public authority owing to the satisfactory purity of the water supply of most large English towns. The Vosmaer and Howard-Bridge systems are American in origin, and find their chief application in Canada and United States of America.

Air Purification.—The unpleasant effect of the air of crowded rooms is not due at all to an excess of carbon dioxide, but to the noxious organic exhalations which are given off from the skin and lungs of the people present. The introduction of ozone into such rooms is found to remove the source of the bad effects by oxidising these organic impurities, whilst if, in addition, a small excess of ozone be admitted, the air is rendered pleasant and invigorating. Bacteria, however, can hardly be removed, for this would demand a concentration of ozone which the human organism could not tolerate; but, if the incoming air be subjected to the influence of ozone, at least partial sterilisation can be effected. The costly complications introduced into heating arrangements by the necessity for hygienic ventilation are removed to a large extent by the use of an ozonising apparatus, which renders even the atmosphere of a closed room wholesome for a considerable time (see, however, *Journ. Ind. and Eng. Chem.*, 5, 882 [1913]).

An air-purification plant usually comprises a filter screen through which the air is drawn and a mixing chamber into which ozone is introduced from the ozoniser to partially sterilise the air, and at the same time enrich it with a minute quantity of ozone (one part ozone to one million parts of air). From this chamber the air is distributed to the various parts of the building, etc., to be ventilated. Such installations have been erected by Ozonair Ltd. in England and by Siemens & Halske in Germany, for the ventilation of large public buildings, factories, hospitals, etc. The method is also found to be particularly useful for sterilising the atmosphere of slaughter-houses and warehouses in which food of all descriptions is stored.

One of the tube railways in London, the Central London Railway, has recently been equipped with an ozonising installation (Fig. 14). The supply of fresh air is drawn from the outside through a filter F consisting of a gauze screen, where it is washed by atomised water, and its temperature somewhat reduced. A small proportion of the air is dried and passed into the ozoniser O, whence it is drawn into the mixing chamber M where it meets the remainder of the still moist air, and the whole is then passed on by ducts A to various parts of the tube. c shows the converter, T the transformer, and E the electric motor for driving the fan.

For household purposes, small portable ozonisers, comprising a transformer, motor, fan, and ozoniser, are upon the market.

Miscellaneous Applications.—In the brewing industry, the introduction of ozonised air into the fermenting chambers is found to have an invigorating effect

upon the yeast, probably by reducing the number of bacterial and other organisms which prey upon it. Ozone is also employed with advantage in the sterilisation of casks, pipes, etc., and during bottling of the beer.

Ozone is employed, too, in the commercial manufacture of vanillin from iso-eugenol, and in the production of artificial camphor.

Its bleaching properties have found application in several directions, such as the decolorising of oils and fats, sugar, etc., and in the bleaching of delicate fabrics.

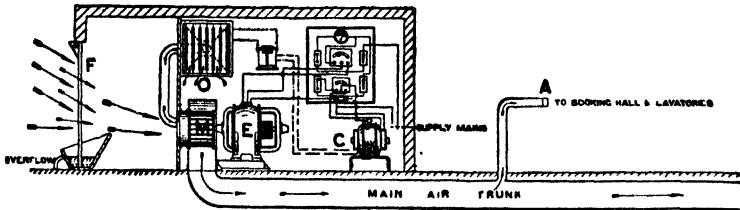


FIG. 14.—Ozonising Installation for Air Treatment of the Central London Railway.

It has been utilised, in addition, for the bleaching of flour, but the effect is now found to be produced by the oxides of nitrogen or hydrogen peroxide present and not by the ozone.

In the seasoning of timber, leather, tobacco, tea, etc., as also in the maturing of spirits, ozone finds useful application.

Acknowledgment.—The author desires to express thanks to Messrs Ozonair Ltd. for permission to reproduce Fig. 14 from one of the several booklets on the subject which they are willing to supply.

SECTION XVI

THE TECHNOLOGY OF WATER

BY HERBERT H. HODGSON, M.A. (Camb.), B.Sc. (Lond.), Ph.D. (Heidelberg)
Head of the Chemical Department, Technical College, Huddersfield.

LITERATURE

- Summary of Current Literature*, "Water Pollution Research," H.M. Stationery Office
 J. H. GARNER.—"Sanitation and Water Purification," Annual Report to the Society
 of Chemical Industry. 1933.
 See also A. PARKER, *loc. cit.*, 1932.
 AMERICAN PUBLIC HEALTH ASSOCIATION.—"Standard Methods for the Examination
 of Water and Sewage."
 DAMMAR, OTTO.—"Technologie der Neuzeit." 1910. Articles, "Wasser," "Indus-
 trie Abwasser."
 DIBDIN, W. J.—"The Purification of Sewage and Water."
 FOWLER, C. J.—"Sewage Works Analyses." 1902.
 —"Bacteriological and Enzyme Chemistry." Article on "Sewage Purification."
 FRANKLAND, P. F. and B. C.—"Micro-Organisms in Water." 1894.
 GARNER.—"Treatment of Effluents from Dyehouse and Textile Factories." 1912.
 HOUSTON, Dr.—"Reports to the Metropolitan Water Board."
 LUNGE, G., and KEANE, C. A.—"Technical Methods of Chemical Analysis," Vol. I.,
 Part II. Articles on "Drinking Water," "Feed Water," "Sewage and Effluents."
 MOORE and SILCOCK.—Vol. II., Appendix III., of "Sanitary Engineering."
Patent Literature:—
 RIDEAL, S.—"Water and its Purification." Also articles in *The Chemical World*.
 RIDEAL, S. and E. K.—"Water Supplies; their Purification, Filtration, and Sterilisation."
 ROYAL COMMISSION ON SEWAGE DISPOSAL.—Reports.
 THORPE, Sir T. E.—"Dictionary of Applied Chemistry," Vols. I. and IV. Articles on
 "Boiler Incrustation," "Ozone," and "Sewage."
 THRESH, J. C.—"The Examination of Waters and Water Supplies." 1904.
 WANKLYN, J. A., and CHAPMAN, E. T.—"Water Analysis." 8th Edition. 1891.
 WANKLYN, J. A., and COOPER, W. J.—"Sewage Analysis." 1905.

Acknowledgments.—In putting together these pages the writer has naturally contracted great obligations to many authors, among whose works he especially wishes to acknowledge:—Fowler's chapter on "Sewage Purification"; Rideal's articles in *The Chemical World*; Lunge and Keane's "Technical Methods of Chemical Analysis"; Moore and Silcock's "Sanitary Engineering"; Thorpe's "Dictionary of Applied Chemistry"; Garner's "Treatment of Effluents from Dyehouse and Textile Factories."

The author also wishes to express his best thanks to the following firms who supplied him with any information requested, and also kindly provided the illustrations:—Philip J. Bertin & Co., London, for "Ultra-Violet Light Processes"; Water Softeners Ltd., for "Permutit"; Lassen & H. Jort, London, for "Water Softeners and De-Oilers"; Royles Ltd., Irlam, near Manchester, for processes on "Water Filtration, Softening, and Purification."

INTRODUCTION

NATURAL waters may be distinguished as rain water, spring and well waters, brook and river, pond, lake, and sea waters. These various waters are so diverse in character, and must be subjected to so many different processes before acquiring economic value, that for simplicity the subject will be treated under three main headings, viz. :—drinking water, feed water for boilers and other technical purposes, and effluents including sewage disposal.

Chemically pure water is unknown in nature, although rain water, after a steady downpour, approaches the ideal most nearly. Rain carries down dust particles from which minute amounts of mineral constituents are extracted, while

certain dissolved gases (nitrogen, oxygen, carbon dioxide, ammonia, nitrous and nitric acids) are usually present. In the neighbourhood of manufacturing towns, sulphuric and sulphurous acids are of frequent occurrence.

Fog is directly due to dust particles, since air filtered through cotton wool has no tendency towards fog formation, and in Berlin there are strict regulations against atmospheric pollution by chimneys for the prevention of fog.

Rain Water has been the subject of exhaustive researches at Rothamsted since 1852, and N. H. J. Miller has collected these observations together in an important communication (see *Journ. Agric. Soc.*, 1905, p. 280). The following is the average composition: NH_3 0.440, N_2O_5 (+ N_2O_3) 0.183, Cl 2.2, SO_3 2.6 mg. per litre. The annual variation of the separate constituents depends very probably on the rain distribution. A clear difference in chlorine content was shown between the rainfall in summer and winter (1 : 2. 3).

According to Schöne, hydrogen peroxide is a regular constituent of rainfall (*B.*, 26, 3011; 27, 1233), while Taufmann states that rain is always radio-active. Micro-organisms and their spores are also always present.

Ground Waters, which have had prolonged contact with mineral sources, contain dissolved substances in amounts varying between wide limits, which owe their presence mainly to the dissolved carbon dioxide in the water derived from the soil and air. All spring water, therefore, contains calcium and magnesium salts usually as bicarbonates, since the carbonates themselves are insoluble and are converted by the carbonic acid water into the former; smaller amounts of these metals are also usually present as sulphates. Sodium and potassium salts may similarly be in solution as sulphates, chlorides and silicates. Waters containing a certain amount of inorganic impurity are termed hard, and the process resorted to for their purification is called "water-softening."

The quantity of organic matter present in a purely natural water is usually very small compared with that of the mineral constituents, since in the upper earth layers, which are porous and filled with air, ready oxidation takes place. Water passing through peaty and turfy layers is characterised by its high organic content and by the presence of iron as vegetable acid compound, bicarbonate, or phosphate, such water having a peaty smell, an acid taste, and frequently reacting acidic to litmus.

Spring Waters which contain large amounts of dissolved substances, or possessing a higher temperature than their environment are known as natural mineral waters. Very many springs are radio-active, generally containing dissolved radium emanation, and, in spite of the gaseous tendency of the latter, thermal springs are generally more active than cold. The medical effect of such springs may probably be bound up with the expulsion of this emanation.

River Water as a rule is softer than spring water, since aeration promotes liberation of carbon dioxide with consequent decomposition of the bicarbonates and precipitation of the almost insoluble normal carbonates. According to the rate of flow depends the amount of suspended matters, such as fine particles of clay, mica, quartz, animal and vegetable substances, etc., which are carried along. In general, rivers have the maximum dissolved content at low water (*i.e.*, in summer) and the minimum of suspended matter. They tend to purify themselves, but for this purpose require a longer course than obtains with the majority of English rivers.

The factors bringing about self-purification are as follows:—

1. Evaporation, which affects all the succeeding influences, and by which ammonia is lost.
2. Sedimentation, which in sluggish rivers gets rid of suspended matter and also bacteria.
3. Light and electricity, which according to H. Buchner destroy bacteria up to a depth of two metres. In this connection ultra-violet light also destroys germs (see later), while the formation of hydrogen peroxide has been observed.
4. Purely chemical decompositions, which are generally brought about by factory effluents, these neutralising free acids and alkalis; heavy metals are precipitated by the carbonates and bicarbonates of the river water, *e.g.*, MgCl_2 from potash salt deposits can bring about manifold transformations.
5. Direct oxidation, whereby sulphuretted hydrogen, sulphides, and ferrous salts are removed.

Whether oxidation of the carbon-nitrogen compounds takes place without the aid of micro-organisms has not yet been established.

6. **Biochemical and purely biological processes.** These play a profound part in the self-purification of rivers.

The other sources of natural waters fall outside the scope of this article.

The purification of natural waters depends upon their character, the object for which they are required, *e.g.*, for drinking, trade, boiler feed, or agricultural purposes, and the quantity to be delivered.

DRINKING WATER

Pure water is unsuitable for drinking purposes owing to its stale flavour and smell, the palatable qualities being due to the presence of small quantities of salts, especially sodium chloride and bicarbonate of soda.

Accordingly **rain water** is generally rejected as a drinking water, either on account of its insipid taste if pure, or its liability to contamination, and when necessity compels its use the collecting surfaces and storage vessels should be kept as clean as possible.

The best drinking water is furnished by hilly and mountainous districts, where the small running brooks are richly charged with air which oxidises organic matter, and thereby promotes its removal.

The value of this kind of water is testified to by the ancient aqueducts which often conveyed water for miles from hilly districts.

A very usual source of supply is **ground water**, of which **spring water** constitutes the best variety, being safer than that from wells. Both spring and well water must be preserved against possible contamination, either by extraneous introduction or by inefficient earth filtration from cesspools, sewers, etc.

In the vicinity of a densely populated district, a well water will seldom comply with these conditions. **Artesian Wells** supply very good drinking water if drawn from a sufficient depth and from a good substratum, since the water is almost bacteria-free, owing to the earth filtration, and requires no further purification.

Drinking water should be clear, colourless, or nearly so, and of a pleasant taste. Unfiltered, stagnant, or surface water is unsuitable for drinking or domestic purposes, since the danger of infecting impurities is ever present.

A serviceable water supply, free from hygienic objections, should not be subject to large temperature fluctuations, while there should be an absence of organic matter in large quantity and of chlorides, sulphates, carbonates, nitrates, and nitrites, especially of the alkalies and alkaline earths, in the neighbourhood. A litre of drinking water should not give a residue exceeding 500 mg. on evaporation, and if the amount is greater, then the geological nature of the district requires inspection.

Large fluctuations in composition and sudden turbidity are indications of the presence of infection, danger, or of unpalatable impurities. Water otherwise dangerous may, however, be purified by suitable filtration, and many towns are compelled to use filtered river water, *e.g.*, London, Altona.

Humus substances impart to the water a yellowish or yellowish-brownish shade which is permanent on standing, in contrast to turbidity caused by suspended impurities which disappears, either whole or part, on settling. Clay causes a yellowish or greenish coloration, ferric hydroxide precipitated by air a reddish-brown, calcium carbonate a white, and metallic sulphides, such as those of iron or lead, a black colour. Very finely suspended matter may pass through good filter paper. Recently collected spring or well water almost always shows a weakly acid reaction, due to presence of free carbonic acid.

The hygienic valuation of water is based upon data obtained from an examination of the supply conditions and the results of physical, chemical, microscopic, and bacteriological examinations. A thorough geological survey of the gathering ground must be made. The cause of any turbidity must be closely investigated, and if due to finely divided clay or other mineral debris it is not injurious to health, although unpalatable; should, however, the cause be introduced impurity, then the

water stands condemned for drinking or domestic purposes as a probable source of infection. An unpleasant smell or taste is its own test, while poverty in bicarbonates or free carbon dioxide, though not unwholesome, diminishes freshness. Water is unpalatable above 15°C ., and at the other limit ice-cold water may be injurious.

While **soft water** is required by most industries, a **medium hardness** of $18^{\circ}\text{-}25^{\circ}$ is most suitable for drinking purposes.

Abnormal hardness often indicates the decay of organic matter in the soil, whereby carbonic and nitric acids are formed which contribute considerably to the solvent action.

Chlorine should only occur in drinking water to the extent of a few milligrams per litre, and should a much larger quantity be detected, contamination by urine or domestic refuse is at once suspected.

Common salt, however, is occasionally added to well water in considerable quantities to improve it.

Usually the **sulphuric acid content** is small, but **nitric acid** when present is under suspicion, since it is the final oxidation product of nitrogenous organic matter.

A larger amount than 10-12 mg. per litre should not be passed, especially if the normal water of the district be nitrate-free.

If 1 mg. or more per litre of **ammonia** or **nitrous acid** be present, **pollution by decaying nitrogenous matter** is indicated, and therefore possible infection, although here the local circumstances should be examined as considerable quantities of ammonia may be present from non-polluted sources.

The **oxygen consumption value** of pure spring water seldom amounts to more than 1 c.c. of $\text{N}/100$ KMnO_4 solution, and if pure well water to 1-2 c.c. per litre, so that rapid absorption of permanganate is an exceedingly unfavourable indication.

Here, however, a water may only be rejected for drinking or domestic purposes if nitrogenous organic matter is also present as shown by the determination of the **albuminoid** or **proteid ammonia**.

Albuminoid Ammonia is the name given to that evolved when a measured sample of water is distilled with a strongly alkaline KMnO_4 solution, and gives an idea of the amount of nitrogenous organic matter present. In a simpler manner, oxidation by potassium persulphate in acid solution, and determination of ammonia colorimetrically, thus avoiding a distillation, gives the **proteid ammonia**.

These determinations do not, however, permit of the absolute amount of nitrogenous organic matter present being calculated, but serve as a guide to the proportions of these substances. These two are among the most important chemical methods of examination, since extremely minute traces of substance of animal origin present can be detected with certainty by the proteid ammonia test.

Ammonia and nitrous acid are not only present in rain water, but are formed by the reducing action of micro-organisms on nitrates; if, however, more than traces of albuminoid or proteid ammonia are found, decaying or unchanged nitrogenous organic matter is certainly present, and almost sure to be of animal origin.

While the determination of **albuminoid ammonia** requires scrupulous care for reliable results, that of **proteid ammonia** is easy and gives the following criteria: pure natural water contains no proteid ammonia, and therefore any quantity present may be considered an index of the amount of nitrogenous matter to hand. When more than 0.1 mg. per litre occurs, the water is open to criticism from a hygienic standpoint, while 0.2 mg. per litre is the maximum allowed. The same conclusions may be applied to the albuminoid ammonia. If reducing power be considerable in the absence of albuminoid or proteid ammonia, either organic matter of vegetable origin only is present, or the decay of organic animal matter has reached its limit, and the water has experienced a certain degree of self-purification.

Phosphoric Acid being only present in traces in pure natural waters, any appreciable quantity indicates pollution, since the excrements of men and animals are comparatively rich in phosphoric acid.

Lead is always injurious, and water containing more than 1 mg. and over per litre must be described as poisonous.

Water comparatively rich in **bacteria** must be avoided whenever possible, and those with abundance should be condemned.

Lunge states that since the absolute number of bacteria in water varies so much, serious mistakes may be committed if the water be judged on this alone. Counting the bacteria is chiefly employed for controlling the efficiency of purifying plant, filter beds, etc.

PURIFICATION METHODS FOR DRINKING AND DOMESTIC WATER

For the purification of drinking and domestic water, sedimentation in large reservoirs followed by filtration is the most usual method. During the settling process there is an almost complete removal of suspended mineral matters, and with them a large proportion of living organisms, while oxidation of the dissolved organic matter takes place; unfortunately, the deposited bacteria continue to live and multiply in the muddy sediment, unless this is removed at frequent intervals, thereby necessitating regular periods for cleansing with additional reservoirs for the maintenance of the service.

In this connection deep well waters are not improved by storage, but are better delivered as pumped provided they are clear, which is almost always the case after the well has been worked for some time. Since pathogenic and other bacteria multiply in these waters with great rapidity, they should be kept in closed reservoirs when storage is absolutely necessary, as in the case of the Kent Co. at Deptford.

For small **house filters** the usual filtering media are kieselguhr, asbestos, porous earthenware plates, spongy iron, coal, etc., while Birkeland has used kieselguhr for large quantities.

On the **large scale** the slow **sand filtration process** is still the most complete method for purifying surface water, and offers the greatest security for retaining infectious germs. The general construction has not altered much of late years, and whether open or closed depends on the local frost conditions.

Every filter must be constructed with regard to the rate of passage, over-pressure, and condition of the filtrate. The velocity of filtration should be uniform and secured against sudden fluctuations and interruptions. The pressure must not be great enough to break the upper slimy layer which forms on the surface of the filter, and the limits must be determined by bacteriological control, while the thickness of the sand layer must be at least so considerable that on cleansing its efficiency remains unimpaired.

The action of the sand filter depends on the formation of a slimy layer composed of finely divided clay, algæ, etc., in which the main purification of the water takes place. Here a felted mass of bacilli and streptococci are entangled in a gelatinous layer of the zooglæa colonies of micrococci together with the algæ, and a sand filter cannot attain its maximum efficiency until this jelly layer has been produced. When once formed, however, the purification proceeds by the action of the nitrifying organisms immediately below this film.

In time the filter becomes clogged and it is necessary to skim off the surface layer and prepare a fresh coating of sand; the filter then requires several days before again resuming its activity. In America where considerable progress has been made in water technology, sand purification apparatus are installed on the filter itself. If a filter be allowed to act for too long a period, a gradual growth of the surface bacteria through the filter bed ensues, and, the effluent thereby becoming contaminated, necessitates the complete renewal of the whole filter bed. At Hamburg and Berlin, where Koch's limits are adopted, no water is allowed to pass through a filter at a speed exceeding 100 mm. (about 4 in.) per hour. The London filter beds usually consist of a layer of sand 2-4½ ft. in thickness, with gravel and stones below. The daily rate of filtration should not be more than 2 million galls. per acre. The sand filter cannot be relied upon to remain unfrozen in America, and the Morison-Jewell Filter Co. of New York use a film of gelatinous alumina for the slimy organic film of ordinary sand filtration.

The disadvantages of sand filtration are: the large space involved, the frequent cleansing, and the slow action.

Recently a large number of improvements have been made, and **quick mechanical filters** have been introduced for dealing with the water after it has first been sedimented for removal of the coarser suspended matters. It is also frequently necessary to assist the settlement of the fine particles by means of the addition of sulphate of alumina, iron, salts, lime, etc.

The characteristics of these filters are the 40-50 times filtration velocity of the sand process, the small extent of filter surface, and the purification of the whole filter material in the chamber by means of mechanical equipment. The material of the filter tanks is almost exclusively a uniformly coarse quartz sand, which is packed vertically in relatively small cylindrical tanks of wood, iron, or concrete.

The filters are constructed in two systems, an **open gravity** and a **closed pressure type**. Innumerable patents have been taken out for quick filters, the following being descriptions of Reisert's patents, as supplied by Messrs Royles

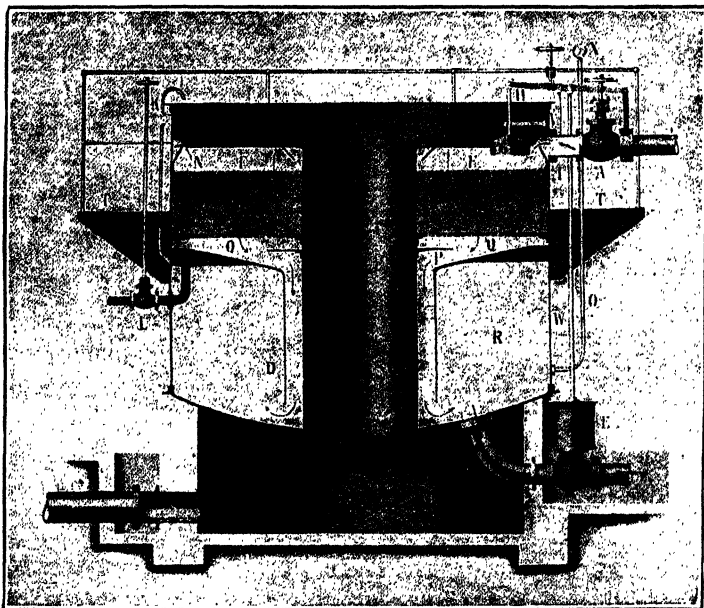


FIG. 1.—Reisert's Rapid Filter in operation (vertical section).

(Messrs Royles Ltd., Irlam, near Manchester.)

Ltd., of Irlam, near Manchester, for whose kind permission to publish the author here returns his hearty thanks.

A description will now follow of an **air-cleansed type** of a **Reisert's rapid filter**, specially suitable for drinking water and water for manufacturing purposes in large quantities.

Since the filtration of water is in itself a common operation, the superiority of one filter system over another will depend largely upon the rate of filtration and the method of washing out the filter bed. In the construction of the Reisert Patent Filter to be used for this purpose, an important adjunct is a speed regulator which ensures a constantly equal speed in the rate of filtration. To effect perfect filtration of the water, it is important that there should be a uniform speed of filtration regardless of the state of the filter bed. If this is not provided for by some mechanical device, there is certain to be a much higher speed of filtration after the first washing out of the filter on account of the reduced resistance, which impairs the efficiency of the filter. As the resistance of the filter increases owing to the accumulation of mud, the quantity of water delivered is reduced unless some means are provided for increasing the pressure on the filtering material. All this is perfectly effected by the Reisert Speed Regulator, which enables a constant amount of water to be

delivered by the filter during all states of the filter bed from the moment of cleansing to the time for cleaning out.

The cleansing is also carried out in the shortest possible time and with the smallest amount of washing water. The usual method of washing out filters of this type is by some mechanical stirring device intended to disturb the top layer of the filtering material, and which takes place simultaneously with the reversal of the flow of the water through the filter. This is a relatively slow process, and the filter bed by such an arrangement is never thoroughly cleaned. In the Reisert patent the cleansing is effected by a strong back wash operation, rousing up the whole filter bed, and to effect this promptly and in the most thorough manner use is made of compressed air by which a large volume of water is forced backwards through the filter bed. Usually not more than twenty seconds are required by this cleansing method, and the filter bed settles down, again delivering absolutely pure water. It would be impossible to effect this thorough cleansing by any of the ordinary wash-out operations owing to the excessively large pipe sections and valves required, but by using compressed air for the purpose of forcing the water through the filter bed, a very small ratio of air pipe section suffices as compared with the water pipe section necessary to supply the same quantity of water under ordinary conditions.

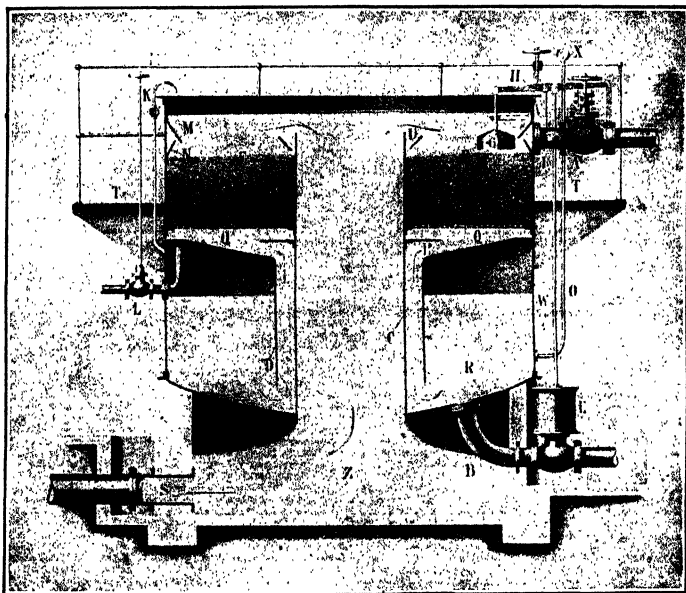


FIG. 2.—Reisert's Rapid Filter during washing-out process.
(Messrs Royles Ltd., Irlam, near Manchester.)

Figs. 1 and 2 show in vertical section a filter element resting on a concrete foundation, viz., Fig. 1 in operation, and Fig. 2 during the washing out.

Fig. 1—Filter in Operation.—The filtering medium *F* of fine granulated quartz rests in a cylindrical holder on a filter floor *Q*, consisting of perforated zinc, and bronze wire cloth laid between. The crude water flows through the valve *A*, and the throttle valve *I*, into the annular space formed by the slanting zinc sheets *M* and *N* from whence it flows even on to the filtering material without disturbing its upper portion. After the crude water has penetrated through, the filtrate passes into the pure water cistern *R*, through the annular space created between the cylinders *C* and *D*, from whence it flows out through the bend *B* and the regulator *E*.

Fig. 2—Washing out of the Filter.—The patented regulator *E* is arranged for the desired capacity, so that the filter speed remains constantly equal from the commencement after the washing out, until the maximum amount of mud has accumulated. This regulation is extremely important for obtaining the most satisfactory results. The float *6* placed above the filter bed regulates not only the

crude water feed by means of the throttle valve *I*, according to the capacity arranged by the regulator *E*, but it also closes the regulator *E* by the corresponding motion of the rods *H* and *W*, so that the water surface can never sink lower than the filter top layer.

The vacuum meter *X* indicates the degree of resistance of the filtering material. If such an amount of mud has been accumulated that, in spite of the now quite opened regulator, the filter pressure is no longer sufficient for the capacity, then it is time for washing out the filter.

To effect this the throttle valve *I* for the crude water feed and the regulator *E* are closed by means of the screw spindle placed above the lever *H*, which moves downwards the throttle valve rod *V* and the regulator rod *W*, after which is opened the air valve *L*, which is in connection with an air chamber. The inflowing air presses the pure water in the cistern *R* in the directions of the arrows, and drives it with great rapidity through the filter material from bottom to top. The water draws with it all the mud and plunges through the cylinder *C* into the chamber *Z*, whence the muddy water flows out through the outlet *S*. At first the whole filtering material lifts up and then falls back through the pure washing water streaming up towards it, thereby freed from all the mud. This process lasts about twenty seconds. Through the letting in of greater or lesser quantities of air, it can be arranged to use any desired amount of washing water. If no other arrangement is made, the amount of air as a rule depends on the amount of pressure in the air chamber, which is

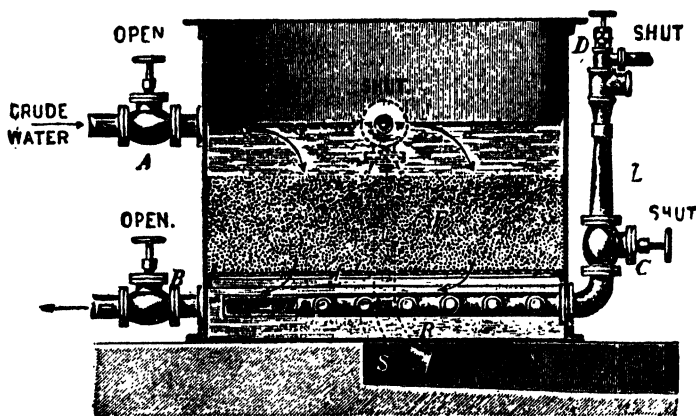


FIG. 3.—Royle's Gravity Filter in operation.

readable on a manometer. After the closing of the air valve, and the slow opening of the throttle valve and the regulator, the filter again comes into operation. The air escapes gradually through the small valve *K*, whereby the pure water chamber slowly fills again. During the filtering period the attendant must fill the air chamber, which is sufficient for a battery of any number of filters up to twenty filter elements.

Messrs Royles also make an air-cleansed type of **gravity and pressure filter** for the clear filtering of muddy or turbid river or canal water for bleaching, dyeing, wool scouring, milling; also for silk manufacturers, cotton spinners, cellulose and paper mills, sugar and starch works, and all industrial purposes.

The filter consists of an open or closed cylindrical vessel (Figs. 3 and 4), in which perforated plates support the filtering material, which consists of fine gravel. Fig. 3 shows the apparatus when working, and Fig. 4 during the cleansing operation. The crude, muddy, or dirty water enters at *A*, passes through the gravel from top to bottom, and is discharged crystal clear at *B*. When the filter is very dirty, so that a perceptible falling off in duty is to be noticed, it is time that the gravel was cleaned.

For this purpose the supply is shut off at *A*, the mud outlet opened, and in the case of a closed filter, the air-cock. The steam valve *D* is opened, putting the air injector *L* into operation, and simultaneously the valve *C*. The compressed air is evenly distributed by perforated pipes over the whole of the underside of the filtering material. The air forces its way up through the gravel, which is violently agitated, and by allowing the clear water to flow backwards through the filtering

material in an opposite direction to that taken when filtering, a most effective and efficient cleansing is obtained. There exists no possibility of the filter being only partially cleaned (unlike "rake" arrangements which require power, and plough channels in the gravel, only affecting such parts), the whole being stirred and agitated from the bottom with equal violence over the whole area. The mud is thoroughly loosened and carried away by the backward flowing water to waste. Air escapes by the air valve on the top of cover in pressure filters. The air is forced under the filter

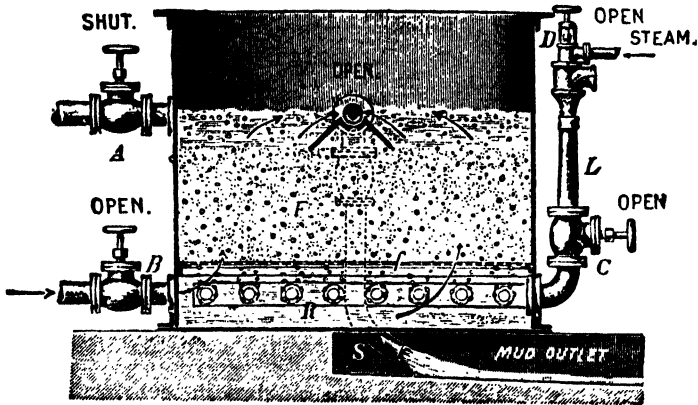


FIG. 4.—Royle's Gravity Filter, cleansing operation.

for two or three minutes, the steam supply shut off, while still allowing the water to flow backwards. As soon as the cleansing water discharging by the mud outlet is clearer, the clean water supply is shut off. The air-cock and mud outlet are closed and the supply valve A opened,

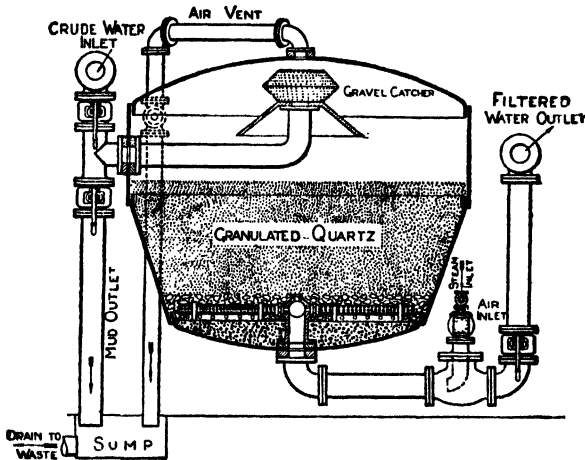


FIG. 5.—Royle's Pressure Filter.

thus making the filter ready for further use. The cleansing occupies about five minutes, and should be done once per day.

The capacity of the filter is naturally dependent on the original condition of the crude water. Should it not by ordinary simple filtration be possible to filter the water clear enough, or should it be necessary to remove any colour, then a medium must be employed whereby the infinitesimal small particles are made capable of being arrested, *i.e.*, filterable. The means of obtaining in all cases a

perfect, clear, colourless filtrate cannot be given haphazard, they being dependent on the condition of the crude water and the purpose it has to fulfil, as also the choice of filter to be adopted.

The **high pressure type of filter** is constructed for pressures exceeding 30 lbs. per square inch, up to any working pressure required. It is constructed of mild steel shell of suitable design to withstand the delivery head (see Fig. 5).

This type of filter is designed where the filtered water requires to be elevated to a considerable height without double pumping. It is also suitable for working for considerable periods before flushing. By this means the suspended matter collects on the top of the filter bed and provides an extremely fine filtering medium, giving most excellent results and perfect clearness of the water. As the deposit accumulates the pressure rises, and when this reaches the safe working pressure the filter is shut off and cleaned similar to the open type filter described previously.

The construction of the filter is as follows: At the bottom of the filter perforated copper tubes are arranged, of uniform pitch, over the entire surface. These are secured to a cast-iron header having suitably tapped holes for the reception of the tubes. At the top of the cast-iron header a series of nozzles are arranged so as to agitate thoroughly the centre of the filter when cleaning. The perforated copper tubes are bedded down on suitable supports fixed on a concrete bed. Coarse spar is placed on the perforated tubes, covering these to a depth of a few inches, and on the top of this fine granulated quartz is placed about 2 ft. 6 in. deep. The crude water enters at the side of the casing near the top, and is distributed over the filter bed by a conical cast-iron spreader. A copper gauze gravel-catcher is fitted on the top of this, so as to prevent any of the quartz passing over when cleaning. After passing through the filtering material the water enters the perforated copper tubes and flows as perfectly clear water to the outlet. Steam and air injectors, also flush water valves, are provided for thoroughly cleaning out. Messrs Royles state that over 4,500 are in actual use, giving entire satisfaction.

Two methods much in use for the **purification of drinking water** are **distillation** and **sterilisation by heating**. Since distilled water attacks almost all metals except silver, gold, and platinum, Bohemian glass is chiefly used for laboratory distillation purposes. A single boiling is sufficient to free the water from disease-carrying organisms, and several forms of apparatus have been designed to deliver large volumes of water sterilised, but these are obviously inapplicable for a town's supply, and so other methods of sterilisation will be considered. Such fall into two main classes, according as to whether the action is chemical or physical.

CHEMICAL METHODS OF STERILISATION

These may be divided into three classes, viz. :—

1. Those which bring about a chemical precipitation.
2. Such additions as bring about the oxidation of organic substances, and simultaneously their disinfection.
3. Such additions as destroy bacteria, algæ, etc., or inhibit their growth.

I. PURIFICATION BY CHEMICAL PRECIPITATION

The chemicals chiefly used are the salts of **aluminium**, **iron**, and **copper**, **calcium carbonate** with and without **lime** or **sodium bicarbonate**, **lime alone**, and also **sodium chloride**. The action consists in the direct precipitation of the dissolved substances, also in the separation of such suspended particles as are difficult to remove by sedimentation or filtration, such as clays, colloids, bacteria, etc. Indirect precipitation is frequently employed, whereby two compounds are caused to interact, producing an insoluble third which carries down the impurities in a flocculent precipitate. These methods, in combination with quick filtration, have been largely used for the purification of surface waters, particularly in America.

The choice of the precipitating material depends on the nature of the water, and also on the market price of chemicals. Aluminium and iron salts are particularly efficient for producing flocculent precipitates. To avoid using potassium sulphate, *e.g.*, in alum, artificial aluminium sulphate, guaranteed arsenic free, is employed. Excess of sulphuric acid in very soft waters must be neutralised by sodium bicarbonate or lime. Iron salts, *e.g.*, ferric chloride, were earlier recommended, with addition of lime or sodium bicarbonate, but here the two solutions must be weighed out accurately, otherwise the water may contain too much dissolved iron or acquire an alkaline taste by excess alkali. In Anderson's process the water is placed in a revolving purifier which contains numerous small pieces of iron, afterwards being aerated and filtered.

In this connection space might be devoted to the **excess lime method for sterilisation of water**, concerning which Dr Houston's reports to the Metropolitan Water Board are extremely interesting. Dr Houston formerly recommended storage as a method of rendering London Thames water safe, since pathogenic organisms commonly disappear in water when kept, but storage must not be less than two weeks, and might, with advantage, be one or two months. Later, he reports that despite the remarkable improvement effected by storage, it seems unwise to trade too greatly on the circumstance if any practical remedy, even of a partial kind, is available. He finds that quicklime (about 75 per cent. CaO) added to raw Thames water in the proportion of one part quicklime to 5,000 parts water kills *B. coli* in five to twenty-four hours, and proceeds to carry this method out on a large scale.

In his eighth report of Feb. 1912, he records further experiments on quicklime as a steriliser for water, and summarises its disadvantages and advantages with a strong balance in favour of the latter. He states that "its complete fulfilment would raise the purity of the Metropolitan water supply to a pitch of perfection never before attained by any waterworks authority in the world, dealing with sources comparable with those of London." His summary at this stage is "15 lbs. of quicklime costing 1½d. would be added to 7,500 galls. of raw unstored Thames water. This would kill the *B. coli* within twenty-four hours, and inferentially, but certainly, the microbes also of epidemic water-borne disease, e.g., the typhoid bacillus. The water would also be improved considerably as judged by chemical and physical standards. The excess of free lime (about .007 per cent.) would then have to be neutralised with 2,500 galls. of adequately stored water, which, according to all his experiments, would not contain any of the microbes of epidemic water-borne disease. Rapid filtration alone would then be required to remove the precipitate of inert carbonate of lime." While admitting that the disadvantages of the excess lime method, grafted on to an existing water purification, are many and serious, he states that the mere cost of lime would probably be about double that of the present sand filtration. This excess lime idea is somewhat old, having been practised at Canterbury since 1860, and at Southampton since 1888, while it is well known that water after lime treatment is slightly caustic, has a deficiency of carbonic acid, and is apt to give after-troubles in the shape of lime deposits in the pipes, pumps, and conduits. On the other hand, the hardness of water within ordinary limits has practically no influence on the health of consumers.

II. PURIFICATION BY OXIDATION

Reichel found that **hydrogen peroxide** destroyed germs in drinking water but difficulties occurred through its ready decomposition. To remedy this, a 30 per cent. solution of **perhydrol** (which may be a mixture of the peroxides of sodium, calcium, or magnesium, with weak acids such as carbonic, citric, acid tartrates, etc.) has been put on the market, but although stable, it is very expensive. **Permanganates** have also been employed with success.

III. ADDITIONS WHICH DESTROY BACTERIA, ETC.

Bleaching Powder was the first of these to be proposed, but has now been replaced in recent years by the **hypochlorites of lime and soda** and by **electrolytic chlorine**.

According to Rideal, hypochlorites are now used by several hundred townships as a permanent or temporary feature of their waterworks scheme. Ideally the process cannot be considered so good as the sterilisation brought about by means of either ozonised air or ultra-violet light (see later), since, in the latter case, nothing at all is added to the water, while in the former case the oxygen content is merely raised; with the device of proper and regular controls, however, sterilisation with hypochlorites is more economical in installation, as well as in operation, than either of the other processes. In the United States the hypochlorite treatment has made great progress, and one town treats 30 million galls. per day at a cost of operation of 27.6 cents per million galls. (including chemicals, labour, and power), while another plant of 15 million galls. per day capacity is run at a cost of 96 cents per million galls.

The method has proved its value in checking water-borne typhoid epidemics, and it may be stated that while filtration alone may remove 97-98 per cent. of the bacterial contamination, the hypochlorite treatment, in conjunction with filtration, removes 99-99.9 per cent., i.e., the chlorination kills the bacteria which the filtration has left. How much treatment any water requires previous to chlorination depends solely on the actual nature of the water itself.

At Cleveland and Erie it is used alone ; at Jersey City and Baltimore with impounding reservoirs ; at Nashville and Omaha with sedimentation basins ; at Des Moines with an infiltration system ; with slow sand filters at Davenport, and with rapid at Cincinnati ; with mountain streams at North Yakima, and with well waters at Corning.

C. A. Jennings, of Chicago, in a paper at the International Congress of Applied Chemistry in 1912, showed from statistics that the general result of using hypochlorites is to decrease the number of typhoid cases by 65-45 per cent., and the number of deaths by 50-30 per cent. At Minneapolis, where raw Mississippi water was used without any treatment, the result of adding hypochlorites was to reduce the typhoid death-rate 95 per cent., which conclusively proves that water was responsible for almost the whole of the disease, and that sterilisation overcame the infection.

Since there are now so many appliances by which the ratio of the sterilising agent to the volume of the water pumped from the river or drawn on by the town can be automatically adjusted, there is no reason why any excess chlorine should ever be found in a public supply. Excess chlorine can be removed in part by Na_2SO_3 , $\text{Na}_2\text{S}_2\text{O}_3$, and $\text{Ca}(\text{HSO}_3)_2$.

Similar additions are **electrolytic chlorine** (by Rideal), **aqua regia**, **liquid chlorine**, **bromine** in alkaline solution (Schumberg), and tabloids of **sodium bromide** and **sodium bromate** formed by dissolving bromine in caustic soda, evaporating to dryness, and mixing with **sodium bisulphate**. **Acetic acid** and **formalin** have also been recommended, but all these methods are only applicable on a small scale.

Recently in America, Alexandria, etc., **copper sulphate** (1 in 100,000 to 1 in 1,000,000) has been proposed (C. T. Moore and H. F. Kellerman, U.S.A. Dept. of Agriculture, 1904-1906).

Very serious defects of certain waters are **lead and iron solvency**. The former has generally been prevented by treatment with **calcium carbonate** or **lime**, but the latter causes grave inconvenience in certain districts, and in the United States has been termed the "**red plague**" owing to the water being rendered unbearably ferruginous. Waters of very varying composition are liable to this evil and it has been connected with the growth of certain organisms, especially of the genus **Crenothrix**. There can be no doubt as to the accessory nature of the odours and taste, and while covering the reservoirs to exclude light discourages a large number of species, it is rather favourable to others, and, moreover, is only applicable on a limited scale. Resort has therefore to be made to sterilisation, and in this regard **copper sulphate** (1 part in 1-50 millions), has long been known to be effective, but has been restricted to emergencies owing to fear of its poisonous nature. **Hypochlorite** and **ozone** (see later) have both come into extended use in various parts of the world, with an experience that their expense is not unreasonable, and that they solve the old difficulties and dangers.

The different species of organisms require for their arrest varying amounts of chlorine, an important point being that the worst tastes and odours are generally the most susceptible. Rideal found that available chlorine just in excess of that immediately consumed by the water, although disappearing in a few hours, inhibited **confervoid growth** for some weeks. **Desmids** were slightly more resistant, and in some of Rideal's experiments the addition of some 0.5 part per million in excess of that immediately consumed by the water was required. **Diatoms** required about 1 part per million of chlorine in excess.

Rideal cites the interesting case of D. Leitch who has successfully combined several of the existing processes, and supplied a population of nearly 370,000 in the Johannesburg and Rand district with daily quantities of water between 7 and 8 million galls. The source is mainly from shafts and bore-holes in the dolomite, with some surface water and springs. The hardness is generally high, averaging 18-19 parts per 100,000, of which 9½-10 are said to be carbonate of lime and 7½-8 carbonate of magnesia. The supplies were often turbid and sometimes contained much iron, amounting frequently to 2 parts per million, which encouraged the growth of "weed" (presumably crenothrix and other algæ) in the mains. The water is softened by lime down to a mean of 14 parts per 100,000, and the growth of weed checked by the addition of 1 part in 3 millions of copper sulphate. The ferrous iron contained is then oxidised and precipitated, by falling through perforated plates on to beds of clinkers. With a weekly cleaning, the iron is reduced to between 0.2 and 0.3 part per million, which gives no further trouble. The total cost of the iron removal, including all capital charges, is about 5s. 6d. per million galls., and the chemical quality of the water is excellent. The bacterial content is low, rarely more than ten organisms per cubic centimetre growing at 37° C., but the use of a small quantity of chloride of lime reduced the total bacteria to one or two per cubic centimetre. The total cost of the works has been about £900,000 and the entire cost of the supply and treatment is given as 2s. per 1,000 galls. The water is sold by meter, and the whole scheme is a commendable example of thoroughness in treatment (see Rideal, *Chemical World*, 1912).

Ozone Treatment.¹—The most active chemical agent hygienically, and the one most free from objection for drinking water sterilisation, is ozone.

Experiments for treating water on an industrial scale and thus making use of the known fact of bacterial destruction by ozone, were carried out in 1891 by Frohlich and Siemens, and an experimental plant was soon afterwards erected at Martinikerfeld. The first installation on a large scale was erected by Schneller, Van der Heen, and Tindal at Oudshorn, Holland, for treating Rhine water which contained from 5,000-1,000,000 bacteria per cubic centimetre. This was followed by an experimental plant at the 1895 Hygienic Exhibition at Paris, and by an installation near Paris to sterilise 2 million galls. of water daily from the Marne. Siemens & Halske have also erected large installations at Paderborn and Wiesbaden.

The Pasteur Institute, the Koch Institute, and the Berlin Reichgesundheitsamt, have each conducted experiments which conclusively established the complete sterilisation of water by ozone, even on an industrial scale. It is essential though that the ozone meets every particle of water, and various forms of apparatus have been designed to this end (see p. 151 for diagrams and descriptions of these).

The amount of ozone needed for ensuring complete sterilisation varies naturally with the character of the water, but averages about 2 g. per cubic metre (220 galls.), *i.e.*, at the concentration employed a bulk of ozonised air equal to that of the water for purification. Suspended matter must be absent from the water, and if organic matter, which hinders sterilisation, is present, a larger proportion of ozonised air may be necessary. A like absorption of ozone takes place in the presence of iron.

At the present time more than forty towns in Europe and America have adopted this treatment, among which are: Petrograd (Siemens & Halske, 11,000,000 galls. per day), Nice (Otto, 10 million galls. daily), Philadelphia (Vosmaer, 1 million galls. from the Schuylkill river, whose water may sometimes contain 2½ million bacteria per cubic centimetre).

The cost must vary according to the condition of the water and size of plant erected, but for small installations should not exceed 1d. per 1,000 galls., while for large ones it may be less than ¼d.

Sterilisation of Water by Ultra-Violet Rays.—Although it is amazing to what extent water can be sterilised by well-conducted slow sand filtration, which fulfils the double purpose of clarifying the water and freeing it from the greater part of the microbes it contains, yet hygienists are still demanding greater purity than the filters are usually able to supply. The previous methods described have been more or less disinfecting processes consisting of the addition of chemicals to the water, each of which acted in its own peculiar way on the germs. The chemicals added to help filtration, *i.e.*, the precipitants, have at times not a toxic, but a physical effect upon the microbes, in that the precipitates which form themselves mechanically drag the microbes into the filter bed. The more recent hypochlorite and chlorine processes are having to make progress in face of a certain amount of aversion by the public to the idea that anything should be added to its drinking water.

The first electrical process proposed for the sterilisation of water is that of ozonisation already described, and a later development along electrical lines has been the use of **ultra-violet rays**.

Although this is the latest process, it is in reality the oldest, having existed in nature since the beginning of time; for sunlight, which is one of the most powerful bactericidal agents known, accomplishes the larger part of the natural purification of water. So far, the bactericidal power of the sun's rays has been studied, less in its relation to the production of a good drinking water, than in view of its action in rendering harmless the waste waters of towns. It is amazing to see how rapidly a river which is heavily polluted by town effluents is freed from its bacterial contents, and thereby rendered practically harmless to the health of the community. On the other hand, effluents running through sewers do not lose their toxic effects, thereby furnishing a proof of daylight sterilisation largely due to the bactericidal effect of the ultra-violet rays contained in sunlight.

Were this not so, what other explanation could be offered for the fact that in tropical countries where heavy cholera epidemics are breaking out from time to time, these epidemics eventually disappear without apparent reason, *e.g.*, in certain parts of India, where dead bodies are thrown into the rivers instead of burying or burning them, cholera epidemics only appear at rare intervals.

The spectrum of sunlight is extremely rich in ultra-violet rays, but a great part of these are absorbed by the air. The first study of their biological action was made by Finsen and his pupils, and applied for healing purposes, *e.g.*, lupus. If it has taken scientists a long time to study this problem of artificially illuminating water in view of sterilising it, the reason is twofold—in the

¹ For description and diagrams of apparatus, see under **Ozone**, p. 151.

first instance, because until recently the phenomenon was not analysed and attributed to the bactericidal action of ultra-violet light; and secondly, powerful sources of such light have only quite recently been established.

The first proposal to immerse a mercury vapour quartz lamp producing ultra-violet rays in a current of water in view of sterilising it, is contained in De Mare's Patent, 1906. It was not until about two years ago that this work was again taken up, chiefly in France, and by Messrs Henri, Helbranner, and von Recklinghausen at the Sorbonne University in Paris.

The production of ordinary light is not always accompanied by a large output of ultra-violet rays, *e.g.*, gas and incandescent filament light are very poor in ultra-violet radiations. On the other hand, sources of light which are based on the incandescence of vapours seem to be exceedingly rich in this type of radiation, *e.g.*, the incandescent vapour forming the surface of the sun. The sources of light based on the incandescence of vapours belong largely to the type of the electric arc playing between metal electrodes; *e.g.*, Finsen has used the arc between iron and similar electrodes, but such a source has the inconvenience of not burning very steadily, and of requiring a regular feeding mechanism which moves the electrodes. In addition, Finsen's arcs throw off oxide of iron, or other metal vapours, which have to be removed from the source of light in order to avoid the obstruction arising therefrom. It has, therefore, been preferred to use metal arcs which are fully enclosed and do not allow the metal vapour to escape. The typical metallic arc of this kind is the **mercury vapour lamp**, which is enclosed in a quartz container. This mercury vapour lamp presents an absolutely steady light, burning without flickering, and giving, under properly chosen conditions, an absolute uniform light of even strength. Besides, the lamps of this type have a very long life, and therefore present an economical source of ultra-violet light.

The results of Henri, Helbranner, and von Recklinghausen with regard to the **sterilisation of water** are as follows: Water infected with *B. coli* is freed of this under the influence of a 220 volt 3 amp. Westinghouse silica lamp within:—

	1 second	at a distance of	4 in.
4	"	"	8 "
15	"	"	16 "
30	"	"	24 "

The temperature of the liquid or solid to be sterilised has little influence on the speed of sterilisation. Even ice, if as transparent as water, may be sterilised in practically the same time as liquid water. The action of the ultra-violet light is equally effective, no matter whether free oxygen is present in the water or not.

The sterilisation is not due to the production of hydrogen peroxide in the water, as the quantity of this hydrogen peroxide produced by the influence of the ultra-violet light is so small that it would be impossible for it to destroy the coli. The presence of hydrogen peroxide can only be determined by very direct methods after an exposure of water during hours to the ultra-violet rays, whilst the sterilisation takes only a few seconds' exposure. The bactericidal effect, therefore, is exclusively that of the ultra-violet light, and not due to any chemical action produced in the water.

The various classes of microbes are not all equally sensitive to the ultra-violet light, just as they are not equally sensitive to heat or chemical agents. The following are some comparative periods of annihilation: Staphylococcus, 5-10 secs.; cholera, 10-15; coli, 15-50; typhoid, 10-20; dysentery, 10-20; pneumobacillus, 20-30; subtilis, 30-60; tetanus, 20-60.

It was found necessary never to interpose glass between the rays and the water, as glass is practically an absolute absorbent of the ultra-violet rays. Air has also great absorbent power, and therefore it is important to have as little air space as possible between lamp and water, although a small space is necessary so that the lamp should not touch the water directly, otherwise its temperature would be considerably lowered, and its electrical characteristics changed to such an extent that the light emission would be seriously reduced, and the sterilising action diminished. On the other hand, experience has shown that lamps which touch the water directly

(submerged lamps) are covered after a while with scale-like boiler tubes, which scale is impermeable to the rays, thus preventing the lamp from sterilising.

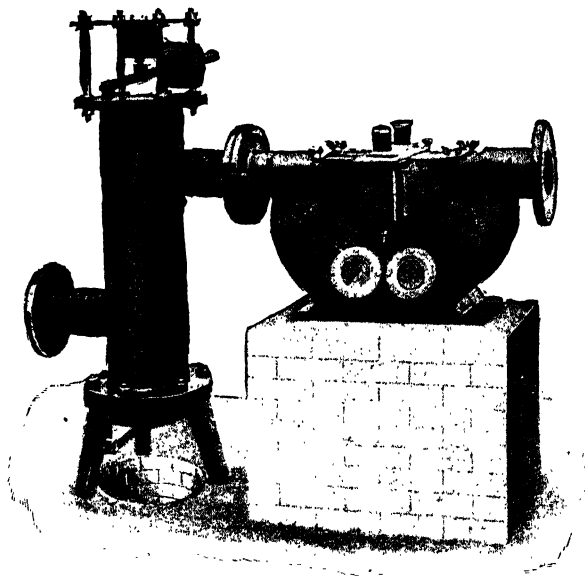
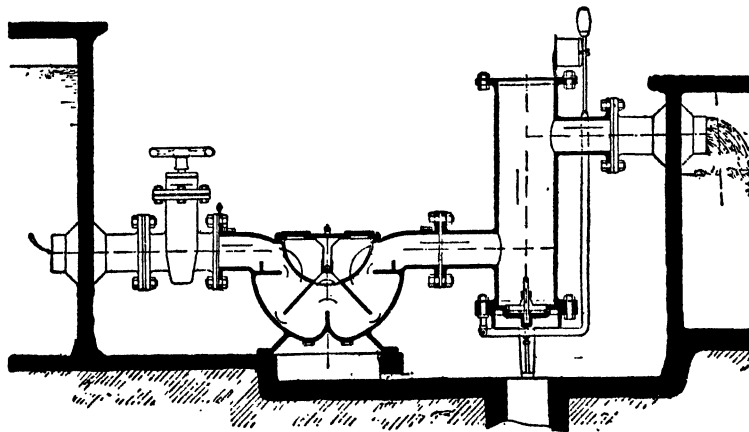


FIG. 6.—Sterilisation of Water by Ultra-Violet Rays. The "R.U.V." Steriliser.

In some trial experiments before designing the R.U.V. steriliser, the water was allowed to flow in large quantities under several successive lamps of the Westinghouse silica type. The lamps in



Section Through "R.U.V." Steriliser.
Type C. 3.

FIG. 7.—Sterilisation of Water by Ultra-Violet Rays.

this case were placed on floats, so as to be constantly near the surface of the water. The water channel was 10 in. wide and 12 in. deep: the flow could be varied between 1,000 and 10,000 galls. an hour. In a trial with water artificially infected by a specially prepared emulsion of coli bacteria, the greatest effect was obtained by the first lamp, where 5,000 coli germs per cubic

centimetre were reduced to 100, and by the second lamp to zero. Taking account of the speed of the water and the energy consumed by the lamp, it was found that with 160-165 watt hours per 1,000 galls. the infected water was absolutely sterilised. The water must be properly clarified before use.

In the R.U.V. steriliser the water under treatment is made to flow past a source of ultra-violet rays, *i.e.*, a mercury lamp. A number of baffle plates are arranged in such a way as to make the water pass several times under the influence of rays, therefore ensuring complete destruction of the microbes (see Fig. 7).

Many problems of modern hygiene have been solved by the use of perfectly sterile water, and in dealing with these it is often desirable, and never disadvantageous, to retain the salts and gases which are in solution. This object is attained by the present system which does not precipitate the soluble salts, and in no way modifies the physical and chemical qualities of the water treated, only destroying all the noxious germs. Industrially such water can be employed for the manufacture of beer, artificial ice, and mineral waters, while it will render great service for the washing of bottles for liquids such as milk, beer, cider, and vinegar. Research has shown that the use of sterile water for the washing of butter has a marvellous effect, the butter keeping for a month without suffering any deterioration.

Solvent Action of Water on Lead.—In the next section, various processes are described for taking the hardness out of water so as to render it suitable for industrial purposes. Now, for drinking purposes **hard water** is not disagreeable except when certain limits are exceeded, and it is well that such should be the case since hard waters have not the same solvent action on the lead and iron pipes as that possessed by soft water. Since lead pipes are chiefly used in households, lead being the most convenient metal available, a few words on the solvent action of soft water are necessary. Air-free water has no effect on lead and any action appears to be due to dissolved oxygen assisted by carbon dioxide, whereby the lead is first transformed into the hydroxide



and then into the soluble bicarbonate $\text{Pb}(\text{OH})_2 + 2\text{CO}_2 = \text{Pb}(\text{HCO}_3)_2$. Chlorides and nitrates also promote solubility, while sulphates appear to exert no appreciable influence. Soft waters must therefore be treated when for domestic use through lead pipes, and for this purpose, caustic alkalies, and the carbonates and bicarbonates of sodium, calcium and magnesium have been used. To a less extent the lead pipes have also been protected by tinning, but it is more usual to make the water sufficiently hard as above, when it will pass through the pipes unscathed.

FEED WATER FOR BOILERS AND OTHER TECHNICAL PURPOSES

A good water for boilers should not attack the iron or form boiler scale. The iron is attacked by free acids, also organic humus acids, by fats which split off acids, by sulphuretted hydrogen, and other chemicals. The greatest destruction ensues by rusting through the oxygen of the feed water, which action is appreciably promoted by the presence of salts, *e.g.*, sodium chloride.

Only **alkaline waters** such as soda, borax, etc., inhibit the tendency to rust. The **boiler scale** is due to the hardness of water which itself ensues through the presence of bicarbonates and sulphates of calcium and magnesium.

The "**hardness**" is expressed in units of CaO or CaCO₃ per 100,000 parts of water, the magnesium salts being calculated into equivalents of CaO. An **English degree of hardness** is equivalent to 1 gr. of CaCO₃ per imperial gallon of 70,000 gr., or 1.43 parts per 100,000. Other countries have adopted different standards. "**Total hardness**" denotes the total CaO and MgO calculated as CaO; "**permanent hardness**" is that which remains after boiling the water for some time, filtering, and diluting to the original volume with distilled water; the difference between total and permanent hardness is termed "**temporary hardness.**" The

latter, which coincides essentially with the amount of calcium and magnesium carbonates deposited on boiling and originally present as bicarbonates, is determined by titration in a similar manner to alkalies, and therefore may be termed the "alkalinity."

When hard water is evaporated, its mineral impurities are precipitated and settle on the shell, tubes, and furnace crowns of the boilers as a hard scale, which, by checking transmission of heat to the water, causes waste of fuel and damage to plates. The scale-forming constituents of natural waters are the **bicarbonates of lime and magnesia, calcium sulphate, and silica**, whilst waters containing **sulphates, chlorides, and nitrates** also assist in scale deposition by reacting among themselves.

The scale deposits form an insulating medium with a high power of resistance to heat, and according to Rankine this resistance of carbonate of lime is seventeen times that of iron, whilst sulphate of lime offers forty-eight times the resistance. Rankine, therefore, calculates that $\frac{1}{4}$ in. of average scale necessitates the expenditure of 16 per cent. more fuel, $\frac{1}{2}$ in. of 50 per cent., and $\frac{3}{4}$ in. of 150 per cent. extra fuel, to generate the same amount of steam as compared with a clean boiler. It has been ascertained that whereas the temperature of a clean boiler plate is only 350° F., that of the same plate covered with $\frac{1}{4}$ in. of scale is 750° F., *i.e.*, the scale-covered plate has to be heated 400° F. above the temperature actually required to convert water into steam.

Chlorides do not cause the formation of boiler scale, but they may attack the iron of the boiler plates, especially magnesium chloride, which at the high temperature and pressure of a boiler will hydrolyse into hydrochloric acid and magnesium oxide.

According to Ost (*Chem. Zeit.*, 1902, 26, 819) the latter compound is the sole cause of this effect, but it can only occur in injurious amount in feed waters very infrequently. J. Pfeifer (*Z. angew. Chem.*, 1902, 15, 194) is of opinion that the soluble **magnesium salts** react, at the pressure present in the boiler, with the calcium salts, forming readily soluble calcium salts, and difficultly soluble magnesium compounds. Magnesium has an injurious effect because its carbonate becomes basic on boiling, and the carbonic acid thus liberated assists in the corrosion of the iron.

Jamieson draws attention (*Journ. Ind. Eng. Chem.*, 1901, 1, 787-788) to the necessity of making determinations of **nitrates** in cases where ground waters are used for the purpose of feeding boilers, and cites instances where the use of well waters containing relatively large quantities of nitrates resulted in rapid corrosion of boiler tubes.

Acid waters cannot, of course, be used for feeding boilers without previous treatment, preferably with lime.

These only occur as a rule in mine waters (*e.g.*, by weathering of sulphides) and in moorland waters (peaty and humus acids).

The effect of **hard and impure** water is therefore: (a) To cause the expenditure of extra fuel; (b) to impose on the boiler plates and tubes unnecessary strain, due to the insulating action of the scale; (c) this strain due to superheating is supplemented by the disintegrating action due to the difference in expansion between iron and scale which causes rapid deterioration of the boiler; (d) the pitting and corrosion due to presence of such dissolved substances as magnesium chloride and ferrous sulphate.

On the question of coal waste information is somewhat diffuse, but Lassen and Hjert state that the colliery manager of the Birtley Iron Company has written them to the effect that after introducing one of their water softeners they are using 11 per cent. less fuel, notwithstanding the fact of an increased output of coal and a consequent larger steam consumption. Calculations based upon coal prices indicate that in actual practice 4d. to 2s. per 1,000 galls. must be added to the initial cost of hard water. It follows, therefore, that in the absence of some cheap and efficient method of softening, such waters are always dear to the steam user, whether he has to pay at the rate of 1d. or 1s. per 1,000 galls.

To the extra expenditure on fuel must be added the cost of cleaning and repairing the boilers, in order to keep them in something like a fit condition, and avoid absolute wreckage in a short time. Besides blowing out the boilers they have to be periodically gone over with the chisel to make an impression upon any hard scale that may have formed. Even in the case of a simple Lancashire boiler, this task of scale removal is by no means an easy one, and is rarely properly done. The difficulty is increased when a boiler with internal flues and cross tubes is employed, still greater in the case of multitubular boilers, and greatest of all where water-tube boilers are in use. Periodical and expensive cleaning is only a palliative and safeguard, not ensuring cleanliness or efficiency, or preventing the rapid deterioration of the boiler which goes on all the time, and it is safe to assume the natural life of a boiler to be shorter by one-half.

As before stated, the scale-forming constituents are the carbonates and sulphates of lime and magnesia, silica, and other salts such as chlorides and nitrates. The carbonates are not soluble in water *per se*, but are taken into solution as bicarbonates by carbonic acid gas derived from the atmosphere and soil. When such a water is boiled the carbon dioxide is liberated, and the carbonates, being insoluble in water alone, are precipitated. Calcium sulphate, however, is soluble in water itself, and not through the agency of carbon dioxide. The most favourable temperature is 95° F. (35° C.), when 1 part dissolves in 400 parts water, and inasmuch as the solubility is considerably decreased at 100° C., if a saturated solution at 35° C. be heated to 100° C., precipitation of a portion will ensue, while at the temperatures in high pressure boilers it is rendered insoluble, and the whole precipitated.

The chief differences in boiler scale are due to variations in the proportions of calcium carbonate and sulphate.

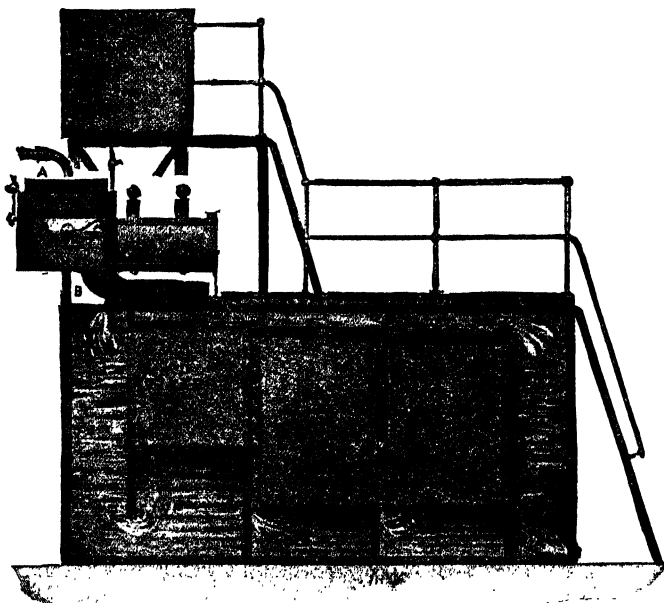


FIG. 8.—Lassen and Hjert's Standard Purifier.

In the case of **marine boilers** it was possible to use **sea water** at comparatively low pressures, but with high pressure tubular boilers the quantity of deposit becomes serious, especially as sea water possesses a very high content of calcium sulphate, and the amount of labour, deterioration, etc., renders the use of sea water impossible, distilled water having to take its place. After use the steam was condensed and returned to the boiler, in which state it always contains some of the **lubricants** from the engine cylinders. When the lubricator happened to be an animal or vegetable oil considerable damage was done to the boiler plates, since the superheated steam saponified the oils and liberated fatty acids. It is, however, imperative to remove the oil if the water is to be used for boiler feed, as it is well known that a thin layer of oil on boiler flues causes overheating and danger of collapse. For this purpose various filtering apparatus have been designed, but none of them have effected the desired aim, viz., to give a crystal clear water entirely free from oil. By subjecting the water to a chemical process it is possible to transform the oil from its emulsified state to such a form as will make it amenable to perfect filtration. Sulphate of alumina and carbonate of soda are

mixed with the water in Lassen and Hjert's Standard Purifier, whereby a heavy and flocculent precipitate is almost instantly formed, which attracts the globules of oil and renders their retention in filters possible. The alumina will react acid, and to counteract such acidity it is necessary to add a slight excess of soda to the water. For high oil percentages two compounds of zinc and potassium are used. The **Standard Purifier** will now be described (see Fig. 8):—

The water is discharged into a tipping trough A, divided into two compartments of triangular form. When one compartment becomes full of water it tips over, and the other compartment is brought under the orifice of the inlet pipe. In this manner certain quantities of water are measured out automatically.

At each oscillation two valves fixed in the chemical reservoir J are opened. The reservoir J is divided into two compartments, one containing the soda and the other the alumina. The extended axle carrying the tipping apparatus also carries the cams which open the valves. The lift of the valves can be adjusted with perfect accuracy, and thus the amounts of the chemical reagents are properly regulated.

The alumina and soda are diluted to the required strength and placed in the two compartments of the chemical reservoir J, whence they are passed into the water through the two valves in the bottom. In the case of large installations, the overhead tank shown in the illustration is included. It consists of two compartments for holding a large supply of alumina and soda solution, these solutions being fed automatically into the two compartments of J. The water and chemicals meet in the shoot B, whence they are discharged into the first compartment C of the purifier. The coagulating action of the chemicals takes place in C, and the water is then ready for filtration. The purifier is provided with three filters, D, E, and F, through which the water has to pass, the filtering material depending largely upon the nature of the water. After the water has passed through the last filter F, it is discharged into the storage tank G, ready for use. The flange H is connected to a feed pump, whence the water is drawn to the boilers. Each compartment of the purifier is provided with a scum cock, to draw off the oil which will collect there. A very important feature of Lassen and Hjert's apparatus is that the filters can be used for months without being cleaned, and there is consequently no waste of water as in the case of purifiers in which sand filters are used, which have to be cleaned out several times a day, thus increasing the cost of working.

The condition and physical properties of a scale deposit are largely affected by the presence of **calcium sulphate**, since this salt separates out in fine needle-shaped crystals, and, aided by the magnesium hydroxide, binds the whole deposit into a hard mass. If, however, the calcium sulphate is absent, the deposit of calcium carbonate is a soft powder which remains in suspension for some time, finally settling into a mud capable of easy removal.

Prevention of Scale Formation Anti-incrustators.—For overcoming the above serious drawbacks, various means of preventing incrustation have been devised. In fresh-water boilers, incrustation may to a certain extent be prevented or at any rate diminished by the addition of substances which will prevent the calcium sulphate binding the carbonate into a hard mass. These **anti-incrustators**, of which there are legion, and for which the patent literature must be consulted, may be divided into two classes:—

1. Those which are purely mechanical.
2. Those which involve some definite chemical action.

As examples of the **first class** may be quoted methods by which surfaces are offered upon which the deposit may accumulate in preference to the boiler plates, such as the suspension of brushes or bundles in the boiler capable of easy withdrawal; the addition of finely divided matter of organic origin such as spent tan, barium tannate (see Burotinghaus and Schroeder, English Patent, 23,618, 1909), etc., which by settling with the deposit prevents crystallisation of the calcium sulphate, and thereby enables the loose deposit to be removed at the sludge cock.

C. Haythorpe (English Patent, 23,123, 1909) has proposed an interesting mechanical treatment of feed water for the prevention of incrustation, corrosion, or pitting. The hot feed water is passed through a closed chamber divided into a number of compartments by perforated zinc plates, the compartments being filled with crushed coke or the like. The zinc plates and the carbon act as a galvanic couple, removing sulphates from the feed water and causing fat and grease to separate out. The carbon also acts as a filter. The metal plates may be made of an alloy of zinc and aluminium. The chamber is provided with a sludge cock, a removable lid, and an air outlet or valve.

A process of extreme interest and not involving the use of chemicals, is the treatment of water by **aluminium plates** for preventing scale formation.

This idea was introduced by Brandes, who by the "luminator" apparatus claims to cause the water to undergo such profound change that when used in steam boilers little scale is deposited, old scale is softened and detached from the plates, while the precipitable salts are deposited as a powder. The treatment consists in allowing water to run down an aluminium plate of special dimensions, with corrugations of a particular size according to the character of the water to be treated. It is only necessary to brush the channels to keep them clean. Storage tanks and mains, if far from the boiler, must be coated with a non-conducting composition—any bituminous varnish will do—and the water must reach the boiler as soon after treatment as possible. In any case, to get the maximum effect, the water must be used within seven days of its treatment. When water is passing continuously day and night, it may be necessary to rest the apparatus about a day per week, as the plates under certain conditions become inert, a circumstance which seldom happens, however. The theory of the action is that by the passage of water over the metal channels at certain speeds, a current of electricity is induced, the water being negative and the plates positive, whereby a kind of ionisation of the salts takes place, causing them to fall out in an amorphous form; at the same time aluminium is by friction and electrical action corroded from the surface as colloidal aluminium, which after a time is changed in the water. The best results are obtained when exposed to direct light. The action in the boiler is somewhat obscure, but in all probability the colloidal aluminium acts as a series of nuclei or active centres for the evolution of carbon dioxide and the crystallisation of salts, while the aluminium particles also combine with the dissolved oxygen of the water and so deoxidise it, thereby diminishing a cause of boiler corrosion. A boiler using the luminator should be blown off frequently, especially in the first stages of its use, because old scale comes off so rapidly that it accumulates at the bottom, and if permitted to remain there, might result in burning the boiler. Duggan cites one case where a boiler gave way at the end of a fortnight. The treatment has an extraordinary effect on foaming, for in every case this practically ceases. Alkali waters are easily treated, but acid waters give more trouble. The corrugations only function is to increase the surface of the plate. If traces of nitrates or nitrites are present, they are decomposed.

The treatment recalls a former common practice of placing zinc slugs in boilers which had the effect of causing precipitation in powdery form; this practice for some unknown reason has been abandoned within the last ten years.¹ Although the inventors state their case with considerable confidence and quote unimpeachable examples of its success, yet it will be advisable to exercise some reserve until further reports are to hand.

On this process are some later patents by C. Neeff and A. Brandes, viz. :—

(1) English Patents, 26,877 and 26,878 of 1910. Here jets of water under pressure are caused to impinge on plates or surfaces of aluminium or similar metals. Also water is forced under pressure over or through plates, corrugated sheets, gratings, rods, or tubes composed of impure aluminium or of an alloy consisting of 1 part tin and 25 parts aluminium. A block of aluminium, or of the alloy, may also be suspended in the boiler.

(2) English Patents, 25,632 and 25,633 of 1911. Here water suitable for washing and boilers is obtained, by causing it to flow rapidly through aluminium tubes, or such composed of an alloy of aluminium and tin, so that the disintegration of the metallic surface is effected by the friction of the rapid water flow. A similar flow may take place through or over baffle plates or gratings composed of aluminium or like metals. The water may be aerated before or after treatment.

As an example of the **second class of anti-incrustators** sodium carbonate may be quoted, this converting the soluble salts into carbonates and preventing any damage due to acids, while the precipitates are so soft and powdery as to be easily blown off by the sludge cock. Other alkalies and alkaline salts are used, among which ammonium chloride may be cited, which decomposes the calcium carbonate, forming soluble calcium chloride, whilst ammonium carbonate volatilises in the steam.

Although acid mixtures have been recommended, it is evident that even in the case of effective removal of boiler scale the plates must be deteriorated.

Boiler compounds are not on the whole regarded as advisable, since these additions at the most, to quote W. H. Fowler ("Handbook of Engineers"), can only convert a hard scale into a soft one, and in no way reduce the amount of material to be removed. They do not prevent, but on the contrary sometimes accelerate, its accumulation in the feed pipes and economiser tubes, where its removal is both expensive and troublesome. A real remedy is to deal with the water before it enters the boiler, and for this purpose a large number of **water-softening plants** are on the market, by which the hardness of the water is brought down to its irreducible minimum, and, in the case of the **permutit** process, almost eliminated, with the result that scale formation almost ceases.

The first essential in water softening is to remove the free carbonic acid gas. This inhibits the action of sodium carbonate when added to precipitate the

¹ A German war vessel's boiler burst owing to the evolution of H from the zinc.

calcium and magnesium salts, by converting it into bicarbonate of soda which has little, if any, action on the above salts. Now carbonic acid can be expelled by boiling, but this costly operation may now be more satisfactorily accomplished by the use of lime. Many designs of apparatus are now on the market involving chemical precipitation, and two of these will now be described.

In **Lassen and Hjert's Water Softener** (Fig. 9) the water to be treated is led through the pipe *K* into one of the chambers of the oscillating receivers. When this chamber is filled it tips over, pouring its contents into the intermediate tank *B* below, at the same time bringing the other chamber of the receiver underneath the orifice of the pipe *K*. On the side of the oscillating receiver is fixed a semicircular tank *D*, containing the chemicals (lime and soda ash or caustic soda), and in the bottom of this tank a valve is fitted, through which the chemicals fall into the chamber *B*. To the receiver is fixed a system of levers which at every oscillation actuates the valve in the bottom of the tank *D*. The lift of the valve can be regulated by two small nuts fixed on the valve spindle, so that a given quantity of chemicals can, by this arrangement, be mixed with the water.

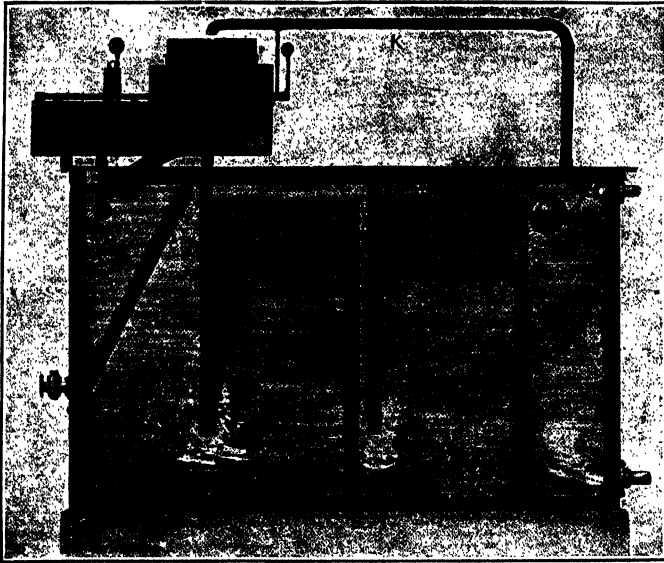


FIG. 9.—Lassen and Hjert's Water Softener.

The lime-milk in this apparatus has a strength of 10 per cent.; the lime-water used in other apparatus has only an average strength of 0.13 per cent.; the lime-milk has therefore a strength of nearly 100 times that of the lime-water, making it possible to reduce the size of the tanks containing the lime in the same proportion. A further advantage of using lime-milk is that a certain quantity of fresh burnt lime is mixed with a certain quantity of water, a solution being obtained the strength of which is always known. In order to keep the lime-milk in constant motion an agitator is fixed inside the semicircular vessel containing the chemicals, and the oscillation of the receiver is utilised for driving the agitator.

The heating chamber *B* is provided with a steam nozzle for either live or exhaust steam. The water is generally heated to a temperature of 150°-200° F. to facilitate the precipitation of the foreign matters. However, where steam is not available, the water can, of course, be treated cold.

From the heating chamber the water passes into the settling tank *A*, where the precipitation takes place. Before leaving the tank the water has to pass through the filters, which are made of wood wool, packed tightly between two rows of wooden bars. The filters can easily be taken out, and cleaned by removing the top bars, and the filtering material can be used over and over again, after having been properly cleansed. Sludge cocks *F* are provided for drawing off the precipitate.

The softened and purified water coming from the filter flows into the storage tank *O* at the end of the softener, and is drawn therefrom. The flow of water to the oscillating receiver is regulated by means of a high pressure float valve fixed on the pipe *K*.

The above description applies to the square type of apparatus, but sometimes a cylindrical type is more advantageous when it is essential that the discharge of soft water should be at a high level.

Lassen and Hjert state that baffle or settling plates in the settling tower are of no use whatever, getting blocked up very quickly, and retarding the softening process.

One of the latest of Reiser's patents of water-softening plant is supplied by Messrs Royles Ltd., of Irlam, near Manchester. In this carbonate of barium takes the place of soda, while the temporary hardness is dealt with by hydrate of lime.

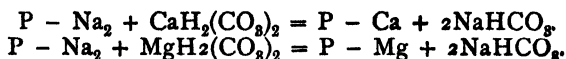
Carbonate of barium has the property of decomposing the sulphates in the water, bringing them down as sulphate of barium which is insoluble, and separated out by the filter. As is well known, the soda process leaves the sulphates in the water principally as sulphate of soda, a soluble salt which goes on concentrating in the boiler, and which requires to be blown off periodically. In boilers of the Lancashire type very little inconvenience arises from this, but in loco and water-tube boilers with little water capacity the rapid concentration of this salt leads to foaming in the boiler, causing priming, *i.e.*, the passage of foam and water through the steam chest with the steam, with its attendant inconvenience and risk of accident and waste of fuel. This type of softener is therefore specially suitable for locomotive and water-tube boilers. As no soda is used, there is no alkalinity from that source, and no wasting of the brass fittings of the boiler due to this concentration. The apparatus is adapted for hot or cold treatment.

The foregoing plants are all eminently suitable for the purpose they serve, but each involves the same fundamental chemical principle of precipitation, and the variations of the system are generally due to differences in the mode of application of the chemicals, and to mechanical devices for facilitating treatment. Of late years an entirely new system has been evolved, based chiefly on the work of Professor Gans, of Berlin, which employs an entirely new principle. The system is of growing popularity, some hundreds of plants being in use, while an installation near Bremen is treating some 3½ million gallons of water per day. This system, known as the permutit process, employs as its active agents bodies known as permutits.

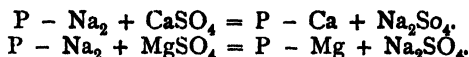
These are all complex silicates containing some proportion of aluminium as a constant constituent. Their manufacture and properties are described in Volume II. of this work.

Gans termed these bodies permutits from the Latin *permutare*, to exchange, to express their extremely important property of exchanging bases. This action is as follows: If a solution containing a calcium salt be poured over sodium permutit, the sodium is displaced by the calcium, forming calcium permutit. Conversely by acting on calcium permutit by a sodium salt in excess, the sodium permutit is re formed, calcium being expelled. This exchange property is utilised for water softening, the lime and magnesia in the water displacing the sodium of the permutit, forming calcium or magnesium permutit, while the sodium passes away in solution. Indicating for convenience "permutit" by P, the exchanges are represented by the following equations:—

For the softening of temporary hardness:—



For the softening of permanent hardness:—



In practice this exchange is absolutely complete, since a hard water emerges perfectly lime and magnesia free, containing no scale-forming, soap-destroying, or other injurious ingredients.

When the permutit ceases to be effective, regeneration is simply and efficiently carried out by passing through the permutit (which now has calcium or magnesium for its base) a weak solution of common salt, *e.g.*:—



Now common salt, as generally employed for the regeneration, is itself slightly contaminated with lime and magnesia, so that to some extent the action of the salt is reduced. For this reason it is advantageous to employ for the regeneration, once every three or four weeks, an extra charge of say twice the normal quantity of salt, and to dissolve the same in softened water. Filtration through permutit is as a rule more effective downwards than in the reverse direction, as there is a tendency to compress together. Agitation before every regeneration is therefore desirable to loosen the mass and remove any air or channels formed in the filter. This takes place upwards, the material being thoroughly loosened by the flushing action of the water. The apparatus usually employed consists of a cylindrical tank containing a bed of sodium permutit between two layers of gravel. The hard water enters above and percolates through, its rate of flow being regulated so that a zero water emerges below. When the specified amount of hard water has passed through, the inlet is closed and the flow reversed for a minute or so whereby the bed is broken up, the



FIG. 10.—Permutit Water-Softening Plant.

formation of channels prevented, and any air in the pores expelled. Thus cleansed the filter is ready for regeneration, for which purpose a cylindrical tank is provided at the top of the apparatus containing the salt solution.

A 10 per cent. salt solution is generally employed for regenerating and is allowed to filter slowly through from eight to ten hours. Thereafter a small quantity of the crude water supply is run through for the purpose of removing the excess salt solution.

Since permutit is active all over its surface, it follows that for the purpose of preventing choking, mechanical impurities such as oil, sludge, iron, or vegetable matter, must be previously filtered before softening. In addition the water must be neutral and if not must be neutralised.

The to-and-fro process of softening and regeneration goes on without any depreciation of the permutit or material wastage. Thus a permutit filter the

charge of which had been in uninterrupted use for about a year and a half, and which during that time had been regenerated several hundred times, delivered a water of neutral reaction and of zero degree of hardness.

The **advantages** of the process are as follows: since common salt is the only reagent used, the objections surrounding lime and soda are eliminated. The treated water has the same alkalinity as on entering, and requires the same amount of acid for acidification after as before treatment. The sludge difficulty is removed as the lime is expelled in the form of calcium chloride, so that no settling tanks or filters are necessary. There is also no adjustment of chemicals for obtaining a



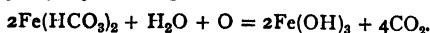
FIG. 11.—Permutit Water-Softening Plant.

uniform water, as it is zero all the time. The amount of attention which a permutit plant calls for is represented solely by the half hour requisite for changing over the operation of the plant from working to regeneration, and in the reverse direction after regeneration is completed; beyond which the plant works automatically and consists of no moving parts whatever. A plant takes up the least possible space and can be designed with either open top—"gravity system"—or closed—"pressure system"—whereby it can be put anywhere in the water supply circuit. The permutit plant is the only pressure system available for water softening.

The Iron Problem.—In underground and well waters, and especially in springs from marshy districts, iron (frequently combined with organic substances) is present in such a condition as to render its separation extremely difficult. Water thus contaminated with iron is not only exceedingly objectionable as a domestic

supply, but in very many industries altogether disastrous, as for example in the dyeing, laundry, paper, and other trades.

The iron usually occurs as ferrous bicarbonate, occasionally as phosphate, and when the water is exposed to air the iron partly separates, *e.g.*—



Schmidt and Bunte distinguish four phases in this separation:—

(1) Oxidation of ferrous to ferric iron, (2) hydrolysis of the salts, (3) transformation of ferric hydroxide to its hydrosol, and (4) change of the latter into hydrogel. The oxidation is promoted by rough surfaces, and by electrolysis.

If such chalybeate water is to serve for drinking or like purposes, it is advisable that it be clarified, having an unappetising appearance and a disagreeable taste. Similarly, when used for manufacturing or industrial purposes, a purification is most essential.

The majority of processes combine in some form or another aeration with subsequent filtration.

In Reiser's type "FO," as supplied by Messrs Royle's & Co., there is a spraying tank A, a coke tower B, and an air-cleansed gravel filter. The water to be freed from iron flows into the spraying tank A, the bottom of which is perforated with fine holes, causing the water to fall in the form of a shower on to the coke. By this means the water and air are well mixed, and the absorbed oxygen commences a separation of iron out of the water. The latter then passes in thin streams or rivulets over the coke, passing from the top to the bottom of the coke tower, where a perfect separation of iron takes place. The necessary air has free access from all sides, those of the coke tower being perforated. The coke becomes in a very short time coated with iron oxide, which accelerates the separating action. After leaving the coke tower, the water passes again in the form of a shower on to the gravel filter. Any precipitated iron remaining in the water is arrested by the filter, and the water leaves by the pipe D perfectly free from iron, and crystal clear. To clean the filter, the mud valve E is opened, and by means of an air-blower F, or out of an air-chamber, air is led under pressure, and simultaneously water, to the underside of the filter. The flush water may be taken from a line of pipes, town's main, etc. The cleansing or flushing of the filter is most energetic, and only lasts a few minutes. The muddy water which collects above the filter flows by the mud pipe to waste. After opening and shutting the corresponding valves, the filter is immediately ready for further use. The frequency of cleansing the filter is naturally dependent on the quantity of iron contained in the water, necessitating accordingly either a daily cleansing or one twice or three times per week. In cleansing the filter it is never necessary to have to handle it, or in any way to touch the filtering material. A pressure type is also supplied, the working of the closed apparatus being essentially the same in principle, except that the air, necessary for the oxidation, is pumped in or drawn in by a snuffle valve in the suction piping.

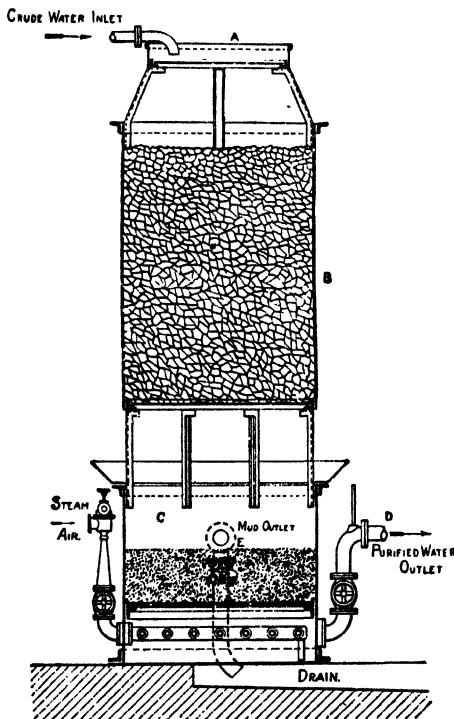


FIG. 12.—Royle's Reiser's Type "FO" Iron-removing Filter.

Chemical precipitation is also used for removal of iron, since if the latter be united with humus matters as in moorland waters, or present as ferrous sulphate as in iron pyrites effluent, only two-thirds of the iron is precipitated by oxygen.

Pfiefke concluded that addition of milk of lime was insufficient, and Kröhnke, by adding some ferric salt prior to lime, obtained more favourable results, as by the decomposition of ferric chloride and calcium hydrate a voluminous flocculent

precipitate of ferric hydrate is formed which settles and carries down not only the iron, but also calcium carbonate, fine turbid material, organic substances, colouring matters, etc. Ozone has also been proposed for this purpose. In America precipitation processes play a large part, while in Europe aeration and filtration are more prevalent.

By means, however, of **permutit**, all difficulty in the removal of iron has been overcome, since by filtration over manganese, permutit waters can be entirely freed from iron or manganese. Incidentally this treatment has another most valuable effect, in that this reaction offers a practical solution to the difficulty of sterilisation of water and elimination of bacteria. In sodium permutit the sodium may be replaced by manganese, and the permutit so formed may be oxidised by dilute potassium permanganate solutions to generate higher oxides of manganese and potassium permutit, the oxides being precipitated in an extremely fine state of division in and on the permutit, so forming a black or brown mass. The latter is a very powerful oxidising agent, which instantly acts upon easily oxidisable matter. When the efficiency is impaired, regeneration is brought about by merely allowing a potassium permanganate solution to act upon it again, a process analogous to the salt regeneration of sodium permutit. When water containing iron flows through manganese permutit, the iron is oxidised by the higher oxides of manganese present, iron oxide being precipitated in the upper layers of the filter bed, the water being made absolutely iron-free. In practice the filters are all of a pressure type with internal stirrers to prevent choking by the iron precipitate; while the regeneration tank contains KMnO_4 .

Waters containing much organic matter and iron, combined with oxy-acids, are particularly hard to treat, and it is usual to add dilute potassium permanganate solution in the form of drops to the crude water. Many such waters are not sufficiently sterilised by simple filtration, since the organic matter consumes the oxidising agents and dissolved oxygen in the water. For sterilisation by permutit, permanganates are added to the water, helping to kill the germs, and producing in the presence of manganese salts colloidal hydroxides which precipitate and coagulate all harmful organic matter. Any excess of permanganate is removed on filtering through the manganese permutit. Water for industrial purposes has to be treated by the foregoing methods to be suitable for the specific object required.

In **laundry work** enormous quantities of water and soap are employed. Dirty clothes usually have the dirt fixed on them by some greasy substance, such as perspiration, which is insoluble in water, and requires the addition of soap for its elimination. Now soap is a stearate of sodium, which, when dissolved in pure water, is resolved into another form containing less soda, and the soda set free by the act of solution operates upon the greasy matter, converting it into a soluble lather, whereby the dirt is rendered removable by rubbing. If, however, the water be hard, insoluble stearates of lime and magnesia are formed, together with sodium sulphate, which possesses no detergent properties. Until all the hardness has been removed, therefore, the soap will be wasted. In addition, if the soap be used for scouring wool for subsequent spinning, weaving, and dyeing, the calcium and magnesium soaps formed are difficult to detach from the fibre, since they form a sticky, greasy curd and may cause defects.

It has been found in actual practice by a firm using water for washing on a commercial scale, that, as a result of softening the water, the saving in soap expenditure was 16 cwt. in every ton. In the spinning and weaving industries the substitution of soft for hard water means the strengthening of the yarn by 15 per cent.

For the **dyeing industry** soft water is a necessity, since the control of a dye bath depends on the character of the substances dissolved. The absence of the alkaline earths, iron, and acids is also important, since by the formation of precipitates, colour changes may be produced and uneven shades obtained. The advantages of soft water are: saving of dye-stuff, penetration, brightness, and above all, evenness.

Water for **paper mills, print, bleach, and glue works**, must be soft and especially free from iron.

In **sugar refining**, sulphates, alkali carbonates, and particularly nitrates actively assist the formation of molasses, and hard water is therefore prohibited.

In all **fermentation industries**, especially breweries and distilleries, perfectly pure, clean, and soft water is required, and above all things there must be an absence of products of decay. The water in addition must contain as few micro-organisms as possible, since these cause subsidiary fermentations which may adversely affect the aroma and taste of the products.

Such water must also be rejected for use in **dairies**, as vessels cleaned with it would retain micro-organisms, and injuriously affect the separation of curd, while **butter** which has been washed with such water soon becomes rancid and bad (see Section on Ultra-Violet Light).

EFFLUENTS, INCLUDING SEWAGE DISPOSAL

Effluents are conveniently classified into those containing a predominant amount of mineral constituents, as distinct from those consisting chiefly of nitrogenous organic matter.

Of the former a fairly comprehensive list is given by Haselhoff,¹ details of which, however, cannot be given in this article. It suffices to say that, owing to the great variety of industrial works, almost every type of chemical compound is represented in the various effluents. For example, in the effluent from coal mines there are present the chlorides of sodium, barium, calcium, strontium, and magnesium, together with ferrous and ferric sulphates and free sulphuric acid, while the effluent from an alkali works contains the sulphides and polysulphides of calcium and sodium, associated with calcium chloride and hydrate.

From these various industries the effluents are usually worked up by special chemical methods, with the object, as a rule, of recovering the different by-products, some of which are of considerable value, *e.g.*, from the gas works effluent the cyanides are used for gold extraction, the tar for benzene, and the ammoniacal liquor constitutes the source for commercial ammonia. The effluent from a bleaching powder is itself of value for disinfecting purposes, the preservation of wood, the purification of illuminating gas, the preparation of colours, and for use in the glass industry, and for copper extraction.

Effluents consisting mainly of nitrogenous organic matter include town sewage, and the effluents from slaughter-houses, sugar and starch factories, breweries, distilleries, dairies, paper mills, wool washing, cloth factories, glue works, tanneries, etc.

The great increase in manufacturing operations, accompanied by the development of the factory system about the middle of the nineteenth century, contributed largely to the very noticeable pollution of streams which began at that time, and still continues. In consequence, special methods have to be employed for allaying this nuisance, and in England the bulk of the effluents are treated together at the sewage purification works.

The greater part of the liquid trade waste at the present time is produced by the textile and dyeing industries, and in certain places special methods have to be adopted by the manufacturers themselves for the purification of the effluent, these methods being naturally designed to suit local conditions, and not for effluent purification in bulk. The latter subject will be treated under sewage disposal.

The various branches of the **textile industries** are concerned with the manufacture of cotton, woollen, and silk goods, but the chief source of pollution arises from the woollen industry, which in all its stages, from the washing of raw wool to the dyeing of the woven fabric, furnishes large volumes of polluting liquids. From a river pollution standpoint, the liquid from the wool washing requires more careful and skilful treatment to yield a satisfactory effluent than any other waste liquid from the textile industries, although compensation is afforded by the fact that valuable by-products can be recovered which causes the treatment to be profitable [see the note on Bradford sewage in the Sewage Section]. This latter fact has caused the purification methods to be designed primarily as recovery processes, while at the same time a purer effluent has resulted.

¹ See Lunge and Keane, "Technical Methods of Chemical Analysis," Vol. I., Part II., p. 807.

The suds from the wool washing as they leave the bowls are highly charged with mineral and organic matters, both in suspension and in solution.

The amount of impurity may be realised when one considers that raw wool on the average contains only about 50 per cent. of wool fibre, the rest being sand, dirt, and grease. The suds, therefore, contain the mineral matter, the excess of scouring agent, and the grease, the latter partly in solution as a potassium or sodium soap from saponification, and partly in suspension or emulsion as unsaponified and unsaponifiable fat. Naturally, the amounts of these will depend on the quality of the wool, the degree of cleanliness required, and the method of washing adopted.

The substances to be recovered are therefore the fatty matters and potash, and the method of purification must have this as its basis. The general conditions to be observed are: (1) The maintenance of a constant effluent which is obtained by using bowls in series; and (2) the removal of heavier solids, such as sand and grit, by means of settling tanks through which the liquid flows with velocity sufficient to help the organic matter in suspension.

Every filtration process has proved a complete failure owing to the grease present, and an investigation by the Massachusetts State Board of Health has shown that intermittent filtration was only possible when the waste liquid was mixed with very large volumes of domestic sewage. When applied directly to sand or coke filters, clogging quickly occurred, while filters for domestic sewage, in a state of active nitrification, were quickly checked.

The first essential step, therefore, is grease removal, and this is brought about by an acid treatment which produces an effluent easily capable of further purification. The liquid, after passing through the settling tank, is collected and then run into the grease recovery or soak tanks, these having a capacity of 6,000-8,000 galls. To the contents of each tank when quite cold, vitriol is added with thorough mixing, until the whole is slightly acid. The fat is thereby "cracked out," and the greater part of the saponifiable fat settles as a sludge or magma to the bottom of the tank, carrying with it most of the unsaponifiable fat, the remainder rising to the surface as a thin scum. The tank contents are then allowed to stand until a complete separation of grease has occurred, when the acid liquor between the two layers is run off by means of an elbow-jointed pipe adjusted at a suitable level. When the latter has been removed as far as possible, the fatty sludge is drained for several days on shallow filters composed of clinkers or ashes about 1 ft. in depth, with a covering of 2 or 3 in. of coarse sawdust, after which it is taken to a grease extraction plant.

The waste liquor is passed through a filter of clinker covered with sawdust for grease retention, and, after a further filtration through clinker, is discharged.

The effluent itself is still polluting, being charged with soluble organic matter, and is purified by treatment with lime to neutralise acidity, followed by ferric sulphate to precipitate organic matter. The cost, however, of this latter process is prohibitive for individual manufacturers, while a disadvantage of the method is the loss of all the potash in the suds.

Precipitation processes other than the acid method have been proposed, but the drawback is the very large amounts of precipitants required for a clear effluent. The best results are obtained with ferric sulphate, although 500-1,000 parts per 100,000 liquid are required. Before the saponifiable fat can be recovered, the voluminous sludge must be acidified, which involves a duplication of the process for grease recovery, as well as the production of a very inferior grease to that afforded by the acid method. The cost of both treatments being practically the same, the deciding factor has been the difficulty of dealing with the voluminous sludge, although the ferric sulphate method often produces an effluent fit for direct discharge, whereas the acid tank effluent necessitates after treatment.

For recovering the considerable amounts of valuable potash, evaporation processes have been devised, and a recent one patented by Messrs Smith & Leach, of Bradford, was in use some years ago, although at present discontinued probably on account of the large initial cost involved. The apparatus consists of a Yaryan evaporator, similar to those used in the sugar and paper industries for the concentration of dilute solutions, a centrifugal separator, and a cylindrical revolving incinerator. The suds, after passage through settling tanks as before, are concentrated to one-tenth or one-fifteenth of their original volume, then heated almost to

the boiling point and passed to the centrifugaliser, where a separation ensues into an outer layer of dirt, a middle aqueous liquor containing the bulk of the wool potash, and an inner layer consisting almost entirely of wool grease. The potash and grease are run off into separate receivers, the former containing 50-70 per cent. of potassium carbonate, the latter about 95 per cent. of wool wax free from mineral and fatty acids, and worth double the grease obtained by the acid method. The distilled water from the evaporation process, although slightly greasy, may be used for wool washing, and a saving of 20-30 per cent. soap effected. The outstanding advantages of the method are no discharge, and recovery of practically the whole of the valuable by-products. But for the expense, the process would be ideal.

Solvent Scouring is another proposal for avoiding a polluting effluent. This process, which involves carbon bisulphide, carbon tetrachloride, or petroleum benzene, is costly owing to volatility and consequent loss of solvent. Success has, however, been attained at Verriers in Belgium, and at Lawrence in Massachusetts, where the wool is treated in an iron vessel with cold petroleum benzene. The grease is dissolved out, and the solvent distilled after several extractions have been made, thereby leaving the grease behind. The wool still contains the potash and dirt, which are washed out with soap, and the wash liquors evaporated for potash recovery. Here again there is no discharge of waste liquor, but the method has not found favour in England, since stains are not removed, whereby scouring is necessitated. The wool also is less suitable for subsequent operations, owing to the too complete removal of the grease.

The purification of **refuse from yarn and piece scouring** is made by the acid treatment, although in this case the grease rises to the surface instead of sinking to the bottom of the soak tank, so that a clear liquid can be tapped off from the bottom of the tank.

The **waste liquors after grease recovery** have still to be purified, and these, together with the effluents from dyeing, scouring with fuller's earth, bleaching, and calico printing, will now be considered. Although they differ appreciably in composition, the method of chemical precipitation, settlement, and filtration is applicable either to each class of refuse separately, or to combinations such as occur in most manufactures. The chemical process is usually the addition of lime, either alone or together with alumino-ferric or ferric sulphate, acids being thereby neutralised, colouring matters fixed, and organic substances coagulated, so that, during settlement, most of the impurities are deposited as a sludge. Before precipitation, however, screening for suspended matter is usually resorted to, as the fibres removable from some varieties of refuse possess considerable value. Lime is added as milk of lime, but only effects partial precipitation of lighter matters, which settle much slower than when alumino-ferric or ferric sulphate are used. The mixing occurs during passage along a channel, and is usually assisted by baffle plates, while the settlement obtains in tanks either by continuous flow or quiescent sedimentation.

The former tanks require less labour and supervision, while the latter can only be used without pumping when there is an available fall of 6 or 8 ft. In the continuous flow method 6 or 8 in. suffice, and any further fall serves for the filtration process.

Filtration is only applied as a final means for removing suspended matter from liquid trade waste, and the beds are generally composed of either clinker, coke, ashes, or sand.

The sludge possesses little or no commercial value, and only one or two attempts have been made to obtain an economical result, *e.g.*, the recovery of indigo from dye waste, and the use of lime sludge as a manure.

The **precipitation process** is the only reliable one for the purification of large volumes of waste, but this usually requires large ground area for successful working.

In consequence a number of more compact systems have been invented, among which may be included the majority of water-softening plants, which remove lime and magnesium salts by precipitation.

The general problem of sewage purification will now receive attention.

Sewage Disposal.—This problem of sewage disposal has been forced on the country owing to the evils of stream pollution, and the general adoption of the water-carriage system. Sewage contains the solid and liquid excreta of the population, together with the waste from all domestic occupations, as well as a large amount of animal and vegetable matter. With the exception of a few towns sewered on a dual system (and such only receives the sanction of the Local Government Board when surface water can be discharged by separate drains without creating a nuisance, and where the combined system would be unduly expensive), sewage also contains the washings of street and storm waters, and, as a rule, complex trade waste.

The main constituents of domestic sewage are :—

- (1) **Matters in solution** (mainly derived from urine), consisting chiefly of nitrogenous substances such as urea, and mineral salts such as sodium chloride and phosphates.
- (2) **Matters in suspension, emulsion, or colloidal solution.** These are nitrogenous bodies of complex character containing sulphur (mainly derived from fæces), cellulose (disintegrated paper), vegetable debris, soap, and fat.
- (3) **Sedimentary matters**, such as silt, clay, and sand.

It is impossible to distinguish sharply as to the amounts of these substances present, *e.g.*, the quantity of soap present will depend on the hardness of the water, while the sedimentary material of class (3) will carry down some or all of the suspended matters in class (2). The above constituents are disseminated in about 20 galls. of water supply per head of population per day.

Since no two cities or even any given sewer possesses the same average sewage composition, for this varies with the hour, the season of the year, and the state of the weather, great difficulties have had to be overcome in devising means and maintaining works for the efficient purification of sewage. Problems in many instances still await solution.

It is possible to transform sewage on the small scale into perfectly harmless products, *viz.*, into the gases methane, hydrogen, nitrogen, carbon dioxide; the soluble salts, such as nitrates, phosphates, sulphates, chlorides, and insoluble residual matters which are conveniently termed "humus," and are generally associated with a fair proportion of mineral matter, especially phosphates, lime, and alumina compounds. This transformation is accomplished by bacterial treatment, which is really direct oxidation through the agency of the requisite organisms in the presence of air.

On the large scale, however, it is difficult to find conditions for dealing with sewage by this dilution method, since a favourably situated outfall must admit of the sewage being quickly mixed with a large excess of water, so that the oxygen content is always sufficient to prevent formation of offensive products. In the majority of cases some form of tank treatment is absolutely necessary.

The first stage on the arrival of the effluent at the outfall works is to remove the coarse suspended matters, for which purpose screens of various designs are used with automatic scrapers, etc. Following this comes the passage through detritus tanks, where the speed of flow is so regulated as to allow of the heavier and mineral matters settling while retaining the lighter mineral and organic suspended matters for subsequent tank treatment. This may have for its object :—

- (a) Removal of remaining suspensions either by quiescent or continuous flow sedimentation (sedimentation tanks).
- (b) Sedimentation with partial digestion of insoluble and soluble organic matters (septic tanks), either by anaerobic or aerobic decomposition.
- (c) Chemical classification (precipitation tanks) in which flocculent precipitates are developed to effect the rapid settlement of suspended matters.

By simple sedimentation only the heavier matters, such as sand, silt, paper, grease, soap, and fæces, will be removed. Now the character of the sewage depends largely on the distance travelled, since mechanical disruption and emulsification of fæcal matter occurs as well as the partial ammoniacal fermentation of the urine. When the sewers are of recent construction, only the initial stages of the latter will have commenced, and the sewage in consequence will be comparatively in-offensive. Sedimentation tanks, therefore, should have such a capacity as to cope with the sewage in these initial stages, while the sludge deposited should for the same reason be quickly disposed of, *e.g.*, by trenching in the ground.

A septic tank, which has also been termed a cesspool, and a liquefying or hydrolytic tank, is designed to facilitate decomposition and removal of solid

matters, and for the control of the character and extent of the chemical changes. In this tank the cellulose is transformed into hydrogen and marsh-gas, with carbon dioxide and fatty acids as by-products. This production of gas is a visible sign of sewage fermentation, and arises chiefly from cellulose decomposition.

Omelianski's researches have shown 90° F. to be the best temperature, and in consequence the activity is more pronounced in summer than winter, while it is extremely intense in tropical countries, so that an economic use can be made of the gas. Fowler is of opinion that in the case of small premises where much cellulose matter accumulates, *e.g.*, packing paper, extracted plants from drug manufacturers, waste hops from breweries, etc., it might not be uneconomical to produce gas in small tanks maintained at the optimum temperature by waste steam.

Ammoniacal fermentation readily begins, and may be almost complete, before reaching the purification works, since the bulk of the sewage nitrogen is present as urea. For nitrification the preliminary conversion of urea, amino-acids, and similar bodies into ammonia must take place, and Fowler has found beyond question that, if absolutely fresh sewage is to be put upon a filter, considerably more filter space is requisite to convert the nitrogen into nitrates, than if time is first allowed, *e.g.*, by retention in tanks for ammoniacal fermentation to take place. This fermentation nearly completes itself in the sewers, and it is doubtful if urea could ever be found in an ordinary sample of town sewage. The other nitrogenous constituents, such as the various decomposition products of albumin, the bulk of the fæces, etc., are all gradually broken down, but this decomposition should not go too far, since evil-smelling substances, such as sulphuretted hydrogen, indol, skatol, etc., are produced. The tanks should therefore be constructed for rapid deposition of solid matter, and its retention within economic limits for decomposition purposes, while the fluid portion should be quickly removed. Fats are also split up in these anaerobic tanks, which latter were at one time closed, although this has now been found unnecessary, since immediately beneath the surface of the sewage, anaerobic conditions must prevail.

About 1904, **Mr Dibdin** treated crude sewage on a coarse contact bed, which took the form of a tank filled with a structure of plates and blocks. The solid matters in the sewage are allowed to settle on shelves of slate, supported by slate blocks at a distance of about 2 in., these being superposed to a depth of 1.5 or 6 ft. as required. In consequence of the alternate filling and emptying, and resting empty for the air, which takes the place of the liquid to oxidise the deposited organic matter, the deposit becomes the home of many types of organisms that digest the matters, and render them inoffensive in like manner to the action by which earth-worms produce a humus from organic debris, and throw it to the surface in the form of worm-casts. In the slate bed the deposit of earthy matter thus formed on the surface of the layer of mud on the slates is washed off by the receding effluent when the bed is emptied, and forms a black slurry, consisting of mineral and indigestible matter with numerous organisms from the bed. This slurry is then placed on a suitable drainage bed for the water to drain off, and to allow time for the full digestion of any crude material that may have come from the bed; and finally, to allow the host of infusoria to extinguish themselves by the natural process of the "survival of the fittest." Fowler terms such a system an **aerobic tank**, the changes being essentially different from those under the above anaerobic conditions. Excess of air is essential to success, otherwise anaerobic conditions may be set up with consequent putrefaction.

The septic tank treatment has not realised expectations, since it was claimed to have solved the sewage difficulty by causing practically all the organic solid matter to be digested in the tank. Experience, however, has not confirmed this, the amount of solids digested being a varying small percentage depending on the character of the sewage, size of tanks relative to volume treated, frequency of cleansing, etc. Another claim put forward was that the sewage after septic tank treatment was capable of easier oxidation, with or without the aid of chemicals, but this has not been substantiated by experience. The suspended matters are not effectively removed, since the tank liquor contains on an average from 10-15 gr. per gallon, thus materially affecting the state of the filters employed for the final purification. Sewage ought not to remain more than twenty-four or less than twelve hours in a septic tank, and the longer the latter goes without cleansing, the more serious will be the state of the tank effluent. The main advantage of a septic

tank is in its equalisation of the sewage as regards strength and uniformity. The Royal Commission are of opinion that in certain circumstances the adoption of a septic tank treatment as a preliminary process is efficient and economical.

To promote fermentation of the organic solids in the sludge deposited, the liquid is removed with the least possible disturbance of the latter, which is then subjected to septic treatment in a special tank for the purpose.

Such tanks have been devised by Travis (the **hydrolytic tank**), and by Truhoff (the **Essen tank**). The latter has a cylindrical form with conical base; the upper portion is a sedimentation chamber with sloping floors and slots at the base for allowing the sludge to settle into the section below. The claim is made that the sludge when withdrawn is non-putrefactive, and that a large percentage of organic solid matter has been destroyed ("Surveyor and Municipal and County Engineer," 1909, p. 625).

In dealing with chemical clarification, the remark must be made at the outset that no amount of chemicals which can with any show of reason be added to sewage is sufficient to convert the whole or even the greater part of the putrescible matter into harmless forms. There are also definite limits to the economic use of chemicals, for beyond a certain point an increase in the amount used does not occasion a proportionate reduction in the amount of suspended matter.

In the case of very dilute sewages, the colloidal matter therein, being disseminated through a large volume of water, requires enormous amounts of chemicals for precipitation, the cost being out of all proportion to the purification obtained. The net result of chemical clarification is to bring the effluent into a condition more suitable for filtration, which latter process in some form or other is acknowledged on all sides to be essential to any efficient system of sewage purification. Speaking generally therefore, the use of chemical clarification is advisable when the sewage is concentrated, the available filtration area limited, and the sludge easily disposed of.

The principle involved in chemical clarification is that colloidal substances of albuminous nature may be coagulated and precipitated by addition of hydrated precipitates such as those of iron and aluminium hydroxides. The chief precipitants used are aluminium sulphate, ferric sulphate, and lime, in conjunction with ferrous sulphate (green copperas); the choice depends largely on current market price and on facilities available for efficient use. Ferric salts have been found especially useful where the sewages contain much grease, *e.g.*, at Wakefield.

One of the chief difficulties encountered is the considerable quantities of sludge to be disposed of, since this is capable of undergoing offensive decomposition.

THE FINAL PURIFICATION OF SEWAGE

The aim of all methods of purification is to remove suspended matters and to convert the carbon and nitrogen of the remaining organic matter into inorganic. Accordingly the River Pollution Commission of 1868 advocated filtration through land, and the conditions then laid down hold at the present time.

In any filtration process, whether through sand, gravel, chalk, solid, or mixtures of these, an absolute essential is **free access of air to the interior of the filter**, while the effluent should so flow through the filter that atmospheric air is drawn through the pores of the material from the surface downwards. In 1868 the action was regarded as mechanical and chemical, and maintenance of the oxidising powers of the filtering medium depended upon absence of choking. Later investigations have shown, however, that purification ensues through the agency of living organisms, as the sewage furnishes abundant organic food for bacteria. Now standing sewage is capable of change in two directions, *viz.*, in the presence of oxygen, when inoffensive products are formed, and in its absence when the contrary obtains. Any rational system is, therefore, based on these changes.

Under special conditions crude sewage may be treated directly on filter beds after screening to remove coarse suspension, especially when the sewage is dilute and a considerable fall available. Such beds are usually coarse percolating filters of sand, each having about 1 acre of superficial area, a depth of 4-5 ft. and being levelled, undermined, and separated from the others.

None of the beds should receive the sewage for a longer period than six hours out of the twenty-four, for no air would be present with a continuous flow. By such a process from 50,000-75,000 galls. of domestic sewage may be purified per diem per acre of sand-bed area (when there is not a large proportion of manufacturing waste present). The resulting effluent in the majority of cases may be discharged into the streams.

Sewage is applied to land after screening and sedimentation by two processes known as **intermittent downward filtration** and **broad irrigation**. In the former, the land functions like an ordinary sand filter and therefore must be open, porous, and have a sandy subsoil. When the land is of a retentive character with a clay subsoil, the latter process is suitable, the sewage being run over the surface and the purification effected by nitrifying organisms in the surface soil.

This process is generally associated more or less with the former when the irrigation areas are undermined, to allow the land to dry off with sufficient rapidity. On a good land with sewage of average strength and eliminated of its suspended matter by previous treatment, 30,000 galls. per acre per day may be treated, although with less suitable land the amount can drop to 3,000 galls. per acre.

The Local Government Board requires that sewage, after previous sedimentation, when applied to suitable land by broad irrigation, should not exceed 4,500 galls. of dry weather flow per acre per day (*i.e.*, the sewage from 150 persons). Surplus land (25-50 per cent.) must also be provided for resting purposes. With downward filtration 15,000 galls. is the limit for the most suitable land, and 25 per cent. surplus is usually required.

After chemical precipitation, however, the effluent may have a maximum application of 30,000 galls. per acre per day.

In almost all cases it will be necessary and certainly preferable to adopt some form of preliminary treatment before final purification on filter beds. The artificial filters in general use are of two types which are broadly divided, according as the sewage is applied intermittently or continuously, into: (a) Contact beds; (b) percolating or trickling filters.

(a) **Contact Bed Treatment.**—This method is the result of Dibdin's experiments on London sewage. The general character of the bed was described earlier when aerobic decomposition was dealt with, although the tank in this case is filled with coarse material such as cinders, clinker or coke, carefully screened and graded to a definite size. The material must be durable and expose the maximum of surface, conditions excellently satisfied by clinker. When a first contact does not furnish a satisfactory effluent, the latter is passed to another bed at a lower level where the filtering material is of smaller dimensions, while if a third contact is necessary sand may be used.

The complex physical, chemical, and bacteriological changes which take place have been previously discussed. The colloidal slimy layer deposited on the surface of the filter, which is the seat of biological activity, must be regulated by a cycle of operations involving a resting period, while a bed should not be filled more than three times in twenty-four hours, arranged in periods of eight so that the maximum drainage and aeration are obtained. The depth of the contact beds should not exceed 6 ft. or be less than 2½ ft., while over the drains material of fairly large size should be laid to preserve the life of the bed as long as possible. In practice the filtering material must be washed when clogged. The working of the bed can be controlled by the amount of nitrate present in the effluent, especially in the first discharge after a long rest, since the nitrates represent the overplus after denitrification, and point to aerobic conditions suited to the maintenance of organic life. When the beds are clogged crowds of worms often appear, demonstrating the lack of air supply.

(b) **Trickling or Percolating Filters.**—In these beds the sewage is not static as in the contact filter, but flows over the fragments of the filtering medium, so that oxidation is continuously proceeding. The filtering material must expose the maximum of surface, and therefore must be as small as the maintenance of free air circulation will allow.

The most suitable substance is hard furnace clinker, which, being of a rough irregular character, exerts little or no retentivity for the gelatinous matter deposited on it. The bed should be of concrete, and upon it a tapered tiled floor is constructed with air and drainage spaces between the tiles, since aeration of the base of the bed with effective drainage is essential for a fully oxidised effluent. The external walls are usually of honeycombed brickwork for side ventilation, and the effluent is sprinkled upon the filter bed by an ordinary rotary distributor, the operation being discontinuous, as each element of surface receives a dose of liquid at given intervals depending on the speed of rotation.

The effluent from percolating beds contains suspended matters which are removed by secondary sedimentation, and these beds must always be equipped

for arresting suspended matter, which, after a period of rest, is rendered granular and readily detachable from the filter. These beds differ from contact ones primarily in the predominance of nitrification owing to the constant presence of oxygen in its interstices. Consequently the effluent from these filters contains a greater reserve of oxygen available for further purification in the stream into which the effluent may flow.

On the other hand, there is a greater tendency for incompletely oxidised nitrogenous matters to escape from them, either in solution, in the colloidal state, as granular residual "humus," or as debris of growths formed in the filter. In the contact bed this is obviated by the interaction between the nitrates and the undecomposed oxidisable matter. The rate of filtration may generally be almost double that permissible in contact beds.

LOCAL GOVERNMENT BOARD REQUIREMENTS

Based upon recommendations in the Fifth Report of the Royal Commission on Sewage Disposal, the Local Government Board have issued a set of revised and supplementary requirements with respect to sewage purification schemes, from which the following abstracts are made. For further information see Appendix III., Vol. II., of "Sanitary Engineering," by Moore and Silcock.

For domestic purposes the quantity of sewage to be treated is estimated at l^t 30 galls. per day for dry weather flow, to which trade refuse, if any, must be added, and the total amount of sewage and rain water to be fully treated at the works is three times domestic sewage + $1\frac{1}{4}$ trade refuse.

Storm overflows should be avoided where practicable, but when otherwise they should be so situated as to avoid possible nuisance. In any district possessing an active river authority, the Board will desire to be informed of the opinion of such authority with respect to any proposed overflows, and the weirs, in the absence of any special circumstances, should be fixed so as not to operate until the flow exceeds six times that of average dry weather. There should be no overflow for untreated sewage or storm water at or near the disposal works.

All liquid delivered at the disposal works should first pass through a screening chamber, and a weir set at three times the dry weather flow should be placed below the screens, and any volume passing over should be dealt with in storm tanks. The tanks should be of such a number that their total capacity is not less than a quarter of the dry weather flow, and so arranged that when full they will act as "continuous flow" tanks. The liquor from the tanks can be discharged without further treatment except in special cases, and the sludge may be dealt with by any of the usual methods suitable for the particular circumstances. In cases where suitable land is available, detritus tanks followed by irrigation may substitute the storm tanks.

Sewage Treatment.—There should be two or more detritus tanks below the screening chamber of capacity about $\frac{1}{3}$ of the dry weather flow. The septic tanks should not be less than two in number, and have a total capacity somewhere in the vicinity of the dry weather flow.

There should not be less than eight tanks for quiescent treatment by chemical precipitation, each of which should have a capacity of about two hours' dry weather flow, while for continuous flow not less than two tanks with a total capacity of at least eight hours' dry weather flow. In most cases a greater number of tanks is desirable.

Settling tanks for quiescent treatment should be the same as in chemical precipitation, while for continuous flow not less than two tanks with ten to fifteen hours' dry weather flow capacity are required.

In determining the size of percolating filters and contact beds, the Board have adopted the divisions into "strong," "average," and "weak" sewages recommended by the Royal Commission, to allow for the strength of the sewage to be treated. The strength of sewage should be ascertained when possible by analysis, average samples of crude sewage being taken in dry weather at frequent and regular intervals throughout seven days, and in proportion to the flow. Possibly in the case of small works, the period for taking samples for analysis may be somewhat shorter, and not less than forty-eight hours, Saturday and Sunday being excepted.

In every case the daily rainfall during the period when the samples were being taken should be noted, and also ascertained for the seven preceding days.

The analyses should in all cases include the following items in parts per 100,000:—

Ammoniacal nitrogen, albuminoid nitrogen, total nitrogen, oxygen absorbed from strong potassium permanganate in three minutes, at 80° F. (3.94 gm. KMnO₄ per litre), the previous absorption being for four hours, suspended solids, soluble solids, and chlorine.

It is also desirable that the amount of dissolved oxygen taken up during the oxidation of the ammoniacal and organic matters of the sewage should be given.

The results of analyses require proper interpretation, but as a rough guide the

strength of the sewage from the figure for oxygen absorbed at 80° F. during four hours may be classified as follows:—

“ Strong ” sewage,	17-25	parts per 100,000.
“ Average ”, „	10-12	„ „
“ Weak ” „	7-8	„ „

In cases where the sewage cannot be analysed its strength should be estimated according to the water consumption, flow per head, type of sewerage system, whether water-closets are in general use, volume and nature of trade waste, amount of dilution by subsoil or surface water, etc. Failing satisfactory evidence to the contrary, it will be desirable to assume that the sewage is “strong” for estimating the requisite capacity of the disposal works.

Effluent tanks or filters (with a capacity of about two hours’ dry weather flow and provision for sludge removal), or shallow straining filters, will in most cases be necessary for preventing suspended matters passing into the river, where the effluent is not irrigated on land.

Sludge Disposal.—This constitutes the “Sewage Problem” of large inland towns. In the case of small works land drying or lagooning is resorted to in places remote from habitations. The dry sludge is sold to farmers, or dug into the soil.

Trenching in the ground is preferable for works of medium size, while for large works with limited land area a preliminary treatment of the sludge by filter pressing is desirable before disposal to farmers, or on to land, or burning with town refuse.

The interesting cases of Salford, Oldham, and Bradford will now be quoted.

At **Salford** the application of chemicals is favoured by the condition of the works, since the area available is restricted owing to the site of the works, while the sludge is sent to sea in a steamer, so that, standing charges having always to be maintained, an increase in sludge production does not necessarily mean a proportionate increase in cost.

At **Oldham**, Grossmann (see English Patent, 16,397, 1908) has in course of erection a plant to receive grease and manufacture a manure from the sewage. The sludge is successively dried by mechanical means and by heat, mixed with sulphuric acid, and subjected to non-destructive distillation by means of superheated steam whereby all the fatty matter is carried over and condensed in cold water. The retort residue, which contains nitrogen, potash, phosphates, and organic matter, may be used as soil or manure, being sometimes mixed with nitrates, potash, and ammonia salts, lime or lime compounds, or phosphates. Phosphoric acid, superphosphates, or acid sulphate of lime or of an alkali may be used instead of sulphuric acid, and, if precipitants have been used for the preliminary treatment of the sewage, or if the sludge has been mixed with lime, basic slag, or the like to facilitate filter-pressing, a larger quantity of acid will be necessary.

At **Bradford** the sewage contains an enormous quantity of wool-scouring effluent, and the recovery of grease has been embarked upon to such an extent that the return from its sale exceeds the working expenses of the tank treatment.

The sewage, after screening, is treated with sulphuric acid so that there is an excess of 10 parts H_2SO_4 per 100,000. The acid sewage then passes through settling tanks, the sludge being conveyed to cast-iron vats, where a further quantity of sulphuric acid is added, and the temperature raised by steam to 100° C. It is then run into steel rams and, by means of compressed air, forced into steam-heated filter presses, where the process of pressing lasts from twelve to twenty-four hours, hot sludge and steam being alternately admitted to the press. The pressed liquid, consisting of water and fat, is run into special vessels for the separation of the fat, after which the fat is boiled with acid and black oxide of manganese to render it marketable.

The amount of wet sludge produced per annum is about 100,000 tons, and contains approximately 80.15 per cent. water and 7.43 per cent. grease, equivalent to 37.7 per cent. grease on the dry matter. The amount of pressed cake produced annually is about 20,000 tons, containing about 27 per cent. water, and part of this is used for fuel in specially constructed furnaces. The fuel value is about 1s. 6d. per ton. Another portion is sold to farmers at 3s. 6d. per ton, while some is

disintegrated, and fetches 5s. 6d. per ton as manure. The dried disintegrated cake realises 6s. 3d. per ton (see "Thorpe's Dictionary of Applied Chemistry," Vol. IV., article on Sewage).

The Royal Commission (Eighth Report) recommend a normal standard for all sewage discharge into non-tidal waters, except where local circumstances justify a special one. A normal standard effluent should not contain more than three parts per 100,000 of suspended matter, and excluding suspensions, *i.e.*, after filtration, it should not absorb at 65° F. more than:—

(a) 0.5 part by weight per 100,000 of dissolved or atmospheric oxygen in twenty-four hours.

(b) 1.0 part by weight per 100,000 of dissolved or atmospheric oxygen in forty-eight hours.

(c) 1.5 parts by weight per 100,000 of dissolved or atmospheric oxygen in five days.

Although these tests are open to some criticism, they do broadly serve to determine whether an effluent is likely to give rise to a nuisance or not.

A claim for a relaxed standard may be entertained under the following conditions:—

(a) When it can be shown that the particular rain water is of such a quality and volume that, when mixed with a sewage or sewage liquor of known or calculated strength and volume, it does not take up more than 0.4 part per 100,000 of dissolved oxygen in five days.

(b) When there is reason to suppose, or when it can be shown, that the river will receive no further pollution, until it has recovered so far as not to take up in five days an amount of dissolved oxygen much in excess of that which it took up before receiving the first discharge.

The following limiting quantities for various harmful substances were obtained by Haselhoff as the result of direct experiments at Munster, upon carp, tench, and gold-fish (see "Landw. Jahrbuch," 1897, 26, 76; 1901, 30, 583; also see Lunge and Keane, "Technical Methods of Chemical Analysis," Vol. I., Part II., p. 836). The figures always refer to 1 litre of water, and indicate the point at which the fish became ill or died.

1. Oxygen content. Unharmful at 2.8 c.c., *i.e.*, about one-third of the oxygen usually present in flowing water. The effect of a deficiency of oxygen in putrefying water is associated with other changes including the formation of substances 2 to 5, which may be injurious.

2. H_2S : 8-12 mg.

3. Free CO_2 : 190-200 mg.

4. Free NH_3 : 17 mg. for small, 30 mg. for large fish.

5. $(NH_4)_2CO_3 + 2NH_4H.CO_3$: 170-180 mg. = 36-38 mg. ammonia.

6. NH_4Cl : 0.7-1.0 gr.

7. $(NH_4)_2SO_4$: 0.7-1.0 gr.

8. $NaCl$: 15 gr.

9. Na_2CO_3 : 5 gr.

10. $CaCl_2$: 8 gr.

11. $MgCl_2$: 7-8 gr.

12. $SrCl_2$: 145-172 mg. which can be raised to 181-235 mg. if added gradually to the water.

13. $BaCl_2$: In individual cases 20.3 mg. acted injuriously, while in others 64.3-500 mg. produced no effect; fish seem to be very variously affected by $BaCl_2$, and to be able to accustom themselves to it to a certain degree.

14. Na_2SO_4 : 31 mg. $Na_2O = 110$ mg. Na_2SO_4 .

15. $CaSO_4$: 8 mg.

16. Fe' and Fe'' sulphates: Injurious action varies with the amount of flocculent ferric hydrate which separates; experiments showed an injurious effect with 40-50 mg. of $FeSO_4$, but found 15-30 mg. of ferric sulphate deleterious.

17. Free lime: 23 mg.

18. Free H_2SO_4 : 35-50 mg. SO_3 .

19. H_2SO_3 : 20-30 mg.

20. Free HCl : 50 mg.

21. $K_2Al_2(SO_4)_4$ 24 H_2O : 300 mg.

22. $K_2Cr_2(SO_4)_4$ 24 H_2O : 230 mg.

In examining the contamination of a stream due to effluents from a works or factory, the sample must be collected at a point where a possible injurious effect is suspected, as otherwise, in consequence of self-purification, the water may subsequently lose its specific deleterious character. The use for which the water is destined must be taken into account since a water injurious for one purpose may be quite harmless for another.

ANALYTICAL METHODS

For making the ordinary physical, chemical, and microscopical analyses of water or sewage the minimum quantity necessary is 2 litres, and for a bacteriological examination, 2 oz.

The collecting vessels must in every case be thoroughly rinsed with the water before being finally filled, while the stoppers should be of glass, pottery jugs or metal containers being excluded. The following intervals allowable between collection and analysis are fairly reasonable maximum limits, although, generally speaking, the shorter the time elapsing the more reliable the results.

Ground waters -	-	-	-	72 hrs.
Fairly pure surface waters	-	-	-	48 "
Polluted surface waters	-	-	-	12 "
Sewage effluents	-	-	-	6 "
Raw sewages	-	-	-	6 "

If sterilised by the addition of chloroform, formaldehyde, mercuric chloride or other germicide, samples for chemical examination may be retained longer, but this will vary according to local circumstances. Should unsterilised samples of sewage or highly polluted surface waters be not analysed on the day of their collection, the organic contents are liable to material change on standing. In the case of sewage, representative samples must be taken.

Some minor physical properties are temperature, turbidity, which is determined against a silica standard by a platinum wire method; colour, which is measured against a standard solution of potassium platinic chloride and cobalt chloride; and odour, which is valuable for detecting organic growths or sewage contamination.

The results of chemical analysis are preferably stated in parts per 100,000, although grains per gallon is still a common method of expression. These may be interconverted as follows :—

$$1 \text{ grain per gall.} = 1.43 \text{ parts per } 100,000.$$

$$1 \text{ part per } 100,000 = 0.70 \text{ grain per gall.}$$

For Drinking Water the following factors are usually estimated :—

Oxygen consumption value.	Hardness, temporary and permanent.
Nitrogen as nitrates and nitrites.	Appearance, colour, and taste.
Free and albuminoid ammonia.	Bacteria per cubic centimetre.
Total solids.	Presence of poisonous metals.
Suspended matter.	

For Technical Purposes the following serve :—

Total solids.	Lime factor.
Temporary and permanent hardness.	Tests for magnesium, sulphates, and chlorides.
Acidity or alkalinity.	

For Sewage and Effluents :—

Total oxygen consumption value from acid permanganate in 4 hours and in 3 mins.	Chlorine.
Nitrogen as ammoniacal, albuminoid, nitrous, and nitric.	Suspended matter.
	Putrescibility.
	Consumption of dissolved oxygen.

The **Total Nitrogen** is determined by the Kjeldahl process (*i.e.*, heating with concentrated sulphuric acid whereby the nitrogen is completely converted into ammonia).

The **Free Ammonia**, which is an intermediate stage in the decomposition of organic matter, may be determined either by distillation (for most waters) and Nesslerisation, or direct Nesslerisation (for sewages, etc.). Ammonium chloride was almost the only standard formerly used, but now the permanent platinum-cobalt standard is coming into more general use.

The distillation process is now being performed by steam, which has the advantage of yielding ammonia more promptly, avoids pumping, and permits the assay of solid matter.

Albuminoid ammonia is estimated by a distillation with alkaline potassium permanganate, whereby nitrogenous organic matter is converted into ammonia, which is then determined by Nesslerisation.

In sewages and other liquids containing considerable quantities of nitrogenous organic matter, the percentage which is ammonia forming is decidedly variable. For this reason the albuminoid ammonia results are less valuable than the total organic nitrogen. For ground and surface waters containing but little pollution, the albuminoid nitrogen quite uniformly approximates to about half the total organic nitrogen.

The **Proteid Ammonia** determination and its significance has been dealt with earlier.

Nitrites, which represent the second stage in the transition to nitrates, are determined against standard nitrate solutions by adding 2 c.c. each of standard sulphanilic acid and α -naphthylamine solutions in acetic acid, to 100 c.c. of the sample decolorised by aluminium hydrate. Acetic acid permits of the colour developing more slowly than hydrochloric acid.

Nitrates.—No single method appears to be applicable to all classes of water, each being subject to considerable error. When the amount of chlorine is less than three parts per 100,000 the phenolsulphonic acid process is recommended, and when exceeding this, as in sewage work, the reduction method is preferable.

Oxygen Consumption Value.—This is the amount of oxygen consumed from an acid solution of potassium permanganate. The expression is synonymous with the "oxygen required or absorbed." Since it is carbon and not nitrogen which is attached, the determination is frequently referred to as an indication of the carbonaceous organic matter present, although the carbon in the nitrogenous matter is as readily oxidised. The carbon present in unstable organic matter is not directly differentiated from that in stable, e.g., residual humus, matter. Nitrates, ferrous iron, sulphides, etc., if present, will increase the consumption, to which a necessary correction should be applied. Unfortunately so many forms of procedure have been proposed (for which analytical books must be consulted) that the most favourable basis has not been established. The following conclusions are taken from the Report of the American Committee.

From a strictly scientific standpoint the thirty-minute period of digestion at boiling temperature in a water bath appears to give the most satisfactory results as regards uniformity and freedom from personal errors of manipulation. In connection with sewage works analysis, to which the usefulness of this method is principally confined, it is recommended that the permanganate solution be added to the sample before heating in order to include the oxygen consumed by volatile compounds.

Total Residue or Total Solids is determined by evaporation.

Hardness and Alkalinity.—Total hardness is commonly measured by the soap-destroying power.

Temporary Hardness or alkalinity is obtained by direct titration with $N/10$ H_2SO_4 and methyl orange.

Permanent Hardness is determined by placing 140 c.c. of H_2O , say, in a flask with 10 c.c. $N/10$ Na_2CO_3 . The whole is evaporated to dryness on a sand bath, and heated for a short time to convert the $MgCO_3$ into MgO . The residue is then taken up several times with small quantities (3-4 c.c.) of cold water, and the extracts filtered through a small filter, afterwards being titrated with $N/10$ H_2SO_4 , using methyl orange as indicated.

Acidity, due to free carbonic acid, free sulphuric acid, and sulphates of iron and aluminium, is determined by titration in the cold with standard Na_2CO_3 and phenolphthalein.

Lime Factor.—This is the number of grains of CaO which will react with 1 gall. of water. The lime is added to remove temporary hardness, carbon dioxide, convert magnesium salts to the hydrate, and precipitate iron. The water is shaken up with excess lime-water for some time, filtered, and the excess lime determined by titration.

Chlorine.—This has its origin in water and sewage, for the most part in the common salt either from mineral deposits or from household and manufacturing waste. Comparison of the chlorine content of a water with that of other waters in the general vicinity known to be unpolluted, frequently gives useful information as to its sanitary quality.

The determination is usually made by silver nitrate against standard salt solutions, using potassium chromate as indicator.

Iron, Manganese, Lead, Zinc, Copper, and Tin.—For analytical methods and modes of separation, analytical text-books should be consulted.

The **Dissolved Oxygen** is usually determined by the methods of Winkler, Thresh and Levy.

Winkler's method depends on the fact that manganous hydroxide is converted by oxygen, in presence of alkali, into manganic hydroxide, which reacts with hydrochloric acid to form manganic chloride; this decomposes immediately into manganous chloride and chlorine, liberating iodine from a standard potassium iodide solution which is then titrated with sodium thiosulphate solution.

Putrescibility is determined by the decolorisation of methylene blue, the relative stability corresponding to the time required for reduction. Those that are blue at the end of four days may be given a relative stability value of 95, except when great accuracy is desired.

In general, effluents having a relative stability greater than 90 may be discharged into any stream without danger of their consuming any of the dissolved oxygen of the water, because effluents of such high stability will retain oxygen indefinitely on exposure to the air.

For details of analytical methods the student is recommended to consult "Standard Methods for the Examination of Water and Sewage," by the American Public Health Association, and Vol. I., Part II. of "Technical Methods of Chemical Analysis," by Lunge and Keane.

SECTION XVII

ARTIFICIAL MINERAL WATERS

BY C. AINSWORTH MITCHELL, F.I.C., B.A.

LITERATURE

- B. HIRSCH** and **P. SIEDLER**.—"Die Fabrikation des Künstlichen Mineralwasser," Brunswick, 1897.
- HERMANN-LA-CHAPELLE**.—"Des Boissons Gazeuses." Paris, 1874.
- W. KIRKBY**.—"The Evolution of Artificial Mineral Waters." Manchester, 1902.
- C. A. MITCHELL**.—"Aerated and Mineral Waters." "Thorpe's Dictionary of Chemistry," 1911.
- "Mineral and Aerated Waters." London, 1913.
- SULZ, C. H.**—"A Treatise on Beverages." New York, 1888.

AERATED WATERS

Machinery.—In the earliest apparatus for saturating water with carbon dioxide, the gas was generated in a small vessel from sulphuric acid and chalk, and was forced, mainly by its own pressure, into a jar or barrel containing the water.

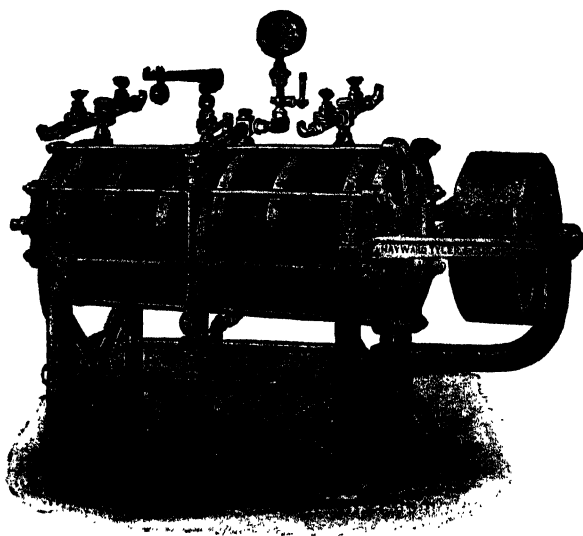


FIG. 1.—Carbonating Cylinder (Geneva Process).

In Paul's factory, in Geneva, in 1790, a pump was used to force the gas into a cylinder containing the salt solution, and this system of carbonating, which became known as the "**Geneva Process**," is still used to a small extent in

modern mineral water factories, chiefly in cases where a small amount of liquid is to be carbonated. The same system is also used in breweries for the carbonation of light beers, the cylinder being usually made of gun-metal. For most purposes, however, the **Geneva process** has been superseded by the **continuous process** which is based upon an invention of Hamilton (English Patent, 3,819 of 1814), the principle of which was soon after adopted by Bramah. Various modifications of Bramah's machine have been devised, but the essential features of the original machinery have been retained.

The gas carbon dioxide coming from a gasometer or a generator is pumped by means of a force pump with a solid plunger into a cylinder, where it meets with a supply of water, which it saturates at the required pressure. Thence the impregnated water is conveyed to a bottling machine in which a regulated amount of soda solution or syrup is introduced into the bottles, and the filling completed with the saturated water.

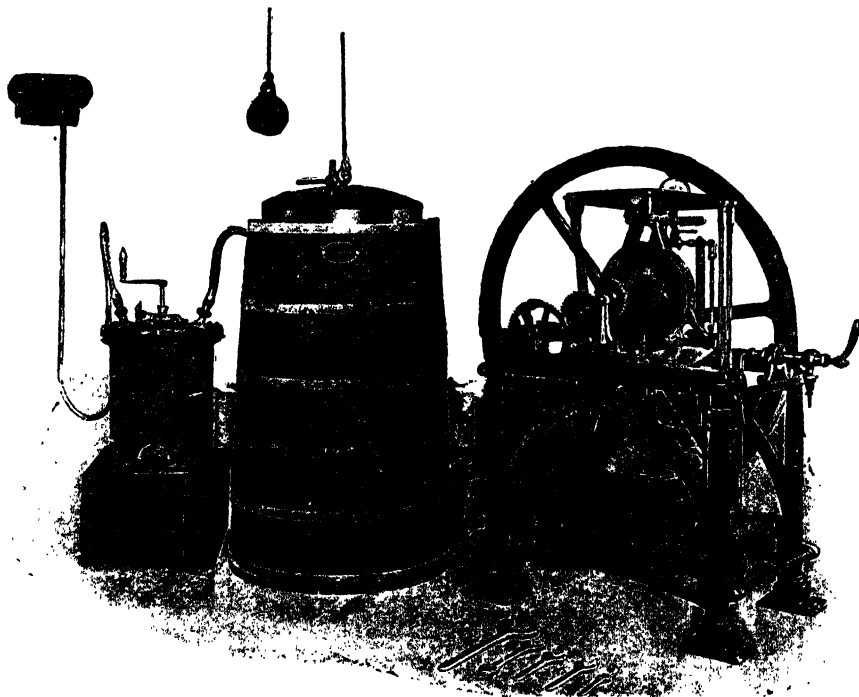


FIG. 2.—Hayward Tyler's Continuous Process Machine.

The Gas Supply.—The carbon dioxide for saturating the water is produced in a generator by the action of sulphuric acid or hydrochloric acid upon chalk or sodium bicarbonate, or as is now the more usual practice, tubes of **liquefied gas** are connected with the gasometer which feeds the soda-water pump.

The liquefied gas is sometimes derived from brewery fermenting tuns, but is more frequently obtained from the products of the combustion of coke or charcoal (see p. 141, section on Carbon Dioxide). Natural carbon dioxide is also used in places where it is available, and several of the sparkling mineral waters upon the market have been impregnated with the gas which issues at the same time as the water from the rock.

The Pressure of Saturation.—In the mineral water factories a pressure of upwards of 200 lbs. to the square inch is frequently recorded upon the indicators of the soda-water machines, but there is a considerable loss of pressure in bottling

the saturated liquid. In the case of the modern **counter-pressure bottling machines**, however, a much lower initial pressure can be used, and there is less loss of gas during bottling.

As a rule the contents of a bottle of soda water will show a pressure of 55-100 lbs. per square inch, while the pressure in bottles of sweetened goods such as lemonade and the like will be considerably lower.

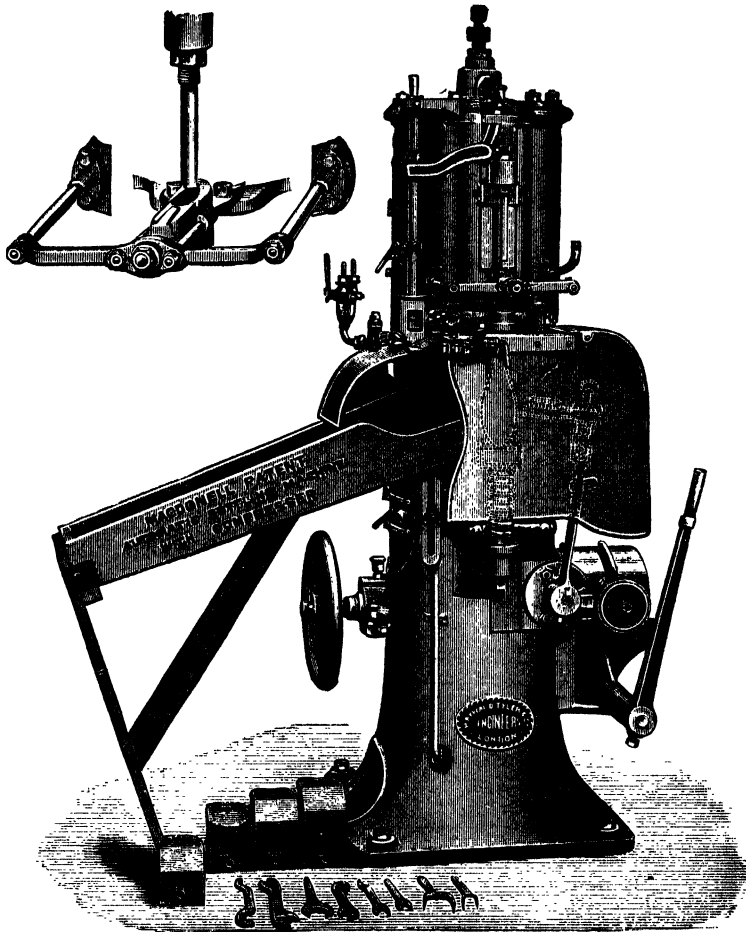


FIG. 3.—Macdonell's Automatic Bottling Machine.

It is essential to good bottling that the carbon dioxide should be free from air. Otherwise the aerated liquid will rush violently from the bottle, but will become flat almost immediately. Well-made soda water can be poured quietly out of the bottle, and will continue to emit bubbles of gas for at least five minutes after opening.

Natural Mineral Table Waters.—Many of the less saline mineral waters are bottled for table use, and in the case of some of them (*e.g.*, Apollinaris water) the gas that issues naturally with the water is collected and used for impregnating the bottled product under pressure. In this way the water within the bottle will contain the same gas under approximately the same pressure as before it issued from the rock.

The following table gives the proportions of the main constituents in parts per 1,000 in some of these table waters:—

	Sodium Chloride.	Sodium Sulphate.	Sodium Bicarbonate.	Calcium Bicarbonate.	Magnesium Bicarbonate.	Iron Bicarbonate.	Silica.	Potassium Bicarbonate.	Calcium Sulphate.
Apollinaris -	0.438	0.247	2.015	0.400	0.858	0.084	0.030
Gerolstein -	0.25	0.10	0.89	0.57	0.45	...	0.08
Johannis -	1.02	0.03	0.36	0.74	0.30	0.01	...
Sulis water -	0.02	0.03	...	0.01	0.02	0.017	0.04	...	1.31

In addition to the Bath water, which is sold for table purposes under the name of Sulis water, several spas (*e.g.*, Buxton and Malvern) now bottle their less saline products for drinking purposes.

Imitation Mineral Waters.—The early attempts to imitate natural saline waters aimed at their preparation for medicinal purposes. The water prepared by Bergman in Sweden, G. Paul in Geneva, and by Struve at his "spas" in Dresden, Leipzig, and elsewhere, were manufactured in direct imitation of the natural mineral waters.

In the case of Struve's products, the composition was based upon exact analyses of the natural waters, and it was claimed that the artificial products were equal in every respect to the originals.

Gradually the demand for artificial medicinal mineral waters declined, and although the recipes for their preparation are still to be found in the manufacturers' handbooks, it is probable that at the present day they are seldom made.

Soda Water.—Originally soda water seems to have been made in imitation of the slightly alkaline effervescing natural waters. It then became an officinal drug of the Pharmacopœia, and was required to contain 30 gr. of sodium bicarbonate per pint. Since 1898, however, soda water has no longer been included in the Pharmacopœia, and the proportion of sodium bicarbonate has been considerably reduced to meet the popular taste.

Potash and lithia waters are also no longer official drugs, but the old standards of 30 gr. of potassium bicarbonate and 10 gr. of lithium carbonate per pint are still usually followed, since these preparations are definitely bought for medicinal purposes, and have not, like soda water, become popular beverages.

Radio-Active Mineral Waters.—The discovery of the radio-activity of waters, such as those of Buxton and Bath, has supplied a probable explanation of the therapeutic effects of the class of waters that were formerly described as "indifferent."

According to the estimations of Sir William Ramsay, the waters of Bath have the following radio-activities:—¹

	Milligrammes per million litres.
Radium in water of the King's Well -	0.1387
Niton (radium emanation) in King's Well	1.73*
Niton " " in Cross Well	1.19*
Niton " " in Hetling Well	1.70*
Niton " " in gas from King's Well -	33.65*

* These figures are the weights of radium capable of forming the amounts of niton found.

Another method of measuring the radio-activity of natural waters is as follows: The amount of radium emanation in a litre of water is first estimated. It is then distributed throughout a definite volume of air, which may be made to circulate through the liquid until charged with emanation, after which its effect upon an electroscope is determined. The fall in potential during an hour is measured and calculated in electrostatic units. The result multiplied by 1,000 gives the number of "Mache units."

¹ *Chem. News*, 1912, cv., p. 135.

A special apparatus for testing waters by this method has been devised by Henrich.¹

As a rule natural mineral waters do not show a very high radio-activity; but the Joachimsthaler spring produces water that shows 14,000 Mache units.

According to Landin,² a suitable radio-active strength for artificial radio-active waters intended for drinking is 10,000 units, while baths may be used at 200,000 units.

In the preparation of artificial radio-active water a minute quantity of a radium salt is dissolved in a measured quantity of ordinary pure water, or of a water that is already radio-active.

Bottles of special construction have recently been made to contain artificial radio-active waters.

Brewed Goods.—Ginger beer has now become an essential branch of the business of the mineral water manufacturer. It is made by subjecting an infusion of ginger, containing sugar and citric or tartaric acid, to a limited fermentation with yeast.

The finished beer, after maturing in bottle, ought not to contain more than 2 per cent. of proof spirit, but if a wrong yeast is used, or the beer becomes infected with certain wild yeasts, the proportion of spirit may reach as much as 15 or 20 per cent.

Other brewed products include non-alcoholic hop ale and "botanical beers," such as horehound beer and the like. These are made in a similar way to ginger beer.

Bacteriological Conditions.—Although carbon dioxide is an antiseptic agent, especially when applied under pressure, the conditions under which soda water is bottled do not sterilise the liquid. A certain proportion of the bacteria that may be present in the water will continue to develop, although experiments made by the writer show that eventually the water will become sterile.

If prepared under insanitary conditions soda water may show a high degree of impurity. For example, commercial samples have been found to contain over 1,000 micro-organisms per cubic centimetre, whilst *B. coli communis* could be isolated from 1 c.c. of the liquid.

A main cause of the contamination is the old paste upon the labels, which are removed from the bottles by soaking in hot water. It is essential that the water in this tank should be kept distinct from the water used for cleaning and rinsing the bottles. However great the care to prevent any contamination, sterility is not to be expected, but in well-made soda water the number of micro-organisms does not reach 100 per cubic centimetre.

Objectionable Fermentations.—In sweetened goods, such as lemonade and ginger ale, fermentation processes may be set up through the use of impure sugar or want of cleanliness in the factory.

A mucinous fermentation which causes the contents of a bottle to gelatinise, is caused by various micro-organisms, including *Bacillus viscosus sacchari*, *B. gelatinosum beta*, and *Leuconostoc mesenteroides*. Wild yeasts introduced during the manufacturing process may cause an excessive production of alcohol, especially in ginger beer, or may set up fermentations producing a bitter flavour or fruity odour. If air has access to a bottle of a brewed liquid, through a defective cork, there is also a strong probability of souring taking place through acetification of the alcohol.

Metallic Contamination.—The principal metallic impurities to be expected in aerated waters are tin, copper, and lead. Tin may be derived from the action of acids upon tin pipes conveying the syrup to the bottling machines. The syrups used in the preparation of lemonade are strongly acid, and it is therefore essential that the pipes and tin-lined machinery should be thoroughly washed at the end of each day.

In most modern works, however, tin pipes are no longer used, their place being taken by glass tubing with rubber connections. At one time copper was a fairly common impurity in aerated mineral waters, but now that the interior of the cylinders is lined with tin, it is rare for copper to be present.

Lead is still not an infrequent impurity in sweetened goods, into which it is introduced with the citric or tartaric acid, which almost invariably contain traces of that metal. When it is present in soda water, which is very rarely the case, its origin will probably be found in the solder on the joints of tin pipes.

¹ *Zeit. angew. Chem.*, 1910, xxiii., p. 340.

² *Chem. Zeit.*, 1910, xxxiv., p. 102.

Traces of **iron** may sometimes be found in soda water, and will cause trouble from discoloration when any liquid containing tannin is mixed with the aerated water. It may be introduced as an impurity in the soda, or by contact of the soda solution with some iron object.

The question of the detection of metallic impurities in mineral waters, and in citric and tartaric acids, is dealt with by Budden and Hardy (*Analyst*, 1894, xix., p. 169), and by Tatlock (*Analyst*, 1908, xxxiii., p. 173), who criticises the limit of 0.002 per cent. suggested in 1907 by the Local Government Board as the maximum permissible quantity of lead in citric and tartaric acids.

The possibility of **arsenic** occurring in mineral waters is suggested by the facts that traces of that substance have been found in tartaric acid, and that glucose is sometimes used in the preparation of the syrups for bottling.

The blocks illustrating this section have been kindly lent by Messrs Hayward Tyler & Co.

SECTION XVIII

THE SULPHUR INDUSTRY

BY GEOFFREY MARTIN, D.Sc., Ph.D.

LITERATURE

See under "Sulphuric Acid." Also the following:—

A. G. SALAMON.—Article on **Sulphur** in Thorpe's "Dictionary of Applied Chemistry," Vol. V., 1913. An excellent account.

LUCAS.—*Journ. Ind. and Eng. Chem.*, February 1912, p. 140.

PLOUGH.—*Loc. cit.*, p. 143.

Journ. Ind. and Eng. Chem., February 1912, p. 132.

"Geological Survey of Louisiana," 2 vols., 1899, 1902. (U.S.A. Geological Survey.)

Journ. Soc. Chem. Ind., 1881, 1, p. 45; 2 (1883), pp. 10 and 202; 3 (1884), p. 392; 7 (1888), p. 162.

Journ. Soc. Arts, 1882, p. 724.

CHANCE.—English Patent, 8,666, 1887.

CLAUS.—English Patents, 3,608, 1882; 5,070, 1883; 5,958, 1883; 5,959, 1883; 5,960, 1883.

CHANDLER and FRASCH.—"History of the Exploitation of the Sulphur Deposits of Louisiana." *Journ. Soc. Chem. Ind.*, 1912, p. 168.

Chemical Trade Journal, 1933, 93, 316.

Chemical Age, 1933, 29, 184, 231, 251.

D. TYRER.—British Patents, 357,178, 358,580.

NATURAL SULPHUR

SULPHUR occurs in certain volcanic and other districts in the native state, the principal of which are Sicily, Louisiana, Japan, New Zealand, Wyoming, Russia, and certain districts in the Central American region.

The deposits in Sicily are worked by the Government, who are endeavouring to exploit the export of the sulphur rock. If this can be maintained of uniform quality and sulphur content, it should prove quite suitable for the production of sulphur dioxide. Those deposits which provide most of the Sicilian sulphur are not directly of solfataric origin, but are found in sedimentary deposits of Upper Miocene age,¹ in which they have been probably formed from gypsum, with which mineral they are intimately associated. Space does not permit of any further discussion of the ultimate origin of this sulphur.

Extraction of Sulphur.—During recent years the old wasteful "calcarone" method, now fortunately practically obsolete, of extracting sulphur from the "rock" or mixture of materials with which it is associated has given place to other more scientific processes, of which the **Gill kiln** is perhaps the best known and most widely used.

This furnace was patented as long ago as 1880 and consists of a series of connecting chambers, which are worked together in series; the first contains a fresh charge, and the last the residue of a former fusion. These chambers are circular in plan with dome roofs. Air is allowed to enter the chamber containing the residue, becoming thus preheated; it passes through the connecting flue into the next kiln, where some sulphur is burned, and the heat evolved melts most of the remainder; the hot gases then pass through a third and sometimes fourth kiln, heating the charges in those chambers and condensing any sulphur vapour; the draught is induced by means of a chimney. It is evident that such a series of kilns can be worked in regular rotation, as, of course, is the actual practice.

For rich ores—*i.e.*, over 25 per cent. S—the Gill steam liquation process is more economical. The great advantage of this method is that the ore may be

¹ *Min. Ind.*, viii., p. 592.

maintained at that temperature at which sulphur possesses the lowest viscosity, and is therefore most easily able to drain away from the perforated kettle in which the ore is placed and heated.

Sulphur is refined by distillation. For the manufacture of gunpowder it was necessary that it should be very pure, but now that gunpowder is becoming obsolete, and improved methods of sulphur mining have been introduced, only a comparatively small proportion is further refined. Whereas in 1905 there were some 1,720 mines at work in Sicily, there were only 476 in 1910, though the drop in consumption has only been from 427,719 to 391,971 long tons.

Frasch Process.—Louisiana sulphur possesses a peculiar fascination for the technologist, as the difficulties in mining it have been overcome in a masterly and ingenious manner by Herman Frasch.

The deposits in Calcasien Parish, Louisiana, and at Bryan Heights, Brazoria Co., Texas, and at some other points in the gulf-coastal-plain are said to be unique geologically. They are extensive domes, and even appear as such upon the surface. They seem to have their origin in

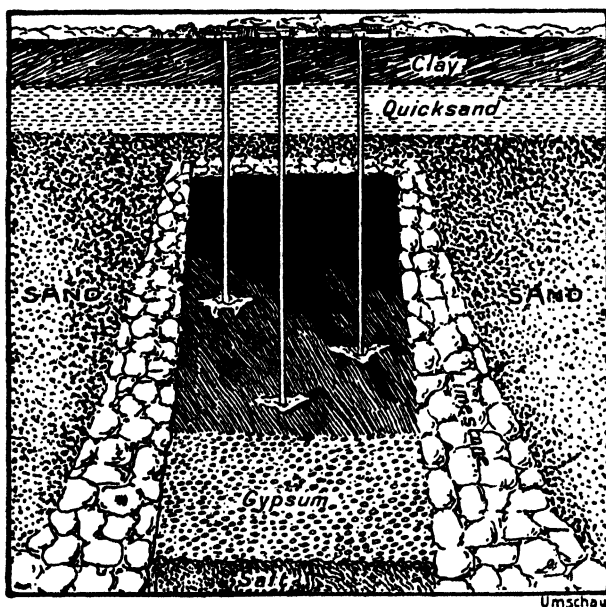


FIG. 1.—Diagrammatic Section of the Louisiana Sulphur Works.

the deposition from solution of deep-seated fluids in chimneys and passages at the intersection of fault planes in deep strata; possibly they are of solfataric character. The domes are overlain by limestone, soft quicksand, and gravel (see Fig. 1).

The sulphur beds have an average thickness of 125 ft., and are covered over with 464 ft. of rock and soil (376 ft. of clay, gravel, and quicksands, and 88 ft. of limestone and soft rock). Beneath the sulphur bed is gypsum with occasional layers of sulphur. Over 40,000,000 tons of sulphur are stated to be available.

The principle adopted is to sink a tube well into the deposit, and pump down superheated water under pressure; this melts the sulphur, which is then raised to the surface by means of an air-lift. The sulphur is produced of about 99.9 per cent. purity.

Fig. 2 shows a rough diagram of the process, which explains the action of the air-lift. First of all a well (not shown) of 17 in. diameter is sunk for about 50 ft. Inside this a 13-in. wrought-iron pipe (not shown) is sunk for about 250 ft. Next inside this is an 8-in. pipe, sunk right down (say 500 ft.) to the bottom of the sulphur beds. The pipe is perforated where it enters the sulphur. Superheated water is conveyed by this pipe to the sulphur bed. Inside the 8-in. pipe is a 6-in. pipe, which is unperforated. Superheated water is also pumped down this pipe. Inside the 6-in. pipe is a 3-in. pipe (unperforated), through which the molten sulphur is raised to the surface.

Inside the 3-in. pipe is a 1-in. pipe (unperforated), through which hot compressed air at 250 lbs. to the square inch is forced down to the sulphur bed. The superheated water melts the sulphur which collects in a pool at the bottom of the sulphur bed. The compressed air then forces this sulphur in the form of an emulsion (*i.e.*, mixed with air) right up to the surface through the inner tube as shown. The superheated water in the 6-in. pipe serves to maintain the sulphur in a melted condition as it rises to the surface.

When the well is exhausted the pipes are withdrawn. Sawdust is often introduced with the superheated water once the pool of liquid sulphur has been formed, since it prevents, to some extent, the flow of the quicksand water into the pool, with resulting lowering of temperature.

After the exhaustion of the well the sulphur is replaced by sandy earth (sent down the pipes) in order to prevent subsidence of the surface.

The output from one well may amount to 73,000 tons of very pure sulphur (99.93-99.98 per cent.). 400-500 tons per day can be produced; the average amount of sulphur extracted is now about 250,000 tons per year, which requires the enormous supply of 2,500,000,000 galls. of superheated water per year. The total boiler capacity is now about 25,000 H.P., steam being run at 100 lbs. Oil fuel (supplied locally) is used to the extent of 1,000,000 barrels per year.

These boilers supply superheated steam to heaters, each 15 ft. high and 3 ft. in diameter. The water, heated to 60° C., is pumped into the heater, and has there its temperature raised to 170°-180° C., being then forced under a pressure of 140 lbs. into the well. Since sulphur melts at 115° C., this water is hot enough to melt it. However, only about $\frac{1}{2}$ per cent. of the total heat is consumed in actually melting the sulphur, the rest going to heat the quicksand water, sides of the tubes, etc.

The liquid sulphur, on reaching the surface, is poured through pipes into large wooden bins (constructed of beams), some 65 ft. high and 250 ft. long and 150 ft. broad. The sulphur is poured into the centre of these bins, and caused to spread in layers 1 in. thick. It cools rapidly enough for continuous working. A series of bins may hold as much as 150,000 tons of sulphur.

This process is only applicable to deposits containing 60-70 per cent. of sulphur, and so will not do for the much poorer Sicilian deposits.

The Frasch sulphur now dominates the world's markets, and commercial competition by Sicily with Louisiana would, it is stated, be impossible except for the alleged fact that the chief sulphur-producing countries have come to an agreement, so that the Louisianian output is restricted, and Sicilian sulphur is able to realise a reasonable profit.

The Japanese deposits are of the normal solfataric type, as also are those of New Zealand, and indeed of most other districts, and are mined and quarried in the same way as those of Sicily.

Statistics of Sulphur.—The production of sulphur during recent years is given (p. 204) for the three greatest producing countries, together with an estimate of the world's total output.

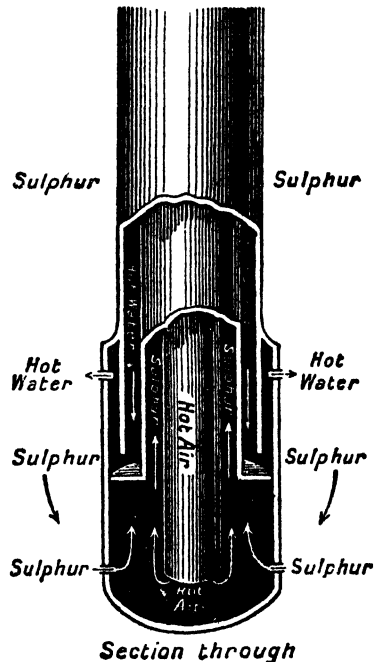


FIG. 2.—Section through Frasch's Sulphur Pump.

METRIC TONS

	Italy.	U.S.A.	Japan.	Total.
1912 - - -	357,547	800,300
1911 - - -	414,671	246,300	52,064	...
1910 - - -	430,360	259,699	43,155	...
1909 - - -	435,060	303,000	36,317	817,608
1908 - - -	445,312	312,700	33,419	829,437
1930 - - -	364,433	2,558,981	75,767	...

For Imports and Exports see p. 206.

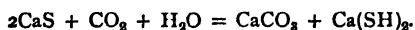
RECOVERED SULPHUR

Large quantities of sulphur are annually recovered from alkali waste by the Chance process, and from other sources of sulphuretted hydrogen by means of the Claus kiln, wherein partial combustion of the H_2S takes place with the formation of sulphur and steam.

Alkali waste (see this Volume under **Leblanc Process**) consists of a mixture of calcium sulphide, CaS , and calcium carbonate, $CaCO_3$. This remains behind after the extraction of the sodium carbonate from the black ash by lixiviation with water.

To every ton of soda extracted, over 1 ton of this alkali waste accumulates, and the slow oxidisation of the sulphides, with resulting production of sulphuretted hydrogen and soluble sulphur compounds, made the presence of this alkali waste an intolerable nuisance.

In the **Chance-Claus process** the alkali waste, mixed into a thin cream with water, is placed in high iron cylinders, termed "carbonators." Carbon dioxide, CO_2 , evolved from lime-kilns, is pumped into the first cylinder of a battery of seven cylinders. In cylinder (1) the CO_2 neutralises the free lime, and changes the insoluble CaS (calcium sulphide) into soluble $Ca(SH)_2$ (calcium hydrosulphide), thus:—



No H_2S is evolved at this stage. As the CO_2 continues to enter, and at last is in excess, the following action takes place:—



The gases escaping from the first cylinder contain about 10 per cent. H_2S by volume, together with much CO_2 . They are collected in a gas holder, mixed with the theoretical amount of air, and led into a Claus kiln for combustion (p. 219). This consists of a cylindrical furnace filled with layers of iron oxide, placed on gratings or beds of broken fire-brick, and the temperature of the whole is maintained at a dull red heat. The H_2S under these conditions burns to sulphur and water, thus:—



Once the action starts the iron oxide is maintained by the heat of combustion at a dull red heat. The yield of sulphur may amount to over 90 per cent. of the total sulphur contained in the alkali waste.

According to the Census of Production for 1907, from 20,000-30,000 tons were so recovered during that year in Great Britain alone. The H_2S can be burned to SO_2 and made into H_2SO_4 (see *Eng. and Min. Journ.*, 5th Feb. 1913).

The Thiogen Process.—It has long been thought possible to recover sulphur as such from smelter-smoke or other waste sulphur dioxide. During recent years Prof. S. W. Young, of Stanford University College, has conducted a persistent research in this direction, and experiments have been conducted at the Penn Smeltery on a fairly large scale. The reducing agent is oil-gas; doubtless natural gas could also be employed. A catalytic mass consisting of a special mixture of calcium sulphite and sulphide is used to increase the velocity of the reaction (see Young, *Eng. and Min. Journ.*, 15th Feb. 1913, p. 369).

Burkheiser has proposed to practically burn spent oxide in the purifier, leaving a residue of iron oxide in a sufficiently active state to absorb sulphuretted hydrogen easily. He effects this by passing air, diluted, if necessary, with some neutral gas through the spent material. Experiments have been tried on the large scale, but they do not appear to have been, nor are they likely to be, consistently successful.

Walther Feld devised an ingenious method for the recovery of sulphur as such from the sulphuretted hydrogen contained in coal-gas. It is based upon the production of sulphur in solution in a suitable oil by the mutual action of sulphuretted hydrogen and sulphur dioxide, the sulphur being eventually crystallised out.

The same inventor proposes to fix ammonia from coal-gas as sulphate without the intervention of sulphuric acid, by means of metallic thiosulphates or polythionates.

Neither of these processes is at work to any great extent. Reference should be made to the original communications (*J.S.C.I.*, 1912, p. 431; 1911, p. 1381; 1910, p. 352).

A small amount of sulphur is recovered in the manufacture of collodion artificial silks.

A vast literature exists and should be consulted.

Properties of Sulphur.—Sulphur in its pure state is only slightly yellow in colour under normal conditions; it is capable, however, of assuming a great number of "allotropic" forms.

The density of rhombic sulphur is 2.07, of molten sulphur 1.8, sp. ht. 0.1712. It is very brittle, but cannot be easily powdered with a pestle and mortar, because it becomes electrified by the friction. It is rather soft, being of a hardness equal to 2 in the mineral scale. It is odourless. The normal varieties are not appreciably soluble in water. It is a poor conductor of heat and electricity and is therefore frequently employed as an insulating material.

On heating it melts at 111.5° C., forming a mobile liquid which on further heating becomes darker, passing through a reddish-brown to almost black, at the same time its viscosity increases enormously; heated beyond some 260° C. it becomes less deep in colour and less viscid.

Sulphur has an appreciable vapour pressure at ordinary temperatures, and consequently will distil with a large proportion of water, but it does not boil until 444.8° C. is reached. Thermometers and pyrometers are frequently standardised and graduated by a determination of this. The ignition point of S in air or oxygen is about 257°-261° C. (M'Crae and Wilson, *Chemical News*, 1907, 96, 25).

Heat of combustion to SO₂ is 71,720 calories for monoclinic, and 71,080 for rhombic variety.

Solubility.—Insoluble in water, slightly soluble in ether, alcohol, and ethereal oils. Very soluble in CS₂ (40 per cent. in cold at 55° C., 100 parts of CS₂ dissolved 182 of S). Soluble in light petroleum. Tar oil at 100° C. dissolves 50 per cent. S. Benzene and toluene dissolve about 26 per cent. S at 100°. Dissolves in benzyl chloride (1 per cent. at 0°, 55.8 per cent. at 134° C.).

Space does not permit of a detailed discussion of the various allotropic forms—at least seven—of sulphur. **Rock or roll sulphur** is the commercial form which has been described, the sulphur in spent oxide is of the same nature. The former is usually exceedingly pure. The latter is hereafter to be described. **Flowers of sulphur** are minute crystals formed by quickly chilling sulphur vapour; it always contains a little sulphurous and sulphuric acid, even if carefully washed. The chief impurities in commercial sulphur are ash—usually originally present chiefly as gypsum and traces of bituminous matter, moisture, and acids, which are always found in both Sicilian and Louisiana sulphur. Arsenic is found in some recovered sulphur.

Uses of Sulphur.—The chief uses of sulphur are for gunpowder (now small), vulcanising rubber, dusting vines and hops to keep away disease, the preparation of carbon bisulphide, for making calcium and magnesium bisulphite used in the manufacture of paper from wood pulp (see **Martin's** "Industrial Chemistry: Organic"), and also as a food preservative.

It is estimated that 180,000 tons of sulphur are annually consumed for wood pulp manufacture for paper, 280 lbs. of sulphur being used for each ton of wood pulp.

The heavy cost of carriage makes the production of SO₂ for bisulphite from iron pyrites unable to compete with its production from sulphur, since the bisulphite must be produced in very dilute solution close to the wood pulp mills; also pyrites SO₂ usually contains some sulphuric acid, which would injuriously affect the fibre of the wood pulp. Over 100,000 tons of sulphur are used

in Europe alone for dusting grapes and hops. Powdered **ground sulphur** (not sublimated) is best, since it adheres properly to the vines. "**Bordeaux Mixture**" (applied to plants) consists essentially of sulphur, copper sulphate, and various porous substances.

Smaller quantities are employed in industrial organic chemistry, tanning, and medicine.

Considerable quantities are still burned for the manufacture of sulphuric acid. This acid is particularly free from impurities, such as arsenic, and is known as "brimstone-acid," though some so-called "brimstone-acid" is not truly made from brimstone.

Sulphur is also used in the bleaching of silk and wool by SO_2 , in the manufacture of ultramarine, vermilion, and other sulphides, in making enamels, and in making metal-glass cements ($\text{S} + \text{Fe} + \text{NH}_4\text{Cl}$).

Statistics.—See also p. 204.

YEAR 1932

	Exports of Sulphur.	Imports of Sulphur.
	Tons.	Tons.
United Kingdom	558	70,130
Belgium	1,577	8,762
France	23,189	148,000
Germany	21,207	48,211
Italy	280,563	5
Norway	46,116	11,137
U.S.A.	359,880	177
Chile	9,407	...
Japan	25,587	...
Canada	93,745
Australia	77,921
New Zealand	43,382
Finland	77,890

SECTION XIX

SULPHURIC ACID

BY GEOFFREY MARTIN, D.Sc., Ph.D.

LITERATURE

- LUNGE.—“Sulphuric Acid and Alkali,” Vol. I., Parts 1-3 (1913).
- DRÖSSER.—“Entwicklung der Schwefelsäurefabrikation,” 1909.
- HASENCLEVER.—“Present Condition and Cost of Sulphuric Acid.” *Journ. Soc. Chem. Ind.*, 1911, p. 1291.
- J. CATHABA.—“L'acid Sulphurique.” *Cosmos*, lx., 1911, pp. 48 and 75.
- “Sulphuric Acid Plant at Okerhütte in the Harz.” *Eng. and Min. Journ.*, Vol. XCI., p. 1109.
- MEYER.—“Intensive Process of Sulphuric Acid Manufacture.” *Zeit. ang. Chem.*, 1911, 24, 1520.
- MUNROE.—“Consumption of Sulphuric Acid in United States of America.” *Journ. Wash. Acad. Sc.*, I, 70.
- WILBUR A. WILSON.—“Manufacture of Sulphuric Acid in Tennessee.” “Resources of Tennessee,” Vol. II., p. 231.
- TRUCHOT.—“Present Position of Roasting Pyrites in Mechanical Furnaces.” *Proc. 7th Int. Con. App. Chem.*, Section II., p. 64.
- AWE.—*Zeit. ang. Chem.*, 1912, p. 2523.
- CHENEY and PATTERSON.—“Contact Sulphuric Acid from Brimstone.” *Proc. 8th Int. Con. App. Chem.*, Vol. II., p. 215.
- UTLEY WEDGE.—“The Sulphuric Acid Industry in the United States of America.” *Proc. 8th Int. Con. App. Chem.*, Vol. II., p. 241.
- “Combination of the Contact Process with the Ordinary Lead Chamber or Tower Systems,” etc. *Proc. 8th Int. Con. App. Chem.*, Vol. II., p. 249.
- E. SCHÜTZ.—“Manufacture of Sodium Thiosulphate.” *Zeit. ang. Chem.*, 1911, 24, 721-725.
- PETERSEN.—“Intensive Working,” etc. *Zeit. ang. Chem.*, 1911, 24, 877-881.
- HARTMANN.—“The Applied Tower Process at Hruschau.” *Zeit. ang. Chem.*, 1911, 24, 2302-2305.
- PETERSEN.—“Tower or Chamber Process System of Sulphuric Acid Manufacture.” *Zeit. ang. Chem.*, 1912, 25, 762-765. See United States Patents, 1,781,954, 1,810,253; German Patent, 312,318.
- “Report on Chemical and Allied Products, United States Census.” (12th) Report, 1902.
- “Final Report, 1st Census of Production, United Kingdom.”
- “United States Bureau of Statistics, Department of the Census.”
- “Annual Reports” of the Chief Inspector under Alkalis, etc., Works Act.
- “Manufacture and Uses of Sulphur Dioxide.” *Chem. Trade Journ.*, 15th Jan. 1910, p. 83.
- “Tennessee Copper Company's Acid Plant.” *Eng. and Min. Journ.*, Vol. XCI., pp. 15 and 1155.
- “Sulphuric Acid in Prussia.” *Chem. Trade Journ.*, 4th Mar. 1911.
- Chem. Trade Journ.*, 1933, 92, 434.
- F. SCHUCH.—*Chem. Ztg.*, 1932, 56, 933.
- H. WOISIN.—*Chem. Ztg.*, 1932, 56, 970; *Metallgesellschaft Periodic Review*, 1930, 17.
- F. RABE.—*Chem. Ztg.*, 1932, 56, 149, 770.
- B. WAESER.—*Chem. Fabr.*, 1932, 5, 445, 469, 474, 484, 501.
- H. SCHÜTT.—*Eng. and Mining World*, 1931, 2, 1660.
- Theory of the Chamber Process—**
- W. J. MULLER.—*Zeit. ang. Chem.*, 1931, 44, 821.
- O. WENTZKI.—*Zeit. ang. Chem.*, 1911, 24, 392-400.
- RASCHIG.—*Journ. Soc. Chem. Ind.*, 1911, p. 166.
- DIVERS.—*Journ. Soc. Chem. Ind.*, 1911, p. 594.
- RASCHIG.—*Zeit. ang. Chem.*, 1910, 23, 2243-2250.
- BERL.—*Zeit. ang. Chem.*, 1910, 23, 2250-2253.
- REYNOLDS and TAYLOR.—*Journ. Soc. Chem. Ind.*, 1912, p. 367.
- MANCHOT.—*Zeit. ang. Chem.*, 1910, 23, 2113-2114.
- O. WENTZKI.—1910, 23, 1707-1714.

- BRINER and KUHUE.—*Comptes Rendus*, 1913, 157, 448-450.
 KNIETSCH.—“Sulphuric Acid and its Manufacture by the Contact Process.” *Rev.*, 1901.
 AWE.—“Construction of Lead Chamber Walls.” *Zeit. ang. Chem.*, 1912, 25, 2523, 2524.
 FALDING and CATHCART.—“The New High Form of Sulphuric Acid Chambers.” *Journ. Ind. Eng. Chem.*, 1913, 5, 223-231.
 G. ODDO.—“Use of Sulphur Ores for Manufacture of Sulphuric Acid.” *Gas. Chim. Ital.*, 1910, 40, I., 217-312.
 RECKE.—“Concentration of Sulphuric Acid in Gaillard Towers.” *Chem. Zeit.*, 1910, 34, 173-175 and 182-184.
 PLUMMER.—“Sulphur at Home and Abroad.” *Sc. Assoc.*, 17th Aug. 1912.
 ANZIÈS.—“Sur le briquetage des minerais de fer.” *Rev. d. Met.*, Jan. 1912, p. 35.
 DUMAS.—“Commercial Pyrites; its Sources, Grades, and Uses.” *Min. and Eng. World*, 13th April 1912.
 G. DUBOIS and T. R. HARNEY.—*Ind. Eng. Chem.*, 1932, 24, 1091.
Chem. Met. Eng., 1930, 37, 501, 676.

INTRODUCTION

SULPHURIC acid is one of the most important of chemicals, being an intermediate raw product essential in the manufacture of explosives, dyes, manures, acids (like hydrochloric and nitric), sodium sulphate (used in glass making), aluminium sulphate, mineral oils, etc.

In fact, in almost every industry some sulphuric acid is used, and it has been asserted that the consumption of sulphuric acid by any nation is a measure of the degree of the civilisation of that country. This is certainly not strictly correct, but sulphuric acid forms the starting-point of, and is used in, so many different industries that there is a considerable element of truth in this statement.

Statistics.—The exact amount of sulphuric acid made is very difficult to estimate accurately, one reason being that much of the sulphuric acid made never comes on the market at all, but is produced in the industry itself for its own use and is immediately utilised.

It is safe, however, to estimate the world's annual production of sulphuric acid, calculated on the basis of 100 per cent. H_2SO_4 , as 7.8 million tons.

According to the First Census of Production, 1907, p. 549, the total output in Great Britain of sulphuric acid of 140° Tw. is put at 1,459,000 tons (= 1,123,200 tons of 100 per cent. H_2SO_4); of this Lunge, in 1903, estimated that from burnt pyrites 1,044,000 tons of 100 per cent. H_2SO_4 were made, and 80,000 tons from other raw materials such as brimstone, etc.

The total amount put on the market in Great Britain in 1907 for sale was 548,000 tons; in 1929 it was 967,000 tons.

3,750,000 tons of sulphuric acid of 50° Bé. were produced by the United States in 1913, this being exclusive of brimstone acid, and 4,010,000 tons in 1929.

Germany produces about the same amount of sulphuric acid as England, viz., over 1,000,000 tons. France produces about 600,000 tons. Austria-Hungary, Italy, Belgium, each about 200,000 tons; Russia, about 180,000 tons; Japan, 50,000-60,000 tons.

Germany in 1904 made 780,000 tons (100 per cent. H_2SO_4) from iron pyrites, and 150,000 tons out of zinc blende, about 20 per cent. being made according to the contact process.

In 1878 the whole production of Europe barely amounted to 1,000,000 tons. At the present time it may amount to 4,000,000 tons.

This enormous increase in the last three decades is due to the great development of chemical industry, and no doubt was occasioned by legislation which forced on manufacturers the condensation of the SO_2 evolved in ore-roasting operations.

The development of the superphosphate industry—caused by the growing demand for fertilisers throughout the world—has also been largely instrumental in causing the development of the sulphuric acid industry. In 1913 sulphuric acid sold at about 25s.-35s. per ton of 60°-66° Bé. (140°-162° Tw.).

General Methods of Production

Sulphuric acid is usually manufactured by the oxidation of sulphur dioxide and absorption of the resulting SO_3 in water, or by methods which amount to that in the end.



The oxidation of sulphur dioxide, or of its solution in water, is very slow under normal conditions, and various means have been used to increase the velocity of reaction.

Two main methods are used of increasing the velocity of reaction :—

- (1) **By Employing Oxides of Nitrogen.** This is the oldest and best known process, being usually termed the "Chamber Process."
- (2) **By Employing Solid Catalysts such as Platinum, Iron Oxide, etc. ;** this is the so-called "Contact Process."

The old "Chamber Process" yields directly a dilute "chamber acid" of 50°-55° Bé. (=62.70 per cent. H_2SO_4), a "Glover acid" of 60° Bé. (=75.82 per cent. H_2SO_4), and, by methods of concentration, an acid of 66° Bé. (=93.97 per cent. H_2SO_4).

The Contact Process, on the other hand, produces more concentrated sulphuric acid than this, the main product being fuming sulphuric acid, which is often diluted down to form sulphuric acid of 100 per cent. H_2SO_4 .

Although the amount of sulphuric acid produced by the Contact Process is increasing, nevertheless by far the greater part of the acid made to-day is produced by the Chamber Process. In fact, the Contact Process has served to stimulate the Chamber Process, and such great improvements in working details in the latter have been made in the last few years, that it seems unlikely that it will be superseded by the Contact Process, so far as the making of dilute sulphuric acid is concerned.

The lead chambers employed in the old Chamber Process are now being replaced by methods of intensive working in towers (Opl and Griesheim).

Raw Materials used for Sulphuric Acid Manufacture.—At one time sulphur (see Section XVIII.) was the raw material most used for burning to sulphur dioxide. At the present time, however, the sulphur dioxide is mostly produced by roasting iron pyrites, and to a less extent from the melting of zinc, lead, and copper ores. The following are the principal raw products used in the manufacture of sulphuric acid :—

1. **Sulphur** (see Section XVIII.).

2. **Iron Pyrites.**—Iron pyrites (FeS_2), containing 53 per cent. S in a pure condition, has, of all heavy metal sulphides, the highest sulphur content. That usually calcined contains 43.48 per cent. S. In order to burn satisfactorily for sulphuric acid manufacture it should contain not less than 35 per cent. S.

The principal country producing pyrites is Spain, most of the ore coming from the Huelva district. It is cupriferos (2.4 per cent. Cu), and the copper is usually extracted by the wet process. The Tharsis mine is approaching exhaustion, but vast quantities are still known to exist at the Rio Tinto mine (or quarry, as it really is now), though the copper values diminish as the depth increases. Next in order of production are Norway and the United States of America. Valuable deposits occur in Russia and Canada.

The statistics for the world's production of pyrites are most misleading, as most of that from the Huelva district is returned as copper ore. They are as follows :—

	Spain.	Portugal.	Norway.	U.S.A.	Total.
1912	500,000	601,443 ¹	430,000	342,655	...
1911	344,879	282,773	350,000	299,904	...
1910	294,184	312,906 ²	322,000	227,280	1,826,854
1909	236,000	284,735	282,606	213,371	1,730,000
1908	263,457	81,417	269,129	209,774	1,854,849

Enormous quantities of pyrites are annually imported into the United States of America, the figure amounting to about 750,000 tons, in order to provide acid for the extensive fertiliser and other industries.

Pyrrhotite contains a smaller proportion of sulphur than pyrites, but more than copper pyrites ($CuFeS_2$), and is therefore suitable for use for the production of SO_2 . Considerable deposits occur in Virginia.

Marcasite has the same chemical composition as pyrites, but has been formed in a different way and is of different crystalline form and properties; there are no massive and considerable deposits known of this mineral.

3. **Zinc Blende.**—Max. Hasenclever pointed out that it by no means follows

¹ Includes 120,148 cupreous ore.

² Total shipments of pyrites from Port of Huelva during 1910 = 2½ million tons.

that it is cheaper to manufacture sulphuric acid from blende than from pyrites, even granting that the sulphur has not to be actually paid for. However, in Germany legislation has been recently introduced restricting the amount of acid which may be discharged into the air, and consequently a large amount of sulphur formerly wasted is being turned into sulphuric acid with profit. In the United States of America the Hegeler mechanical furnace has been employed for many years, and the amount of sulphuric acid produced in that country from zinc blende was over 250,000 tons during 1911.

By far the greater proportion of the zinc which is produced is derived from zinc blende, which contains about one-third of its weight of sulphur. It is, therefore, of some interest to include the statistics for the world's production of this metal, this being a most valuable guide to the amount of sulphuric acid derivable from this source.

	U.S.A.	Germany.	Belgium.	Total.
	Tons.	Tons.	Tons.	Tons.
1912	316,368	205,940	271,064	976,872
1911	268,378	195,102	235,776	881,886
1910	251,348	172,578	227,754	824,973
1909	241,730	167,100	219,766	784,199
1908	190,933	161,940	216,490	718,160

4. The most important other metallic sulphide, regarded as a source of sulphur, is galena, lead sulphide (PbS).

During recent years the Dwight-Lloyd furnace for roasting galena has been installed in the States and in Germany, where even "contact" acid is made from the smelter smoke—after due purification. The Huntington-Heberlein pot furnace has also permitted the useful turning to account of some of the sulphur in galena. Regarded as a source of sulphuric acid, it is interesting to note that over a quarter of a million tons of sulphuric acid should be producible from this ore in the five principal producing countries.

5. The **Spent Oxide** of gas works consists mainly of a mixture of sulphur, hydrated oxides of iron, some undecomposed sulphides, sawdust, and some organic impurities. The sulphur content may vary between wide limits (25-80 per cent.). It can be readily burned to SO_2 , or the sulphur can be distilled or extracted.

In large cities, such as London, Manchester, etc., considerable quantities of sulphuric acid (some 30,000 tons H_2SO_4 in London alone) are produced from this material.

Sulphuretted Hydrogen is produced mainly in the Chance process of working up alkali waste and in the sulphate of ammonia saturators, where it comes from gas liquor. Gas containing as low as 15 per cent. of H_2S and over 75 per cent. of CO_2 can be satisfactorily burned to SO_2 in properly designed furnaces. The gas may, as an alternative, be partially burned in a specially designed furnace—the Claus kiln—and the sulphur recovered as such; it is, however, of rather poor quality, and cannot usually compete with refined Sicilian or Louisiana sulphur.

6. **Nitrates.**—Until recently the only source of oxides of nitrogen for the production of H_2SO_4 was the well-known Chile saltpetre of commerce.

At the present time there are three other sources of nitrates which we have to consider; they are those produced by the oxidation of atmospheric nitrogen in electric furnaces of the Birkeland-Eyde, Schönher, or Pauling type, the fixation of nitrogen by means of metallic carbides, and by the catalytic synthesis of ammonia, with the production of nitric acid from the two latter by the Ostwald process. The forms of nitrate which are available to the sulphuric acid manufacturer are, therefore, (1) nitre, the refined quality is usually employed; (2) calcium nitrate, or an impure sodium nitrate; (3) nitric acid, the last-named being available only if the factory be situated in immediate proximity to an Ostwald plant or nitric acid works.

Analysis of Raw Materials

The examination and analysis of the raw materials is best conducted as follows, though there are, of course, many modifications and other methods:—

Pyrites and similar **metallic sulphides** are best analysed by determining the moisture in the ordinary way, and calcining the weighed quantity in a porcelain or silica boat in a glazed porcelain, silica, or glass tube, air being drawn over the material and through bromine water. The resulting

sulphuric acid is estimated gravimetrically. For sulphur, spent oxide, and other sources of sulphur in which the sulphur is not combined, the above method may be employed, or a suitable solvent, such as carbon bisulphide or benzol, may be used to separate the sulphur. A most accurate and rapid method introduced by J. Foucar consists in the digestion of the sample with alcoholic sodium cyanide, and titration of an aliquot portion of the resulting sulphocyanide. The results are usually returned in percentages. More than 1 per cent. of organic matter soluble in CS_2 in spent oxide is obnoxious and can be avoided.

Even at the present day a most unscientific method of analysis is still to a great extent employed for the analysis of nitre. According to this method the sum of the sodium chloride (estimable by titration with standard silver nitrate) and sodium sulphate (estimable gravimetrically with barium chloride) is called the refraction. It is assumed that the rest is sodium nitrate, which, as a matter of fact, is practically never the case. What the user generally wishes to know is the actual amount of nitrate present. The most rapid method of estimation is by means of Lunge's nitrometer, in which a strong solution is made in water, run through a stop-cock into a graduated burette over mercury, strong sulphuric acid added and the volume of NO evolved determined. There are, of course, a number of other methods, of which one at least is convenient and rapid; it consists in the oxidation of an excess of ferrous salt and titration of the residual ferrous salt. For some purposes it is necessary to know the amount of perchlorate present.

Roasting Processes for Producing Sulphur Dioxide for the Manufacture of Sulphuric Acid

The sulphur dioxide (SO_2) produced for oxidising into sulphuric acid may be obtained by burning iron pyrites, or by roasting zinc blende, galena, and copper ores.

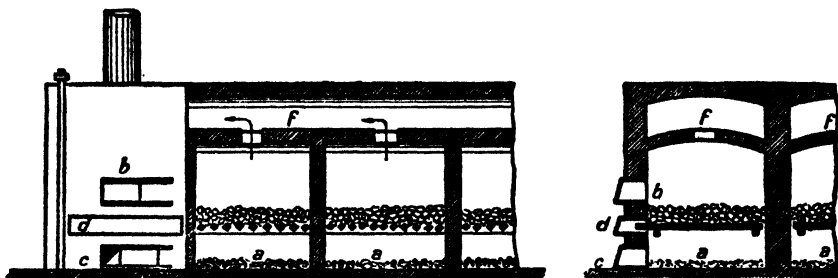


FIG. 1.—Lump Pyrites Kilns.

For making very pure arsenic-free sulphuric acid sometimes sulphur brimstone is burnt. Iron pyrites, zinc blende, etc., nearly always contain arsenic, which can easily find its way into the acid produced therefrom.

The usual process is to roast the iron pyrites in a stream of air, when the sulphur burns to SO_2 (also some SO_3 is produced), and a residue of iron oxide (Fe_2O_3) remains behind. Some ferric sulphate is usually produced, which, at $600^\circ C.$, completely decomposes to Fe_2O_3 and SO_3 , or SO_2 and O .

Pyrites rich in sulphur will, when once inflamed, continue to burn without need of an external supply of heat, until almost all the sulphur has burnt out.

Pyrites Kilns.—The pyrites is crushed, sieved, and the pieces, usually the size of walnuts, are burnt in "lump pyrites kilns," while the fine dust is burnt in mechanical fumes of another construction, described below.

Fig. 1 shows an ordinary hand-fired lump pyrites kiln, which is now practically obsolete. They are united in batteries of ten or more. A deep bed of pyrites rests on a rectangular or polygonal set of bars, and is burnt by air streaming up between the bars from below. The ash can be removed from time to time by shaking or rotating the bars (either by hand or mechanically) through 45° (whereby the space between them is increased), when the ash falls through the bars into the ash compartments (*a*).

As the pyrites burns away, fresh lump pyrites is thrown into the kiln through *b*. The gases, rich in SO_2 , stream away into the flue dust canal (*f*) to the Glover tower.

It is very important that only the right amount of air is allowed to enter. The air supply is regulated by means of a sliding door *c*. *b* and *d* are closed by air-tight sliding doors.

The burners require some skill in handling, as with imperfect or irregular

admission of air sintering may take place, and the sulphur content in the ash may also increase to a high figure.

The furnaces for treating the **crushed or powdered pyrites** usually consist of a series of superincumbent shelves, from which the ore is worked down in succession either by hand or **mechanically** (Maletra type of furnace).

Fig. 2 shows a **Herreshoff mechanical furnace**. It consists of a cylindrical furnace, about 2 metres high, built of refractory brickwork, enclosed in a strong steel casing. Inside are a number (usually five) of circular shelves *a*, which are gently inclined as indicated in the figure. These are also made of refractory material. A vertical air-cooled shaft *B*, with cast-iron rakes or arms *r* attached, and driven by a cog-wheel *i*, placed below, causes the ore to traverse the shelves.

The finely crushed pyrites, entering through the hopper *c*, is poured in a regular stream by means of a worm on to the uppermost of the shelves, thence it moves downwards as indicated by the arrows, from shelf to shelf. All the while it is subjected to the action of an uprising stream of air, so that in its passage downwards it is burnt and discharged as ash at *f*, while the SO_2 rich gases escape through *h*.

In order to cool the shaft (which otherwise undergoes rapid corrosion) holes are made at the base (shown at *k* and *l*), and a current of cold air streams up through it. The rakes *r* are made easily detachable so as to be renewable when worn out (see also Figs. 3 and 4 for modern types of air-cooled shafts and raking arms).

The operation is started by heating the furnace with coke or coal, but later the burning of the sulphur in the pyrites supplies sufficient heat to maintain the combustion. The shelves are provided with a series of ports (for air admission) and doors (for repairs).

One disadvantage of this furnace is the fact that the burner gases bear with them much dust, which must be held back by means of large dust chambers and special "gas filters" made of coke.

Improvements introduced by the J. L. Foucar consist in the provision of a dust chamber over the top of the top working bed and a telescopic dust-sealed burner pipe.

The former completes the combustion and prevents sublimation—a difficult thing to avoid when using high per cent. spent oxide—and causes the deposition of a certain amount of dust. The latter prevents fracture of the cast-iron pipes and connections

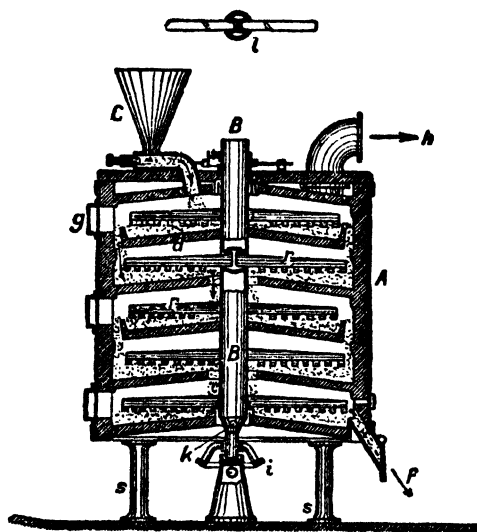


FIG. 2.—Herreshoff Mechanical Furnace for Pyrites.

or distortion or worse of the brickwork on account of expansion and contraction by heat.

The Wedge Mechanical Roasting Furnace (Fig. 5) is of the same type, and is probably the best for large works, individual burners being now constructed to calcine up to 40 tons of pyrites per twenty-four hours.

In this burner the central column and rotating arms are **water-cooled** by means of pipes of ample size passing down the large hollow shaft from a circular water tank fixed on the top of the central shaft. This central shaft is wide enough and at a low enough temperature to enable a man to get inside and fix on a new arm (when necessary), without stopping the furnace for more than a few minutes. The fastenings and water connections are all inside the shaft, and the temperature of the water in the arms may be regulated in accordance with the temperature of the particular hearth in which the arms are working, the arms being quite independent of each other. Only the water pipes of the arm which has to be exchanged have to be disconnected. These water-cooled arms last very well and the cooling is very effective.

The hearths, which vary in number from five to seven, are horizontal on their upper surface. The ore drops through the same port from shelf to shelf that the gas comes up through. The charging arrangements are very simple.

The Harris Furnace (Figs. 6, 7, 8) consists of two series of adjacent circular superimposed hearths, so arranged that the ore from one hearth becomes swept

into the one adjacent to the hearth beneath, then back. It is specially designed to diminish the amount of dust usually carried forward by mechanical burners, and is said to effect this in a very satisfactory manner.

The course of the gases is a little difficult to follow without a complete series of drawings. The flues are so arranged that all the gas may be led through the dust chamber, or one or more sections may be by-passed for repairs.

The rakes are slipped on water-cooled projections of the water-cooled shaft, the design of which is distinctly simple and ingenious.

It is particularly claimed for this furnace that the dust is a minimum and that the costs of repairs are low, such few repairs as may be necessary being made without stopping the furnace.

The number of mechanical calciners is now literally legion: amongst others may be mentioned the O'Brien, the Moritz, the Lurgi, the Scherfenberg, the Frasch, the Thorna, the Ducco (an inclined tube), and the Wyld.

The authors do not consider that mechanical furnaces have nearly approached finality in their design, much room for improvement remaining, particularly in the directions of the reduction of dust, the simplification of the cooling arrangements, or by the provision of central column and arms coated with or formed of some material upon which sulphur has no appreciable action, the preheating of the air and its admission through the teeth of the rabblies, the improvement of mechanical means of handling both raw and calcined material, the arrest and removal of such dust as cannot be prevented.

However, in any new installation it almost invariably will be found better to crush the ore, if received in lumps, and instal mechanical burners, than to employ the old-fashioned lump-burners.

The chief advantages of mechanical burners are simplicity—requiring no appreciable skill in handling—cheapness in working, regularity. Their disadvantages are the high initial cost and the necessity of installing some kind of power.

It is important to note that spent oxide from gas works containing from 80 per cent. of S, down to as low as 0.25 per cent. S, can be burnt in three shelf burners of this type.

The residue from burnt pyrites, also from burnt "spent oxide," still contains 0.25 to 3 per cent. S. If the ore contained lead or zinc, the percentage of sulphur may be much higher than this. Also arsenic is usually present. These impurities made the "burnt" iron oxide very unsuitable for iron smelting and it was usually "dumped."

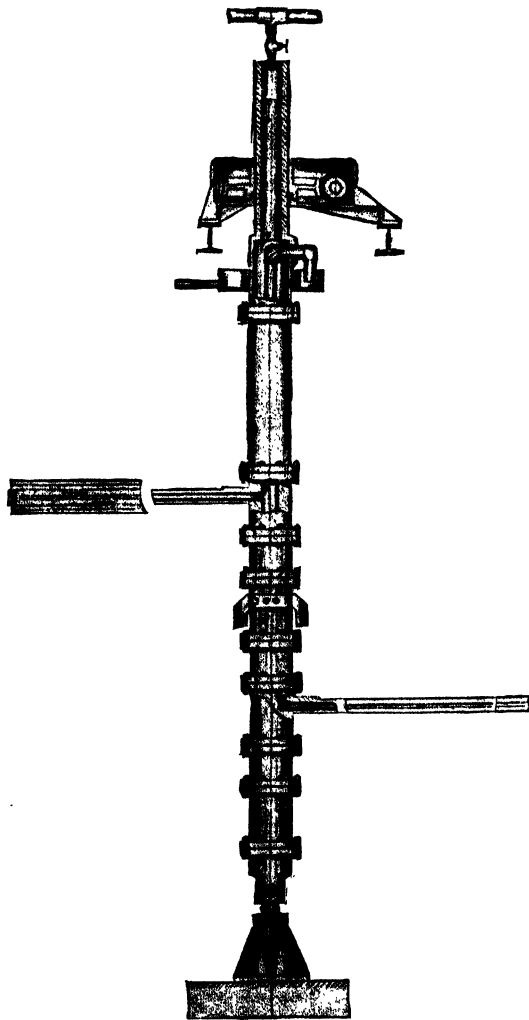


FIG. 3.—The "Harris" Patent Water-cooled Flanged Aim and Shaft for the Wedge Furnace. (See p. 212.)

Now it is being used in part for the manufacture of copperas or ferric sulphate for sewage treatment, or the residue from the burnt "spent oxide" is neutralised with lime or ammonia and used again in the gas work's purifiers. The action of the latter is slow, but in time it seems to recover.

The burnt pyrites can now be put into a form in which it can be used in the blast furnace. For this purpose it is treated in a nodulising kiln and the sulphur is reduced to a trace. This is effected either by the use of a binder or flux or without. The kilns are long inclined tubes

with refractory linings not unlike cement kilns; they are fired with waste gas, where that happens to be available. In view of the world's undoubted shortage of iron ore, of the enormous quantities of pyrites cinders which are obtainable, and of their being usually low in phosphorus, these nodulising processes are of great importance.

When the burnt pyrites contains copper it is usually worked for this, the sulphur being withdrawn from the ore along with the copper in the form of copper sulphate. In this case the residual iron oxide is pure enough to be smelted for iron in the blast furnace.

The zinc-rich German pyrites, after burning, leaves a residue from which zinc sulphate is extracted by lixiviation (Oker), which is used either for the manufacture of electrolytic zinc (Brunner-Mond process) or for Lithopone manufacture (see *Martin's "Industrial Chemistry: Organic,"* under Colours).

The employment of enriched air, *i.e.*, air containing more than 21 per cent. of O_2 , may be found to be profitable, particularly in the calcination of some ores of low sulphur content. The cost now, by fractional distillation of liquid air, is comparatively small.

Iron pyrites forms the main raw material for the production of sulphuric acid. However, owing to the rise in price of pyrites, sulphuric acid manufacturers have turned their attention to other mineral raw materials, amongst which **zinc blende, copper ores, and lead sulphide (galena)** may be mentioned. The SO_2 rich gases evolved from furnaces working these ores for the metals are now no longer allowed to escape into the air and damage the surrounding vegetation, but are to an increasing extent used for the manufacture of sulphuric acid.

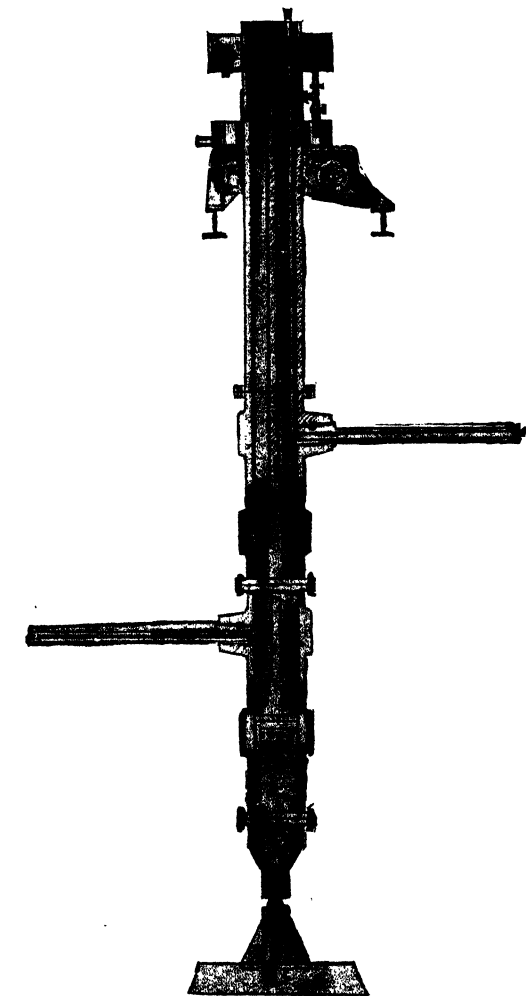


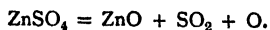
FIG. 4.—The "Harris" Patent Air and Water Cooled Stirring Arm and Shaft for the Wedge Furnace. (See p. 212.)

In this case, however, it must be remembered that the main object of the operations is the production of the metals, zinc, lead, and copper, the utilisation of the gases evolved for sulphuric acid manufacture being of secondary importance.

Zinc blende (ZnS) is largely worked in Germany at Stolberg and Lipine. The ore is roasted at a temperature of 900° - $1,000^{\circ}$ C., when the following change takes place:—



At temperatures lower than 900° we get $ZnSO_4$ formed, whereas at temperatures over 900° this decomposes, thus:—



Owing to the small sulphur content of these zinc ores (33 per cent. S when pure,

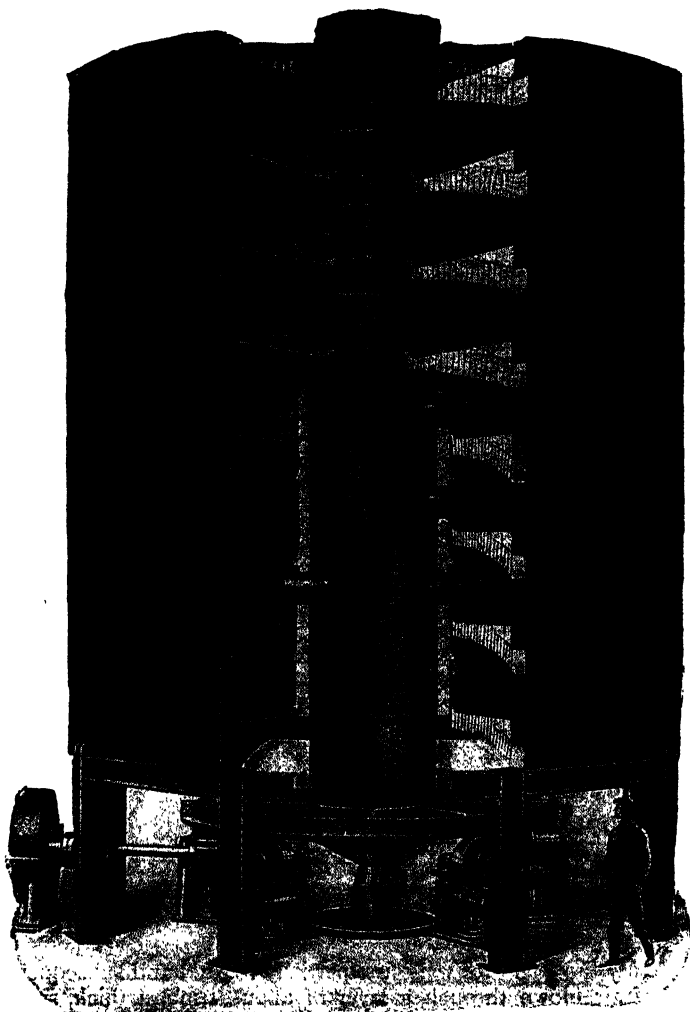


FIG. 5.—Wedge Mechanical Roasting Furnace. (See p. 212.)

under 20 per cent. S in actual practice), it is necessary to supply external heat in calcining zinc blende, so that here pyrites roasting furnaces are inapplicable.

In Germany a hand-raked muffle shelf furnace—the **Rhenania**—is largely used, in which the zinc blende gases are separately led off without mixing with the gases from the fire supplying external heat to the furnace. These zinc blende furnace gases, containing $5.7\frac{1}{2}$ per cent. vol. SO_2 , are sometimes led into the leaden chambers, but it is better to pass them into a contact apparatus, for conversion into sulphuric acid.

Figs. 9 and 10 show the zinc blende roasting furnace **Rhenania**. The furnaces are long muffles, built together in pairs, and separated by a dividing wall (Fig. 12). Each furnace contains three muffles, A, B, C, lying one over the other, in which the zinc blende (introduced by the funnel T) is gradually worked down from muffle to muffle by raking through the doors *a, a, a*. The fire gases for heating and muffles stream above, below, and between the muffles by means of the canals *e, g, h*. R is the fireplace, the hot gases from which, after effecting their purpose of heating the muffles to 900° - $1,000^{\circ}$ C., stream away through J to the chimney, without mingling with the SO_2 : rich gases come from the muffle.

The air is allowed to enter the lowest muffle c at one end, and the burner gases from the muffles pass into the dust chamber K and then pass to the Glover tower (or contact apparatus) for conversion into chamber sulphuric acid.

The burnt zinc blende, consisting of zinc oxide (which must be burnt free from sulphur), is raked out from time to time and smelted for zinc.

In the United States the **Hegeler** mechanical furnaces, which are also rectangular shelf-burners, have been used for some years. In Germany the **Lurgi** mechanical furnace for zinc blende is in use.

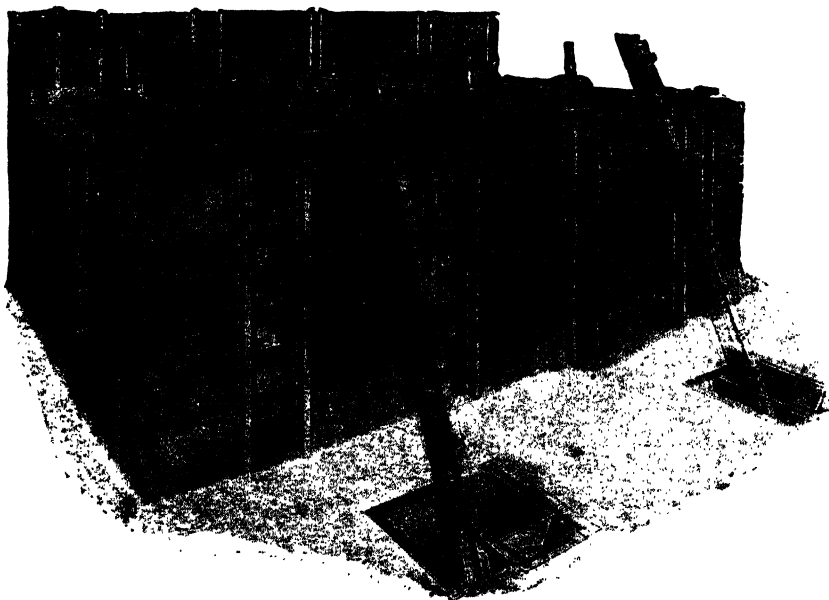


FIG. 6.—Harris Mechanical Roasting Furnace (8 Shafts, 4 Hearths (4 Sections)). Front View showing Mechanical Feed Tables and Hoppers, Elevators, etc. Roasting Capacity, 28 tons Pyrites Fines per twenty-four hours. (See p. 212.)

The treatment of **lead ores** (usually galena, PbS) is somewhat different, only part of the sulphur being recoverable as SO_2 .

Until recently the lead ores were first partially roasted and subsequently melted, and a blast of air blown through a layer of about 1 metre thick, such processes being the **Huntington-Heberlein** and **Savelsberg**.

During the last few years Messrs **Dwight and Lloyd** have introduced a method whereby a thin uniform layer of the materials to be sintered is fed on to the perforated bottom of a conveyor, the charge is automatically ignited on the underside, and the sintering proceeds right through the layer, the necessary heat being supplied by the sulphur in the ore or by added carbon. This process is applicable not only to lead ores but also to copper and iron sulphide ores and flue dust. The type which is now most popular is the "straight line." The gas from this sintering roaster contains 2-7 per cent. SO_2 , and is being used for the production of sulphuric acid in Germany. This furnace has been further improved by **von Shippenbach**. The chief differences between it and the Dwight-Lloyd are: (1) The roaster-gas is so regulated that 4-5 per cent. SO_2 is continually separated from that containing only 0.2 per cent.; (2) the thickness of the bed is only 4 in. instead of 10 in.; (3) the grate has a different construction; (4) the ore is first rough-roasted, as in the Huntington-Heberlein process.

In the **Dwight-Lloyd** process the partially roasted material is finally reduced in a blast furnace, the gases from which can be, and in many cases are, employed for the production of sulphuric acid. **Dr Hasenclever** estimates that 90 per cent. of the sulphur contained in galena should be recoverable by this process.

The gases contain, of course, some 5 or 6 per cent. of CO_2 and a large volume of dust, which has to be removed.

It has been estimated that if all the lead ores smelted in Germany were to be treated in this way, they would yield about 40,000 tons of sulphuric acid of 60° B. annually. In England the production would only be about 6,000 tons; in Belgium, 18,000; in France, 12,000; in Spain, 75,000; and in the United States of America, from 100,000 to 200,000.

In the case of **copper pyrites** (CuFeS_2) only part of the sulphur can be recovered as SO_2 for sulphuric acid manufacture.

The furnaces employed for smelting copper, and from which the gases are utilised for the manufacture of sulphuric acid, are principally of the water-jacketed blast furnace type, except, of course, where the copper content is low. Some sulphuric acid is also now recovered from the furnaces, reducing the "matter."

In the blast furnace it is important that the smelter should be of large size, otherwise the heat losses are relatively so great that it is not possible to reach a sufficiently high temperature to thoroughly melt the matter. One of the main advantages of the blast furnace is that the heat of combustion of the mineral is usefully employed, and much fuel is saved. The chief disadvantage is that the process can only be usefully employed where the ore is in lumps. However, the **Dwight-Lloyd** straight line sintering roaster has successfully solved the problem of the treatment of fires in the blast furnace.

According to present practice a small amount of coke is still employed in the smelter, which consists of a water-jacketed silica-lined shaft, to which hot-air twyers are fitted. The furnace is fed with a mixture of the ore, silica, and coke. The iron and sulphur are burned, the former forming a fusible slag with the silica, and the latter is removed as gaseous SO_2 ; the copper is recovered as a molten "matter" consisting mainly of copper and sulphur, and containing up to 50 per cent. Cu. The best known of these blast furnaces is the **Mathewson**. The gases contain a large quantity of dust, and usually some proportion of arsenic; they contain at the works of the Ducktown and Tennessee Copper and Sulphur Co. $\frac{3}{4}$ per cent. CO_2 and $\frac{3}{4}$ per cent. SO_2 . At these works over 160 tons of acid per day are recovered in this way by the smelting of copper pyrites. It is, of course, usual to work a number of furnaces together, otherwise wide variations in the composition and temperature of the gases are inevitable.

Sulphur-Burners.—Quite another type of furnaces are those in which sulphur is burned for producing sulphur dioxide, either for the manufacture of special "arsenic-free" sulphuric acid, or for the manufacture of sulphurous acid and sulphites (p. 253), for bleaching, disinfecting, and the manufacture of wood pulp for paper.

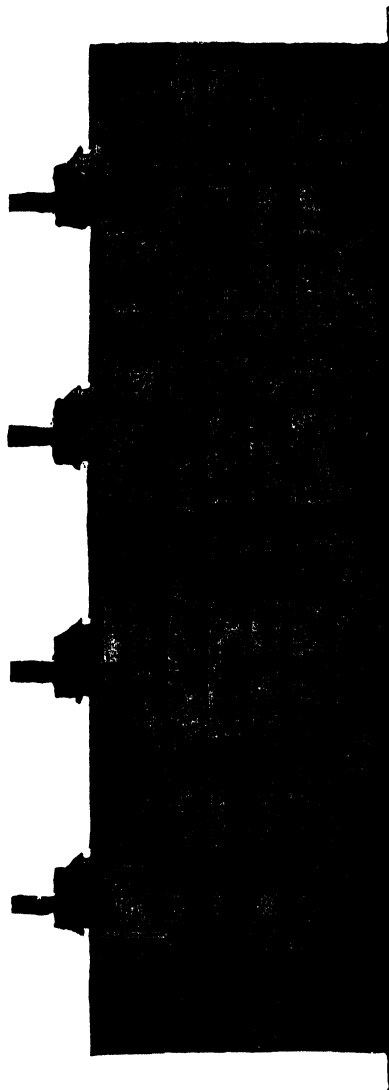


FIG. 7.—Harris Mechanical Roasting Furnace. Elevator (Part Wall Removed) showing Flue Outlets, Discharges, etc. (See p. 212.)

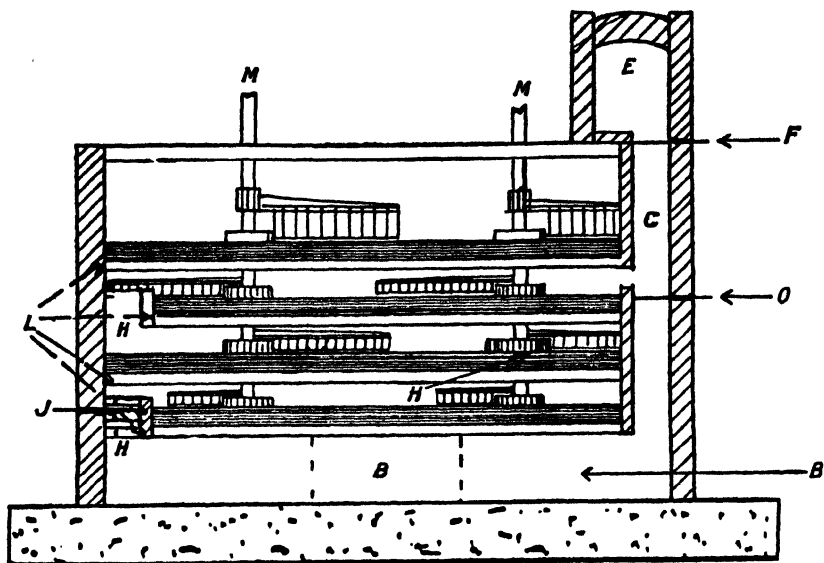


FIG. 8.—Harris Mechanical Furnace—Cross Section. (See p. 212.)

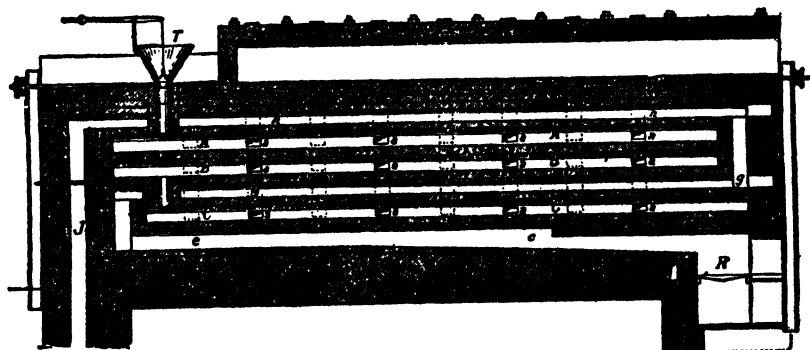


FIG. 9.—Longitudinal Section of Rhenania Furnace for Roasting Zinc Blende. (See p. 216.)

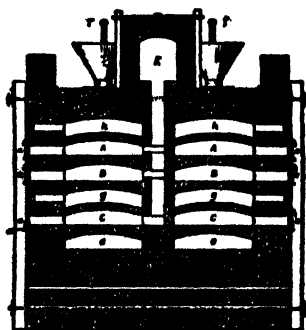


FIG. 10.—Cross Section of Rhenania Furnace for Roasting Zinc Blende. (See p. 216.)

There are two general types of furnace in which sulphur is burned : of these one intentionally volatilises the sulphur and ensures complete combustion of the gas, the other burns some of the sulphur, and condenses that portion which is volatilised but not burned. Of these there are again sub-types.

Of the first type the most noteworthy is the Tomblee and Paull. It consists of a horizontal, cylindrical, lined iron shell 8 ft. long and 3 ft. in diameter, with conical ends, making one revolu-

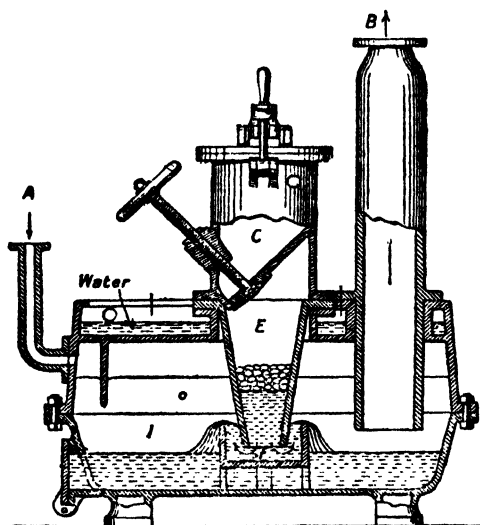


FIG. 11.—Sachsenberg Sulphur Burner.

tion in two minutes. At one end is a hopper and worm-feed with sliding dampers, at the other a rectangular cast-iron box of 37 cub. ft. capacity, provided with sliding damper and vertical uptake, which leads to a brick dust-catcher. The sulphur is fed in lumps which melt just before dropping into the body of the burner, and a complete liquid coating is formed on the inside of the shell as it

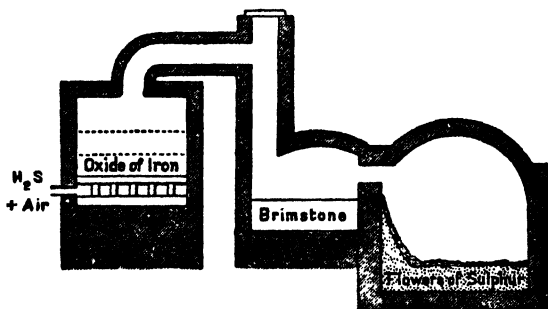


FIG. 12.—Claus Furnace for Burning Sulphuretted Hydrogen.

revolves. The combustion box and vertical uptake complete the combustion. The furnace, box, and uptake are all lined with refractory material. Using 98 per cent. Louisiana sulphur, it is only necessary to clean out the dross which collects once in two months. The appliance will burn 6,000 lbs. of S per day.

Hand-fed burners of the first type are now completely obsolete, and will not be described; some of them employ secondary air to ensure the complete combustion of the sulphur. The writer has found this very satisfactory if such air be preheated.

Of the second type of furnace may be mentioned the Sachsenberg burner (Fig. 2). It is particularly suitable for the production of SO_2 in small quantities, and which is required to be as free as possible from SO_3 , as is required for bleaching, in the manufacture of glue, in the refining of sugar, etc.

In starting up sulphur is placed in and ignited by inserting a red-hot iron bar through the hole in the body (which, when working, is closed by a plug). The hopper c and funnel e are filled with sulphur, which melts and forms a liquid seal in f. Air is drawn through a, and the SO₂ passes out through b. The upper portions of the body and funnel are water-cooled. Compressed air may be introduced into b to burn any sulphur sublimed there. The slight coating of sulphur on the pipes, etc., is found to effectually preserve them. A burner of this type, measuring only 8 ft. by 3 ft., will burn no less than one ton of sulphur per twenty-four hours.

Humphrey's Sulphur Burner is described on p. 255. See also p. 254 for a complete plant for SO₂ manufacture.

Burners for the Combustion of Sulphuretted Hydrogen are exceedingly simple to construct once the elementary principles underlying them have been grasped. In the case of the "waste" gas from ammonia-saturators, it is of the utmost importance that the gas should be well cooled, and that as much as possible of the organic matter—largely naphthaline vapour, ammonia, and cyanogen—should be removed. The gas should be burned in a series of Bunsen burners, care being taken in the design of the burner to ensure that thorough heating of the gases takes place before reaching the furnace. The most satisfactory furnaces are provided with secondary air and chequer-work partitions of refractory brick. The presence of iron oxide facilitates the combustion, which has to be started by coal-gas, coke, spent oxide, or some other artificial means. The gas from the Chance recovery process can be burned, if desired, in the same type of furnace (see Fig. 12). A large excess of heat is evolved, which may be profitably employed for the concentration of acid or for other purposes.

Flues, Dust-Removal Appliances, Burner-Pipes, and Draught-Pipes

The **Flues** for conveying the burner-gas are usually constructed of a special brick and lined with an acid-proof fire-brick; there is no reason why they should not be built of reinforced concrete. Ordinary brick is quite good enough, provided the flues are kept dry. Flues should be square, and as great a cross section as convenient; they should be short, so as to avoid condensation, and without bends; such bends as may be inevitable should be gradual. The roof is usually formed of a special tile, such as those manufactured by Messrs Davison of Buckley.

It is most important to protect flues from the weather. It is even a good thing to jacket them with sand. The whole structure should be well provided with buck-stays, tie-rods, and angle-iron clamps, so that it may not become unduly distorted. These should not be buried in brickwork where they can corrode, but be easily accessible, so that they can be readily inspected, tarred, repaired, or replaced. The base of the flue is usually carried on cast-iron plates, and these in turn by steel stanchions or cast-iron columns.

Dust is difficult to remove from hot gas. It is found that horizontal surfaces, and a velocity not exceeding 5 ft. per sec., are best for the deposition of the dust. A properly designed stagnation chamber is all that is needed in many instances; to be really effective, however, its cross section has to be very large.

One of the most effective appliances for catching dust consists of a series of horizontal or vertical wires stretched between frames; each flue is provided with a pair of dust-catchers, either one of which can be used while the other is being cleared, either by means of shaking, an air or steam blast, or other means. Dust can be satisfactorily removed by **centrifugation**, but a high velocity is necessary for this. The appliance may be constructed of suitable cast iron; now that it is possible to use efficient fans for driving the gases between the burners and the first tower or catalyser, as the case may be, there is every reason why this method of dust removal should be used.

For removing the last traces of dust, which is necessary in some contact processes, a series of asbestos mats with a filtering layer of slag or wood wool, or other suitable material, is used with complete success.

The removal of dust is a big undertaking, particularly in the recovery of smelter smoke. As explained elsewhere, the type of furnace usually employed is some kind of mechanical roaster or blast furnace; in the latter very large quantities of dust are produced. This dust is sometimes settled in long flues, as at Freiburg and in Tennessee.

An interesting process for the precipitation of dust is the **Cottrell electrical method**. This works on the same principle as Sir O. Lodge's fog-dispelling device. It is also used for collecting sulphuric acid and other mists. The apparatus is said to be efficient and the cost of working low.

Carbon tubes are now used and the entering gases may be as high as 700° C. (see *Chem. Met. Eng.*, 1930, 37, 676).

Burner-Pipes, leading from burner to flue, and **Draught-Pipes**, leading from dust chamber or flue to first tower, are usually constructed of cast iron.

The new acid-resisting cast iron is quite suitable, though large castings (48 in. diameter) require careful handling and are expensive and easily cracked; the pipes have cored or slotted bolt-holes

provided for the flanges, which are not machined. Fire-proof earthenware and volvic stone have been used with some success, and also cast iron lined with acid-proof refractory material. The difficulties inherent to the use of cast iron are frequently overcome by making all these connections in brick with the shortest connection possible between flue and tower. The two chief difficulties which have to be provided against are expansion and corrosion due to the gas cooling down too far. With proper and thoughtful design, all these troubles can be entirely eliminated.

The Burner-Gas.—The burner-gas produced in these ways usually contains some SO_3 , which is presumably formed catalytically, the dust or brick acting as a catalyst.

The gases obtained by burning good iron pyrites contains, as a rule, 7-8 per cent. by volume SO_2 , 0.1 per cent. SO_3 , 10 per cent. O, and 82 per cent. N.

When pure sulphur is burnt the evolved gases can contain as much as 10 per cent. SO_2 . The gases evolved from the roasting of zinc blende contain, usually, 5-7.5 per cent. SO_2 .

A high oxygen content is essential for success both for the chamber process

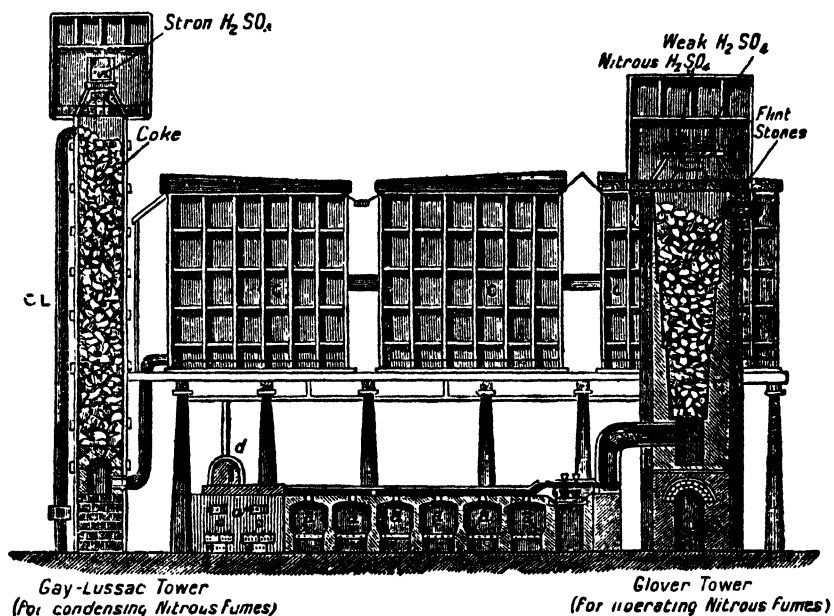


FIG. 13.—Three-Chamber Sulphuric Acid Plant (Diagrammatic).

as well as for the contact process. 6-11 volumes of oxygen is necessary, the exact amount most favourable to oxidation being determined by actual practice.

Analysis.—The amount of $\text{SO}_2 + \text{SO}_3$ in the gases is usually determined by absorbing in standard NaOH and titration with standard acid, using phenolphthalein as indicator. The amount of SO_2 is then estimated by titrating with standard iodine solution.

The oxygen in the gaseous mixture is usually estimated by absorption with pyrogallol or other suitable reagent.

The SO_2 produced by any of the foregoing methods is now converted into sulphuric acid, either by the **Lead Chamber Process** or by the **Contact Process**. We will discuss each in turn.

The Lead Chamber Process for Sulphuric Acid Manufacture

Fig. 13 shows a diagrammatic drawing of a typical three-chamber sulphuric acid plant. Fig. 14 is another drawing showing the general view of the apparatus.

Fig. 15 shows a small two-chamber plant. The gases (consisting of SO_2 and atmospheric O and N) from the pyrites, burners, or roasting furnaces *aa* (Fig. 13), after depositing dust and arsenic oxide in wide flues (and dust chambers—not

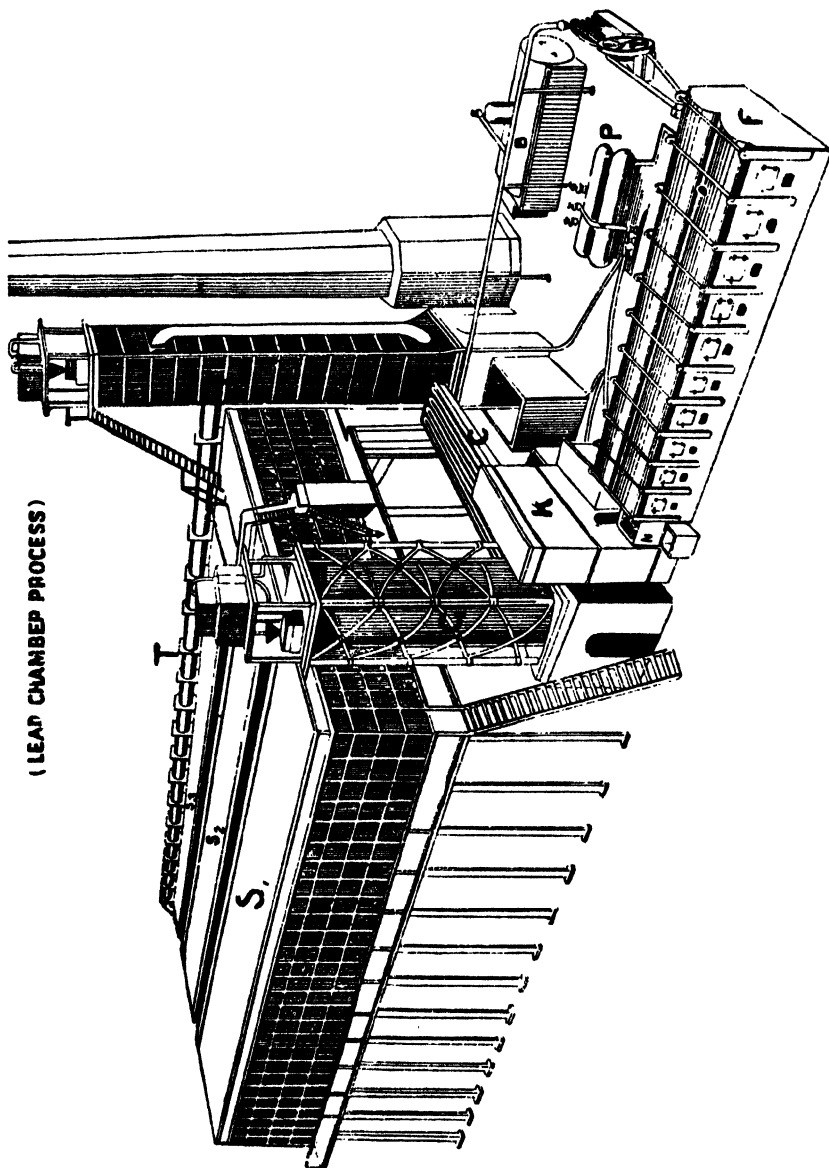
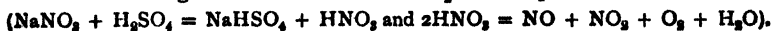
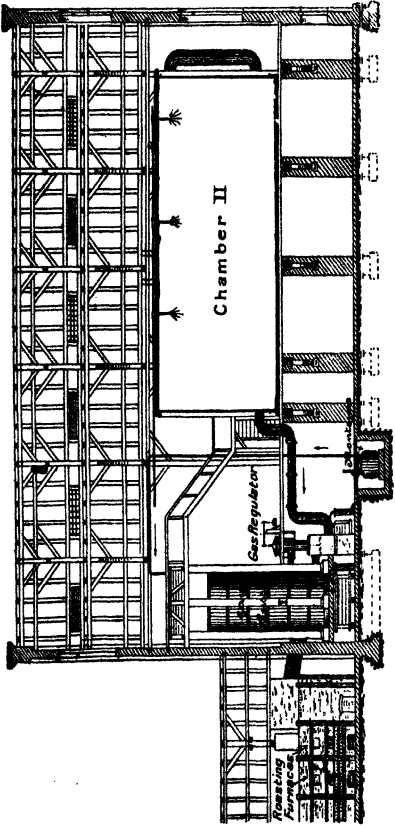


FIG. 14.—Three-Chamber Sulphuric Acid Plant. General View. (See p. 224.)
(Taken from the Series of "Chemical Lecture" Diagrams by Geoffrey Martin, by kind permission of Messrs Sampson Low, Marston & Co.)

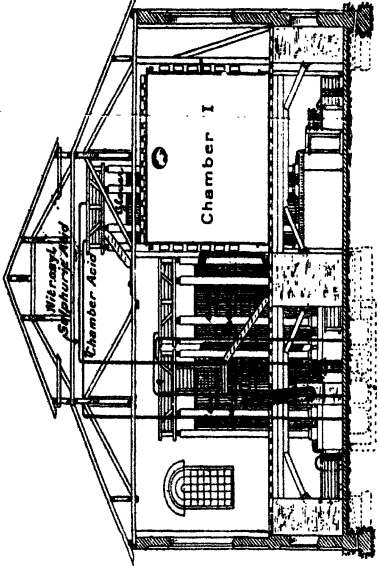
shown in drawing), pass at a temperature of about 300° from pyrites (lower in the case of zinc blende) over nitre pots *bb*, containing sodium nitrate (Chile saltpetre) and concentrated sulphuric acid. These pots evolve the oxides of nitrogen which are essential in causing the oxidation of the SO_2 into sulphuric acid—



Longitudinal Section Through A.A.



Cross Section Thro' B.B.



Scale.



Ground Plan.

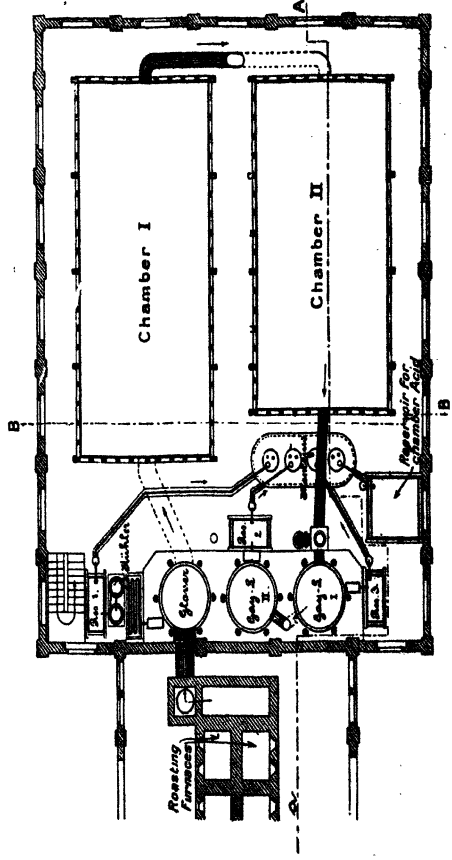


FIG. 15.—Two-Chamber Sulphuric Acid Plant.

The mixture of gases next pass up a **Glover tower G** (described below), then into a series of **large leaden chambers CCC** (Fig. 13)—often having a total capacity of 150,000 cub. ft.—where the sulphur dioxide is oxidised to sulphuric acid by means of the oxides of nitrogen and atmospheric oxygen, the water necessary for that purpose being supplied by spraying into the chamber extremely finely divided cold water (jets of steam are not now used).

The following action takes place :—



The oxidation takes place not only in the chambers, but even far more intensely (as we will presently see) in the **Glover tower** as well.

This action, which probably proceeds naturally of itself to some extent, is enormously **accelerated** by the catalytic action of the oxides of nitrogen present in the chamber.

The exact mechanism of the action of the oxides of nitrogen in bringing this about, however, is not known. In some way they act as carriers of oxygen, passing on oxygen to SO_2 , becoming reduced, and again absorbing some of the excess of oxygen present.

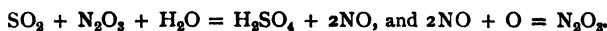
According to Péligot (1844), nitrogen peroxide (NO_2) oxidises the SO_2 , and is itself reduced to nitric oxide (NO) thus :—



Next the nitric oxide (NO) at once unites with the atmospheric oxygen present in the chambers to re-form nitrogen peroxide, thus :—



The nitrogen peroxide thus formed once more reoxidises more SO_2 , and so the cycle commences anew. According to Berzelius (1830) and Weber (1866), it is nitrogen trioxide (N_2O_3) which is the active agent :—



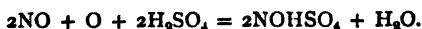
Divers, Raschig, and Lunge have set up rival theories based on the existence of real or (more probably) imaginary "intermediate" compounds. The main authorities contradict each other on the subject, so that an account of these theories is best omitted. The reader will find a full account in Lunge's "Sulphuric Acid and Alkali" (1913 edition), but for full information reference should be made to the original papers mentioned at the beginning of this article.

Whatever be the mechanism of the action, it is certain that a relatively small supply of nitric oxide in the presence of a continuous supply of sulphur dioxide, air, or steam is capable of converting this mixture into sulphuric acid.

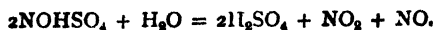
The reaction is much facilitated by the use of ultra-violet light, and serious attempts have been made and patents taken out to intensify the process (that is, to reduce the space required per unit of sulphur burned per unit of time) by the use of mercury-vapour quartz lamps, which are extremely rich in this type of radiation.

The sulphuric acid condenses on the floor of the leaden chambers, and can be drawn off as "**Chamber acid**" of $50^\circ\text{--}55^\circ$ B \acute{e} . ($105^\circ\text{--}122^\circ$ Tw. = 62.70 per cent. H_2SO_4). As we shall immediately see, much of it is pumped up the Glover tower and sent down this, and sold as "**Glover acid**" of 60° B \acute{e} . (= 141° Tw. = 78 per cent. H_2SO_4).

The waste gases in the chambers are highly charged with oxides of nitrogen. These are recovered by passing the gases up a **Gay-Lussac tower, GL** (Fig. 13), packed with coke, down which concentrated sulphuric acid is trickling from a tank placed at the top. The concentrated sulphuric acid absorbs the nitrous fumes, forming nitrosyl sulphate, which remains dissolved in excess of sulphuric acid :—



In order to recover the oxides of nitrogen from this compound, the "nitrosyl" sulphuric acid is forced up to a tank placed at the top of the **Glover tower, G**, filled with flint stones, and communicating at the top directly with the first leaden chamber of the series. Another tank at the top of the same tower is filled with the comparatively weak chamber acid. The two liquids flowing down the tower are made to mix in the upper part of the column of flint stones, and the water in the weaker acid decomposes the "nitrosyl-sulphuric acid" dissolved in the more concentrated acid, thus :—



The nitrogen oxides thus liberated are swept back by the torrent of hot ($300^{\circ}\text{C}.$) ascending sulphurous gases from the pyrites burners, and pass once more into the leaden chambers, whereas the sulphuric acid descending the Glover towers, freed from nitrogen compounds, runs off in a boiling hot concentrated state at the bottom of the tower as "Glover" acid.

The uses of the **Glover tower** are: (1) To recover the nitrous fumes from the Gay-Lussac tower. (2) To cool the hot gases from the burners (which enter at about $300^{\circ}\text{C}.$). (3) To help concentrate the chamber acid passing down the tower—the heat of the hot ascending gases from the burners being very effective in doing this—the Glover acid escaping at the bottom of the tower at about 60°Bé. (141°Tw.). The chamber acid is only allowed to concentrate to about $50^{\circ}\text{--}55^{\circ}\text{Bé.}$ ($105^{\circ}\text{--}122^{\circ}\text{Tw.}$), a stronger acid than this causing the lead of the chambers to be eaten away rapidly. (4) The sulphur dioxide is very rapidly oxidised to sulphuric acid in the Glover tower—the action being here even more intense than in the chambers themselves (*at least* ten times the amount of sulphuric acid is produced per unit of space in the Glover than is produced in an equal volume of chamber space). Consequently the "Glover" acid, running out at the bottom of the tower, contains a considerable amount of sulphuric acid produced directly by the oxidation of the SO_2 entering the tower from the burners. (5) In many works nitric acid is directly introduced into the sulphuric acid running down the towers, this process dispensing with the nitre pots previously mentioned (see also pp. 222, 233, 234).

Fig. 14 gives a very good idea of the ordinary old-fashioned three-chamber process. F is a row of pyrites burners. The sulphurous gases from these pass over the nitre pots placed at N, then (bearing with them oxides of nitrogen) through a dust-depositing chamber K into the Glover tower G, where more oxides of nitrogen are liberated. From the Glover tower G the gases pass successively into the three separate leaden chambers, s_1 , s_2 , s_3 , thence by the tube T into the Gay-Lussac tower L, where the oxides of nitrogen are removed.

B is a boiler for introducing jets of steam into the leaden chambers (in modern practice finely divided cold water sprays are used instead of steam jets). The boiler also works the compressed air pumps P, which serve to force the acid liquids continuously up to the top of the Glover and Gay-Lussac towers. C is a series of coolers for cooling the hot "Glover" acid running out at the bottom of the Glover into a tank. A similar tank receives the acid from the Gay-Lussac towers.

Fig. 15 gives details of a small modern two-chamber plant designed by Hartmann of Wiesbaden, which is capable of producing annually about 2,500 tons of sulphuric acid. The water is introduced as a fine spray at the top of the chambers. The arrangements for storing the acids, pumping, etc., are also clearly indicated. The whole system is roofed over with a wood or iron construction. Notice that the single Gay-Lussac tower of the old plant is here replaced by two.

General Remarks on the Chamber Process.—The reactions which go on in the chambers, leading to the ultimate condensation of "chamber" sulphuric acid out of a mixture of reacting gases and mist, can be carried out to completion, although this requires a certain time. The acceleration of the process by various means is essential in modern practice.

The chief recent improvements for effecting this are the better design of the chambers, especially the Moritz system, the introduction of fans which cause a thorough mixing of the gases, the introduction of water or dilute acid spray, and the introduction of reaction towers (such as have culminated in the Opl and Griesheim tower systems, p. 239), and the invention of efficient acid pumps. All these have combined to greatly increase the efficiency of the process, which is now better able than ever to compete with the contact process.

Perhaps one of the most difficult problems is to cause the complete oxidisation of the SO_2 , which in the last chamber becomes excessively dilute. Also for the process to work properly it is absolutely essential that plenty of nitric oxides (usually introduced as "nitrosyl sulphuric acid" from the Gay-Lussac tower, but also directly as nitric acid in many continental works) should be present in the reacting gases. Any want of nitric acid causes not only a loss of unattacked SO_2 gas out of the chambers into the air, but also a loss of nitrogen, as unoxidised nitric oxide (NO) finally escapes out of the system, not being absorbed as such in the Gay-Lussac tower. However, excess of nitric acid causes the action to almost complete itself in the first chamber instead of being distributed through three chambers. The intensity of the action and amount of sulphuric acid

produced is thus greatly increased, but unfortunately the lead of the chambers is more rapidly attacked. In fact, under the now more intensive conditions of work prevailing at the present time, the life of a set of lead chambers has been reduced from twenty years to fifteen years, and even less.

It is essential that the gases escaping into the air after passing through the system shall contain some 5-7 per cent. by volume of free O—otherwise the nitric oxide (NO) will not be oxidised to NO₂ or N₂O₃, and so will pass right through the Gay-Lussac towers unabsorbed, and escape into the air, thus occasioning a loss of valuable nitrogen. Any deficiency in the design or number of the Gay-Lussac towers will also yield a loss of nitrogen.

Indeed it is the loss of the expensive nitrogen which causes much of the working costs. Part of this loss seems unavoidable, possibly some nitrogen escaping unabsorbed into the air as nitrogen monoxide (N₂O). Enlarging the Gay-Lussac towers and effective packing (see below) have reduced very considerably the amount of this waste of nitrogen, yet even now it is quite common to consume 1½-3 kilos of sodium nitrate to every 100 kg. of sulphur burned. This works out as 0.5-1 kg. of sodium nitrate to every 100 kg. of concentrated sulphuric acid produced, amounting to 4-8 per cent. of the selling price of the latter.

However, the recent introduction of cheap processes for manufacturing nitric acid (see under raw materials, p. 210, also under nitric acid in this Volume) may lower very considerably this expense.

The oxidation of sulphur dioxide (SO₂) into sulphuric acid, thus:—



proceeds with the development of heat. Thus to produce 1 kg. of sulphuric acid with the aid of water sprays there is developed some 600-700 calories. When jets of steam (as in the old process) are employed some 800-900 calories are developed.

It is hence easy to understand that the introduction of water spray instead of steam (by allowing the chambers to be kept below 90° C., and thus saving the lead from corrosion and favouring the condensation of the acid) has effected much saving by allowing a more intensive production to take place per cubic yard of chamber space. The last chamber of the series is usually kept about 40° C., and sometimes means are taken to artificially cool further the gases escaping from this into the Gay-Lussac towers, because the nitric oxides are far better absorbed at a low temperature.

Water is necessary to form sulphuric acid (as is obvious from the above equation). Much of this water is yielded in the form of steam from the Glover tower, where the hot furnace gases, meeting the diluted chamber acids, concentrate it very considerably, the steam thus evolved passing with the uprising gases into the chambers. This water, however, is not sufficient for the production of the 75 per cent. acid of the chambers, and so more has to be supplied in the form of water sprays.

However, the supply of water has to be very carefully regulated, so that the chamber acid of the first chamber never exceeds 55° B \acute{e} ., while the acid in the last chamber must not be less than 45° B \acute{e} .. Acids stronger than this cause the solution of oxides of nitrogen in the form of nitrosyl sulphuric acid (see under Gay-Lussac tower, above), and rapidly attack the lead, whereas acids weaker than these limits cause the oxides of nitrogen to dissolve as nitric acid and pass out with the chamber acid.

The Yield of Sulphuric Acid should work out, when operations are properly conducted, about 290-296 parts of sulphuric acid (100 per cent. H₂SO₄) per 100 parts of sulphur burned as pyrites.

This corresponds to a yield of 94-96 per cent. of the theoretically possible. Pyrites poor in sulphur, zinc blende, and similar materials naturally do not yield anything like this amount of sulphuric acid on the amount of sulphur burned. A certain loss of sulphuric acid occurs by part escaping as a mist or cloud with the exit gases of the system. The amount of sodium nitrate consumed is 0.5-1 per cent. of the weight of concentrated sulphuric acid produced—a loss which seems unavoidable (see above).

Constructional Details of the Lead Chambers

The chambers are constructed of antimony-free soft lead sheet, about 3 mm. thick. The joints, etc., are all autogenously welded by means of the oxy-hydrogen blow-pipe flame. The bottom plates have their edges bent up so as to form a flat

cup-like receptacle for the chamber acid. The sides, tops, and bottoms are supported on wooden beams—usually of pitch pine—by means of straps of lead fused on to the lead forming the chambers by the oxy-hydrogen flame, and nailed on to the beams at the other end. The roof and side walls, thus suspended by leaden straps from the surrounding beams, dip like a bell into the lower cup-like dish of the base, the chamber acid itself thus forming the sealing liquid between the interior of the chamber and the outside air. Two to four chambers are usually built of oblong shape as indicated in our illustrations. The greater the number of chambers the higher the cost of construction, but also the higher the yield of acid per unit volume. Wide leaden tubes connect the chambers together, and also connect the chambers with the Glover and Gay-Lussac towers. The cold water is sprayed in above through a series of “atomisers” (steam is not now used), while thermometers are arranged in the walls right round the chambers so that the temperature conditions inside may be checked. The density of the chamber acid is ascertained by making compartments in the walls of the chambers, whereby the acid condensing on the sides is, by an opening, allowed to come into contact with hydrometers, the readings of which give at a glance the strength of the chamber acid. Glass windows are set in the uniting lead pipes, whereby the colour of the chamber gases can be observed. From time to time the chamber acid is run off through leaden pipes into leaden reservoirs.

Formerly it was considered a good yield when 1 cub. m. of chamber space produced per twenty-four hours some 4.4.5 kilos of chamber acid. However, at the present time, methods of intensive work are almost universally practised, whereby it is not uncommon to obtain as much as 10 kilos of chamber acid per cubic metre chamber space per twenty-four hours. In order to increase the yield sometimes intermediate “**reaction towers**” are placed between the successive chambers. These are filled with acid-proof plates or stones down which dilute acid is run, and in them considerably more acid is formed than in an equal volume of empty chamber space, since the larger the condensing surface the greater the yield of acid. However, these intermediate towers do not seem to have been very widely introduced (see pp. 229, 230 for further details). The increase of condensing surface by suspending leaden plates inside the chambers has been tried and abandoned, since the lead is rapidly eaten away. The main method employed for increasing the yield is the introduction of an increased quantity of nitric acid (usually run down the Glover tower, thus doing away with nitre pots), so that plenty of oxides of nitrogen are liberated and circulated inside the chambers, thus oxidising a greater amount of SO_2 per unit time. Also the gases in the chambers are more thoroughly mixed by the introduction of fans which force the gases from the pyrites burners through the whole system without causing undue pressure at any one point. Before the introduction of these ventilating fans the only draught obtainable was from the chimney at the exit and from the hot gases rising from the furnaces.

As in this “intensive working” considerable heat is involved (see p. 225), this is eliminated by making the chambers narrower and longer than formerly, as they cool more rapidly. Also the replacement of the steam jets by cold water spray helps considerably (see pp. 225, 233). Nevertheless, the life of the chambers has sunk from twenty years to under fifteen years.

Within the last few years very considerable advances have been made in the construction of leaden chambers, whereby their life is greatly prolonged. The principal credit of these new methods of construction seems to be due to **R. Moritz**. In the old system of chamber construction no proper arrangement for allowing for the expansion of the lead was made, and the supporting timbers soon warped under the heat. The lead, therefore, soon cracked at points of strain, and corrosion became very considerable at certain points. Moreover, radiation was much hindered. Moritz, however, obviates these and other disadvantages by enclosing the chamber in a strong skeleton built of structural iron or steel, from which the chamber is suspended by overhead beams. The structure may be enclosed by a very light brick lattice structure and tile roof, light being admitted by glass panels and tiles.

Moritz Chambers are now being constructed of cylindrical shape, almost like empty round towers. The precise method of suspending the chamber is exceedingly ingenious, and is specially designed to obviate any danger arising from expansion or contraction, and to secure a maximum heat loss by radiation.

In one type the top of the chamber was made semi-oval instead of flat, the objects being to prevent the accumulation of dust, render repair more easy and less necessary, and to assure more perfect circulation of the air outside and of the gases inside its upper surface.

The lead floor rests upon an under floor of iron plate, and this in turn is supported by brick

columns. The upturned edge of the floor consists of iron plate, bent underneath to a distance of 10 in. This is to ensure the most rapid cooling at the weakest point in the construction of a chamber, where corrosion is most pronounced and repairs are exceedingly difficult. The same principles of construction are employed for the necessary towers. All corners are avoided as much as possible.

The cost of construction at Kratzwieck was about 33 per cent. more than by the old system; it has now been reduced to under 25 per cent. The yield is about 7 kilos of chamber acid at 50° B. per cubic metre, the consumption of nitric acid being some half a kilo per 100 kilos of chamber acid.

It was anticipated that the increased capital cost would be more than compensated by the increased production and decreased nitre consumption, saving in the amount and difficulty of executing repairs, increased life of the lead and economy of costs of reconstruction, when eventually necessary. Subsequent experience has tended to confirm these opinions.

Many modified forms of chambers have been described and even extensively erected. Thus in Meyer's Tangential Chambers (*Zeit. angew. Chem.*, 1899, 159, 655), a thorough and efficient mixing of the gases is achieved by making the chambers circular in horizontal section (a number of these being arranged in series), and causing the gases to enter the side of the first chamber tangentially, and leave by a pipe through the centre of the bottom, passing thence to the second chamber, which is also entered at a tangent, and so on throughout the series. The water sprays are arranged so as to aid the circulation and mixing of the gases, which are thus compelled to take a spiral course through each chamber, thus effecting a thorough mixing and resulting in a larger output per unit of chamber space.

Another system which merits attention is the "Falding Chamber." The Falding Chamber is one which is becoming popular in the United States of America. Its essential feature is its height, the theory being that the gases which have reacted and cooled sink to the bottom, whence they can be removed to the next chamber. This practice of increasing the height is by no means confined to Falding, it having been the tendency among intelligent manufacturers, particularly on the Continent of Europe, for many years. The advantages claimed are a saving in lead or an increase of output for the same cubic capacity, only 6-7 cub. ft. of space being required, so it is stated, per pound of sulphur burned per twenty-four hours.

The Brown Tower Chamber seems to represent a considerable advance in chamber design. It is 16 ft. in diameter and 35 ft. high, and is guaranteed to be workable at a production of 4 cub. ft. per pound of sulphur burned per twenty-four hours. The nitre consumption under these conditions of work is not stated, but at a lower output—also not stated—the nitre consumption is guaranteed not to exceed 2 per cent. on the sulphur burned. Large sets of these chambers are being erected in this country. Fig. 16 shows a set of six, together with Glover and Gay-Lussac towers. The chambers could probably be made larger with advantage.

The Gaillard-Parrish system is extending (see *Chem. Age*, 1929, 21, 612; 1930, 23, 606).

The Gay-Lussac Towers.—In modern factories nearly always two are used. They are cylindrical in shape, about 10 m. high, and 3 m. in diameter. They are usually built of lead and filled with coke.

Lunge has proved that coke is slightly acted on by the oxides of nitrogen, and so in some recent practice the coke has been replaced by other acid-proof packing. The gases from the last chamber, which are practically free from SO₂, but rich in oxides of nitrogen, enter at the base of the tower and there meet with a descending stream of 60° Glover acid. The acid is sprayed over the packing of the tower uniformly either by a rotating leaden "sparger" or by means of plates of lead or earthenware with zigzag edges.

The nitrous fumes are here absorbed with the formation of nitrosyl sulphuric acid, as explained on p. 223.

The Glover Towers, being exposed at their base to a very considerable temperature (as the hot gases from the pyrites furnaces enter them with an initial temperature of 300° C.), are now usually built of closely-fitting acid-proof earthenware, shown at *a* in Fig. 17 (which gives two sections at right angles to each other). The section may be round or circular, and they are fitted together without mortar, by means of lead rings (shown at *b*, Fig. 17) or silicate cement. Towers are now being constructed of rings of **volvic lava** (a compact stone known to geologists as "Domite," and found in the Auvergne district in France).

The packing here employed may be flints, but in modern practice plates or hollow cylinders of acid-resisting earthenware are employed (Fig. 18). Oscar Guttman employs fused alumina, which is very acid-resistant. This packing must distribute the downflowing acid uniformly, but special care must be taken that too great a resistance is not offered to the uprising gases (see p. 231).

In the **Niedenführ-Rohrmann** system of packing (Fig. 17) the stones are packed together, as shown in 1, 2, 3, 4, each stone being provided with a gutter *r* and an opening *a*. The stones are arranged in the towers in horizontal layers, as seen in Fig. 17. For the general theory of packing towers, see p. 229.

The gases from the furnace enter at *hi* (Fig. 17), and pass upwards through the layer of stoneware. The entering acids flow uniformly down the tower out of

the two distributing tanks *tt*, the very hot Glover acid escaping through *pq* at the base. The function of the Glover tower has been discussed on p. 224.

Recently systems of two Glover towers have been built, the first one only being kept very hot so as to concentrate the acid pouring down it, while the second one serves to denitrate the acid. The second tower, however, must be kept fairly hot if it is to work efficiently.

Cooling the Glover Acid.—The Glover acid issuing from the Glover tower is, of course,

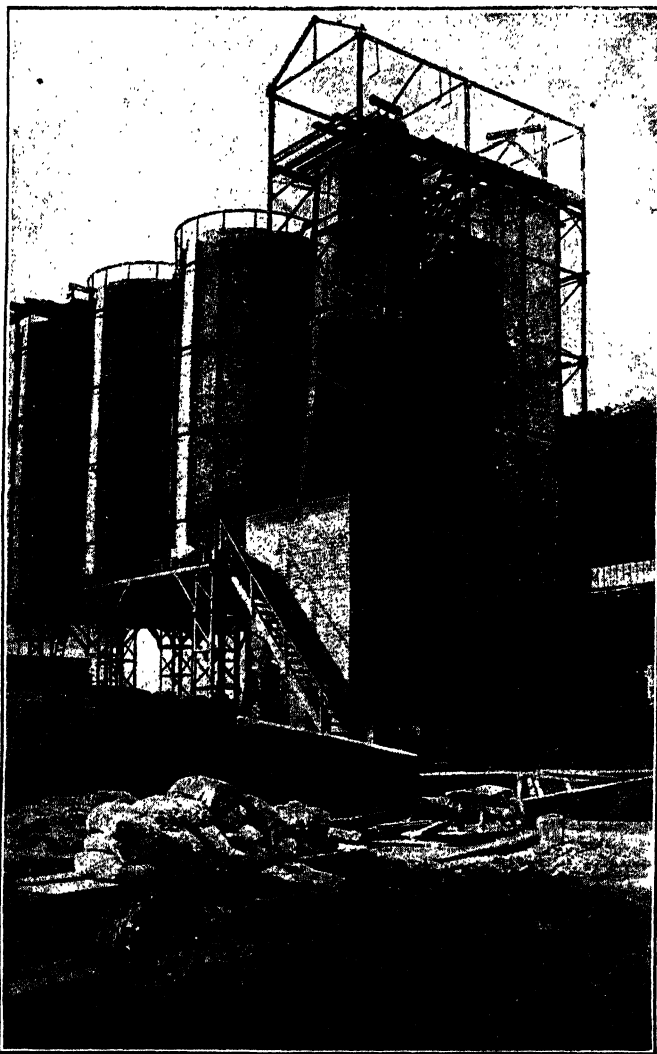


FIG. 16.—The Brown Tower Chamber for Sulphuric Acid. (See p. 227.)

itself exceedingly hot, being practically at its boiling point of 120° - 160° C. ; it, therefore, has to be cooled. The most efficient system of cooling is to start the operation by passing the acid through a water-jacketed, fused silica vessel, and to finish it in a cooler made of chemical lead.

The object of this cooling by stages is to check the considerable corrosion of the lead by the intensely hot acid. Unless the tower packing be really acid-proof, and the burner-gas well freed from dust, it may frequently happen that solids will settle or crystallise out in the coolers ; in this case they should be designed so as to admit of easy and rapid cleaning while at work if necessary.

Other forms of coolers are frequently employed, such as coils of pipe, etc., but they are not as convenient nor as efficient as the method indicated.

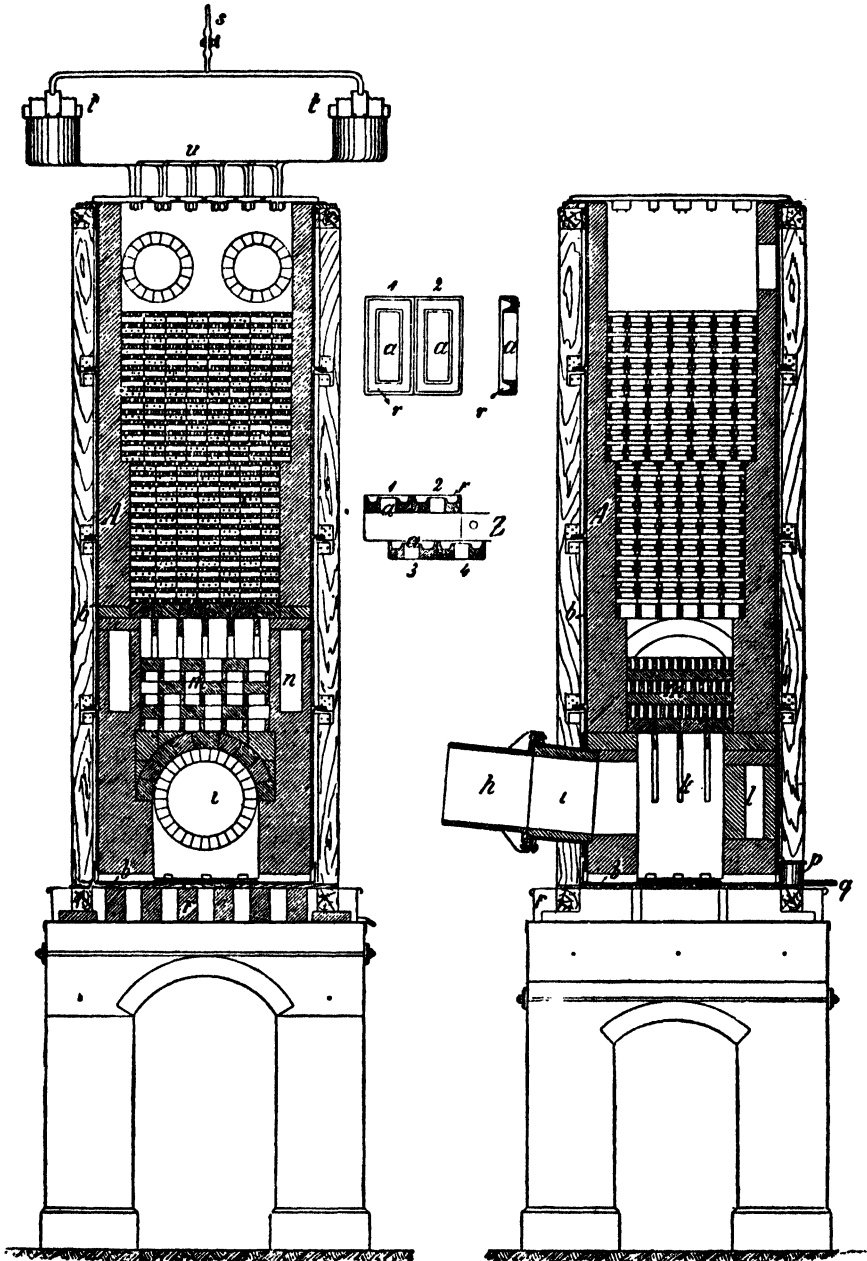


FIG. 17.—Glover Towers. Employing the Niederführ-Rohrman System of Packing. The Two Vertical Sections above shown are cut at Right Angles to each other. (See p. 227.)

General Theory of Towers.—The employment of towers in almost any process usually involves the principle of the counter-current. By this is meant that a substance "a" can interact

either chemically or physically with a substance "b" in such a way as to take from or give to it a form of energy or matter; the avidity with which this interaction takes place, and the extent to which it will proceed, depends, other things being equal, upon the amount of energy or matter which has already been interchanged, and is approximately inversely proportional thereto. If we can so design our interchanger that the outgoing nearly saturated "a" meets with the incoming "b," the maximum difference of what the physicists term "potential" will be always maintained, and that, **by sufficiently augmenting the time of contact, we can increase the percentage of our exchange as much as we please.** In the case of chemical reactions it can be made practically perfect. Interesting examples of the counter-current are the expansion steam turbine, the mechanical calciner, the heat "interchanger," continuous stills, the extraction of sugar and other soluble materials. Continuous work is more efficient than if the interaction be conducted in a series of steps; or, if in a series of steps, it will be more efficient the greater be the number of those steps.

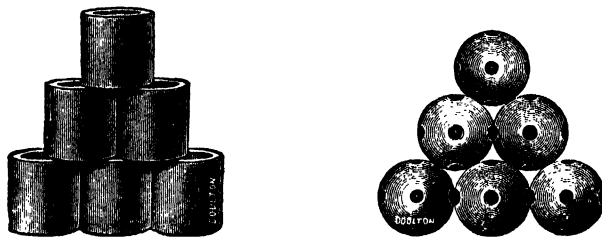


FIG. 18.—Packing for Glover Towers.

The amount of interaction depends upon the **relative velocity** of the two counter-currents, and upon their degree of intimacy, and upon the rapid removal of the material at the surface, where the interaction takes place; the efficiency is greatest when the velocities of the two counter-currents are equal and opposite.

If these essential principles are borne in mind, it is easy to decide whether or no a tower packing is likely to be efficient (see next Section).

Lunge-Rohrmann Reaction Towers.—It had been found that the very slow gaseous movement going on in big leaden chambers caused a partial separation of the component gases and mists, the heavy acid mist sinking downwards, while the lighter nitrous gases rose to the top of the chamber, and caused severe corrosion of

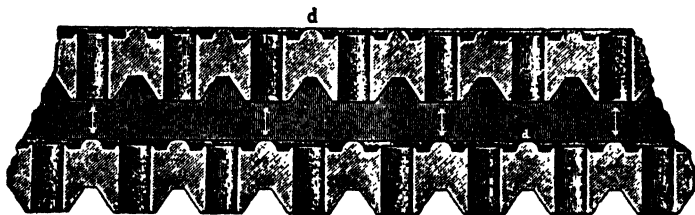


FIG. 19.—Earthenware Plates for Lunge's Tower.

the lead. Lunge and Rohrmann, therefore, placed reaction towers between the leaden chambers in order to cause a more thorough mixing of the chamber gases, and so increase the yield of sulphuric acid.

Owing to the probable replacement of most chamber systems by tower systems, the value of the intermediate tower as an adjunct to a set of chambers has somewhat depreciated. They were very popular on the Continent of Europe. Their function was a double one,—firstly, to improve the intimacy of contact, and effect thorough mixing of the gases and finely divided vesicles of liquid in suspension; and secondly, to arrest and cause the deposition of such of this acid mist as was in a fit condition to be removed.

Reaction towers are usually made of acid-proof earthenware, consisting of a series of plates (see Figs. 20, 21) or sections in which the liquid is brought into very intimate contact with the gas. The towers are either fed with chamber or other

acid, depending upon their position, or not fed at all, sufficient acid mist being arrested to maintain a sliding film of liquid on the interacting surface.

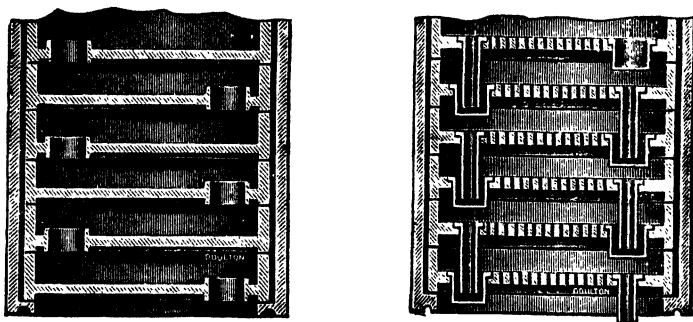
As regards the **packing** in them the following points must be borne in mind, which also apply to the **Glover Tower, Gay-Lussac**, and other towers (see preceding article for them).

(1) The packing must be really acid-resisting; (2) the cost should not be too high; (3) it should be homogeneous, otherwise the efficiency must suffer; (4) it should expose the maximum surface possible; (5) the path of the counter-current should be as great as possible; (6) the relative velocity should be as small as possible; (7) it should be possible to clean it by washing; (8) it should not be too heavy.

It is evident from the above that the packing must not be too closely set together, otherwise the amount of free space will be so small as to cause the velocity of the gas current to be too high, throwing a back-pressure in addition to increasing the velocity; it must not contain large partially stagnant pools of liquid nor pockets of gas.

There are many varieties of tower packing (see p. 227), which more or less fulfil these conditions, those of Messrs Oscar Guttman & Sons, of the Huncoat and Buckley Brick and Tile Companies, being good. Few of them are really acid-proof, and have to be replaced after a time. They are usually made of semi-vitrified clay, though those of Messrs Guttman are made of fused alumina, which is much more resistant to the corrosive action of acids. The use of strips of glass is successfully employed by one inventor.

If properly packed and properly graded, flints and broken quartzite form excellent packing materials for towers, their chief disadvantage being their weight. The lateral thrust of a considerable height has to be taken by means of a reinforcing lateral iron band, or by other means;



FIGS. 20 and 21.—Plates for Acid Towers.

moreover, the ratio of surface to mass is much less than in properly designed packings. The finest quartzite for the purpose comes from Cherbourg.

During recent years an interaction tower has been introduced which is entirely devoid of packing. The liquid with which it is fed is sprayed in at the top, and falls as a fine rain to the base, where it is collected and removed, the uprising gases being distributed through the specially designed floor. This type of tower has been used for both Glover, Gay-Lussac, and concentrating functions.

Method of Inducing Draught.—Fans are now usually employed, made of regulus metal, special cast iron, or acid-proof stoneware. Usually one fan is placed between the burner and the Glover, and another between the two Gay-Lussac towers. They are cased in lead, iron, volvic stone, or acid-proof brick.

Pumping the Acid.—Usually the acid is pumped to the top of the Gay-Lussac and Glover towers by automatic montejus, driven by compressed air.

Very efficient apparatus of this sort have been put on the market by Kestner. Fig. 22 shows a typical **Kestner acid elevator**. The liquid contained in the feed tank A runs into B.

As soon as B is full the acid operates the part x of the float which, by means of the rod c, closes the air exhaust valve and opens the compressed air valve. The liquid is discharged through the pipe T, and the air, after delivering the liquid, causes a fall of pressure in the apparatus, which operates the valves in the opposite direction. The cycle is then repeated.

Schütze's automatic elevator is also very efficient. It is shown in Fig. 23.

The liquid flows by gravitation through the check-valve *A* into the elevator. During this period the dead weight of the double float *C* (consisting of two rigidly connected balls *B* and *B*₁) acts on the lever *D* in such a manner that the compressed air (or steam) inlet *E* is kept closed, whilst the outlet valve *F* is open, allowing the air displaced by the liquid to escape.

When the liquid reaches the upper part of *B*, the float rises, whereby air outlet *F* is closed, and the air inlet valve *E* opened. The compressed air then presses upon the surface of the liquid, which is forced through delivery pipe *G*. When the surface of the liquid reaches the lower ball *B*, the float sinks, closing the air inlet valve. The compressed air expands until the egg is nearly emptied, but before the air can enter the delivery pipe the air outlet valve *F* opens, and the cycle of operations is repeated.

Messrs Kestner also construct elevators in which the air is separately exhausted, and have also

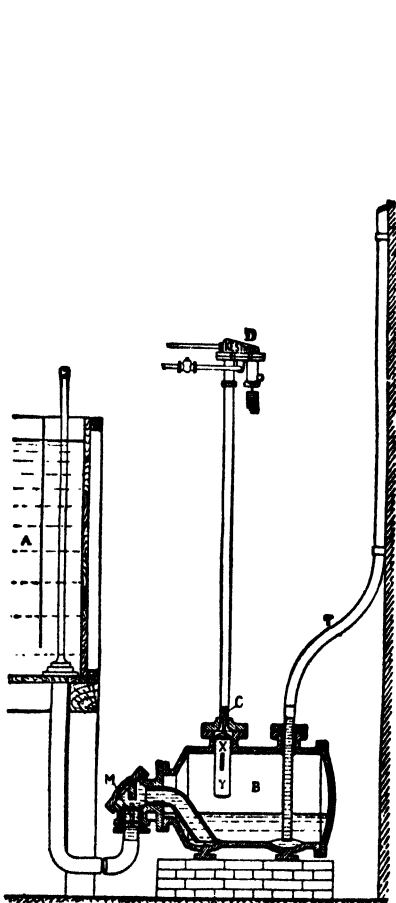


FIG. 22.—Kestner's Acid Elevator.

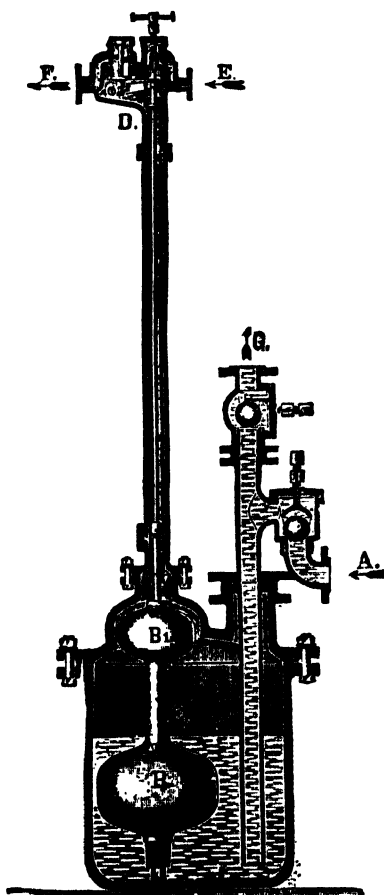


FIG. 23.—Schütze's Acid Elevator.

applied the principle of preheating the compressed air, whereas Schütze has designed a continuous elevator suitable for working sprays direct, and also one electrically controlled for dispensing with feed tanks at the top of towers.

Acid Centrifugal Pumps are now on the market, which are mechanically far more efficient than compressed air liftings.

Messrs Houghtons construct centrifugal acid-tight pumps, having overcome the difficulty of leakage at the glands.

In addition to their economy of power, centrifugal pumps possess the following advantages over compressed air: (1) There is less wear and tear of the acid pipes. When compressed air is used much repair work is necessary, due to the violent shaking—this is avoided, of course, with

an independent air exhaust, and also to a great extent in Schütze's expansion pulsometer; (2) no escape of nitrous gases; (3) ease of rendering completely automatic; (4) absolutely continuous delivery. Highly efficient pumps of this kind are now made in England, Germany, the States, and elsewhere; in some the gland is allowed to leak, and the leakage returned to the feed tank.

Ordinary plunger or bucket pumps are now constructed of hard lead, acid-resisting cast iron, and earthenware. They are fairly efficient appliances, but are not nearly so convenient as, and are more expensive in use than, centrifugal pumps. The old acid "eggs" and also "emulseurs" (where the acid is driven over as a froth) have largely gone out of use. Against a low pressure, however, emulseurs are still used.

Introduction of Water Spray instead of Steam.—The introduction of water spray into the chambers instead of steam has effected a considerable economy, the expense of steam raising being obviated, while both the nitre consumption, chamber space, and wear and tear have been considerably reduced (see p. 225).

The sprays used are of two main types. The one consists of a cylindrical chamber with a tangential inlet and a central outlet. This type has been developed by Messrs **Haughtons**, and is very efficient where it is required to handle fairly large volumes. Theoretically it is very much better to introduce the water in the form of weak acid than as atomised water; practically, however, there is the risk of water being delivered to the chamber without being atomised, upsetting the chamber process, and possibly causing severe local corrosion of the chamber, through the formation of nitric acid, before being discovered. An advantage of Haughtons' spray is that the aperture is comfortably large, and the acid-feed need, therefore, only be passed through the coarsest of filters. The outlet is lined with porcelain or other wear-resisting material.

The other type of spray which is very largely used, particularly on the Continent of Europe, is that exploited by Messrs **Benker & Millberg**. It is really intended for use with water, and

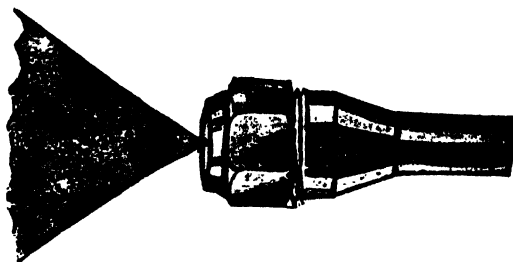


FIG. 24.—Haughtons' Spray.

is made of iridio-platinum. With the extremely high price at which platinum now stands (over £8 per oz., or more than double the price of an equal weight of gold) the expenditure necessary to equip a set of chambers with these sprayers is very considerable. Fig. 25 shows the various parts, full size. The appliance consists of a cylinder in which a finely cut loose spiral works, the thrust being taken on a footstep bearing. The acid being forced through the spiral channel causes the screw to rotate, and a fine and widely distributed spray results. The chief disadvantages of this apparatus are the possibility of obtaining a stream instead of a spray in the event of the passage becoming clogged or corroded, and that the initial cost is very great; a large number are required; it is difficult to tell if they are working properly, much supervision is therefore necessary, and a set of very fine filters have to be used. Their chief advantage over the Haughtons' type of sprayer is the smaller volume of liquid with which they will work—some 2½ galls. per hour, though the Haughtons type is said to be capable of being satisfactorily used for this capacity.

These sprayers require 40-48 lbs. pressure per square inch behind them, obtainable either by means of compressed air, or preferably by means of multicellular centrifugal pumps.

Other sprays exist of the splash-plate type, in which a fine jet, under pressure, is directed against a plate, and also atomisation by steam. This last method is somewhat unsatisfactory. Glass sprayers have also been used.

The sprays are usually fitted on the top or side of the chamber (see Fig. 25) so as to be readily inspectable.

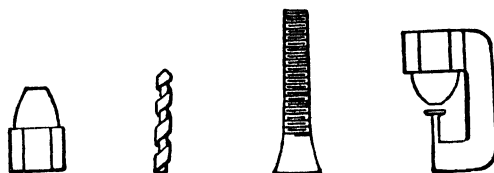
Methods of Introducing Nitric Nitrogen.—The old-fashioned method of the nitre pot, heated by the burner-gas, still remains in a very large number of factories both in the United Kingdom and in the United States of America.

On the Continent of Europe it is more usual to employ nitric acid. The increased cost of producing the HNO_3 is said to be more than reaped by the economy due to the regularity of feed and other considerations

The nitre pot consists of a cast-iron vessel placed in an expansion of the flue. It is fitted with an acid feed tank, and is periodically charged with nitre and acid. The nitro-cake (acid sodium sulphate) is run off, by removing the plug, into a tray where it is allowed to cool.

“Nitre” may also be introduced by running a strong solution of sodium nitrate and sulphuric acid down a special nitrating tower immediately following the Glover, or by spraying the solution

Benker's Sprayers full size



How the Cold Water Spray System is attached to the lead Chambers.

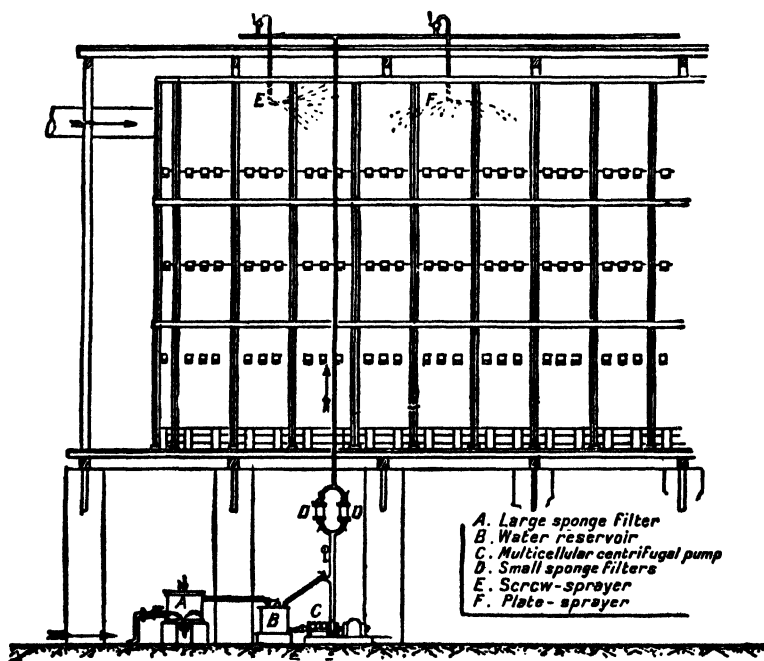


FIG. 25.

into the chamber itself. In the case of fertiliser factories the presence of a small quantity of sodium sulphate is of no great consequence, and the second of these two methods seems likely to be further developed.

In the *Opl system* (p. 239) any one of these methods of introducing “nitre” may be employed, except, of course, that there are no chambers into which to spray the nitre solution. In the *Griesheim process* (p. 239) nitric acid itself has to be used.

Chemical Control of the Chamber Process.—The progress of the manufacture is controlled (a) by estimating the amount of SO_2 and SO_3 in the entering burner-gases; (b) determining the strength of the chamber acid; (c) checking the temperature of the chambers; (d) the waste gases from the chambers are tested (by observing their colour through glass windows) for oxides of nitrogen both before and after passing through the Gay-Lussac towers. The amount of free oxygen in the gases is also estimated; (e) the amount of nitric acid and also total nitrogen, both in the acid coming from the Gay-Lussac tower and also in the chamber acid, is usually estimated.

The Waste Gases.—According to the Alkali, etc., Works Act, the final exit gases from sulphuric acid works must not be of an acidity equivalent to more than 4 gr. of SO_3 per cubic foot in Class I. (acid made by the Chamber and like systems). In Class II., which consists of contact processes, the "best practicable means" have to be employed; this includes contact systems. The acidity of the final outlet gases from concentration plants must not exceed the equivalent of 1.5 gr. of SO_3 per cubic foot.

The waste gases contain, of course, comparatively little oxygen, and, of course, a high proportion of nitrogen. It is conceivable that they could be profitably further enriched and used for the formation of either calcium cyanamide or synthetic ammonia.

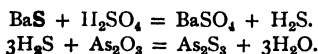
Purification of Sulphuric Acid.—Arsenic in the form of arsenious oxide, As_2O_3 , is the chief impurity in sulphuric acid, especially in that made from many pyritic ores, although spent oxide and some deposits of pyrites are very nearly free from it. The arsenic may be present from traces up to 0.10. The presence of small quantities of arsenic in the sulphuric acid used for making superphosphates and other manures is not very injurious, but for other purposes, such as the manufacture of glucose, the etching of metals, the production of hydrogen—in fact for all ordinary uses—the acid must be arsenic free.

Where a perfectly arsenic-free acid is necessary, it is easiest to obtain it by burning sulphur (see p. 217), or else by the contact process. However, a "technically" arsenic-free acid can also be prepared by the lead chamber process, provided that a pyrite poor in arsenic is used, and that good dust chambers and gas-filtering arrangements are used.

Arsenic may be removed from sulphuric acid :—

1. *By treating the acid with sulphuretted hydrogen and precipitating the arsenic as sulphide.* On the large scale the chamber acid is diluted to 45° Bé., and allowed to flow down leaden towers against an uprising stream of H_2S .

The complete removal of the arsenic as As_2S_3 , however, can only be attained by diluting to 20° Bé. On the small scale, e.g., in acid to be used for accumulators, this is achieved by adding barium sulphide (BaS) thus :—



The H_2S at the same time removes, as sulphides, such metals as lead, copper, antimony, bismuth—but not iron.

2. *By volatilisation as chloride*, which method was introduced and is worked by the United Alkali Co.; the acid is treated at a temperature of about 100° C. in a suitable tower with dry HCl , the trichloride which forms being subsequently volatilised. This method has the advantage over that of removal in the form of sulphide in that, in the latter, it is necessary to dilute the acid before treatment with H_2S .

3. *By arresting the arsenic in hot ferric oxide with the formation of iron arsenite.* Of these methods each has its special merits.

Chamber acid sometimes contains **oxides of nitrogen**. These can be easily eliminated by adding some ammonium sulphate when concentrating the acid. The nitrogen escapes as N_2 and as N_2O .

If further purification is really necessary the acid usually has to be distilled. This is effected in platinum or glass stills heated in a sand bath and fitted with suitable condensers, usually platinum. Heraeus, of Berlin, has introduced a still made of a compound sheet of platinum and gold. In the existing state of the platinum market it is much cheaper than one of equal capacity made wholly of platinum. The wear and tear is said also to be considerably less. Stills for sulphuric acid are also made in fused silica.

Concentration of Sulphuric Acid.—Chamber acid is concentrated to about 60° Bé. in the **Glover tower**. The **Glover acid**, however, takes up considerable amounts of Al_2O_3 and Fe_2O_3 which are difficult to remove. A purer acid can be obtained by evaporating in lead pans, heated either by the waste heat of the burners or by passing superheated steam through leaden pipes immersed in the acid.

However, the concentration in lead pans can only be carried up to 60° Bé.,

since a more concentrated hot acid attacks lead badly, and also porcelain. Recently, however, there have been put on the market pans of extremely acid-resisting material; for example, fused sand or silica (vitresil), also a mixture of silica with a little titanium or zirconium oxide (which is said to delay devitrification and increase toughness, "siloxide"); alundum, fused alumina; also the very

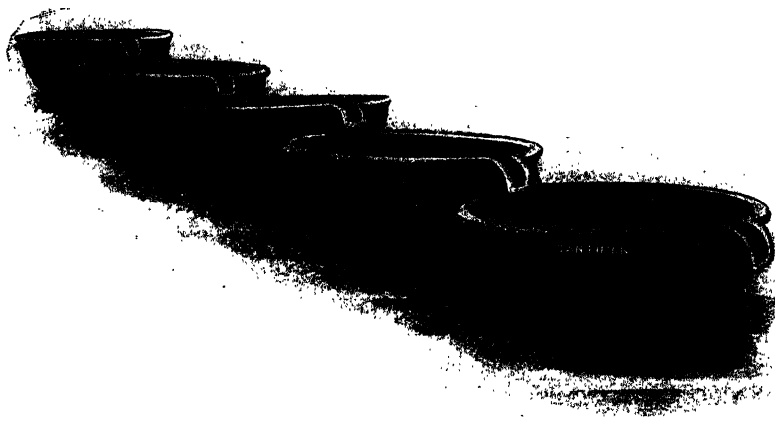


FIG. 26.—Cascade System of Acid Concentration.

important new acid-resisting alloys of iron with silicon—such as "ironac," "tantiron," "duriron," etc. (see also British Patent, 304,688 (1930)).

The so-called **cascade system** is employed. The pans (see Figs. 26, 27, 28), each provided with a lip,¹ are arranged in a series, each one at a lower level than the other, so that the strong acid follows, cascade-like, from one into the other. Each of the pans is heated from below, so that the acid at 60° enters the top basin of the series and, flowing over each basin (twenty or more), in turn is gradually concentrated, and escapes from the last basin concentrated to 66° Bé. Naturally during the operation quite a considerable amount of acid fumes are evolved, so that the series of basins are covered with a hood which leads away the fumes through a condensing system, and so recovers most of the volatilised sulphuric acid.



FIG. 27.—Acid Concentration Pans.

On the large scale **Gaillard towers** are now very widely used. They are built of volvic lava (see p. 227), which is a stone extremely resistant towards hot concentrated acid.

Fig. 29 shows a section through the apparatus. T is the Gaillard concentration tower, built of rings of volvic lava cemented together with waterglass volvic lute. The towers are about 15 m. high and do not contain packing. Down them is sprayed in a steady stream the

¹ They have to be provided with a long lip, as otherwise the low surface tension and high viscosity will cause the acid to creep down the side.

chamber acid to be concentrated; the falling spray meets an uprising current of hot fire gases from the producer G, and is thereby highly heated and falls in a concentrated form, collecting at the base *f* of the tower, whence it runs away through a special series of coolers. R is a "recuperator" made out of acid-resisting brick, down which a stream of water or dilute acid is sprayed. This, however, does not completely stop the mist of acid, and so a coke filter H is necessary, which removes the last traces of the acid drops. The coke filter is filled with a

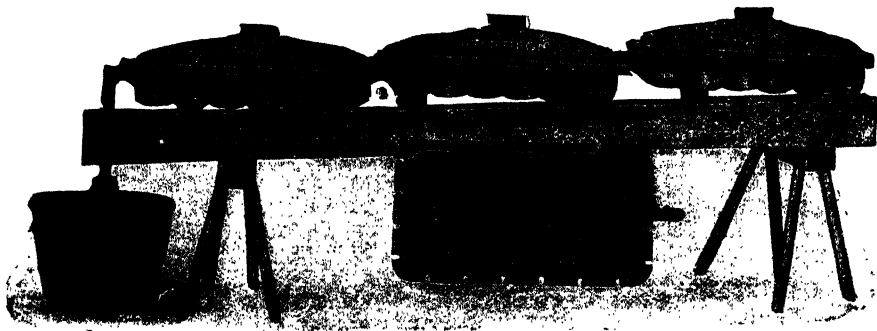


FIG. 28.—Haughtons' Acid Concentration Plant.

moderately finely granulated coke, and it is important to observe that it is only by passing the gas through such a "gas filter" that the mist of acid can be completely condensed. The gas is drawn right through the whole apparatus by means of a fan placed at V (see also Parrish, *Chem. Met. Eng.*, 1930, 37, 93).

In Kessler's apparatus the highly heated products of combustion of

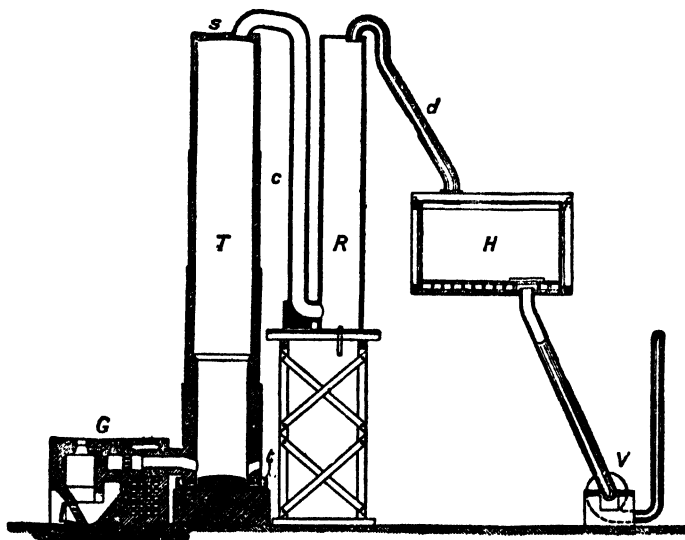


FIG. 29.—Gaillard Towers.

producer-gas are made to pass under, over, and through the sulphuric acid on the principle of the counter-current. The apparatus is built mainly of volvic lava or acid-proof brick, parts being made of fused silica or acid-resisting silicon iron; the gas is drawn through by means of a suitable fan. It is convenient and efficient, but very expensive as regards first cost compared with a modern cascade plant, and is not more economical to run. It is fired with producer or other gas.

All these evaporators have to be fitted with suitable coolers of fused silica or acid-resisting silicon-iron, etc., at the one end, and with some form of scrubber at the other. In some, the flue gases and the products of evaporation are kept separate; in others, such as the Kessler and Gaillard, they are co-mingled or allowed to mix before or immediately after leaving the appliance. The scrubber has to be put up to arrest most of the SO_3 —and to some extent SO_2 if the acid be reduced in the process of evaporation. Strong sulphuric acid, when boiled, loses sulphur trioxide owing to dissociation, which passes forward as a gas or as a mist of sulphuric acid. In the Kessler system there should be a minimum of loss in this way, as all the products of combustion and evaporation have to pass practically through the comparatively weak inlet acid. In actual practice, however, it is not found that this difference is so great as might at first sight be expected.

In Great Britain it is laid down by Act of Parliament that the **exit gases** from plants concentrating sulphuric acid shall not exceed $1\frac{1}{2}$ gr. per cubic foot, acidity counted as SO_3 , hence the necessity of providing a scrubber. This scrubber may be turned into a source of income. Packed with suitable material, allowed to become hot, and fed with the acid which condenses in it, the make up being periodically removed, fairly strong acid, up to 130°Tw. , may be recovered with safety.

A small amount of acid is also concentrated in platinum and glass stills; it is, however, usually more profitable to bring up the concentration, if required above 95 per cent. H_2SO_4 , by means of the addition of fuming contact acid, or even of SO_3 , or to use contact acid diluted to the point required.

Sulphuric acid can be concentrated by evaporation up to 98.3 per cent. H_2SO_4 , and with this concentration it possesses its highest boiling point of 338°C. , and can be distilled without decomposition.

Acid of higher concentration than this decomposes, splitting off SO_2 , H_2O , and O. The ordinary concentrated 66°Bé. (167°Tw.) acid of commerce contains about 93.5 per cent. H_2SO_4 (see Table, p. 250).

At the present time acids of greater strength than 93 per cent. are usually prepared by means of the contact process. This is especially so of the 100 per cent. H_2SO_4 now on the market.

For acids of 93 per cent. H_2SO_4 (66°Bé.) and under, the chamber process holds its own, and indeed produces it as cheaply, if not more cheaply, than the contact process.

The **transport** of concentrated sulphuric acid of over 50°Bé. is effected in large wrought-iron cylindrical boilers, mounted on railway wheels, and carrying many tons of acid at a time. Smaller quantities, however, are transported in glass carboys holding 50-70 litres. (See p. 251 for precautions, etc.)

Tower Systems of Producing Sulphuric Acid

It will be recollected that on pp. 223, 224 we mentioned that in the **Glover tower** (where the SO_2 from the burners meets a descending stream of sulphuric acid containing dissolved oxides of nitrogen) the sulphur dioxide (SO_2) is very rapidly oxidised to sulphuric acid, the action being here at least ten times as intense as goes on in an equal volume of chamber space.

Attempts have been made—and recently with success—to dispense entirely with leaden chambers, the sulphuric acid being produced entirely in towers down which pour sulphuric acid containing dissolved oxides of nitrogen (as in the **Glover tower**), and up which pass burner-gases containing SO_2 . So that here the sulphuric acid is produced, just as in the leaden chambers, but with the difference that the oxidation takes place, not in a gaseous state—as in the case of leaden chambers—but in liquids pouring down the tower, and consequently in a very much less volume.

For example, six towers are erected, the first five of which act like Glover towers (see pp. 223, 224), being fed with a stream of sulphuric acid containing dissolved oxides of nitrogen. These oxidise the SO_2 to H_2SO_4 , and concentrate and denitrate the sulphuric acid pouring down. The last tower acts as a **Gay-Lussac tower**, and absorbs any oxides of nitrogen escaping from the preceding five towers. A continual and energetic circulation of acids by pumping to the top of each tower is obviously necessary in this system, which thus involves the expenditure of much mechanical work.

The Griesheim System is as follows:—The burner-gases pass through a Glover tower whose function is similar to that in the chamber system, and then into towers fed with nitric acid of 30°-35° Bé. A considerable excess of nitric acid is used, with the result that the oxidation is extremely rapid. The acid formed retains about 1 per cent. HNO₃, and contains over 50 per cent. of H₂SO₄; the whole of it is passed down the Glover, where it is completely denitrated. The gases pass into a further series of towers serving to recover the nitric acid in a form in which it can be used in the oxidising towers. The whole process depends upon the careful adjustment of temperature, and this again partly upon the density of the various acids feeding the towers. The main advantages claimed are that wide variations in the composition of the burner-gas are permissible, that stronger acid is produced than by the chamber process (this is very much open to question.—J. L. F.), and that the nitric acid is recovered as such.

The Opl Process has developed on somewhat different lines. It appears to have been fairly successful, a number of installations having been recently erected in Great Britain (over twenty) and on the Continent. The process as now developed is briefly as follows: In the first set of towers acid is produced and concentrated as in the Glover tower; in the second set—each usually of three towers—the oxides of nitrogen are recovered by strong sulphuric acid in the form of a Gay-Lussac acid. The water is introduced into the top of the first four towers. The acid from the first three is pumped on to the next three, and vice versa, so that there are three sets of towers working together. All the acid produced is finally run down the tower nearest the burners. The first tower produces about 20 per cent., the second 30 per cent., and the third 50 per cent. The acid is raised to the top of the towers by emulseurs worked by compressed burner-gas. This method of acid elevation is not likely to be mechanically efficient, and will probably be replaced by centrifugal pumps. The process is therefore the principle of intermediate towers combined with Petersen's inner ring system of secondary Glover and Gay-Lussacs working together, and the "intense" method of working chambers, wherein a very much greater concentration of nitric nitrogen is employed than when working on the old system. The results of this happy combination are a tremendous reduction in the amount of both ground space and actual volume required; a considerable reduction in the original cost, and consequently of repairs, depreciation, and interest; a make of acid of uniform strength of over 140° Tw. (this is possible with an ordinary chamber set); the possibility of employing burner-gases of a widely varying content of SO₂; a low consumption of nitre; a uniformly low acid-content of the effluent gases, and easy supervision of both the plant and its working. The chief disadvantages of the process are the cost of pumping the large volumes of acid (which, now that mechanically efficient and acid-resisting pumps are available, is quite small), and of gas against the resistance of the tower packing. In this system, as in most other tower systems, the whole of the acid is obtained in the most impure form, that of **Glover acid** (see pp. 235, 248); but with satisfactory appliances for removing dust, which are neither costly to erect nor difficult to use, the amount of impurity may be rendered practically as small as desired. The system is being widely installed.

An improvement introduced by **Petersen**, which could be combined with the Opl system, is that of the use of a supplementary tower fed with acid of 126° Tw., this tower immediately preceding the first Gay-Lussac. It has the important property of absorbing and oxidising sulphur dioxide, and also of absorbing oxides of nitrogen. Any temporary dislocation of the process will therefore have one or other of the following effects: in the event of an excess of sulphur dioxide coming forward it will be absorbed so long as there is more than a certain nitre content in the acid; at the same time oxides of nitrogen are liberated from the acid and pass on to the Gay-Lussacs, where they are absorbed, producing an acid of greater nitrosity, this acid being subsequently run down the Glover tower. This action does not continue indefinitely, of course, but sufficient warning should be given to those in charge of the plant to enable them to make the necessary adjustments without either seriously disorganising the process or even wasting "nitro."

In the event of an excess of oxides of nitrogen coming forward into the "regulator," that excess is simply absorbed until the acid becomes saturated, producing a reserve for action should the variation turn about in the opposite direction. Where working with material variable in sulphur-content the regulator tower is of great value, paying for itself merely in the amount of acid made therein, the economy in nitre being a clear saving.

A third tower system has been recently introduced in France by **Duron**. It is more or less a combination of Opl and Regulator. The **Gaillard-Parrish** system continues to extend (see *Chem. Age*, 1929, 21, 612; 1930, 23, 606; *Chem. Met. Eng.*, 1930, 37, 93).

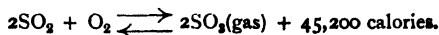
The Contact Process

When a mixture of sulphur dioxide (SO₂) and oxygen (either ordinary atmospheric or else pure) is passed over platinised asbestos, heated to dull redness, they unite to form sulphur trioxide or sulphuric anhydride, thus:—



Although this fact was observed by Davy nearly a century ago, and was developed technically by Winkler in 1875, also by Schröder, Hanisch, and Grillo in 1887, nevertheless it was the **Badischen Anilin- und Sodafabrik**, under the direction of R. Knietzsch, who brought, in 1889-1890, the process to such a state of technical perfection that they succeeded in *completely* transforming the waste SO_2 (coming from roast gases of various processes) into SO_3 , which they utilised to make fuming sulphuric acid for the manufacture of synthetic indigo.

In order to start the combination of sulphur dioxide and oxygen the gases must be heated to about 300°C. , in the presence of platinum, when the action proceeds with the evolution of much heat, taking place in accordance with the law of mass action :—



The conditions regulating the equilibrium are given by the formulæ :—

$$\frac{C^2(\text{SO}_3)}{C^2(\text{SO}_2) \cdot C(\text{O}_2)} = k, \text{ or } \frac{C(\text{SO}_3)}{C(\text{SO}_2)} = \sqrt{C(\text{O}_2) \cdot k.}$$

Here $C(\text{SO}_3)$ represents the **concentration** of the SO_3 , *i.e.*, the number of gramme-molecules of SO_3 in each litre, and $C^2(\text{SO}_3)$ is simply the square of this number. The same applies to the figures $C(\text{SO}_2)$, $C(\text{O}_2)$, etc., which represent the **concentrations** of the SO_2 and O_2 , *i.e.*, the number of gramme molecules of SO_2 and O_2 per litre.

k is the so-called "constant of equilibrium," a quantity which varies considerably with the temperature, being great at 400° but much less at higher temperatures. Owing to this fact it is possible at 400°C. to almost completely transform the SO_2 into SO_3 in a **single operation**, provided excess of oxygen is present. However, at higher temperatures the back action $\text{SO}_3 = \text{SO}_2 + \text{O}$ increases and much SO_2 escapes transformation.

Nature of Catalysts Employed to Promote the Union of SO_2 and O

Although SO_2 and oxygen act almost imperceptibly slowly upon each other at 400°C. in the **absence** of a catalyst, yet the presence of a **catalyst** (such as platinum, iron oxide, chromium oxide, copper oxide, oxides of manganese, NiSO_4 , CoSO_4 , Vd_2O_5 , brick, quartz, etc.) causes this almost imperceptibly slow action to take place quite rapidly. Of all these catalysts, platinum causes the action to become rapid at the lowest temperature, being best at 400° - 450°C.

With **vanadium catalysts** (see Holmes and Elder, *Ind. Eng. Chem.*, 1930, 22, 471) at 98 per cent. conversion is obtained at 500°C.

With other contact substances a higher temperature than this is necessary (*e.g.*, iron oxide is most active at 600° - 700°C.), which naturally leads to a diminished yield of SO_3 , owing to the increasing extent of the back action :—



Quite a large range of contact substances have been proposed in addition to those mentioned ; they do not, however, seem to be employed to any great extent. They include oxides of tungsten, titanium, molybdenum, and thorium. Anhydrous magnesium sulphate impregnated with 0.2 per cent. of platinum is said to be used in one small, but apparently successful, installation. We may therefore divide the chief successful processes into three classes—(1) those using platinum black in one form or another ; (2) those using soluble platinum salts in suitable form ; (3) those using iron oxide.

How platinum and other catalysts act is not known. They apparently accelerate an action which takes place in their absence only very slowly indeed. The catalysts do not alter in the slightest the final equilibrium attainable by a given chemical action at a stated temperature ; all that the catalyst achieves is to enormously speed up the process, and so diminish the time necessary to establish the equilibrium peculiar to the temperature and concentration of the reacting components.

Possibly the catalysts act by causing a condensation of the gases on or in their surfaces, and by thus bringing them closely together cause the acceleration of the chemical action. Another theory is that "intermediate" compounds are formed. Although catalysis is usually defined as "increasing of the velocity of a chemical reaction by the presence of a third body or bodies which do not appear to have undergone chemical change at the end of the interaction," yet it seems likely that the catalysts do actually play some chemical part ; indeed this is known to be the fact in some well-known cases. The action of the oxides of nitrogen in the so-called "chamber" process may be said to be catalytic, though we know that they do undergo some chemical change, the nature of which is imperfectly understood.

Catalysers are very easily upset, most easily by chemical impurities, which seem to be absorbed, and effectively inhibit the catalytic effect. The precise way in which these contact "poisons" work is not yet ascertained. Minute traces of arsenic will effectually stop the catalytic

effect of platinum preparations—particularly in elemental form—and the elimination of all the impurities present, or which even became subsequently introduced, proved exceedingly laborious and costly to discover.

Conditions for Technical Success

One of the first conditions for success in causing the union of SO_2 and O by the contact process is the **steady maintenance** of the most favourable temperature, viz., $400^\circ\text{--}450^\circ\text{C}$. (when **platinum** is used as the contact substance).

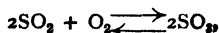
As pointed out above, the union of SO_2 and oxygen proceeds with the development of a considerable amount of heat ($2\text{SO}_2 + \text{O}_2 = 2\text{SO}_3 + 45,200$ calories). On the small scale this heat is so rapidly radiated that the temperature does not rise very high. However, on the large scale the radiation is much less, and the temperature tends to rise so much that part of the SO_3 formed decomposes again into SO_2 and O, thus:—



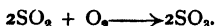
The heat, therefore, evolved in the reaction must be artificially dissipated—which is usually done by utilising it to heat the incoming cold mixture of SO_2 and oxygen (as will be seen immediately).

Although a mixture of SO_2 and oxygen energetically react when first brought into contact with the platinum, causing the latter to glow, nevertheless the reaction takes place more and more slowly as an increasing percentage of SO_3 is formed, and the final equilibrium (with almost complete transformation of the SO_2 into SO_3) is only attained by allowing the reacting gases to remain in contact with each other for some considerable time. The higher the temperature the more rapidly is a state of equilibrium attained, but the more unfavourable is this final state of equilibrium for the yield of SO_3 , as the back action $\text{SO}_3 = \text{SO}_2 + \text{O}$ increases rapidly with the temperature.

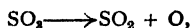
This is clearly shown by the following experimental curves (Fig. 30) of Bodenstein and Pohl. The temperatures are abscissæ, and the ordinates are the yields of SO_3 per 100 parts of SO_2 present in the gaseous mixtures. These yields, it must be recollected, are those **maximum yields** which can be obtained by allowing the action to go to complete equilibrium. To attain a state of equilibrium may require some time. In fact, under 400° such a long time is required for the reaction,



to come to its final stage of equilibrium, that the process is **unworkable practically** at temperatures below 400° —and this although the action below 400° practically comes to final equilibrium with the complete conversion of the SO_2 into SO_3 in the sense of the equation:—



At temperatures higher than 400° equilibrium is fairly rapidly attained, but here the back action



becomes more pronounced, so that all the SO_2 cannot be converted into SO_3 . In practice the initial temperature is maintained at $450^\circ\text{--}500^\circ\text{C}$., so that equilibrium is rapidly attained, and then, in order to cause the further complete conversion of the SO_2 into SO_3 , the temperature in the latter parts of the contact apparatus is kept at $400^\circ\text{--}450^\circ\text{C}$. By such means the Badische Anilin- u. Soda-fabrik have been able to obtain a yield of SO_3 of over 98 per cent. of the theoretically possible. In the curves the behaviour in the platinum contact apparatus of four different gaseous mixtures are shown between the limits of $400^\circ\text{--}900^\circ\text{C}$. Curve (1) shows the results of a mixture of gases such as are obtained from a normal roasting furnace containing 7 per cent. by volume of SO_2 , 10 per cent. by volume of O, and 83 per cent. by volume of N; once equilibrium has been attained it was found that at 400°C . 99.3 per cent., and at 500°C . 93.4 per cent. of the SO_2 is converted into SO_3 . A much worse yield of SO_3 is obtained when the oxygen and SO_2 are mixed together in the exact proportions required by the equation $2\text{SO}_2 + \text{O}_2 = 2\text{SO}_3$ (i.e., 2 vols. of SO_2 to 1 vol. of O_2). Curve (2) shows this, which was obtained from a gaseous mixture of 33.3 per cent. O and 66.7 per cent. SO_2 ; here at 400°C . only 98.1 per cent. of the SO_2 is converted into SO_3 , and at 500°C . the yield is barely 91.3 per cent. A much better yield is obtained by having excess of oxygen (see curve 3) of air. Dilution of the burner-gas with excess of air is especially favourable, because it enables the action to be carried on at a higher temperature, and so more rapidly.

All these four curves show that at 400° a nearly 100 per cent. yield of SO_3 is attainable; nevertheless, it is impossible to utilise a temperature below 400° technically, because the action completes itself too slowly.

Badische Anilin- und Sodafabrik Process (Knietzsch-Herreshoff Process).—Fig. 31 shows the platinum contact apparatus of the Badischen Anilin- und Sodafabrik, as reproduced from the German Patent, 113,932 of 1898. Here the initial temperature of the reacting mixture is kept at 450°-500° in order that the action may complete itself as rapidly as possible; then the temperature is reduced to 400°-450° in order that the complete transformation of the SO_2 into

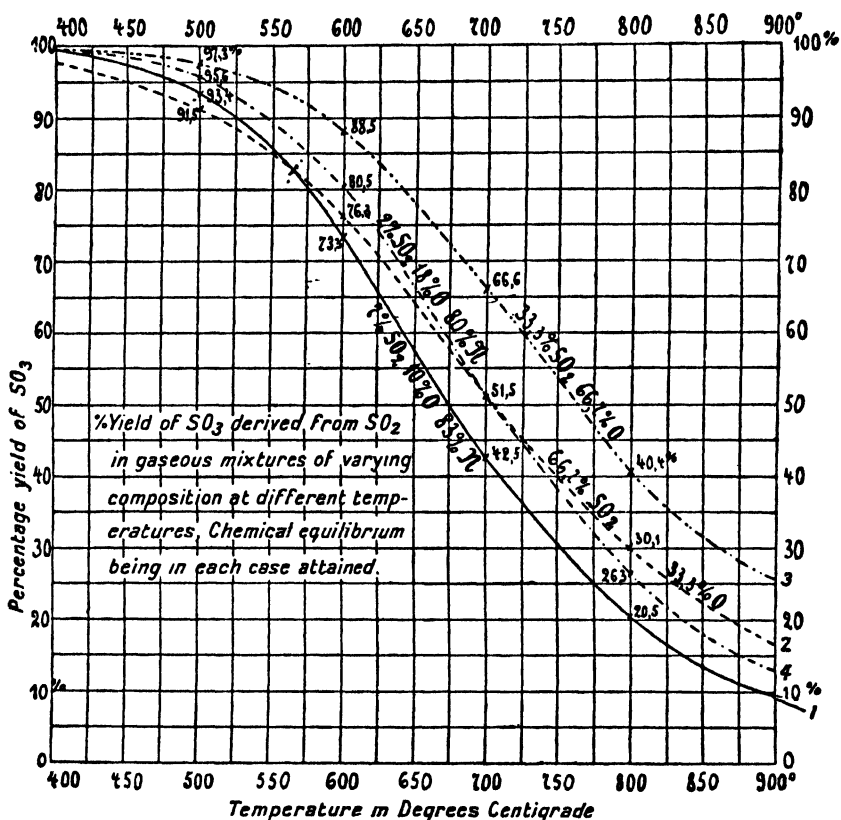


FIG. 30.—Conversion of Sulphur Dioxide into Sulphur Trioxide (Bodenstein and Pohl).

SO_3 should be attained. The regulating of the temperatures is attained by leading in only moderately hot gases from the roasting furnaces, so that the heat of the reaction is utilised by heating these cold entering gases, while the cold gases themselves chill the reacting mass, and prevent the temperature rising too highly.

In fact, the principle of the heat-interchanger is here employed.

The apparatus consists of a large iron cylinder about 3 m. in diameter, down which pass four smaller "contact" tubes, in which platinised asbestos (containing 10 per cent. Pt) is packed on acid-proof plates of earthenware, which are pierced with numerous holes. The platinised asbestos is packed loosely between the successive plates, so that the gases can pass through the tube without encountering a great resistance.

The separating plates in the tube are held in their position by means of a central rod passing down through the centre of the tubes. It has been found that platinised iron oxide (derived from the burning of pyrites), in pieces the size of a pea, work somewhat more efficiently than platinised asbestos, the contact tubes being filled with the mixture in loose layers.

The very carefully purified preheated gases from the roasting furnaces are driven by a pump, from G through the valve *v*, and enter at the bottom of the wide cylinder at A. Then the gases pass upwards around the outside of the four contact tubes (thus abstracting from them their excess of heat, and at the same time the uprising gases are thereby heated to the proper temperature for reacting). At D the gases, now heated to the right temperature, pass into the contact cylinders, streaming down them. As the gases pass downwards over the platinised asbestos the union of the SO₂ and the oxygen takes place, the temperature being highest at the top of the tubes (being maintained at 450°-500°) and lowest at the bottom (400°-450°), these temperature conditions being necessary to attain a quantitative yield of SO₃, as above explained. In order to maintain these favourable temperatures the colder roast gases can be allowed to enter at *v*¹ or *v*² so as to chill the upper part of the tubes if they tend to become too hot. Also cold air can be passed up outside the large iron cylinder to cool this somewhat if the temperature rises too high. Sometimes the lower part of the tube cools to too low a temperature for most favourable action. To obviate this heating tubes are arranged at *h h*.

The downstreaming gases, charged with SO₃, escape from the contact tubes into the lower space E.

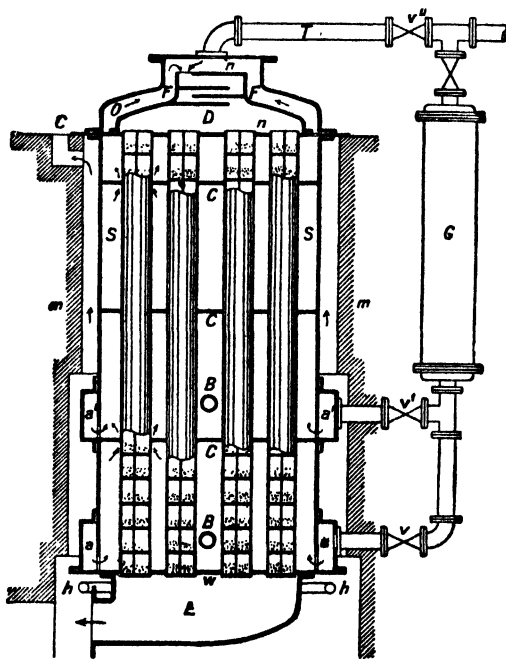


FIG. 31.—Badische Anilin- u. Sodafabrik Contact Process for Sulphur Trioxide.

The absorption of the SO₃ formed is effected by passing the gas into strong sulphuric acid, which in turn may be diluted successively with weaker and weaker acid, until finally only water is used. Continuous counter-current water-cooled absorbers are usually employed to produce fuming acid of any required degree of strength (see pp. 245, 246).

One condition absolutely essential for success is the **very careful purification of the entering gases from the roasting furnaces.**

Otherwise the catalytic platinum becomes "poisoned" (see p. 240), and refuses to work.

The extreme degree of purification of the gases necessary in this process is one of its chief disadvantages. Thus the Badische Anilin- und Sodafabrik find that not only must all flue dust be removed from the entering gas, but also all vaporous impurities, all compounds of arsenic, iron, bismuth, antimony, sulphur, selenium, mercury, phosphorus, silicon tetrafluoride, SiF₄ (which arises out of the use of zinc blende), must be most carefully eliminated if the platinum catalyst is to be kept effective for any length of time. The presence of even traces of arsenic acts most injuriously on the platinum.

The gases are therefore purified by a thorough scrubbing in leaden troughs (iron troughs would only cause the evolution of further impure gases). Sometimes the gas is filtered dry through a fine granular layer of coke, clay, blast-furnace slag, or similar material. Arsenic is completely eliminated by passing through unburnt clay at about 350° C.

The burner-gas in these purifying processes naturally becomes too cold for direct use, and hence it is necessary to preheat the gas before it enters the contact apparatus, by designing the apparatus as a counter-current heat-interchanger.

The Badische are said to obtain a conversion by their latest improvements, according to this method, of over 98 per cent., and the annual output of sulphuric anhydride by the Badische themselves, and by other firms working their process under licence, amounts to over 200,000 tons.

The chief improvements introduced in the United States of America by Herreshoff are said to be a material reduction of the back pressure, elimination of liquid seals, and discardance of the counter-current heat-interchanger principle for the contact element, resulting in finer adjustment of the necessary temperature.

For methods of control see H. M. Coater, *Ind. Eng. Chem.*, 1931, 23, 563.

Use of Iron Oxide as Contact Substance

The Mannheim Process.—Iron oxide (Fe_2O_3) is the contact substance used in an important process owned by the Vereins chemischen Fabriken, Mannheim. The details are set out in the German Patent, 107,995 of 1898 (Hasenbach and Clemm). See also Wilke, *Journ. Soc. Chem. Ind.*, 1905. Iron oxide only becomes effective between 600°-700° C., the most active variety being a freshly prepared sort obtained by heating ferrous sulphate. It follows, therefore, that by its means it is quite impossible to completely transform the SO_2 into SO_3 .

A reference to the curves shown on p. 242 will show that theoretically at 600° only 73.3 per cent. of the SO_2 can be converted into SO_3 if we use ordinary burner-gas containing about 7 per cent. SO_2 . Curve 4 shows, however, that on diluting the gas considerably with air it may be possible to get 80.5 per cent. of the SO_2 transformed into SO_3 .

It is, therefore, necessary to employ two separate contacts: (1) An iron oxide contact element in which about 66.6 per cent. of the SO_2 is transformed into SO_3 ; (2) the residual gas coming out of the first contact is then passed into a platinum contact, which transforms the rest into SO_3 .

The great advantage of the process is that the burner-gases coming from the roasting furnaces or pyrites kilns do not need any careful purification, because arsenic does not affect the catalytic action of the iron oxide.

Fig. 32 shows a diagram of the whole process. a^1, a^2 are the two pyrites burners, closed air-tight in front. They are only opened when it is necessary to throw in fresh pyrites, which is done through c. The pyrites must be quite dry. The air required for burning the pyrites is carefully dried (by H_2SO_4 or SO_3) in the drying tower e, and enters at f^1, f^2 under the bars of the pyrites burners. The burner-gases then pass quite unpurified directly into the first contact space g, which is a tower filled with freshly burnt pyrites, i.e., iron oxide. The undermost layers of this mass act as an effective gas filter, absorbing all the flue dust, and also chemically uniting with any volatilised arsenic oxide forming an iron arsenite. The topmost layers, which are kept at a temperature of 600°-700° (by the waste heat of the furnace gas), convert about 66 per cent. of the SO_2 into SO_3 .

If the temperature falls below 600°, SO_3 is lost as it unites with the iron oxide to form ferrous sulphate (FeSO_4).

The lowermost layers of iron oxide, which gradually become non-effective, are removed from time to time from below, while the loss is made up by adding freshly burnt pyrites above. The gases, rich in SO_3 , now pass away through A, being cooled, and the SO_3 thoroughly removed by condensation (see below). Since SO_3 and H_2SO_4 mist injuriously affects a platinum contact arrangement, the residual gas, after removal of the SO_3 , is then filtered through a layer of granulated slag, and then passes directly into the platinum contact element, which consists of a mat of platinised asbestos. This converts the rest of the SO_2 into SO_3 , no overheating of the apparatus being here possible, as the percentage of SO_2 in the gas is low, and so the action is not vigorous enough to need elaborate cooling arrangements. The issuing gas is once more cooled, and the SO_3 absorbed in a second series of condensers.

There are some thirty-five units on this system in the United States of America, but it has not been so widely adopted on the Continent of Europe.

The process does not require complicated or delicate pieces of apparatus, a staff of highly-trained and specialist chemists, nor any special apparatus for the purification of the roast gases, as this is done in the furnace itself. It may be combined with a chamber or tower process. The amount of fuel consumed and motive power required is, so it is stated, smaller than that of any other known process, and the plant can be built up gradually on account of the units being small and being easily arranged in groups. The cost of repairs is stated to be very low.

Other Processes

The Schroeder-Grillo is the most successful of those processes employing contact masses of soluble platinum salts. In this process the principal salt employed is the sulphate. The chief advantages claimed for this method are: (1) The contact mass is easily regenerated, hence the kiln gases do not have to be purified as perfectly as if working with platinised insoluble vehicles; (2) the calcined crusts are very porous, so that the contact mass made from them offers much less

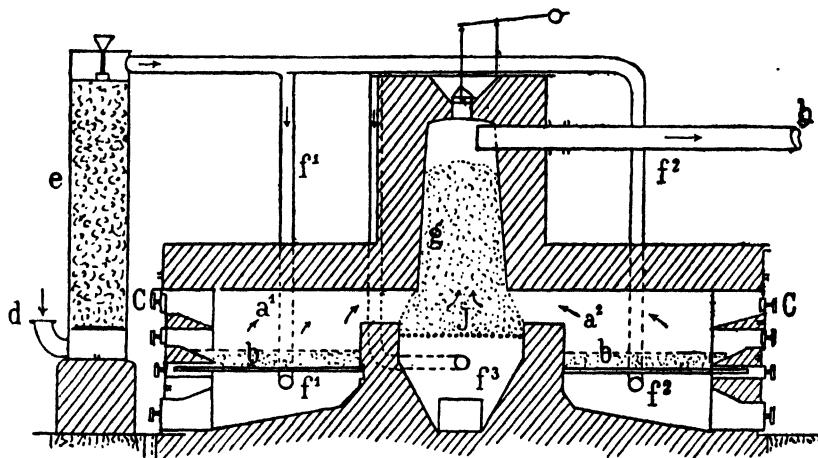


FIG. 32.—Ferric Oxide Process for Sulphur Trioxide.

resistance to the gases passing through them than the tightly packed asbestos formerly used; (3) the catalytic action of the contact mass made from soluble salts is far superior to that of platinised insoluble carriers, and the contents of platinum in the contact mass, which were from 8-10 per cent. of the weight of the asbestos in the old Schroeder plates, have been decreased to 0.1 per cent. without reducing the efficiency of the contact material. This process is very popular in the United States of America, where there must be now 25-30 plants at work. The **Knietsch-Herreshoff**, however, seems to be generally considered to be superior.

The Freiburg Process uses platinised porcelain, and purifies the furnace gases by filtration through wood wool. Externally heated wide horizontal contact elements are used.

Rabe's Process, **Tentelw and Eschelmann's Process**, and the **Höchst Process**, as worked out by Dr Krause, all use platinum, the last process employing in addition other catalysts, the nature of which has not been published.

Arrangements for Cooling and Condensing the Sulphur Trioxide

The gases leaving the contact apparatus, charged with SO_3 , are always very hot, and must therefore be cooled before the SO_3 can be absorbed.

The **cooling arrangements** consist of a series of vertical tubes immersed in water. The hot gas passing through the tubes is soon cooled to a suitable temperature. The **absorption** of the SO_3 is carried out in tall towers, down which a slow current of concentrated sulphuric acid trickles. Sulphuric acid containing 97.99 per cent. H_2SO_4 is the most effective liquid for absorbing the

SO_3 . A more dilute acid, or water, causes the SO_3 to form a mist of sulphuric acid, which is very difficult to completely absorb. Pumps are used to force the gases from the pyrites towers through the contact apparatus and thence through the cooling and absorbing apparatus. The complete plant is built of wrought iron, and occupies far less space than the enormous chambers of the lead chamber process.

The absorption of SO_3 is somewhat complicated by its properties (see p. 247). SO_3 melts at $+17.7$ (polymerising at $+40^\circ \text{C}$.), and boils at 44.88°C . It is, therefore, very volatile. It possesses a great chemical attraction for water, dissolving in it with the evolution of great heat—which naturally makes its absorption by pure water somewhat difficult. Now with sulphuric acid it unites to form a series of hydrates, having widely varying melting points (see p. 247). Thus a mixture of H_2SO_4 , containing 42 per cent. of SO_3 dissolved therein, melts at 35° —maximum melting point. Sulphuric acid containing 17 per cent. SO_3 and 60 per cent. SO_3 have the lowest melting points, the one melting at -12° and the other at 0°C ., as indicated in the curve (Fig. 33).

The absorption of the SO_3 is carried out systematically in three towers, (1), (2), and (3). Tower (3)—the last of the series—is fed with 96-98 per cent. H_2SO_4 , and produces a fuming sulphuric acid containing 5 per cent. SO_3 . This acid is pumped through tower (2) and then through tower (1), leaving this first tower with 20-25 per cent. SO_3 .

Another method of procedure is this: The first of the three towers is filled with 98 per cent. H_2SO_4 , and into the top of this cylinder the SO_3 containing gas, previously cooled, is led through a bell with tooth edges immersed some 20 cm. under the surface of the H_2SO_4 . The acid is thus charged to about 25 per cent. SO_3 , and flows away from this cylinder (1) into a second cylinder (2) where it meets the gases coming from cylinder (1) and is thereby enriched to 60 per cent. SO_3 . The waste gases now emerging from cylinder (2) pass on into cylinder (3), and here enrich an ordinary 60 per cent. H_2SO_4 up to 98 per cent. H_2SO_4 , this last liquid being once more returned to cylinder (1) for fresh use.

Production of Anhydrous SO_3 and Fuming Acids.—Both the most concentrated acid as well as the pure anhydrous SO_3 can be obtained by distilling these fuming acids from retorts. However, the demand for pure SO_3 is very small; what is most used is a fuming sulphuric acid containing either 20 per cent. SO_3 or 60 per cent. SO_3 respectively.

100 per cent. H_2SO_4 (non-fuming) is now usually produced by diluting the stronger fuming acids with weaker acids, or with water.

Advantages of the Contact Process.—One great advantage of all acid produced by the contact process is that it is very pure, being arsenic-free owing to its method of production. Usually, however, it is coloured somewhat darkly owing to the presence of organic matter and iron. It may, however, be rendered water-clear by treating with a little barium peroxide (BaO_2) or lead peroxide (PbO_2), followed by filtration through sand.

The contact process is undoubtedly the cheapest process for producing very concentrated sulphuric acid, e.g., acid of over 66°Bé ., also fuming acid. Consequently there is no doubt that this process will control the market for the manufacture of the very concentrated acids required in the oil, colour, and explosives industries. Possibly also for export or transport over great distances, where carriage is expensive.

However, the chamber process still controls the market for the supply of weaker acids, e.g., as acids of 60°Bé . and below, such as are used in the manufacture of superphosphates, ammonium sulphate, sodium sulphate (salt cake), aluminium sulphate, etc. Indeed, the development of the contact process, by its competitive effect on the chamber process, has caused great improvements and economies to be made in the latter process, and it is now holding its own.

One great advantage of the contact process is the fact that it can be used for the complete utilisation of the SO_2 evolved in ore-roasting processes, even when the amount of SO_2 in the escaping gases is extremely small, so small that the lead chamber process cannot be used for converting this SO_2 into sulphuric acid.

The contact process has, therefore, a field of activity into which the chamber process cannot penetrate.

Costs of Manufacture.—The question of whether or no it is likely to be profitable to start the production of sulphuric acid depends upon many considerations, which belong at least as much to

the domain of the economist as to that of the chemical engineer, whom, however, it is always advisable to consult. The type of plant which should be erected depends partly upon the raw materials available, and largely upon the kind of acid the demand for which it is intended to meet. For the manufacture of superphosphate and sulphate of ammonia some modification of the tower or chamber process will probably long continue to hold the field; for the refining of oils one cannot make a definite pronouncement, since it depends upon circumstances, but where the main demand is for acid of over 95 per cent. H_2SO_4 a contact process is almost invariably the cheaper, certainly if acid of over 98 per cent. is required.

In well-conducted works on the large scale there should be a net profit to the manufacturer of some 15s. per net ton of tower acid, and more than double this on C.O.V. (concentrated oil of vitriol), or contact acid, and this in spite of fairly keen competition. In isolated places, where the cost and difficulty of carriage are considerable, these profits may be greatly increased.

The cost of a sulphuric acid plant is very great, owing chiefly to the large amount of lead on the one hand or the high cost of platinum on the other. A plant for the production of 20 tons of H_2SO_4 per twenty-four hours would cost at least £10,000, exclusive of land or engineers' fees.

Properties of Sulphuric Anhydride or Sulphur Trioxide (SO_3).—Sulphur trioxide is a white crystalline solid, existing in two modifications: the α -form, SO_3 , melts at 14.8° , boils at 44.88° , and at temperatures below 25° gradually polymerises in the β -form (SO_3)₂, which volatilises without fusion at $40^\circ C.$, and is reconverted into the α -form by distillation. The specific gravity of α -form is 1.944 at 11° , and of β -form it is 1.97 at $20^\circ C.$ Dry SO_3 is not corrosive, and shows no acid reaction. On heating to redness it decomposes to

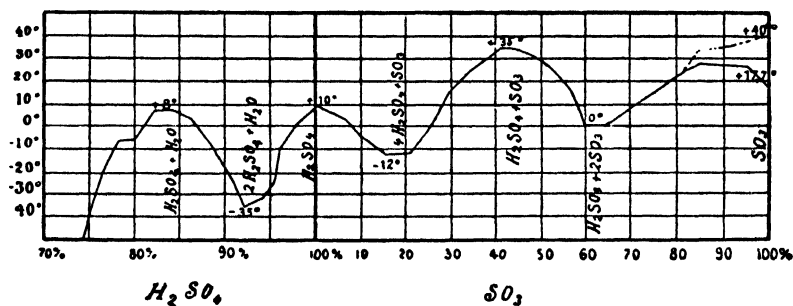


FIG. 33.—Mixtures of H_2SO_4 and SO_3 (after Knietzsch).

SO_2 and O, a temperature of $1,300^\circ$ being necessary for complete decomposition. Very hygroscopic; combines with water with explosive violence to form sulphuric acid, evolving much heat in so doing. SO_3 chars organic substances like sulphuric acid.

SO_3 unites with water to form a series of products represented by $m.SO_3.n.H_2O$. Of these the substances **pyrosulphuric acid**, $2SO_3.H_2O$ (a solid, M.P. $35^\circ C.$), **ordinary sulphuric acid**, $SO_3.H_2O$ (a liquid, M.P. $10.5^\circ C.$), **dihydrated sulphuric acid**, $SO_3.2H_2O$ (crystals, M.P. $8^\circ C.$), and **trihydrated sulphuric acid**, $SO_3.3H_2O$, are stated to exist.

The following curve (after Knietzsch) shows the behaviour of mixtures of SO_3 and water, the points of maximum and minimum melting points probably corresponding with definite compounds.

It will be seen that a mixture of H_2SO_4 and SO_3 of the composition 42 per cent. SO_3 (*i.e.*, 100 parts of mixture contain 42 parts of SO_3 and 58 of H_2SO_4), corresponding to $H_2SO_4.SO_3$, has the highest M.P. of $+35^\circ C.$, while mixtures containing 17 per cent. SO_3 and 60 per cent. SO_3 have the lowest melting points, *viz.*, $12^\circ C.$ and $0^\circ C.$

Consequently the liquids on the market under the name "sulphuric acid" may be represented by the general formula $m.SO_3.n.H_2O$, where m and n are whole numbers. On this basis sulphuric acids may be classified, technically, into two classes:—

1. **Non-fuming sulphuric acids, ordinary sulphuric acid,**
 $m\text{SO}_3 \cdot n\text{H}_2\text{O}$, where $m < n$.
2. **Fuming sulphuric acids,** $m\text{SO}_3 \cdot n\text{H}_2\text{O}$, where $m > n$.

We will consider each in turn.

(1) **The Non-Fuming or Ordinary Sulphuric Acids,** $m\text{SO}_3 \cdot n\text{H}_2\text{O}$, where $m < n$.—Ordinary concentrated sulphuric acid, H_2SO_4 ($\text{SO}_3 \cdot \text{H}_2\text{O}$, $m = n$), usually called "**Oil of Vitriol**" (short **O.V.**), appears on the market in a variety of forms, the chief of which are as follows: **Brown Oil of Vitriol**, a concentrated acid, usually a tower acid, or a badly concentrated chamber acid; as civilisation progresses this variety will doubtless tend to become more rare; it used to be known in commerce as **B.O.V.** Another variety of concentrated acid is **C.O.V.** This should have a specific gravity of $168^\circ\text{--}169^\circ$ Tw., and was formerly slightly discoloured and often not quite clear. It contains 93.95 per cent. H_2SO_4 . Much of the acid which is now sold as **D.O.V.** (distilled oil of vitriol) is merely concentrated acid, concentrated in modern plant under proper conditions, and sometimes brought up to strength by the addition of a small quantity of SO_3 or fuming acid, if the factory happens to possess a contact plant. Other qualities of acid are **tower acid** from the **Glover tower**, usually slightly brown in colour and $140^\circ\text{--}145^\circ$ Tw., and **chamber acid**, which may vary from $100^\circ\text{--}120^\circ$ Tw. Only the chamber acid should contain oxides of nitrogen in combination or solution. The Glover acid is the most impure (see pp. 235, 239).

The following table gives the properties of these commercial varieties of ordinary sulphuric acid at a glance:—

	Degrees Tw.	Degrees Bé.	Specific Gravity.	Percentage H_2SO_4 .
Chamber acid - - -	105 to 122	50 to 55	1.53 to 1.61	62 to 70
Glover tower acid - -	233 ,, 150	58 ,, 62	1.67 ,, 1.76	75 ,, 82
C.O.V. (Conc. Oil Vit. German, "66° acid") -	167	66	1.83 ,, 1.84	93 ,, 97

The monohydrate (*i.e.*, H_2SO_4) begins to boil at a temperature of 290° , which rises to 338° , though the actual strength of the acid falls through the evolution of SO_3 . Sulphuric acid of lower strengths is sometimes used for high temperature liquid baths.

The following are some approximate boiling points. For the strength of the acid represented by these degrees see table, p. 249.

Approximate Boiling Points

Acid.	F°.	Acid.	F°.
50° Bé	291	63° Bé	423
60° "	378	64° "	446
61° "	388	65° "	473
62° "	403	66° "	522

The strong acid evolves considerable heat when mixed with water—so much so that it should only be added slowly with continued stirring to the water, and never contrariwise. Water or its elements are absorbed with such avidity by the strong acid, that wood, cotton wool, and other substances of like character are at once charred by contact with it.

Sulphuric acid itself is quite colourless and odourless. It has a strongly acid taste, and is unpleasant or fatal if taken internally, according to the strength and quantity absorbed.

The best antidote is copious draughts of cold water, together with any suitable alkali, soda water, washing soda, lime, chalk, ammonia, ceiling or wall plaster suspended in water.

The strong acid does not corrode iron to any considerable extent ; however, it acts upon lead in a far greater degree than when dilute.

Recently acid-resisting irons have been placed on the market, which are remarkably resistant to corrosion by sulphuric acid. These are known as ironac, tantiron, duriron, and by other names on the Continent of Europe. They vary considerably in quality. They are all high silicon irons, and are intensely hard and somewhat more brittle than cast iron (see p. 236).

The action of sulphuric acid upon other metals is briefly as follows :—

Cold dilute sulphuric acid has little action upon the heavy metals ; zinc, iron, aluminium and most of the light metals are easily dissolved. Stronger acid attacks copper, mercury, and many other metals when heated, with evolution of SO₂. Lead is attacked by acid of about 140° Tw., and should not be used for the storage of acid of that gravity or over; however, iron is not appreciably acted upon by acid stronger than 140° Tw., and cast iron is but little affected except by the dilute acid ; alloys of iron and silicon, including cast silicon itself, are even less corroded.

Sulphuric acid, when heated, evolves SO₃ as a suffocating gas, forming dense fumes in moist air owing to the absorption of water vapour. At a still higher temperature it decomposes into a mixture of SO₂, SO₃, oxygen, and H₂O.

Sulphuric acid expands but little upon heating ; nevertheless, it is necessary to apply a small correction for temperature when determining acid-content by density. This correction varies between 0.0006 for acids up to 1.170, to 0.0010 for acids up to a specific gravity of 1.840 per degree Centigrade.

The following table gives the specific gravity of ordinary non-fuming sulphuric acid (O.V. stands for "Oil of Vitriol" of 66° Bé., or 167° Tw., containing 93.5 per cent. H₂SO₄) :—

SPECIFIC GRAVITY OF NON-FUMING SULPHURIC ACID

Degrees Baumé.	Specific Gravity.	Weight of 1 Cub. Ft. in Pounds.	Per Cent. O.V.	Pounds O.V. in 1 Cub. Ft.	Degrees Tw.	Per Cent. H ₂ SO ₄ .
0	1.000	62.37	0.00	0.00	0	0.000
1	1.007	62.81	1.00	0.63	1½	0.935
2	1.014	63.24	2.50	1.58	3	2.337
3	1.021	63.68	3.66	2.33	4	3.422
4	1.028	64.12	5.00	3.21	5½	4.675
5	1.036	64.62	6.00	3.88	7	5.610
6	1.043	65.05	7.00	4.55	8½	6.545
7	1.051	65.55	8.00	5.24	10	7.480
8	1.058	65.99	9.00	5.94	11½	8.415
9	1.066	66.49	10.25	6.82	13	9.584
10	1.074	66.99	11.50	7.70	15	10.752
11	1.082	67.48	12.50	8.44	16½	11.687
12	1.090	67.98	13.60	9.25	18	12.716
13	1.098	68.48	14.70	10.07	19½	13.744
14	1.107	69.04	16.00	11.05	21½	14.960
15	1.115	69.54	17.00	11.82	23	15.895
16	1.124	70.10	18.25	12.79	25	17.064
17	1.133	70.67	19.60	13.85	26½	18.326
18	1.142	71.23	21.00	14.96	28½	19.635
19	1.151	71.79	22.00	15.79	30	20.570
20	1.160	72.35	23.25	16.82	32	21.739
21	1.169	72.91	24.50	17.86	34	22.907
22	1.179	73.53	26.00	19.12	36	24.310
23	1.188	74.10	27.25	20.19	37½	25.479
24	1.198	74.72	28.50	21.30	39½	26.647
25	1.208	75.34	30.00	22.60	41½	28.050
26	1.218	75.97	31.25	23.74	43½	29.219
27	1.229	76.65	32.75	25.10	46	30.621
28	1.239	77.28	34.00	26.28	48	31.790
29	1.250	77.96	35.50	27.68	50	33.192
30	1.261	78.65	37.00	29.10	52	34.595

Specific Gravity of Non-Fuming Sulphuric Acid—continued.

Degrees Baumé.	Specific Gravity.	Weight of 1 Cub. Ft. in Pounds.	Per Cent. O. V.	Pounds O. V. in 1 Cub. Ft.	Degrees Tw.	Per Cent. H ₂ SO ₄ .
31	1.272	79.33	38.37	30.44	54½	35.876
32	1.283	80.02	39.75	31.81	56½	37.166
33	1.295	80.77	41.25	33.32	59	38.569
34	1.306	81.46	42.62	34.72	61	39.850
35	1.318	82.20	44.00	36.17	63½	41.140
36	1.330	82.95	45.50	37.74	66	42.542
37	1.342	83.70	47.00	39.34	68½	43.945
38	1.355	84.51	48.50	40.99	71	45.347
39	1.368	85.32	50.00	42.66	73½	46.750
40	1.381	86.13	51.50	44.36	76	48.152
41	1.394	86.94	53.00	46.08	79	49.555
42	1.408	87.82	54.50	47.86	81½	50.957
43	1.421	88.63	56.00	49.63	84	52.360
44	1.436	89.56	57.50	51.50	87	53.762
45	1.450	90.44	59.00	53.36	90	55.165
46	1.465	91.37	60.50	55.28	93	56.567
47	1.479	92.25	62.00	57.50	96	57.970
48	1.495	93.24	63.50	59.21	99	59.372
49	1.510	94.18	65.00	61.22	102	60.775
50	1.526	95.18	66.50	63.29	105	62.177
51	1.542	96.17	68.00	65.40	108½	63.580
52	1.559	97.23	69.70	67.77	112	65.169
53	1.576	98.30	71.30	70.09	115	66.665
54	1.593	99.36	73.00	72.53	118½	68.255
55	1.611	100.48	74.60	74.96	122	69.751
56	1.629	101.60	76.20	77.42	126	71.247
57	1.648	102.79	77.87	80.04	129½	72.808
58	1.666	103.91	79.50	82.61	133	74.332
59	1.686	105.16	81.30	85.50	137	76.015
60	1.706	106.40	83.00	88.31	141	77.605
61	1.726	107.65	85.00	91.50	145	79.475
62	1.747	108.96	87.00	94.80	149½	81.345
63	1.768	110.27	89.00	98.14	153½	83.215
64	1.790	111.64	91.62	102.29	158	85.665
64½	1.801	112.33	93.12	104.60	160½	87.067
64¾	1.897	112.70	94.00	105.94	161½	87.890
65	1.812	113.01	94.70	107.02	162½	88.544
65½	1.818	113.39	95.66	108.47	163½	89.442
65¾	1.824	113.76	96.80	110.12	164¾	90.508
66	1.830	114.14	98.33	112.23	166	91.939
66	1.835	114.45	100.00	114.45	167	93.500

Impurities in Non-Fuming Sulphuric Acids.—The chief impurities in the acid are arsenic, soda, iron, aluminium, and lead. Of these only the arsenic is of great consequence, as when used for the inversion of cane-sugar, or in the manufacture of other food-stuffs, it must obviously not contain an appreciable proportion of arsenic, and its presence in sulphuric acid is objected to. The actual maximum quantity admissible, according to Liehner, is one part of As₂O₃ in 200,000 of H₂SO₄. Sulphuric acid, except that made by the platinum contact processes, is seldom, if ever, free from arsenic, that element being one of the most widely distributed in nature. The usual method of detection and estimation consists in the reduction of the arsenic—usually present as arsenious or arsenic acid—to arseniuretted hydrogen, and the decomposition of this compound by heat, with the deposition of the element upon the heated glass tube (Marsh test). Iron may be easily estimated by reduction and titration with permanganate. Lead, if in solution, is best estimated by dilution with an equal volume of water and two volumes of alcohol. The lead sulphate is precipitated, and may be collected, washed, ignited, and weighed in the ordinary way.

It may happen that sulphuric acid—if drawn from the last chamber of a set—will contain a fairly large amount of oxides of nitrogen. These may be readily estimated by the nitrometer. On the contrary, it may happen that SO_2 is present in solution, in which case it is hardly possible for an appreciable amount of oxides of nitrogen to be also present. The SO_2 may be conveniently determined by standard iodine solution.

Chamber acid should only contain minute amounts of SO_2 or oxides of nitrogen.

Fuming Sulphuric Acids, $m\text{SO}_2 \cdot n\text{SO}_3$, where $m > n$.—These acids—known in Germany as “oleum”—appear on the market in all strengths, of which the commonest is 45 per cent. SO_3 . This means that it contains 55 parts of H_2SO_4 and 45 of SO_3 . The acids from 0.40 per cent. and from 60.70 per cent. SO_3 are oily liquids, but from 40.60 per cent. and from 70 per cent. upwards are solids in the form of colourless needles (see curve on p. 247). It can only be handled with difficulty, owing to its hygroscopic character. The acids up to 45 per cent. may be melted with a gentle heat (30°C). The sample is then carefully diluted—after measurement—in two stages if necessary, first with monohydrate and then into water, and tested in the same way as with the other sulphuric acids. It is usually packed in air-tight wrought-iron drums, upon which this strength of acid has practically no action.

SPECIFIC GRAVITIES OF FUMING SULPHURIC ACID AT 35°C .
(Knietsch. *Ber.*, 1901, 4101.)

Free SO_2 Per Cent.	Specific Gravity.	Free SO_2 Per Cent.	Specific Gravity.	Free SO_2 Per Cent.	Specific Gravity.
Degrees.		Degrees.		Degrees.	
0	1.8186	34	1.9405	68	1.9600
2	1.8270	36	1.9474	70	1.9564
4	1.8360	38	1.9534	72	1.9502
6	1.8425	40	1.9584	74	1.9442
8	1.8498	42	1.9612	76	1.9379
10	1.8565	44	1.9643	78	1.9315
12	1.8627	46	1.9672	80	1.9251
14	1.8692	48	1.9702	82	1.9183
16	1.8756	50	1.9733	84	1.9115
18	1.8830	52	1.9749	86	1.9046
20	1.8919	54	1.9760	88	1.8980
22	1.9020	56	1.9772	90	1.8888
24	1.9092	58	1.9754	92	1.8800
26	1.9158	60	1.9738	94	1.8712
28	1.9220	62	1.9709	96	1.8605
30	1.9280	64	1.9672	98	1.8488
32	1.9338	66	1.9636	100	1.8370

Conveyance and Handling of Sulphuric Acid.—Chamber or tower acid is usually stored and conveyed in lead-lined wooden tanks. Vessels are now made of acid-resisting steel, glass-enamel coated steel, and homogeneous lead-coated iron (on the metal). All of these have their disadvantages, however.

Where acid is used in quantity it is, of course, usually made near to the place where it is required, and the serious difficulties of handling and storing are to a great extent overcome. The chambers, where used, are usually employed for storing the acid made.

In smaller quantity bottles or glass carboys are used for all strengths.

For acid of 140°Tw . or over, steel or iron vessels may be safely employed if a few precautions are observed. The vessel must not be closed to the outside air, as hydrogen might be evolved therein, and considerable pressure accumulated, and the vessel should not be left entirely open, as moisture is likely to be absorbed, and severe corrosion take place near the air-acid surface. In order to effect a compromise, the wisest plan is to employ a vent-pipe sealed in a few inches of strong acid, and so arranged that air can be drawn in or driven out through it.

It must be remembered that, although hydrogen has an exceedingly high coefficient of diffusion, it is quite possible for an explosive mixture to be lurking in an iron vessel which has been or is employed for conveying or storing sulphuric acid. The rule should be that **no** naked light should be brought near such a vessel.

Sulphur trioxide is put up in sheet-iron drums soldered up tight, much the same as those in which caustic soda finds its way to market.

Uses of Sulphuric Acid.—In almost every industry some sulphuric acid is used. In more or less dilute form chamber-tower acid is used in enormous quantities for the purpose of rendering soluble mineral and animal phosphates (superphosphate manufacture for manures); for decomposing salt with the production of sodium sulphate and hydrochloric acid, thus indirectly in the manufacture of soda-ash, soap, glass, bleaching powder, etc.; in pickling (*i.e.*, cleaning) iron goods previous to tinning or galvanising; in preparing other acids, and in many other ways.

It is important to note that two processes of treating phosphate rock which have been recently introduced may greatly diminish the amount of sulphuric acid now required for the rendering soluble of the tricalcium phosphate. The one process is a calcining process—the Newberry-Fishburne—and the other consists in the use of nitric acid instead of sulphuric acid, as proposed by Eyde, of Norway.

Stronger acid, tower acid, and C.O.V. (concentrated oil of vitriol) is used in the purification of most kinds of oil, including petroleum and tar oils, as a drying agent, in the production of organic dyes, in the nitration of organic substances such as glycerin, cellulose, benzol, etc.

The fuming acid is now mainly employed in the manufacture of explosives, such as nitroglycerin and nitrocellulose, where it is added to weaker recovered acid; and in the dye industry, small quantities being used for drying air and other purposes.

Detection and Estimation of Sulphuric Acid.—In the absence of soluble silicofluorides, soluble sulphates produce a difficultly soluble precipitate of barium sulphate. This precipitate is difficultly soluble in acids and alkalis, though slightly so in strong hydrochloric acid. (Strong hydrochloric acid produces a precipitate of BaCl_2 if added to a strong solution of the latter; the precipitate, however, is completely soluble in water in the absence of sulphates.)

Sulphuric acid in the free state and in absence of other acids, or after boiling in presence of other volatile acids, may be directly estimated by titration with standard alkali. It may also be determined by precipitation with barium chloride and collection, washing, ignition, and weighing of the resulting BaSO_4 .

Sulphuric acid is usually estimated commercially by the specific gravity. For works' control this is satisfactory under most conditions, and as a seller it is not infrequently convenient. However, the specific gravity may be considerably increased by the presence of sodium, aluminium, and iron sulphates, so that the buyer should never consent to a contract being based on specific gravity only. Two particularly unscientific scales are employed—the one is that of Twaddell, and is in general use in Great Britain; the other is that of Beaumé, and is that employed in the United States of America and on the European Continent. The rules for the interconversion of specific gravity and the two arbitrary scales are given in the appendix.

SECTION XX

MANUFACTURE OF SULPHUR DIOXIDE AND SULPHITES

BY GEOFFREY MARTIN, D.Sc., Ph.D., and J. LOUIS FOUCAR, B.Sc.

Manufacture of Sulphur Dioxide and Sulphurous Acid

THE burner-gases (see pp. 211-221) from pyrites, zinc blende, or spent oxide from gas works are sometimes worked for the manufacture of **anhydrous sulphur dioxide** (SO_2). The usual process is that of **Hanisch and Schröder** (see Fig. 1).

The gases from the roasting furnaces, which must contain at least 4 per cent. SO_2 by volume, otherwise too much water is required for complete condensation of the SO_2 , enter through **A**, pass under the leaden pans **B B** and heats them, then pass into the tower **C C**, packed with

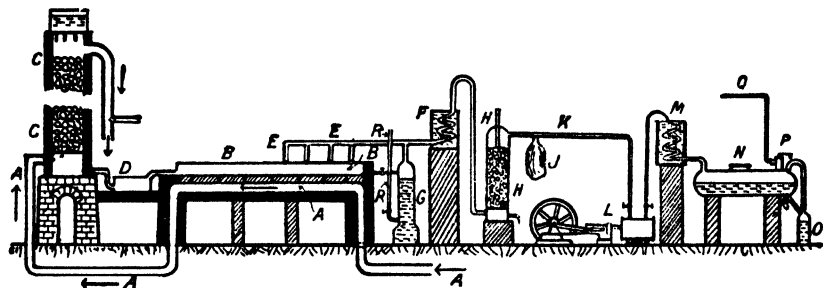


FIG. 1.—Hanisch and Schröder's Process for the Manufacture of Anhydrous Sulphur Dioxide.

coke, down which cold water trickles. This absorbs practically all the SO_2 , which thus collects as a solution at the bottom of the tower, and from there runs into the preliminary heater **D**, which is composed of thin lead plates, round which hot waste liquids (from a later stage of the operations) circulate and give up their heat usefully. The SO_2 solution leaves **D** at a temperature of about 85°C ., and then runs over the leaden pans **B B**, where the heat of the flue gases causes it to boil, thus expelling SO_2 through the pipe **E E** to the cooling worm **F**, where it is cooled, and most of the moisture accompanying it runs away into **G**. The SO_2 gas is then dried in a tower **H H**, packed with coke down which a stream of concentrated sulphuric acid trickles, and then passes a taffeta bag **J** (which regulates the pressure) along the pipe **K** into the bronze pump **L**, where, under a pressure of $2\frac{1}{2}$ atmospheres, it is liquefied, cooled in **M**, run into the cast-iron boiler **N**, whence it can be drawn off as required. The moisture saturated with SO_2 , which collects in **G** (a small tower packed with lead wire), is boiled by live steam entering through **R R**. The SO_2 is thus boiled out and recovered, whereas the hot liquid so obtained is used for heating the preheater **D**.

The anhydrous liquid SO_2 so obtained is sold commercially of 99.8 per cent purity.

For many purposes, *e.g.*, for bleaching sugar, cellulose, etc., also for treating wood pulp for making into paper (see **Martin's "Industrial Chemistry: Organic"**), there is required a more or less dilute **solution of sulphur dioxide in water**.

This is easily obtained by bubbling the gas, rich in SO_2 either from pyrites

burners (see p. 211) or from other suitable burners, through water (after first washing with water).

In order to obtain a strong solution both gas and water must be well cooled.

For many purposes it is essential that the sulphurous acid (SO_2 solution in water) should be free from sulphuric acid. (*E.g.*, the presence of sulphuric acid in the bisulphite used for treating wood pulp is very injurious to the fibre.)

Hence, as pyrites burner-gas nearly invariably contains SO_3 (see p. 221), and the plant for burning the pyrites must be close to the place of consumption of the aqueous solution, many manufacturers find it cheaper to make their own sulphurous acid and sulphite by **burning sulphur** in a suitable burner, and leading the gas into water.

There are two general types of furnace in which sulphur is burned: of these one intentionally volatilises the sulphur and ensures complete combustion of the gas, the other burns some of the sulphur, and condenses that portion which is volatilised but not burned. Of these there are again sub-types.

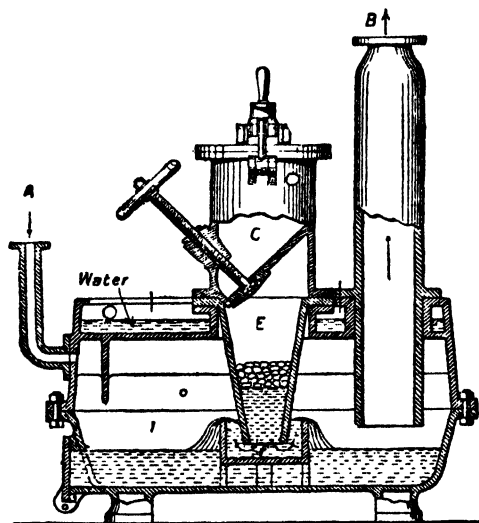


FIG. 2.—Sachsenberg Sulphur Burner.

Of the first type the most noteworthy is the **Tomblee and Paull**. It consists of a horizontal, cylindrical, lined iron shell 8 ft. long and 3 ft. in diameter, with conical ends, making one revolution in two minutes. At one end is a hopper and worm-feed with sliding dampers, at the other a rectangular cast-iron box of 37 cub. ft. capacity, provided with sliding damper and vertical uptake, which leads to a brick dust-catcher. The sulphur is fed in lumps which melt just before dropping into the body of the burner, and a complete liquid coating is formed on the inside of the shell as it revolves. The combustion box and vertical uptake complete the combustion. The furnace, box, and uptake are all lined with refractory material. Using 98 per cent. Louisiana sulphur, it is only necessary to clean out the dross which collects once in two months. The appliance will burn 6,000 lbs. of S per day.

Hand-fed burners of the first type are now completely obsolete, and will not be described; some of them employ secondary air to ensure the complete combustion of the sulphur. The writer has found this very satisfactory if such air be preheated.

Of the second type of furnace may be mentioned the **Sachsenberg burner** (Fig. 2). It is particularly suitable for the production of SO_2 in small quantities, and which is required to be as free as possible from SO_3 , as is required for bleaching, in the manufacture of glue, in the refining of sugar, etc.

In starting up sulphur is placed in and ignited by inserting a red-hot iron bar through the hole in the body (which, when working, is closed by a plug). The hopper C and funnel E are filled with sulphur, which melts and forms a liquid seal in F. Air is drawn through A, and the SO_2 passes out through B. The upper portions of the body and funnel are water-cooled. Compressed air may be introduced into B to burn any sulphur sublimed there. The slight coating of sulphur on the pipes, etc., is found to effectually preserve them. A burner of this type, measuring only 8 ft. by 3 ft., will burn no less than one ton of sulphur per twenty-four hours.

A more modern type of plant is that patented and produced by Mr H. B. P. Humphries, of Queen Anne's Chambers, London, S.W.

Fig. 3 shows a furnace of medium size, while a complete installation is outlined in Fig. 4.

The plant may be worked under considerable gas pressure, and arrangement is made for

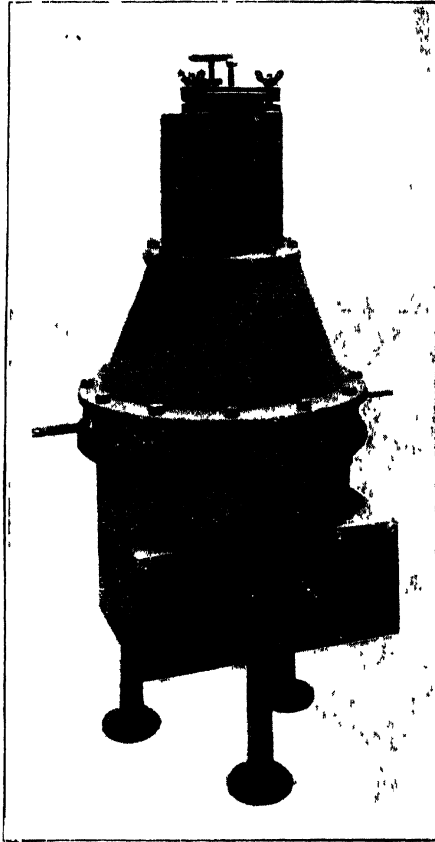


FIG. 3.—Humphries' Sulphur Burner.

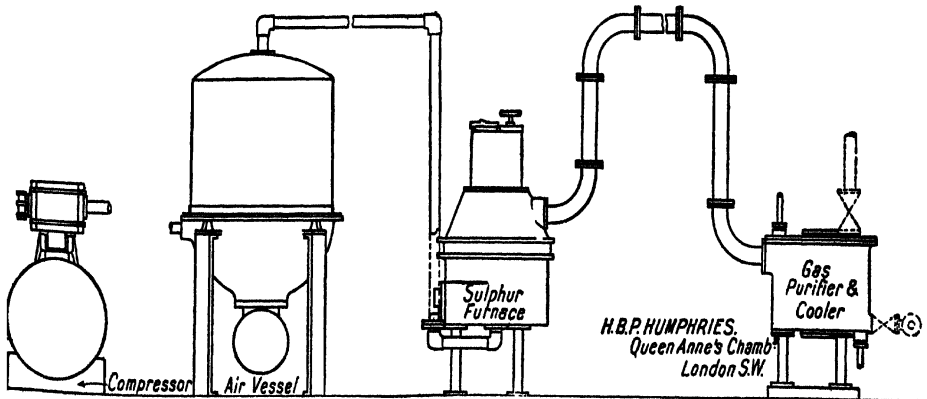


FIG. 4.—Humphries' Plant for making Sulphur Dioxide.

replenishing the sulphur without any disturbance whatever of the working. Special attention is given to the construction of the joints and to facilities for cleaning out. The latter is seldom necessary—once every few weeks, or maybe months—depending on the work required from the plant. For some purposes, such as sugar defecation, a feature is incorporated which diminishes the content of SO_2 in the gases to a minimum, conformably with the most recent recommendations of sugar experts.

Installations of single units and of batteries are in use throughout the world. The smallest size burns $2\frac{1}{2}$ lbs. sulphur per hour, while a large size burns 50 lbs. per hour.

The sulphur furnace, cooler, and system in general are covered by patents.

Properties and Uses of Sulphur Dioxide and Sulphurous Acid.—Colourless gas, with a pungent, suffocating smell, incombustible, and a non-supporter of combustion. Sp. gr. = 2.26 (air = 1).

By cooling or compression it may be condensed to a colourless mobile liquid, boiling at 10°C . under atmospheric pressure. The pressures exerted by liquid SO_2 at various temperatures are:—

Temperature	-	-	-10°C .	$+0^\circ\text{C}$.	$+10^\circ\text{C}$.	$+20^\circ\text{C}$.	$+30^\circ\text{C}$.	$+40^\circ\text{C}$.	$+50^\circ\text{C}$
Pressure (in atmospheres)	-	-	0	0.53	1.26	2.24	3.51	5.15	7.18

Critical temperature = 156°C .; critical pressure = 78.9 atmospheres. The latent heat of evaporation is large, being 93.4 calories per kilo at -10°C .

Liquid SO_2 does not act upon iron, and is therefore put up in steel cylinders, being used in refrigerating machines. The gas is also used in bleaching, and for antiseptic purposes.

Its chief advantages for this purpose are its fairly high latent heat and pungent smell, the latter giving timely warning of any escape.

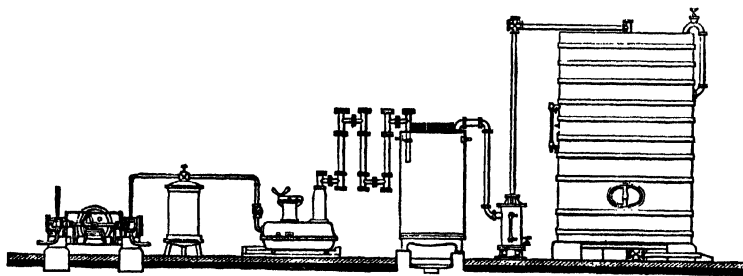


FIG. 5.—Complete Plant for Making Solution of Sulphur Dioxide.

SO_2 is very soluble in water (water at 0°C . dissolves 79.8 vols. of SO_2 , at 20° 39 vols., at 40°C . 19 vols.); considerable heat is evolved in the process of solution, and the liquid behaves as if it were a solution of sulphurous acid (H_2SO_3).

It corrodes many metals, such as wrought iron and zinc, decomposes carbonate, forms salts with most metals, and generally behaves like an acid.

Uses.—The gas or its aqueous solution is mainly used for bleaching and antiseptic purposes, in sugar purification, and in making large numbers of organic chemicals.

The most important use is undoubtedly in paper making, where vast quantities are used in the form of calcium bisulphite. Large quantities are also used in the Hargreaves saltcake process (see p. 289).

Much sodium bisulphite is used under the name of "antichlor," in order to withdraw the last traces of chlorine from goods bleached with chlorine. Solid sodium sulphite ($\text{Na}_2\text{SO}_3 + \text{H}_2\text{O}$) and potassium metasilphite ($\text{K}_2\text{S}_2\text{O}_5$) are both made on the large scale.

Analysis.—Sulphites or other combinations of sulphurous acid are readily recognised by their smell on acidification with sulphuric acid, by the bleaching properties of the resulting gas, by its discoloration of solutions of permanganate and iodine, and its reduction to H_2S in presence of nascent hydrogen (zinc or aluminium). Sulphur dioxide may be estimated by standard iodine titration, by oxidation to sulphuric acid and precipitation as barium chloride or titration with standard alkali in the case of its aqueous solution, and in the absence of other acids.

The air of towns near metallurgical works, smelters, or calciners usually contains sulphur dioxide, which slowly oxidises with the formation of sulphuric acid or possibly of ammonium sulphate. If it exceeds a certain amount ($\frac{1}{1000}$ volume), serious damage will be done to vegetation, which cannot seem to become accustomed to it.

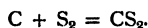
SECTION XXI

MANUFACTURE OF OTHER SULPHUR COMPOUNDS

By GEOFFREY MARTIN, D.Sc., Ph.D.

Carbon Disulphide (CS₂)

Manufacture.—By passing sulphur vapour over heated carbon, when the two unite thus :—



At one time the heating was effected externally in retorts, charcoal and unrefined sulphur being employed.

At the present time internal electrical heating is employed, and the substance is now made on the large scale at Penn Yan, New York, America.

The electrical process for the manufacture of CS₂ has been fully described by Taylor (*Journ. Franklin Inst.*, 1908, 83, 141-161; also United States Patents, 688,364, 10th December 1901, and 871,971, 26th November 1907). Fig. 1 shows one of Taylor's smaller furnaces. It consists of a vertical lined cylinder into which a mixture of sulphur and charcoal is fed in at the top through the opening *x* (from a gas-tight charger). The heating is effected electrically, the current passing through the carbon electrodes DD at the base of the furnace.

There are four of these electrodes arranged at right angles to each other something like a cross. Our illustration shows only two. The metallic portions of the electrodes are kept cool by a stream of sulphur, which enters through the hoppers *n*, fills the annular chambers *o*, and falls on to the electrodes, melts, and flows to the bottom of the furnace.

There is thus an **annular layer** of sulphur surrounding the lower part of the furnace, which is gradually melted and finds its way to the reaction zone. This arrangement absorbs heat which would otherwise be radiated from the walls of the furnace, and so be lost.

At *k* are pipes through which broken carbons are passed (refuse from the manufacture of arc-light carbons) which reinforce the main carbons. These broken carbons pass over the electrodes and convey the current from the electrodes to the charcoal, and prolong the lives of the electrodes. The current is usually passed from one electrode to the other immediately opposite, across the intervening charcoal. The current, however, can be switched across to an adjacent electrode to burn away obstructions which may prevent the descent of the charge in the furnace shaft. The sulphur melts, comes into contact with the hot electrodes, and is transformed into vapour, which passes up through the layer of charcoal in the shaft and unites with the charcoal to form CS₂ (C+S₂=CS₂). As the charcoal thus burns away in the region of most intense heat the charge in the shaft gradually descends in order to take its place. The shaft is kept filled with the mixture of charcoal and sulphur, fresh material being charged in through *x* as the layer sinks in the shaft. The vaporous CS₂ passes out through *r* into the condensing towers.

This furnace is 16 ft. in diameter and 41 ft. high (see Fig. 1). It runs continuously for about one year before cleaning out or renewing the electrodes. The insulated electrodes at the base are connected by means of aluminium bars, 6 in. wide and $\frac{3}{8}$ in. thick, with dynamos of average voltage, 50. Yield of CS₂ is 14,000-25,000 lbs. of CS₂ per twenty-four hours.

Purification of CS₂.—This is effected by distillation in vessels of sheet zinc on the water bath, with the usual condensing coils.

In the first portions of the distillate are foul-smelling impurities. The last portions contain sulphur. The middle portions are the purest.

It may be purified by adding caustic soda (which retains much H_2S) and distilling. Also by mixing with milk of lime and distilling.

The vapours may be passed through solutions of iron, lead, and copper in order to remove impurities. Agitating with mercury until no blackening occurs is efficient. Cloez adds 0.5 per cent. $HgCl_2$, which removes the evil-smelling sulphur compound, decants, adds 0.02 per cent. of an inodorous fat, and distils the mixture on the water bath. Another process is to add 2-3 per cent. of dried $CuSO_4$, shake, allow to settle, and rectify over dry $CuSO_4$.

Another technical method is to wash with lime-water until clear, and distil with 1 per cent. of colourless oil and a little water containing acetate of lead dissolved.

Transport and Storage.—The substance is sold in iron drums provided with a screw stopper. Since carbon disulphide is very volatile, and its vapour forms a highly explosive mixture with air, the storeroom should be isolated from other buildings and be kept well ventilated.

The carbon disulphide should be drawn off for use through a syphon.

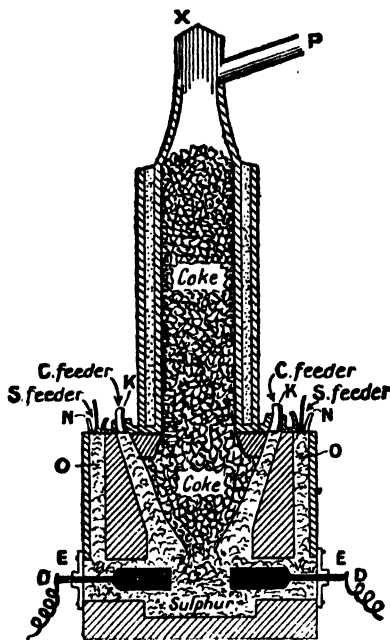


FIG. 1.—Taylor's Carbon Disulphide Furnace.

Properties.—Colourless, very volatile liquid. B.P., $46^\circ C$. Solidifies at $-112^\circ C$. Vapour ignites at the low temperature of $149^\circ C$. in air, and so is dangerous to handle near a naked light. Refract. ind., 1.645; sp. gr., 1.29215, 0° to 4° .

The pure substance has a pleasant ethereal smell. The commercial has a foetal odour. Immiscible with water; soluble only to extent of 0.1 per cent. Aqueous solution acts as an antiseptic. Liquid dissolves fats, oils, camphor, caoutchouc, sulphur, phosphorus, iodine, etc.

Uses.—Almost wholly as a solvent. However, it is so dangerously inflammable that its use, even in the cold, is being superseded by light petroleum, or non-inflammable chlorinated hydrocarbons.

It is used also as an insecticide, especially for destroying weevils, etc., in grain. A little sprinkled on the grain kills the pests without injuring the grain. Also it is used as a solvent for rubber in the preparation of vulcanised caoutchouc, seamless joints, etc.

Sodium Thiosulphate, $\text{Na}_2\text{S}_2\text{O}_3 \cdot 5\text{H}_2\text{O}$ (Hyposulphite)

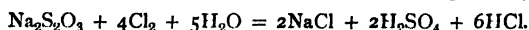
This salt, formerly made by the addition of sulphur to sodium sulphite, is now manufactured on the large scale from alkali waste (Leblanc process) by exposing it to air for a week or more, turning over from time to time to bring every part into contact with air, lixiviating with water, adding sodium carbonate to precipitate any calcium, decanting from the precipitate, evaporating, and crystallising. It is also prepared from bicarbonate by boiling with an equivalent quantity of sulphur and treating with SO_2 ; this method is obviously suitable only to ammonia-soda work. Further methods consist in the oxidation of sodium hydrosulphide at 150° , in passing H_2S and air or oxygen over sodium sulphide at 300°C. , in fusing sodium sulphite with sulphur, etc.

Properties.—Neutral transparent prisms. Melts in own water of crystallisation. Very soluble in H_2O , forming supersaturated solutions (217 parts of salt will be held in solution by 100 parts of water at 0°C.).

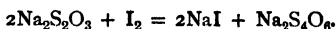


FIG. 2.—External View of Plant for Producing Sulphur Disulphide.

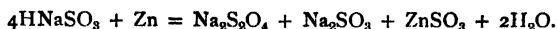
Uses.—For removing last traces of Cl from bleached goods (antichlor):—



In photography for “fixing,” since it dissolves silver chloride, bromide, etc. Also used as a source of SO_2 in **bleaching oils, straw, wool**, etc.; as a preservative in sugar manufacture; as a mordant in medicine; also in analysis, since it absorbs iodine according to equation:—



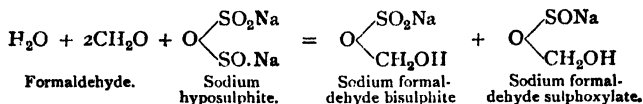
Sodium Hyposulphite.— $\text{Na}_2\text{S}_2\text{O}_4$ is made on the large scale as a reducing agent in the dyeing and calico-printing industries, by the action of zinc on a solution of sodium bisulphite, the zinc being removed by lime, and the sodium hyposulphite being precipitated by adding salt, when $\text{Na}_2\text{S}_2\text{O}_4 \cdot 2\text{H}_2\text{O}$ is obtained:—



By treating the unstable compound $\text{Na}_2\text{S}_2\text{O}_4 \cdot 2\text{H}_2\text{O}$ with alcohol, the water of crystallisation is removed, and the resulting anhydrous salt is fairly stable, being

sold under the name "**Hydrosulphite B.A.S.F.**," containing 90 per cent. of hyposulphite.

This cannot be used in calico-printing as a discharger, since the steam oxidises it. Instead there is used a formaldehyde derivative, prepared thus:—



The mixture of salts is sold as "**Hydrosulphite N.F.**," "**Rongalite conc.**"

These, although they do not reduce at ordinary temperatures, yet in boiling or steaming they are decomposed into their constituents, which act as reducing agents in the usual way. They are now used as discharges for cotton.

By treating sodium formaldehyde bisulphite with zinc the whole of this can be converted into sodium formaldehyde sulphonylate, being sold under the names "**Hyraldite C. Ext.**," "**Hydrosulphite N.F. conc.**," etc., of formula $\text{NaHSO}_2\cdot\text{CH}_2\text{O}\cdot 2\text{H}_2\text{O}$.

Other uses of sodium hyposulphite are as a decoloriser for sugar juice, and as an oxygen absorber in gas analysis.

Sulphuretted Hydrogen (H_2S) is an evil-smelling, colourless gas. Poisonous when inhaled. Large quantities are produced in the recovery of sulphur from alkali tank-waste by the Chance process, and a smaller amount from gas liquor. Its uses are somewhat limited.

It was proposed to pump it into steel bottles in liquid form in a similar manner to that in which SO_2 and NH_3 appear in commerce, but the corrosion of the valves was so considerable that the effort proved a failure.

As an analytical reagent it long held the field, and even now is invaluable for many purposes.

Its uses in industry are practically confined to the precipitation of metals, and to a limited extent in the preparation of sulphur dye-stuffs.

For Persulphuric Acid. see Section XLIII., p. 424.

SECTION XXII

THE SALT INDUSTRY

By GEOFFREY MARTIN, D.Sc., Ph.D.

LITERATURE

- O. M. SMITH.—*Ind. Eng. Chem.*, 1932, **24**, 547.
 FÜRER.—“Salzbergbau und Salinenkunde.” 1900.
 BUSCHMAN.—“Das Salz dessen Vorkommen und Verwertung.”
 WATTS.—“Sodium Chloride.” Thorpe’s “Dict. Applied Chem.,” Vol. V., 1913.
Chemical Trade Journ., February 1910, 179.
 WARD.—*Journ. Soc. Arts*, 1894-1895, **43**, 78.
 GEOFFREY MARTIN.—“The Salt Industry.” *Chemical World*, 1914, **3**, 135.
 —“The Manufacture of Salt.” *Products and Machinery*, March 1914, p. 40.
 “Geology and Economic Minerals of Canada.” Department of Mines, Ottawa, 1909.
 THOMPSON.—*Trans. Manchester Geol. and Min. Soc.*, **30**, 105.
 DAWKINS.—*Quart. Geol. Soc.*, **58**, 1902.
 WILSON.—*Quart. Geol. Soc.*, **58**, November 1888.
 MARLEY.—*N. of England Inst. of Mining Engineers*, 1892, p. 27.
 WARD.—*Trans. Manchester Geol. Soc.*, **18**, 396, **19**, Part VII., 1886-1887.
 RIEMANN.—“Monographien über Chemisch-technische Fabrikation-methode,” Band 18.
 Halle, 1909.
 “Home Office Report on Mines and Quarries,” Part III. (annual).
 “Final Report on First Census of Production,” 1907, pp. 56-58, 81-82 (see also the last Census of Production.)

Much curious information regarding salt is given in the following articles in magazines:—
 E. GOLDSMITH.—“Salt-making in the Far West.” *Journ. Franklin Inst.*, 1904, **159**, 45.

- S. HARTMANN.—“Salt Meadows.” *Harper’s Monthly Mag.*, 1902, **106**, 959.
 A. INKERSLEY.—“Salt Sea in the Desert of Colorado.” *World’s Work*, 1902, **4**, 2105.
 PARKER.—“Salt and Gas Wells of China.” *Chambers’s Journ.*, 1896, **73**, 545.
 “Salt Formation in Cheshire.” *Cornhill Mag.*, 1892, **66**, 256.
 “Salt Region, Cheshire.” S. Baring Gould, *Good Words*, 1893, **34**, 59.
 “Salt Works.” *New Eng. Mag.*, New Series, 1909, **41**, 489-492.

The extraction of magnesium salts from sea-water is dealt with by B. Panteleimonov, *Chem. Ztg.*, 1930, **54**, 153; *Chem. and Ind.*, 1930, 348.

COMMON salt, sodium chloride (NaCl), is a mineral found in great abundance in nature. Economically the substance is of great importance, for not only is it an essential component of the food of man and animals, but also it is the source whence, industrially, most of our sodium salts are manufactured: for example, it is the raw product for the manufacture of salt cake (sodium sulphate), sodium carbonate, caustic soda, soap, etc. The only exception to this rule is sodium nitrate, which is found native in very large quantities in Chile.

Occurrence of Salt.—Immense deposits in the form of rock salt are found in many parts of the world. The principal deposits occur at Wieliczka, in the Carpathians (where the deposits are said to be 1,200 ft. thick and the mines have been worked since the eleventh century); at Cordan (near Barcelona) in Spain, where there are two hills of very pure rock salt, each about a mile in circumference; at Stassfurt in Germany, where the layers exceed 3,000 ft. in thickness and are first reached at a depth of 832 ft. from the surface. It also occurs in the Alps at Salzburg, Hall, Hallein, Ischl, Aussee, Berchtesgaden, Heilbron, etc., etc.

Very extensive deposits of salt occur in China, Africa, Asia, Mexico, Colombia, Venezuela, and Russia. In fact, the richest deposit of rock salt in the world is said to occur near Iletz Zashtchiti in the province of Orenberg, South-East Russia.

In the United States and Canada very extensive deposits occur, the principal localities being New York State, Michigan and Ontario, Utah, Virginia, Ohio, Louisiana, and Kansas.

The main British deposits occur in Cheshire and Lancashire, while it is also found near Carrickfergus and near Larne in Ireland.

At Northwich, in Cheshire, the top bed of rock salt is 75 ft. thick and lies 135-150 ft. below the surface. Under this comes a layer, 30 ft. thick, of hard marl, and then comes a second bed of rock salt 105 ft. thick. Below this come successive thin beds of salt. At Winsford in Cheshire the beds are similar to those at Northwich, the upper bed of salt being 70 ft. thick and the lower 120 ft. thick. Similar beds occur at Droitwich and Stoke Prior in Worcester, at Preesal in Lancashire, near Barrow-in-Furness, in Staffordshire, and various other localities.

Composition of Rock Salt.—The natural rock salt, as it occurs in the mines, is usually strongly contaminated with calcium sulphate and magnesium salts, and so cannot be directly used. The following figures refer to the average composition of some rock salts which are commonly met with :—

	Cheshire.	Stassfurt, "Jüngere Steinsalz."	Stassfurt (Impure).	Wieliczka (White).	Cardona.
NaCl - - - -	98.30	97.0	94.57	100.00	98.55
CaSO ₄ - - - -	1.65	1.5	0.89	...	0.44
Mg salts - - - -	0.05	0.5	0.97	...	0.02
CaCl ₂ - - - -	0.99
Alumina and ferric oxide -	3.35
Water - - - -	...	1.0	0.22
Total - - - -	100.0	100.0	100.00	100.00	100.00

Sea Salt.—Enormous quantities of salt are found in the oceans and seas, whither it has been brought by the rains and rivers flowing from land to sea, a process which has gone on without interruption for millions of years, and is still continuing. The sea water evaporates, falls as rain on the land, and runs back into the sea by means of numerous rivers and rivulets. Thus the salt and soluble components of the soil are being continually washed away from land to sea, and the stores of salt now accumulated in the seas and oceans represent the net result of the lixiviation or extraction of land for many geological ages.

100 g. of sea water contain :—

	The Ocean.	The Mediterranean.	The Dead Sea.
	Grams.	Grams.	Grams.
NaCl - - - -	2.723	3.007	8.79
MgCl ₂ - - - -	0.334	0.385	8.99
MgSO ₄ - - - -	0.225	0.249	...
CaSO ₄ - - - -	0.126	0.140	0.14
KCl - - - -	0.077	0.086	1.36
MgBr ₂ - - - -	0.008	0.008	0.37
CaCO ₃ - - - -	0.012	0.012	2.38
Total salts -	3.505	3.887	22.03

To every 100 g. of NaCl in ocean salt we have :—

NaCl - - - -	100.00	KCl - - - -	2.83
MgCl ₂ - - - -	12.27	MgBr ₂ - - - -	0.29
MgSO ₄ - - - -	8.26	CaCO ₃ - - - -	0.44
CaSO ₄ - - - -	4.62		

The Dead Sea really consists of mother liquors from which part of the salt has already separated. As regards other seas it may be remarked that the Baltic and the Black Sea are poor in salt, containing only about half the amount of NaCl per 100 g. that the Atlantic Ocean does. It should also be noted that the relative proportions of the salts which occur, for example, in the Atlantic Ocean and the Mediterranean are practically the same, whereas the Caspian Sea is much richer in sulphates. Analogous to the Dead Sea is the Utah Sea, which contains some 20-30 per cent. of salt.

Extraction of Rock Salt.—In many salt mines (especially that at Wieliczka) the salt is systematically mined, by first breaking down the rock salt by means of powder. Then the broken salt is shovelled into trucks and sent to be ground into a more or less fine powder at a crushing and grinding mill placed at the bank of nearly every rock salt pit, when it is ready for shipment.

In order to support the roof, columns of either unchanged rock salt are left at intervals, or else the hollow spaces, from which the salt has been removed, is filled in again with debris.

The pillars which are left to support the roof are in proportion to the depth of the mine. Thus at 330 ft. one pillar is left for every $11\frac{1}{4}$ times its area of salt worked. The pillars are usually 10 yds. square, and are separated by intervals of 25 yds.

However, it is now usual to direct water systematically upon the salt so as to prepare a **saturated solution of brine**. This is then pumped up to the surface, and is either piped directly to alkali works, or to where salt is required in the solid conditions; the brine is evaporated in the manner we will presently describe, and the salt allowed to crystallise out.

In this manner great chambers are hollowed out in the rock salt beds in certain mines, and means have to be taken to prevent the roof from subsiding by leaving undissolved certain pillars of salt or by timbering, etc.

In Cheshire, **natural brine** which penetrates only to the upper bed of salt is reached by sinking a shaft some 10 ft. in diameter lined with cast-iron cylinders jointed together or backed with timber. This shaft is carried down until the marl covering the rock salt (which is fairly impervious to water) is reached. Then a bore-hole is driven in until the natural brine is tapped. The brine rushes up into the shaft often with great force, and is then raised by common pumps to the surface, whence it flows into reservoirs lined with puddle clay and brickwork. Occasionally large wooden tanks are employed as reservoirs, the timbering being held together by wooden plugs (nails cannot be used on account of corrosion). From these reservoirs the brine is piped directly to the salt pans or to alkali works.

The piping used sometimes consists of trunks of trees bored out in the centre and tapered at the ends, so that the end of one pipe fits into that of the next pipe. Iron piping is also used, but is regarded as inferior to wood piping in some respects.

In cases where no natural brine is found a shaft is sunk, in the manner above described, to the layer of rock salt and then a stream of fresh water is pumped down on to the bed of salt, allowed to saturate with salt, and then is pumped up again.

The concentrated brine is heavier than pure water, and so collects at the bottom of the shaft, and care is taken to draw only from the bottom of the shaft, the pumps being only worked so long as the brine comes up almost saturated (since weak brine requires much expensive fuel for evaporating the excess of water).

The specific gravity of the saturated brine is about 1.2. As the brine is pumped away from the bottom of the cavity more water flows in, the cavity becomes larger, and the productive capacity of the shaft becomes greater.

However, the removal by solution of these subterranean beds of salt by the agency of water causes in some districts very serious subsidence of the land above them. In fact it is quite common in brine-pumping districts for pieces of land to sink at the rate of 1 ft. a year.

The water finding its way down to the rock salt beds often runs for miles along its surface, and so an ever-increasing layer of salt is removed. When the water becomes saturated the absorption of the salt ceases, but should the water be pumped up again for manufacturing purposes a fresh supply of water flows in, and so the action goes on from year to year, often with bad subsidence of the overlying land.

Manufacture of Salt from Sea Water—Solar Salt

In countries provided with an abundant supply of sunshine, much salt is obtained by the evaporation of sea water. Such salt is called "Solar" salt (Lat. *sol*, the sun).

The chief countries where the process is worked are France, Portugal, Italy, Dalmatia, the Crimea, the United States, and in countries bordering the Mediterranean Sea and the Atlantic Ocean.

In France, especially, the industry is a well developed one; no less than twenty-five large sea-salt works being in operation; the most important company is known as the "Comp. des Product. chim. d'Alais et de la Camargue," and the most important works are situated at the mouth of the Rhone and in the Giraud district.

The general method of work is as follows:—A piece of flat land lying well below the high-water level, is levelled and surrounded by a bank or wall. The best soil to use is clay, which is easily made water-tight. If the land is not clay the ground is puddled with clay to make it water-tight.

The enclosed space, often many acres in extent, and called a "salt garden" or "salt meadow," is divided into compartments by internal walls. Sea water is now admitted into A (Fig. 1) at high tide (usually in spring), and is allowed to stand in this shallow "concentration" pond until the concentration has risen from 3.5° to 25° Bé., *i.e.*, nearly to the saturation point. There separates out at this stage, clay, calcium carbonate (CaCO_3), gypsum (CaSO_4), etc. The concentrated sea water is now allowed to run into the crystallising pond B (Fig. 1), where the

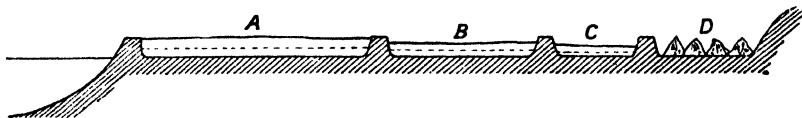


FIG. 1.—Manufacture of Salt from Sea Water.

concentration is allowed to proceed until 27° Bé. is reached, when fairly pure NaCl (95.97 per cent.) separates out in a crystalline form.

The mother liquors are now run into other ponds such as C (Fig. 1), and the concentration continued until 32° Bé. is reached, when NaCl of inferior quality is obtained.

The separated salt is then raked together into heaps, and allowed to stand in the air D (Fig. 1); there it slowly dries, the deliquescent salts, such as MgCl_2 , running away or being washed out of the mass by occasional showers.

In good seasons each square metre will produce in forty days some 55.72 kg. of salt.

Now it will be recollected that sea water contains to each 100 g. NaCl present about 12.20 g. MgCl_2 , 8.26 g. MgSO_4 , 4.62 g. CaSO_4 , 2.83 g. KCl, 0.29 g. MgBr_2 , 0.44 g. CaCO_3 . In the course of the evaporation above described, most of the NaCl has been removed, also the CaSO_4 and CaCO_3 . There, therefore, remains behind in the mother liquors much MgCl_2 , MgSO_4 , MgBr_2 , and KCl. In France, in the Giraud district, these mother liquors—now concentrated to $\frac{1}{4}$ of their original bulk—are still worked up, according to a process introduced by Balard, for magnesium and potassium salts, in spite of the development of the Stassfurt deposits (which now supply the bulk of the magnesium and potassium salts of commerce, see p. 329). On further evaporation of these mother liquors we get *sel mixte* crystallising out, a mixture of about 40 per cent. MgSO_4 and 60 per cent. NaCl, and from this Glauber salt ($\text{Na}_2\text{SO}_4 \cdot 10\text{H}_2\text{O}$) is made by dissolving the mixture in water and exposing the solution to a natural or artificial cooling a few degrees below 0° C., when the following change occurs:—



The sodium sulphate crystallises out as Glauber salt, while the MgCl_2 remains behind in solution.

After the separation of the *sel mixte* there crystallises out Carnallite ($\text{KCl}, \text{MgCl}_2, 6\text{H}_2\text{O}$), which is worked for KCl in the manner described under **The Stassfurt Industry**, p. 330, also p. 335 of Section XXIX.

In the mother liquors from these residues a considerable amount of bromine occurs, and the liquors are sometimes worked for this in the manner described in Section XL., p. 403, under "Bromine."

Recently in the Giraud district in France vacuum evaporating pans have been set up (described below) and a factory for ammonia soda after the Solvay process has also been erected. For the spraying process see **O. M. Smith, Ind. Eng. Chem.**, 1932, 24, 547.

In Russia (Siberia, N. Russia, etc.) much salt is obtained by allowing sea water to freeze. After removing the ice (which is almost pure water) mother liquors rich in salt are left. These are once more allowed to freeze, the ice removed and, on gentle evaporation, salt separates from the mother liquors. It is purified by exposing to atmospheric moisture. A sample contained NaCl 77.6 per cent.; MgCl₂ 1.66 per cent.; CaCl₂ 0.94 per cent.; Na₂SO₄ 13.60 per cent.; insoluble 6.20 per cent.

Magnesium salts are also extracted from sea water in the Crimea and Odessa (see B. Panteleimonov, *Chem. Zeit*, 1930, 54, 153; *Chem. and Ind.*, 1930, 348).

Manufacture of Salt from Brine

Much salt is obtained, especially on the Continent, from natural or artificial salt springs which issue naturally from the earth, or are pumped up from below by means of artificial bore-holes (see above). Many of the natural salt springs are almost saturated (e.g., at Lüneberg there is such a spring which has been known since the year 956 A.D.) while others are dilute.

The following figures give the composition of some well-known brines:—

100 Parts Brine Contain	Northwich Bottom Mine.	Droitwich.	Friedrichshall.	Syracuse, New York, U.S.A.	Middlebrough.	Schönbeck.
NaCl - - -	25.790	22.452	25.563	21.710	24.930	9.623
CaSO ₄ - - -	0.450	0.387	0.437	0.505	0.450	0.339
MgCl ₂ - - -	0.093	...	0.005	0.136	...	0.083
KCl, K ₂ SO ₄ - - -	0.021
CaCO ₃ - - -	0.018	...	0.010	...	0.030	0.026
CaCl ₂ - - -	0.044	0.188
Na ₂ SO ₄ - - -	...	0.390	0.020	0.249
MgCO ₃ - - -	...	0.034
MgSO ₄ - - -	0.023	...	0.046	0.012
FeCO ₃ - - -	0.005	...	0.001
Total - - -	26.395	23.263	26.038	22.544	25.476	10.354

In parts of Germany and the Continent, in cases where these salt springs contain less than 16 per cent. of salt, they are sometimes concentrated by allowing the liquor to drip over tall blackthorn hedges in the free air. An enormous surface is thus exposed to the air, and CaCO₃, CaSO₄, etc., deposits on the thorns and twigs of the wall. However, this process is uneconomical, because much salt is lost by being blown away by the wind, and practically it is found more economical to either buy rock salt and add it to the water from the springs and so bring them to saturation point, or else to penetrate the underlying salt beds by means of bore-holes and allow fresh water to run down and saturate itself with salt. This brine is then pumped up.

The brine, brought up to the saturation point, is next run into large "salt pans" and boiled down for salt.

These salt pans are made of wrought-iron plates riveted together, like boiler plates, and heated from below. At Northwich, the smallest pans employed are 25 ft. long by 20 ft. wide and 1½ ft. deep, but larger pans used for making coarser salt are 70-140 ft. long by 25-30 ft. wide by 1½-2 ft. deep. Many salt pans hold over 50 cub. m. of brine. The pans are placed upon brickwork, which forms the flues, while the fireplaces are put in front.

Fig. 2 shows a cross section through a typical English salt pan.

The salt pan A is heated by flues running underneath and, supported upon the flue walls, has running down each side at CC a narrow gangway, made of 2-in. planks, 2 ft. wide, known as the "standing aside." These gangways run the entire length of the pan, and are used by the workmen for shovelling the salt out of the pan on to the "hurdles" D, consisting of wooden planks, inclined as shown, with a gutter placed at the edge. These form a receptacle for the wet salt, the gutter allowing any brine flowing from the wet salt to flow back into the salt pans. As considerable strength is required to shovel out the salt from the pans on to the hurdles, a narrow "toe space" is left beneath the pan, so that the workman in drawing the salt out of the pan can get his toe under the pan and so exert greater force. The pans at the side extend some 6 in. or more beyond the flue walls, in order to give this "toe-room" to the workmen, and also to keep the angle irons at the sides well out of the flues and so prevent them from becoming heated strongly. The pans also extend about 1 ft. to 1½ ft. beyond the iron wall of the fireplace

(in order to prevent the angle irons of the sides becoming unduly heated). The salt is drawn from the pan by a sort of perforated shovel known as a "skimmer."

The plates of the pan which are directly over or near the fires are thicker (e.g., $\frac{3}{8}$ in. thick) and smaller than the other plates ($\frac{1}{8}$ in. thick), because they wear away more rapidly. Each set of fire-plates is separated from the neighbouring series of fire-plates by the long plates resting upon the wall dividing the two fireplaces. The floor of the pan is firmly joined to the sides by means of an angle iron. All the plates are riveted together like boiler plates, and are made out of wrought iron.

A somewhat different arrangement is adopted in Continental salt works. Here

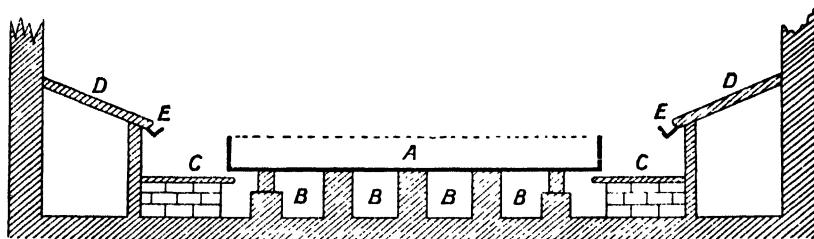


FIG. 2.—English Salt Pan.

the salt pans are usually covered with a wooden cover, provided with an upright shoot to take off the steam. This cover keeps in the heat and accelerates the drying of the salt.

Figs. 3 and 4 show, for example, a typical German salt pan as worked at Schönebeck. The heat is supplied from two fireplaces A and B (using "brown" coal), and the hot gases therefrom stream

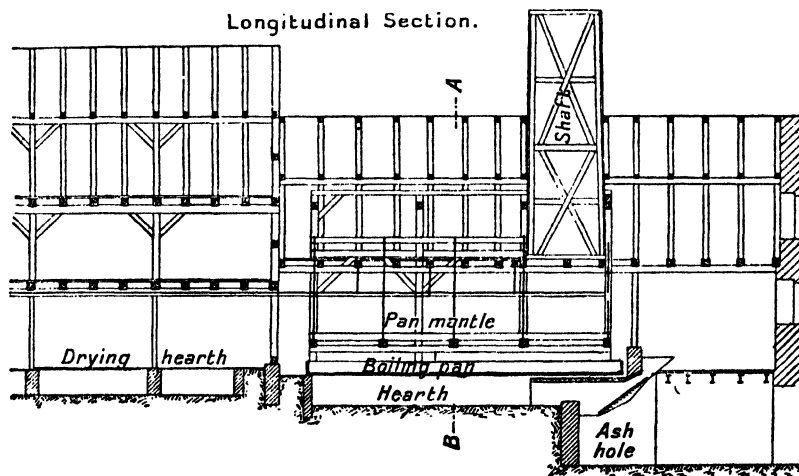


FIG. 3.—German Salt Pan at Schönebeck.

under the pan backwards and forwards several times through flues arranged as shown in Fig. 5, the hot flue gases finally escaping away to the chimney by passing underneath the "drying hearths" which are adjacent to the salt pans as shown. In these drying hearths the salt is finally dried.

The evaporation of the brine is on the Continent usually carried out in two distinct stages. 1. The brine is first run into circular pans provided with stirring gear ("Störpfaunen"), and evaporated until the brine is quite saturated. At the same time a certain amount of purification is effected at this stage, because here there separates (together with some NaCl) such substances as CaSO_4 (gypsum), Na_2SO_4 , $\text{Fe}(\text{OH})_3$, and certain organic resinous matter (known as "Quellsäure" and "Erdharze").

2. After the brine has been saturated and purified, as above described, it is next run into the salt pans ("Siedepfaunen"), where it is boiled down as described in the English process. Here the salt is separated in a fairly pure form in crystals, and by means of rakes and perforated shovels is

drawn out, placed wet upon a dripping board or mantle ("hurdles") above the pans, so that the uprising steam serves to dry it, and then is transferred, by means of suspended iron trucks, into the drying rooms.

The drying process is completed on iron or stone floors adjoining the salt pans and heated underneath by flues, through which stream the waste hot gases escaping from the salt pan fires (see Fig. 3). This method causes lumps to form in the

Section through A.B.

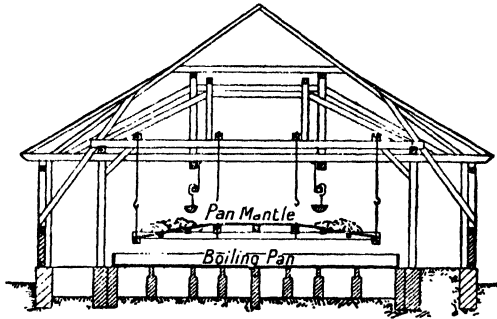
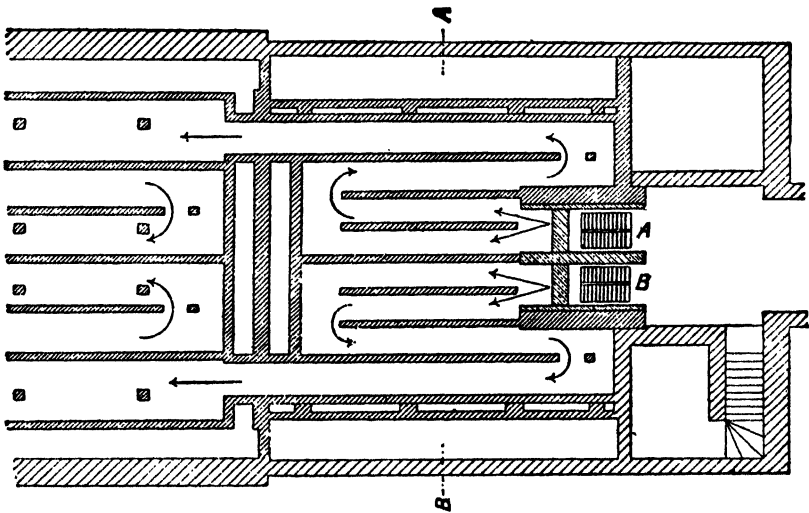


FIG. 4.—German Salt Pan at Schönebeck.

salt, and consequently the better qualities of salt are often slowly dried on wooden gratings or in perforated shelves in special drying chambers.

The varieties of salt formed differ considerably according to the temperature at which the pans are worked.

Fine-Grained or Lump Salt is made by actually boiling the brine in small



Ground Plan of Flues.

FIG. 5.—German Salt Pan at Schönebeck.

sized pans (say 20-40 ft. long by 20-25 ft. wide and 16-18 in. deep). The temperature of the boiling brine is 107.5° C., and the salt as it settles out is raked off the fire-plates to the side of the pan. Every eight to twelve hours the salt is withdrawn from the pan and placed in wooden boxes. On cooling, the hot brine still contained in the salt crystallises out and knits the whole into a solid lump, which is then knocked out of the box and dried in a drying chamber.

Table salts are prepared from this fine-grained lump salt simply by grinding.

The best varieties of **German table salt** are prepared by removing salt wet from the pans, allowing to drain on dripping boards, then throwing into centrifugal machines, which force out the excess of moisture. The final drying then takes place in horizontally placed rotating copper cylinders, coated internally with cement (since copper and even tinned copper are attacked by moist salt) and provided internally with a rotating worm, which keeps turning the salt over. Hot air is passed in a steady stream through the cylinder, whereby the salt is dried without the formation of "lumps." It then possesses a brilliant white crystalline appearance.

The following analyses give the average composition of three typical specimens of table salt, to which is appended a specimen of salt derived from sea water :—

	Table Salt from Brine.		Sea Salt.
NaCl - - - -	98.40	97.40	97.11
CaSO ₄ - - - -	1.30	0.58	1.10
MgSO ₄ - - - -	...	0.15	0.23
MgCl ₂ - - - -	0.28	0.08	0.04
Insoluble residue - - -	0.03	...	0.05
H ₂ O - - - -	...	1.71	1.40
	100.01	99.92	99.93

Magnesium chloride (MgCl₂), if present in salt to any extent, causes an intensification of the salty taste, but, being hygroscopic, causes the salt to become lumpy and damp. It should, however, be noted that even the purest samples of NaCl have a tendency to stick together in lumps. In some table salts this difficulty is got over by adding a small amount of bone meal (calcium phosphates) to the salt. Thus **Cerebros salt** is stated in a recent lawsuit to contain 3 per cent. of phosphates thus added, which possibly acts beneficially in adding mineral phosphates to the food in small quantities.

For "**Common Salt**"—as used in certain manufacturing operations—the crystallisation of the salt is effected at 60°-80° C. in large pans, 40 ft. by 25 ft. by 1½ ft. The salt is raked from the fire-plates every two hours and taken out of the pan every twenty-four to forty-eight hours, and, after draining on the hurdles, is ready for shipment. The grain of this salt is much coarser than the previous variety mentioned.

Fishing Salt, made for the fishing industry, is a coarse-grained variety made by crystallising at 38°-60° C. in large pans, often 60 ft. long, 2 ft. deep and 25 ft. wide. The salt is removed every seven to fourteen days. The longer the salt remains in the pans the coarser the grain. A little alum added to the brine favours the formation of large hard crystals.

Bay Salt is still coarser in grain than fishing salt, the pans being very large, sometimes 135-140 ft. long by 30 ft. wide and 2 ft. deep. The brine is kept at 40°-50° C. and the salt is drawn from the pan every three or four weeks.

The grain of salt can be altered to some extent by adding various substances to the pan. *E.g.*, Alum favours the formation of large crystals (*i.e.*, a coarse-grained salt) while gelatine or grease tends to cause a fine-grained salt to be deposited.

"**Hopper**" Salt is made by adding alum to the salt, when the salt crystallises out in hollow cubes, which float about before they sink to the bottom of the pan.

Various impurities gradually separate out on the pan—mostly over the fire-plates—and form a scale over the bed of the pan. Thus any bicarbonate of calcium (CaCO₃.H₂CO₃) is decomposed and a layer of CaCO₃ is deposited (CaCO₃.H₂CO₃ = CaCO₃ + CO₂ + H₂O), forming what is known as "sand scale." This has to be broken occasionally by a hammer or blunt pick and is removed, otherwise the fire-plates would get red hot and burn away.

Likewise CaSO₄ (Gypsum, calcium sulphate) present in the brine also settles out as a hard crust, often containing much NaCl, and is known as "pan scale." This latter often attains 4 in. or more in thickness, and is broken out and sold as a "salt lick" for cattle, also for manuring purposes. If the brine contains much MgCl₂ (Magnesium chloride) the preparation of salt occasions difficulties owing to the deposition of scale and other impurities.

Owing to the gradual deposition of scale, and loss of efficiency therefrom, periodically all the liquid is run away and the pan cleaned and scale removed ("picking" the pan).

The mother liquors remaining after the removal of the salt are usually run to waste.

Manufacture of Salt by Multiple Effect Vacuum Evaporators

The introduction of vacuum apparatus for evaporating the brine is of recent date, and triple effect vacuum evaporating pans have now been employed with success for many years at several large salt works.

Multiple effect vacuum pans have been described in **Martin's "Industrial Chemistry: Organic,"** 65, under **Soap** (pp. 123-124), under **Sugar** (pp. 155-160), and in this Volume, p. 378, and we will not again describe them in detail here except to mention that heat is applied to the vessels through tubes to the first vessel of the series—such heat may be waste steam or hot flue gasses, and is passed through hot tubes immersed in the brine.

The steam generated from the boiling brine in the first vessel is then used for boiling the brine in the second, and the steam from the second heats the third. A vacuum is maintained by a special pump attached to the last vessel, and consequently the last vessel is under the highest vacuum (so the boiling takes place here at the lowest temperature), while in each of the preceding vessels the pressure is greater and so the boiling takes place at successively higher temperatures; so that while

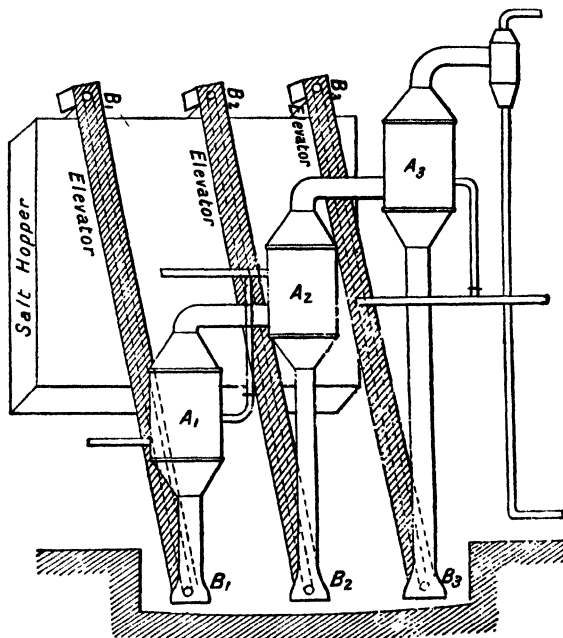


FIG. 6.—Vacuum Evaporators for Salt.

in the first evaporator the pressure may be only a little under atmospheric pressure, in the last evaporator, where a high vacuum is maintained, the boiling takes place at a low temperature.

In the vacuum plant designed for salt works special arrangements are made for automatically and continually removing the salt as it separates. Such devices have been described in **Martin's "Industrial Chemistry: Organic,"** under **Soap**, in describing Foster's salt recovery plant for evaporating soap lies. (See *loc. cit.*, p. 123, and also under "Electrolytic Production of Caustic Soda," this Volume, p. 378.) In evaporators employed in salt works, however, very often a long leg is fitted to each evaporator so as to maintain a column of brine equal to the vacuum in the vessel, so that the crystals of salt as they separate out fall into the bottom of the leg and are continually removed by means of an elevator to a storage hopper, and this without in any way interfering with the vacua. Fig. 6 illustrates this arrangement, where each evaporator (A_1 , A_2 , and A_3) is placed at a different height so as to give a length of leg proportional to the vacuum in the vessel, the evaporator A_3 next the vacuum pump being thus placed at the greatest height. Each evaporator has its own elevator (B_1B_1 belongs to A_1 , B_2B_2 to A_2 , and B_3B_3 to A_3) for raising the salt as it falls to the bottom of the leg into the hopper.

The earlier attempts to use vacuum apparatus for evaporating brine failed on account of the deposition of calcium sulphate, calcium carbonate, etc., in the form of hard crusts on the internal pipes, which speedily rendered the plant

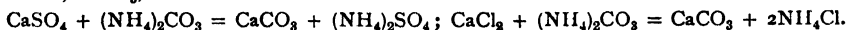
ineffective. Now almost all natural brines are practically saturated with CaSO_4 , which is more soluble in NaCl solution than in pure water, although its solubility is much diminished if either CaCl_2 or Na_2SO_4 or MgSO_4 is present.

Hence many works purify the brine artificially before evaporating in the vacuum pans for salt.

Thus at Lüneburg the brine is treated with some milk of lime, which precipitates the magnesium salts as $\text{Mg}(\text{OH})_2$ and also precipitates any calcium bicarbonate present, thus:—



Next some ammonium carbonate liquors are added, which precipitate all the calcium present, as carbonate, CaCO_3 , thus:—



The precipitated CaCO_3 is allowed to settle and the purified brine thus obtained is run directly into triple effect evaporating pans and boiled down. The salt is automatically recovered (see under **Soap, Martin's** "Industrial Chemistry: Organic,") as the evaporation proceeds, and the mother liquor remaining after the removal of as much salt as possible contains all the added ammonium salts either as ammonium sulphate $(\text{NH}_4)_2\text{SO}_4$ or as ammonium chloride (NH_4Cl) . This is recovered by adding each time to the liquor excess of lime, $\text{Ca}(\text{OH})_2$, which then sets free the ammonia, and then CO_2 gas is passed into the ammoniacal solution, converting the free ammonia once more into ammonium carbonate, which is once more used for purifying a fresh lot of brine. Consequently for each purification the only chemical which has to be added each time is lime, the ammonia being used over and over again.

Another successful method of treating the brine is the addition of calcium chloride (CaCl_2) (Vis, 1896), which precipitates the CaSO_4 (by lowering its solubility) in the form of small crystals, which mixes with the salt and does not allow the formation of scale in the tube. The salt, after separation, is washed free from CaCl_2 by means of fresh brine, and the washings are sent with the brine into the evaporators once more, so that the same CaCl_2 is used over and over again.

In 1900 Vis proposed to electrolyse brine until the NaOH formed is sufficient to precipitate the Ca and Mg salts. Afterwards CO_2 gas (flue gases) is passed in to precipitate the rest of salts in solution. A very similar proposal was made by Malcolm and Munton in 1908.

Mechanical devices for stopping the formation of scale in the tubes of the evaporator have also been successful to some extent, e.g., Trump's device (patented in 1908) of placing a circulating pump in the vacuum apparatus, which caused the crystals and mother liquors to be continually returned to the evaporator, thereby favouring the formation of large crystals, which by their scouring action prevented the formation of scale in the tubes.

The salt separated by vacuum evaporator invariably comes down as fine-grained white crystals. It is thrown into centrifugals, and is finally drained as above described. It is almost chemically pure, often containing as much as 99.8 per cent. NaCl .

The grain of salt produced by these vacuum evaporators is always fine, and where a coarse-grained salt is required (essential in certain manufactures), the concentrated brine from the evaporators is allowed to flow into an ordinary open pan where the crystals of salt form slowly and grow to a large size. These tanks are sometimes known as "grainers."

The yield of these vacuum pans is far greater than that of the open pans per ton of fuel burnt.

Thus with an ordinary open pan 1 ton of coal (slack, with 15-20 per cent. ash) will make at most 2 tons of salt, whereas a good triple effect vacuum evaporator will give 5-6 tons of salt for the same amount of fuel burnt. Since the price of fuel is a heavy item in the preparation of salt, any saving in this greatly increases the margin of profit.

Another advantage about the employment of vacuum pans is that their productive capacity is far greater than that of the open pans.

Thus from an ordinary open pan 15-20 tons of salt per twenty-four hours is considered a good yield. However, multiple effect evaporators are built which will produce with ease some 500-700 tons of salt per day.

The main disadvantages of vacuum evaporators are the heavy initial cost, and the care with which the brine is to be purified in order to prevent the covering of the tubes with calcium sulphate scale.

An interesting development of the salt industry has recently taken place. The problem of utilising rock salt for the direct production of white salt suitable for commerce and edible purposes, instead of making it from brine, has long occupied the attention of inventors.

This will be obvious when it is recollected that one imperial gallon of saturated brine will only yield on evaporation some 50 ounces of dry salt. Thus there is a great fuel consumption necessary for the evaporation of brine to dry salt. "Fine" salt from brine requires with open pans 13 cwt. of coal, while "common salt" about 9 cwt. of coal, for each ton of salt produced.

Now ordinary rock salt contains clay, gypsum, and is stained by iron and metallic oxides all sorts of colours, ranging from brick red to green or violet. Hence, in order to produce a commercial salt of good quality direct from rock salt we must remove all traces of these staining impurities. Now the temperature at which salt fuses, viz., 776° C., is so much lower than the very high fusion temperature of the impurities contained therein, that it is possible to purify it by fusion alone. A great many attempts have been made to purify by fusion, but with little commercial success. It is stated that Lee, working for the International Salt Co., whose works were at Carrickfergus in Ireland, has overcome these difficulties, and that the process may in time revolutionise the salt industry. Lee found that when salt is melted in an ordinary crucible, and agitated by a stream of air, and then is maintained molten for a considerable time, the impurities settle out at the bottom, sinking through the molten salt. On cooling, the whole of the earthy impurities deposit at the bottom in distinct laminæ, the separation showing a straight well-defined line, the bulk above it being pure white salt of a good appearance.

Lee next carried out these laboratory experiments on the large scale. The crude rock salt was melted in a furnace of the same type as an open hearth steel furnace, and was then run into large vessels, termed "converters," into which air was blown. The salt, on cooling, shrank away from the walls, and gave a similar line of demarcation between the pure salt and the impurities as had been obtained on the small scale. However, very great practical difficulties were encountered. The clayey matter became viscid, and formed a clog upon the bed of the furnace, which prevented the free running of the salt into the converter, and caused much salt to remain behind mixed with clay.

The yield of pure salt thus obtained made the process hopeless as a commercial venture. Consequently, it was found necessary to depart altogether from the type of an ordinary metallurgical furnace. The furnace employed had an internal platform, upon which crushed rock salt was discharged at various openings, and accumulated along the platform in the form of cones. When these cones of rock salt melted under the heat of the furnace, the melted salt flowed away, leaving a residue of clayey matter, etc., capable of being easily removed. The molten salt was now allowed to run down to the bed of the furnace, and when enough of the molten fluid had accumulated, air was blown through the salt in the furnace itself, thus doing away with the use of converters. The molten salt was now allowed to stand some time to allow the impurities to deposit, and was then run into moulds, where it was quickly cooled. The salt was then transferred to crushing and grading machinery, where it was graded into the different kinds of finished salt.

Lee estimates that 1 ton of coal will by this process give 12 tons of purified finished salt. Exclusive of the price of rock salt, the price of its conversion into pure grade commercial salt, including depreciation on apparatus, does not exceed 2s. 6d. per ton.

There is, it is claimed, much saving of labour as well as a quicker turnover on capital invested by this Lee process than by the usual brine process. Whether the process will stand the test of time and the introduction of vacuum pans into the salt industry by the brine process remains, however, to be seen.

The first patent was taken out by Lee in 1903, and several additional patents have since been taken out for improvement in the process.

Properties of Salt.—Sodium chloride crystallises in cubes of sp. gr. 2.2, and hardness 2. The following figures give the solubility of salt in water at various temperatures :—

Temperature.	NaCl in 100 g. Solution.	NaCl taken up by 100 g. Water.
0° C.	26.3	35.7
10° "	26.4	35.8
20° "	26.4	35.9
50° "	26.9	36.8
100° "	28.1	39.1
107.7° "	28.4	39.7

The following figures give the specific gravities of salt solutions of various strengths at 15° C. :—

NaCl per 100 g. solution	-	-	5 g.	10 g.	15 g.	20 g.	25 g.	26.8 g.
Specific gravity	-	-	1.0355	1.0726	1.1105	1.1497	1.1904	1.2055

Statistical.—The manufacture of salt is carried out in Great Britain in forty-eight registered "works." Of these, ten occur in the North of England, twenty-eight in Cheshire, North Wales and Lancashire. (See "Forty-Ninth Annual Report of Alkali, etc., Works," 1913, p. 5.)

The total quantity of rock salt mined, white salt made from brine, and salt contained in brine used for making alkali, amounted in 1907 to 1,979,000 tons, valued at £644,000, and this quantity has remained fairly constant for many years past. (See "Home Office Report on Mines and Quarries for 1907," Part III., Cd. 4343.)

The "Final Report on the First Census of Production of the United Kingdom" (1907) states, p. 56, that the total output of salt works in 1907 was :—

	Quantity.	Value.
	Tons.	£
Rock and white salt - - - -	1,417,000	618,000
Table salt (sold in jars or packets) - -	35,000	77,000
Other products - - - -	...	17,000
Total of salt - -	1,452,000	712,000

The difference between these latter returns and the total amount mined is due to the fact that alkali manufacturers pump large quantities of brine directly in their works and the amount used by alkali manufacturers is not included in this latter estimate.

The amount of salt of different qualities produced may be estimated from the fact that out of 1,144,000 tons of white salt produced by certain firms in 1907 it was ascertained that :—

277,000 tons	were coarse,	for chemical and manufacturing purposes.
482,000 "	" "	coarse, for other purposes.
258,000 "	" "	fine.
127,000 "	" "	fishery.

Total, 1,144,000 tons of white salt.

The price of salt at the works was, in 1907, 8s. 10d. per ton, while the average value of exported salt in the same year on shipboard was 15s. 6d. per ton. The total number of persons employed in Great Britain in salt mines, brine pits, and salt works was in 1907, 4,736 (of which 439 were women); the net output per person employed was £67.

The amount of salt consumed per head of population is 30 kg. = 67 lbs.—due largely to consumption in the alkali industries.

The following figures show the British imports and exports of white and rock salt :—

	1907.	1910.	1913.
Exports -	582,000 tons (£452,000)	562,000 tons (£465,000)	
Imports -	30,000 " (£23,000)	32,000 " (£23,000)	

Germany in 1908 produced at twenty-three salt mines and sixty-two brine pits :—

1,164,100 tons rock salt.
 648,100 ,, refined salt (siedesalz).
 29,200 ,, salt residues (abfallsalz).

Total, 1,841,400 tons salt.

In the same year there was pumped some 15 million hectolitres of brine.
 In the same year she used :—

488,600 tons table salt (7.7 kilos per head of population).
 529,500 ,, for soda, sodium sulphate (to this must be added brine for the ammonia-soda process).
 262,100 ,, for other chemical and technical purposes.
 49,500 ,, for manuring purposes.

Total, 1,445,100 tons (22.8 kg. per head of population).

At Stassfurt 100 kilos rock salt cost 0.45 mark, refined salt 2.8 marks. On table salt is a duty of 12 marks per 100 kilos. As sold in trade, table salt in Germany costs 0.2 mark per kilo (1908).

The salt tax (only on table salt) in Germany produced, in 1908, 58,200,000 marks. Salt for industrial purposes and for cattle are tax free, provided they are denatured. The denaturing agents for cattle salt are $\frac{1}{4}$ per cent. iron oxide and $\frac{1}{4}$ per cent. wormwood powder. For salt to be used in the alkali industry the denaturing agents are 1 to 8 per cent. sulphuric acid or $2\frac{1}{2}$ per cent. sodium sulphate or 8 per cent. ammonia, according to the use to which the salt is to be put.

The salt production of other lands is estimated (1908) as follows : United States, 3,000,000 tons ; Russia, 1,800,000 tons (of which half is produced from sea water) ; France, 1,200,000 tons (of which 40 per cent. is sea salt) ; Austria, 340,000 tons and 7,400,000 hectolitres brine.

The British Empire produced in 1932 about 4,300,000 tons of salt.

PRODUCTION OF SALT

Producing Country and Description.	1930.	1931.	1932.
United Kingdom—	Tons.	Tons.	Tons.
Rock salt - - - - -	25,023	21,553	19,567
Brine salt - - - - -	2,042,541	1,876,011	2,196,632
Union of South Africa (years ended 30th June) - - - - -	87,928
Canada - - - - -	241,493	228,224	233,283
Ceylon - - - - -	9,533	44,819	17,703
India (including Aden)—			} 1,610,861
Rock salt - - - - -	175,467	161,893	
Salt - - - - -	1,535,881	1,677,507	
Australia—			
Victoria (estimated) - - - - -	50,000	50,000	50,000
Western Australia - - - - -	8,000	3,938	2,771
Southern Australia - - - - -	58,766	68,666	60,063

Germany in 1932 produced 2,082,274 tons of rock salt and 477,713 tons of brine salt.

France in 1932 produced 1,407,071 tons of rock salt and 168,000 tons of brine salt.

The figures for the United States are as follows :—

	1930.	1931.	1932.
Rock salt - - - - -	1,765,509	1,655,509	1,443,138
Brine salt - - - - -	3,320,054	2,946,616	2,473,954
Evaporated salt - - - - -	2,105,902	1,967,580	1,840,371

China in 1931 produced 2,235,000 tons of salt.

Japan in 1931 produced 513,029 tons of salt.

The exports of salt from the United Kingdom were in 1932 nearly 300,000 tons.

SECTION XXIII

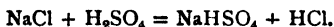
THE MANUFACTURE OF HYDROCHLORIC ACID

BY GEOFFREY MARTIN, D.Sc., Ph.D.

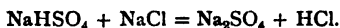
LITERATURE

- LUNGE.—“ Sulphuric Acid and Alkali.” 1915.
 T. MEYER.—“ Sulfat und Salzsäure.” 1907.
 F. HURTER.—*J. Soc. Chem. Ind.*, 1885, 639; 1887, 707; 1893, 226.
 LASCHE.—*Z. angew. Chem.*, 1894, 6, 610, *cf.* p. 614.
 F. WEINREL.—*Ind. Chem.*, 1931, 7, 461.
 See also United States Patent, 1,764,593 (1930); British Patent, 351,264 (1931).

Manufacture of Hydrochloric Acid.—Hydrochloric acid is usually manufactured by heating two molecular proportions of salt with one molecular proportion of concentrated sulphuric acid. Usually about half a ton of salt is placed in a large semispherical pan set in brickwork and heated by direct firing. An equal weight of concentrated sulphuric acid (1.7 sp. gr.) is added from a leaden cistern, when the following action takes place:—



About 70 per cent. of the hydrochloric acid escapes through a flue in the dome of brickwork which covers the pan, and is condensed by water as is described below. The fused mass is finally raked into another part of the furnace, and is there heated to redness, when the action is carried to completeness, thus:—



The hydrochloric acid escapes through a separate flue. This is known as the **Salt Cake Process**, and details of the furnaces, etc., are given fully in Section XXIV., p. 281.

The main product is sodium sulphate, the hydrochloric acid being more or less a by-product.

The second process of manufacturing hydrochloric acid is known as **Hargreave's Process**, and consists in passing a mixture of sulphur dioxide, air, and steam over salt heated to dull redness, when the following action takes place:—



The process is fully described under “Sodium Sulphate” in Section XXIV., p. 284.

The hydrochloric acid gas evolved in the manufacture of sodium sulphate, either by the salt cake process or the Hargreave's process, is always absorbed by being led into water.

At one time the acid fumes from the salt cake furnaces were allowed to escape into the air. In spite of enormous chimneys reaching to the height of 450 ft. and more, the neighbourhood of the salt cake factories was surrounded by dense clouds of smoke. The acid vapours in the air killed the vegetation for miles around the factories, and brought great distress to farmers. Consequently, in 1863 the Alkali Act was passed which makes it compulsory for 95 per cent. of the escaping acid gases to be condensed. The exit gases should not contain more than 0.2 grain HCl per cubic foot, and the total amount of acid gases escaping must be less than is equivalent to 4 grains of SO₂ per cubic foot.

This at first caused great expense to the factories, as at that time HCl was an almost worthless by-product; but soon the rise in value of HCl for the manufacture of chlorine and bleaching powder made the forcible condensation process an actual source of gain, and at the present time it is common for 99.27 per cent. of the HCl to be condensed.

Fig. 1 shows a typical plant attached to salt cake furnaces, giving 4,800 kg. of sodium sulphate per twenty-four hours. The HCl gas escapes from the salt cake furnaces A, A₁ by means of two separate pipes. One pipe B, made out of acid-

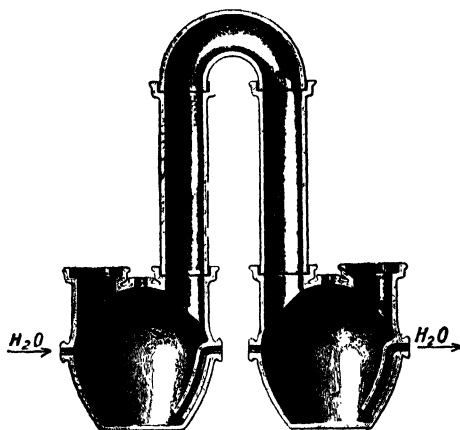


FIG. 2.—Hydrochloric Acid Receivers.

proof earthenware, leads the concentrated and fairly cool HCl gas out of the "pan" in A; while the other pipe B₁ leads the hot dilute HCl gas out of the muffle or roasting part of the furnace. This HCl gas is dilute and very hot, and so the first part of the pipe B₁ is made of tarred sandstone. The gases pass into two sandstone towers C, C₁ where they receive a preliminary cooling, and are to a great extent freed from dust and sulphuric acid. They then pass through a series of some 50 to 60 acid "receivers." These are simply large "Woullf's bottles," made of acid-proof

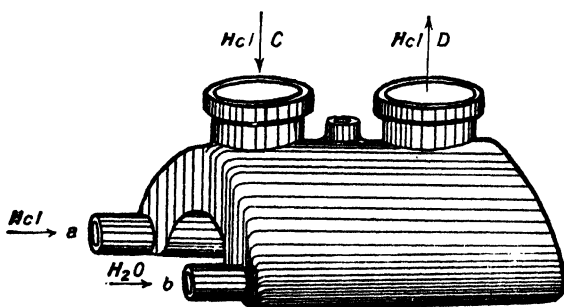


FIG. 3.—Cellarius Receivers.

stoneware, about 32-37½ in. high, connected together by wide Ω -shaped pipes, and arranged as shown in two parallel rows. They are laid down so that a gentle inclination on slope towards the furnaces exists, so that a stream of water can flow through the series in a direction opposite to that of the gases coming from the furnace. The holes for the water are well seen in Fig. 2. This water absorbs most of the HCl, and is run off into the side receivers G₁, G.

In Germany the more efficient Cellarius receivers have come into use of late years.

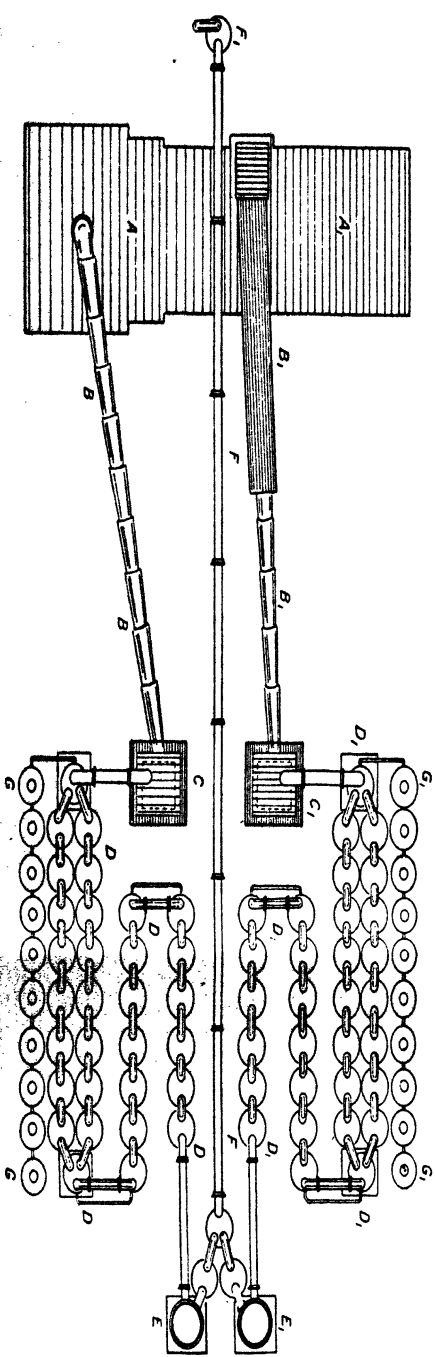
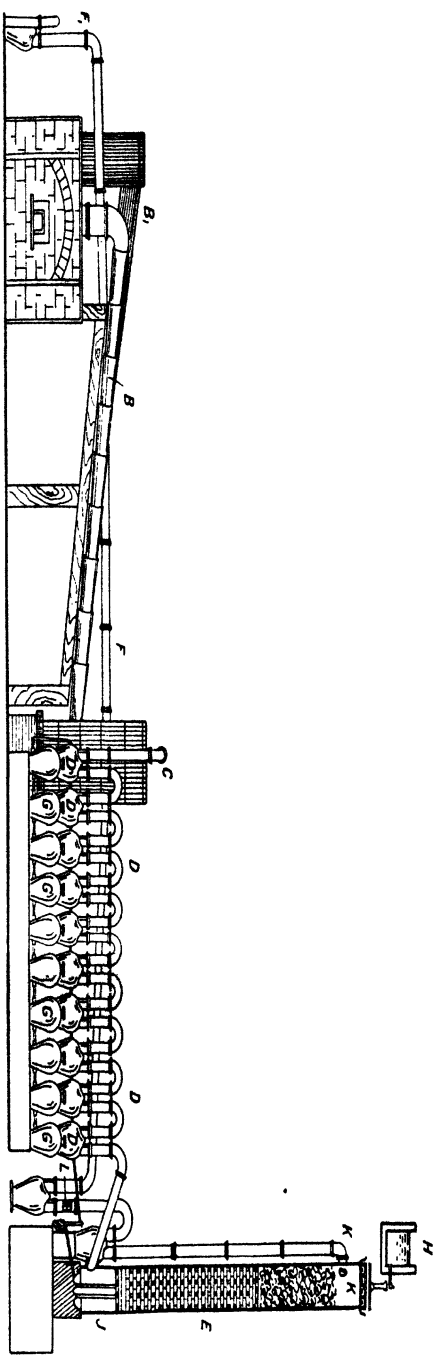


FIG. 1.—Plant for Manufacture of Hydrochloric Acid.

Fig. 3 shows a typical Cellarius receiver. The gas enters at c and escapes at d, while the absorbing water enters by the pipe a, flows over the "saddle" and escapes by the pipe b. Thus a much larger absorption surface is presented to the entering gas, and the latter is more thoroughly mixed with the water and cooled. The whole vessel is immersed in tanks filled with cold water which thus greatly increases the efficiency of the absorption and the strength of acid produced.

The gases finally escaping from the terminal receivers now pass into absorption towers E, E₁, where they meet a stream of descending water which removes the last traces of acid from the gas.

An absorption tower of improved construction is shown in Fig. 1. It consists of a series of rings of hard earthenware, about 1 m. in diameter, set one on the other so as to form a tower some 15-30 m. high. The upper part of the tower is filled with coke, and the lower part with stoneware plates or bricks. From the water tank H a stream of water is sprinkled by means of a rotating "sparger" over the coke and flows in a steady stream down the tower, escaping at the bottom into the stoneware receivers described above.

The gas from the receivers enters at j (Fig. 1) at the bottom of the tower, and escapes at k into a long earthenware tube FF₁ which leads the now acid free gas away to the chimney. At l. samples of the acid can be withdrawn and tested.

In England in many works it is the custom to pass the gases evolved from the salt cake furnaces directly into the absorption towers without the introduction of the elaborate system of cooling and absorption vessels described above. These condensing towers are some 20-30 m. high, and are filled with coke or bricks down which a stream of water trickles as previously described. They are usually built of sandstone plates previously boiled in tar or asphalt, made air and water tight with a lute made of tar and clay, and securely bolted together by means of iron clamps and bars. The aqueous acid thus obtained is not quite so strong as that obtained with the more elaborate condensing system, because the gases enter the tower while still hot. The acid, too, is more impure, being contaminated with organic matter, sulphur dioxide, sulphuric acid, chlorine, chlorides of iron and arsenic—the latter substances sometimes being present in considerable quantities, being derived from the pyrites used in making the sulphuric acid used. Within recent years, acid-resisting materials such as silicon-iron alloys (tantiron, ironac, duriron, etc.), fused silica, acid-proof earthenware, etc., have been widely introduced in constructional details of acid plant.

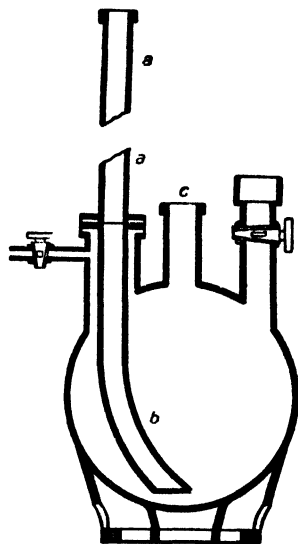


FIG. 4.—Acid "Egg."

The main problem now before hydrochloric acid factories is not so much the condensation of all the HCl fumes, but how to condense them in such a manner as to yield **only strong acid** (the only sort saleable), and by the method first described the condensation is now so perfect that it is possible to recover some 99.27 per cent. of the evolved HCl, mostly in the form of strong acid of 21° Bé. The strength of the produced aqueous acid depends upon the concentration of the gas and the temperature at which it enters the absorbing water.

For example, a 100 per cent. by volume HCl gas at 0° C. gives an aqueous acid containing 45.2 per cent. by weight HCl; while a 5 per cent. HCl gas under the same conditions will only yield an aqueous acid containing 36 per cent. by weight HCl (22° Bé.), and a 10 per cent. HCl gas (by volume) will only yield a 39 per cent. by weight HCl solution (24° Bé.).

As the temperature of the entering gases increases, so also the strength of the obtainable acid decreases. *E.g.*, a 5 per cent. by volume HCl gas at 20° C. will only yield an aqueous acid containing 33 per cent. HCl by weight (20° Bé.).

The conditions affecting the condensation of HCl have been described at length by F. Hurter (*J. Soc. Chem. Ind.*, 1885, 639; 1887, 707; 1893, 226) and the reader should consult these papers for further information (see also Lasche, *Z. angew. Chem.* (1894), 6, 610; Lunge, same journal, p. 615).

The problem of the complete condensation of the HCl gases evolved in the manufacture of salt cake is first of all complicated by the fact that these gases

contain very variable amounts of HCl. *E.g.*, the HCl gases from Hargreave's and the "open roaster" furnaces may contain much less than 10 per cent. by volume of HCl. Secondly, the cooling down of the gases during the condensing process is rendered difficult by the fact that when the gas dissolves in water it evolves much heat, so that as the cold absorption water is forced against the current of hot gases it rapidly becomes heated, and so does not dissolve the maximum amount possible of HCl. However, the introduction of modern pumps made of stoneware, ebonite, or acid-resisting iron now enables the manufacturers to pump the liquid in a continual stream through the condensing system, and so they can ultimately obtain an acid of 20° Bé. even out of weak HCl gases, such as are evolved from Hargreave's process. The introduction of these acid pumps betokens a great advance on the old system of manufacture.

The acid is best elevated by acid pumps or elevators as described on p. 231, under Sulphuric Acid.

The acid is also elevated sometimes in "emulators," where it is blown mixed with compressed air in the form of a froth from one vessel to another. The old acid "egg" (Fig. 4) still maintains its position as a simple acid elevator but is very wasteful compared with "elevators" and acid pumps. Compressed air forced in at *c* forces the acid contained in the vessel up the tube *ab*.

These "eggs" are sometimes made of strong thick-walled stoneware, which, however, is liable to fracture under a sudden accidental blow.

Casing iron with ebonite or soft rubber is efficient. Lately there has been placed on the market non-corroding iron alloys such as "tantiron," "ironac," etc., often made of iron mixed with silicon and other components, which are stated to be extremely efficient as regards their non-corrodibility and their strength. For HCl.aq., however, it is always best to use proper acid pumps for elevating.

Transport and Storage.—The acid is usually transported in large glass "carboys" or in stoneware vessels some 1-1½ m. high. Occasionally ebonite-lined iron vessels or vessels made of gutta-percha have been used. HCl is now being transported in railway tank waggons lined with specially prepared waxed wood. Rubber-coated steel or wood tanks also resist hydrochloric acid.

One of the great difficulties of the industry has been the expense of the vessels necessary for storing large quantities of HCl for any length of time, all the more so as more hydrochloric acid is made than is required in industry and so the price is low. The cause of this is the fact that there is a great demand for sodium sulphate, and the accompanying HCl simultaneously produced more than suffices for the demand for the acid.

Where hydrochloric acid is required in places remote from alkali works, it is usually manufactured by the action of sulphuric acid upon salt in special cast-iron cylinders fitted with sandstone doors. This acid is condensed as already described. It is usually much purer than the acid from alkali works and is known in the trade as cylinder acid in contradistinction to "tower" acid which contains more sulphuric acid.

Good commercial cylinder acid should not contain more than 0.5 per cent. of H₂SO₄.

Purification of the Acid.—The purification of the acid from the various impurities which it contains (*e.g.*, arsenic, sulphuric acid, SO₂, iron chloride, etc.) is usually carried out in special factories.

Arsenic is detected by means of Marsh's test or by adding stannous chloride, which produces a dark precipitate of arsenic. Arsenic may be removed by adding stannous chloride, settling the precipitate, and redistilling the liquid. Arsenic-free HCl is best obtained by employing arsenic-free materials to start with, but it is often removed technically in great parts by washing the acid with tar oils. **Sulphuric acid** is detected by adding BaCl₂ solution to the dilute acid, when a white precipitate of BaSO₄ is produced if it is present. Sulphuric acid is largely eliminated during the process of condensation, but may be completely removed by adding the proper amount of BaCl₂ and distilling.

Sulphur dioxide, SO₂, is detected by adding zinc to the diluted acid, when sulphuretted hydrogen, H₂S, is given off and is detected by its blackening effect on lead acetate paper. **Free iodine** is found by adding KI and starch solution to the diluted acid, when a blue colour is produced.

The complete purification of the acid from these impurities is a matter of great difficulty, and where pure acid is essential it is easiest to start with pure sulphuric acid and pure salt, and thus exclude the foreign impurities. When chemically pure HCl is required it is usually distilled in platinum stills.

Technical Uses of Hydrochloric Acid.—In England the main use of concentrated hydrochloric acid is for making chlorine for the manufacture of bleaching powder, chlorates, etc. The acid sold is usually 20°-22° B \acute{e} ., acids weaker than this scarcely getting a market. In Germany and also in Great Britain large quantities of concentrated hydrochloric acid are absorbed in the colour industry, metallurgical industries, and for very many minor industrial purposes. For example, dilute HCl is largely used for purifying coke, iron ores, clay, for regenerating exhausted animal charcoal, for preparing CO₂ in the aerated water industry, for "pickling" sheet iron in the galvanising industry, so as to remove rust and leave a clean surface for the zinc to adhere to. Also for the manufacture of certain chlorides, in making pottery, and in numerous other things as well. One curious application may be mentioned, viz. : the making of freezing mixtures of concentrated HCl and snow, or sodium sulphate.

The acid is also used in analytical chemistry as a solvent, and for titrating purposes. "Aqua regia"—a mixture of HCl and HNO₃—is also made for dissolving gold and making gold chloride, which finds considerable use in photography.

Properties of Aqueous HCl.—The pure concentrated aqueous acid is a colourless liquid fuming strongly in air. One volume of water at 0° absorbs 503 volumes of HCl gas. The following table due to Roscoe and Dittmar (*Journ. Chem. Soc.*, 1860, 128) gives the weight of gas absorbed by 1 g. of water at different temperatures :—

Temperature.	Grams HCl Absorbed by 1 g. H ₂ O.	Temperature.	Grams HCl Absorbed by 1 g. H ₂ O.	Temperature.	Grams HCl Absorbed by 1 g. H ₂ O.
0°	0.825	24°	0.700	44°	0.618
4°	0.804	28°	0.682	48°	0.603
8°	0.783	32°	0.665	52°	0.589
12°	0.762	36°	0.649	56°	0.575
16°	0.742	40°	0.633	60°	0.561
20°	0.721				

When HCl dissolves in water, 17,314 calories are evolved per gram-molecule of HCl dissolved. The composition of the aqueous acid changes when boiled, according to the temperature and pressure employed; but corresponding to a definite pressure a constant boiling mixture of HCl and water is obtained. The aqueous acid which boils unchanged at 110° C. at 760 mm. contains 20.24 per cent. HCl (Roscoe and Dittmar, *loc. cit.*). A weaker solution when evaporated at ordinary pressures concentrates to this strength. A stronger acid loses HCl and also attains this strength when evaporated.

The following table gives the specific gravity of solutions of aqueous hydrochloric acids of given strengths, as given by Lunge and Marchlewski (*Zeit. angew. Chem.*, 1891, 133).

SPECIFIC GRAVITY OF PURE HYDROCHLORIC ACID SOLUTIONS AT 15° C.
(REDUCED IN VACUO), AFTER LUNGE AND MARCHLEWSKI.

Sp. Gr. at 15/4° C.	Degrees Baumé.	Degrees Twaddle.	100 Parts by Weight Correspond to the Following Amount of Pure Acid per Cent.						1 Litre Contains in Kilogrammes.					
			Pure HCl.	18° Bé. Acid.	19° Bé. Acid.	20° Bé. Acid.	21° Bé. Acid.	22° Bé. Acid.	Pure HCl.	Acid of 18° Bé.	Acid of 19° Bé.	Acid of 20° Bé.	Acid of 21° Bé.	Acid of 22° Bé.
			1.000	0.0	0.0	0.16	0.57	0.53	0.49	0.47	0.45	0.0016	0.0057	0.0053
1.005	0.7	1	1.15	4.08	3.84	3.58	3.42	3.25	0.012	0.039	0.036	0.036	0.034	0.033
1.010	1.4	2	2.14	7.60	7.14	6.66	6.36	6.04	0.022	0.077	0.072	0.067	0.064	0.061
1.015	2.1	3	3.12	11.08	10.41	9.71	9.27	8.81	0.032	0.113	0.106	0.099	0.094	0.089
1.020	2.7	4	4.13	14.67	13.79	12.86	12.27	11.67	0.042	0.150	0.141	0.131	0.125	0.119
1.025	3.4	5	5.15	18.30	17.19	16.04	15.30	14.55	0.053	0.188	0.176	0.164	0.157	0.149
1.030	4.1	6	6.15	21.85	20.53	19.16	18.27	17.38	0.064	0.225	0.212	0.197	0.188	0.179
1.035	4.7	7	7.15	25.40	23.87	22.27	21.25	20.20	0.074	0.263	0.247	0.231	0.220	0.209
1.040	5.4	8	8.16	28.99	27.24	25.42	24.25	23.06	0.085	0.302	0.283	0.264	0.252	0.240
1.045	6.0	9	9.16	32.55	30.58	28.53	27.22	25.88	0.096	0.340	0.320	0.298	0.284	0.270
1.050	6.7	10	10.17	36.14	33.95	31.68	30.22	28.74	0.107	0.380	0.357	0.333	0.317	0.302
1.055	7.4	11	11.18	39.73	37.33	34.82	33.22	31.59	0.118	0.419	0.394	0.367	0.351	0.333
1.060	8.0	12	12.19	43.32	40.70	37.97	36.23	34.44	0.129	0.459	0.431	0.403	0.384	0.365
1.065	8.7	13	13.19	46.87	44.04	41.09	39.20	37.27	0.141	0.499	0.469	0.438	0.418	0.397
1.070	9.4	14	14.17	50.35	47.31	44.14	42.11	40.04	0.152	0.539	0.506	0.472	0.451	0.428
1.075	10.0	15	15.16	53.87	50.62	47.22	45.05	42.84	0.163	0.579	0.544	0.508	0.484	0.460
1.080	10.6	16	16.15	57.39	53.92	50.31	47.99	45.63	0.174	0.620	0.582	0.543	0.518	0.493
1.085	11.2	17	17.13	60.87	57.19	53.36	50.90	48.40	0.186	0.660	0.621	0.579	0.552	0.523
1.090	11.9	18	18.11	64.35	60.47	56.41	53.82	51.17	0.197	0.701	0.659	0.615	0.587	0.558
1.095	12.4	19	19.06	67.73	63.64	59.37	56.64	53.86	0.209	0.742	0.697	0.650	0.620	0.590
1.100	13.0	20	20.01	71.11	66.81	62.33	59.46	56.54	0.220	0.782	0.735	0.686	0.654	0.622
1.105	13.6	21	20.97	74.52	70.01	65.32	62.32	59.26	0.232	0.823	0.774	0.722	0.689	0.655
1.110	14.2	22	21.92	77.89	73.19	68.28	65.14	61.94	0.243	0.865	0.812	0.758	0.723	0.687
1.115	14.9	23	22.86	81.23	76.32	71.21	68.93	64.60	0.255	0.906	0.851	0.794	0.757	0.719
1.120	15.4	24	23.82	84.62	79.53	74.20	70.79	67.31	0.267	0.948	0.891	0.831	0.793	0.754
1.125	16.0	25	24.78	88.06	82.74	77.19	73.64	70.02	0.278	0.991	0.931	0.868	0.828	0.788
1.130	16.5	26	25.75	91.50	85.97	80.21	76.52	72.76	0.291	1.034	0.972	0.906	0.865	0.822
1.135	17.1	27	26.70	94.88	89.15	83.18	79.34	75.45	0.303	1.077	1.011	0.944	0.901	0.856
1.140	17.7	28	27.66	98.29	92.35	86.17	82.20	78.16	0.315	1.121	1.053	0.982	0.937	0.891
1.1425	18.0	...	28.14	100.00	93.95	87.66	83.62	79.51	0.322	1.143	1.073	1.002	0.955	0.908
1.145	18.3	29	28.61	101.67	95.52	89.13	85.02	80.84	0.328	1.164	1.094	1.021	0.973	0.926
1.150	18.8	30	29.57	105.08	98.72	92.11	87.87	83.55	0.340	1.208	1.135	1.059	1.011	0.961
1.152	19.0	...	29.95	106.43	100.00	93.30	89.01	84.63	0.345	1.225	1.152	1.075	1.025	0.975
1.155	19.3	31	30.55	108.58	102.00	95.17	90.79	86.32	0.353	1.254	1.178	1.099	1.049	0.997
1.160	19.8	32	31.52	112.01	105.24	98.19	93.67	89.07	0.366	1.299	1.221	1.139	1.087	1.033
1.163	20.0	...	32.10	114.07	107.14	100.00	95.39	90.70	0.373	1.326	1.246	1.163	1.109	1.054
1.165	20.3	33	32.49	115.46	108.48	101.21	96.55	91.81	0.379	1.345	1.264	1.179	1.125	1.070
1.170	20.9	34	33.46	118.91	111.71	104.24	99.43	94.55	0.392	1.391	1.307	1.220	1.163	1.106
1.171	21.0	...	33.65	119.58	112.35	104.82	100.00	95.09	0.394	1.400	1.316	1.227	1.171	1.113
1.175	21.4	35	34.42	122.32	114.92	107.22	102.28	97.26	0.404	1.437	1.350	1.260	1.202	1.143
1.180	22.0	36	35.39	125.76	118.16	110.24	105.17	100.00	0.418	1.484	1.394	1.301	1.241	1.180
1.185	22.5	37	36.31	129.03	121.23	113.11	107.90	102.60	0.430	1.529	1.437	1.340	1.279	1.216
1.190	23.0	38	37.23	132.30	124.30	115.98	110.63	105.20	0.443	1.574	1.479	1.380	1.317	1.252
1.195	23.5	39	38.16	135.61	127.41	118.87	113.40	107.83	0.456	1.621	1.523	1.421	1.355	1.289
1.200	24.0	40	39.11	138.98	130.58	121.84	116.22	110.51	0.469	1.667	1.567	1.462	1.395	1.326

SECTION XXIV

THE MANUFACTURE OF SODIUM
SULPHATE (SALT CAKE)

By GEOFFREY MARTIN, D.Sc., Ph.D.

LITERATURE

LUNGE.—“ Sulphuric Acid and Alkali.” 1913.

T. MEYER.—“ Sulfat und Salzsäure.” 1907.

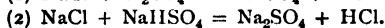
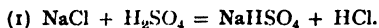
F. WEINREL.—*Ind. Chem.*, 1931, 7, 461.

CONSIDERABLE deposits of natural sodium sulphate occur in Persia (near Tiflis), in the Kara-Boghas Gulf of the Caspian Sea, at Tomsk in Siberia, and some other places. Also many inland seas contain considerable amounts in solution, especially the Owens Lake in California, whose waters contain some 11 g. of sodium sulphate per 1,000 c.c.

However, for industrial purposes, the substance is almost always (in Europe at least) obtained from common salt by two main processes: (1) by treating with sulphuric acid (salt cake process), or (2) by the SO_2 , air, and steam (Hargreave's) process.

Small amounts are also obtained as a by-product in the Stassfurt Salt Industry (which see).

1. Salt Cake Process.—The salt used is either broken-up pure rock salt (where this is available), or else salt coarsely crystallised. The sulphuric acid used is usually “Glover” acid, of 58° - 62° Bé. The decomposition occurs in two distinct stages:—



The first reaction begins at ordinary temperatures, whereas the second is only completed at a red heat. The final product is called “salt cake.”

Figs. 1, 2, 3 show the ordinary salt cake muffle furnaces (“blind roasters”) employed.

Figs. 1 and 2 show a vertical and horizontal section through the furnace, while Fig. 3 represents a horizontal section through the lower flues of the furnace. h is the large cast-iron “pan,” usually some 3 m. in diameter, some 60 cm. deep, and made some 16-18 mm. thick. It lies with a flange round the edge resting on the stonework of the furnace.

Good iron “pans” will stand several thousand charges before being burnt through. However, they must be composed of cast iron of the proper composition, containing a high percentage of chemically-combined carbon, but only small amounts of uncombined carbon (graphite) and silica, and be of uniform composition throughout (otherwise some parts will corrode more quickly than others).

The vaulted roof of this part of the furnace is built of acid-proof materials, and is provided with an outlet tube l_2 of acid-proof earthenware, iron alloy, or fused silica, for the escaping HCl gas.

The salt is introduced into the pan through the opening i_2 (Fig. 2), and the proper amount of sulphuric acid is poured upon it through a leaden tube (not shown), when HCl gas ("pan gas") is at once evolved, and the following action takes place:—



When the evolution of HCl has almost stopped, the iron sliding door k is raised,

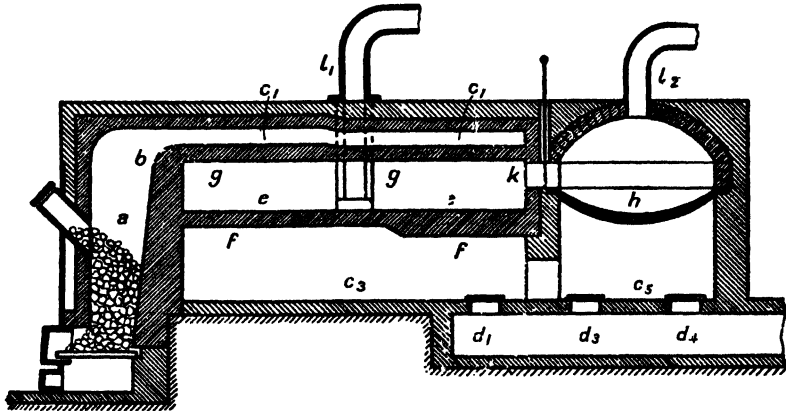


FIG. 1.—Salt Cake Muffle Furnace—Elevation.

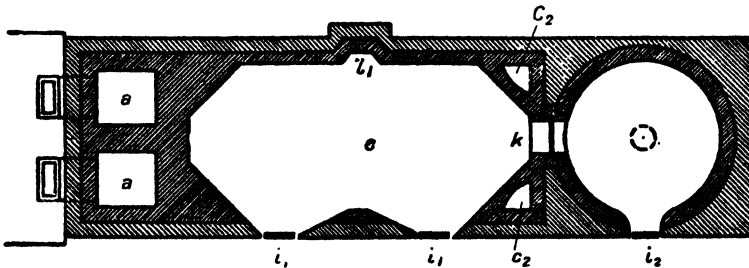


FIG. 2.—Salt Cake Muffle Furnace—Horizontal Section.

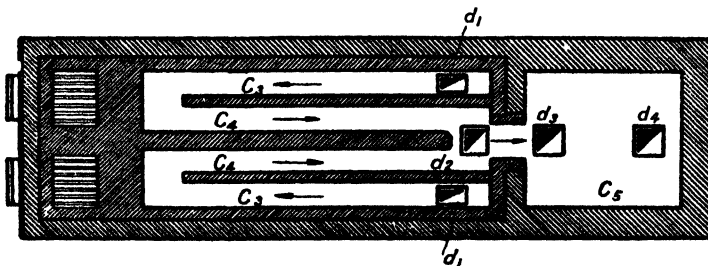
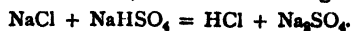


FIG. 3.—Salt Cake Furnace—Horizontal Section through Lower Flues.

and the mass is transferred into the muffle furnace (blind roaster) e , being spread over the floor by means of the doors i_1 . This muffle is composed of fire-clay or other acid-proof material, and is gas-tight although fairly thin walled. In this blind roaster the mass is raised to a high temperature by the hot gases playing round it from the furnace a , and the following change takes place:—



The HCl gas ("roaster gas") escapes through a sandstone pipe l_1 , the HCl gas here escaping being kept separate from the HCl gas (pan gas) coming from the pan through l_2 . The product in the muffle furnace must be constantly raked and stirred. The heating must not be so intense as to cause the finished sulphate to melt, and this regulation of the temperature is secured by allowing the hot gases coming from the two fireplaces $a a$ (Fig. 2) to first pass right above the muffle by c_1 , then vertically downwards through $c_2 c_2$, then again horizontally beneath the muffle through $c_3 c_3$, $c_4 c_4$, finally passing by c_5 beneath the pan and heating this somewhat, the gases finally escaping through $d_1 d_1 d_2$, d_3 and d_4 to the chimney stack.

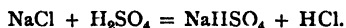
In the early years of the process open hearths were used, in which the flames from the fire played directly on to the mass placed on the hearth. The yield of these "open" roasting furnaces was greater than that of modern muffle (blend roaster) furnaces, and they were also more economical of coal. However, "open hearth" furnaces of this construction have now been almost entirely abandoned on account of the difficulty of condensing the HCl gas (which was thus mixed with the gases from the fire), and the impurities in the gas when condensed were very marked. Moreover, the "condensing" arrangements became choked up with dust from the fires.

The hot product, still emitting HCl gas, is finally raked out into iron transport vessels provided with lids, and standing immediately in front of the furnace. The product called "salt cake" is contaminated with iron, and is usually ground up. Meanwhile a fresh charge of salt is placed in the pan, and the operation repeated.

An average furnace works per day some twelve charges of 500 kg. sodium sulphate or salt cake.

For certain purposes "iron free" sodium sulphate is required—e.g., for making plate and mirror glass—and for this special sulphate the cast-iron pans are replaced by long **leaden** pans, made out of thick-walled lead, rectangular in section, and often some 5-8 sq. m. in area. These are very costly, and unless the firing is carefully adjusted they can be permanently damaged by melting under the heat applied.

Mechanical Salt Cake Furnaces.—Many attempts have been made to carry out the manufacture of salt cake in mechanical furnaces. Mactear's revolving furnace consists of a circular revolving bed covered with a fixed arch, between which and the bed the hot furnace gases stream. A mixture of salt and acid are continually fed into a large basin in the centre of the hearth, where the ingredients mix and react according to the equation:—



The mass overflows into the outer portions of the revolving floor, and are then highly heated by the hot furnace gases. Fixed stirrers continually mix the mass and gradually work it to the circumference over which it drops. The action is thus continuous, and the HCl gas evolved at a constant rate. It is claimed that in spite of the fact that the HCl gas is mixed with the whole of the furnace gases, the condensation is more readily effected and a more concentrated acid obtained than with the ordinary process.

Where mechanical furnaces, however, have not to any great extent displaced the ordinary furnace above described, except in one case—and that is the manufacture of sodium sulphate by heating the acid sodium sulphate (obtained as a by-product in the manufacture of HNO_3 from Chile saltpetre, NaNO_3) with salt, NaCl —the salt and the NaHSO_4 are both ground, and thoroughly mixed in circular flat enclosed ovens, made of special acid-resisting cast iron, and provided with stirring apparatus at the centre. The whole oven is enveloped in the hot gases coming from a furnace, and so the temperature of the whole is maintained at about 700°C . (above this the iron is strongly attacked by the HCl). The stirrers work mechanically with a raking movement from the centre, and continually mix the mass and urge it towards the periphery of the circular floor, where it is rejected as Na_2SO_4 . See Fig. 4.

The HCl gas is evolved in great purity and in a very concentrated form (30-35 per cent. by volume). At Mannheim in 1909 these mechanical furnaces were used to obtain a pure arsenic-free HCl gas, which, after freeing from H_2SO_4 dust in Cellarius condensers, is then led directly into the contact apparatus for Deacon's process for manufacturing chlorine, thereby reducing this latter process to its original simple form (see "Deacon's Process," p. 363).

2. Hargreave's Process for Manufacturing Sodium Sulphate.—This process dispenses with the manufacture of sulphuric acid. It depends upon the fact that although pure sulphur dioxide gas (SO_2) of itself does not decompose salt, yet a mixture of SO_2 , air, and steam will in time completely convert salt into Na_2SO_4 . The SO_2 reacts with the NaCl to form a little sulphite, which is then immediately at a temperature of 500°C . oxidised in the presence of air to sulphate, so that ultimately the following equation is realised:—

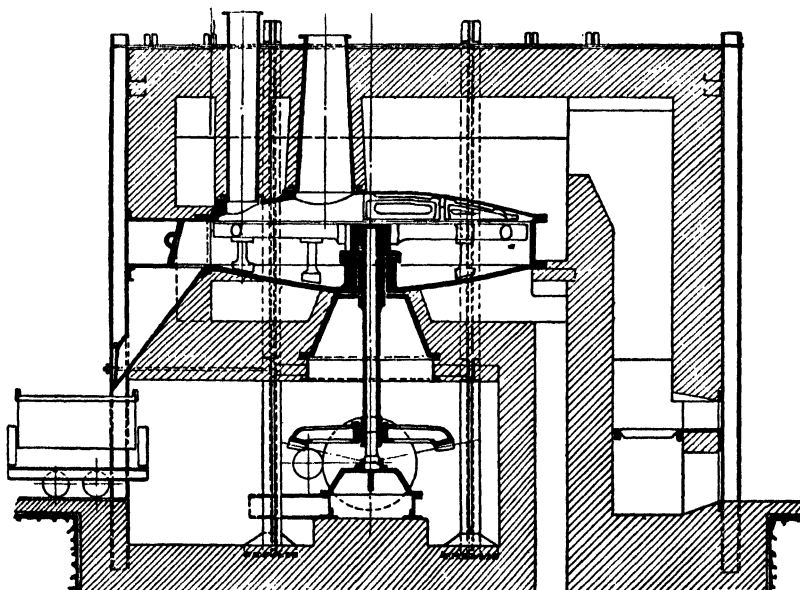
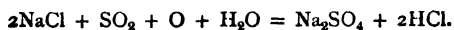


FIG. 4.—Mechanical Salt Cake Furnace.

The hydrochloric acid is separated from the evolved gases by passing them into hydrochloric acid condensing towers.

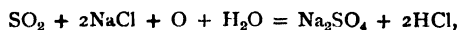
The salt is moistened and pressed into cakes of about half a brick in size, and then dried so as to form a porous cake. It is then placed in the kilns. These were (and sometimes still are) built of brick, so arranged that each kiln can be put into communication with its neighbour, and each separately heated with a fire. In the best practice, however, some ten large cast-iron cylinders some $5\frac{1}{2}$ m. in diameter by 3.7 m. in height, are connected up in two rows of five cylinders each to form a "cylinder battery." They are then filled with the dry porous cakes of salt, and the hot gases from the pyrites burners (such as are used in chamber sulphuric acid works), mixed with an equal volume of air and some steam, are led into the cylinders from above downwards, the fresh entering gases from the furnaces being led into that cylinder in which the process is most nearly completed (*i.e.*, containing much Na_2SO_4 and little NaCl), while the end gases, from which most of the SO_2 has been absorbed, are led into a cylinder filled with fresh NaCl. In general some eight cylinders are in action at once, the other two being placed out of action for emptying from the formed Na_2SO_4 and refilling with fresh NaCl.

Each cylinder holds about 50 tons of salt, and its complete conversion into sulphate requires about three weeks. The action proceeds best at a temperature of 500° C. Consequently each cylinder is fitted into brickwork and provided with a fireplace so that the whole cylinder can be externally heated. The first and last cylinders of the series are thus heated, but in the intermediate cylinders the action proceeds with the evolution of sufficient heat to maintain them at the proper temperature without the aid of external heat. In fact sometimes cooling of the intermediate cylinders is necessary since if the temperature gets beyond 600° C. the mixture of salt and formed sodium sulphate will fuse and so destroy the efficiency of the cylinder.

Pure salt fuses about 780° C., pure sodium sulphate at 860° C., while a mixture of the two at a lower temperature than either component alone, viz., at 600° C.

The gases are drawn off from the last cylinder of the series by means of a porcelain or earthenware exhauster. They contain about 10 per cent. HCl by volume, and after passing through cooling pipes, are led directly into the HCl condensing towers.

It should be noted that according to the equation :—



each volume of SO₂ produces double its volume of HCl gas. A battery, such as that described above, will yield some 7,000-7,500 tons of Na₂SO₄ per year, but the whole process requires very careful adjusting of the temperature, entering gases, etc., etc.

The great disadvantage of the process is the length of time required for the complete conversion of the salt into sulphate.

However, the process has been worked successfully in a great many factories in England since 1872, also in France and Germany.

Properties of Sodium Sulphate.—Anhydrous sodium sulphate (Na₂SO₄) is known as **salt cake**, enormous quantities being yearly produced by one or other of the processes above described. (The annual output is estimated at 360,000 tons.)

Good technical salt cake may contain up to 1 per cent. free H₂SO₄, 0.1 per cent. Fe, and 0.3-0.5 per cent. NaCl. However, if the substance is to be used for making mirror, plate, and other special kinds of glass, it must not contain more than 0.01-0.02 per cent. of iron, and so must be made from iron-free materials in leaden pans (see above).

In order to purify technical sulphate it is dissolved in water, and after the iron has been precipitated by the addition of calcium carbonate, the solution is evaporated and allowed to crystallise out in the cold, when it separates as "**Glauber's salt**" (Na₂SO₄·10H₂O). Should the crystallisation be carried out in a boiling solution the sulphate separates out as anhydrous sulphate (Na₂SO₄).

100 parts of water dissolve the following quantities of sodium sulphate, calculated as Na₂SO₄ :—

Temperature	0°	10°	20°	30°	34°	40°	50°	60°	70°	80°	90°	100°	105°
Na ₂ SO ₄ dissolved	5.02	9.00	19.4	40.0	55.0	48.8	46.7	45.3	44.4	43.7	43.1	42.5	42.2

The hydrate Na₂SO₄·10H₂O when in solution passes over into the anhydrous form at about +32° C. The solubility increases from 0° to +32° C., and thereafter decreases. The saturated solution boils at 103.5° C.

If ordinary Glauber's salt (Na₂SO₄·10H₂O) be exposed to the air or is heated it loses water and goes into the anhydrous salt.

Heated on charcoal or in the reducing flame, sodium sulphide (.Na₂S) is formed (see below).

Sodium hydrogen sulphate, sodium bisulphate, may be prepared by mixing equivalent quantities of Na₂SO₄ and H₂SO₄, and evaporating at a temperature over 50° C.

Sodium sulphide (Na_2S) is prepared on a large scale by melting sodium sulphate with coal in large "open" roasting furnaces, similar to those formerly used for making sodium sulphate. The hearths are made of "basic" lining, and rapidly attacked by the hot mass. The mass first melts to a thin mobile fluid, and CO gas bursts forth all over the surface and burns. As the heating proceeds, however, the liquid becomes somewhat more viscid. The mass is allowed to cool and the reddish solid is crushed into coarse fragments and lixiviated with water. The clear solution is evaporated, and allowed to crystallise out. The salt comes on the market in deliquescent crystals ($\text{Na}_2\text{S} + 9\text{H}_2\text{O}$), containing some 30-32 per cent. Na_2S . The crystals are sometimes dehydrated and come on the market in a concentrated form, containing some 60-65 per cent. Na_2S . However it is not possible to completely dehydrate the substance.

Sodium sulphide (Na_2S) is used on a large scale for making "sulphur" dyes (see **Martin's "Industrial Chemistry: Organic"**); it is also used in tanneries for removing the hair from skins.

Statistics—

In 1925 the European output of salt cake was 590,000 tons, made up as follows: **Germany**, 290,000 tons; **Great Britain**, 150,000 tons; **Belgium**, 80,000 tons; **France**, 70,000 tons.

In 1925 Great Britain exported 75,000 tons. In 1928 the figure was 77,789 tons.

SECTION XXV

GENERAL SURVEY OF THE
SODIUM CARBONATE INDUSTRY

BY GEOFFREY MARTIN, D.Sc., Ph.D.

LITERATURE

C. C. CONCANNON.—*Chem. Trade Journ.*, 1929, **84**, 323.H. O. MORAW.—*Chem. Trade Journ.*, 1929, **85**, 173.

General Survey

Natural Sodium Carbonate is found encrusting the soil in parts of Egypt, being produced, no doubt, by the weathering of the sodium sulphate left by the drying up of old Egyptian lakes and seas.

This sulphate (Na_2SO_4) is reduced to sodium sulphide (Na_2S) by the action of certain fungi and algae. CO_2 in the soil and atmosphere then converts the Na_2S into Na_2CO_3 with evolution of H_2S .

A considerable amount of this natural soda, called "Trona," is even at the present time collected. It has the composition $\text{Na}_2\text{CO}_3 + \text{NaHCO}_3 + 2\text{H}_2\text{O}$, mixed with salt. Other deposits of natural soda occur in California, Mexico, Persia and other tropical lands, the carbonate actually separating in a crystalline form from numerous tropical "soda" lakes and seas in the dry season, also from the Caspian Sea and the Araxes.

One of the most remarkable deposits of natural soda occurs in the Owens Lake, California, the waters of which contain per litre 31 g. Na_2CO_3 , 11 g. Na_2SO_4 , and 31 g. NaCl . Some 20,000,000-50,000,000 tons of soda are estimated to be here stored up, and the exploitation of this source has already commenced.

Early in 1911 a company with a capital of £1,312,500 was formed to acquire a ninety-nine years' lease of and to develop the deposit of natural soda covering some 30 sq. miles known as Lake Magadi, in the British East Africa Protectorate, to connect same with the Uganda Railway, about 100 miles, and to build a pier and approaches at or near Kibudini, British East Africa.

The deposit is said to contain some 200×10^6 tons of soda, of which 40×10^6 are in the upper layers.

The deposit is remarkably pure but contains sodium fluoride. Sodium sulphate is the mother substance of Egyptian soda; however, some deposits of natural soda undoubtedly arise from the decomposition (by atmospheric CO_2) of sodium silicates, silicic acid being set free and sodium carbonate formed.

For many years the ashes of seaweed and of wood formed the chief European sources of potash and soda. But the great demand for cheap soda for making soap for the cotton industry caused Leblanc in 1791, with the assistance of Dizé, to invent the process for converting salt into soda which now bears his name.

The process consists, essentially, in heating salt with sulphuric acid, thereby converting it into sodium sulphate. The sulphate is then ignited with calcium carbonate and coal and is thereby converted into sodium carbonate.

Leblanc, the originator of one of the world's greatest chemical industries, which has given us cheap soap and cheap glass and has poured directly or indirectly untold wealth into numerous lands, did not meet with any reward in his lifetime. He died, by his own hand, a ruined man in the madhouse of a workhouse in 1806; some fifteen years before he had won the prize offered by the French Academy (1791) for the best method of converting salt into soda.

In France political troubles prevented the development of the soda industry. It was Muspratt in England, who in 1824, after the repeal of the salt tax, built the first Leblanc soda factory, and thus created the great chemical industry of to-day. Thus, a supply of cheap sulphuric acid in large quantities is one of the first essentials of the Leblanc process, and so the enormous sulphuric acid industry of to-day owes its origin to the Leblanc process; next, the production of excess of hydrochloric acid, as a waste product, in the salt cake furnaces called into existence the chlorine industry and the manufacture of bleaching powder; so that a group of inter-connected chemical industries sprang up in England soon after 1824, and for more than fifty years English manufacturers and merchants controlled the world's markets. Great soda factories sprang up everywhere in the neighbourhood of the salt and coal deposits, especially at Newcastle-on-Tyne, Glasgow, Widnes, and St Helens in Lancashire.

In 1866 Solvay introduced his "ammonia soda" process, which was the beginning of a new era for chemical industry. No sulphuric acid is necessary in this process for making soda, and no hydrochloric acid is generated; moreover, this process allowed the production of sodium carbonate at much lower cost than the Leblanc process.

Consequently between 1870-1875 the price of sodium carbonate declined from £13 per ton to only £4-£5; and at the present time the Leblanc process is not remunerative, so far as the sodium carbonate is concerned, being mainly kept going by the value of the produced hydrochloric acid (which is required in the bleaching powder industry), the recovered sulphur, and other products.

A new era in the industry began in 1895, when the alkali chlorides began to be electrolysed on the large scale for the manufacture of chlorine and caustic alkalis, and it appears that this new process must gravely threaten the Leblanc process. Indeed the Leblanc process, owing to the competition of these cheaper processes, has ceased to be worked in most countries. Several large Leblanc works are still operated in England, and two in Germany, but it remains doubtful whether they can hold their own in spite of great improvements in plant and process, and the amalgamation of the various interested parties in the "United Alkali Co." We must remember, however, that the Leblanc process works in with the wet copper process, with CS_2 manufacture, and various other important industries. However, the enormous supplies of sodium carbonate formerly consumed by the glass industry have been now largely replaced by the use of the cheaper sodium sulphate. As a consequence of this, the first part of the Leblanc process, namely, the formation of sodium sulphate (salt cake) by the action of sulphuric acid or salt, has actually increased of late years. It is only the second part of the process—the calcining of this sodium sulphate with coal and limestone—that has decreased, subjected as it is to the competitive action of the ammonia soda process.

The ammonia soda process has made rapid headway during the last thirty years, and at the present time it is practically the only sodium carbonate process worked on the large scale in the United States, France, Belgium, and Austria. In Germany it is the main process worked for the production of sodium carbonate, the Leblanc process in Germany being in a very threatened condition, only two factories in 1909 (*viz.*, at Stolberg and at Heinrichshall) now working the Leblanc process.

The ammonia soda process is not threatened to any great extent by the growth of the electrolytic processes for making caustic soda and chlorine, because the amount of sodium carbonate and alkali required for industrial purposes is far greater than the amount of chlorine and bleaching powder required, so that even in the event of the electrolytic processes completely covering the world's demand for chlorine or bleaching powder, the yield of alkali then produced would only be a small fraction of that which is necessary to commerce.

To sum up, it would appear that three main processes will continue to be simultaneously worked on a very large scale, *viz.* :—

1. The **salt cake** process (viz., $\text{NaCl} + \text{H}_2\text{SO}_4$) for making sodium sulphate and hydrochloric acid.
2. The **Hargreave's** process for the same products also seems well established.
3. The **ammonia soda** process for sodium carbonate, sodium bicarbonate, and caustic soda.
4. The **electrolysis of alkali chlorides** for caustic potash, caustic soda, and chlorine.

On the other hand the calcining of the sodium sulphate with limestone and coal (second stage of Leblanc process) ultimately may be abandoned completely.

Statistics

Counting together the sodium carbonate, bicarbonate and caustic soda, the following figures show the world's production in these chemicals in 1884.

	1884.	
	Leblanc Soda.	Ammonia Soda.
	Tons.	Tons.
England - -	385,000	52,000
Germany - -	56,500	44,000
France - -	70,000	57,000
United States - -	...	1,100
Austria-Hungary - -	39,000	1,000
Russia - -
Belgium - -	...	8,000
Total -	545,500	163,000
	Leblanc Soda.	Ammonia Soda.
Total -	708,500	

In 1903 Solvay estimated the world's production of soda as 1,750,000 tons—1,600,000 of which being produced by the ammonia soda process and only 150,000 tons by the Leblanc process.

In 1908 Lepsius put the world's production at 2,000,000 tons, only 100,000 of which being made by the Leblanc process. This quantity shows a consumption of soda of 1.3 kg. per head of population throughout the world.

The German net export, 1909 (after subtracting the slight import), was as follows :—

Soda (principally calcined)	-	57,400	tons at	90	marks.
Bicarbonate	-	1,200	"	215	"
Caustic soda	-	8,280	"	215	"
Sodium sulphate	-	65,500	"	30	"
Na_2S and K_2S	-	7,000	"	160	"

The total value was put at 10,200,000 marks = £510,000.

Between 1923 and 1927 the world's export trade in caustic soda amounted to 220,000 tons per annum, of which total Great Britain contributed 50 per cent. The United States production of caustic soda between 1923 and 1927 was 50,000 tons per annum. The actual production in the U.S.A. was 436,000 tons in 1923 and 584,000 tons in 1927. During the period 1923-1927 the United States lost 88 per cent. of its European markets for caustic soda.

The total world production of **soda** was 2,840,000 tons per annum in 1927, the U.S.A. being the largest producer, Great Britain coming second. The following figures show the

total soda alkali exports in 1927 of four major countries of the world in short tons of 2,000 lbs. :—

Destination.	Sodium Carbonate.	Caustic Soda.	Total Alkalis on Soda Ash Basis of 58 % Na ₂ O.
	Tons.	Tons.	Tons.
Europe - - -	236,700	66,300	324,900
North and Central America and West Indies - - -	29,800	23,900	61,600
South America - - -	40,100	34,700	86,200
Far East - - -	282,200	89,700	401,600
Africa - - -	2,100	4,100	7,500
Unclassified - - -	24,500	10,200	38,000
Total - - -	615,400	228,900	919,800

SECTION XXVI

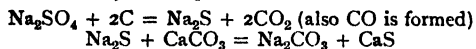
THE MANUFACTURE OF SODIUM
CARBONATE AND CAUSTIC
SODA BY THE LEBLANC
PROCESS

LITERATURE

- G. R. ROBERTSON.—*Ind. Eng. Chem.*, 1931, 23, 478.
 I. UNGE.—“ Sulphuric Acid and Alkali.” 1913.
 HÖLBING.—“ Fortschritte in der Fabrikation der Anorg. Säuren, der Alkalien, u.s.w. 1893-1905.” Berlin, 1905.
 DAMMAR.—“ Chemischen Technologie.” 1895. “ Chemische Technologie der Neuzeit.” 1910.
 ULLMANN.—“ Enzyklopädie der technischen chemie.” 1914.
 THORPE.—“ Dict. of Applied Chemistry.” 1913.
 HOUGHTON and MILLER.—United States Patent, 1,853,275 (1933).
 A. MENTZEL.—British Patent, 366,420 (1932).

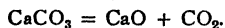
**Manufacture of Sodium Carbonate (Soda) and Caustic
Soda by Leblanc Process**

THIS process consists in melting together sodium sulphate (salt cake), coal, or coke, and limestone or chalk, when the sulphate is reduced by the carbon to sodium sulphide, which then reacts with the calcium carbonate (chalk, limestone) to yield sodium carbonate, as shown by the equations:—

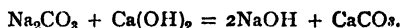


The calcium sulphide (CaS) formed is insoluble in water, so that in order to isolate the sodium carbonate all that is necessary is to lixiviate the mass with water.

In practice a considerable excess of limestone and coal is employed, so that much free CaO (calcium oxide) is formed, thus:—



When this mass is then slaked with water calcium hydroxide is formed with the evolution of heat ($\text{CaO} + \text{H}_2\text{O} = \text{Ca(OH)}_2$) which then reacts on the sodium carbonate to produce caustic soda, thus:—



This procedure greatly aids the rapid lixiviation of the mass with water, and indeed at the present time the English Leblanc factories prefer to work the mass solely for caustic soda as it is cheaper and finds a readier sale among soap makers.

Melting Process.—100 parts of sodium sulphate (salt cake), 90-120 of calcium carbonate in the form of limestone or chalk, and 40-80 of carbon in the form of “slack” or powdered coal are heated together in a furnace. It is important that the calcium carbonate should be as pure as possible and that the sodium sulphate (salt cake) should be of good quality.

Fig. 1 shows an old “open” roasting furnace (“black ash furnace”), still fairly widely used. It is provided with two hearths made of fire-fast bricks, embedded with mortar in a layer of stamped clay. The mixture of sulphate, coal, and limestone is first placed on the hearth

A, where it receives a preliminary heating. It is then raked forward to the hotter hearth *B*, and here heated to bright redness. The mixture first melts to a thin fluid mass, then becomes pasty, and CO_2 gas is copiously evolved. Towards the end of the reaction, little jets of burning CO gas, known as "candles," burst forth over the surface of the fluid mass. During the whole process, a workman continually rakes and mixes the fluid mass by means of long arms inserted through a side door in the furnace; and when the mass reaches the right consistency the charge is withdrawn into iron boxes standing just below the furnace. It requires some experience to know when to withdraw the charge, for if the heating is continued too long, not only is sodium

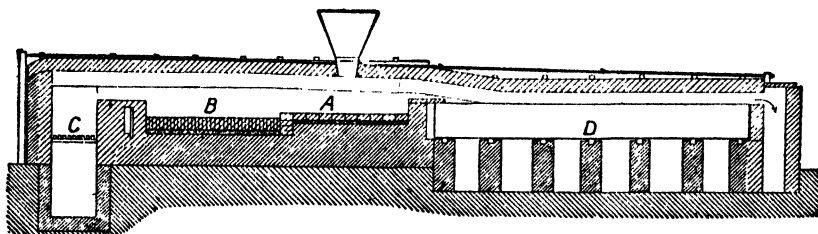


FIG. 1.—Old Type "Open" Black Ash Furnace.

oxide (Na_2O) formed (which reacts with the CaS present to regenerate Na_2S and Na_2S_2), but also the mass becomes hard and non-porous, and so difficult to lixiviate with water. The product at this stage is known as "black ash."

One of these furnaces takes a charge of some 150 kg. sodium sulphate (salt cake), and the operation is complete in about fifty minutes. The waste heat from the furnaces is usually utilised in evaporating the crude soda solution obtained by lixiviation (as described below), *D* being an iron tank containing the soda solution, over the surface of which the hot gases from the surface stream.

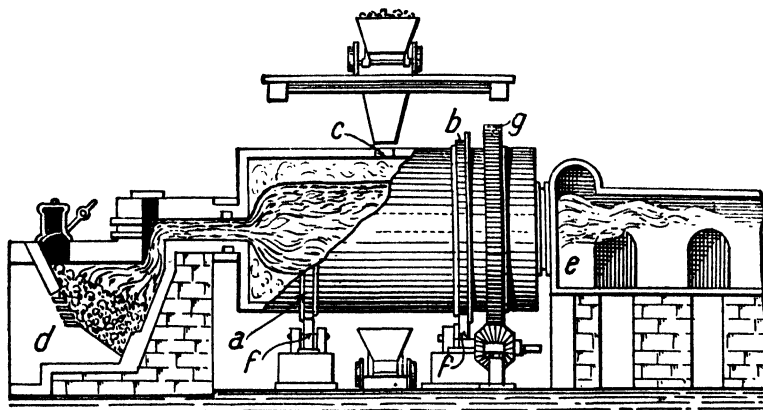


FIG. 2.—Revolving Black Ash Furnace.

The larger works, however, now usually employ large, mechanical, revolving black ash furnaces, shown in Fig. 2.

It consists of a large, horizontal, slowly revolving cylinder, some 10-15 ft. diameter, and 15-20 ft. long, made of boiler plate, and coated internally with fire-fast bricks or clay; an opening *c* serves either to fill or empty the cylinder. The hot gases and flames from the furnace *d* play through the interior of the cylinder as shown, and so uniformly heat the contents to a high temperature; the rotation of the cylinder (at first slow, but afterwards to 5-6 revs. per min.) thoroughly mixes the charge, and brings every portion under action of the flames. The hot furnace gases escape at *e*, and are utilised for evaporating the crude soda liquors from the lixiviating tanks as described in the open black ash furnace.

a and *b* are two steel bands on which the cylinder rotates, resting on the

friction wheels *f, f*. The whole is rotated by the massive cog-wheel *g*, the power being supplied by a steam engine.

The usual charge for a revolving black ash furnace of this type is 2 tons of sodium sulphate (salt cake), 2 tons of crushed limestone, and 1 ton of "slack" or powdered coal. The process is carefully watched by experienced workmen, and as the long yellowish green flames of carbon monoxide make their appearance, the operation is complete, and the cylinder is revolved until the opening *c* is just over an open iron truck. The door of the opening *c* is released, and the fused contents of the cylinder are discharged into the iron truck placed beneath. This truck runs on rails, and is drawn forward by means of an iron chain. As one truck fills, it is drawn forward and replaced by another. Finally the furnace is recharged, and the operation completed.

The whole process must be carefully controlled by experienced workmen, as too long or too short a period of heating will spoil the yield.

Process of Lixiviation.—The black ash so obtained consists of 39.45 per cent. Na_2CO_3 , 27.31 per cent. CaS , 9.11 per cent. CaO , and about 5.6 per cent.

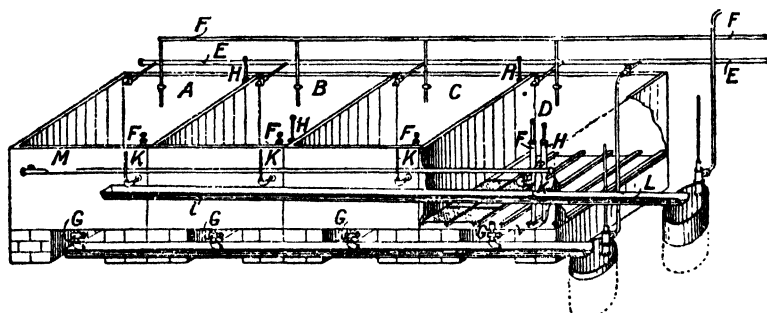


FIG. 3.—Shank's Black Ash Lixiviating Tank.

of unaltered coal, together with small amounts of unaltered Na_2SO_4 , NaCl and silicates.

Fig. 3 shows Shank's process of lixiviation, the system which is now generally employed. A, B, C, D are a number of iron tanks (4-6), all of the same height, each provided with an inlet tube E for water, and with a steam-pipe F for blowing steam into each tank with the object of maintaining the temperature of the contents of each tank at about 50°C ., thereby aiding the solution. G, G, G are outlet taps for running off the liquid contents of the several tanks. Each tank is also provided with two overflow pipes F and H, and with a false bottom of sieve-like or perforated nature.

The coarsely broken up black ash is placed on the perforated false bottom of all the tanks except one (which is put out of action for the purpose of emptying from extracted residues or for filling up with a fresh charge), and fresh water is allowed to flow from the water pipe E into the tank A, filled with black ash which already has been almost completely extracted. This incoming water floats upon the specifically heavier Na_2CO_3 solution in the bottom of the tank, and causes the liquid to flow through the overflow pipe H into the second tank B, where a still stronger solution of Na_2CO_3 is found. Here the same process continues, and so a stream of fluid of gradually increasing concentration flows in succession from one tank to another, until it reaches, say, the tank C filled with fresh black ash. Here the overflow pipe H is shut off, and so the saturated solution escapes by the overflow pipe F into the channel L, and is run off into the evaporating tanks. In the meantime, the tank D is recharged with fresh black ash, and the tank A is put out of action and emptied from the waste. So that B now forms the initial tank of the series and D the last, the saturated solution now issuing out of D. A is then refilled with fresh black ash, and becomes the last tank (B being put out of action and emptied), the connection between D and A being maintained by the pipe M.

This system has been in operation at St Helens since 1861. It is an application of the discontinuous counter-current principle.

There is left behind in the tanks, after the sodium carbonate and caustic soda have been crushed out, a mass of calcium sulphide (CaS), unchanged coal and

calcium carbonate. This is known as "**tank waste**" and is treated as described on p. 297.

The liquor drawn off is usually green in colour; it contains as impurities some thiosulphate and sodium sulphide in addition to excess of sodium carbonate and sodium hydrate. The specific gravity is usually 30° - 32° Bé. It should be noted that for rapid and complete extraction the black ash should be porous and contain some 10 per cent. or more of CaO, so that, when treated with water, the mass crumbles and swells up. The $\text{Ca}(\text{OH})_2$ formed converts part of the Na_2CO_3 into NaOH (see below).

The saturated black ash liquor can now be worked either for the manufacture of sodium carbonate or for the manufacture of caustic soda. We will take each in turn.

1. Working the Black Ash Liquors for Sodium Carbonate (Soda)

The liquid contains a considerable amount of caustic soda, "NaOH," produced by the action of the free lime on the Na_2CO_3 . The first process, then, is to "carbonise" it by passing in CO_2 . The liquid is allowed to trickle down

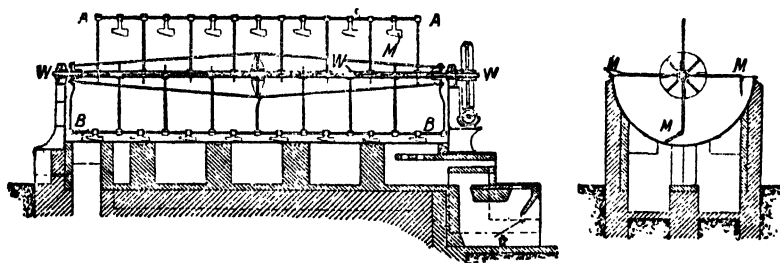


FIG. 4.—Thelen Evaporator.

tall iron towers, where it meets an ascending stream of CO_2 gas and air coming from limekilns. Sometimes the burnt gases from furnaces (also rich in CO_2) are used for this purpose. The CO_2 converts the NaOH into Na_2CO_3 ($2\text{NaOH} + \text{CO}_2 = \text{Na}_2\text{CO}_3 + \text{H}_2\text{O}$), and simultaneously Fe_2O_3 , Al_2O_3 , SiO_2 , etc., are precipitated, while oxygen in the hot entering gases oxidises the sulphides (e.g., Na_2S , FeS) to sulphates. The soda solution is now passed through filter presses and then is evaporated.

One process of evaporation much in vogue (on account of its cheapness) was the passage of the hot gases from the **black ash furnaces** over the **surface** of the liquor contained in tanks (see Fig. 1). The liquor thus becomes contaminated by ashes, etc., but by this "surface evaporation" the formation of hard firm crusts of soda at the bottom of the tank is avoided—an evil which at once results, if attempts are made to evaporate the liquors by heating from beneath, when these crusts settle and, like "boiler scale," greatly diminish the efficiency of the heating process.

This difficulty has been surmounted by the employment of special pans in which the bottom of the tanks are continually stirred by revolving arms, thus preventing the setting hard of solid crusts. Fig. 4 shows the well-known and very efficient **Thelen** evaporator.

It is set on brickwork and heated from beneath by the hot gases coming from the black ash furnace. The section is semicircular as indicated, and attached to a horizontal shaft, w w; running lengthwise down the pan are two other shafts A A, B B, to which are attached a number of wedge-

shaped scrapers *MMM*, loosely turning on the axle as these revolve about the central axle, and hanging vertically by their own weight when raised out of the pan.

As the main axle *W W* revolves the two subsidiary axes *A A*, *A A* revolve and the scrapers attached to them scrape the bottom of the pan as indicated in the cross section (Fig. 4).

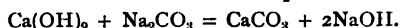
Any crystals of soda which separate out are scraped up by the scrapers out of the liquid and fall over the side of the pan, where the substance is shovelled away into vessels provided with a sieve-like bottom, from which the water drips away leaving the soda crystals to dry. When the evaporation takes place at a boiling heat the sodium carbonate crystals which separate out have the formula Na_2CO_3 . They are removed and heated more strongly (to completely dehydrate) in similar pans, but provided with crushing rollers, which run along the bottom of the pan, and are attached in a similar manner to rotating axles. The product is "soda ash," and is put on the market practically anhydrous, containing 98.99 per cent. of Na_2CO_3 ; 0.8 per cent. Na_2SO_4 ; 0.1 per cent. NaCl ; 0.1 per cent. sodium sulphite or sodium thiosulphate, with a little insoluble matter (less than 0.1 per cent. in good samples) and less than 0.7 per cent. of water.

In England this alkali is sold on the basis of the percentage of Na_2O it contains, an ash of the above composition being denoted as 58 per cent. alkali, *i.e.*, 100 parts contain 58 parts of Na_2O .

2. Working the Black Ash Liquors for Caustic Soda

The cheap and pure sodium carbonate obtained by the ammonia soda process (see below) has largely destroyed the market in England for Leblanc sodium carbonate, and consequently most English Leblanc alkali factories now work the black ash liquors directly for NaOH . There is a far more ready sale for caustic soda than sodium carbonate, because of the demand for the latter substance by industries such as the paper trade, the textile and cellulose (straw, etc.) industries, the oil and fat industry, soap makers, manufacturers of dyes (*e.g.*, Alizarin).

Owing to the presence of much free lime in the black ash the black ash liquors contain a very considerable amount of NaOH . The black ash liquor is diluted to 13° Bé. (= 13 per cent. NaOH in final liquor) and run into semispherical iron pans, in which are suspended wire cages filled with quicklime, CaO ; steam is driven through the liquid to maintain it at a boiling temperature, while a strong current of air pumped in at the bottom causes a thorough agitation of the contents and thus accelerates the causticisation which takes place according to the equation:—



The air blown in oxidises the sulphides of iron and sodium, the iron separating out at the bottom of the tank.

It should be noted that the solubility of lime, Ca(OH)_2 , in the liquor rapidly decreases with the amount of NaOH formed, and consequently a concentrated Na_2CO_3 liquor cannot be completely causticised by lime. Even a 10 per cent. Na_2CO_3 solution can only be causticised by lime to the extent of 97.3 per cent. However a very dilute solution would cause much expense and trouble in evaporating afterwards, and so in practice a moderately concentrated solution is taken, and the unchanged Na_2CO_3 is afterwards removed by crystallisation. The causticisation is greatly accelerated by heating, without, however, sensibly altering the equilibrium composition of the liquor. A much more complete causticisation is theoretically producible by using a more soluble base, such as strontium hydroxide, Sr(OH)_2 , or barium hydroxide, Ba(OH)_2 . Practically, however, the superior cheapness of lime more than compensates for the incomplete conversion of the sodium carbonate into caustic soda, and so lime is always employed for the purpose.

After the boiling has continued for a sufficient length of time, the liquid is allowed to settle, when the calcium carbonate (CaCO_3) and precipitated iron salts settle out at the bottom of the vessel, leaving a clear supernatant layer of NaOH . This is siphoned off clear, while the settled mud is washed on a filter. Finally the solution of NaOH is boiled down in multiple vacuum pans (such as is described in **Martin's** "Industrial Chemistry: Organic," under **Sugar**) made of cast iron. Almost invariably the process of evaporation is carried out in two distinct stages. First the liquor at $16^\circ\text{--}17^\circ$ Bé. is concentrated in one set of evaporators until a density

of 26°-27° Bé. is attained. It is then run off into a second set of vacuum pans and boiled down until the density reaches 40° Bé., the Na_2CO_3 , NaCl , Na_2SO_4 , and other salts which crystallise out as the concentration proceeds being separated by passing the liquor through filters interposed between the various vacuum pans. Finally the concentrated liquor is run out into thick cast-iron semispherical pots, set in brickwork over a free fire, and capable of holding some 10-15 tons of NaOH . Here the boiling down is continued, the pots being finally heated to 400°-500° C., the NaOH being actually fused.

Now the caustic soda obtained by the Leblanc process always contains much impurity, principally sodium sulphide (Na_2S), iron sulphide (FeS), and also sodium cyanide (NaCN), in the form of ferrocyanide derived from the nitrogenous matter in the coal used for melting the sodium sulphate. The product is therefore purified by adding sodium or potassium nitrate to the molten mass, whereby the sulphides are completely oxidised and the ferrocyanides are destroyed with separation of graphite, while the iron separates as a red precipitate of ferric oxide. As Ralston showed in 1860, when the caustic soda is anhydrous all the iron separates, and the addition of only a handful of nitre will cause a large pot containing some 16 tons of molten NaOH to change from yellow, through white, to green or vice versa. Too much nitre must not be added as it colours the molten mass greenish owing to the formation of a trace of manganate.

After partial cooling, during which the very considerable precipitate of iron hydroxide, etc., is allowed to settle out at the bottom, the still molten caustic, which is as clear and limpid as water, is ladled out into thin sheet-iron drums, allowed to solidify, and the drums soldered up air-tight as soon as the caustic soda has set. Occasionally the solid mass is smashed into lumps before packing in iron drums (which are soldered up air-tight). Sometimes the NaOH is ground to a powder in special machines provided with precautions against the escape of NaOH dust into the air, and the powdered NaOH is then packed as before.

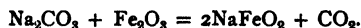
"White caustic," as colourless caustic soda is called, was first manufactured by this process from Leblanc soda about 1862, and is now put on the market containing as much as 76 per cent. of alkali, other strengths being made, however, down to 60 per cent. alkali.

Caustic soda is manufactured in exactly the same way from the sodium carbonate prepared from the ammonia soda process. The initial raw material is here "calcined soda," and the only difference in the mode of preparation is that the NaOH thus produced is somewhat purer, so that the addition of nitre in the final fusion of the NaOH is unnecessary. The principal impurities in the NaOH made from ammonia soda sodium carbonate is NaCl and unchanged Na_2CO_3 .

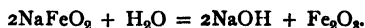
These impurities, however, do not cause any trouble in the application of the NaOH for many industrial purposes, e.g., soap making, as the soap itself often contains 20 per cent. and more NaCl .

Among other processes for making caustic soda we must here mention the **Löwig process** employed by the Solvay Works (see also British Patent, 391,462 (1933)).

Calcined sodium carbonate (soda ash), as sodium bicarbonate prepared by the ammonia soda process, is employed. The substance is mixed with iron oxide and heated in a revolving cylinder furnace similar to the revolving cylinder black ash furnace described above. The last furnace gases and flames streaming through the interior of the cylinder heat the mass to redness when the following action takes place:—



All the CO_2 escapes, and the resulting sodium ferrite (NaFeO_2) is raked out and lixiviated with water, when it decomposes according to the equation:—



A concentrated solution of NaOH is immediately obtained, under which the iron oxide settles out as a dark mass. The NaOH solution, in a practically pure condition, is drawn off, evaporated, and melted as above described, no nitre being necessary for the final melting.

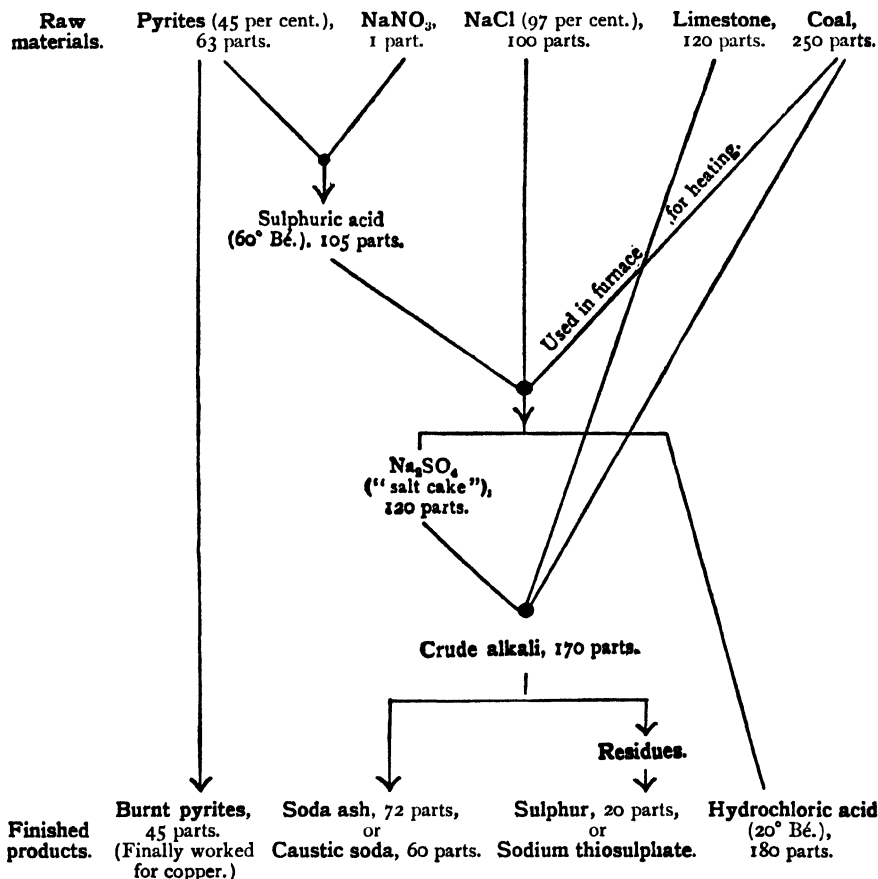
Considerable amounts of caustic soda and caustic potash are prepared by the **electrolysis of NaCl or KCl solutions**. These processes are described in detail under the heading "Electrolytic Chlorine and Alkali," p. 367, and so we will not further deal with them here, except to say that the NaOH or KOH solutions drawn off are evaporated as above described in vacuum pans, freed

from NaCl or KCl, crystallising out, and finally melted in large iron pots (see p. 296). (See Schulz, *Chem. Zeit.*, 1932, 56, 889, and J. Haladen, *Trans. Electrochem. Soc.*, 1933, 63, 183.)

The mercury diaphragm process yields a chlorine-free NaOH or KOH, while that obtained by the diaphragm process yields an NaOH (or KOH) solution rich in NaCl (or KCl). However, the NaCl (or KCl) almost entirely crystallises out during the concentration of the solution, being very insoluble in concentrated NaOH solution. Where the NaOH solution is not immediately used for Alizarin manufacture (see Martin's "Industrial Chemistry: Organic") it is boiled down, fused, and packed in iron drums for transport or export as above described.

SUMMARY OF THE LEBLANC PROCESS.

(After Ost, slightly modified.)



In England the strength of the caustic soda is expressed on the basis of the percentage of Na₂O it contains. Thus a pure NaOH (100 per cent. NaOH) would be in England denoted as 77.5 per cent. caustic soda, since 100 parts of NaOH contain 77.5 parts of Na₂O.

In Germany, however, its strength is calculated on the supposition that this Na₂O is combined as Na₂CO₃, e.g., a 100 per cent. NaOH in Germany would be denoted as a 132.5 per cent. caustic soda (because 100 parts of NaOH are equivalent to 132.5 parts of Na₂CO₃).

For details the reader should consult Kcane-Lunge, "Technical Methods of Analysis."

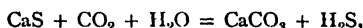
Treatment of Alkali Waste.—After the lixiviation of the black ash for sodium carbonate and caustic soda (see p. 294), there is left behind in the tanks a mass of calcium sulphide, together with unchanged coal and unchanged calcium

carbonate, lime, etc. ($\text{Na}_2\text{SO}_4 + \text{CaCO}_3 + 2\text{C} = \text{Na}_2\text{CO}_3 + \text{CaS} + 2\text{CO}_2$), the product being known as "tank waste" or "alkali waste."

To every ton of soda produced nearly a ton of these residues accumulated, which formerly were an intolerable nuisance, since by the action of atmospheric acids on the calcium sulphide, sulphuretted hydrogen (H_2S) was set free, poisoning the air in the neighbourhood. Also the drainage from the mass, containing as it did soluble sulphur-containing compounds and sulphuretted hydrogen, was very harmful. This mass also contained the total sulphur introduced into the process (as Na_2SO_4), which was therefore lost.

This waste mass is now worked for sulphur by the **Chance-Claus process**, the sulphuretted hydrogen being either burned in a Claus kiln to produce sulphur, as described on pp. 204 and 208, or else it is burned to SO_2 and converted into sulphuric acid.

The Chance process is expressed by final equations :—



from which it is obvious that the calcium carbonate (CaCO_3), originally introduced into the process is again capable of being recovered and used again. Since the sulphur is also recovered in the form of H_2S (and ultimately as S or H_2SO_4) there is now no more "waste" theoretically produced by the Leblanc process. Sometimes the waste residues are worked for sodium thiosulphate (hyposulphite) ($\text{Na}_2\text{S}_2\text{O}_3 \cdot 5\text{H}_2\text{O}$), as described on p. 259.

It is said that 30,000-40,000 tons of sulphur are annually recovered by this process in Great Britain.

It can be safely stated that without the Chance-Claus process, Leblanc soda would long have become entirely defunct, not only on account of the financial loss of the sulphur, but also on account of the objectionable nature of the alkali waste itself, which weathers and oxidises, producing H_2S and SO_2 , even catching fire occasionally, and the drainage from which is naturally an exceedingly unpleasant and harmful liquor.

SECTION XXVII

MANUFACTURE OF SODIUM CARBONATE BY THE AMMONIA SODA PROCESS

BY STANLEY SMITH, M.Sc. (Birmingham),
Late Manager of the Ammonia Soda Co. Ltd.

LITERATURE

- L. G. HUGHES.—*Chem. Met. Eng.*, 1930, 37, 232.
 W. E. PIPER.—*Chem. Met. Eng.*, 1930, 37, 362.
 SCHREIB.—*Zeits. angew. Chem.*, 1888, 283; 1889, 445, 485.
 BRADBURN.—*Journ. Soc. Chem. Ind.*, 1896, 884.
 BODLANDER and BRUELL.—*Zeits. angew. Chem.*, 1901, 381, 405.
 M'COY.—*Amer. Chem. Journ.*, 1903, 29, 437.
 H. V. JUPTNER.—*Oest. Chem. Zeit.*, 1904, 247.
 FEDOTIEFF.—*Zeits. Phys. Chem.*, 1904, 492.
 MEYERHOFFER.—*Verh. Gewerbli.*, 1905, 167.
 JANECKE.—*Zeits. angew. Chem.*, 1907, 1559.
 ROHLAND.—*Oest. Chem. Zeit.*, 1908, 62.
 JURISCH.—“*Chemische Industrie*,” Berlin, 1910, 346.
 MASON.—*Chem. Zeit.*, 1910, 137.
 — *Chem. Zeit.*, 1914, 2.
 COLSON.—*Journ. Soc. Chem. Ind.*, 1910, 186.
 HEMPEL and TRDESCO.—*Zeits. angew. Chem.*, 19, 24, 2459.
 H. SCREIB.—“*Die Fabrikation der Soda nach dem Ammoniak-verfahren.*”
 LUNGE.—“*Sulphuric Acid and Alkali*,” Vol. III.

Present Position of the Ammonia Soda Process.—The manufacture of sodium carbonate by the ammonia soda or Solvay process occupies to-day a predominant position in the chemical industry. During the period, 1864-1868, the annual output of soda ash by this process amounted to 300 tons. In the year 1902 it had grown to 1,600,000 tons, whilst at the present time the total production probably exceeds 3,000,000 tons per annum.

During the years 1879-1883 the output by the Leblanc process reached a maximum of 500,000 tons per annum. Since that time the Leblanc industry has steadily declined, and were it not for the recovery of by-products and the large amount of capital invested in this process, it is probable that the production of the Leblanc alkali would by this time have entirely ceased.

The manufacture of bleaching powder with the aid of electrolytic chlorine has considerably affected the Leblanc industry, and doubtless this influence will be felt even more seriously in the future.

The ammonia soda process produces sodium carbonate in a higher state of purity and at a much lower cost than the Leblanc process. Recently competition and a desire to stimulate the demand for ammonia alkali has resulted in a considerable reduction in the price of this article, with the consequence that it is almost impossible for the makers of soda ash by the Leblanc process to compete.

The ammonia soda process itself will soon be confronted with competition by the exploitation of natural deposits of soda which occur near Lake Magadi, in East

Africa. A company has been formed with a capital of £1,300,000 to mine these deposits, which have approximately the following components:— Na_2CO_3 , 43.5; NaHCO_3 , 40.4; H_2O , 15.6; NaCl , 0.4.

Factories are being erected in England and in the East to refine the raw material and to convert it into other soda compounds. It has, however, to be remembered that the cost of an article to the consumer is largely determined by the expense of carriage, and this item, with regard especially to the natural soda, must necessarily be in most cases particularly heavy.

Another disturbing factor in the ammonia soda industry is the ever-increasing production of caustic alkali by electrolytic processes. In a very large number of industries the soda ash is only used after causticising by lime, with the consequence that, should it be possible to produce caustic soda at a sufficiently low price, very serious competition with ammonia soda would result.

As, however, it will be pointed out later, the ammonia soda process has been brought to an exceedingly high state of economic efficiency, and in spite of the various factors mentioned, it is questionable whether the commanding position which it at present holds in the alkali industry is seriously threatened.

Historical.—It is not proposed to deal in this article at any length with the historical aspect of the ammonia soda process. The reader who is interested in the subject may be referred to **Mond**, *Journ. Soc. Chem. Ind.*, 1885, p. 527. Also to a lecture given by Ernest Solvay at the **International Congress of Applied Chemistry**, Berlin, 1903. A copy of this will also be found in *La Revue de l'Université de Bruxelles*, May 1903.

In 1838 the treatment of brine with carbonate of ammonia was patented by Dyar and Hemming, and subsequently by Delaunay in 1839. In 1840 the introduction of carbon dioxide in the gaseous form was also patented by Canning. Subsequently in 1852, Crinus, a Frenchman, directs the recovery of the gas given off in the calcination of the sodium bicarbonate, whilst Chisholm in the same year patents the distillation of ammonium chloride with lime, and the subsequent absorption of the gas in brine. The application of this had been anticipated, however, by Delaunay.

Thus already, in 1852, all the chemical reactions essential to the success of the ammonia soda process were well known, and it is significant that from that time onwards all the patents taken out which had any subsequent bearing on the history of the industry related to the disposition and nature of the apparatus to be employed, and it is in this connection that the ammonia soda process is indissolubly connected with the name of Solvay. From 1861 onwards, Ernest Solvay, with the assistance of his brother Alfred, devoted his attention to the perfection of the mechanical details of the plant, and in 1863 *La Société Solvay et Cie* was formed with a capital of 136,000 francs for the erection at Couillet of a factory to produce sodium carbonate by this process. In the year 1866 the production of this factory reached one and a half tons per day.

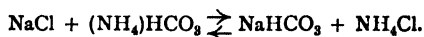
In 1872 Ernest Solvay was approached by Ludwig Mond, with the consequence that the process was also started at Northwich, in Cheshire. The factory now at Winnington, near Northwich, owned by Brunner, Mond & Co., is probably the largest in the world, producing, as it does, about 200,000 tons per annum. This company now also owns works at Lostock Gralam, Middlewich, and Sandbach, all in the Cheshire brine district, so that the total output of this firm will be in the neighbourhood of 500,000 tons per annum.

The firm of Messrs Brunner, Mond & Co. forms part of the powerful Solvay syndicate which practically controls the ammonia soda industry of the world, owning, as it does, works all over the Continent of Europe and in the United States of America. Besides the works owned by Messrs Brunner, Mond & Co., only two other ammonia soda factories exist in England, that of the United Alkali Co., at Fleetwood, in Lancashire, and that of the Ammonia Soda Co., at Lostock Gralam, in Cheshire.

In America several factories outside the combine exist, notably the Michigan Alkali Co., the Columbia Chemical Co., and the Mathieson Alkali Co.

On the Continent a new factory outside the combine, the *Adriawerke Aktiengesellschaft*, Trieste, has recently commenced operations.

Theoretical Considerations.—The fundamental reaction on which the ammonia soda process depends is of the simplest character, and may be expressed by the equation—



A consideration of the solubility of these salts in water will indicate in which direction we may expect the reaction to proceed, and in consequence which salts, if any, we may expect to be precipitated.

The following table shows the solubility of NaCl , NaHCO_3 , and NH_4Cl in water :—

SOLUBILITY OF NaCl IN WATER.

Temperature. Degrees.	Grams in 100 g.
10 - - - - -	35.69
20 - - - - -	35.82
30 * - - - - -	36.03
40 - - - - -	36.32
50 - - - - -	36.67
60 - - - - -	37.06

NaHCO ₃ in H ₂ O.		NH ₄ Cl in H ₂ O.	
Temperature. Degrees.	Grams in 100 g.	Temperature. Degrees.	Grams in 100 g.
0 - - - - -	6.9	0 - - - - -	29.7
10 - - - - -	8.2	10 - - - - -	33.3
20 - - - - -	9.6	20 - - - - -	37.2
30 - - - - -	11.1	30 - - - - -	41.4
40 - - - - -	12.7	40 - - - - -	45.8
50 - - - - -	14.5	50 - - - - -	50.4
60 - - - - -	16.4	60 - - - - -	55.2

Sodium bicarbonate (NaHCO₃) is by far the least soluble of all these salts, and it would thus be anticipated that the first salt to be precipitated would be sodium bicarbonate. The probability that such will be the case becomes still greater when one investigates the solubility of sodium bicarbonate in solutions of sodium chloride, ammonium bicarbonate, and ammonium chloride.

SOLUBILITY OF NaHCO₃ IN NaCl (Fedotieff, *loc. cit.*).

NaCl. Grams per Litre.	NaHCO ₃ . Grams per Litre
0 - - - - -	105.8
172 - - - - -	29.0
231 - - - - -	20.1
313 - - - - -	12.1
0 - - - - -	85.3
175 - - - - -	21.4
234 - - - - -	14.6
312 - - - - -	8.8

} at 30° C.
} at 15° C.

SOLUBILITY OF NaHCO₃ IN NH₄HCO₃.

NH ₄ HCO ₃ . Grams per Litre.	NaHCO ₃ . Grams per Litre.
0 - - - - -	85.3
21.1 - - - - -	77.0
79.8 - - - - -	62.1

} at 15° C.

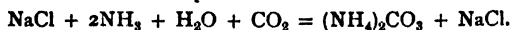
SOLUBILITY OF NaHCO₃ IN SOLUTIONS OF NH₄Cl AND NaCl (Schreib).

100 c.c. of a solution containing 18 g. of NH₄Cl dissolved before and after the addition of NaCl, gives the following quantities of NaHCO₃ :—

At 25° C.			At 40° C.		
NH ₄ Cl.	NaCl.	Na ₂ CO ₃ as NaHCO ₃ .	NH ₄ Cl.	NaCl.	Na ₂ CO ₃ as NaHCO ₃ .
0	0	6.5	0	0	8.0
18	0	6.0	18	0	7.0
18	2	5.0	18	2	6.2
18	8	2.7	18	8	3.8
18	14	1.7	18	14	2.3

Thus in each case the solubility in the saline solution is much lower than in water.

If, then, a current of carbon dioxide be passed through brine containing ammonia gas in solution, the following reaction will first of all take place :—



The effect will be the formation *in situ* of a solution of the normal carbonate of ammonia, when all the ammonia present has been converted into the normal carbonate. Further passage of carbon dioxide will result in the formation of the acid carbonate—



We shall in consequence have a system containing the ions—



The value of the solubility product $[\text{Na}^+][\text{HCO}_3^-]$ in the solution of sodium chloride is, of course, lower than in water, owing to the depression of the dissociation of the feebly ionised sodium carbonate by the strongly dissociated sodium chloride containing the common ion Na^+ , and when a certain quantity of carbon dioxide has passed, the solubility product $[\text{Na}^+][\text{HCO}_3^-]$ is exceeded, and precipitation of sodium bicarbonate results. Were the passage of carbon dioxide now stopped no further precipitation would occur. As, however, more carbon dioxide is bubbled through the solution, it is absorbed by the ammonium carbonate, giving ammonium bicarbonate. In this way the concentration of the HCO_3^- ion is renewed, and as there is a large excess of Na^+ ions present, the value of the solubility product is again exceeded, and so precipitation proceeds. Gradual depletion of the Na^+ ions from the solution, together with the fact that no more carbonate of ammonia is present, by means of which the concentration of the HCO_3^- ions may be increased, results eventually in a point being reached when the value of the solubility product $[\text{Na}^+][\text{HCO}_3^-]$ does not exceed the limiting value but is equal to it, with the consequence that equilibrium is established. Owing to the smaller value of the solubility product at a lower temperature, a reduction in the temperature of the solution at this point would, of course, lead to further precipitation. Thus for any given temperature the equilibrium will be represented by the expression :—

$$\frac{[\text{NaHCO}_3][\text{NH}_4\text{Cl}]}{[\text{NaCl}][\text{NH}_4\text{HCO}_3]} = K'.$$

These considerations indicate the conditions necessary to obtain the maximum yield of sodium bicarbonate. It is apparent that—

1. *The solution must originally contain a very high concentration of the Na^+ ions, i.e., it must be fully saturated with salt.*

2. *The solution must contain a high concentration of ammonia in order that by subsequent absorption of carbon dioxide the greatest number of HCO_3^- ions may be produced.*

3. *To decrease the value of the solubility product $[\text{Na}^+][\text{HCO}_3^-]$, the temperature of the solution must be low.*

Unfortunately, for many reasons, both chemical and industrial, it is impossible to realise the ideal conditions.

When a solution of sodium chloride is treated with ammonia gas, the concentration of the sodium chloride falls as the concentration of the ammonia increases. This is shown by the following table :—

SOLUBILITY OF SODIUM CHLORIDE IN SOLUTIONS OF AMMONIA AT 30° C.

(Hemple and Tedesco, *Zeit. angew. Chem.*, 1912, 24, 2468.)

NaCl.		NH ₃ .		Specific Gravity.
Grams per Litre.	Grams, Molecules per Litre.	Grams per Litre.	Grams, Molecules per Litre.	
293.38	5.4836	29.535	1.7374	1.1735
292.50	4.9972	40.655	2.3915	1.1656
289.70	4.9500	47.260	2.7800	1.1600
286.50	4.8950	60.780	3.5750	1.1494
283.38	4.8426	72.070	4.2390	1.1406
283.06	4.7942	72.715	4.2772	1.1395
277.49	4.7413	81.855	4.8150	1.1301
270.57	4.6123	97.490	5.7348	1.1205

Further, in practice the ammoniacal solution of salt is always to some extent diluted by water vapour carried over with the ammonia gas, and it is found impossible during the precipitation of the sodium bicarbonate to work at very low temperatures. This matter will again be referred to later.

It is thus necessary to consider what is the most suitable concentration in ammonia to which the brine should be brought, in order that the maximum yield of sodium bicarbonate may be obtained under industrial conditions. In the domain of pure chemistry the problem has been attacked from the standpoint of the phase rule by various workers.

Schreib ("Ammonia Soda," *loc. cit.*) gives the results obtained on carbonating, under the same conditions, solutions containing varying concentrations of salt and ammonia. The experiments were carried out with only approximate accuracy, but nevertheless are comparative amongst themselves.

Some of Schreib's figures are here given :—

	Original Solution.		Carbonated Solution.			Per Cent. of NaCl Converted.	Na ₂ CO ₃ as NaHCO ₃ . Grams per Litre.
	NH ₃ per Cent.	NaCl per Cent.	NH ₃ per Cent.	NaCl per Cent.	NH ₄ Cl per Cent.		
1 - -	6.3	27.4	1.2	10.9	16.4	62.5	138
2 - -	6.6	27.3	1.3	10.2	16.1	63.1	146
3 - -	7.2	27.2	1.3	9.3	17.9	67.8	154
4 - -	8.9	25.8	...	7.4	18.8	73.6	168
5 - -	11.5	24.3	1.3	7.3	18.5	73.6	145

The solutions used in practice will correspond to Nos. 3 and 4, although so high a conversion as 73.6 per cent. of the NaCl into NaHCO₃ will not usually be attained, as the carbonating operation for various reasons is never carried on to its extreme limit.

Fedotieff (*loc. cit.*) determined the solubility of the four salts in the presence of one other. He then took weighed quantities of the NaCl, NH₄HCO₃ and H₂O, and shook them in a closed vessel for several hours at 15° C. In this way the following results were obtained :—

In 1,000 g. of Water.			Solutions Containing Gram Equivalents per Litre.				Per Cent. Decomposition of NaCl.
NaCl.	NH ₄ HCO ₃ .	NH ₃ .	HCO ₃ '.	Cl'.	Na'.	NH ₄ '.	
336	336	72.4	0.3	4.74	1.78	3.46	62.5
336	377	81.3	0.64	4.65	1.47	3.82	68.5
340	416	89.6	0.77	4.67	1.25	4.19	73.4

By means of a space model and graphical extrapolation he deduced that a maximum decomposition of 83.4 per cent. of NaCl could be obtained in this way at a temperature of 30° C., and indicated that at 15°-20° C. in industrial practice a conversion of 79-80 per cent. NaCl should be possible. He further points out that theoretically it is better to treat common salt, either solid or in solution, with solid ammonium bicarbonate as in the process of Schlösing (English Patents, 21,370, 1878; 2,110, 1882; 4,025, 1885).

Janecke (*loc. cit.*) applies his graphical method of representing reciprocal pairs of salts (*Zeits. anorg. Chem.*, 1906, 51, 132-157) to the problem, and demonstrates the possibility of increasing the yield by the addition of solid NaCl whilst the solution is maintained at 32° C.

As has previously been mentioned, the concentration of salt and ammonia in the ammoniacal brine cannot be determined by purely theoretical conditions. It has already been pointed out that the concentration of the salt in the ammoniacal brine is diminished to some extent by water vapour carried over from the ammonia distiller. Again, it is found in practice more difficult to prepare solutions containing a high concentration of ammonia than those containing a low concentration.

When working with solutions containing a high concentration of ammonia the yield of sodium bicarbonate is better, and the more concentrated liquor returning to the ammonia stills requires less steam for distillation and less effluent is produced. The carbonating process is, however, much slower and there is more danger during the treatment of these strong liquors of losing ammonia.

The ammonia soda process in outline (see also p. 321) may be summarised as follows: Brine (NaCl) is saturated with ammonia gas (NH₃), and subjected to the action of a current of carbon dioxide (CO₂), produced by the burning of limestone, when the following reaction takes place :—



The bicarbonate of soda (NaHCO_3) so produced is filtered and calcined ($2\text{NaHCO}_3 = \text{Na}_2\text{CO}_3 + \text{CO}_2$); the evolved CO_2 , being used against the mother liquor containing NH_4Cl , is returned to the ammonia distiller, where, by treatment with lime and steam ($2\text{NH}_4\text{Cl} + \text{Ca}(\text{OH})_2 = \text{CaCl}_2 + 2\text{NH}_3 + 2\text{H}_2\text{O}$), the ammonia is recovered and again absorbed in fresh brine. The spent liquors (containing CaCl_2 and NaCl), after extraction of the ammonia, pass away as the effluent.

Operations on the Industrial Scale

Preparation of the Saturated Solution of Salt.—It is essential to the commercial success of the ammonia soda process that an abundant supply of sodium chloride, either as rock salt or as fully saturated brine, preferably the latter, be close at hand. Some factories are at work where the salt has to be transported to the works, but it is probable that, unless the price of soda ash in the country under consideration were not artificially maintained, they would have great difficulty in competing.

Where rock salt mines exist, as at Fleetwood in Lancashire, it is usual to flood these with water and to subsequently pump away the brine formed by the dissolution of the rock salt (see p. 263, **Salt Industry**).

The utilisation of the salt in the process is by no means complete, only 60 per cent. to 73 per cent. of the sodium chloride being converted into sodium bicarbonate, and for the production of 1 ton of soda ash it will be necessary to treat 7.8 tons of brine.

Natural brine contains impurities such as calcium and magnesium salts (see p. 265).

A typical analysis of natural brine (Cheshire) is given below :—

	Grams per Litre.				
NaCl	-	-	-	-	300.0
MgCl_2	-	-	-	-	0.6
MgSO_4	-	-	-	-	0.7
CaSO_4	-	-	-	-	4.0
CaCO_3	-	-	-	-	0.2

Formerly these impurities were removed before the brine entered the process, by treatment of the crude brine with sodium carbonate and lime. This, however, is not the usual practice at the present day, and the impurities which are precipitated during the saturation of the brine with ammonia containing carbon dioxide are removed at a later stage.

The brine, from whatever source it may be obtained, is usually pumped into large reservoirs. From these reservoirs it is again pumped to a tank at the top of the main building, so that it may gravitate from there to the washers and absorber, and subsequently to the settling vats.

Saturation of the Brine with Ammonia.—Several different forms of ammonia absorber have been used from time to time. They all depend for their construction on the simple principle of allowing the gas from the ammonia distiller to meet a stream of brine after the manner of counter-currents.

A typical absorber is shown in Fig. 1. The brine flows downwards, through the various compartments, whilst the ammonia gas by means of the serrated mushrooms is caused to bubble through the liquor in each compartment. This type of apparatus is very widely used in the industry for numerous operations.

The "tower" washer, Fig. 2, is of similar construction, but larger. It is used for recovering the ammonia carried away by the gas current from the carbonating plant. A portion of the brine which enters the absorber will first pass through this column.

The gases entering the ammonia absorber consist of ammonia, carbon dioxide (resulting from the decomposition of the sodium and ammonium bicarbonates present in the mother liquor), and water vapour, together with small quantities of air which

have been previously present in the liquors, or in the water from which the steam necessary for distillation was generated. In addition a certain amount of sulphuretted hydrogen will be present, due to the use of crude gas liquor, to make up for any losses in ammonia that occur.

The ammonium sulphide thus formed reacts with the iron of the vessel to produce a thin coating of sulphide of iron; this prevents the dissolution of the metal by the liquors which otherwise would result in a discoloration of the finished product.

During the distillation of **1 metric ton** of ammonia there will enter the absorber at a temperature of 60°C ., in addition to the 1 ton of ammonia, 720 kilos of CO_2 , 380 kilos of H_2O .

The absorption of the ammonia by brine, of the carbon dioxide by the ammoniacal brine, and the condensation of the water vapour, results in the evolution of large quantities of heat, with the consequence that the total amount of heat evolved will be approximately 900,000 kilo calories per metric ton of ammonia distilled. This will be sufficient to raise the 12,500 kg. of liquor in which the ammonia will dissolve by about 72°C .

It is essential that the temperature of the liquor in the absorber should be maintained as low as

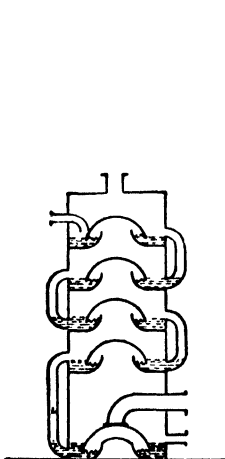


FIG. 1.—Ammonia Absorber.

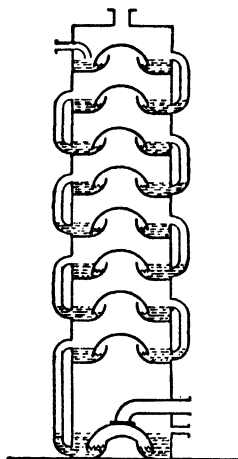


FIG. 2.—Ammonia Recovery Tower.

possible, in order to keep down the partial pressure of the ammonia in the liquor, and thus assist absorption. This is especially necessary when, as is now the case, the absorber is worked under a vacuum. Further, at a high temperature the ammonium carbonate is decomposed, and a loss of carbon dioxide will result.

Unfortunately any cooling pipes inserted inside the vessel so soon become coated over with a heat insulating scale of calcium and magnesium carbonates as to render them almost inoperative. They must in consequence either be very frequently cleaned, or some other method must be adopted of keeping the temperatures down. It will suffice here to say that the temperature is so regulated as not to exceed 60°C .

The gas leaving the absorber will still contain a fair quantity of ammonia. It is in consequence passed through another tower, where it can again be submitted to the action of fresh brine. Finally it may, if necessary, be passed through another washer containing water in order that the last traces of ammonia may be removed. This final washer is in direct connection with an air pump, which maintains a vacuum through the washers and absorber to the ammonia still.

Part of the fresh brine entering the process passes first of all through the carbonating or tower washer, where any ammonia mechanically carried over by the gas current from the precipitating apparatus is recovered. It then joins the brine, leaving the absorber washer before entering the absorber itself.

It may here be pointed out that ammonia gas is absorbed by brine with great avidity. Thus in an experimental plant the author found that by bubbling 2,000 kilos per hour of NH_3 gas over a surface of 3 sq. m. through 6 in. of brine already containing 40 g. per litre of NH_3 , 1,000 kilos per hour were absorbed when the temperature was maintained even as high as 70°C ., and the resulting liquor contained 80 g. per litre of NH_3 .

The liquor leaving the absorber will have approximately the following composition:— NaCl , 260 g. per litre; NH_3 , 80 g. per litre; CO_2 , 45 g. per litre. It will contain in suspension as carbonates all the calcium and most of the magnesium salts originally present in the brine. In order to clarify this liquor, it flows by gravity to the bottom of a large tank, and is allowed to overflow from the top of this vessel to the bottom of another, and so on, until eventually the liquor arrives at the final tank perfectly free from all suspended matter.

Several hundred tons of liquor may thus be kept continuously settling. In this way not only is the clarification of the liquor accomplished, but the liquor leaving the last vessel is maintained at a constant strength, and the effect due to any irregularities in the working of the absorber is

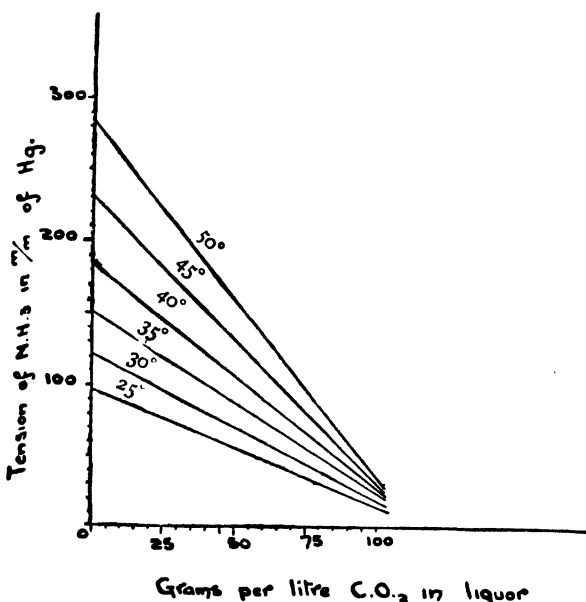


FIG. 3.—Influence of Temperature and CO_2 content on tension of NH_3 in Solutions of Ammoniacal Brine.

minimised. The mud separating out in the settling vats may be kept in a state of suspension by an agitator, and passed to another vessel, where it is washed with brine or water; alternately it may be pumped direct to the ammonia stills in order that the ammonia present may be recovered.

Carbonating Apparatus.—The clear ammoniacal brine leaving the last settling or storage tank must be cooled down before it is subjected to the action of the carbon dioxide. Otherwise a large quantity of ammonia will be carried away by the gas current to the carbonator washer.

It is interesting here to note that the amount of ammonia thus removed from solution is dependent not only on the temperature, but also on the content of carbon dioxide in the liquor, for as the concentration of carbon dioxide in the liquor increases, so the tension of the ammonia in solution decreases, with the consequence that the higher is the concentration of carbon dioxide in the ammoniacal brine entering the carbonating apparatus, the smaller will be the quantity of ammonia carried away by the gas current. The influence of temperature and of the carbon dioxide content in the tension of ammonia in solutions of ammoniacal brine as determined by the author is shown in Fig. 3.

The curves refer to a solution containing 80 g. per litre of ammonia, and 270 g. per litre of sodium chloride.

In order to cool the ammoniacal brine it is pumped through a cooler of the evaporative type, whereby the liquor passes through a number of cast-iron pipes over which cold water is running.

Owing to the fact that the insoluble magnesium salts do not readily separate from solutions of ammoniacal brine, a portion of the magnesium salts present is precipitated on the interior of these cooling pipes as an intensely hard scale. The composition of this scale varies somewhat. It was found by Reinitzer, *Zeits. angew. Chem.*, 1893, 446, to consist of $MgCO_3 \cdot NaCl$.

The effect of this scale formation is to rapidly diminish the cooling effect of the apparatus, and in consequence the pipes must periodically be steamed out, and the scale removed.

The ammoniacal brine, cooled to about $30^\circ C.$, is now ready to enter the carbonating apparatus. Various forms of carbonators have been devised, but it will be sufficient here to describe the apparatus used by Solvay and that introduced by Honigmann, D.R.P., 13,782.

Amongst other types of carbonating plant that have been used may be mentioned that introduced by Boulouvard, French Patent, 125,625, 1878, and by Schreib, D.R.P., 70,169.

In the Solvay apparatus (Fig. 4) the liquor is pumped to the top of a high tower, where it falls over a series of baffle plates and meets, after the manner of counter-currents, a stream of carbon dioxide gas rising upwards. The absorption of the carbon dioxide by the ammoniacal brine results in the evolution of considerable quantities of heat, and in order to keep down the temperature of the liquor the lower portion of the tower is fitted with the well-known Cogswes coolers (English Patent, 1,973, 1887), which consist of a number of mild steel tubes expanded into a steel tube plate. The liquor as it reaches the bottom of the tower falls over these tubes through which cold water is running. The Solvay tower may be from 70-90 ft. high, and from 5-7 ft. in diameter.

It is the usual practice now to conduct the carbonating operation in two stages. In the first tower the absorption of the carbon dioxide is allowed to proceed up to the point when most of the ammonia present, but not all, has been converted into the normal carbonate. From the bottom of this tower the liquor may be blown into a storage tank, and thence pumped to the top of the second tower, known as the precipitating or making tower. Here further absorption of carbon dioxide goes on, and the sodium bicarbonate is precipitated. It is necessary to regulate with great care the temperature of the liquor during this operation. If the temperature is kept too high the sodium bicarbonate is of very coarse grain, and although well suited for the Thelen pans, it may not filter so well nor be so easily washed as material of a finer grain. At the same time the yield is, of course, considerably decreased, not only owing to the greater solubility of the salt at the higher temperature, but also owing to the increased partial pressure of the carbon dioxide in solution, and the consequent decreased efficiency with which the carbon dioxide is absorbed. It must be remembered that only so long as the partial pressure of the carbon dioxide in the gas exceeds the partial pressure of the carbon dioxide in the liquor can absorption proceed.

Should the temperature of the liquor be brought too low, the resulting sodium bicarbonate is of a pasty consistency. It is almost impossible to filter or wash the material, and on calcining in the Thelen pans it is discharged in the form of small balls, the outside of which is the normal carbonate, whilst the interior is a core of the bicarbonate of sodium.

The magma of bicarbonate of soda and ammoniacal liquor is blown by the gas pressure from the precipitating tower to the filtering plant. The temperature of the liquor leaving the carbonating tower will be about $30^\circ C.$ or less. It may, however, be mentioned here that it is not so much the final temperature of the liquor which affects the grain of the bicarbonate of soda, as the conditions existing in the tower before that temperature is reached.

Obstructions in the form of hard crusts of sodium bicarbonate gradually form in the precipitating tower, with the consequence that at intervals the towers must

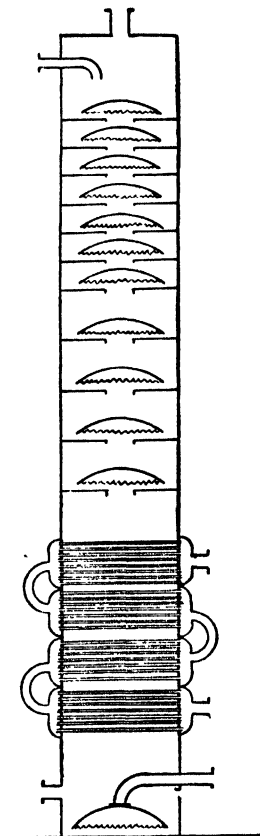


FIG. 4.—Solvay Tower.

either be changed over so that the fresh ammoniacal brine is pumped through the precipitating tower in order to dissolve these crusts, or the tower may be treated with steam and the dissolution of the crusts effected in this way.

The liquor leaving the first Solvay tower may contain up to 90 g. per litre of carbon dioxide, whilst the liquor entering the filter will have been carbonated to such an extent that it contains about 20 g. per litre of free ammonia.

The Honigmann apparatus (shown in Fig. 5) consists of three or more conical vessels fitted with cooling pipes, which are filled with ammoniacal brine, and through which the carbon dioxide is pumped in series. The gas pipes and valves on these vessels are so arranged that the gas may travel after the manner of the counter-currents, *i.e.*, the strongest gas passes first through the vessel containing liquor weakest in free ammonia, whilst the almost spent gas travels through the liquor strongest in free ammonia.

At intervals, when precipitation of the sodium bicarbonate is complete, the contents of one of the Honigmann carbonators is blown to the filter, after which the vessel is refilled with ammoniacal brine and the process repeated.

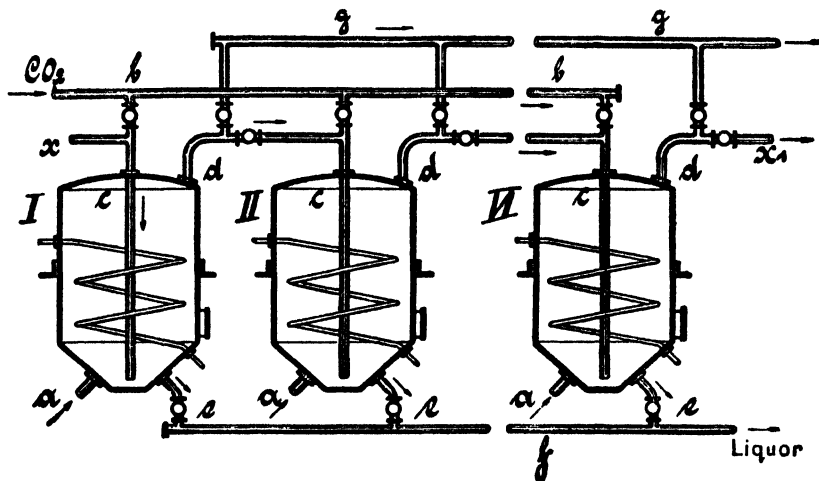


FIG. 5.—Honigmann's Carbonating Apparatus.

According to the size of the vessels the amount of bicarbonate of soda produced in one operation will vary from 8-12 tons. The time necessary for the production of this quantity depends, of course, on the concentration of carbon dioxide in the gas, together with the rate at which it is pumped through and absorbed. For the most part in practice the time occupied in carbonating the contents of one of the Honigmann vessels will be from six to nine hours.

The chief advantage claimed for the Honigmann apparatus is that the vessel does not become crusted up with bicarbonate of soda as is the case with the Solvay tower. Further, the resistance presented to the passage of the gas from the compressing engines is less, and in consequence a saving in fuel is effected.

The Honigmann apparatus, however, introduces an intermittently working plant into the middle of a process otherwise continuous; moreover, the system of counter-currents produced by the Honigmann apparatus is by no means so perfect as that produced by the Solvay tower, with the consequence that the absorption efficiency is not so great.

Thus with the Honigmann apparatus 80-90 per cent. of the total carbon dioxide passed through will be absorbed, whilst with Solvay towers the absorption efficiency may rise as high as 90-95 per cent.

When working with the Honigmann apparatus one vessel will always be discharging its contents to the filter whilst another is being filled, so that through these two vessels the carbon dioxide will

only be passing through a small head of liquor, and the absorption of carbon dioxide absorbed will not be so efficient as would otherwise be the case. During the period elapsing between the emptying of one carbonator and the filling of another the vessel will be completely empty, and absorption of carbon dioxide will then only be proceeding in the other two vessels. These defects do not appear in the Solvay tower, since with normal working the tower is always full of liquor.

On the content of carbon dioxide in the gas entering the carbonating plant the success of the whole process largely depends. The progress of the absorption of the carbon dioxide by the liquor is represented by the curves shown in Fig. 6.

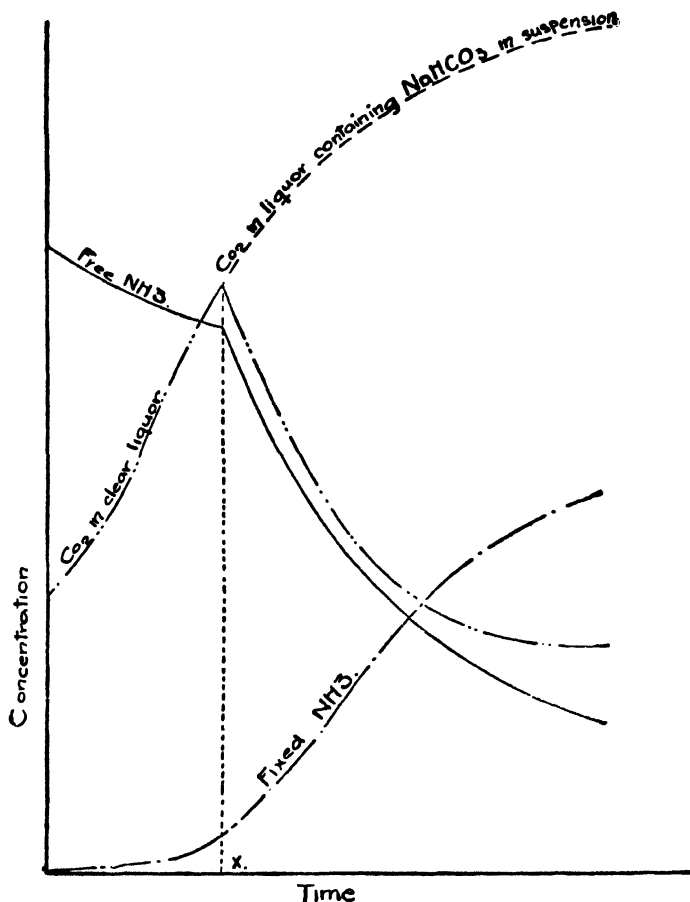
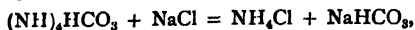


FIG. 6.—Absorption of CO₂ by Ammoniacal Brine.

It will be seen that the concentration of the carbon dioxide in the clear liquor continuously increases to the point *x*, when, owing to the separation of sodium bicarbonate at this time, a sudden fall occurs. The free ammonia content of the liquor falls slowly up to the point *x* owing to the removal of ammonia in the gas current, whilst after the point *x* the progress of the action,



is seen by a rapid fall of the free ammonia content, and a subsequent increase in the content of fixed NH₃. At the time *x* the whole of the ammonia in the ammoniacal brine has been converted into the normal carbonate, and as has already been mentioned, where Solvay towers are used this part of the operation would be conducted in the semi-carbonating tower, whilst the finishing process from *x* onwards would be conducted in the "making" or "finishing" tower. A glance at the

curve shows that the preliminary carbonating process represents about one-third of the whole operation.

The design of the Solvay towers and Honigmann carbonators is based on a consideration of the work which must be done in order to absorb unit weight of carbon dioxide in ammoniacal brine of suitable concentration.

Thus in the case of the Solvay tower, the higher the column of liquor through which the gas has to pass, the more perfect will be the absorption, but, at the same time, the greater will be the work which must be done by the compressing engines to effect that absorption. Experiments carried out by the author show, as would be expected, that there is a certain point of maximum efficiency when a compressor of given capacity is under consideration.

If the work required to absorb unit weight of carbon dioxide is plotted against the height of liquor in the tower, all other conditions being constant, then a curve showing a minimum value is obtained.

The liquor blown by the gas pressure from the Solvay tower or from one of the Honigmann vessels has now to be filtered. The filtering plant originally consisted of a round or rectangular vessel provided with a false bottom, over which sacking or other similar material would be stretched. The magma of bicarbonate of soda and liquor was introduced into the vessel, when the liquor

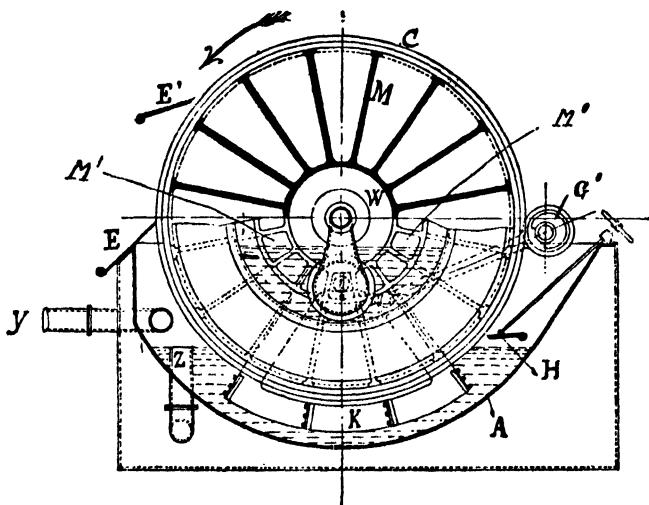


FIG. 7.—Mechanical Bicarbonate of Soda Filter—Revolving Cylinder Type.

would pass through the false bottom, leaving the bicarbonate of soda to be subsequently washed with water. The filtering action would be assisted by a pump which, besides drawing off the liquor, maintained a vacuum under the cloth. The bicarbonate of soda was subsequently dug out, and in some cases it would be further dried in a hydro-extractor.

These old static filters are now quite obsolete. They have been replaced in all modern works by mechanical filters which consist of a rotating perforated drum or cylinder covered with flannel, inside of which a vacuum is maintained. The drum or cylinder is partially immersed in a trough containing the magma of bicarbonate of soda and liquor. By means of the pressure of the atmosphere the liquor is forced through the cloth, leaving on it a layer of the substance in suspension. As the drum or cylinder revolves the layer of bicarbonate of soda is washed with water, and subsequently scraped off by a knife. See Figs. 7 and 8.

When working with a mechanical filter, as described above, it was found that after a short time the pores of the filter cloth became clogged, and thus impeded the filtering process, with the consequence that from time to time the apparatus had to be stopped and the cloth washed. In order to avoid this trouble the filters are now divided into compartments, a vacuum being maintained in each

compartment, except the one which has just passed the knife and is about to enter the liquor. Into this compartment, by means of a mechanical device, a pressure of air or liquor is introduced. In this way the cloth is cleaned before it enters the liquor, with the consequence that the efficiency of the filter is maintained at a maximum.

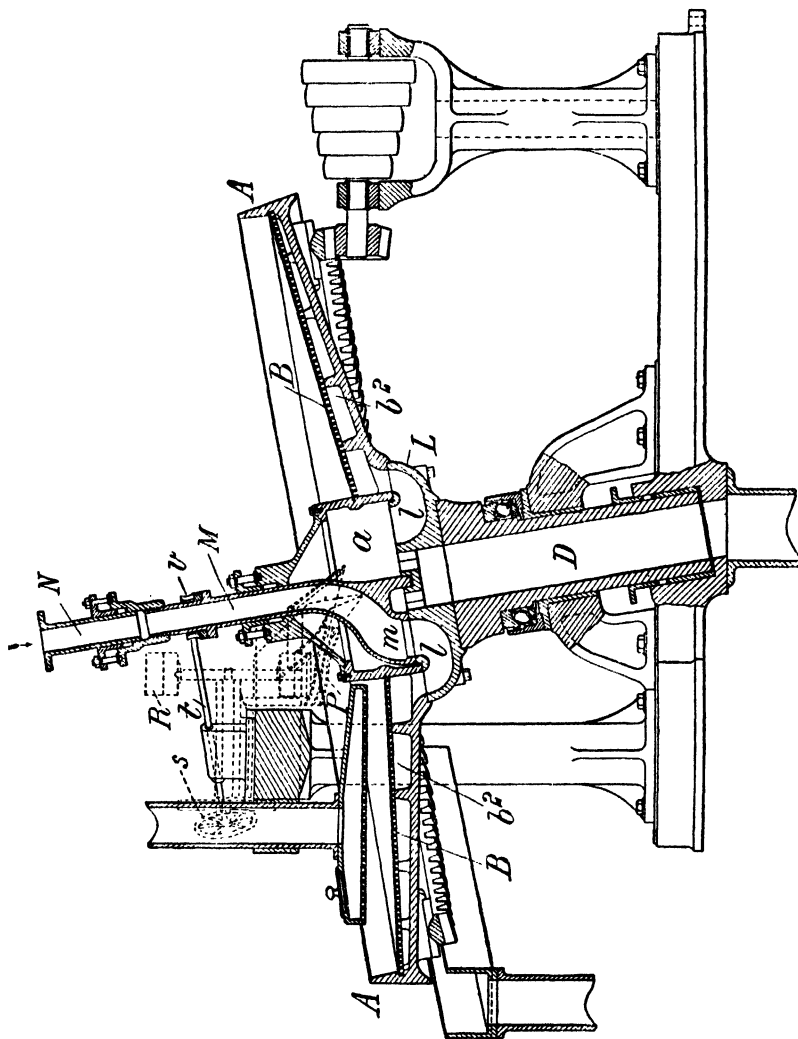


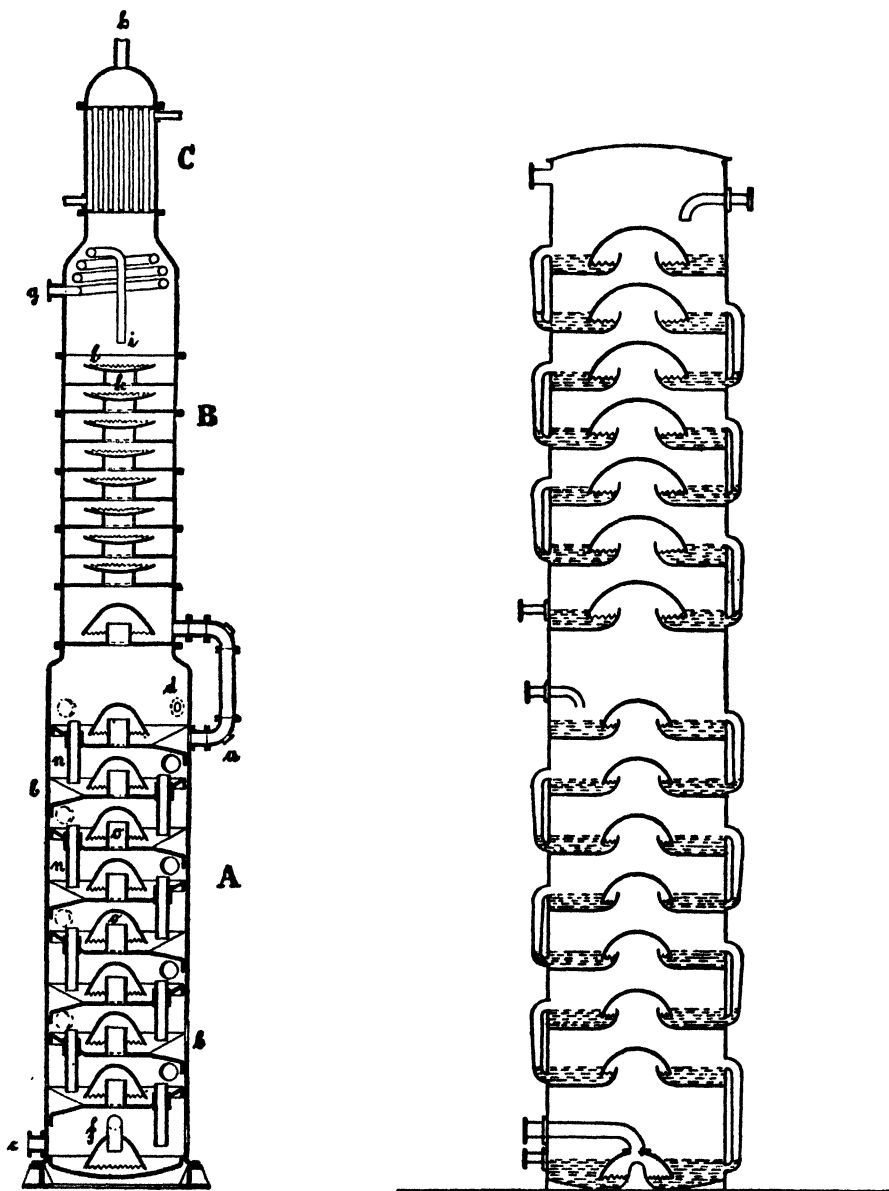
FIG. 8.—Mechanical Bicarbonate of Soda Filter—Rotating Drum Type.

These filters, which are described in English Patent 4,725, 1896, Solvay et Cie, also English Patent 23,791, 1903, Houghton and United Alkali Co., are shown in Figs. 7 and 8 respectively. Fig. 7 shows a filter of the revolving cylinder type, whilst Fig. 8 shows a filter of the rotating drum type.

The bicarbonate of soda leaving the filter will have the following composition :—

NaHCO ₃	84	per cent.
H ₂ O	15	"
NaCl	0.3	"
NH ₃	0.7	"

The mother liquor is diluted to an extent of about 10 per cent. by the wash water, and by dissolution in this water a small quantity of the bicarbonate of soda is carried into the mother liquor. This liquor now contains nearly the whole of the

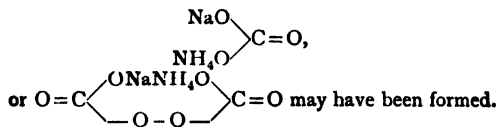


Figs. 9 and 10.—Ammonia Distillers.

ammonia originally present in the ammoniacal brine. About 8 per cent. has been mechanically carried away by the passage of the gas, and will have been recovered by means of brine in the carbonator washer, and thence returned to the absorber.

A small quantity is contained in the bicarbonate of soda.

It appears quite impossible to remove by washing with water the last traces of ammonia present in the bicarbonate of soda. Whether the ammonium compound is present in the form of a solid solution, or has been absorbed by the sodium bicarbonate, it is difficult to say. Further, it is impossible to tell by analytical methods in what state of combination the ammonia is present. Probably a portion is present as ammonium bicarbonate, although it is possible that some compound such as a double or complex carbonate of sodium and ammonium as—



Distillation of the Ammoniacal Liquors

The mother liquor has now to be treated with steam and lime in order that the ammonia contained therein may be expelled and again absorbed in brine.

The ammonia distilling plant is perhaps the most important part of an ammonia soda factory, as it represents the connecting link between one cycle of operations and another.

The method of distilling the ammoniacal liquor consists in submitting it first to the action of steam when the free ammonia present, chiefly as the acid carbonate, is expelled. Here also any sodium bicarbonate present in the liquor reacts with the ammonium chloride thus:—



After the removal of the free ammonia the liquor is treated with milk of lime, and again subjected as before to a current of steam.

Two types of distilling apparatus are shown in Figs. 9 and 10.

The principle involved in all ammonia distillers is the same, although the construction of the apparatus varies somewhat in detail.

The liquor is pumped first of all into the top portion of the distiller known as the heater. A current of steam rising upwards expels the free ammonia. The liquor leaving the heater may now pass into the first compartment of that portion of the apparatus where the fixed ammonia is to be expelled. From here, after treatment with milk of lime, it flows downwards through the various compartments whilst the steam is bubbling through it, carrying away the ammonia gas. Thus as the liquor falls down the distiller, it becomes weaker and weaker in ammonia, until finally, on arriving at the last compartment when the whole of the ammonia has been driven off, the spent liquor is blown away by the steam pressure as the effluent.

In some cases the liquor leaving the heater may be treated with milk of lime in a special vessel. From this vessel it may either be blown or pumped back to the distiller, or alternatively the mixer may be placed at such a level that the liquor flows in and out by gravity.

The principles to be considered in the distillation of ammoniacal liquors are as follows:—

1. A system of counter-currents must be employed with regard to the transference of heat, in order that the efficiency of the heat exchange between steam and liquor may be a maximum. This it will be seen is more or less accomplished. The fresh steam comes into contact with the hottest liquor, whilst the exhausted steam at the top of the heater comes into contact with the coldest liquor.

2. A system of counter-currents must be maintained with regard to the concentration of the ammonia in the vapour and in liquid phases, or rather with regard to the tension of the ammonia in the vapour and liquid phases. By this, of course, it is meant that the fresh steam must come into contact with the liquor weakest in ammonia, whilst the exhausted steam must come into contact with liquors containing a high concentration of ammonia. This system of counter-currents here outlined is unfortunately not perfect, since, as will be shown later, it is impossible to produce a system of counter-currents perfect both as regards heat transference and ammonia expulsion.

The determining factor in the transference of the ammonia from the liquid to the gaseous phase will be the difference between the partial pressure of the ammonia in the liquor and vapour

respectively. Thus the ideal system for ammonia distillation would be a system where the tension of ammonia in the vapour increases as the tension of ammonia in the liquor increases. It may be represented as in Fig. 11.

The curves show that here, as we pass up the apparatus, the tension of the ammonia in the liquor and in the vapour steadily rise and converge until finally on leaving the apparatus they coincide alternatively; it may be said that the difference between the tension of ammonia in the gas and in the liquor increases from zero and then decreases again to that value. The velocity with which the ammonia is being expelled at any point will be proportional to the difference in the two partial pressures. Thus for example at the point x in the apparatus it would be proportional to the distance $A B$.

The actual conditions existing in a distiller deviate from the ideal conditions, owing to the fact that the tension of NH_3 in the liquor is at a maximum in the middle and not at the top of the column. This feature is shown in Fig. 12.

The point x indicates that compartment of the distiller where the lime is introduced. It will

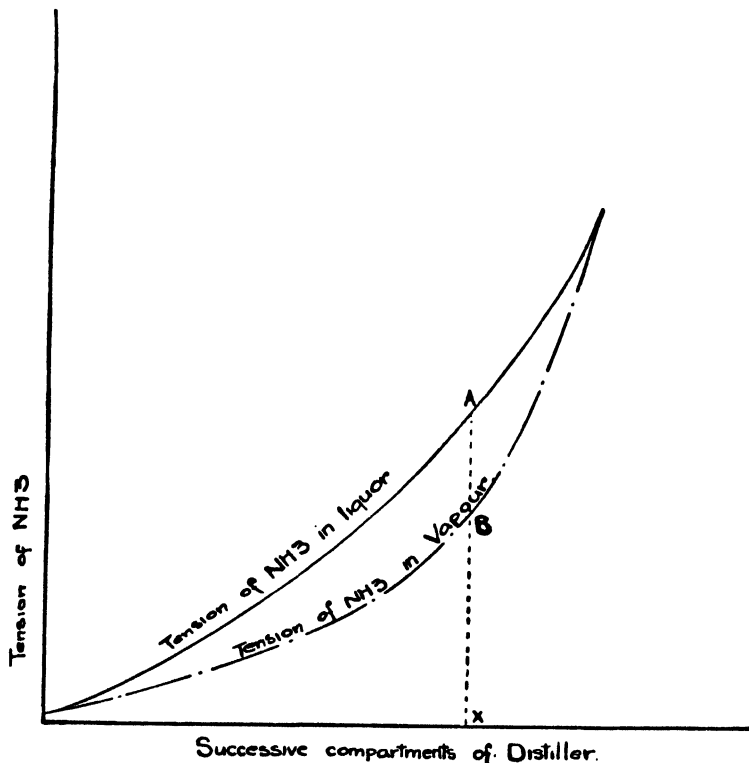


FIG. 11.—Ideal Conditions for Ammonia Distillation.

be observed that a very rapid increase in the tension of ammonia both in the liquor and vapour takes place at this point.

It is, of course, obvious that only so long as the partial pressure of the ammonia in the liquor exceeds the partial pressure of the ammonia in the vapour will the gas be expelled from solution. Since the tension of the ammonia in the liquor increases rapidly with rise in temperature, it may so happen that at the top of the heater where the coldest liquor is being introduced, the conditions will be reversed, *i.e.*, the tension of ammonia in the vapour exceeds the tension in the liquor, with the consequence that the concentration of the gas in the liquor will increase by the ammonia going into solution. These conditions are shown in Fig. 13. Thus at the point y the ammonia previously expelled starts to dissolve again.

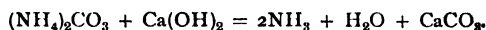
The tension of ammonia in the vapour after the point y will tend to decrease owing to the removal of ammonia from the vapour to the liquor, but at the same time the condensation of water vapour will lead to an increase in the tension of ammonia in the vapour, with the consequence that a break in the curve occurs at this point.

This condition of affairs is by no means hypothetical. In fact with an inefficient heater it may so happen that no free ammonia at all is evolved in this part of the apparatus; in fact it is quite

possible, under very adverse conditions, which, however, sometimes exist, that the liquor leaving the heater contains a higher concentration of ammonia than when it entered.

The dotted line in Fig. 13 shows how this might result. It will be observed that in this case the tension of the ammonia in the liquor never in the heater exceeds the tension of ammonia in the vapour.

Under these conditions, which are of course exceedingly objectionable, it will usually be found that the liquor leaving the heater contains a large quantity of carbon dioxide present as ammonium carbonate, with the result that the milk of lime combines with the carbon dioxide to give calcium carbonate—



Hence not only carbon dioxide but also lime is wasted, since the reaction—

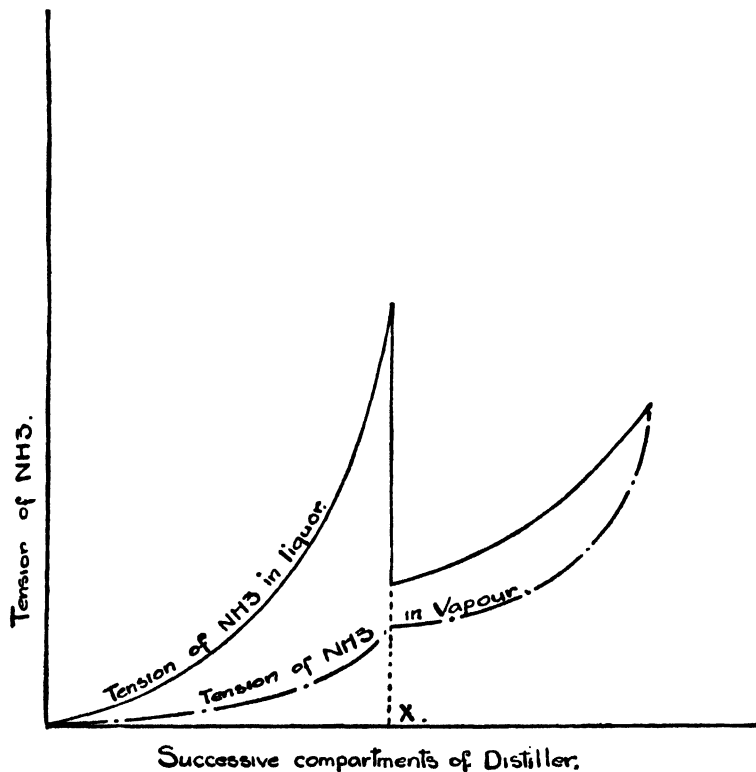


FIG. 12.—Tension of NH₃ in Liquor during Process of Distillation.

only proceeds very slowly in the still and the greater part of the calcium carbonate will pass away as such.

The distillation of ammonia in the upper portions of the still proceeds with great rapidity, but the final expulsion of the lost traces of ammonia is only accomplished with difficulty.

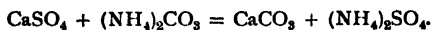
In order that there may be no loss of ammonia in the effluent, it is necessary to work with a small excess of lime in the distiller. This excess must, of course, be kept as low as possible, and with an efficient plant skilfully handled will vary from 3.5 g. per litre.

It will be apparent from a consideration of the factors previously outlined, on which the distillation of the ammoniacal liquor depends, that it will be especially advantageous to work the distiller under a vacuum, since in this way the partial pressure of the ammonia in the vapour is decreased, and the tendency for the gas to be expelled from solution is, of course, much greater. All modern distillers are now worked under a vacuum which extends through the absorber and washing towers. Care has to be taken in working the apparatus under a vacuum that the various compartments in the distiller do not become gas locked, otherwise the liquor will "hold up" in the

heater, and thereby cause great irregularities in the working of the entire plant. With a distiller suitably designed and worked under the correct conditions, this gas locking trouble, however, does not occur.

The construction of ammonia distillers has been continuously improved and their capacity increased until at the present day one unit will distil sufficient liquor to produce from 1,000 to 2,000 tons of ash per week, working with absolute regularity for twelve months, when supplied continuously with steam, liquor, and milk of lime. A certain quantity of scale slowly forms in the distiller; it consists for the most part of calcium sulphate and Na_2SO_4 which has been produced by the following reactions from the calcium sulphate originally present in the brine.

In the absorber—



In the distiller—

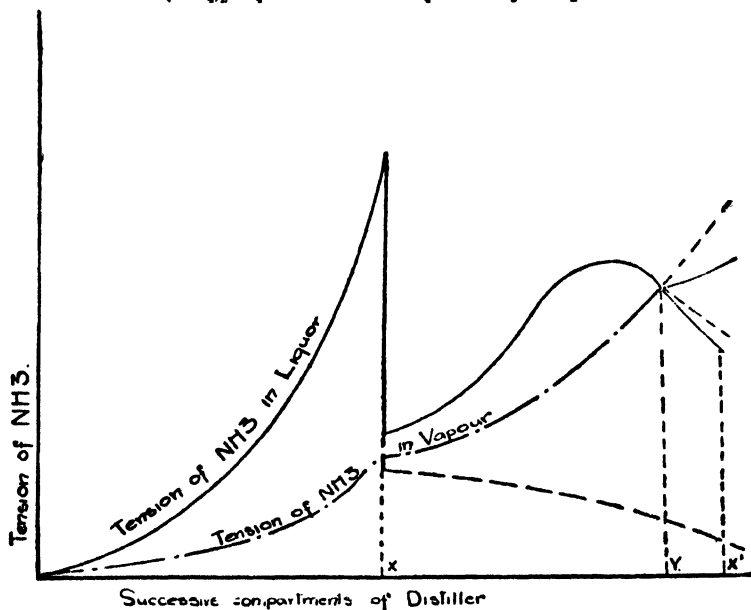
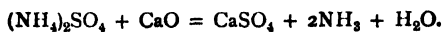


FIG. 13.—Tension of NH_3 in Liquor during Process of Distillation, showing Absorption of NH_3 previously expelled.

A sample of this scale examined by the author had the composition:—

CaSO_4	-	-	-	-	76.83	per cent.
CaCO_3	-	-	-	-	6.35	"
Na_2SO_4	-	-	-	-	3.76	"
MgSO_4	-	-	-	-	0.04	"
NaCl	-	-	-	-	0.48	"
H_2O (difference)	-	-	-	-	13.54	"

The steam used for driving off the ammonia in the distillers is supplied by the exhaust of the compressing and other engines in the plant. The valves on these engines will be set in such a way that expansion in the cylinder takes place down to the back pressure of the ammonia stills. In order that the steam consumption may be kept low, it is apparent that this back pressure must be reduced as far as possible. This is, of course, in part effected by working the distiller under a vacuum. The total quantity of heat that must be supplied to a distiller depends on a very large number of factors, so that it can hardly be here attempted to consider the question in detail. It will be sufficient to state that in practice it will approximate to 3,000,000 kilo calories per ton of ash produced.

In the design of a factory it is an important matter to decide as to how many of the engines will be made condensing and how many non-condensing in order that the requisite quantity of steam may be admitted to the ammonia distiller.

The economy obtained by exhaust steam is evident, the engines merely acting as reducing valves. Of the total heat supplied to the engine, 97 per cent. will pass away in the exhaust.

The utilisation of high pressure and superheated steam for the purpose of ammonia distillation has often been suggested. The fact is frequently lost sight of, however, that the effect of the superheat will be almost entirely removed in the bottom compartment of the distiller. The final result being that rather less effluent will be produced owing to the evaporation of a certain quantity of liquor in the bottom compartment. Further, it will already have been observed that the important factor in expelling the ammonia from solution is not so much the intensity of the temperature of the steam as the volume occupied by it, since each bubble rising through the apparatus has a tendency to become saturated with ammonia gas.

The gases leaving the distiller are maintained at a temperature of 75° - 85° C, and will in consequence be saturated with water vapour at this temperature. In order that the brine in the absorber may not be unduly diluted or heated by the condensation of the water vapour, the temperature of these gases is reduced to about 57° - 60° C. by passing through a cooler which may be of the evaporative or multitubular type.

The liquor condensing in these coolers is a strong solution of ammonia containing more or less carbon dioxide. It is run back to some portion of the heater, preferably the upper compartments, in order that the system of counter-currents may be maintained.

The gas, after being cooled, passes to the absorber, when the cycle of operations is once more commenced.

It is essential that the pipes carrying the ammonia gas be of ample dimensions in order that very little frictional resistance be offered to the passage of the gas current.

The Lime-Kilns.—The function performed by the lime-kilns in the ammonia soda process is two-fold. They supply not only most of the gas necessary for the carbonating operation, but also the lime for decomposing the ammonium chloride. Owing to the necessity for recovering the gas, the limestone is calcined directly with coke in closed kilns. The suitably proportioned mixture is introduced into the top of the kiln, where it is heated by the issuing gases. It then passes through the zone of combustion where the change



takes place.

The hot lime, as it passes further down the kiln, is cooled by the air entering and is finally discharged, either by mechanical means or by hand, into waggons.

It will be seen that an efficient kiln is perfectly regenerative in action, the whole of the heat being conserved.

Fig. 14 shows one type of kiln in use.

The lime may be delivered into a vessel provided with a perforated false bottom provided with agitating gear (shown in Fig. 15); here it is slacked by hot water. The milk of lime containing 250 g. per litre CaO is run off and sieved, when after passing through storage tanks it is delivered to the ammonia stills.

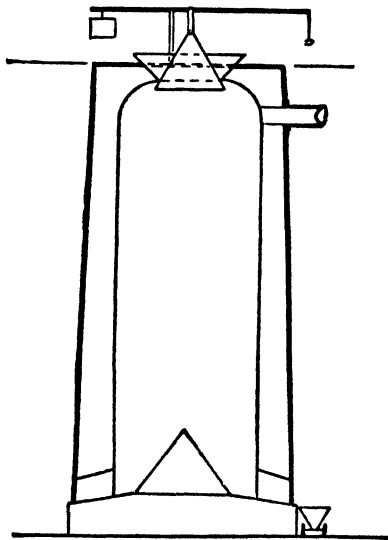


FIG. 14.—Lime-Kiln.

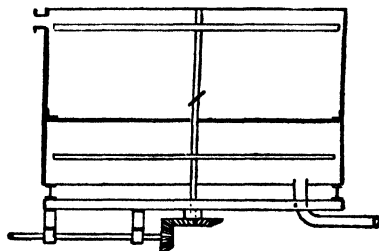


FIG. 15.—Lime Slacker.

These intermittent lime slackers have in some work given way to a continuous form of apparatus.

The **gas** evolved by the lime-kilns is drawn by the compressing engine through scrubbers which consist of towers, where the gas is either caused to bubble through layers of water, or it is exposed to the action of a current of water flowing over some suitable packing material, such as coke, limestone, blue bricks, etc. After passing through the scrubbers it is mixed with the gas given off during the decomposition of the bicarbonate of soda, and delivered by the compressors to the carbonating plant.

Calcination of the Bicarbonate of Soda.—Having now described the cycle of operations which has led to the formation of sodium bicarbonate, and

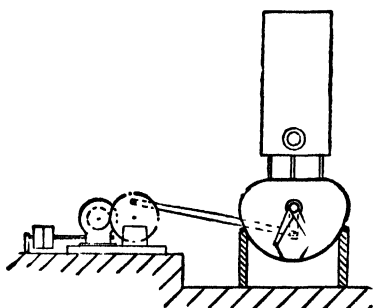
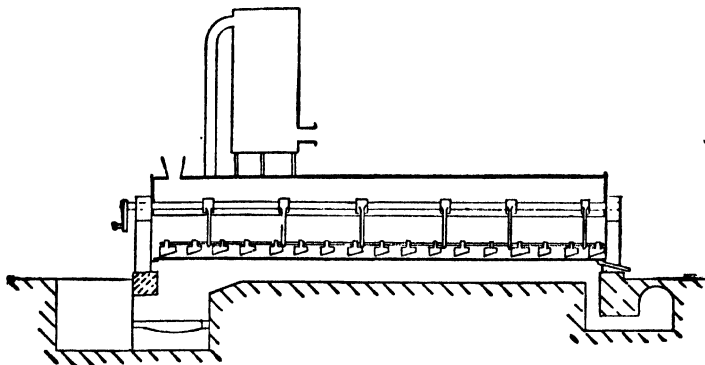


FIG. 16.—Thelen Pan.

subsequently to the recovery of ammonia from the mother liquors, we may now proceed to the final stage of the operation—the conversion of the bicarbonate of soda into the normal carbonate. The decomposition is effected in one or two operations, and may be carried out in mechanical or static furnaces.

When the operation is carried out in two stages the bicarbonate of soda is first calcined to the point when most of the moisture and the whole of the ammonia has been evolved. It is then passed to the Thelen pans where the decomposition is completed.

The final calcining operation may also be carried out in a revolving furnace, such as that described in United States, America, Patent 386,664, 1888, which is 60 ft. long, 5 ft. diameter, and is heated externally by gas.

The most usual form of calcining furnace is that known as the **Thelen pan**, which is shown in Fig. 16.

It consists of a number of cast-iron semicircular plates about 2 in. thick, 6-10 ft. in diameter, and 7-8 ft. long. A number of these pans are bolted together by means of flanges, so that the total length of the furnace may be from 30-50 ft.

The pans are heated externally by means of gas, or coal. The flue gases traverse the length of the furnace and pass away by means of a downtake.

The moist or partially dried bicarbonate of soda is fed by a mechanical device into the furnace in such a way that no gas can escape. The material inside the furnace is carried backwards and forwards by a number of scrapers so inclined as at the same time to push the material forward. These scrapers are attached by means of arms to a rotating shaft which makes a semicircular movement. In this way the substance is pushed slowly over the pans towards the end of the furnace and is eventually discharged at a temperature of about 160° C. The discharge of the material is conducted in such a manner as to prevent the entrance of air or the escape of gas.

The mechanical gear on these furnaces will, according to the size of the apparatus, absorb from 10-20 H.P.

The following figures, taken by the author, show the progress of the calcining operation as conducted in a Thelen pan, the samples being taken every six minutes. The bicarbonate of soda was a special sample arranged to contain as near as possible 20 per cent. of moisture.

Na ₂ CO ₃ per Cent.	NaHCO ₃ per Cent.	NaCl per Cent.	NH ₃ per Cent.	H ₂ O per Cent.
<i>Nil.</i>	79.0	0.57	0.75	19.68
33.08	56.0	1.0	0.12	9.8
35.84	54	1.07	0.09	9.0
88.27	9.0	1.0	0.03	1.7
88.5	9.0	1.0	<i>Nil.</i>	1.5
99.0	<i>Nil.</i>	1.0	<i>Nil.</i>	<i>Nil.</i>

The mixture of steam, ammonia, and carbon dioxide leaving the furnace is drawn first of all through a multitubular condenser. Here the steam is condensed, giving a solution, the composition of which will vary within small limits according to the content in ammonia and moisture of the material which is being calcined. It will contain, however, about 25 g. per litre of ammonia and 42 g. per litre of CO₂, and is thus a mixture of the normal and acid carbonate of ammonia. After leaving the condenser the gas may be passed through a brine or water scrubber, where the last traces of ammonia will be recovered. Finally after mixing with the furnace gas it passes to the compressors.

Although it has been shown by **Gautier** (*Ber. Deutsch. Chem. Ges.*, 9, 1434, 1876) that complete decomposition of sodium bicarbonate takes place readily at 100°-110° C., yet in practice in order to increase the velocity of the action much higher temperatures are used, and in the hottest part of the furnace under the Thelen pans the temperature will be in the neighbourhood of 1,000° C. The presence of moisture in the material, its low conductivity for heat, together with the tendency which the crude bicarbonate has to form into lumps, renders this part of the process most difficult to carry out economically in practice.

In order to calcine 100 kilos of bicarbonate of soda, the following quantities of heat must be supplied:—

Decomposition of NaHCO ₃	-	-	-	-	27,800 calories.
Evaporation of water	-	-	-	-	18,900 "
Heat lost by the CO ₂	-	-	-	-	1,610 "
Heat carried away in ash	-	-	-	-	4,500 "
Radiation, etc.	-	-	-	-	13,000 "
					<u>66,000 approx.</u>

Assuming coal with a calorific value of 6,500 calories is used and a heat efficiency of 70 per cent. in the furnace, the quantity of coal required will be about 14.5 kilos per 100 kilos of ash, *i.e.*, the amount of fuel burnt under the furnaces will be 14½ tons for every 100 tons of ash produced.

When the soda ash is intended for export or glass-making purposes, it is after leaving the Thelen pans again calcined at a high temperature in a Mactear furnace, and subsequently ground to a powder. In this way the density is considerably increased. Thus, whereas 100 g. of light ammonia ash occupies a space of about 600-700 c.c., the same quantity of "heavy ash" only occupies about 300 c.c.

The soda ash is conveyed by a worm conveyor to the ash mill, where in a mechanical sieve it is reduced to a fine powder, and is then ready for packing.

The Compressing Engines.—The gas compressors form a very important part in an ammonia soda factory. Their function is, of course, after drawing the gas from the lime-kilns and the furnaces to force it through the carbonating apparatus. The back pressure exerted by the carbonating apparatus will be from 35-40 lbs. with Solvay towers, and from 30-40 lbs. per square inch when Honigmann's carbonators are used.

The compressors are direct acting, and are usually fitted with mechanically operated valves such as those of the Burchardt or Riedler type. It is impossible to use the highest class of valve giving a sharp cut off, owing to the exceptional difficulty of removing the last traces of dust from the lime-kiln gases. It is of course essential that in any case the gas passing to the engines should be as free as possible from suspended matter, otherwise the gas cylinders and valve faces rapidly become scored. The cylinder will in all cases be water-jacketed. It is necessary, however, to cool the gas still further before it enters the carbonating plant.

Content of Carbon Dioxide in the Various Gases.—A very large portion of the power raised in an ammonia soda factory will be used in pumping the carbon dioxide through the carbonating plant. It is hence a matter of the very greatest importance to maintain the content of carbon dioxide in the gas as high as possible in order that energy may not be uselessly expended in compressing large volumes of weak gas.

In order to produce 1 metric ton of sodium carbonate the quantity of carbon dioxide theoretically required is 422 cub. m. at N.T.P.

A certain quantity of carbon dioxide will, however, after compressing be lost owing to the following causes:—

1. Inefficient absorption in the carbonating plant.
2. Formation of calcium carbonate from calcium sulphate in the brine.
3. Incomplete expulsion of carbon dioxide in the heater.
4. Incomplete absorption of carbon dioxide in the absorber.
5. Leakage through valves, piston rod, glands, etc.

The total loss of carbon dioxide will vary in different factories between fairly wide limits, and it will usually be found necessary to pump from 450-500 cub. m. per metric ton of ash produced.

Of the total quantity of carbon dioxide required for the production of the sodium carbonate, theoretically 50 per cent. should be drawn from the soda calciners, and 50 per cent. from the lime-kilns. Since, however, the quantity of gas that has to be passed exceeds the theoretical quantity, the greater volume must be drawn from the lime-kilns, since the calcination of the bicarbonate of soda cannot furnish a greater quantity than 211 cub. m. per ton of ash produced.

The Content of Carbon Dioxide in the Lime-Kiln Gas.—In order to calcine 100 kilos of limestone, the following quantities of heat must, in practice, be supplied:—

Decomposition of CaCO_3 -	42,500 calories
Loss by withdrawal of hot lime, exit of hot gases, radiation, etc. -	15,100 "
Total	<u>57,600</u> "

Now the quantity of heat given out by the burning of 1 kg. of carbon present in the coke will be approximately 8,000 kilo calories. The total quantity of carbon necessary is hence:—

$$\frac{57,600}{8,000} = 7.2 \text{ kg.}$$

This quantity of carbon will require for combustion 13 cub. m. of oxygen yielding 13.0 cub. m. of CO_2 . As the oxygen is supplied by the air there will also be present 53.6 cub. m. of nitrogen.

Thus the issuing gases will have the following composition:—

CO ₂ from decomposition of CaCO ₃	-	-	-	22.4 cub. m.
CO ₂ from combustion of coke	-	-	-	13.4 "
N ₂ from atmosphere	-	-	-	53.6 "
				89.4 "

and the content of the carbon dioxide in the gas will be

$$35.8 \times \frac{100}{89.4} = \text{approximately } 40 \text{ per cent.}$$

Assuming coke with a content of 90 per cent. available carbon is used, the consumption of this material will be

$$7.2 \times \frac{100}{90} = 8.0 \text{ kilos per } 100 \text{ kilos of limestone.}$$

Content of Carbon Dioxide in the Furnace Gases.—The design of the calcining furnaces has been continuously improved until the gas now drawn from this source contains from 90-98 per cent. of carbon dioxide, and practically no loss occurs.

Content of Carbon Dioxide in the Mixed Gas.—If it is assumed that the total loss of carbon dioxide in the process, owing to the various causes previously mentioned, is 10 per cent., then it will be necessary to pump $422 \times \frac{100}{90} = 469$ cub. m. of carbon dioxide to produce 1 metric ton of ash. Of this quantity the furnaces should supply 200 cub. m., leaving $469 - 200 = 269$ cub. m. of carbon dioxide to be supplied by the kilns.

200 cub. m. of carbon dioxide from furnaces at 95 per cent.	=	210 cub. m. gas.
269 " " " " lime-kilns at 40 per cent.	=	672 " "
		Total 882

Thus in order to produce 1 metric ton of ash it will be necessary to compress 882 cub. m. of gas containing 469 cub. m. of carbon dioxide, or 53.2 per cent. by volume.

It will be seen that the content of carbon dioxide in the mixed gas is not only dependent on the strength of the lime-kiln and furnace gases, but also on the total quantity of gas pumped, and on the quantity of gas recovered from the furnaces.

Summary of the Operations.—Fig. 17 shows diagrammatically the manner in which the various parts of the apparatus in the ammonia soda process are combined together.

Limestone mixed with coke is charged into the kiln A. The issuing mixture of carbon dioxide and nitrogen is drawn by the compressing engines C through the water scrubber B, and is then pumped through the carbonating tower D, where it meets a stream of ammoniacal brine. Here most of the carbon dioxide is absorbed, and the spent gas containing a small quantity of ammonia passes through the brine washer N where the ammonia is recovered. A final scrubber O, fed with water, removes the last trace of ammonia gas should any escape the washer N.

The magma of bicarbonate of soda and ammoniacal liquor is blown from the tower D by means of the pipe K to the filter P. The moist sodium bicarbonate passes to the furnace T, where it is calcined and subsequently discharged as soda ash at G.

The gas leaving the furnace is drawn by the compressor C through the condenser S, where the water vapour is condensed. The final traces of ammonia in the gas are removed in the washer V, after which it is mixed with the lime-kiln gas.

The liquor leaving the filter passes to the storage tank Q, and is delivered by the pump R to the top of the heater L of the ammonia distiller. The ammonia is expelled from solution by a current of steam supplied through the pipe A. After reaching the bottom of the heater L the liquor leaves by the pipe D, is mixed with milk of lime, and returned at C, when the fixed ammonia is expelled in the still K. The spent liquor is blown away by the pipe B.

The gas leaving the ammonia distiller, after being cooled in the apparatus H, bubbles through brine in the absorber G, where most of the ammonia is dissolved. Any gas not absorbed passes to the washer M, where, by means of fresh brine, the last traces of ammonia are removed. The brine entering the absorber comes from the tank V after passing through the washers N and M.

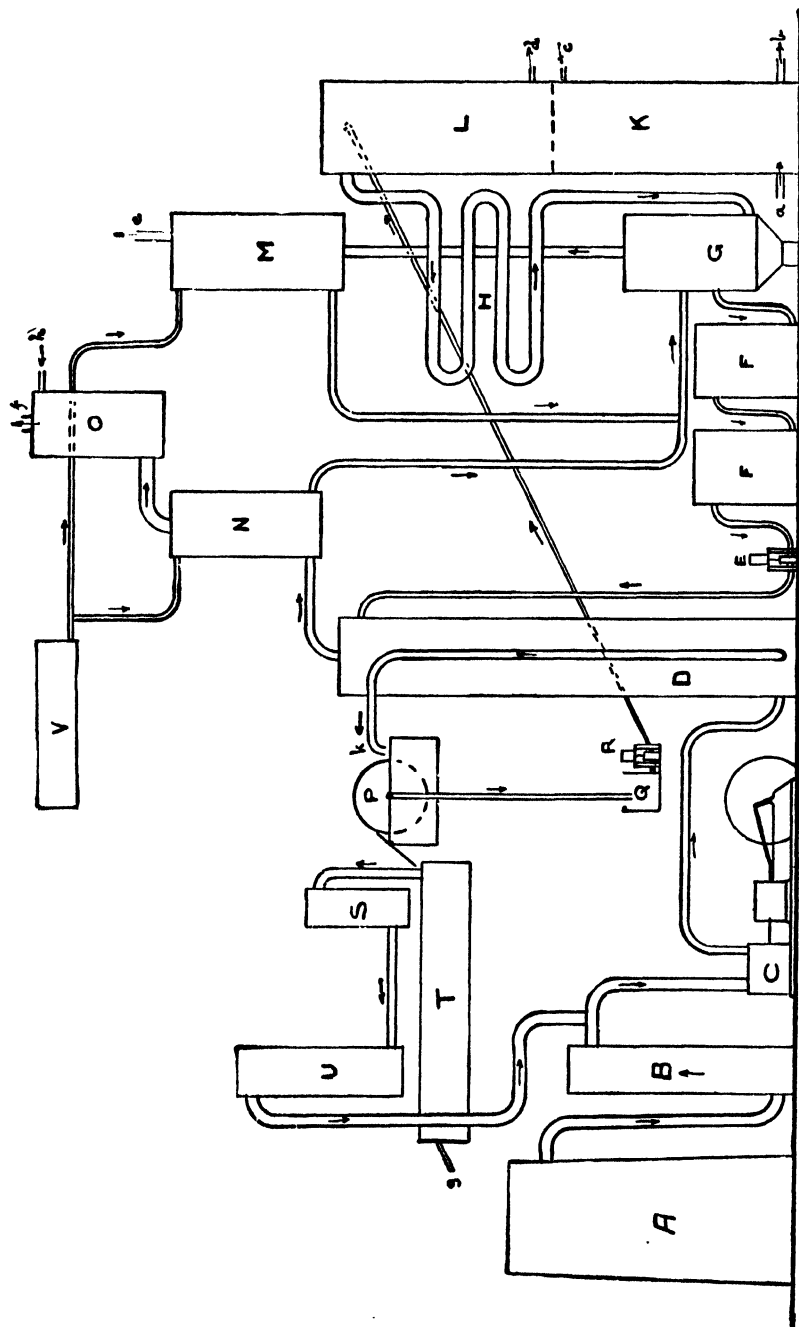


FIG. 17.—Diagram showing Ammonia Soda Process in Outline.

The ammoniacal brine, leaving the absorber G, passes through the settling vats F and F and is delivered by means of the pump E to the top of the carbonating tower (see also L. C. Hughes, *Chem. Met. Eng.*, 1930, 37, 232).

Control of the Process.—In order that the final product may be produced with the minimum consumption of raw materials, and in order that the maximum output of the various units may be maintained, it is necessary to watch every phase of the process with the greatest care.

The lime-kiln gases and furnace gases will be continuously sampled in order that the concentration of carbon dioxide may be maintained at a maximum. Further, the relative quantities of each of these gases, as shown by the mixed gas test, will be watched.

This relation is readily obtained.

Let x = volume of lime-kiln gas and p = per cent. of CO_2 ,

y = volume of furnace gas and p_1 = per cent. of CO_2 ,

P = per cent. of CO_2 in mixed gas.

Then $\frac{px}{100}$ = volume of CO_2 in lime-kiln gases,

and $\frac{p_1y}{100}$ = volume of CO_2 in furnace gas.

Hence,
$$\frac{\frac{px + p_1y}{100} \times 100 P}{x + y}$$

or,
$$y(p_1 - P) = x(P - p),$$

i.e.,
$$x : y = p_1 - P : P - p.$$

It will be seen that relative volumes of lime-kiln and furnace gas are inversely proportional to the amounts by which the respective carbon dioxide content differs from the mixed gas content of carbon dioxide, and the relative volumes of carbon dioxide supplied can be obtained thus :—

$$\frac{\text{CO}_2 \text{ from lime-kilns}}{\text{CO}_2 \text{ from furnaces}} = \frac{p(p_1 - P)}{p_1(P - p)}$$

This expression, $\frac{p(p_1 - P)}{p_1(P - p)}$, should approach unity.

The smaller the value is, the higher will be the efficiency of the process.

The spent gases leaving the carbonator washer must also be analysed in order that this loss of carbon dioxide may be kept as low as possible.

It may be here pointed out that if the gas leaving the process contains 5 per cent. of carbon dioxide, the percentage of carbon dioxide really lost is much greater. If x = per cent. of CO_2 in original gas, and y = per cent. of CO_2 in the gas leaving the process, then the percentage loss of CO_2 will be—

$$\frac{(100 - x)}{(100 - y) \cdot x} \times 100,$$

from which expression it is apparent that the percentage loss of carbon dioxide is dependent, not only on the actual percentage of carbon dioxide in the gas going to the atmosphere, but also on the percentage of carbon dioxide in the gas entering the process, for by increasing x the value of the above expression will be lower even if the value of y remain constant.

According to the efficiency of the carbonating plant, the exit gases will contain from 2-10 per cent. of carbon dioxide. An average of 3-4 per cent. will represent fairly good modern practice.

The ammoniacal brine in the absorber will be sampled every few minutes, and its content in ammonia and salt determined.

It is essential to the success of the process that the concentration of ammonia in the ammoniacal brine keep constant at the required figure, whilst the salt content must continually be kept as high as possible.

During the carbonating operation frequent samples are taken at various stages. Where a semi-carbonating tower is employed, the content of the carbon dioxide in the liquor leaving will be determined by Lunge's volumetric method. During the precipitation of the bicarbonate of soda the temperature is carefully controlled, and the decrease in the content of free ammonia watched. The operation is so conducted that the liquor passing to the filter is of uniform composition.

The bicarbonate of soda leaving the filter will be tested for ammonia, salt, and moisture. During the calcining operation the physical appearance of the material undergoing decomposition and temperature of the product leaving the furnace are the most important features to be watched. The final product may be tested for sodium carbonate, salt, insoluble matter, and iron. The quantity of the two latter constituents should be almost negligible, with the consequence that the soda ash produced is exceptionally pure, containing from 99.99.7 per cent. of Na_2CO_3 .

The return liquor going to the ammonia still is tested for free and fixed ammonia; the liquor leaving the heater for free ammonia and carbon dioxide.

The concentration of the milk of lime, and the lime excess after admixture with the ammoniacal liquor, require very careful control if the distilling operation is to be carried out with the minimum loss of lime and ammonia.

It is essential that the strength of the milk of lime be maintained as high as possible, in order to avoid excessive dilution of the liquors and consequent increase in the steam consumption in the still. Further, as every cubic metre of effluent will carry away from 2.10 kilos of lime and a trace of ammonia, it is apparent that the total volume of effluent must be kept low.

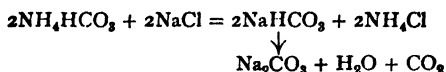
The content of ammonia present in the liquor nearing the bottom of the ammonia distiller is continuously determined, and the operation so conducted that the liquor in the last compartment contains an almost negligible quantity of ammonia.

In practice, however, this liquor will always contain a trace of ammonia, although the total amount should not exceed .001 g. per litre. The quantity of effluent passing per ton of ash produced will thus be carefully recorded.

The temperature of the gas at the top of the heater, and of the liquor leaving the heater, is kept under close observation. Too high a temperature at the top of the heater will mean excessive steam consumption, and a large amount of work being placed on the gas coolers. Too low a temperature will mean inefficient working of the heater. In consequence, the temperatures are maintained at the figure which experience has shown to be most suitable for the particular apparatus in question.

The temperature of the gas leaving the coolers must be maintained in the region of $58^\circ\text{--}60^\circ\text{C}$. Below this range the pipes will become blocked with ammonium carbonate. Above it excessive quantities of water vapour are carried to the absorber, and the salt content is diminished. Further, the temperature of the absorber will also rise, and this, as it has been mentioned, it is desirable to keep as low as possible.

The Yield of Soda Ash per ton of ammonia distilled is an important factor. The equation:—



shows that 1 ton of ammonia should produce 3.1 tons of ash.

In practice, however, for a large number of reasons, the yield falls considerably short of this figure, and may fall as low as 1.6 tons of ash per ton of ammonia distilled.

In any plant when the stock of ammonia is more or less constant the determining factor in the output is a figure which may be called the **ammonia cycle**. This figure is obtained from the expression

$$\frac{\text{Tons of NH}_3 \text{ distilled per unit of time}}{\text{Tons of NH}_3 \text{ in stock}}$$

and thus represents the number of times the stock of ammonia has gone through the cycle of operations in the period under consideration. The greater the speed

with which the ammonia stock can be circulated through the various stages of the operations, distilling, carbonating, and filtering, the greater, of course, is the production.

It is scarcely necessary to add that the power consumed in the ammonia soda process should be generated as economically as possible, the evaporative efficiency of the boiler plant being controlled in accordance with the most modern practice. With normal working the steam load will be practically constant. Large quantities of hot water for boiler feed purposes can usually be obtained from various sources, so that the efficiency of the boiler plant should be high. The effective utilisation of the steam once generated will depend on the efficiency of the process. A large proportion will be consumed by the compressing engines, and it is necessary to indicate frequently the gas and steam cylinders in order that their efficiency may be maintained at a maximum. Further, the relation between the quantity of gas which appears to have passed from chemical considerations, and that which should have been pumped, assuming a certain volumetric efficiency of the compressor, should be recorded in order that any discrepancy may at once be noticed.

Although the chemical reactions underlying the ammonia soda process are so simple in character, yet on the industrial scale the greatest difficulties are presented. The various operations are so interdependent one on the other that inefficient working, or a breakdown of any portion of the plant, is at once reflected throughout the entire process. Further, the disturbing influence will make itself felt for a considerable period after the defect has been remedied.

In order to maintain the continuity of operations so essential to the success of the process, it is necessary that those parts of the plant liable to accident or breakdown be duplicated.

The manufacture of ammonia soda in the most economical manner is an operation on which must be brought to bear experience, together with the highest technical ability.

In modern factories a very high state of efficiency has been arrived at, and with almost monotonous regularity, day and night for three hundred and sixty-five days of the year, many hundreds of tons of soda ash per week are produced with a minimum consumption of raw materials.

Factories designed, and subsequently worked, by those without previous experience in the industry have usually had to undergo many alterations before efficient working could be attained. Once, however, the initial difficulties of the process have been overcome, and the plant has been made efficient, very little further trouble will result.

Consumption of Raw Materials and Costs.—The raw materials used in the ammonia soda process are coal, coke, limestone, and ammonia.

The cost per ton of these materials will be governed partly by the locality of the factory, whilst the actual consumption will depend on the efficiency of the process.

Such has been the advance made in the industry, that the figures given by Schreib (*Chem. Zeit.*, 1894, p. 1951), as the lowest possible according to calculation, are those now realised in actual practice.

Consumption of materials for 100 kilos of soda :—

Coke	-	-	-	-	6.5	kilos.
Limestone	-	-	-	-	120	„
Coal	-	-	-	-	50	„
Ammonia	-	-	-	-	0.22	„

Whilst the consumption of coke will be slightly more than the figure given by Schreib, the ammonia loss will be considerably less, and with good practice should not exceed 0.1 kilo per 100 kilos of ash. In order to arrive at the final cost of production of the finished article, it will be necessary to add to the cost of raw materials, wages, standing charges, cost of package, etc. As these latter items are so variable, it will be unnecessary to discuss them here in detail. Owing to the great facilities usually afforded in the factory for handling the raw materials, and to the fact that the actual product during the various stages of manufacture is never touched by hand, the wages item will be very low, whilst owing to the large amount of plant and land necessary for producing ammonia soda, standing charges will be rather high.

Finally, it may be said that the ammonia soda process is in the hands of very few firms, and is by them conducted with the greatest secrecy, so that those details so essential to the commercial success of the process are not known to the general public.

Those who peruse the patent literature will have been struck in recent years by the absence of matter relating to this process, and from this might be led to conclude that little or no progress has recently been made. Such, however, is by no means the case. Rather than indicate to competitors the directions along which economy can be effected, and rather than invite them to infringe the patent in question, or to improve upon it, the manufacturer prefers to carry on his operations behind closed doors, behind which none but the most trusted employees are admitted.

Modifications of the Ammonia Soda Process

The final result of the ammonia soda process,



leads to the formation of two products, only one of which is of any great commercial value. In consequence of this, the application of the process to the treatment of **sodium sulphate** was patented by Bower, English Patent 8,413, 1840; Gerlach and Weldon, English Patent 5,605, 1883; also Gaskell and Hurter, English Patent 5,712, 1883. Its application to **sodium nitrate** was patented by Lesage & Co. in 1871, and by Chance in 1885. Colson (*loc. cit.*), again, discusses this subject, which has been further investigated by Fedotieff and Koltunow (*Zeits. anorg. Chem.*, 1914, 85, 247). They find that the behaviour of sodium nitrate is very similar to that of sodium chloride, although it is possible by suitable treatment to precipitate the whole of the sodium as the bicarbonate. 87.5 per cent. of the ammonia may be recovered as the nitrate; alternatively after distillation with lime a product may be obtained having the composition 79.42 per cent. $\text{Ca}(\text{NH}_2)_2$ and 20.58 per cent. NaNH_2 . This substance, of course, should have a high manurial value.

The German Patent, 164,726, directs the electrolysis of the effluent after-mixture with concentrated brine. Owing, however, to the precipitation of lime in the pores of this diaphragm this was not successful.

Finlay (English Patent 16,853, 1907, D.R.P. 216,265), in order to recover ammonia and chlorine, submits the ammonium chloride formed in the process to electrolysis, more sodium chloride being added if required. Loss of nitrogen, and in consequence of ammonia, during the operation, however, renders this process impracticable.

Clemm (English Patent 16,470, 1913) treats the ammoniacal mother liquors with an electrolysed solution of brine in order to expel the ammonia. The caustic soda reacts, of course, with the ammonium chloride to regenerate salt. This resulting solution is again electrolysed and used as before. Only a very low concentration of hydroxyl ions is aimed at during electrolysis in order that the current efficiency may be high.

The patentee claims that in this way a perfect process is obtained, and loss of sodium chloride is avoided. It is indeed impossible to conceive how such an extraordinary claim can be justified. It must be at once apparent that the utilisation of sodium chloride in the process is determined entirely by the carbonating operation, and can be in no way dependent on the distillation of the mother liquors. In such a process as that aimed at in this patent, after the distillation of a certain amount of mother liquor, the resulting effluent is again electrolysed, and used for the treatment of a further quantity of the mother liquor, with the result that the amount of liquor in circulation through the ammonia stills will increase indefinitely, and in a plant producing 1,000 tons of soda ash per week the amount of liquor thus circulating at the end of the first week would be in the region of seven million litres. It is, of course, quite impossible to carry out a process of this nature.

It would appear that what is in the mind of the patentee must be in reality the regeneration of the sodium chloride by distillation of the mother liquors with electrolysed brine, and the subsequent treatment of this sodium chloride again in the absorber and carbonating plant (although no indication of such a claim appears in the patent).

It must, however, be remembered that the reaction—



leads to a dilution of the sodium chloride, so that the solution of salt obtained will not be saturated. Further, it would be necessary to produce by electrolysis such a quantity of caustic soda and chlorine as would be equivalent to the whole of the sodium carbonate produced, with the consequence that a much more direct and economical process for the preparation of sodium carbonate would be to carbonate the caustic alkali during electrolysis as in the Hargreaves Bird cell.

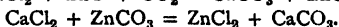
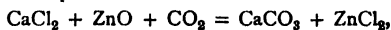
It is unnecessary to point out further defects in such a patent as applied to the ammonia soda industry, although they are many.

By-Products of the Ammonia Soda Process.—Although it has often been pointed out that the longevity of the Leblanc process has been due to the recovery of by-products, and that in this respect it has an advantage over the ammonia soda process, yet in reality this advantage is not very great, for while the Leblanc process can point to bleaching powder, sulphur, and hydrochloric acid, the Solvay process can point to chloride of ammonia, carbonate of ammonia, liquid ammonia, and calcium chloride.

The outstanding defect in the ammonia soda process is the fact that practically the whole of the chlorine originally present in the brine is run to waste as calcium chloride. A small quantity of this material is recovered and used for dust-laying refrigerating, and other purposes.

By means of this calcium chloride Messrs Brunner, Mond, & Co. prepare metallic zinc.

Calamine suspended in a solution of calcium chloride is treated with a current of carbon dioxide when the following reactions take place :—



The zinc is subsequently recovered from the chloride by electrolysis. Difficulties were at first experienced in obtaining a coherent deposit of zinc, but these have now been overcome.

Numerous attempts have been made in various directions to recover the chlorine present in the calcium chloride as such, but so far no economical method has been found.

Soda Crystals.—A large amount of sodium carbonate finds its way into commerce as the decahydrate ($\text{Na}_2\text{CO}_3 \cdot 10\text{H}_2\text{O}$) and is known as soda crystals or washing soda. It is very largely used where a mild form of alkali is required.

Soda ash, produced by the ammonia soda process, is dissolved with the aid of steam and a mechanical agitator in a mild steel vessel; a small quantity of salt cake is also added to harden the crystals. The solution is made of such a strength that it has a specific gravity of about 1.2-1.3 at 100° C. It is then passed into settling tanks, where the liquor is treated with bleaching powder in order to oxidise any organic matter that may be present and so decolorise the solution. Also in this way any iron present will be converted into the ferric state. Subsequently milk of lime is added, and any iron precipitated. At the same time the calcium carbonate produced, in falling to the bottom of the settling vat, carries with it other suspended matter of lower density. After standing for several hours the clear liquor is syphoned off into large mild steel semicircular crystallising pans, which usually hold from 8-10 tons of soda crystals. Flat bars are placed on the top of the pan and lie in the liquor in order that the crystals forming on the surface of the solution may be supported. The process of crystallisation usually takes about seven days in the winter and ten days in the summer. At the end of this time the mother liquor is allowed to drain away, and the crystals are crushed and subsequently treated in a hydro-extractor. The finest crystals are those formed on the surface of the liquor.

A very large amount of space is required for the production of soda crystals, owing to the length of time which the liquor must remain in the crystallising pans. In consequence a large number of patents have been taken out to expedite the process of cooling by using artificial means. Cf. Mactear (English Patent 10,651, 1884), Dekher (English Patent 24,978, 1898), Kunstner (English Patent 5,808, 1900). In this way, however, only small crystals are obtained, and although in this form the product is equally well, in fact better, suited for the purposes to which soda crystals are put, doubtless owing to prejudice on the part of the consumer, it is not widely used in this country. On the Continent, however, considerable quantities are produced.

Crystal Carbonate.—When a hot solution of sodium carbonate is allowed to evaporate, fine crystals, having the composition $\text{Na}_2\text{CO}_3 \cdot \text{H}_2\text{O}$, are deposited. This monohydrated carbonate of sodium is placed on the market under the name of “**crystal carbonate**.” It contains 81.5 per cent. Na_2CO_3 , 17.73 per cent. H_2O , as compared with the decahydrate, which contains 36.7 per cent. Na_2CO_3 and 62.86 per cent. of H_2O . The dissolution of the monohydrate in water results in the evolution of heat, whilst in the case of the decahydrate the action is endothermic.

At about 300° C. ordinary soda crystals dissolve in their water of crystallisation, whereas the monohydrate does not melt below a red heat, with the consequence that crystal carbonate finds application in tropical countries. Further, for export purposes especially, the lower cost of carriage per unit of alkali is of course an advantage.

Bicarbonate of Soda.—The sodium bicarbonate produced in the ammonia soda process contains a small quantity of ammonia which renders it unfit for many of the purposes to which the pure product is put. In order to produce the refined article the ammonia may be expelled from the crude product by a preliminary roasting operation. A large quantity of carbon dioxide is, however, lost in this way and it will in consequence be necessary to recarbonate the product so obtained after dissolution in water (C. F. Brock and Hawlickek, English Patent 8,314, 1896)

The bicarbonate of soda which separates out is filtered in the usual way and most of the moisture removed in a hydro-extractor; finally in a current of hot air or CO_2 (C. F. Jarmay, English Patent 3,889, 1893). The product is dried, then subsequently ground to an impalpable powder.

The expulsion of the ammonia from the crude bicarbonate of soda may also be effected whilst it is in solution or suspension by means of steam; recarbonation of the resulting liquors will, however, be necessary (C. F. Solvay, English Patent 173, 1888; Jarmay, English Patent 23,890, 1893).

Amongst other methods for the preparation of pure bicarbonate of soda may be mentioned that patented by Mond and Jarmay (English Patent 2,996, 1884), who direct the dissolution of the crude salt in water at 65°C . After filtration and cooling, pure bicarbonate of soda separates out, leaving all ammonium salts in solution.

Concentrated Crystal Soda, Sodium Sesquicarbonate (Watts and Richards, English Patent 13,001, 1886).—This substance ($\text{Na}_2\text{CO}_3 \cdot \text{NaHCO}_3 \cdot 2\text{H}_2\text{O}$) is prepared by allowing a solution containing suitable proportions of the normal and acid carbonates of sodium to crystallise above 35° . It finds application in wool washing and possesses the advantages of being neither efflorescent nor deliquescent.

SECTION XXVIII

THE STASSFURT INDUSTRY

BY FRANK MILSOM, B.Sc. (Lond.)

Technological Chemist

LITERATURE

- DAMMAR.—“*Chemische Technologie.*”
 —“*Chemische Technologie der Neuzeit.*”
 OST.—“*Chemische Technologie.*”
 THORPE.—“*Dictionary of Chemistry.*”

The Stassfurt Industry

THE Stassfurt deposits were discovered in the year 1839, and have proved of vast importance technically as the source of a large quantity of the potassium salts of commerce, besides magnesium and sodium salts.

The following minerals are found :—

Mineral.	Formula.
Rock salt - - - -	NaCl
Anhydrite - - - -	CaSO ₄
Polyhalite - - - -	K ₂ SO ₄ .MgSO ₄ .2CaSO ₄ .2H ₂ O
Kieserite - - - -	MgSO ₄ .H ₂ O
Carnallite - - - -	KCl.MgCl ₂ .6H ₂ O
Boracite (Cryst.) - - -	2Mg ₃ B ₃ O ₁₅ .MgCl ₂
Douglasite - - - -	2KCl.FeCl ₂ .2H ₂ O

These are the originally deposited minerals. By their decomposition the minerals given below are formed and are accordingly found in the deposits.

Mineral.	Formula.
Sylvin - - - -	KCl
Kainite - - - -	K ₂ SO ₄ .MgSO ₄ .MgCl ₂ .6H ₂ O
Schönite - - - -	K ₂ SO ₄ .MgSO ₄ .6H ₂ O
Tachhydrite - - - -	CaCl ₂ .2MgCl ₂ .12H ₂ O
Bischofite - - - -	MgCl ₂ .6H ₂ O
¹ Krugite - - - -	K ₂ SO ₄ .MgSO ₄ .4CaSO ₄ .2H ₂ O
Reichardtite (Epsom salts) - - -	MgSO ₄ .7H ₂ O
¹ Glauberite - - - -	Na ₂ SO ₄ .CaSO ₄
Astrakanite - - - -	Na ₂ SO ₄ .MgSO ₄ .4H ₂ O
¹ Pinnoite - - - -	MgB ₂ O ₄ .3H ₂ O
Hydroboracite - - - -	CaB ₂ O ₄ .MgB ₂ O ₄ .6H ₂ O

Gypsum (CaSO₄.2H₂O) is also found in the upper strata.

From the first discovery of them the nature and composition of the deposits has aroused great interest. Great numbers of experiments have been done with a view to determining the origin of the deposits. The question is a very complicated one, and much valuable work was done on it

¹ These minerals are decomposed by water.

by van't Hoff. It can only be referred to very briefly here, as the question is one of pure chemistry rather than of great technical importance. It has been found that pressure and temperature have a great influence upon the salts deposited from a mixture.

For example, from a solution saturated with sodium chloride at 25° C., and also containing magnesium chloride, potassium sulphate, magnesium sulphate, and potassium chloride, the following are obtained :—

Name.	Formula.
Rock salt	NaCl
Sylvin	KCl
Carnallite	KCl.MgCl ₂ .6H ₂ O
Magnesium sulphate	MgSO ₄ .6H ₂ O
"	MgSO ₄ .7H ₂ O
Magnesium chloride	MgCl ₂ .6H ₂ O
Schönite	K ₂ SO ₄ .MgSO ₄ .6H ₂ O
Glaserite	K ₂ Na(SO ₄) ₂
Magnesium sulphate	MgSO ₄ .5H ₂ O
"	MgSO ₄ .4H ₂ O
Sodium sulphate	Na ₂ SO ₄
Astrakanite	Na ₂ SO ₄ .MgSO ₄ .4H ₂ O

By varying the temperature and pressure can be obtained also—

Kieserite	MgSO ₄ .H ₂ O
Kainite	K ₂ SO ₄ .MgSO ₄ .MgCl ₂ .6H ₂ O

With this brief general survey of the deposits we can pass to a more detailed account of the various salts.

Carnallite (MgCl₂.KCl.6H₂O).—Carnallite or potassium magnesium chloride is the mineral from which most of the potassium chloride of commerce is obtained. It is of a red colour, due, according to Ruff, to anhydrous ferric oxide. Sp. gr., 1.6; hardness, 1 (Moh.); greasy, shining lustre; colour, white, pink, or red; gives a conchoidal fracture; intumesces when heated; easily soluble in water.

Carnallite contains a minimum of 9 per cent. potassium chloride, which is obtained from it in the following manner:—

By dissolving the crude salt in the hot mother liquors (*vide infra*) and allowing to crystallise, a product containing 80-85 per cent. potassium chloride is obtained. This method of manufacture is still much used.

Several other methods of treating the carnallite are also in operation (see Potassium Salts).

By the electrolysis of fused carnallite metallic magnesium is obtained.

Kainite (K₂SO₄.MgSO₄.MgCl₂.6H₂O).—Kainite is sold under a guarantee as containing 12.4 per cent. potassium oxide. Sp. gr., 2.13; hardness, 2 (Moh.); vitreous lustre; colourless, grey, or yellow crystals; soluble in water.

It is used as a source of potassium sulphate, which is prepared from it by the method of Precht, which consists in heating with a saturated solution of potassium magnesium sulphate and sodium chloride under a pressure of 2-4 atmospheres. The double salt (K₂SO₄.2MgSO₄.H₂O) separates and is filtered off and washed. By this washing, 1 molecule of magnesium sulphate is removed, and the residue (K₂SO₄.MgSO₄) comes into the market as potassium magnesium sulphate. By treating these with potassium chloride, potassium sulphate can be obtained.

Another method of separating the potassium as potassium sulphate, or as potassium sodium sulphate, consists in the use of ammonia, whereby the magnesium is separated as the double ammonium chloride. Enough ammonia is first led in to combine with half the magnesium, the magnesium hydrates are filtered off and the filtrate saturated with ammonia. The magnesium now remains in the solution as the double salt, and the potassium sulphate separates.

Magnesium chloride is obtained from the mother liquors of the above salts. These contain 28-29 per cent. magnesium chloride with about 0.3 per cent. magnesium bromide. This latter is separated and used for the preparation of bromine.

The liquors are concentrated to a specific gravity of 1.388-1.401, and on cooling this MgCl₂.6H₂O crystallises out (see Magnesium Salts).

Kieserite (MgSO₄.H₂O).—Sp. gr., 2.5-2.6; hardness, 3; vitreous lustre; white, yellow, or grey crystals; easily fusible; soluble in water. Kieserite is used as

the source of Epsom salts, or magnesium sulphate heptahydrate. This is obtained by long boiling of the kieserite with water.

Glauber Salt.—This salt, well known for its medicinal properties, is obtained at Stassfurt by working up residues from the carnallite (see table).

These have the following composition :—

NaCl	-	-	-	-	-	-	-	45-55	per cent.
KCl	-	-	-	-	-	-	-	3-5	"
MgCl ₂	-	-	-	-	-	-	-	3-4	"
MgSO ₄	-	-	-	-	-	-	-	25-30	"
CaSO ₄ and insoluble matter	-	-	-	-	-	-	-	7-9	"
Water	-	-	-	-	-	-	-	7-10	"

These are allowed to stand some time in the air, and are then dissolved to make

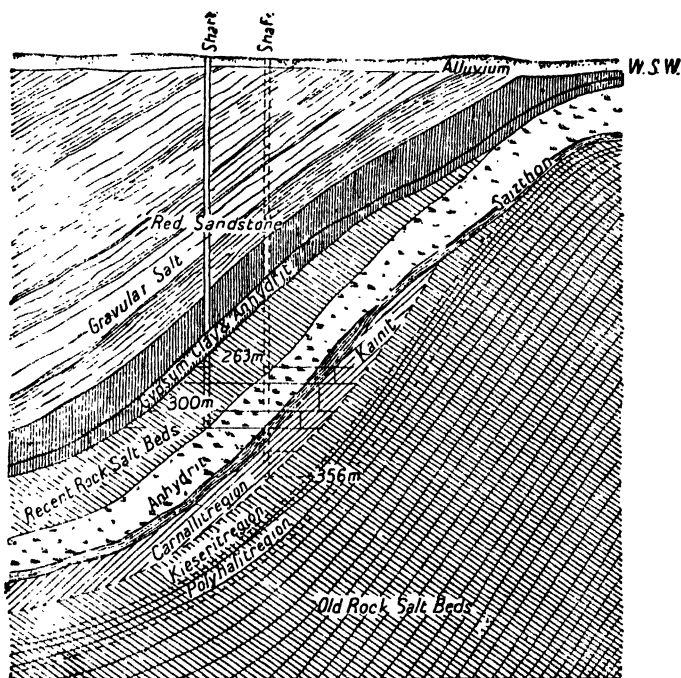
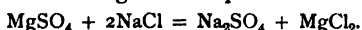


FIG. 1.—Stassfurt Salt Deposits.

a solution of specific gravity 1.268-1.29 at 33° C., which contains about 150 kg. magnesium sulphate per cubic metre. This solution is allowed to spontaneously evaporate in flat crystallising pans.

Glauber salt is formed according to the equation :—



The crude crystals are drained and recrystallised, and dried at 25°-30° C.

Boracite.—The following minerals are classed together under the name of Boracite :—

Boracite	-	-	-	-	-	-	-	2Mg ₃ B ₂ O ₁₃ + MgCl ₂
Hydroboracite	-	-	-	-	-	-	-	CaMgB ₄ O ₈ .6H ₂ O
Pinnoite	-	-	-	-	-	-	-	MgB ₂ O ₄ .3H ₂ O

These are found in lumps in the deposits of carnallite and kainite. They are

sparingly soluble in water and can be obtained by washing out the more soluble portions of these salts.

The percentage of Boracite is from .0112-.045.

The residue from the working up of carnallite, etc., contains about 15 per cent. boracite.

Boric Acid is obtained from these boron-containing minerals by precipitation with hydrochloric acid. 100 parts boracite require 150 parts hydrochloric acid and 300 parts water. From 100 parts boracite, 82-85 parts crystalline boric acid are obtained.

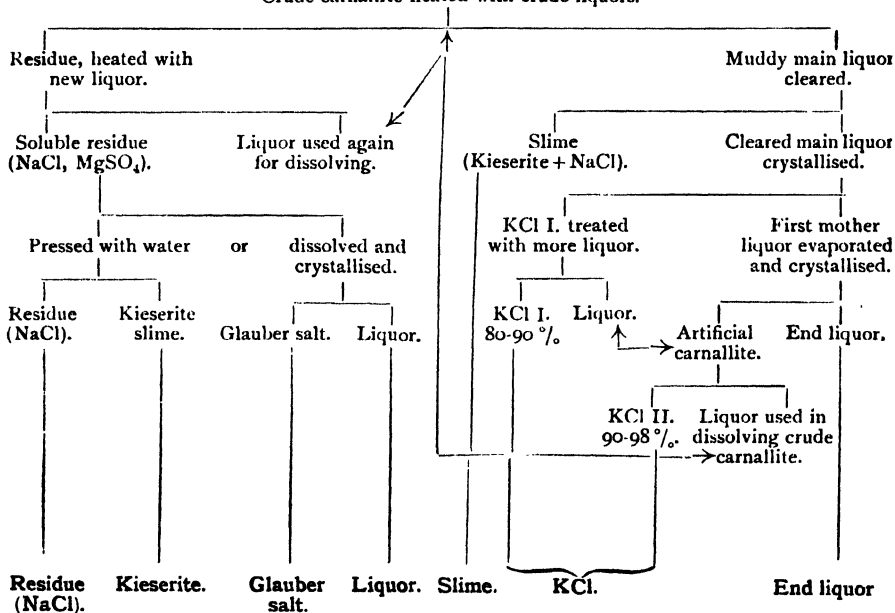
The "end liquor" of the potassium salt manufacture contains much magnesium chloride, for the preparation of which see Magnesium Salts.

A small amount of magnesium bromide is contained in the magnesium chloride.

The end liquor contains from .287-.323 per cent. $MgBr_2$. This corresponds to about 3.5 kg. bromide per cubic metre. The bromine is separated by treatment with chlorine as described under **Bromine** on p. 403.

Treatment of Carnallite

Crude carnallite heated with crude liquors.



STATISTICS OF SALT FROM 1898 TO 1907

Salt.	1898.	1899.	1900.	1901.	1902.
	Tons.	Tons.	Tons.	Tons.	Tons.
Potassium chloride - - -	191,347	207,506	271,512	294,666	267,512
Magnesium chloride - - -	19,819	21,370	19,397	21,018	19,658
Glauber salt - - - - -	69,111	79,062	90,468	76,066	90,742
Potassium sulphate - - -	18,853	26,103	30,853	37,394	28,278
"Magnesium" - - - - -	13,982	9,765	15,368	15,612	18,147
Magnesium sulphate - - -	30,295	39,540	48,591	46,714	39,262
... - - - - -	35,366	37,693	44,372	46,807	47,905
Alum - - - - -	4,069	3,358	4,355	4,145	4,108
Total - - - - -	382,842	424,397	524,916	542,422	515,612

Statistics of Salt from 1898 to 1907—continued.

Salt.	1903.	1904.	1905.	1906.	1907.
	Tons.	Tons.	Tons.	Tons.	Tons.
Potassium chloride - - -	280,248	297,238	373,177	403,387	473,138
Magnesium chloride - - -	22,990	25,730	29,017	38,468	32,891
Glauber salt - - - -	83,087	76,034	68,455	81,175	80,340
Potassium sulphate - - -	36,674	43,959	47,994	54,490	60,292
"Magnesium" - - - -	23,631	29,285	34,222	35,211	33,368
Magnesium sulphate - - -	37,844	39,312	58,568	42,041	41,105
... ..	49,727	55,481	55,806	55,969	59,473
Alum - - - -	3,934	3,850	4,270	4,494	4,200
Total - - - -	538,135	571,389	671,509	715,235	784,814

SECTION XXIX

POTASSIUM SALTS

BY GEOFFREY MARTIN, D.Sc. (Lond.)

LITERATURE

- “The Mineral Industry of the British Empire.” The Imperial Institute, London, 1933.
 “The World’s Supply of Potash.” The Imperial Institute, London, 1915.
 G. R. ROBINSON.—*Ind. Eng. Chem.*, 1929, **21**, 520.
 See also *Chem. Trade Journal*, 1933, **93**, 120, 288; *Chem. Age*, 1933, **29**, 163; *Ind. Eng. Chem.*, 1933, **25**, 256, 374; also G. A. BLANC, *Trans. Inst. Chem. Eng.*, 1931, **49**.
 See British Patent, 342,617.

THE great commercial importance of potassium salts is so self-evident that it needs no comment.

The chief of these salts are:—**The chloride, sulphate, nitrate, carbonate, bicarbonate, hydrate and chromate.**

Potassium salts of various kinds are found in many mineral deposits, the most notable of which are the Stassfurt deposits (*q.v.*), and the various salt-petre beds of the world, chief among which are those of Ceylon.

These mineral sources can be classed together as inorganic sources, but one great branch of the potassium industry consists in the manufacture of potassium carbonate from vegetable or organic sources.

Potassium salts are now being produced in **France, Spain** (Catalonia), **Palestine** (the Dead Sea), **United States and Mexico**. About 52,000 tons of potash salts were used for fertilisers in the United Kingdom in 1928.

The most important, perhaps, of all the various manufactures is the preparation of **potassium chloride** from the **Stassfurt deposits**.

It is prepared from **carnallite** in the following manner:—

The crude ore, containing usually about 16 per cent. KCl, is first of all dissolved, usually in the “end liquor” (see table, p. 332), which itself contains 10-20 per cent. of magnesium chloride. This liquor is kept at boiling temperature (approximately 115° C.) during the solution. When the maximum amount of ore is dissolved, the hot liquor is run off from the insoluble kieserite and mud into clearing vats and is allowed to stand (still being kept hot) for an hour or two. If necessary the specific gravity of the solution is reduced to 1.28-1.30 before clarifying.

The clarified liquor is then run off into crystallising vats, and allowed to cool fairly slowly. It is allowed to crystallise for two or three days.

Fig. 1 shows the plant used in working up the carnallite for KCl manufacture. The raw carnallite is coarsely ground in the mill *a*, then transferred by the elevator *b* to the dissolving boiler *d*, made of cast iron and fitted with a perforated false bottom, on which the carnallite rests. The capacity of the boiler is usually 12 cub. m. It is fitted with steam-heating coils and a valve for running off the contents, also manholes, etc. The liquor used for lixiviation (usually the “end liquor”) is pumped from *g* (by the pump *h*) into the heating tank *i*, thence it flows into the boiler *d*, where it is heated to about 115° C., the boiling being continued for some time until as much salt is dissolved as possible, the crude carnallite being added gradually to the hot liquor. There remains behind a mud of kieserite, lumps of hard rock salt, etc. The hot solution flows away through the filtering tank *e* (where much of the mud is retained) into the clarifying tank *f*, and, after clarifying, is run hot into iron crystallising tanks, where crystallisation of the KCl I. takes place.

These crystals (potassium chloride I.) contain after drying 80-85 per cent. KCl. These are washed several times with water or weak liquor, and finally attain a concentration of about 90 per cent. KCl.

The mother liquor from the crystallisation of the KCl yields on further evaporation “artificial carnallite.” This is dissolved in the washing liquors and crystallised. It yields a potassium chloride of 90-98 per cent. purity after washing as before and drying. The final washing liquors serve as a solvent for the crude carnallite.

The composition of the potassium chloride I. is approximately :—

KCl	-	85	per cent.
NaCl	-	12	„
MgCl ₂	-95	„
MgSO ₄	-6	„
Water	-	2.5	„

Potassium chloride is also prepared from sylvine (KCl and NaCl) in the same way as from carnallite, and yields crystals of 92-94 per cent. purity, which after washing and drying are 98 per cent. pure. 100 g. water dissolve 33.4 g. KCl at 15° C., and 56.6 g. at 100° C.

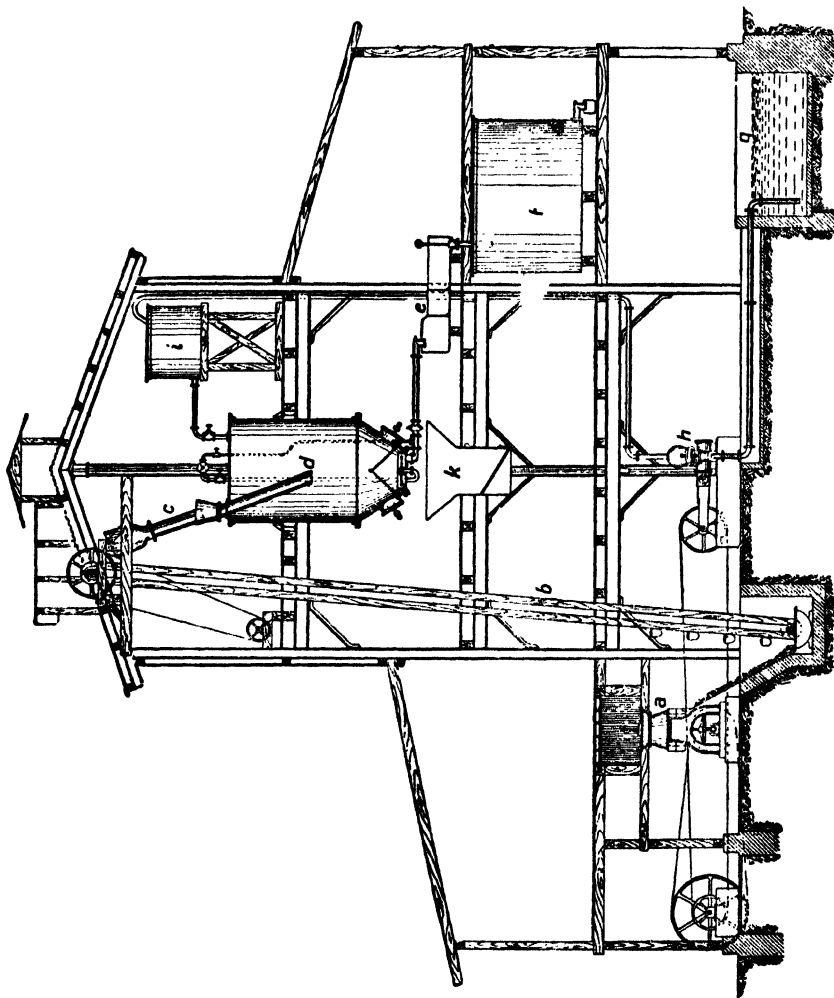


FIG. 1.—Carnallite Plant for KCl Manufacture.

Various patents on these processes are :—

D. R. P. 92,812 of 6th August 1896.
 D. R. P. 98,344 of 13th November 1896.
 D. R. P. 99,957 of 1st December 1896.
 D. R. P. 102,075 of 15th October 1897.
 D. R. P. 129,864 of 16th April 1901.
 D. R. P. 128,999 of 14th March 1901.

D. R. P. 135,722 of 14th November 1899.
 D. R. P. 149,435 of 23rd February 1904.
 D. R. P. 166,558 of 1st June 1904.
 D. R. P. 132,474 of 18th June 1901.
 D. R. P. 206,410 of 2nd October 1907.
 D. R. P. 207,887 of 28th March 1907.

And many others.

Potassium Sulphate (K₂SO₄)

Kainite (K₂SO₄.MgSO₄.MgCl₂.6H₂O) is chiefly used as the starting point in this manufacture.

It is finely ground and macerated with water, and allowed to stand in the air for some time. It then separates into potassium magnesium sulphate and magnesium chloride liquor.

In modern times, however, Precht's method is followed, viz. :—

The crude kainite is heated with a saturated solution of common salt and potassium magnesium sulphate under a pressure of 2-4 atmospheres.

Precht's double salt (K₂SO₄.2MgSO₄.H₂O) is thus formed. It is separated and dried at 100° C., and is practically pure, after washing.

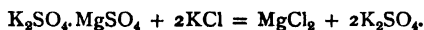
(The mother liquor from this crystallisation contains KCl and MgCl₂ and can be used in the working up of carnallite.)

Crude kainite yields 30-40 per cent. of potassium magnesium sulphate.

The washing liquors on evaporation yield **Schoenite**, K₂SO₄.MgSO₄.6H₂O.

Schoenite can also be prepared by the interaction of crude carnallite with kieserite. For this purpose the powdered carnallite is shaken with a hot saturated solution of kieserite.

For the preparation of **potassium sulphate** the potassium magnesium sulphate, prepared in either of the foregoing ways, is macerated with potassium chloride solution of 1.142 sp. gr. (18° Bé.), or else the solution of the double salt is shaken with finely powdered dry potassium chloride—



The crystalline magma of potassium sulphate formed is purified by washing. It is of about 90 per cent. purity before drying and about 96 per cent. after drying. 100 g. water dissolve 10.3 g. K₂SO₄ at 15° C., and 26.2 g. at 100° C.

Potassium Carbonate (K₂CO₃)

Potassium carbonate (K₂CO₃) crystallises anhydrous. 100 g. water dissolve 110 g. K₂CO₃ at 51° C. and 156 g. at 100° C. It can be manufactured from the following sources :—

1. Mineral—

(a) From potassium chloride and sulphate.

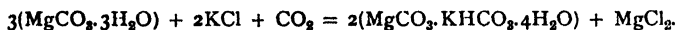
(β) From felspar and other naturally occurring potassium silicates.

(α) (i) For the **Leblanc process** see p. 291.

(ii) The **ammonia process** (p. 299) is not applicable owing to the solubility of potassium bicarbonate.

Ortlieb (D.R.P.'s, 5,706, 9,376, 13,397) used trimethylamine. The great solubility of the hydrochloride of this base admits of the separation of the potassium bicarbonate. This ingenious process was, however, given up after working for a short time.

(iii) **Precht's magnesia process.**—In this process, kiln gases are passed into a paste consisting of a solution saturated at 20° C. of potassium chloride mixed with trihydrated magnesium carbonate (MgCO₃.H₂O). The following reaction takes place :—



The double salt formed is washed free from chloride by a solution of magnesium carbonate, and is then heated under pressure at 140° C., when it suffers decomposition thus :—



For this process see D.R.P.'s, 55,182, 125,987, 143,594, 155,007, 172,313 and others; also R. Engel, D.R.P. 15,218.

(β) Hart (U.S. Pat. 997,671) extracts the potash from siliceous minerals by fusing with barium sulphide, and extracting the potassium salt with acid.

2. Vegetable—

- (α) From wood ashes.
 (β) From beetroot molasses.
 (γ) From kelp.

(α) Potassium being a constituent of the ashes of plants, potassium carbonate has been prepared from this source for a very long time.

The following table gives the percentage of potash and ash in some common woods :—

	Per Cent. Ash.	Per Cent. Potash.
Pine - - - - -	0.34	0.045
Beech - - - - -	0.58	0.145
Ash - - - - -	1.22	0.074
Oak - - - - -	1.35	0.153
Willow - - - - -	2.80	0.288
Elm - - - - -	2.55	0.390
Vines - - - - -	3.40	0.550
Ferns - - - - -	3.64	0.626

In Canada most potash is made from elm, birch, larch, and maple.

The wood is buried in pits dug in the earth and sheltered from the wind.

The ash is collected, spread out in thin layers, sprinkled with water, and worked about until evenly damp.

The damp ash is then placed in casks provided with perforated double bottoms, which are covered with straw, and washed with water many times.

The liquor containing from 20-25 per cent. of salts is then evaporated, and the solid burnt white in a furnace to get rid of organic substances. The yield is about 10 per cent. of the original ashes.

This "wood-potash" contains 50-80 per cent. potassium carbonate, 5-20 per cent. potassium sulphate, also sodium carbonate, potassium chloride and other salts.

(β) **From Beet Sugar Molasses.**—The extraction of potassium carbonate from beet molasses is quite an important branch of the potash industry. Germany manufactures about 15,000 tons yearly. This is manufactured from about 300,000 tons of molasses.

In former times the sugar was got rid of by diluting the molasses, fermenting, and distilling of the spirit.

Nowadays, however, the following method is adopted.

The molasses is neutralised with lime, and concentrated. When syrupy, it is placed on the bed of a reverberatory furnace and carbonised. The heat is carefully regulated, so that the mass does not fuse, as this renders the subsequent extraction with water difficult.

The resulting solid is known in Germany as "Schlempekohle" or in France as "vinasse cinder."

The composition¹ of this is as follows :—

K_2CO_3	-	-	-	-	30-35 per cent.
Na_2CO_3	-	-	-	-	18-20 "
KCl	-	-	-	-	18-22 "
K_2SO_4	-	-	-	-	6-8 "
Insoluble matter	-	-	-	-	28-15 "

Vincent (*Compt. Rend.*, 84, 214) runs the liquor at a concentration of 40° Bé. into iron retorts, and distils. The distillate consists of trimethylamine, methyl chloride, ammonia, and other substances of lesser importance.

The working up of the "cinder" is proceeded with as follows :—

The cinder is lixiviated, the liquor being run off when it attains a concentration of 23°-32° Tw. This is then evaporated to 74°-82° Tw. The hot liquid is then allowed to settle for two hours,

¹ For further analyses see also Hinz Fischer's "Jahresberichte," 1893, 389.

during which time potassium sulphate separates along with mud, etc. The clear liquor is then drawn off and allowed to cool. Impure potassium chloride then crystallises.

The mother liquor is evaporated to 127°-142° Tw. and is slightly cooled, when more potassium chloride separates. On drawing off and cooling, a double chloride of potassium and sodium ($K_2CO_3 \cdot Na_2CO_3 \cdot 12H_2O$) separates.

This is filtered off and dissolved in hot water, the liquor being then concentrated to 117° Tw. Monohydrated sodium carbonate ($Na_2CO_3 \cdot H_2O$) is separated by fishing.

The mother liquor is boiled down with the former mother liquor from the double carbonate, and after settling is calcined.

Its composition is :—

K_2CO_3	-	-	-	-	-	80-84	per cent.
Na_2CO_3	-	-	-	-	-	8-10	"
KCl	-	-	-	-	-	3-4	"
K_2SO_4	-	-	-	-	-	3-4	"
K_2SiO_3 , K_2HPO_4 , and insoluble matter	}				-	0.6-2.2	"

Potassium Bicarbonate ($KHCO_3$)

This is prepared by leading carbon dioxide into a saturated solution of potassium carbonate. The bicarbonate, being much less soluble than the carbonate, crystallises out.

On the manufacturing scale, it is prepared by passing CO_2 into a slightly moistened mixture of "potash" and charcoal.

When all the carbonate is apparently changed into bicarbonate, the mixture is lixiviated with water at a temperature of 70°-80° C.—not higher, as this would decompose the bicarbonate—and the clear filtered liquor is evaporated to crystallisation.

Potassium Chromate (K_2CrO_4)

For the manufacture of this important potassium salt, chrome-iron ore (Cr_2FeO_4) is used as the starting point.

It is mixed with potash and saltpetre and fused. The mixture is powdered, and the potassium chromate extracted with hot water.

Jacquelain (D. 106, 405; 131, 136) strongly heats the chrome-iron ore with chalk, and decomposes the resulting calcium chromate with potassium sulphate.

According to Massignon and Vatel (Bll. 5, 371; D.R.P. Nr. 56,217), the powdered ore is mixed with chalk, the mixture treated with calcium chloride solution to make a stiff paste, formed into blocks, dried and burnt in a furnace to decompose the $CaCO_3$.

The porous mass is allowed to stand in contact with air until oxidation is complete, then lixiviated, and the residual calcium chromate decomposed with potassium sulphate (or sodium sulphate, if sodium chromate is to be prepared).

100 g. water dissolve 62.9 g. K_2CrO_4 at 20° C. and 79.1 g. at 100° C.

Potassium Bichromate ($K_2Cr_2O_7$)

Prepared by roasting finely powdered chrome-iron ore with the purest possible lime and potassium carbonate.

The resulting mixture of calcium and potassium chromates is treated systematically with a solution of K_2SO_4 or K_2CO_3 .

The liquor is mixed with sulphuric acid until of strongly acid reaction, and then evaporated, when potassium bichromate crystallises out. 100 g. water dissolve 13.1 g. $K_2Cr_2O_7$ at 20° C. and 102 g. at 100° C.

Potassium Chlorate ($KClO_3$) is prepared as described in Section XXXVIII, p. 385.

Potassium from Cement Works.—The flue dust from most cement works contains much potassium, and it has been proposed to utilise this dust as a source of potash (see, for example, S. L. Madorsky, *Ind. Eng. Chem.*, 1932, 24, 233).

Statistics—

PRODUCTION OF POTASH

(Long Tons)

Producing Country and Description.	1930.	1931.	1932.	K ₂ O Content or Equivalent.		
				1930.	1931.	1932.
BRITISH EMPIRE						
Palestine—						
Carnallite - - -	...	40,000	100,000
India—						
Nitrate (estimated) -	4,600	7,000	9,000	2,200	3,400	4,300
Total (estimated) -				2,200
FOREIGN COUNTRIES						
France—						
K ₂ O equivalent—						
Sylvinite, etc. :						
12-16 % - - -	214,301	114,872	102,213	} 498,373	363,544	316,155
18-22 % - - -	649,360	447,697	388,361			
30-40 % - - -	207,776	146,165	94,849			
50 % and over -	464,496	363,544	337,324			
Germany—						
Kainite, sylvinite, etc. - - -	9,935,271	6,881,691	5,688,310	1,406,851	961,232	797,314
Carnallite, etc. -	1,838,053	1,042,548	625,896	176,259	99,390	60,278
Italy—						
Leucite - - -	40,500	16,000	43,000
Alunite - - -	812	974	700	80	100	70
Poland—						
Kainite - - -	99,191	58,186	44,108	9,919	5,819	4,411
Sylvite - - -	201,591	199,006	249,996
Spain—						
Crude salts - - -	281,912	84,470	403,414	28,192	27,672	53,945
Nitrified earth -	900	1,100
Egypt—						
Crude salts - - -	...	1	8
United States—						
Crude salts - - -	94,473	119,571	127,786	54,705	57,036	55,348
Korea—						
Alunite (impure) -	11,523	13,600
Total - - -				2,220,000	1,560,000	1,310,000
WORLD'S TOTAL -				2,220,000	1,560,000	1,320,000

SECTION XXX

CALCIUM AND MAGNESIUM SALTS

BY GEOFFREY MARTIN, D.Sc., Ph.D.

CALCIUM SALTS, LIME, LIMESTONE, ETC.

LIME.—**Calcium oxide**, CaO , is made by heating calcium carbonate—limestone, marble, etc. (see under **Calcareous Cements**, Vol. II. of this work).

Properties.—White, porous, amorphous mass; sp. gr. 2.3-3.0. Very infusible, but melts in highest temperature of the O.H. flame, also in electric arc. Emits an intense light when heated. Takes up water from the air, and when moist rapidly absorbs CO_2 as well. Much heat is evolved on adding water, owing to the formation of calcium hydroxide (*q.v.*). Anhydrous CaO , however, only absorbs gaseous CO_2 at about 400°C . CaO is readily soluble in mineral acids, being a strong base. It reacts with alcohol to form calcium hydroxide and calcium ethylate at 125°C . in a sealed tube.

Qualities and Uses of Lime.—The two main uses of lime are for building and for chemical manufacture. Technical lime varies very considerably in composition.

For chemical manufacture a lime as pure as possible is preferred, but for building purposes impure limes (sometimes approximating in composition to Portland cement) are preferred (see under **Calcareous Cements**, Vol. II. of this work).

Slaked Lime, Calcium Hydroxide, Hydrate of Lime, $\text{Ca}(\text{OH})_2$ (see under **Calcareous Cements**, Vol. II. of this work).—Pure slaked lime is a white amorphous powder, sp. gr. 2.078, sparingly soluble in water; one part of CaO dissolves at 0°C . in 759 of water, at 20° in 791 of water, at 99° in 1,650 parts of water. At a red heat water is driven off and CaO regenerated.

Calcium Carbonate, CaCO_3 .—For occurrence, etc., see under **Calcareous Cements**, Vol. II. of this work.

Properties.—Pure water dissolves 18 mg. CaCO_3 per litre of water. Water containing CO_2 takes up much more owing to formation of calcium bicarbonate, $\text{CaCO}_3 \cdot \text{H}_2\text{CO}_3$. One litre of water saturated with CO_2 dissolves 0.7 g. CaCO_3 at 0°C ., and 0.88 g. at 10°C . Water saturated with CO_2 under pressure can take up 3 g. of CaCO_3 per litre. When the CO_2 is expelled by boiling, the CaCO_3 separates out again, hence the furring of kettles, etc. (see under **Water Softening**, p. 172, *et seq.*).

CaCO_3 when heated to redness decomposes to CaO and CO_2 (see above, under **Lime**).

The tension of dissociation of the CaCO_3 is 27 mm. at 547°C ., 46 mm. at 610°C ., 56 mm. at 625°C ., 245 mm. at 740°C ., 678 mm. at 810°C ., 753 mm. at 812°C ., 1,333 mm. at 865°C . The dissociation is aided by a current of steam or air.

Heated in a closed vessel, CaCO_3 fuses and solidifies to a marble-like calcite.

Calcium Chloride, CaCl_2 , occurs as a by-product in the ammonia soda process, in the Weldon chlorine process, in the manufacture of potassium

chlorate, in the preparation of CO_2 gas from CaCO_3 and HCl for mineral water manufacture, as a decomposition product of bleaching powder, and in making potassium nitrate from calcium nitrate.

Anhydrous CaCl_2 is prepared by heating the hydrated salt, $\text{CaCl}_2 \cdot 6\text{H}_2\text{O}$, which is deposited on evaporating the solutions. Anhydrous CaCl_2 is a white porous mass, which fuses at a red heat (755°C). The porous chloride obtained by drying the crystals at 200° is best for use as a desiccator, since heating in air to redness causes partial decomposition of calcium chloride, with formation of oxychloride. CaCl_2 dissolves in alcohol (at 80°C ., 100 alcohol dissolves 60 of CaCl_2), and takes up NH_3 to form $\text{CaCl}_2 \cdot 8\text{NH}_3$. It is also very deliquescent and soluble in water.

Temperature $^\circ \text{C}$.	100 g. H_2O Dissolve g. CaCl_2 .	1 g. CaCl_2 Needs for Solution g. H_2O .
0	49.6	2.016
10	60.0	1.667
20	74.0	1.351
30	93	1.075
40	110	0.909
60	129	0.775
80	142	0.704
99	154	0.649

Gerlach (*Z. Analyt. Ch.*, 1887, 26, 413) gives the following B.P.'s for the solution of CaCl_2 :—

To 100 g. H_2O g. CaCl_2 .	B.P. $^\circ \text{C}$.	To 100 g. H_2O g. CaCl_2 .	B.P. $^\circ \text{C}$.
6	101	178	150
21	104	222	160
41	110	268	170
69	120	292	175
101	130	305	178
137.5	140		

The following gives the sp. gr. of solutions of CaCl_2 :—

g. CaCl_2 in 100 H_2O - - - -	6.97	12.58	23.33	36.33	50.67	62.90
Sp. gr. 19.5° (H_2O at 19.5°C . = 1) -	1.0545	1.0954	1.1681	1.2469	1.3234	1.3806

Uses.—On small scale as a drying agent. On large scale it is never used in drying towers, as the regeneration of the CaCl_2 is too costly. H_2SO_4 is, therefore, used in drying towers. The solution is used, instead of brine, as a refrigerating liquid (see p. 79).

It is applied as a dust-laying solution for roads. Attempts to utilise it for the preparation of hydrochloric acid, chlorine, and bleaching solutions proved uneconomical.

The Gesellschaft f. Stickstoffdünger, D.R.P. 198,706 (1909), used CaCl_2 for aiding the development of NH_3 from cyanamide.

CaCl_2 has been used for aiding the fixation of atmospheric nitrogen (see p. 477), but the process seems to have been given up.

Calcium sulphate, gypsum, and plaster of Paris are discussed on p. 345.

Calcium carbide, CaC_2 , is discussed in Vol. II. of this work.

Calcareous cements, see Vol. II. of this work.

MAGNESIUM SALTS

Magnesium chloride, MgCl_2 , see pp. 330 and 366.

Magnesium oxide, MgO , see this Volume, p. 366.

Magnesium carbonate (magnesite) occurs native, also combined with calcium carbonate as dolomite, $\text{MgCO}_3 \cdot \text{CaCO}_3$.

The hydrated carbonate, $\text{MgCO}_3 \cdot 2\text{H}_2\text{O}$, is formed by precipitating a magnesium salt with an alkaline carbonate. The amorphous precipitate is decomposed by water into a basic carbonate of the composition $5\text{MgO} \cdot 4\text{CO}_2 \cdot 11\text{H}_2\text{O}$.

Magnesium alba is a basic carbonate of varying composition produced by precipitating MgCl_2 or MgSO_4 with sodium carbonate.

Magnesium carbonate dissolves to some extent in water containing CO_2 dissolved. Thus at 19.5°C ., under 1 atmos. CO_2 , 1 litre of water dissolves 25.79 g. MgCO_3 . When the CO_2 is at 9 atmos. pressures some 56.59 g. MgCO_3 is taken up.

SECTION XXXI

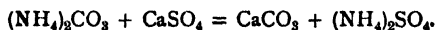
THE GYPSUM INDUSTRY

BY JAMES SHELTON, F.I.C.

LITERATURE

- Imperial Institute.—“The Mineral Industry of the British Empire.” 1930-1932.
- E. C. ECKEL.—“Cements, Limes and Plasters.” New York, 1905.
- W. F. JENNISON.—“Report on Gypsum Deposits.” Canada Department of Mines, Ottawa, 1911.
- F. A. WILDER.—“Iowa Geological Survey,” Vol. XII., Annual Report for 1901. Des Moines, U.S.A., 1902.
- A. VAN ZWALUWENBURG.—“The Mineral Industry,” 1906, Vol. XV. New York and London, 1907.
- Dr HANS KUHL.—“Chem. Technologie der Neuzeit.” Stuttgart, 1910.
- W. A. DAVIS.—“The Nature of the Changes Involved in the Production and Setting of Plaster of Paris,” *J.S.C.I.*, 1907, Vol. XXVI., pp. 727-738.

THE mineral gypsum, which consists essentially of hydrated sulphate of lime, $\text{CaSO}_4 \cdot 2\text{H}_2\text{O}$, is extensively excavated as the raw material for that class of cements known as the plasters. A considerable amount of this mineral is consumed by the manufacturers of Portland cement, as it is common practice to add about 2 per cent. of gypsum to their product to increase its time of set. In some localities gypsum is ground and sold under the name of **land plaster**, which is a particularly valuable soil dressing, as it neutralises any harmful alkalis such as “black alkali” (Na_2CO_3) and carbonate of magnesia. It also promotes the growth of leguminous plants, favours nitrification in soils, and accelerates the decomposition of zeolites, making the potash available as a plant food. The consumption for agricultural purposes is decreasing, owing to the increased use of superphosphate which contains calcium sulphate. Gypsum, if scattered about stables on decaying manure, serves to fix the ammonia liberated by putrefaction thus:—



Under trade names, such as “terra alba,” “annaline,” and “satinite,” a certain amount of the purer forms of gypsum is employed by paint manufacturers for admixture with pigments (see **Martin's** “Industrial Chemistry: Organic,” under “Pigments”). For this purpose it is finely ground with air separation, so that all passes a sieve with 74 meshes to the lineal inch, and about 80 per cent. passes a sieve with 200 meshes per lineal inch. Gypsum is also used as a flux in smelting oxidised ores for matte, the sulphate being reduced in the furnace to sulphide, and this furnishes sulphur for combination with the metals and lime to slag off the siliceous gangue.¹

¹ “The Behaviour of Calcium Sulphate at Elevated Temperatures with some Fluxes.” Hofman and Mostwitsch, American Institute of Mining Engineers.

The following figures from "The Mineral Industry" show the disposal of the gypsum production of the United States for the year 1908 :—

	Quantity in Short Tons.	Value in \$.
<i>Sold Crude</i>		
For Portland cement	187,680	305,745
„ paint material	1,281	1,300
„ plaster material	29,516	77,860
As land plaster	37,972	91,833
For other purposes	7,484	11,630
<i>Sold Calcined</i>		
For dental plaster	174	636
As plaster of Paris, wall plaster, etc.	1,074,229	3,508,520
To glass factories	14,412	41,102
For Portland cement and other purposes	36,802	99,934
	1,389,550	4,138,560

The rock gypsum of the plaster manufacturer is a soft mineral, easily scratched by the finger nail. Its specific gravity is 2.3, and its colour, owing to natural impurities, varies from white to brown. It occurs in extensive beds, which are often interstratified with limestone and argillaceous rock. A deposit consisting of small grains of gypsum disseminated through an earthy mass is known as **gypsite**, and this is in some localities collected by ploughing or disc harrowing, and scraping, and used for the production of wall plasters. A deposit of pure gypsite powder as fine as flour occurs at Laromie, Wyoming, in a bed of an average thickness of 7 ft., which is covered by only a few inches of soil. Of rarer occurrences is a form of gypsum called **alabaster**, which is a fine-grained, semi-transparent stone, specially valuable for ornamental carvings. Crystals of gypsum, to which the name **selenite** is given because of their pearly lustre, are often found in beds of gypsum and clay. Calcium sulphate having no water of crystallisation, and consequently called **anhydrite**, sometimes occurs in rocky deposits, but these are of no use to the plaster manufacturer, and its presence depreciates the value of a gypsum bed.

The hill of Montmartre near Paris was the first large deposit of gypsum to be exploited, but now deposits of economic importance are found widely distributed throughout the world. Great Britain has gypsum beds in Nottinghamshire, Derby, Stafford, Cumberland, and Westmoreland.

Gypsum occurs in most of the States of America, plaster mills being in operation on a large scale in the States of New York, Ohio, Iowa, California, Michigan, Texas, Kansas and Oklahoma. In Canada, gypsum beds are of common occurrence especially in Nova Scotia, New Brunswick, British Columbia, Manitoba, and Ontario. The Harz Mountains are the seat of the plaster industry of Germany. Large deposits are found in Algeria, and beds of minor importance occur in Cyprus and in Switzerland. Deposits of the purest form of alabaster are found in Italy near Leghorn.

The following figures from "The Mineral Industry, 1911," show the production of crude gypsum in the principal countries of the world during the year 1910 :—

	1909.	1910.	1911.
	Metric Tons.	Metric Tons.	Metric Tons.
United States	2,042,286	2,158,756	2,018,770
France	1,655,672	1,980,804	...
Canada	398,290	481,941	458,652
United Kingdom	242,832	259,648	...
Baden and Bavaria	88,251	95,475	...
Algeria	36,250	60,625	...
India	6,678	...
Greece	191	249	...

For more recent statistics see publications of the Imperial Institute.

The value of a gypsum deposit depends on its purity, location with regard to markets for gypsum or plaster, and the ease with which the deposit can be worked. The relatively pure deposits averaging 98 per cent. gypsum are utilised either for the manufacture of plaster of Paris, and hard finish plasters, or are sold to the Portland cement manufacturers. The pottery and plate glass trades are the largest consumers of plaster of Paris, so these manufacturing centres provide the best outlet for the product of the plaster mill.

All densely populated areas provide a market for plaster of Paris and wall plasters but, as with all builders' materials, the demand is liable to fluctuate. With regard to location it must be remembered that the finished product is heavy, so that cost of carriage is an important consideration. Deposits of rock gypsum are opened out by quarrying, and then if the overburden to be removed is large in proportion to the thickness of the deposit, the working is continued by mining. In this connection it may be remarked that the cost of mining is roughly double that of quarrying. Gypsum fetches 6s. to 10s. per ton in England, and the average price in New York is about 2½ dollars per ton.

The preparation of plasters is simply a process of dehydration of gypsum by heat, and is fully described under "Calcareous Ovens" (see Vol. II. of this work).

Plaster of Paris is the name given to the hemihydrate $(\text{CaSO}_4)_2\text{H}_2\text{O}$, which is produced by heating the purer forms of gypsum at a temperature of about 190° C. A temperature of 107° C. is all that is really necessary for producing the hemihydrate, but it is found to be more economical in fuel and time to remove the water at the highest allowable temperature.

Plaster of Paris owes much of its utility to the fact that when mixed with a third of its weight of water it takes under ten minutes to form a solid mass of interlocking acicular crystals of hydrated sulphate of lime, $\text{CaSO}_4 \cdot 2\text{H}_2\text{O}$. The preparation and setting of plaster of Paris is well expressed by the equation $2\text{CaSO}_4 \cdot 2\text{H}_2\text{O} \rightleftharpoons (\text{CaSO}_4)_2\text{H}_2\text{O} + 3\text{H}_2\text{O}$.

Wall plasters are manufactured by heating the less pure forms of gypsum at a temperature somewhat above 200° C.

They take about two hours to set, but this period is still further increased by the addition of colloidal substances to the calcined gypsum before it is put on the market for the preparation of wall plasters. It is suggested by Grimsley that colloids retard the process of crystallisation by keeping the molecules apart. In this connection it is interesting to note the use of colloidal bodies in boiler compositions. The hard scale formed on boilers using sea water is a crystalline deposit of hydrated sulphate of lime, and the introduction of colloidal bodies into the boiler hinders this crystallisation, causing the sulphate of lime to be deposited as a soft scale which is easily removable.

Above 200° C. the hemihydrate gradually loses its water, and is converted into an anhydrous product which sets slowly with water, and is known as **soluble anhydrite**.

As the temperature is raised so the time of set is lengthened, thus between 400° and 750° C. a product is obtained which has hardly any setting properties (Glasenapp, *Vonind. Zeit.*, 1908, 32, pp. 1148-1152, 1197-1202, 1230-1235). It is stated by Wilder ("Iowa Geological Survey," 12, 1902, p. 221) that 500° C. is the temperature at which the flooring plaster known as **estrichgips** is calcined. Experiments conducted by Beyer and Williams (*loc. cit.*) showed that the plasters obtained by heating at 450°-500° C. for periods of one to four hours set with water, and at the end of thirty-nine days briquettes gave a tensile strength of 290 lbs. per square inch. The samples heated at this temperature for a longer period than four hours showed little tendency to set. Glasenapp gives 750° C. as the temperature at which flooring plaster begins to form, and states that 900° C. to 1,000° C. is the usual temperature at which flooring plaster is burnt, and that when heated above this temperature the content of basic sulphate increases, but the material does not lose its power to set. He thus differs from Van't Hoff and Just ("Sitzungsberichte der 'vgl. preuss. Akad. der Wissenschaften," 1903, B. i., pp. 249-258), who found no evidence in support of the statement that after "dead burning" a plaster, further heating to high temperatures confers setting properties on the material. As, however, Glasenapp also contradicts the statement that flooring plaster occurs in needle-shaped crystals resembling the dihydrate, and states that **estrichgips** sets with water without alteration of form, apart from the production of small quantities of the dihydrate and of calcium hydroxide, it is quite possible that two forms of **estrichgips** are manufactured.

When dehydrated gypsum has been treated with a solution of some catalyst such as alum, or borax, it can be reburnt at a red heat without in any way losing its setting properties.

Hard finish plasters are prepared in this manner, and they set slowly with water to a hard mass of crystals of the dehydrate.

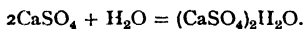
When plaster of Paris is shaken for a few minutes with excess of water, and the insoluble matter rapidly filtered off, the clear solution on allowing to stand soon becomes cloudy owing to the deposition of crystals of gypsum (Marignac, *Arch. Sci. Phys. Nat.*, 1873, 48, p. 120).

This simple experiment shows that the setting of plaster of Paris is simply a process of dissolving the hemihydrate to form a solution, which, being supersaturated with regard to the dihydrate, deposits this substance in interlacing groups of crystals. The water added dissolves hemihydrate. This solution being supersaturated with regard to dihydrate deposits crystals of the latter substance. The solution is now free to dissolve more hemihydrate, and this process goes on until the conversion to dihydrate is complete, and thus, by the use of a small quantity of water, a compact mass is made. This reaction goes on more slowly with the hard finish plasters, but the process of reaction is exactly the same. Van't Hoff states that flooring plasters set in the same manner, but Glasenapp says that flooring plasters set without change of form.

The manufacture of Plasters is discussed in detail in Vol. II. of this work, under **Calcareous Cements**.

Analysis. The ordinary chemical examination of plasters consists in the determination of the amounts of lime, magnesia, iron and alumina, silica, sulphate, carbonate, sulphide (if any), and water. The percentage of water present is certainly an indication of the extent of dehydration, but it does not show if this dehydration was carried out uniformly. The following experiments recommended by Frey (*Zonind. Zeit.*, 33, pp. 1229, 1230) may therefore be of use:—

To determine the soluble anhydrite, 5 g. of the plaster are allowed to stand over water for seven days, whereby the soluble anhydrite is converted into hemihydrate—



The increase in weight, after drying the sample to constant weight at 70° C., when multiplied by 272/18, gives the weight of soluble anhydrite. 5 g. of the sample dried at 60° C. are made into a thin paste with water, which after half an hour is evaporated at 70° C. The increase of weight is due to conversion of hemihydrate and soluble anhydrite to the dihydrate. The gain in weight of the soluble anhydrite is given by multiplying the amount present by 36/136. Subtraction then gives the gain in weight of the hemihydrate, and this gain multiplied by 290/54 gives the amount of hemihydrate present.

Determination of Flooring Plaster.—For this estimation Frey recommends repeating the above experiment, but leaving the paste in moist air for seven days instead of half an hour before drying to constant weight at 70° C. After subtracting the gain in weight found in the previous experiment, the remainder multiplied by 136/36 he calls the weight of flooring plaster present.

Physical Tests are essential if one wishes to obtain a good idea of the value of a plaster. The German Plaster Standards Committee (*Chem. Zeit.*, 1911, 35, p. 222) recommend the following determinations:—

Fineness—by estimating the residue not passing a sieve with 900 holes to the square inch.

"Gauge"—the amount of plaster required to make a good slip with 100 c.c. of water. This is determined by slowly adding plaster to 100 c.c. of water contained in a weighed beaker. The addition of plaster is stopped as soon as the plaster floats and the water mirror remains obscured for a few seconds. The beaker and contents are then weighed.

"Slip."—The sample gauged with the proper amount of water as found in the previous experiment is poured on to a glass plate in pats 6 mm. deep and about 11 mm. in diameter. The time of slip is the time that elapses between the gauging of the plaster, and the time when the plaster sets to such a condition that a knife with an edge of 2 mm. fails to cut its way through the pats.

"Setting Time."—Pieces are cut off the above pats at intervals of a minute, until the plaster is shown to be set by its friable and granular condition.

Tensile Strength.—This is estimated on briquettes of the ordinary shape, 5 sq. cm in cross section, which are broken in a machine similar to that used for Portland cement (which see).

In addition to these tests the following determinations may be useful:—

Specific Gravity.—Performed as with Portland cement, using a liquid such as kerosine or turpentine.

Apparent Specific Gravity.—The weight of plaster required to loosely fill a cubic foot measure is found as with Portland cement.

Trial pats should be made on a glass plate and examined. If a straight scratch is made with a knife on underside of the pat the plaster should break along this scratch like glass cut with a diamond.

The tensile strength of the plaster mixed with three parts of standard Leighton Buzzard sand gives an indication of the adhesive power of the plaster.

Several sieves should be used to obtain an accurate estimate of the fineness.

Determinations of crushing strength of the plaster neat and with standard sand are sometimes made. A measure of the contraction on setting might sometimes be useful.

The results of series of tests of various American cement plasters, carried out by Professor Marston in 1900, are given in the annual report ("Iowa Geological Survey," 12, p. 162).

For the results of experiments on the compressive strength of plasters, both neat and mixed with sand, see "Tenth Annual Report," Wyoming College of Agriculture and Mechanics.

Uses.—The best quality plaster of Paris is used by the plate glass and pottery manufacturers. The former use it as an adhesive to fix the sheet glass on the polishing beds, and frequently calcine the once used plaster, and use it a second time. The latter use plaster for moulds, and these losing their sharp outlines with use frequently have to be renewed.

A good quality of plaster of Paris is used in internal decorations for mouldings, ceilings, and plaster casts. For these purposes it is often toughened by the addition of tow, and this mixture is known as "staff."

Less pure is the product employed for wall plasters. The plaster comes from the manufacturer mixed with retarder, and hair, or wood fibre. Near the building centre clay or dried sand is added, and the mixture is then applied to walls on a foundation of either lath or on wire netting. Gypsum boards used for partitions are prepared by pouring a mixture of calcined plaster, sawdust, and water on to an iron slab on which jute and rushes are strewn. Fire-proof slabs are made with asbestos and calcined plaster. Small amounts of plaster are used for the preparation of imitation marble and chalcedony.

SECTION XXXII

BARIUM SALTS

BY FRANK E. MILSOM, B.Sc.

BARIUM is a metal of the alkaline earth series, occurring next to strontium. It has the atomic weight, 137.4.

The compounds generally resemble those of its congeners, calcium and strontium; for example, it forms an insoluble sulphate, soluble chloride, etc. It imparts a fine grass-green colour to the Bunsen flame.

Barium occurs native as the **carbonate**, BaSO_3 , "**witherite**," and the sulphate, BaSO_4 , "**heavy spar**" or "**barytes**." Both the names of the sulphate are in allusion to the great density of the mineral. This is 4.5, whereas that of most other non-metallic minerals is about 2.5.

It crystallises in rhombic forms, isomorphous with anhydrite and celestine. Its great insolubility renders it extremely useful for the detection of both "Ba" and " SO_4 " ions in solution.

"**Witherite**" crystallises in forms of the rhombic system, and is isomorphous with aragonite and strontianite.

In 1932 the United Kingdom produced about 62,000 tons of barytes, Prussia 100,000 tons, and the United States 119,000 tons.

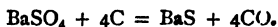
Barium salts generally crystallise well, and for this purpose are used in organic analysis of acids, the barium salt being evaporated and ignited with sulphuric acid and the residue of barium sulphate weighed.

The green coloration which barium salts impart to flame is utilised in pyrotechny.

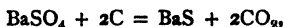
Barium Chloride, $\text{BaCl}_2 \cdot 2\text{H}_2\text{O}$.—Barium chloride is one of the most important of the barium salts. It is a colourless compound, and crystallises with two molecules of water of crystallisation, which it loses only at a fairly high temperature. Unlike the chlorides of calcium and strontium, barium chloride keeps its neutral reaction on dehydration.

It is manufactured chiefly from heavy spar. Two methods are commonly used:—

1. Finely powdered heavy spar is mixed with coal and strongly heated in a furnace. Decomposition occurs according to the equation:—



According to Mostowitsch (C.B., 1909, 1838) the reduction takes place at 600° as follows:—



and at 800° C. according to the first equation.

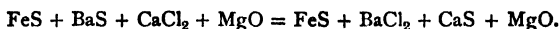
2. Another method is the heating of a mixture of 100 parts BaSO_4 , 40 parts charcoal, 20 parts limestone, and 50 parts calcium chloride in a reverberatory furnace. On cooling, the mass is lixiviated with water, which dissolves out the barium chloride.

According to the D.R.P., 129,063, of 25th November 1900, barium chlorate can be prepared from the dross obtained in the manufacture of copper as follows.

The mineral, which consists of iron, calcium, and barium sulphides, is treated with magnesium chloride solution, obtained as a by-product in the manufacture of potassium chloride. By heating the mixture to 70° C. the following reaction occurs:—



When the evolution of H_2S ceases, a current of air is passed to displace the rest of the H_2S , and the residue heated to 600° - 700° C. The following reaction occurs:—



By lixiviation of the mass, barium chloride can be obtained.

Heinz (D.R.P., 186,738, of 3rd January 1907) prepares it by the decomposition of barium sulphide with magnesium chloride under pressure in autoclaves.

Barium Nitrate, $Ba(NO_3)_2$.—Barium nitrate is the salt of barium, most used in pyrotechnics (see **Strontium**).

It crystallises anhydrous.

It is manufactured from witherite by dissolving the latter in nitric acid and crystallising.

It is also prepared by the fractional crystallisation of a mixture of barium chloride and sodium nitrate. Barium nitrate being much less soluble than sodium chloride (100 parts water dissolve about 9 parts at 18° C.), crystallises first.

According to Schreiber (D.R.P., 153,498, of 1st June 1902), it can be prepared by evaporating *in vacuo* crude barium sulphide liquor, thereby obtaining a strong solution of barium sulphhydrate, and decomposing this in the cold with a concentrated solution of alkali nitrate. Fractional crystallisation of the mixture yields barium nitrate.

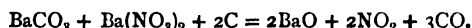
Hellmers (D.R.P., 204,476, of 7th December 1907) manufactures it by the decomposition of barium oxalate or phosphate with crude saltpetre under pressure.

Barium Oxide, BaO .—This, the lower oxide of the two commonly known oxides of barium, was used in the oxygen industry (*vide infra*).

It can be prepared as a porous solid by heating barium nitrate (P. Martin: D.R.P., 128,500, of 30th December 1900) in a muffle furnace.

Another method used on a large scale consists in heating witherite with lamp-black, and heating to 1200° C. About 8 per cent. of lamp-black is suitable (D.R.P., 104,171, of 27th November 1898; 108,255, of 16th September 1898).

Siemens & Co. (D.R.P., 158,950, of 31st May 1903) prepare it by the reduction of a mixture of barium carbonate or nitrate with carbon, by heating in an electric furnace to a white heat—



Barium Hydrate.—By the addition of the calculated quantity of water to barium oxide, $Ba(OH)_2$ is obtained.

Barium hydrate, however, crystallises from its solutions similarly to strontium hydrate, with 8 molecules of water.

It is manufactured by mixing barium nitrate solution with caustic soda solution of sp. gr. 1.10-1.15, and crystallising.

Commercial barium hydrate is made by igniting heavy spar with coal, and heating the resulting mixture first in a current of moist carbon dioxide, and then in a current of superheated steam.

It has a great use in the detection and estimation of carbon dioxide, for example, in air. It is soluble about 4 parts in 100 of water at the ordinary temperature.

Barium Peroxide, BaO_2 .—Barium peroxide is used both in the preparation of hydrogen peroxide and also of oxygen.

It is prepared by heating barium oxide to dull redness in a stream of oxygen or air free from CO_2 .

To purify it a mixture with water is acidified with hydrochloric acid, the mixture filtered, and a little baryta added, the solution filtered again and excess of baryta added, whereby the pure peroxide is obtained.

Barium peroxide can be obtained anhydrous, and also forms a crystalline hydrate.

Brin's oxygen process (now obsolete) consists in passing a stream of air free from CO_2 over barium oxide heated to 500° - 600° C. When oxidation is complete the pressure is reduced to 65 cm., when oxygen is evolved of 97-98 per cent. purity.

Other Barium Compounds.—Barium sulphide, BaS , is obtained by the ignition of heavy spar with carbon. With water it forms a mixture of hydrate and sulphhydrate thus:—



It is used in the preparation of phosphorescent substances. For example, "Bolognian phosphorus" is obtained by heating barium sulphate with powdered carbon, finally with a blowpipe, and sealing up hot. It phosphoresces in the dark with an orange light.

SECTION XXXIII

STRONTIUM SALTS

BY FRANK E. MILSOM, B.Sc.

STRONTIUM occurs naturally as the carbonate, **strontianite**, SrCO_3 , and as sulphate, **celestine**, SrSO_4 .

The carbonate crystallises in forms of the rhombic system, isomorphous with aragonite (one of the naturally occurring forms of calcium carbonate). A form isomorphous with Iceland spar is not known.

Celestine is so called from the fact that it is frequently found coloured blue by impurities. It also crystallises in forms of the rhombic system, and is isomorphous with anhydrite (CaSO_4 , see "Stassfurt Deposits," p. 329).

Both these substances are used as raw products for the manufacture of other strontium compounds.

Strontium is allied to **barium** and **calcium**, and comes in properties midway between them. Its atomic weight is 87.6.

The fine red colour which strontium gives in the Bunsen flame is well known, and is made the basis of the use of strontium salts in pyrotechny.

Metallic strontium can be obtained by electrolysis of the fused chloride, and can also be got by the action of sodium amalgam on a concentrated solution of the chloride. A strontium amalgam is thus formed, and by distilling off the mercury in a current of hydrogen, the metal can be obtained pure.

Strontium Oxide, SrO .—This can be easily obtained from strontianite.

The moist and finely powdered mineral is subjected to the action of superheated steam and is then ignited, when carbon dioxide is given off and the oxide formed.

Strontium Hydroxide, $\text{Sr}(\text{OH})_2 \cdot 8\text{H}_2\text{O}$.—This is similar in properties to baryta. It is readily soluble in hot, but sparingly (1 in 50) in cold water. A solution is termed strontia water, and is quickly acted upon by atmospheric carbon dioxide, becoming cloudy.

It is manufactured, according to Niewerth (D.R.P., 251,191), by the action of carbon on strontium sulphite.

Celestine is mixed with an equal weight of coal and brown iron ore, and the mixture roasted. After roasting is complete the mass is lixiviated with water. Ferrous sulphide and strontium hydroxide are produced.

Claus (D.R.P., 25,382) prepares it by the interaction of strontium chloride and barium hydrate and fractional crystallisation, or by the action of barium hydrate and strontium sulphide. (Strontium sulphide is prepared by the reduction of strontium sulphate with carbon.)

Seplay (D.R.P., 254,436) heats strontianite with superheated steam, as mentioned above.

Lee Patterson's process (English Patent, 16,989, 1884) consists in blowing air heated to a temperature of 100° F. through a mixture of manganese dioxide and strontium sulphide.

Trachsel gives the following detailed process:—

Celestine is crushed and mixed with coal in the proportion of 7 cwt. coal to 20 cwt. mineral. The mixture is then calcined. Steam is next blown through the mixture, until the resulting liquor has attained a density of 24° Tw. It is allowed to settle, and the still hot, clear liquid treated in crystallising tanks with caustic soda, and allowed to crystallise. The mother liquors containing sodium sulphhydrate are concentrated to 30° Tw., and again crystallised.

Strontium Dioxide, SrO_2 .—This is similar in properties to barium dioxide.

Strontium Chloride, SrCl_2 , is prepared by strongly heating a mixture of strontium sulphate, calcium chloride, and carbon.

The product consists of calcium sulphide and strontium chloride, and is crystallised from water.

It is similar in properties to barium chloride.

Strontium Nitrate, $\text{Sr}(\text{NO}_3)_2$.—This salt crystallises anhydrous, and is readily soluble in water; it is used in pyrotechny (see below).

Applications.—Strontium compounds have several important commercial applications, of which the two chief are their use in the sugar industry and in pyrotechny.

Strontium hydroxide forms insoluble saccharates with sugar. These are easily decomposed by carbon dioxide with regeneration of the sugar. These facts are made use of in refining beet sugar (see **Martin's "Industrial Chemistry: Organic,"** p. 164).

As mentioned above, the use of strontium compounds in the manufacture of fireworks is the fine red colour which they impart to flames.

For this purpose they are mixed with potassium chlorate or nitrate, sulphur, and charcoal.

The following are typical formulæ for red stars in rockets, Roman candles, etc. :—

Potassium chlorate -	16	8 pts.
Sulphur -	5	6 "
Charcoal -	1	1 "
Strontium nitrate -	16	16 "
Shellac -	1 "

For red fires an admixture with magnesium filings is made, the following being a formula :—

Potassium chlorate -	2 pts.
Sulphur -	2 "
Charcoal -	1 "
Magnesium filings -	2 "
Strontium nitrate -	8 "

For more rapidly burning fires, aluminium powder mixed with calcium or magnesium peroxides is added. Strontium carbonate is sometimes substituted.

Statistics—

PRODUCTION OF STRONTIUM MINERALS

(Long Tons)

Producing Country and Description.	1930.	1931.	1932.
BRITISH EMPIRE			
United Kingdom—			
Celestite - - - -	5,141	4,052	6,852
FOREIGN COUNTRIES			
Germany (Prussia)—			
Strontianite - - - -	359	128	64
Tunis—			
Strontium minerals - -	500

SECTION XXXIV

COMPOUNDS OF BORON

BY FRANK E. MILSOM, B.Sc.

LITERATURE

THORPE'S "Dictionary of Applied Chemistry."
DAMMER'S "Chemische Technologie der Neuzeit."
"British Pharmaceutical Codex," etc.

INTRODUCTION

THE earliest identification of boron salts was from the "soffioni" of Tuscany. These are hot springs from which steam containing a small amount of boric acid issues. By the condensation of this steam small marshes are formed which are more or less impregnated with boric acid.

Boric acid was first discovered in these "soffioni" in 1777, and the manufacture of boric acid was first commenced in 1815.

By far the larger part of the boric acid and borax of commerce is to-day, however, manufactured from mineral deposits.

The chief of these minerals are:—

Boronatrocaltite, now more commonly called *Ulexite*—



Pankermite— $\text{Ca}_2\text{B}_6\text{O}_{11} \cdot 4\text{H}_2\text{O}$.

Colemanite— $\text{Ca}_2\text{B}_6\text{O}_{11} \cdot 3\text{H}_2\text{O}$.

Of less importance are—

Boracite— $2\text{Mg}_3\text{B}_8\text{O}_{16} + \text{MgCl}_2$.

Pinnoite— $\text{Mg}(\text{BO}_2)_2 \cdot 3\text{H}_2\text{O}$.

Hydroboracite— $\text{CaMgB}_6\text{O}_{11} \cdot 6\text{H}_2\text{O}$.

Boric Acid.—Boric acid, as found in commerce, has the formula H_3BO_3 or $\text{B}(\text{OH})_3$. It usually occurs in two forms, viz., in powder and crystals. Both the powder and the crystals have a soapy feeling, somewhat resembling "French chalk." The crystals form characteristic scaly masses.

Boric acid has a great use in medicine as a mild antiseptic.

It also is greatly used as a preservative, sometimes illegally.

The process of extracting the boric from the "soffioni" is as follows:—The latter are surrounded by basins of stone, arranged in tiers. In these basins a dilute and very impure solution of boric acid collects.

The contents of the basins are allowed to pass into settling pans, where most of the mud and debris is deposited. It is then drawn off into lead-lined evaporating pans, about 20 ft. long by 10 ft. broad. These are heated by means of the hot gases of the "soffioni," which have no use otherwise. The liquid deposits much gypsum in the course of evaporation, and this must be separated.

The clear solution is then allowed to crystallise for twenty-four hours. The crystals are then drained and dried.

The boric acid thus obtained is very impure, and usually contains about 75.80 per cent. H_3BO_3 .

One or two more crystallisations, however, render it pure.

By far the larger quantity of boric acid, however, is made from the boron-containing minerals.

Colemanite and **Pondermite** are found in large quantities in California in the "Death Valley" and **Mohare Desert**, of which they form layers of 5 to 30 ft. in thickness, mixed with much earthy matter.

The biggest company mining these deposits is the **Borax Consolidated Co. Ltd.** (The Pacific Coast Borax Co.).

The ore, which contains 35 per cent. or more of boric acid, is sent to Bayonne to be worked up; poorer ore is roasted on the spot, and siliceous matter and potassium carbonate separated. The concentrated material, containing 45 per cent. or more boric acid, is sent to Bayonne. 2.4 tons of poor quality ore give one ton of roasted ore.

Several processes are adopted for the manufacture of the pure acid from the raw mineral.

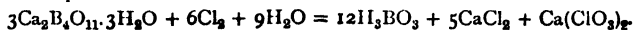
The one in most use consists in shaking the finely powdered ore in wooden vats with water, and leading in SO_2 until all the boric acid is set free. The solution is then filtered and evaporated in the sun in wooden vats. The crystals of boric acid which separate from this solution are 90 per cent. pure. They can be further purified by recrystallisation.

The preparation of boric acid from ulexite is carried on in Chile in a similar manner, using HCl or H_2SO_4 in place of the SO_2 .

A newer process consists in the use of $NaHSO_4$, which is a by-product in the manufacture of sodium nitrate.

Lots of 500 kg. of the finely powdered calcium borate mineral are boiled with a solution of 850 g. crude $NaHSO_4$ in a solution of $150^\circ C$. for one hour. The mass is filtered and the solution evaporated, when 450 g. boric acid crystallises out.

Another process by Moore (English Patent, 118,073, 18th March 1900) consists in the use of chlorine gas. The equation for this is:—



Statistics—

From the Tuscan industry:—

1828	-	-	-	-	-	50,000 kg.
1839	-	-	-	-	-	1,000,000 "
1859	-	-	-	-	-	2,000,000 "
1932	-	-	-	-	-	5,383,000 "

From mineral sources. The following amounts were produced:—

	1902.	1932.
California and Oregon	50,000 tons.	162,424 tons.
Chile	15,000 "	...
Peru	5,000 "	...
Bolivia	1,500 "	...

BORAX

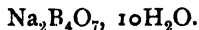
By far the most important salt of boric acid used in commerce is borax.

It consists of the sodium salt of the acid $H_2B_4O_7$, which may be supposed to be derived from orthoboric acid, thus—



Borax occurs on the market in four different forms, viz.—

(1) **Prismatic Borax.**—This is the common crystalline variety of the formula—



(2) **Octahedral Borax**, another crystalline variety with five mols. of water of crystallisation.

(3) **Burnt Borax** (Boraxosta).—This is crystalline borax with most of the water of crystallisation removed. It occurs as a white powder. Some samples personally examined during the past year contained from 4-20 per cent. water (crystalline borax contains 47 per cent.).

(4) **Borax Glass, or Nitrified Borax.**—This consists of borax with the whole of the contained water expelled and the residue fused. It forms a hard glassy mass of sp. gr. 2.36.

Borax is prepared on the large scale from ulexite (boronalrocalcite), colemanite, and pondermite.

Ulexite is found in a pure condition, mixed with sodium chloride and calcium borate, in Chile and Argentina. This quality of raw material is exported in large quantities by the International Borax Co. of Brussels, chiefly to their factories in Belgium and France.

Imports.	1907.		1908.	
	Tons.	Value in 1,000 Marks.	Tons.	Value in 1,000 Marks.
From Chile - - -	7,129	1,426	9,366	3,233
„ Peru - - -	4,959	992	4,956	1,873
Exports - - -	214	43	540	108

In 1932 the United Kingdom imported 8,773 tons borax and 10,208 tons of borates.

To prepare the pure borax, the finely ground raw mineral is first washed with water to free it from chlorides.

It is then placed with four times the quantity of water in a steam-heated boiler, and a mixture of sodium bicarbonate, with one quarter the quantity of sodium carbonate added. The mixture is heated three hours. The mass is then filtered, and the filtrate allowed to crystallise. From the crude mass of crystals the borax is separated by another crystallisation.

A similar process is followed in the case of colemanite and pondermite.

The borax in this case is separated into three qualities—

- (a) Refined crystals.
- (b) Refined screenings.
- (c) Granulated borax.

Other methods of preparation of borax are those of Masson and Tillière, involving the use of ammonium carbonate (D.R.P., 95,642; C.B., 1898, l. 648); Richmon and Rappe, using H₂SiF₆ (D.R.P., 96,196) and sodium phosphate (D.R.P., 98,759).

The great technical importance of borax depends on its use as a flux in soldering, and in the production of fusible glazes and enamels.

It is also used in analysis, owing to the fact that many metallic oxides dissolve in the glassy fused variety, with characteristic colours, *e.g.*—

Cobalt.	Chromium.	Violet.
Manganese.	Blue.	Green, etc.

Among other borates may be mentioned **manganese borate**. This may be produced by the interaction of boric acid and a manganese salt, and finds application as a paint dryer. It is a very quick dryer, being superior to BaSO₄ and PbCO₃, which are also used for the purpose.

Lead borate is used in glass manufacture.

Perborates are produced by the action of H₂O₂ on borates (*vide* p. 426).

Complex Boron Compounds.—Among these may be mentioned the **borosalicylates**, which are important diuretics, and the borocitrates, which are used in kidney diseases. These are complex compounds which boric acid forms with extreme readiness with organic acids.

Cadmium borotungstate is remarkable for the fact that its saturated solution has a very high specific gravity, *viz.*, 3.28.

SECTION XXXV

THE MANUFACTURE OF CHLORINE BY THE WELDON AND DEACON PROCESSES

BY GEOFFREY MARTIN, Ph.D., D.Sc. (Lond.)

LITERATURE

For a full account of the subject, including literature, see G. LUNGE, "Sulphuric Acid and Alkali Industry." 1915.

GEOFFREY MARTIN and E. DANCASTER give a full account of the properties of gaseous and liquid chlorine in Vol. VIII. of "Modern Inorganic Chemistry." Edited by Newton Friend. 1914.

See also HÖLBBING, "Fortschritte in der Fabrikation der Anorganischen Säuren, der Alkalien, des Ammoniaks und Verwandter Industriezweige." Berlin, 1905.

See also the references under "Deacon Process," p. 363; under "Electrolytic Chlorine and Alkali," p. 367; and under "Liquid Chlorine," p. 381.

UNTIL recently almost all the chlorine produced was made from hydrochloric acid, either by the Weldon or by the Deacon process, the hydrochloric acid for the purpose being obtained by treating salt with sulphuric acid (salt cake process). Within the last few years, however, more than half the world's supply of chlorine has been obtained by electrolysis of brine solutions, which latter method yields, according to slight alterations in the conditions of electrolysis, chlorine, chlorates, bleaching solutions, also caustic soda and sodium carbonate. An account of each of these methods will be given in due course.

The main use of chlorine is for the bleaching of paper and cotton. The oldest bleaching fluid put on the market was "Eau de Javel" (Paris, 1786), a solution of potassium hypochlorite. Later, this was displaced by the cheaper and more convenient solid "bleaching powder" (Tennant, 1799, in Glasgow), which at the present time is manufactured on a very large scale, and is sold under the trade names of "chloride of lime" and of "bleaching powder." More recently, after a century-long monopoly, a serious rival to bleaching powder has arisen in the electrolytically produced bleaching fluids ("electrolytic bleaching"), which are produced by electrolysis of brine on the place of use, because the liquids soon decompose on standing.

The main use of chlorine is, therefore, the production of these bleaching materials. However, large quantities of chlorine are now employed for chlorinating various organic products in the intermediate stages of synthetic dye production, the chlorine for the purpose being put on the market in a liquid form in steel cylinders.

The manufacture of chlorates of sodium and potassium has attained considerable importance, these products being used for the production of explosives and for oxidising purposes.

Statistics.—According to Bernthsen (1909) the world's production of bleaching powder is estimated at 300,000 metric tons yearly, Germany producing in 1905 some 85,000 tons, 50,000 of which were made from electrolytic chlorine. Europe at present produces some 9,000 tons of chlorates.

The following figures relating to German chemical industry are interesting as showing the great variations in price and quantities of the products, fluctuations traceable to the rise of electrolytic bleaching processes :—

Bleaching Powder :—

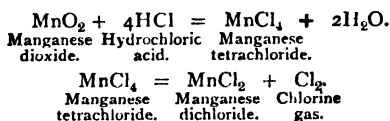
	1895.	1905.	1909.
Excess of export } over import. }	2,300 tons at 150 marks.	30,300 tons at 90 marks.	26,100 tons at 90 marks.

The German import of potassium chlorate is given by the following figures :—

	1895.	1905.	1909.
Excess of import } over export. }	75 tons at 820 marks.	1,020 tons at 530 marks.	100 tons at 620 marks.

The manufacture of chlorates is most advantageously carried out in countries provided with cheap water power, and the industry is rapidly developing on such sites.

The Weldon Process.—The process rests on the oxidation of hydrochloric acid by means of manganese dioxide. The exact nature of the reaction is disputed,¹ but is usually represented by the equations—



The manganese dioxide (pyrolusite, black oxide of manganese), MnO_2 , is largely mined in Spain and in the Caucasus mountains. It is impure, usually containing iron. Its value, technically, is judged by the amount of "available oxygen" it contains.

The available oxygen is estimated as follows :—

Manganese dioxide is dissolved in sulphuric acid in the presence of a known excess of ferrous sulphate. The amount of ferrous iron oxidised to the ferric state is then determined by volumetric titration in the ordinary way.

Another process is to heat the manganese dioxide with hydrochloric acid. Chlorine is evolved equivalent in value to the "available" oxygen. This chlorine is received in a solution of potassium iodide, and the iodine set free is then estimated by titration with sodium thiosulphate. For details of these processes books on chemical analysis should be consulted.

By a special process to be described the used manganese dioxide is recovered and used again, so that in practice the only natural manganese dioxide required is that needed to cover the unavoidable working losses, which usually amount to 3 per cent. on every 100 parts of bleaching powder made.

The working details of the process are as follows (see Fig. 1) :—

A is the chlorine still. It consists of a still made out of some 6 or 8 granite or sandstone slabs fastened together. The still is usually 9 or 10 ft. high and about 6 or 7 ft. in diameter. At the top is an earthenware inlet pipe, and at the bottom is a pipe for running off the manganese chloride liquors. A steam inlet pipe, encased in earthenware or sandstone, passes nearly to the bottom of the still, and allows its contents to be heated by live steam.

The calculated amount of hydrochloric acid² having been run into the still, the calculated amount of manganese dioxide in the form of recovered Weldon mud is allowed to gradually flow in, and chlorine gas is developed in a regular stream. When the action slackens the contents of the still are heated by live steam until the liquid boils, when the reaction $\text{MnO}_2 + 4\text{HCl} = \text{MnCl}_2 + \text{Cl}_2 + 2\text{H}_2\text{O}$ is completed. The hydrochloric acid will be almost completely used up if it is of the right strength, viz., 18°-20° Bé.

If, instead of Weldon mud (recovered manganese dioxide), natural manganese dioxide is to be used, the pyrolusite, broken into coarse pieces, is placed in a different still from that used for Weldon mud, being placed on sandstone or earthenware grids, and steam is then blown in.

¹ See discussion, Geoffrey Martin and Lancaster's "The Halogens."

² One cannot partially replace the HCl by H_2SO_4 , otherwise the Weldon recovery process becomes impossible.

As a rule, in big works several stills are in use at once, the chlorine being led into a common conducting pipe. In order to cut out any given chlorine still the following device is resorted to:— Each still has an exit tube *B* (Fig. 2), which communicates with the main chlorine conducting pipe *A* by means of a U tube shaped as in the figure, the tubes being joined up chlorine-tight through a water seal at *c*. When it is decided to cut off the chlorine generator connected with *B*, all that is necessary is to pour water down *e* so as to fill up the U tube with water.

When communication between *B* and *A* is to be reopened, the water in the U tube is run off by withdrawing the stopper *f*.

Some small factories (such as bleachers) generate their own chlorine in earthenware generators, such as that illustrated in Fig. 3. More usually, however, these small users buy chlorine in the liquid state (at less than 6d. per pound) in steel cylinders (see p. 381).

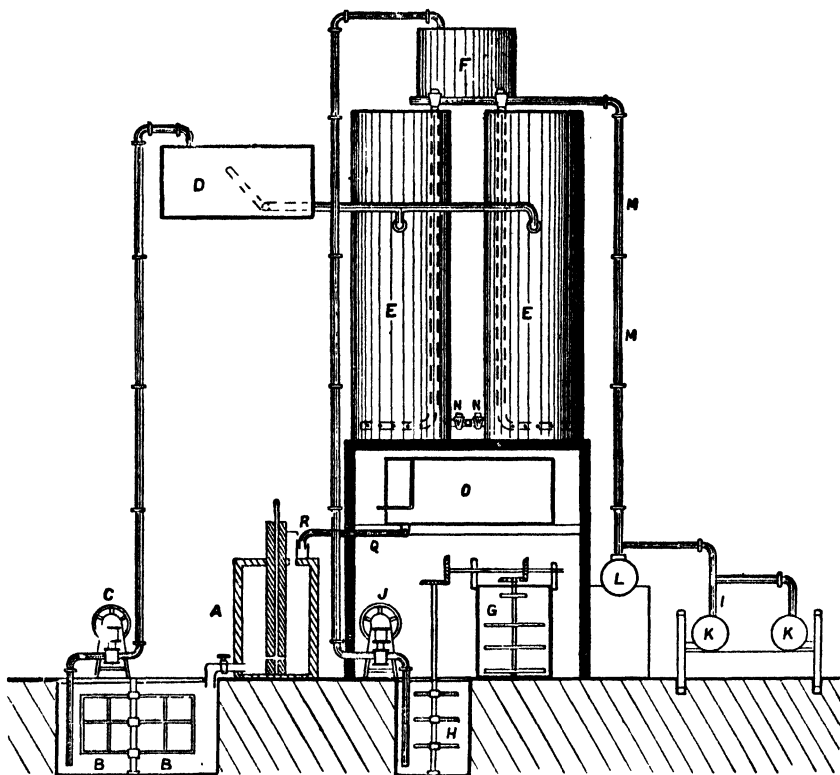


FIG. 1.—The Weldon Process of Chlorine Manufacture.

When the action is completed the acid manganese chloride liquors are run from the still *A* (Fig. 1) into the cemented tank *B*, which is provided with a mechanical stirring apparatus and a pump *c*. Here the liquid is neutralised with lime, Ca(OH)_2 , whereby iron hydroxide, Fe(OH)_3 , and other impurities are precipitated. The liquid is next raised by means of the pump *c* into the iron settling tank *D*. From here the clear manganese chloride liquors are run into the *oxidation towers* *E, E*. These are tall iron cylinders, some 30-40 ft. high and 6-7 ft. in diameter. Steam is blown in so as to raise the temperature of the contained manganese chloride liquors to 55°C ., and then the calculated amount of milk of lime is run in from the tank *F*.

The lime is slaked in the mixer *G*, thence the fluid mass is run into *H* and pumped up through the pump *J* into the lime tank *K*.

Meanwhile compressed air is blown into the towers *E, E*, issuing from perforated pipes placed near the bottom of the towers. *K* is the duplex blower, *L* the air

reservoir, and MM the air conducting pipe. The air is blown through the warm liquid for some four to five hours before the oxidation of the manganese present to manganese dioxide is complete.

The chemical mechanism of the action is not completely understood even after years of research. It seems that first of all the lime, Ca(OH)_2 , first precipitates manganous hydroxide, Mn(OH)_2 , thus:—



The Mn(OH)_2 , a white substance, will take up oxygen spontaneously from the air until it reaches the grade of oxidation Mn_2O_3 ; however, if excess of lime or NaOH is present, the oxidation will proceed further than this, and the manganese oxide will be oxidised almost completely to the MnO_2 state, forming a black body of composition varying between CaO.MnO_2 and CaO.2MnO_2 , so that the regenerated "Weldon mud" contains chemically united lime (CaO). It is remarkable that, apparently, a trace of CaCl_2 solution appears to be necessary before the complete oxidation will take place.

The action is carried out in such a manner that a "mud" containing as little CaO as possible is aimed at. The active component in the mud is, of course, the amount of MnO_2 present, each molecule of MnO_2 present corresponding to the evolution of 2 atoms of Cl .

The progress of the oxidation is followed by withdrawing samples of liquor at frequent intervals and titrating the blackening mud with ferrous sulphate solution and potassium permanganate.

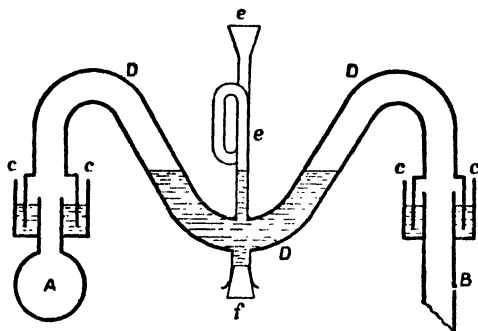


FIG. 2.—System of Connecting the Chlorine Pipes to the Chlorine Stills.

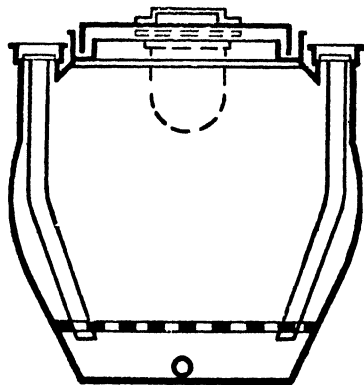


FIG. 3.—Small Chlorine Still.

Towards the end of the action the excess of lime is as far as possible got rid of by running in more manganese chloride solution so long as a precipitate of Mn(OH)_2 is caused by the free lime still remaining.

When the process of oxidation is known to be complete the Weldon mud is run out of the base of the towers E,K (by means of the stopcocks N,N) into the settling tank o. The mud settles to the bottom of this tank, whence it is run into the chlorine still A once more, and so used again. The aqueous liquors, principally containing calcium chloride (see equation above), is drawn off from the tank o, and either run to waste or worked up in some other manner.

No less than 70 per cent. of the total chlorine of the hydrochloric acid remains as a waste product in this calcium chloride, a loss of chlorine which causes the Weldon process at the present time only to be worked in those districts where hydrochloric acid does not command a good price, and where the calcium chloride can be utilised.

So far as can be ascertained, the Weldon process is not extending at the present time, the under-described **Deacon Process** (where the waste of chlorine is less), and also electrolytic methods of manufacturing chlorine, steadily gaining ground at its expense (see p. 365). The chlorine evolved from the **Weldon Process**, however, is very concentrated, sometimes amounting to 90 per cent. by volume of the evolved gas.

THE DEACON PROCESS

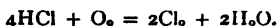
LITERATURE

See references on p. 359; also

HABER.—“Thermodynamik technischer Gasreaktion.” 1905.

FALCKENSTEIN.—*Zeit. physikal. Chem.*, 1907, 59, 313; 1909, 65, 371.

The oxygen of the air can be used to oxidise hydrochloric acid to chlorine and water. When a mixture of hydrochloric acid and air is led over a heated suitable “contact” substance the following change takes place:—



This is the process of Deacon and Hurter. The decomposition, however, is by no means a quantitative one, and the unchanged hydrochloric acid is recovered and used again. The contact substance employed is usually cupric chloride, CuCl_2 , heated to 450°C . Cupric sulphate, CuSO_4 , has been used, but is not so efficient as CuCl_2 .

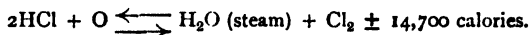
The action is essentially “catalytic,” but it is usually supposed that the CuCl_2 is first converted into an oxychloride, which is then, by means of the HCl, reconverted into CuCl_2 . For example, Hengsten gives the equations:—

1. $\text{CuCl}_2 = 2(\text{CuCl}_2 + \text{Cu}_2\text{Cl}_2) + 4\text{Cl}$.
2. $2(\text{CuCl}_2 + \text{Cu}_2\text{Cl}_2) = 3\text{Cu}_2\text{Cl}_2 + 2\text{Cl}$.
3. $\text{Cu}_2\text{Cl}_2 + \text{O} = \text{CuO}.\text{Cl}_2$.
4. $\text{CuO}.\text{CuCl}_2 + 2\text{HCl} = 2\text{CuCl}_2 + \text{H}_2\text{O}$.

Lunge and Marmier come to somewhat similar conclusions, which are, however, denied by Levi and Bettoni, who cannot find in the CuCl_2 used any Cu_2Cl_2 or $\text{CuO}.\text{CuCl}_2$. Moreover, pumice-stone impregnated with Cu_2Cl_2 or $\text{CuO}.\text{CuCl}_2$ gave between 250° - 400° no trace of Cl. Also, CuSO_4 , chlorides of Ni, Mn, Mg, etc., also strongly heated pumice-stone alone, gave Cl when a mixture of HCl gas and air was led over them. On this ground these authors reject the “oxychloride” theory of the previous writers, and assert that the Cl does not come from the CuCl_2 at all, as this latter can be replaced by the SO_4 or substances which do not contain Cl at all, and put forward the suggestion that the catalytic action of these substances is to be referred to the tendency of the substances to form oxychlorides. Levi and Voghera also carried out experiments on the use of catalysers such as CaCl_2 , MgCl_2 , BaCl_2 , NiCl_2 , CuSO_4 , CuO , etc.

Ditz and Margosches (D. R. Patent, 150,226, 15th June 1902) have proposed to use as a contact substance the chlorides of the rare earths (Th, Ce, La, Pr, Nd, etc.), which occur as a by-product in the manufacture of thoria for gas mantles. The reaction temperature is 300° - 600° . With diluted gases it is stated that the reaction takes place even better than with concentrated 40-50 per cent. gases.

The reaction is reversible, following the ordinary law of mass action:—



At low temperatures the reaction tends to proceed almost completely in the direction from left to right, with the evolution of heat, but so slowly as to be practically unworkable. As, however, the temperature increases, apparently the attraction of hydrogen for chlorine increases, and the reaction tends to proceed more rapidly in the reverse direction from right to left, so that as the temperature increases the yield of Cl from HCl decreases. Consequently the lower the temperature the greater is the quantity of HCl theoretically converted into Cl_2 ; but at low temperatures the reaction proceeds extremely slowly, so that it is unpractical to carry it out below 400° - 430°C . At a temperature such as 450°C equilibrium is more rapidly attained, but the yield of chlorine is seriously diminished, and at temperatures much above 450° notable amounts of copper chloride are lost by volatilisation.

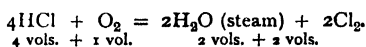
The most favourable practical conditions have been worked out by Lunge and Marmier (*Zeit. angew. Chem.*, 1897, 105), who found that the contact substance should be kept between 450° - 460°C . Above 460°C serious losses of copper chloride

occur, while below 440° C. the yield of chlorine was bad on account of the slowness with which equilibrium was attained.

As regards the theory of the process the reader should see Haber, "Thermodynamik technischer Gasreaktion," 1905, p. 89. A recent investigation on the equilibrium of the Deacon process has been published by Vogel von Falckenstein, *Zeit. physikal. Chem.*, 1907, 59, 313; 1909, 65, 371-379.

As in all chemical actions where heat is evolved, increase of temperature increases the velocity of the reaction up to a point, and beyond that point the velocity of the reverse reaction increases very rapidly.

It follows, therefore, that as in all chemical reactions attended with the evolution of heat (see the "Contact Process for SO₃ Manufacture," this Volume), the *lower the temperature* the more completely does the reaction take place in the direction $2\text{HCl} + \text{O} \rightarrow \text{Cl}_2 + \text{H}_2\text{O}$, and consequently the more completely the hydrochloric acid is turned into chlorine. Unfortunately, however, at low temperatures the reaction proceeds so slowly as to make it practically unworkable. It is only at 400°-430° that the action proceeds with CuCl_2 with sufficient velocity to make the process technically workable. As the temperature increases up to 450°, so also does the rapidity with which equilibrium is attained, although the yield of chlorine per given amount of hydrochloric acid becomes increasingly worse on account of the increasing rapidity of the back action, $\text{H}_2\text{O} + \text{Cl}_2 \rightarrow 2\text{HCl} + \text{O}_2$. According to Haber, theoretically at 430° C., some 75.85 per cent. of HCl is convertible into Cl, whereas at 577° C. only 50 per cent. is convertible. Possibly some advance may come with the discovery of a more efficient catalytic agent than CuCl_2 , which works at a lower temperature than 450° C. According to von Falckenstein, the best yield in the Deacon process is obtained by using a mixture of 40 per cent. HCl and 60 per cent. air. About 70-71 per cent. of the HCl gas entering the apparatus can be converted into Cl. On drying the cooled gaseous mixture by passing through concentrated sulphuric acid, and again passing it through the apparatus, a yield of 82.85 per cent. of chlorine can be obtained, while on passing once more through the apparatus, 87.89 per cent. yields are attainable. As regards the influence of *pressure* on the equilibrium, it is a general law that an increase of pressure tends to cause a reaction to proceed in such a direction as to favour the production of products occupying a small volume, as the equation shows:—



An increase of pressure should therefore favour the transformation of HCl into chlorine by the Deacon process, and Foucar (private communication) has suggested that a modified Deacon process carried out under pressure, and at such a temperature as would just prevent the condensation of the steam, would have a future before it.

Fig. 4 shows one of the older forms of the Deacon plant. A is the salt-cake furnace from which the HCl gas is evolved from the action of sulphuric acid on salt. B is a pipe leading off the HCl gases. C is a condenser in which sulphuric acid, aqueous hydrochloric acid, etc., are condensed. E is the preheater, where the entering gases are raised to the right temperature, say 220° C., before entering the contact apparatus F. This consists of a cylindrical iron tower F, surrounded by a brickwork wall M, whereby the whole can be heated to the proper temperature (about 430°-450° C.). In the central portions of the tower are piled layer over layer of baked clay or porous earthenware balls, previously soaked in cupric chloride solution and dried. As the CuCl_2 is somewhat volatile, the entering gas is first sent through the system from below upwards, after which the direction is changed from above downwards, and so on in alternately reversed directions. By this arrangement loss of copper chloride is minimised.

The German patent, 197,955 (1906), proposes to use the double salt, $\text{CuCl}_2 \cdot \text{NaCl}$, which at 550° is not noticeably volatile. With this salt the gas stream can be heated to 510° C., without much loss of copper, whereas in the ordinary CuCl_2 , over 460°, a considerable loss of copper occurs.

By means of this system about 65 per cent. of the HCl is, in actual practice, decomposed into Cl. The issuing stream of chlorine-rich gases escapes through the pipe H into a series of cooling tubes J, whence they pass into the tower K, where they meet with a descending spray of water, which washes out the HCl gas, but only absorbs a small amount of chlorine. The aqueous HCl thus obtained is freed from chlorine by blowing through it a stream of air.

From the water tower the chlorine gas next passes into the drying tower L, where it is dried by a descending stream of concentrated sulphuric acid, the dry chlorine emerging at N.

In its original form the Deacon process suffered from some grave defects which rendered it unable at first to compete with the Weldon process. The HCl was at first led directly from the

salt-cake furnaces into the contact apparatus, and it was found that the latter ceased to work effectively because the unpurified HCl gas carried on sulphuric acid fumes, ferric chloride, arsenic, and dust, which spoil the contact substance. Hasenclever, of the Rhenania Factory, was the first to make the process really successful. This he achieved by purifying the HCl gas by first absorbing it in water, and then liberating it again in a comparatively pure state by running in concentrated 66° Bé. (107° Tw.) sulphuric acid, and finally blowing air through the liquid. The HCl came over pure in a steady stream, and was led directly into the contact apparatus. This process is still worked on a very large scale.

At Mannheim, in 1909, a further simplification was introduced in the process by obtaining directly in *mechanical salt-cake furnaces* (see this Volume, p. 284), nearly pure HCl gas, free from arsenic, and of a fairly constant strength, consisting, say, of 30 per cent. HCl and 70 per cent. air. This gas is purified by leading it through a series of Cellarius condensers (p. 276), whereby dust and sulphuric acid are deposited. Lastly, the gas is heated to about 220° C., and is led directly into the contact apparatus.

The chlorine evolved in the Deacon process is very dilute as compared to Weldon and electrolytic chlorine. It usually amounts to only 8-12 per cent. by volume, the rest being atmospheric nitrogen and other gases. Consequently, it is difficult to use an ordinary "chamber" for making bleaching powder. The lime

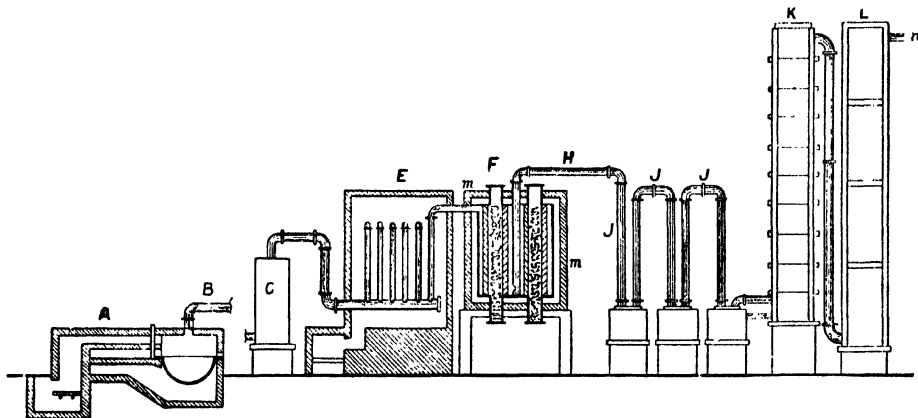


FIG. 4.—Deacon Process of Chlorine Manufacture.

must be treated in a special apparatus invented by Hasenclever, which will be described under bleaching powder (p. 394).

The Deacon process is still able to maintain its position and even advance in spite of the growth of electrolytic chlorine. In the Weldon process only about one-third of the chlorine in the HCl is utilised, while in the Deacon process over 40 per cent. of the HCl is transformed into Cl₂, the rest being recovered as HCl, and, moreover, the oxidation agent, viz., atmospheric oxygen, does not cost anything. The disadvantages of the Deacon process are the trouble in getting the plant to work, the frequent loss of efficiency by the contact materials becoming useless, and the loss of copper by volatilising or otherwise.

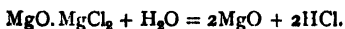
Preparation of Chlorine and Hydrochloric Acid from Magnesium and Calcium Chlorides.—Enormous amounts of magnesium chloride, estimated at 500,000 tons, are run to waste at Stassfurt (see this Volume, p. 329, "The Stassfurt Industry"), simply because no economic means are known of transforming these mother liquors into chlorine products.

Many attempts have been made to obtain chlorine and hydrochloric acid from magnesium chloride, MgCl₂. When the latter is crystallised from its solution it deposits as a snow-white mass containing water of crystallisation (MgCl₂.2H₂O).

When this crystallised magnesium chloride is melted it decomposes, forming oxychloride and evolving half its chlorine as HCl, thus:—



If now the magnesium oxychloride remaining behind is heated in a stream of steam nearly all the chlorine is evolved as HCl, leaving magnesia, MgO, behind, thus:—



This is a method of obtaining HCl from $MgCl_2$ which has actually been put into practice, but without much success.

In order to obtain chlorine from magnesium chloride or oxychloride the substance must be ignited in a stream of air when it evolves chlorine, but only incompletely; it does not melt, but remains porous. This, essentially, was the Weldon and Pechiney process, worked for a time, but unsuccessfully, at Salindres in S. France, the magnesium chloride being obtained by concentrating the mother liquors left after crystallising out the salt, NaCl, the manufacture of salt being here a considerable industry. Similar processes were worked at Neustassfurt and Leopoldshall in Germany, two manufacturers of potassium salts seeking to utilise the magnesium chloride waste liquors in this manner, but again with no success at Neustassfurt. In Leopoldshall the manufacture of chlorine by this process was given up in 1909, after being worked since 1890, but hydrochloric acid is still obtained at the latter place by the following method:—

Powdered magnesia, MgO, is mixed with the concentrated $MgCl_2$ mother liquors, when combination ensues, with the formation of solid plates of magnesium oxychloride, containing, roughly, 10 per cent. MgO, 40 per cent. $MgCl_2$, and 50 per cent. H_2O . These plates are then stacked up side by side and one over the other in the shaft of a furnace, care being taken to suitably support the plates. From beneath, the hot gases from the furnace stream through the mass and heat them to a red heat. The plates, shrinking and subsiding downwards, as they do in the hotter parts of the furnace, yield up most of their chlorine in the form of dilute HCl gas, which is then condensed and absorbed in the usual way by passing the furnace gases up absorbing towers, where they meet with a stream of descending water.

The firing of these furnaces is "brown coal," which gives off much water, and so aids the action of the heat in causing the complete decomposition of the oxychloride. The resulting HCl solution is very dilute, only 15° Bé., but has the great advantage of being practically arsenic free.

There finally remains a calcined mass containing 15 per cent. $MgCl_2$ and 85 per cent. MgO, which is then ground up and utilised, partly for mixing with the $MgCl_2$ liquors for repeating the process, and partly for the production of magnesium oxychloride cements (sorel cement, xylolith), which is now being used in increasing quantities for floorings, artificial marble, etc. (see p. 419).

There seems, however, but little prospect of an increased production of HCl from this or allied methods, as the ease and abundance with which HCl is produced by the extension of the salt-cake furnace methods puts the former out of court unless the running costs can be considerably reduced.

As regards the production of HCl and Cl from calcium chloride, this is one of the great problems of the day. By the ammonia soda process enormous amounts of waste calcium chloride liquors are produced, and also by the Weldon recovery process, and the manufacture of $KClO_3$. Enormous numbers of proposals, almost always devoid of practical success, have been made to manufacture Cl cheaply from $CaCl_2$, or to utilise this chlorine effectively; e.g., Solvay in 1877, 1888, and 1889 took out a number of patents which consisted in heating $CaCl_2$ with sand, clay, etc., under various conditions in a stream of air (see "Chemische Industrie," I, 49 (1878), and Hurter, *Journ. Soc. Chem. Ind.*, 2, 103 (1883)). An account of the various proposals is given in Lunge's book, "Sulphuric Acid and Alkali," Vol. III.

SECTION XXXVI

ELECTROLYTIC CHLORINE AND
ALKALI

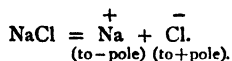
BY GEOFFREY MARTIN, D.Sc., Ph.D.

LITERATURE

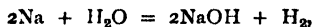
- J. A. LEE.—*Chem. Met. Eng.*, 1930, **37**, 232.
 B. SCHULZ.—*Chem. Ztg.*, 1932, **56**, 889.
 J. HEDALEN.—*Trans. Electrochem. Soc.*, 1933, **63**, 183.
 C. L. MANTELL.—*Chem. Met. Eng.*, 1931, **38**, 88.
 ALLMAND'S "Principles of Applied Electrochemistry." 1912.
 HÖLBING.—"Fabrikation der Bleichmaterial" (1913).
 KERSHAW.—*Journ. Soc. Chem. Ind.* (1913), **32**, 993; *Electrical World*, **46**, 101.
 V. ENGELHARDT.—"Hypochlorite u. Elektrische Bleiche" (1903); also *Chemiker Zeitung* (1911).
 R. LEPSIUS.—*Ber.*, 1909, **42**, 2895.
 L. FÖRSTER.—"Elektrochemie wässriger Lsgn." 1905.
 See also British Patent 348,792 (1931), United States Patent 1,781,830 (1931), and British Patent 346,470 (1931).

WITHIN the last two decades a large industry has arisen out of the electrolysis of the alkali chlorides, whereby not only chlorine, but also valuable bleaching solutions, chlorates, and caustic alkalies are obtained. At the present time it is stated that over half the world's supply of chlorine and chlorine products arises out of the electrolysis of the alkali chlorides. A large number of different processes have been proposed, but we will only mention those which have been attended with some success.

General Principles.—When an electric current is passed through a salt solution the positively charged metallic ions pass to the negative electrode (cathode), whereas the negatively charged chlorine ions pass to the positive electrode (anode) thus:—



Arriving at the electrodes, these charged ions give up their electrical charges, and the sodium ions become ordinary sodium, which at once reacts with the excess of water present, to yield H gas, and produce caustic alkali, thus:—



so that at the cathode caustic soda accumulates and free hydrogen is given off. On the other hand, the chlorine ions, after giving up their negative charges at the + pole, are liberated as chlorine gas at the anode (+ pole), and also remain dissolved in the liquid surrounding the anode. In very dilute solutions, and with too high electrical potentials, the water suffers electrolysis, oxygen coming off at the positive pole, and hydrogen at the negative.

The conduction of the current across such an electrolytic solution depends upon its transportation by the charges on the ions. Thus every equivalent ion, e.g., 1 g. of hydrogen, 35.5 g. of chlorine, 23 g. of sodium, etc., carries with it the same quantity of electricity, viz., 96,540 coulombs—either positive or negative electricity, according to the + or - character of the ion (Faraday's law). It is therefore an easy matter to calculate the amount of chemical products theoretically producible by the passage of a certain quantity of electricity through a liquid. E.g., to produce, say, 35.5 g. of chlorine, or 40 g. of NaOH (from 23 g. of liberated Na) we theoretically only require the passage of 96,540 coulombs.¹ Theoretically, a current of one ampere liberates in one hour 1.3236 g. of chlorine. In practice, however, side or secondary reactions diminish the yield of these products.

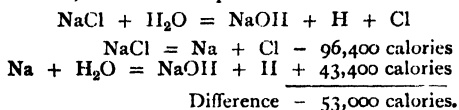
To liberate any ion a definite electrical tension is required, measured in volts. And to drive a current continually through any electrolyte there is thus required a definite voltage depending upon

¹ A coulomb is the quantity of electricity represented by one ampere flowing for one second past any section of a circuit.

the nature of the ions liberated. These are the so-called "polarisation" voltages, which must be overcome before the ion gives up its electrical charge and is liberated.

The total amount of *electrical energy* required for electrolysis is measured by the product of the current in amperes, and the voltage at which it is forced through the liquid, the unit being called a volt-ampere. 1 volt-ampere = 1 watt/second = 0.24 gramme-calorie.

For electrolysis, Ohm's law takes the form: $-C = \frac{E - e}{R}$, E being the voltage of the source of electricity, and *e* the polarisation voltage which must be overcome before the current will flow through the electrolyte at all. It is always possible to calculate *approximately*, from the heats of combination of component salts, the reactions which take place. Thus, confining ourselves to the electrolysis of NaCl solution, we have the equations:—



Hence, in order to decompose 1 g. mol. of NaCl (58.5 g.) and liberate 40 g. NaOH, 1 g. H and 35.5 g. Cl, we require the expenditure of energy represented by 53,000 calories, which is equivalent to $53,000/0.24 = 220,800$ volt-amperes. Now 96,540 coulombs = 96,540 ampere-seconds are required to liberate the gram equivalent of these quantities, and so the *minimum* voltage (assuming that all the heat is represented by electrical energy) necessary for decomposing the solution is $220,800/96,540 = 2.3$ volts.

As a matter of fact, however, in practice a much greater amount of energy than this is usually required. Thus a considerable voltage is required to drive the electric current against the high resistance of the electrolyte, and this causes the generation of much heat, which is derived from the electric current.

Consequently, in order to pass a current of any intensity across the liquid, we must work with a voltage considerably greater than this minimal voltage of 2.3 volts. As the frictional heat represents a waste of electrical energy, in practice the resistance of the electrolytic cells is diminished to the greatest possible extent by making the electrode surfaces as large as possible, and the layer of electrolyte between them as short as possible. Moreover, the voltages are kept as low as possible, the conditions for economic production being low voltages and currents of great strength. In order to render the salt solutions good conductors (and so save waste of electrical energy in frictional heat effects) they are made as concentrated as possible, and usually are hot.

As regards the source of power for generating electricity, this is usually and most cheaply provided for by water power, and so the Niagara Falls in America, Norway, and other countries rich in water power are the main seats of this new industry.

However, where water power fails (as in Germany) the power is often provided from coal, brown coal, peat, the producer gases evolved in some furnaces, and coke ovens, etc.

The currents are usually generated by water turbines driving dynamos, and the current is delivered to the salt solutions at a definite voltage and a definite current density, such as experience shows is best for the particular cell employed. These cells are small, and the current is often divided among hundreds, and sometimes thousands, of individual cells (as these latter cannot be greatly enlarged to meet increased power, as is the case in most other industrial plants).

ELECTROLYSIS OF ALKALI CHLORIDES FOR PREPARING CHLORINE AND ALKALI

Four main processes are worked, namely:—(1) The diaphragm process, (2) the mercury process, (3) the Bell process, (4) the fused electrolyte process. We will describe each in detail.

(1) **The Diaphragm Process.**—The earliest and most successful cell of this type is the Griesheim, which has been worked (*Chemische Fabrik Griesheim-Elektron*) since 1890. Large works employing this cell also exist at Bitterfeld, Basel, and the Badische Anilin- und Soda-fabrik also use this process. The cell (Figs. 1 and 2) consists of an iron box MM, which is made to serve as the cathode. Inside this are placed six small porous cells *d,d*, serving as diaphragms in which dip the anodes κ, κ, κ , all connected in series, the whole being filled with *saturated NaCl solution*.

The walls of the small porous cells *d,d* (diaphragms) are a composition of cement, NaCl and HCl (Brucer, German Patent, 30,222, 1884). In the course of use the NaCl dissolves and leaves an extremely fine-pored wall, which separates the anodic from the cathodic space, and which allows the current to pass through. This composition has proved very resistant against alkali

and chlorine. The anodes *KK*, dipping into each porous cell, are now made of magnetic iron oxide (Fe_3O_4) fused in the electric furnace at 2,000-3,000° C., and poured into moulds. Such electrodes have proved superior to the carbon poles previously employed, which are attacked by nascent oxygen.

Separating each small porous cell are iron plates *b, b*, going right across the main iron box *MM*, and dipping nearly, but not quite, to the bottom. These iron plates form (together with the iron walls of the main box *MM*) the cathodes.

The porous cells surrounding the anodes are covered with lids, chlorine

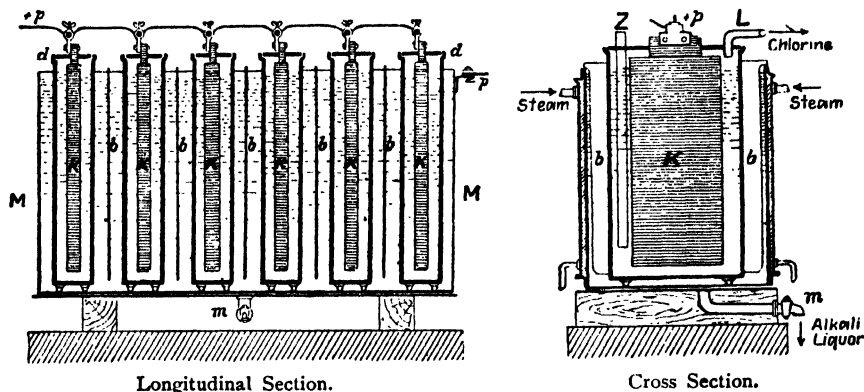


FIG. 1.—The Griesheim Cell.

escaping through a tube leading from the interior porous cells as shown at *L*, the anodes passing right through the lid. The chlorine is led away through an earthenware pipe to the chlorine chamber.

Also each cell is provided with a tube-shaped grid of earthenware for filling in salt, thus keeping the solution saturated. The bath *MM* is also provided with a lid through which the evolved hydrogen escapes. This gas is either led into

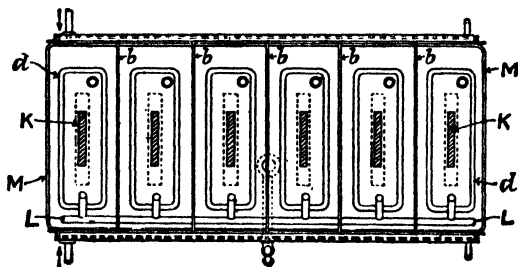


FIG. 2.—The Griesheim Cell.

a gasometer or it is led away to the pumps, and compressed in strong steel cylinders under 150 atmospheres pressure, and stored in this form.

The following are the changes which occur in the cell when the current is passed through the saturated NaCl solution in the bath. The Cl ion passes through the diaphragms *d, d* into the anodic space and there escapes as Cl gas, while the Na ion passes from inside the diaphragm and discharges itself on the cathodic space outside, being converted into NaOH and H , which escapes as above described. As the action proceeds the solution becomes weaker and weaker in NaCl , so that saturated NaCl solution is run in through the pipe *Z*, and the solid salt added from time to time also maintains the supply of salt to the liquid. Consequently in the cathodic space there gradually collects NaOH liquors mixed with a dilute NaCl solution, and this is run out from time to time by means of a tap *M*, the deficiency being replaced by fresh NaCl solution entering through *Z*, so that there is a continuous flow of electrolyte through the system. The action, however, does

not proceed to completion. As soon as NaOH is formed it begins to itself take part in carrying the current, the tendency becoming the more marked the more NaOH that is present. It is supposed that the NaOH decomposes electrolytically, thus:—

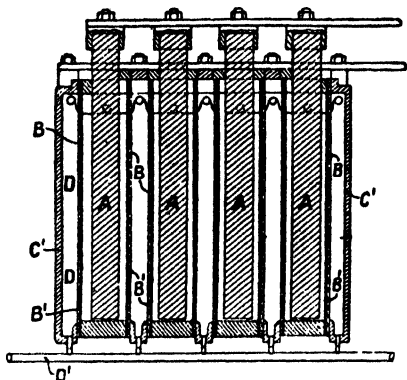


FIG. 3.—The Hargreaves-Bird Cell.

as possible together, while the salt solution is maintained at 80°-90° by means of a steam jacket.

It has been found that the best results are attained in practice by using a voltage of 4 volts to drive the current across the path, the current density being 100-200 amperes per square metre. Since the equivalent amount of products liberated are 35.5 g. Cl + 40 g. NaOH + 1 g. H, by the passage of 96,540 coulombs (*i.e.*, ampere-seconds) through the liquid, with 4 volts driving this current the energy expended per second would be $4 \times 96,540$ volt-amperes = 525 H.P. In other words, 525 H.P. working for 1 second would yield 35.5 g. of Cl, or 1 H.P. working for twenty-four hours would give 5.85 kg. of Cl = 16 kg. of bleaching powder = 6.6 kg. NaOH = 0.17 kg. H (= 2 cub. m.).

It should be pointed out that when the chlorine formed comes into contact with the NaOH produced we get, in the cold, some sodium hypochlorite produced; in the hot solution, however, sodium chlorate is produced. So that the NaOH produced sometimes contains small amounts of hypochlorite and chlorate. The hypochlorite and chlorate in the liquors tend to attack the carbon anodes, producing CO₂, which is absorbed by NaOH forming carbonates. So that wherever carbon electrodes are used, small amounts of carbonates are usually found in the resulting NaOH.

The Hargreaves-Bird Cell¹ is used directly for the electrolytic production of sodium carbonate. The construction of this cell is best understood by reference to Fig. 3. A, A are carbon anodes dipping into a saturated solution of NaCl contained in the anodic cells BB', B'B. The walls of these cells are made up of porous diaphragms, consisting of cement or some similar material, to which is affixed on

The Na ion at the cathode then gives up its charge, and reacts with the surrounding water to produce NaOH again and H ($2\text{Na} + 2\text{H}_2\text{O} = 2\text{NaOH} + \text{H}_2$), while at the cathode we get the OH' ions similarly changing into water and oxygen ($2(\text{OH})' = \text{H}_2\text{O} + \text{O}'$), so that the net results are that hydrogen is given off at the cathode and oxygen at the anode, and a considerable amount of the current is used up uselessly simply in decomposing water. To prevent this waste, therefore, in practice the process of electrolysis is stopped as soon as about one-third of the NaCl has been changed into NaOH, and the NaOH liquors formed, containing about 75 g. NaOH, and 160-200 g. NaCl per litre, are run off into vacuum evaporators and concentrated.

With the object of diminishing as much as possible the internal resistance of the cell, the polar surfaces are made as large as possible, and brought as close

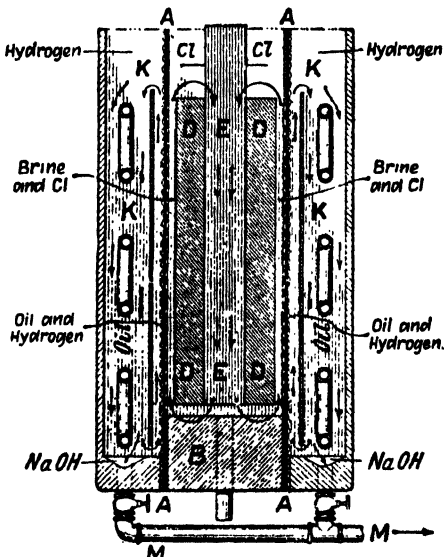


FIG. 4.—The Townsend Cell.

¹ See C. Kershaw, *Electrical World*, 46, 101; English Patents, 18,871, 1892; 5,197, 1893; 18,173, 1893.

the *outside* a network of iron gauze, which forms the cathode. The NaCl solution flows into the anodic space through a tube near the top, and pours through the diaphragm surrounding the anode, out through the wire gauze into the exterior empty space DD, finally escaping through the tube D'; as the salt solution pours through the cell, subjected to the powerful electrolytic action by the current passing from A to B', and consequently the salt solution emerges through the diaphragm into the exterior empty space DD, it is largely decomposed into NaOH. In DD, however, it meets with a stream of steam and CO₂ which immediately combines with the NaOH to form Na₂CO₃, which pours off through D'. The exterior space DD thus remains empty. The Na₂CO₃ liquor is gradually evaporated and the crystallising Na₂CO₃ separated by centrifugals.

According to Kershaw, the main cells are 10 ft. long by 5 ft. 14 in. deep, and are united in batteries of fourteen. The brine is pumped directly from the salt springs into the battery, and a current of 2,000 amperes, under a tension of 4-4½ volts, is passed through the liquid. Every cell decomposes 100 kg. salt in twenty-four hours. Current efficiency, 90 per cent. The escaping Na₂CO₃ liquors contain 150 g. Na₂CO₃ per litre. About 66 per cent. of the NaCl is decomposed into NaOH.

This process is worked by the Electrolytic Alkali Company in Middlewich, but the success in England does not appear to be very marked, although the plant appears to be more successful abroad, where electrical power is cheaper.

The **Townsend Cell** (Fig. 4) consists of an interior diaphragm of porous material, *i.e.*, asbestos mixed with iron oxide and hydroxide, firmly fixed into a non-conducting cement foot B. Surrounding and in close contact with the porous diaphragm AA is the cathode, made of *iron gauze*. Into the interior of the diaphragm projects the hollow anode (of Acheson graphite) DDD, which nearly fills the entire central space. Through the middle of this anode is a tube EE, down which a strong NaCl solution is pumped. This NaCl, as it passes between the wire gauze cathode on AA and the anode DD, is subjected to the powerful electrolytic action of the strong current flowing between them. The NaOH formed streams through the diaphragm AA into the exterior space KK, which is filled with oil, which serves as the inactive fluid which separates the cathodic and anodic fluids and prevents them uniting. The NaOH liquors sink below the layer of oil to the bottom of the space KK, and are run off through MM. The oil bath can have its temperature regulated by closed steam or water coils. Cl escapes from the anodic space and H from the cathodic space (see English Patent, 18,403, 1904).

According to Baekland (*Chemiker Zeitung*, 1909, 33, 1125), at Niagara Falls a current of 2,500-5,000 amperes is sent through a battery of seventy-six cells. The "density" of the current used is about 1 ampere for each square inch anodic surface. The voltage per cell is 4. The diaphragms are cleaned every thirty days. Current efficiency, 90 per cent. 15-20 l. of NaCl solution are sent through each cell per hour. The liquors escaping contain 150 g. NaOH and 200 g. NaCl per litre.

The main advantage of the process is stated to be the almost complete absence of chlorates and hypochlorites in the escaping liquors. The resulting NaOH liquors are evaporated, separated from the NaCl (which crystallises out), again evaporated in open boilers, and sold containing 76-77½ per cent. NaOH, together with 2 per cent. Na₂CO₃, and a small amount of NaCl.

Le Sueur's Cell, of latest construction, is described in the American Patent, 723,398. The cell (Fig. 5) is divided into two compartments by the diaphragm AA (made of asbestos), which is coated with *iron gauze*, which forms the cathode. A carbon *anode* B passes through a lid closing the anodic compartment C. A stream of NaCl solution enters through the pipe e, enters the anodic compartment C by means of a hole bored in the lid, and then flows out through the diaphragm into the cathodic compartment D. The electrolysed brine collects in D, and the resulting liquor, rich in NaOH, escapes through F. The fluid pressure in C must be greater than in D, otherwise the liquid will not escape readily through the diaphragm.

A modification of this process is stated to be worked at Rumford Falls in Maine (U.S.A.).

The **Outhenin-Chalandre Cell** (see *Moniteur Scientif.*, 1907, 789, 586) has been used extensively in France, Switzerland, Italy, and Spain. The anodes

are of graphite, the cathodes of iron, and the diaphragm consists of a special kind of porous earthenware.

The **Billiter-Siemens Cell** (see British Patent, 7,757, 1907; Kershaw, *Journ. Soc. Chem. Ind.*, 1913, 32, 993-995; Allmand, *loc. cit.*; Allmand, "Principles of Applied Electrochemistry") has, since 1907, been extensively introduced on the Continent and at Niagara Falls.

The apparatus (Fig. 6) consists of a bell (11) closed at the bottom by a diaphragm (1, 2), which rests on an iron or nickel net (3), which serves as the negative cathode. Inside the bell is the anode (8) (made of carbon), the whole standing in an outer vessel (10).

The special feature of this cell is the nature of the diaphragm. The wire-net cathode (3) is covered with ordinary commercial asbestos cloth (1), on which is piled a powder diaphragm (2), made of a composition consisting of an insoluble powder (like barium sulphate or alumina), with asbestos wool, the whole being made into a tenacious but consistent mass with a solution of common salt.

NaCl solution enters through the pipe (12), flows right through the diaphragm, is subjected to electrolysis in so doing, and escapes as NaOH through the outlet (13).

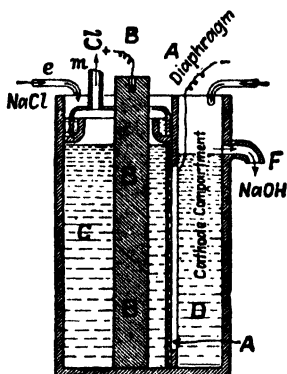


FIG. 5.—The Le Sueur Cell.

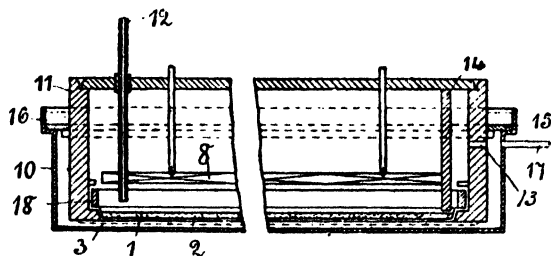


FIG. 6.—The Billiter-Siemens Cell.

The cell is provided with a special heating arrangement, which serves to keep the liquid hot.

With 4.5 volts the apparatus gives 12 per cent. NaOH, with efficiencies of 90-95 per cent. of the theoretical amount. Cl gas of 99 per cent. strength is evolved. An apparatus with a cathodic net of 1 sq. metre working under a tension of 4.4-5 volts requires a current of 600 amperes. The salt solution is maintained at 60° C. Anodes of magnetic iron oxide are now stated to be used instead of carbon.

The **Billiter-Leykam Cell**, a modification of the Billiter-Siemens cell, is an improved form of the bell-jar cell, using cathodes hooded in asbestos and placed underneath the anodes.

Working at 85° C., it furnishes a 12-16 per cent. NaOH at a current efficiency of 92 per cent., using 3.2 volts and employing unpurified brine. The drawback is the small amperage per unit of floor space.

The **Finlay Cell**, described in the British Patent, 1,716 of 1906, also in Allmand's "Principles of Applied Electrochemistry," p. 380, is a double diaphragm cell, with a doubly counter-flowing electrolyte traversing the cell from end to end by means of tubes. By means of a filter press arrangement (the cell being built much like a filter press), the thickness of the electrolyte is reduced to a minimum. There is a constant difference of hydrostatic pressure at every point of the diaphragm, so that uniform percolation of the brine is secured.

Fig. 7 shows a section of a battery of cells. *a, a* are the anodes, *b, b* the cathodes, *a', a'* the diaphragms (made out of asbestos plate, with holes therein at top and bottom for allowing brine to flow through according to a definite counter-current circulating tube system), and *p, p* are

"distant pieces" (*i.e.*, frames placed between the diaphragms) which, when pressed up by the screw 31-32, enclose a space which constitutes an electrolytic chamber. These distance pieces are also provided with holes, which, with the corresponding holes in the cathode, anode, and diaphragms, constitute parts of the tubes of the circulating system. When these parts are arranged in the cell as shown, and are pressed together between the end plates 30 by means of the screw 31, and the handwheel 32, orifices in the cathodes, diaphragms, distance pieces, and anodes all coincide, and form continuous tubes or ducts for circulating the electrolyte. 36 is the feed system for the brine, 37 and 38 are, respectively, out-flow cisterns for the products of the cathode and anode chambers respectively. 39 is a separator for H gas, a similar separator (not shown) being employed for the chlorine.

The separators and pipes connect with the three double lines of holes in the elements, making up the battery, so that three continuous tubular circuits are formed for the flow of liquids.

According to Donnan (*Journ. Soc. Chem. Ind.*, 1913, 32, 994) this cell, working with purified brine and a current density of 4 amperes per square decimetre of diaphragm, can produce 8-12 per cent. NaOH at a voltage not exceeding 3 volts, and with a cathodic current efficiency of 98-99 per cent.

In 1913 three 1,000 ampere units were being satisfactorily operated in Belfast. The Finlay cell, however, according to Kershaw (*loc. cit.*), is handicapped by the low concentration of the NaOH produced.

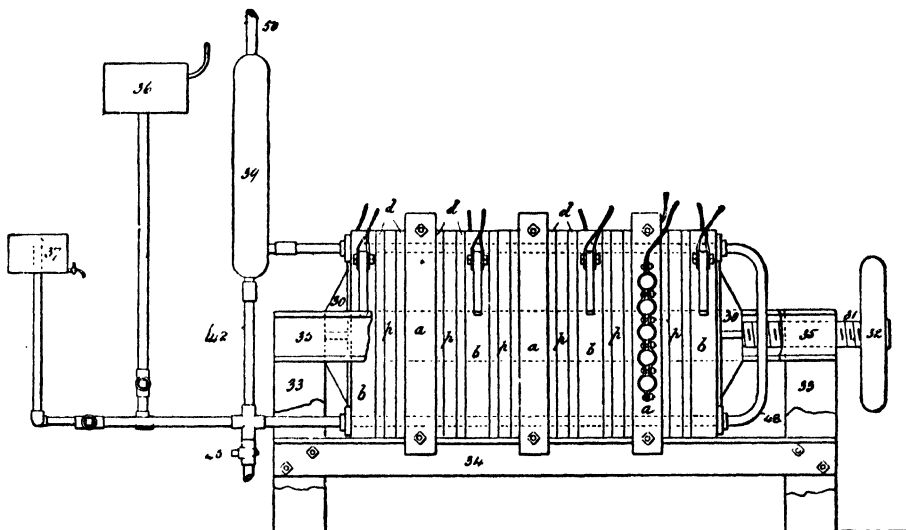


FIG. 7.—The Finlay Cell.

Kershaw (*loc. cit.*) states that diaphragm cells, with a moving electrolyte, the flow of which through the cell counteracts the effects of convection currents and of ionic migration which are constantly occurring, are now the most efficient type of electrolytic cell for the production of alkali and chlorine compounds, the Billiter-Siemens and Finlay cells possessing the highest energy efficiencies.

The following figures are given, showing the current and energy efficiencies of the various electrolytic alkali processes:—

Name of Process or Cell.	Efficiencies per Cent.		Concentration of Soda Liquor.
	Current.	Energy.	
Griesheim - - -	75	48	1.2 N
Hargreaves-Bird - - -	80	54	...
Townsend - - -	94	45	4 N
Billiter-Siemens - - -	92	68	3 N
Billiter-Leykam - - -	95	59	3.4 N
Finlay - - -	98	75	2 N
Castner-Kellner - - -	91	52.3	...
Aussig "bell" - - -	87½	40.9	...

Note.—A concentration of 1 N is equivalent to 40 g. of NaOH per litre.

(2) **The Quicksilver Process of Electrolysing Alkali Chlorides.**—

In this process quicksilver serves as the cathode, taking up the liberated Na as an amalgam, and giving it up at another place to water to form NaOH and hydrogen. The great advantage of this process is that the NaOH formed in the neighbouring cell is completely chlorine free, and on evaporating the solution a very pure NaOH is obtained. Moreover, it is possible to prepare directly very concentrated NaOH liquors, so that not such a great deal of evaporation is necessary as in the process first discussed. The absence of a diaphragm greatly reduces the resistance, and so allows the whole operation to be carried out at a low voltage. The main disadvantage is the great cost of the large quantities of quicksilver required for the plant.

Fig. 8 shows the cell employed by the **Castner and Kellner Co.**, Weston Point, Runcorn. The large trough MM is divided into three compartments A, B, A, by two partitions which do not touch the bottom of the cell, but fit into grooves at the bottom. Two stout graphite electrodes project through the walls of the two outer compartments of the vessel, while the middle compartment is fitted with an iron grid to form the cathode (− pole). The non-porous massive partitions do not reach quite to the bottom of the cell, but dip into a layer of mercury covering the

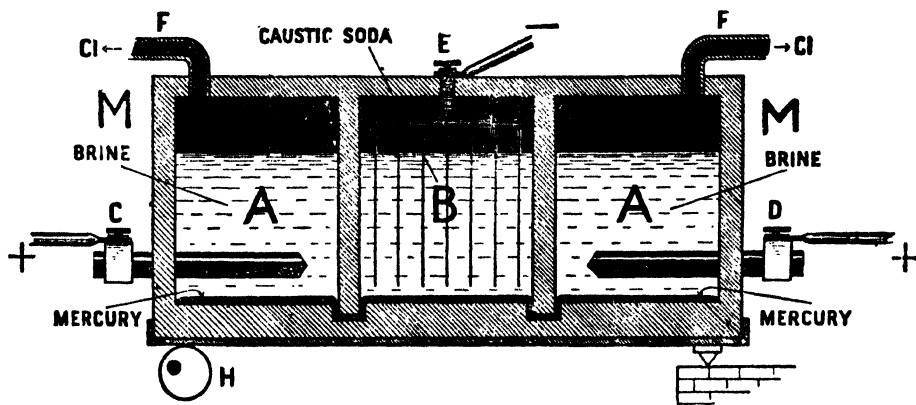


FIG. 8.—The Castner-Kellner Cell.

bottom as shown. A solution of alkali chloride flows through the two outer compartments, and water through the middle compartment:

On passing the current, the salt dissolved in the water of the two outer compartments A, A is split up into Cl and Na ions. The chlorine is evolved as such at F, but the sodium travels with the current and dissolves in the mercury at the bottom of the compartment, forming sodium amalgam. A slow rocking motion is given to the whole apparatus by means of an eccentric wheel placed at H, and this makes the mercury flow from one compartment into the other, and so brings the mercury amalgam into contact with the water in the middle cell, where it is decomposed, forming NaOH, evolving H₂, and regenerating the mercury. The hydrogen escapes through the loosely-fitting cover. When the NaOH formed in the middle compartment is sufficiently concentrated it is run off into another tank for boiling down.

According to W. Gordon Carey (*Journ. Soc. Chem. Ind.*, 1913, 32, 995), 144 cells of the rocking Castner type, measuring 6 ft. by 4 ft. internally, and containing 200 lbs. of mercury, gave with a current of 560 amperes at 4 volts (using Acheson graphite anodes and iron cathodes) per cell about 0.75 gall. of 20 per cent. caustic soda per hour. Mercury in the cells was purified from disintegrated graphite by mechanical means and dilute nitric acid, the total loss of mercury being under 2 per cent. per year. The evolved chlorine made 40 tons of bleaching powder per week. In working the cells care has to be taken to prevent undue hydrogen formation in the anodic chamber

(the gases being repeatedly analysed), otherwise explosions may occur. Kershaw (*loc. cit.*) gives the current efficiency as 91 per cent. and the energy efficiency 52.3 per cent. See also Lepsius (*loc. cit.*) and English Patents, 16,046, 1892; 10,584, 1893.

Solvay-Kellner Cell.—Fig. 9 shows a diagram of the Solvay-Kellner cell.

The carbon anodes A, A, A, A are joined up as shown, and dip into a strong solution of brine which fills the trough xv, the brine entering at s and flowing out at s'. Simultaneously a stream of mercury enters at B, flows along the bottom of the cell and escapes at D, flowing over a "weir" at C. As the current passes from the carbon electrodes to the mercury, the sodium dissolves in the

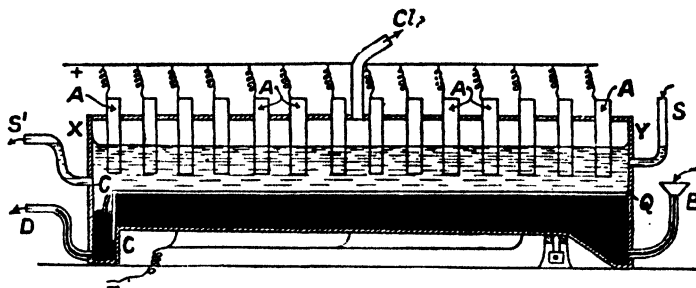


FIG. 9.—The Solvay-Kellner Cell.

mercury to form amalgam, which is then removed at D, decomposed by steam, forming H gas and NaOH, and the recovered mercury is pumped in again at B. Chlorine escapes continually at E. The apparatus is thus a continuous working one. The escaping amalgam contains usually 0.2 per cent. of Na. The cell can be built in very large units, taking 10,000-15,000 amperes (see German Patent, 104,900, 1898).

Rhodin's Cell, stated to be in use in Sault Ste Marie in Canada, consists (Fig. 10) of a circular iron trough AA, in which is placed a bell-like vessel BB, through which passes a series of carbon anodes D, D. The NaCl solution is contained in the bell. The exterior trough AA, however, is filled with water, and the bottom of the trough contains mercury, which forms the anode. The whole bell slowly revolves, and the quicksilver absorbs the liberated Na as sodium amalgam, which

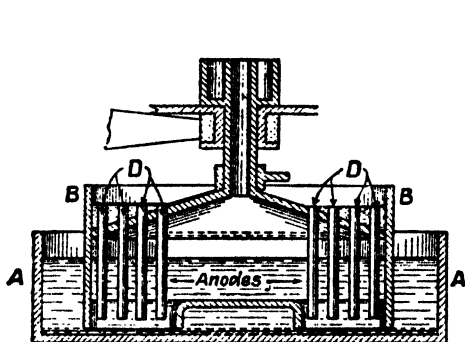


FIG. 10.—The Rhodin Cell.

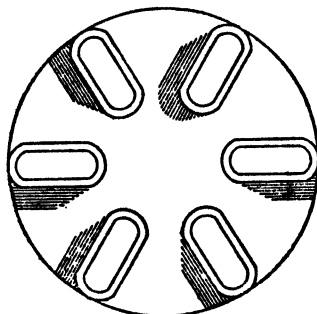


FIG. 11.—Bell of Rhodin Cell, as viewed from below.

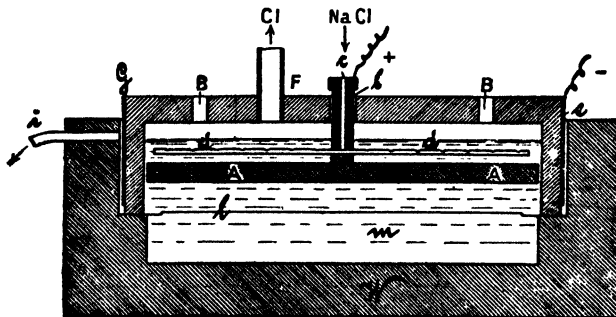
is then decomposed by the water in the exterior trough, forming NaOH and H (see *Zeit. f. Elektrochem.*, 1903, 9, 366; also German Patent, 102,774, 1896).

The advantages of the mercury cell are (Lepsius, *loc. cit.*):—(1) Very pure caustic alkali of high concentration; (2) high current efficiency; (3) no oxygen evolved. The disadvantages are:—(1) High voltage required (4.3 volts); (2) cost of mercury (72 tons per plant of 6,000 H.P.); (3) expense of first cost (apart from Hg).

(3) **The Bell Process.**—In this process no diaphragms are used, the separation of the liquors being made dependent upon the superior specific gravity

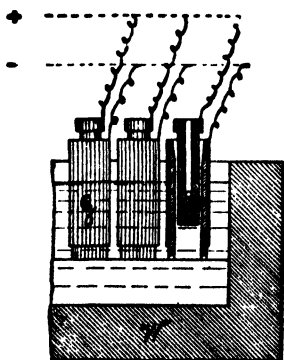
of the caustic soda or caustic potash solution, which then sinks to the bottom, leaving the NaCl or KCl solution above.

Figs. 12, 13, and 14 show the **Aussig-Bell Process** in longitudinal and in cross section (see German Patent, 141,187, 1900). Here the anode is enclosed in an inverted, non-conducting bell, with the cathode outside. In a vessel *w* stand some twenty-five small inverted earthenware "bells," *G,G*, coated externally with iron sheeting *ee*, which forms the cathodes. Inside each bell is a carbon anode *A*, placed so that only a small space is left between the walls of the bell and *A*. All the bells are connected in parallel, as shown in Fig. 13. Through an opening *c* in the carbon anode *A* a saturated stream of NaCl slowly pours out of many small holes in the pipe *dd* into the cell. As it enters, the liquid is subjected to the action



Longitudinal Section.

FIG. 12.



Cross Section.

FIG. 13.

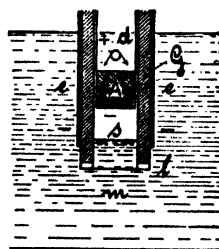


FIG. 14.

The Aussig-Bell Cell.

of the electric current, and the heavy caustic soda formed sinks downwards and fills the trough beneath; as it does so, it is continually removed by the overflow pipe *i*. The Cl gas escapes out of *F*. The openings *B,B* in the bells are used for connecting together the gas spaces of the twenty-five small bells, so as to maintain internal gaseous pressure the same in each cell.

The theory of the process has been worked out in detail by O. Steiner (*Osterr. Chem. Zeit.*, 1907) and F. Chancel (*C.B.*, 1908, 1789). The alkaline cathodic liquors form in the "bell" sharp layers (Fig. 14), the definiteness of which must be maintained if the process is to work efficiently. Its position in the cell, also, must not be altered to any great extent, a state which can only be maintained by continuous working. For in the process of electrolysis, the neutral zone, if left to itself, would steadily advance upwards in consequence of the passage of OH ions toward the anode, for, as explained on p. 370, as soon as any KOH is formed, it begins to take part in the electrolysis, the K passing towards the cathode and the OH ions towards the anode; and it is obvious that in

the cathodic liquors, where excess of KOH is present, it is the KOH which is for the greater part electrolysed, whereas in the anodic solution above it is the KCl which mainly undergoes electrolysis. Consequently, if we were dealing with a stationary fluid, the KOH layer would steadily creep upwards towards the anode, and this is only prevented by a steady continuous feed of KCl solution at such a rate as to just counterbalance the rise of the KOH layer, so that the "neutral zone" remains in a stationary condition in the cell, neither advancing up the bell nor receding below it—conditions which are easily maintained by carefully regulating the voltage and temperature, and the inflow of KCl solution, so as to maintain equilibrium. The neutral layer must remain several centimetres distant from the anode, and the liquid should not be heated to any great extent.

The iron cathode must lie close to the bell, and the anode must be perfectly horizontal.

It has been found that the necessary voltage for efficiently working this process is 4.5 volts, while the current-efficiency is given as 85-90 per cent. It yields alkaline liquors containing often 120 g. KOH per litre—consequently much richer in KOH than the liquors obtained by the diaphragm process. However, the electrolysis of the KCl cannot be carried to completion owing to the growing yield of O together with the Cl, also some chlorate is formed.

One disadvantage of the apparatus is the smallness of its dimensions,¹ and the care and exactness with which it must be regulated, one necessary condition to this being exact horizontalness. Once in action, however, it will keep long at work (the graphite anodes having, it is stated, a life of five years), and requires but little supervision.

(4) The Fused Electrolyte Process

is stated to be successfully worked on the Niagara Falls (see Haber, *Z. Elektrochemie*, 1903, 9, 364), and is protected by the English Patents, 6,636 and 6,637 of 1898, and by the German Patents, 117,358, 118,049, 118,391, 119,361. It is usually known as Acker's process. Molten lead is used for the cathode for collecting the sodium, and the resulting alloy of lead and sodium is then decomposed by steam to form hydrogen and sodium hydroxide. Fig. 15 shows the apparatus. Four graphitic anodes A, A, A, A dip into a 12-15 cm. deep bath of fused salt, so that they are only separated by a distance of $2\frac{1}{2}$ cm. from the cathode of molten lead C, and on which the molten NaCl floats.

The molten lead is contained in a vessel built up of fire-resisting material, the component parts of which are kept fastened securely together without mortar or cement merely by the molten salt penetrating between the crevices, and there solidifying, forms the binding material.

A powerful current of 8,000 amperes, under a tension of 7 volts, the current density being 2.9 amperes per square centimetre area, keeps the bath in a molten condition, the lead taking up some 4 per cent. of Na, and being then run off and decomposed by a blast of steam under a pressure of 2-3 atmospheres. This regenerates the lead, which is pumped back into the furnace again, while a stream of burning H escapes; above the lead the NaOH forms in a layer, which steadily runs off (about 11 kg. in one hour) and is absorbed in special vessels. The chlorine, mixed with air (10 per cent. Cl to 90 per cent. air), escapes from the anode and is conducted to the *Hasenclever bleaching powder apparatus* (p. 394) for chlorinating lime.

Although at least 50 per cent. more energy and a higher voltage is needed with this process than for the electrolysis of aqueous solutions, yet this is to some extent compensated by the high yield and concentration of NaOH, averaging 94 per cent. The impure salt is directly converted

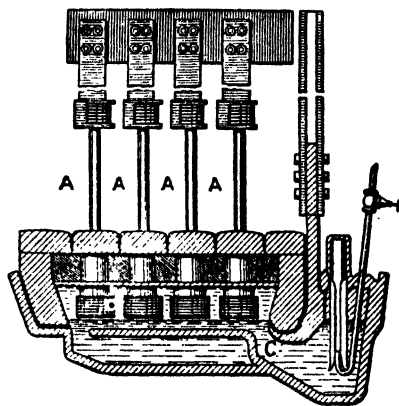


FIG. 15.—The Acker Process.

¹ At Aussig 25,000 cells are required for 3,000 H.P.

into NaOH, which is then fused in iron boilers in order to remove traces of MgO and CaO, which are derived from the Ca and Mg salts originally in the salt. The MgO and CaO settle out at the bottom, the resulting products consisting of 97.4-97.6 per cent. NaOH and 1 per cent Na_2CO_3 .

The process was successfully worked at Niagara Falls between 1900 and 1907, when the works were destroyed by fire.

Evaporation and Concentration of the Caustic Soda and Potash.

—The evaporation of the NaOH liquors, containing as they do much NaCl, is carried out in triple or quadruple effect vacuum pans very similar to those used in the manufacture of soap for evaporating the soap lyes and recovering the salt (see **Martin's** "Industrial Chemistry: Organic").

In evaporation, advantage is taken of the fact that NaCl and KCl are very sparingly soluble in concentrated NaOH or KOH solution, and consequently, as soon as the concentration proceeds far enough, the NaCl separates out almost completely, and is separated from the NaOH liquors by forcing the whole through

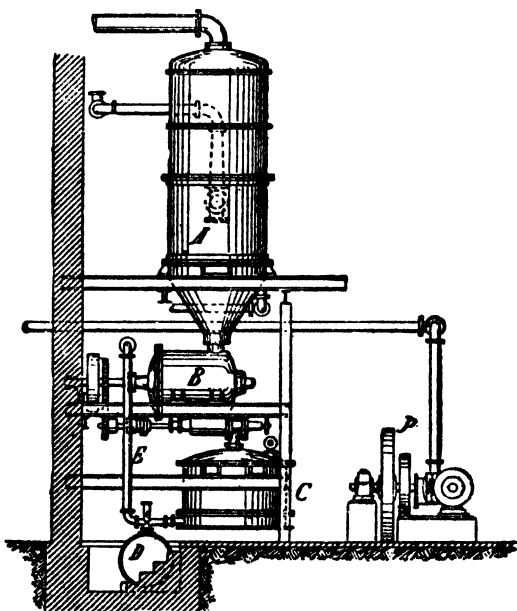


FIG. 16.—Vacuum Pan for Concentrating Caustic Soda.

special filters. Thus (Fig. 16) A represents the body of the vacuum pan, the separating NaCl collects in B, which is provided with a transporting screw or worm, working automatically, which from time to time forces the deposited salt from B through the filter press C, wherein the salt remains behind while the NaOH liquors are sucked away into D, whence they are forced back again into A, and the evaporation continued until the right concentration is attained.

The electrolytic NaOH of the Badische Anilin- und Soda-fabrik is used largely for the alizarin fusion. Large quantities of NaOH find an outlet in the paper, soap-making, and many other trades.

The electrolysis of KCl with the resulting production of KOH, Cl, and H is carried out in precisely the same manner as that of NaCl, and it is possible to obtain chlorine-free KOH by first evaporating to 50° Bé. (at which temperature the liquor contains 49 per cent. KOH to only 0.6 per cent. KCl—so insoluble is KCl in concentrated KOH solution, the substance being often put on the market in this form), and after filtering the separated salt, by further concentration and crystallisa-

tion at 60° C., when the chlorine-free solid hydrate $\text{KOH} \cdot \text{H}_2\text{O}$ is obtained. Below 32° C. the hydrate $\text{KOH} \cdot 2\text{H}_2\text{O}$ is obtained.

The industry is especially developed in Germany, where in 1904 some 15,000 tons electrolytic NaOH and 28,000 tons electrolytic KOH were placed on the market, the evolved chlorine going to make some 60,000 tons of bleaching powder. In Germany two-thirds of the bleaching powder made is derived from electrolytic chlorine. In the U.S.A. the industry is also highly developed, but in the United Kingdom only a beginning has been made.

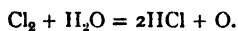
The chlorine which is evolved in these electrolytic processes is extremely concentrated, as much so as Weldon's chlorine. It is either directly converted into bleaching powder or liquefied.

The hydrogen, compressed in solid-drawn weldless steel cylinders to 150 atmospheres, is used for autogenous welding and cutting, for hydrogenating unsaturated organic substances, and for filling airships (see this Volume, p. 109, *et seq.*). In Germany it is stated that 10,000,000 cubic metres are annually produced from this source alone.

Properties of Chlorine Gas.—Greenish-yellow, very irritant suffocating gas. Sp. gr. 2.5 (Air = 1). 1 vol. water absorbs of chlorine gas (measured at 0° C. and 760 mm.):—

Temperature	-	-	-	-	10° C.	20° C.	30° C.	90° C.
Vols. of chlorine	-	-	-	-	3.095	2.260	1.767	0.380

Sunlight decomposes chlorine water, causing evolution of oxygen:—



Moist chlorine is very chemically active, uniting with H gas explosively in sunlight, also with most metals (with exception of platinum), S, P, etc. Carbon is not attacked. Dry chlorine is much less active, having no action on sodium or even iron. Chlorine is absorbed by sodium thiosulphate, caustic alkalies, lime, etc.

Powerful bleaching and oxidising agent in presence of moisture.

For **Liquid Chlorine**, see p. 381.

SECTION XXXVII

LIQUID CHLORINE

BY GEOFFREY MARTIN, Ph.D., D.Sc.

LITERATURE

See the foregoing references to chlorine on pp. 359, 367, also the following :—

TEICHMANN.—“Komprimierte Gase.” 1908.

HÖLBBING.—“Fortschritte in der Fabrikation der anorganischen Säuren, der Alkalien, des Ammoniaks und verwandter Industriezweige, 1893-1905.” Berlin, 1905.

O. KAUSCH.—*Zeit. comp. u. flüss. Gase*, 1893, 7, 58.

Also German Patent, 50,329, 1888. American Patent, 491,699. English Patents, 13,070, 1888; 7,058, 1890; 1889-1892.

Chem. Ind., 1906, 29, 105; 1905, 698.

A. LANGE.—*Zeit. angew. Chem.*, 1900, 684, gives the physical properties of liquid chlorine.

GEOFFREY MARTIN and E. DANCASTER give a full account of the properties of gaseous and liquid chlorine in Vol. VIII. of “Modern Inorganic Chemistry.” Edited by Newton Friend. 1915.

IN Germany, the production of large quantities of chlorine by electrolysis of alkali chloride solution has led to the manufacture of liquid chlorine on a considerable scale. Liquid chlorine is also made in England by the Kastner-Kellner Co. The industry arose from the observation of R. Knietzsch (of the Badische Anilin- und Soda-fabrik), in 1888, that dry liquid chlorine does not attack iron. At the present time the liquid chlorine is sent long distances in large boilers mounted on wheels (somewhat similar to the apparatus used for transporting petroleum), and is drawn off from below in a liquid condition into storage vessels, from which it is allowed to issue from above as a gas when required for use.

When, however, only small quantities are required, the liquid chlorine is preserved in steel cylinders, holding from 80-120 lbs. or more of liquid chlorine.

By means of these methods chlorine has been rendered available in a convenient form, and is now generally used both on the large and small scale for chlorinating organic materials (e.g., in the manufacture of **monochloroacetic acid** for the preparation of indigo (see **Martin's** “Industrial Chemistry: Organic”), chloroform, chloral, carbon tetrachloride, chlorobenzene, chlortoluene, etc.; also for obtaining bromine from bromides. Recently it has been employed in warfare.

Liquid chlorine is produced solely from concentrated electrolytic (or Weldon) chlorine. Diluted chlorine evolved from the Deacon process is quite unsuitable for liquefaction. The process is as follows :—

The concentrated chlorine as it streams from the electrolytic cells is cooled in earthenware pipes in order to condense as much water and hydrochloric acid (if any is present) as possible; the gas then passes through concentrated sulphuric acid in order to dry it, and then into the gas holder A, which stands over concentrated sulphuric acid (Fig. 1). From A the gas passes through the tube *bcd* into the compressing pump D.

The piston M works up and down in the limb P of the U-shaped tube RS. This U tube is filled with concentrated sulphuric acid, but the surface of the acid

in *P* is covered with a layer of petroleum. The tube is widened at *R* in order to prevent the rise and fall of the liquid surface churning up the sulphuric acid and petroleum therein into an emulsion. The limb *s* communicates with the holder *T* by means of a valve *N* and a hole *l* (which can be wholly or partially closed by the screw *p*).

A water bath *H* surrounding *s* keeps the limb *s* at a temperature of 50°-80° C., so as to prevent chlorine condensing in this part of the apparatus. *x* is the strong glass tube to show the level of the liquid in *T*. The tube *g* leads to the condensing coil *K* and the strong steel holder *O*. The action is as follows:—When the plunger *M* rises in *R* the pressure is diminished, and Cl gas is sucked in from the tube *bcd* through the valve *f* into the chamber *E*. When, however, the plunger *M* descends on the return stroke, the chlorine which has entered is driven out of the chamber *E* through the valve *N* into *T*, the last traces of Cl being forced out of the chamber *E* into *T* by the excess of acid contained therein. The complete expulsion of the Cl from the chamber above *E* is essential, because in order to liquefy chlorine gas it is necessary to compress it to about $\frac{1}{16}$ of its original value, so that if only a small bubble of chlorine remained in *E* this would greatly impair the efficiency of the pump. The hole *l* prevents this, for as soon as the pressure decreases in *E*

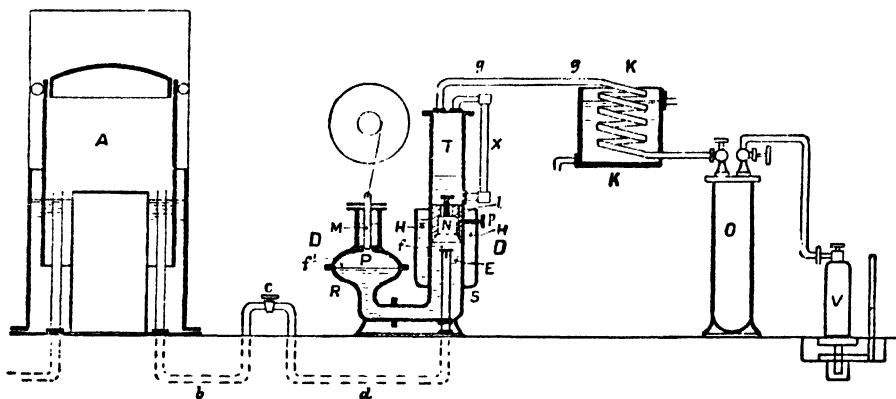


FIG. 1.—Plant for Liquefying Chlorine.

(owing to the rise of the plunger *M*) a quantity of acid is sucked from *T* through the tube *l* into this chamber *E* so as to partially fill it, and consequently somewhat less Cl is sucked into the chamber *E* from *f* than properly corresponds to the volume of the plunger *M* of the pump. When now the plunger *M* returns on its downward stroke, it follows that not only is all the Cl pressed out of *E* into *T*, but also the excess of sulphuric acid which had entered the chamber *E* through *l* is also expelled, and this stream of acid forces out the last traces of Cl from *E* into *T*.

The compressed chlorine passes away from the pump through *g* into the condensing coil *K*. Here liquefaction takes place, the liquid pouring into the strong steel vessel *O*, and then into the steel cylinder *V*, which stands upon a weighing machine. The steel transport cylinders are made of such a size that they will hold, say, 50 kg. (about 1 cwt.) of chlorine. It should be noted that for each 1 l. capacity not more than 1.25 kg. of liquid chlorine can be run in, or 1 kg. of chlorine must have allowed it 0.8 l. (The specific gravity of liquid chlorine at -10° C. is about 1.5.) 1 kg. Cl corresponds to about 300 l. of Cl. These cylinders are usually tested every two years up to 22 atmospheres pressure.

The firm, P. Schültze & Co., have placed on the market a double-action compressor for chlorine and similar very reactive gases, a section of which is shown in Fig. 2. The apparatus is worked by compressed air. The whole apparatus is made of acid-resisting cast iron. The compressing pistons for the chlorine are formed by liquid sulphuric acid of 60° B \acute{e} . contained in the two vessels *v, v*.

The sulphuric acid in these two vessels alternately rises and falls, being operated by compressed air entering through *A*. When the liquid in *v* falls, it sucks in chlorine gas through the valve *H*; and when it rises it expels the chlorine gas in a compressed condition (about 8 atmospheres) through the valve *F*. A glass tube (shown in outline) indicates clearly what is taking place in each of the vessels *v*. The chlorine gas, therefore, only comes into contact with the sulphuric acid in *v*, and the walls of *v* (which are often porcelain or lead-lined cast iron). By this means all difficulties as regards pistons, stuffing boxes, etc., are avoided. The way that the compressed air entering through *A* causes the sulphuric acid in *D* and the chambers *v, v* to alternately rise and fall is as follows:—The compressed air rushing in through *A* into the chamber *D* forces the sulphuric acid out of *D* into *v*, thereby compressing the chlorine in *v* and expelling it through *F*. When, however, the sulphuric acid is nearly expelled from *D* the floater *B* is left without support, and immediately sinking operates

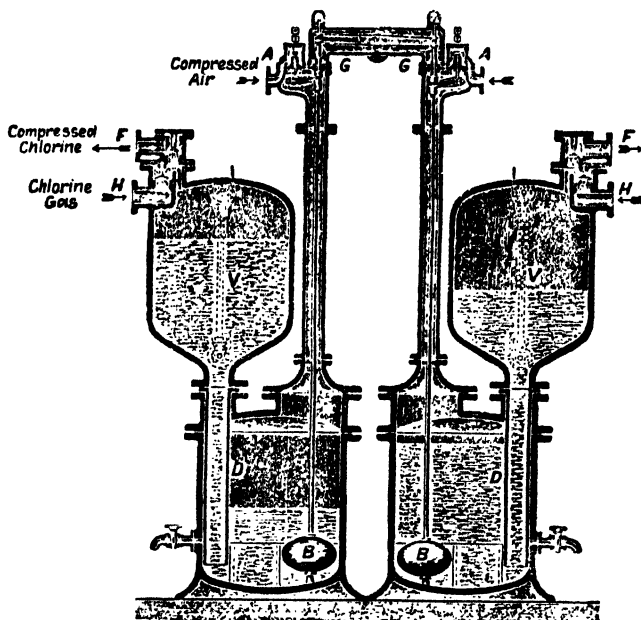


FIG. 2.—Double-Action Compressor for Liquefaction of Chlorine.

a lever which shuts off the supply of compressed air, and simultaneously opens the valve *G*, thus allowing the compressed air in *D* to escape into the air. The pressure thus falls in *D*, which causes the sulphuric acid in *v* to rush back again into *D*, thus again drawing in fresh chlorine through *H*. The mechanism is so arranged that when the sulphuric acid in one chamber *v* is rising, the sulphuric acid in the other chamber *v* is falling.

Liquid chlorine is a yellow mobile liquid, boiling at -34° C. At 15° C. it has a vapour pressure of 5.8 atmospheres, and consequently it can be easily liquefied either by compressing to 8 atmospheres and cooling with water, or by cooling to -50° C. by means of liquid CO_2 .

The specific gravity of liquid Cl is 1.5950 at -50° , 1.4685 at 0° C., 1.4257 at 15° C., 1.3141 at 50° C., 1.2228 at 75° C., and 1.1134 at 100° C.

For properties of Chlorine Gas see p. 379.

SECTION XXXVIII

MANUFACTURE OF CHLORATES
AND PERCHLORATES

BY GEOFFREY MARTIN, Ph.D., D.Sc.

LITERATURE

- LUNGE.—“Sulphuric Acid and Alkali.” 1913.
 JURISCH.—“Die Fabrikation von Chlorsauren Kali.” 1838.
 MUSPRATT.—*Journ. Soc. Chem. Ind.*, 1886, 408.
 HAMMILL.—*Journ. Soc. Chem. Ind.*, 1889, 168.
 HIGGINS.—*Journ. Soc. Chem. Ind.*, 1887, 248.
 WELDON.—*Journ. Soc. Chem. Ind.*, 1882, 41.
 KERSHAW.—“Die elektrolytische Chloratindustrie.” Halle, 1905.
 HÖLBING.—“Fortschritte in der Fabrikation der anorg. Säuren, der Alkalien,” etc., 1893-1903. Berlin, 1905.
 F. FÖRSTER.—“Elektrochemie wässeriger Lsgn.” 1905.
 B. LEPSIUS.—Berlin, 1909, 2,899.
 MUSPRATT and ESCHHELLMANN.—English Patents, 3,960, 1883; 5,183, 1883; 5,186, 1883; 1,900, 1885.

See also the following patents:—HURTER, English Patent, 15,396, 1893. BLUMENBURG, English Patent, 9,129, 1894; American Patent, 537,179. IMHOFF, American Patent, 627,063, 1899; German Patent, 110,505, 1898. LEDERLIN and CORBIN, French Patents, 226,257, 1892, and 238,612, 1894; German Patent, 136,678, 1901. UNITED ALKALI CO., English Patent, 1,017, 1899. LANDOLT, French Patent, 282,737, 1898, and German Patent, 159,747, 1904. SIEMENS and HALSKE, German Patent, 153,859, 1903.

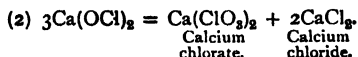
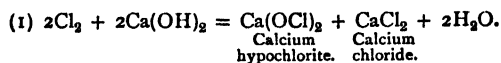
Manufacture of Sodium and Potassium Chlorate.—Potassium chlorate, KClO_3 , and sodium chlorate, NaClO_3 , form excellent oxidising agents, containing the chlorine absorbed in their formation available for oxidising purposes ($6\text{Cl} = 3\text{O}$), hence chlorates are much used for oxidising purposes in various technical processes, in the preparation of dyes, and in cloth printing; also large quantities of chlorate are used in the manufacture of explosives and matches. The chief difference between sodium and potassium chlorates is the fact that potassium chlorate is only sparingly soluble in cold water, but readily soluble in hot, so that it is easy to obtain this substance in a finely crystalline and pure condition. Sodium chlorate, however, is easily soluble in cold water as well as in hot, and so in cold aqueous solution is somewhat easier to use than potassium chlorate, but more difficult to manufacture.

Two processes of manufacture are in use. According to the old process chlorine gas is led into hot milk of lime, and the difficultly crystallisable calcium chlorate thus produced is converted into potassium or sodium chlorate by adding excess of KCl (or NaCl).

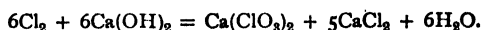
The more recent electrolytic process is being largely worked in the United States (Niagara Falls), Sweden, and the Alps, where cheap hydro-electric power is available. However, the old process at the time of writing is holding its own against these newer processes. We will describe each process in turn.

Old Process for Manufacture of Chlorates.—Milk of lime is placed in a large iron cylinder provided with a stirring apparatus, and a stream of chlorine

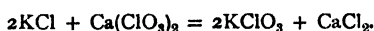
is led into the liquid. Heat is evolved, and the liquid spontaneously increases its temperature to 40°-50° C., when the calcium hypochlorite at first formed is almost entirely decomposed into chlorate, according to the equations:—



Or expressed in one equation:—



Towards the end of the reaction a pink colour appears in the liquid, due to the formation of small quantities of permanganate, owing to the presence of traces of manganese in the lime. The liquid is now neutralised and filtered, and then excess of KCl is added, when potassium chlorate is formed and crystallises out:—



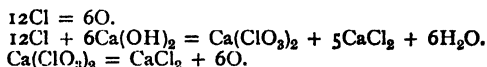
On cooling the mother liquors strongly with special refrigerating machines a further crop of KClO_3 separates. The mother liquors are very rich in CaCl_2 , the technical utilisation of which (as in the Weldon and Ammonia-Soda processes) is one of the unsolved problems of chemical industry (see this Volume, p. 341).

The potassium chlorate is freed from chloride by recrystallisation. The preparation of **sodium chlorate** differs from that of potassium chlorate, owing to the fact that it is much more easily soluble in cold water, and thus more difficult to separate by crystallisation. 100 parts of cold water at 20° C. dissolve 7.3 parts of KClO_3 against 99 parts of NaClO_3 . Hence in this case the procedure is as follows:—To the neutralised and filtered calcium chlorate solution excess of NaCl solution is added, and the liquor allowed to evaporate until calcium chloride, CaCl_2 , separates out in a crystalline state. Now Glauber salt (sodium sulphate) is added so as to precipitate the rest of the calcium salts in solution as calcium sulphate:—



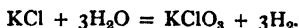
The sodium chloride and sodium chlorate in the mother liquors are then separated by crystallisation, sodium chloride being much less soluble in water than sodium chlorate.

In practice it is found that about seven times more chlorine is necessary to produce 1 part of potassium chlorate than the same weight of bleaching powder. From the preceding equations it will be seen that, theoretically, some five-sixths of the chlorine used passes away as the almost worthless CaCl_2 (practically considerably more than five-sixths of the used chlorine is wasted), but the chlorine thus absorbed is converted into the equivalent amount of available oxygen in the resulting chlorate. This is seen from the equations:—



Manufacture of Chlorates and Perchlorates by Electrolysis.—When an electric current is passed through a hot aqueous solution of potassium chloride, KCl, the current, under certain conditions, can split up the water, oxygen being evolved at the + pole (anode) and hydrogen at the - pole ($\text{H}_2\text{O} = \text{H}_2 + \text{O}$). The KCl also undergoes decomposition, KOH and hydrogen being produced at the - pole and Cl at the positive pole ($\text{KCl} = \text{K} + \text{Cl}$; $\text{K} + \text{H}_2\text{O} = \text{KOH} + \text{H}$). If, however, these different products are not automatically separated as formed, but are liberated under such conditions that they can all react together at a temperature of 45°-100° C., we get the chlorine absorbed by the KOH formed, forming hypochlorite ($2\text{KOH} + 2\text{Cl} = \text{KClO} + \text{KCl} + \text{H}_2\text{O}$), and the nascent oxygen also absorbed in oxidising the hypochlorite to chlorate ($\text{KClO} + 2\text{O} = \text{KClO}_3$). Also the hypochlorite spontaneously decomposes into chlorate ($3\text{KClO} = \text{KClO}_3 + 2\text{KCl}$). It is

thus possible, by carrying out the electrolysis of KCl solution under suitable conditions, to obtain an excellent yield of KClO_3 , the final result being expressible by the equation :—



Practically only traces of free oxygen or chlorine are evolved.

Gall and Montlaux (Switzerland) were the first (1889-1890) to successfully produce chlorates on the large scale by electrolytic processes, and so long ago as 1900 their factories at Vallorbe and S. Michel were producing some 3,000-3,500 tons of chlorate annually.

The first cells of this firm were provided with diaphragms, and the alkaline cathodic liquors were transferred to the anodic compartment by special means. At the present time, however, the use of diaphragms has been given up, and the neutral KCl solution is simply electrolysed, using platinum-iridium net anodes with stirrers in the cell to bring the chlorine into contact with the KOH produced at the cathode.

The bath is heated by the passage of the current to over 40°C . The bath liquors, when containing sufficient KClO_3 , are removed, the KClO_3 allowed to crystallise out, and the mother liquors, again saturated with KCl, are allowed to run back into the electrolyser.

In **Gibb's Process**, as used at the National Electrolytic Co., at Niagara Falls, N.Y., the cell consists of a wooden trough lined with lead and divided into a number of compartments. Fig. 1 shows a longitudinal section through the cell. The anodic surfaces *B* are sheet-lead covered over with platinum foil. The cathodes consist simply of a number of copper wires *c*, fixed vertically in the cell by insulating bars *o*. *F, F* are insulating strips. A continuous stream of alkali chloride solution is led in through *G* to the bottom of the apparatus, and the chlorate produced in the cell, together with unchanged KCl and *H* gas, escapes through the openings *h*.

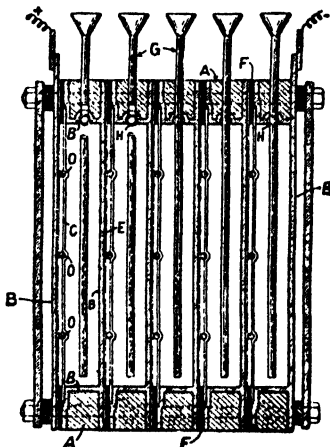


FIG. 1.—Gibb's Electrolytic Cell for Chlorate.

The temperature of the bath is kept at $60^\circ\text{-}70^\circ \text{C}$., when the brine flows through the cells at the rate of 28 l. per hour, while the yield from the current is about 70 per cent. of theory. The current density employed amounts to 55 amperes per square metre at the anode, the current going through the series of cells being 1,650 amperes. The works at Niagara use 2,000 H.P. from the falls. The escaping liquors must not contain more than 30 per cent. chlorate per litre.

In **Lederlin and Corbin's Cell** (see French Patents, 226,257 of 1892, and 238,612, of 1894) a large number of platinum foil electrodes *c* (Fig. 2), fixed close together in ebonite holders *B* in a tank of cement, are employed. The hot current of alkali chloride solution, entering at *o*, flows between these electrodes *c*, and so is converted into chlorate in the usual way. The solution of chlorates run off at *q*. *G* and *H* are wooden supports for the ebonite holders. This apparatus has been successfully employed on the large scale, and has been working since 1895 in a number of Continental factories.

Since the formation of potassium chlorate takes place according to the equation :—

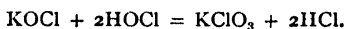


(only very little oxygen being evolved through secondary decomposition of water), about $\frac{1}{2}$ cub. m. of hydrogen gas is evolved to every 1 kg. KClO_3 produced.

Considerable losses of current ensue by the reduction of the hypochlorite formed at first by the hydrogen evolved at the cathode, and many proposals have been made to overcome this difficulty. Thus the addition of 0.2 per cent. CaCl_2 (see French Patent, 283,737 ; German Patent, 159,747, of 31st May 1904) or the presence of potassium dichromate and HCl (see German Patents, 110,505,

of 29th March 1898, and 136,678, of 12th April 1901) considerably reduce the loss, possibly owing to the formation on the cathode of a thin layer of $\text{Ca}(\text{OH})_2$ or $\text{Cr}(\text{OH})_3$, which acts as a diaphragm and prevents the evolved hydrogen too readily from coming into contact with the hypochlorite generated. When chromate is used the temperature of the bath is kept at 75°C . The United Alkali Co. (English Patent, 1,017, 1899) add aluminium salts, or clay, or silicic acid to the electrolyte for the same purpose; Siemens and Halske (German Patent, 153,859, of 22nd March 1903) add fluorides, while the German Solvay Works (German Patent, 174,128, of 11th January 1905) add soluble vanadium compounds—all of which processes raise the current yield of chlorate.

The slight evolution of chlorine at the beginning of the electrolysis may be avoided by adding KOH to the bath, a process, however, which diminishes the yield from the current employed. Better yields are obtained by keeping the electrolyte slightly acid, when the free hypochlorous acid formed promotes the formation of chlorate according to the equation:—



The current needed for producing one gram-molecule (122.5 g.)—

$$\text{KClO}_3 = 6\text{Cl} = \frac{.96540 \times 6}{60 \times 60} = 161 \text{ amperes per hour.}$$

A current of 1 ampere in twenty-four hours can yield 18.3 g. KClO_3 .

The manufacture of sodium chlorate, NaClO_3 , from salt (NaCl) is carried out just as the manufacture of KClO_3 from KCl , but owing to the great solubility of

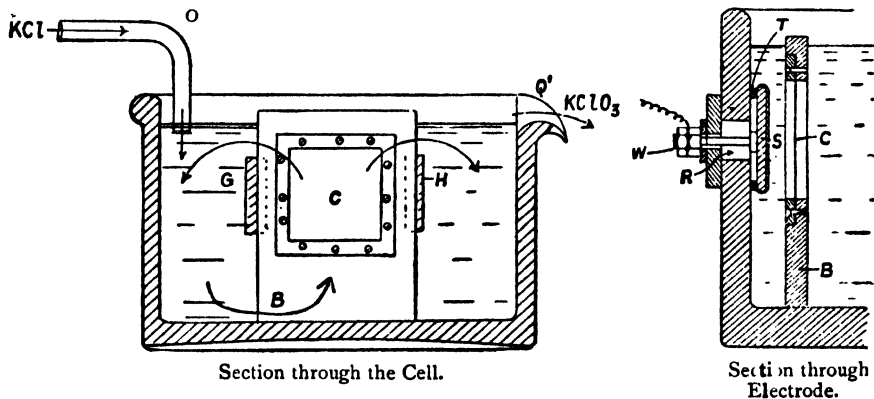
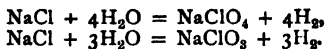


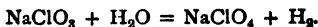
FIG. 2.—Lederlin-Corbin Electrolytic Cell for Chlorate.

NaClO_3 in water a complete separation of the NaClO_3 from the NaCl is only attained by repeated recrystallisation.

Manufacture of Perchlorates.—When the percentage of sodium chloride in the electrolytic bath falls below 5 per cent. perchlorate, NaClO_4 , is formed, together with chlorate, NaClO_3 :



If the temperature is kept low and the current density small all the chlorate will disappear, being converted into perchlorate—



With 10 per cent. NaCl or more in solution perchlorate is not formed in noticeable quantities, and also perchlorate is not formed in hot baths. The conditions of formation of perchlorate from chlorides, therefore, are dilute solutions of chloride, low temperatures, and low current densities. However, in the manufacture of perchlorates, usually they are not obtained directly from chloride solutions, but the chloride is converted first into chlorate, and then the chlorate so obtained is electrolysed into perchlorate.

Winteler (*Chemiker Zeit.*, 1898, 89) has worked out in detail the best conditions. Assuming that the solution only contains chlorates, he finds that these conditions are:—(1) A low temperature at anode, (2) an acid solution at anode, (3) current density, 8-12 amperes per square metre, (4) high concentration of the electrolyte, (5) artificial cooling of the electrodes.

Lederlin (German Patent, 136,678, of 1901) adds bichromate to the electrolyte (best by adding chromate and then at periodic intervals running in some free HCl). He claims that this procedure greatly increases the yield of perchlorate. Wilson (German Patent, 143,347, of 1902) advises the presence of a little free chlorine in the bath.

Couleru (*Chem. Zeit.*, 1906, 30, 213) states that the electrolysis of the NaCl solution is continued until a solution containing some 750 g. per litre of sodium chlorate, NaClO₃, is obtained—thereby saving the expense of concentrating the liquid. A crude sodium chlorate is deposited from this solution, which is then redissolved in water, and so a solution containing practically only chlorate is obtained, the presence of chloride or hypochlorite being injurious. This chlorate solution is then electrolysed for perchlorate, using platinum anodes and iron cathodes, the electrolysis being carried out in as concentrated a solution of chlorate as possible.

Any alkali formed is neutralised, and the bath is kept between 8° and 10° C., a temperature over 25° C. being very injurious indeed. The temperature is kept low either by means of cooling coils inserted in the bath, or else the electrodes are themselves cooled internally, special refrigerating machines being used for the purpose.

The current density, and also the addition of various substances to the electrolyte, does not effect to any great degree the yield, which amounts to 85 per cent. of theoretical. The electrolysis should be continued until all the chlorate is converted into sodium perchlorate, which, being very soluble in water, does not crystallise out. Sodium perchlorate, moreover, is hygroscopic, and so is quite unsuitable for the manufacture of explosives and fireworks. It is therefore never isolated as such, but is always directly converted into the more convenient and non-hygroscopic **potassium perchlorate**, KClO₄, or **ammonium perchlorate**, NH₄ClO₄, by adding to the content sodium perchlorate solution excess of KCl or ammonium salts (3NH₄Cl or NH₄NO₃), and crystallising out.

KClO₄ is only sparingly soluble in cold water, 1,000 c.c. cold water merely taking up 15 g. KClO₄, and hot water some 180-225 g., so that it is very easily separated by crystallisation from NaCl, which is much more soluble in cold water. 1,000 c.c. cold water dissolves 250 g. ammonium perchlorate, and so the ammonium perchlorate is somewhat more difficult to free from NaCl by crystallisation; however, as the solubility of the ammonium salt rapidly increases with the temperature, in practice not much difficulty is experienced in preparing pure ammonium perchlorate.

The crude salts which crystallise out are washed with a little water, and are obtained easily 99 per cent. pure. They are dried with steam, or hot air, at a temperature below 100° C.

In a wet state the substances are not in any way dangerous; when dry, however, and mixed with oxidisable organic matter, they may set up dangerous explosive combustion, and accidents have occurred owing to workmen's clothing becoming impregnated with the liquors, which have then dried.

Considerable amounts of perchlorates are manufactured for explosives, perchlorates being better adapted for this purpose than chlorates, both on account of their greater stability and their higher percentage of oxygen.

Analysis.—The amount of perchloric acid is not estimable by titration, as the contained oxygen is not active. The amount of metal in the salt is, therefore, obtained in the usual gravimetric manner, and so the amount of perchlorate is calculated from this.

SECTION XXXIX

BLEACHING POWDER AND HYPOCHLORITES

BY GEOFFREY MARTIN, D.Sc., Ph.D.

LITERATURE

- LUNGE.—“ Sulphuric Acid and Alkali.” 1913.
 ENGELHARDT.—“ Hypochlorite und Elektrische Bleiche.” 1903.
 G. ANGEL.—*Chem. Ztg.*, 1928, **52**, 962; *Ind. Chem.*, 1932, **9**, 300.
 A. J. JAFET.—*Chemica*, 1933, **1**, 65.
 C. PAOLINI.—Austrian Patent 121,976.
 GIORN.—*Chem. Ind. Appl.*, 1930, **12**, 9.
 British Patents 391,078, 396,256 (1933), 317,437, 317,727, 357,933.

BLEACHING POWDER

WHEN moderately dry¹ slaked lime is treated with chlorine in the cold, it absorbs some 35-36 per cent. of chlorine to form a dry white powder, which possesses strong bleaching and disinfecting properties, and is known as “bleaching powder” or “chloride of lime.” These properties arise from its power of giving off the absorbed chlorine again when treated with acids. Although commercial bleaching powder usually contains only 35-36 per cent. “available” chlorine, yet, if the temperature of the lime be kept between 30° C. and 40° C., a bleaching powder containing some 40 per cent. of available chlorine may be obtained. Under very special circumstances lime has been known to take up as much as 43.5 per cent. of “available” chlorine. The actual amount of available chlorine in bleaching powder depends greatly on the mode of manufacture, its age, etc.

The following are typical analyses of good bleaching powder:—

	Per Cent.		Per Cent.
<i>Available chlorine</i> - - -	36-38.3	<i>Alumina</i> - - -	0.3-0.4
<i>Chlorine as chloride</i> - - -	0.32-0.60	<i>Manganese oxide</i> - - -	trace
<i>Chlorine as chlorate</i> - - -	0.08-0.26	<i>Carbonic acid</i> - - -	0.2-0.5
<i>Lime</i> - - -	43.5-44.5	<i>Silica</i> - - -	0.3-0.5
<i>Magnesia</i> - - -	0.3-0.4	<i>Water and loss</i> - - -	16.3-17.0
<i>Ferric oxide</i> - - -	0.02-0.05		

Lunge and Schäppe made a bleaching powder with perfectly pure lime so as to obtain the greatest absorption possible of chlorine. The sample contained:—

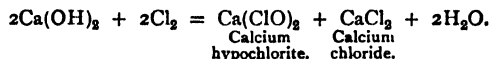
	Per Cent.
<i>Available chlorine</i> - - -	43.13
<i>Chlorine as chloride</i> - - -	0.29
<i>Lime</i> - - -	39.89
<i>CO₂</i> - - -	0.42
<i>H₂O</i> (direct estimation) - - -	17.00

100.73

In 1785 C. L. Berthollet, in Paris, discovered the bleaching action of “Javel water,” produced by the action of chlorine on potash. Watt brought the news to Glasgow, and in 1798 Charles Tennant patented a process for use of cheaper lime instead of potash, this patent being subsequently declared void because lime had been used for the same purpose in Lancashire for some years prior to Tennant’s patent. It was therefore only natural that the action of the chlorine in the

¹ Perfectly dry slaked lime, Ca(OH)₂, is not acted on at all by chlorine. For the best results the lime should contain some 4 per cent. of excess water over that required for the formula Ca(OH)₂, and the lime should be as pure as possible.

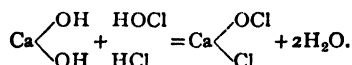
Ca(OH)_2 was thought to be similar in nature to that which occurs when chlorine is led into cold KOH or NaOH solutions, when potassium or sodium hypochlorites (KClO or NaClO) are formed, and so bleaching powder was at first thought to be merely a mixture of CaCl_2 and calcium hypochlorite, Ca(ClO)_2 , produced thus:—



However, it seems practically certain that **ordinary dry** bleaching powder does not contain calcium hypochlorite, Ca(ClO)_2 , as such, and the exact constitution of dry bleaching powder or "chloride of lime" is still a matter of dispute. Balard gave it the formula $\text{Ca(OC}l)_2 \cdot \text{CaCl}_2 + \text{Ca(OH)}_2$; while Stahlschmidt proposed the formula $\text{Ca(OC}l)(\text{OH}) \cdot \text{CaCl}_2 \cdot 2\text{H}_2\text{O}$. However, the formula now most favourably received is that suggested in 1861 by W. Odling, who assumed that the essential component of bleaching powder was the compound $\text{Cl}-\text{Ca}-\text{OCl}$, which is mixed with uncombined lime, Ca(OH)_2 .

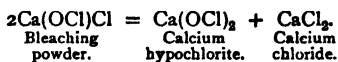
Commercial bleaching powder is best represented by such a formula as $\text{Ca(OC}l)\text{Cl} + n \cdot \text{Ca(OH)}_2$, where n = nearly $\frac{1}{2}$, that is to say, $2\text{Ca(OC}l)\text{Cl} + \text{Ca(OH)}_2$.

The formation of the compound $\text{Cl}-\text{Ca}-\text{OCl}$ could be regarded as due to the neutralisation of lime by a molecule of each of the monobasic acids formed by the action of chlorine on moisture present in the lime, thus:—

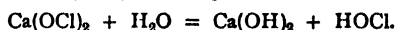


It is very probable that Odling's formula is correct, and that dry bleaching powder does not contain any calcium chloride as represented by Balard's and Stahlschmidt's formulæ, for the following reasons:—(1) The chlorine can be completely expelled from bleaching powder by moist CO_2 at 70°C ., whereas CaCl_2 is not so decomposable. (2) Good bleaching powder is not deliquescent, as it would be if CaCl_2 as such was present in it; also CaCl_2 is readily soluble in alcohol, whereas alcohol extracts very little CaCl_2 from bleaching powder. (3) Bleaching powder cannot be made to take up more than 43.5 per cent. of Cl .

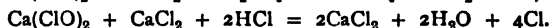
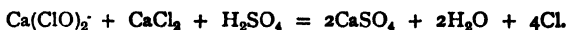
Although ordinary bleaching powder is regarded as not containing calcium hypochlorite, $\text{Ca(OC}l)_2$, as such, but rather the compound $\text{Cl}-\text{Ca}-\text{O}-\text{Cl}$, yet this only applies to *dry* bleaching powder. As soon as the bleaching powder is thrown into excess of cold water it is decomposed thus:—



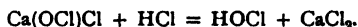
The calcium hypochlorite, Ca(ClO)_2 , and calcium chloride pass into solution, whilst the unchanged calcium hydroxide forms an insoluble layer at the bottom, the solution possessing an intensely alkaline reaction owing to the presence of some dissolved Ca(OH)_2 , which, of course, is a strong base. It has been suggested that hydrolysis takes place, thus:—



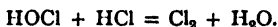
The practical application of bleaching powder depends upon the fact that when excess of acid is added to the solution, practically all the chlorine is evolvable as free chlorine, thus:—



It is probable that the liberation of chlorine by acids is due first to the formation of hypochlorous acid, HOCl , thus:—



The hypochlorous acid formed is very unstable and decomposes with excess of acid liberating chlorine, thus:—



Very dilute acid added to bleaching powder liberates hypochlorous acid, HOCl , alone.

It is the amount of chlorine thus set free, the "available chlorine" as it is called, which determines the technical value for bleaching purposes.

In bleaching with bleaching powder or with sodium or potassium hypochlorite, the fabric is steeped in a dilute aqueous solution of the bleaching agent, and then in dilute acid. Hypochlorous acid, HClO , is liberated as above described, and then free chlorine. The chlorine acts on the moisture of the wet fibre, liberating

nascent oxygen ($\text{H}_2\text{O} + \text{Cl}_2 = 2\text{HCl} + \text{O}$) which oxidises the colouring matter of the fibre into a colourless oxidation product, and so "bleaches" the fibre.

Treating with acid in this manner causes a rapid and energetic bleaching action to take place. However, treating the fabric with a dilute aqueous solution of bleaching powder causes a moderate and even bleaching action, which is accelerated by the action of atmospheric CO_2 .

The bleaching action of hypochlorous acid is generally stated to be twice that of the chlorine it contains, supposing that this latter were to be in a free state, as may be seen from the two equations:—



However, as seen from the equation representing the manufacture of bleaching powder or hypochlorites (*e.g.*, $2\text{Ca}(\text{OH})_2 + 4\text{Cl} = \text{Ca}(\text{ClO})_2 + \text{CaCl}_2 + 2\text{H}_2\text{O}$, $2\text{KOH} + 2\text{Cl} = \text{KOC} + \text{KCl} + \text{H}_2\text{O}$), since two atoms of chlorine are required to form one molecule of HOCl (since an equivalent of HCl is formed at the same time), this advantage appears practically to be somewhat illusory.

Manufacture of Bleaching Powder.—For the manufacture of good quality bleaching powder the lime must be carefully slaked so as to form a dry powder, containing about 4 per cent. more water than corresponds to the formula $\text{Ca}(\text{OH})_2$. Perfect dry lime does not absorb chlorine at all. The lime should be as pure as possible, and is passed through a sieve before use. The chlorine gas should be cool and dry, and carefully freed from HCl; it should not contain much CO_2 . The presence of a little CO_2 in electrolytic or Weldon chlorine (which is very concentrated) does not matter, because CO_2 acts on the $\text{Ca}(\text{OH})_2$ much more slowly than the chlorine. Generally speaking, 64 parts of slaked lime yield 100 parts of 36 per cent. bleaching powder.

For the manufacture of bleaching powder two kinds of technical chlorine are available—(1) The very concentrated Weldon or electrolytic chlorine, which acts rapidly and energetically on the lime. (2) The very dilute Deacon's chlorine, which acts less energetically. Entirely different plants are used with these two kinds for chlorine, and we will describe each separately.

1. Manufacture of Bleaching Powder from Concentrated Weldon or Electrolytic Chlorine.—The lime is spread in 3 or 4 in. layers on the floor of a large "chlorine chamber," some 6 or 7 ft. high, 10-20 ft. wide, and 100 ft. long. The walls are made out of tarred or asphalted sandstone slabs (asphalt being very resistant towards chlorine); in modern practice, however, the top and sides are made of sheet lead fastened by straps on timber work, like vitriol chambers. The entrance is covered over with asphalted iron plates. The layer of chlorine is raked into furrows in order to expose a larger surface, and a stream of chlorine is led into the chamber from one of the ends of the chamber; an opening in the other end of the chamber allows the air to escape. Two windows allow the interior to be viewed and the flow of chlorine to be turned off as soon as the chamber is full. The outlet is also closed when the chamber is filled with chlorine. The chlorine enters through a pipe placed at one end near the roof of the chamber; being a heavy gas it sinks downwards, and is at first rapidly absorbed by the lime; later the absorption becomes slow and the temperature rises, but great care must be taken that this latter never exceeds 25°C . Great excess of chlorine should also be avoided, and so usually a definite amount of chlorine is let into the chamber; the chamber is closed and allowed to stand some twelve to twenty-four hours. In order to expose a fresh surface the lime is turned over from time to time. Finally, before allowing workmen to enter the chamber and remove the bleaching powder, the last residues of chlorine must be sucked out, either by passing in a stream of air, or simply by injecting some finely powdered lime dust (English Patent, 7,199, 1886; *cf.* "Twenty-third Report on Alkali, etc., Works," 58-60), which absorbs most of the chlorine.

A chamber making 10 tons of bleaching powder and containing fair excess of chlorine requires some 4-5 cwt. of lime dust blown in through a special fan or distributor. This reduces the Cl in the chambers to about 0.8 gr. per cubic foot, producing 6 cwt. of extra bleaching powder, and requiring about two hours to settle. Before allowing workmen to enter, the air of the chambers

(which should be tested by the works' chemist) should not contain more than $2\frac{1}{2}$ gr. of Cl per cubic foot. Bleaching powder chambers should have about 200 sq. ft. of chamber space per ton of bleaching powder made per week (see "Twenty-first Report on Alkali, etc., Works," p. 12, for rules).

The bleaching powder is then packed into very well-made wooden casks (but of hard wood) for transport and storage.

The ends are coated with plaster of Paris to prevent access of air, which soon spoils the powder; the full casks must be stored in a cool, dry place, both rain and sunshine damaging the material.

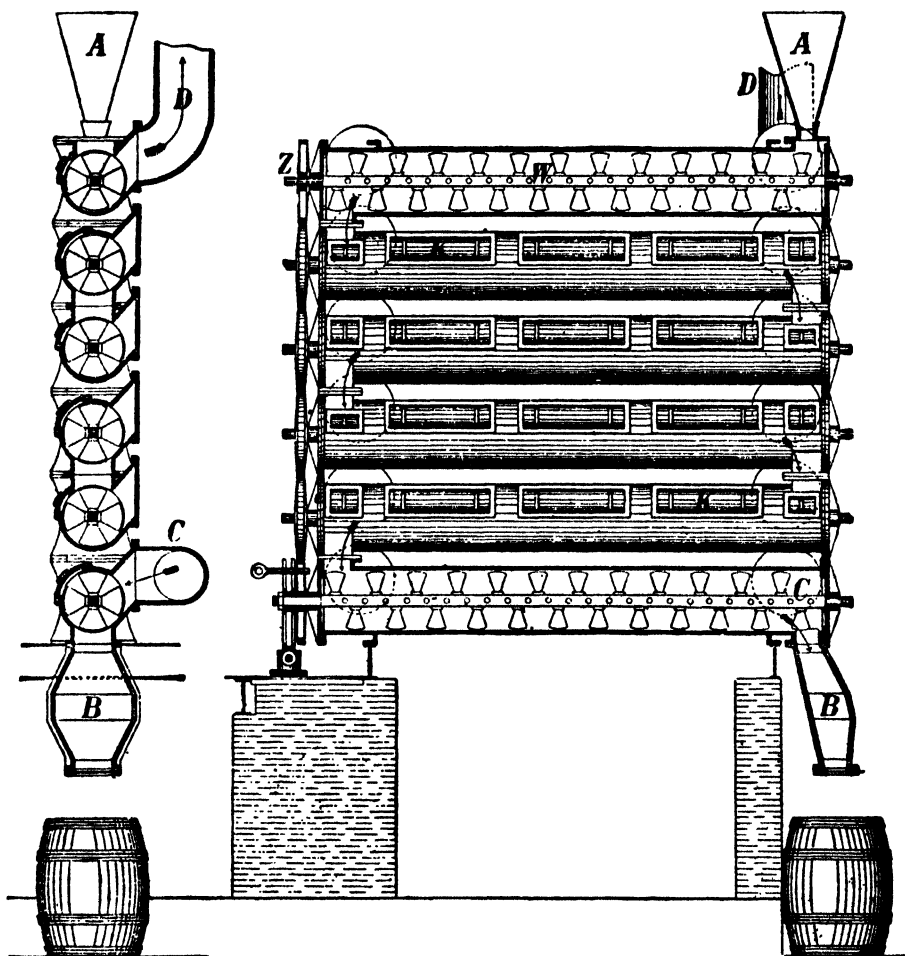


FIG. 1.—Hasenclever's Cylinder Apparatus for Bleaching Powder.

The *yield* of bleaching powder is usually $1\frac{1}{2}$ times the weight of the slaked lime.

Since the raking over and indeed entry of the chlorine chambers by workmen is very injurious for the health, and has often been attended by fatal accidents, many devices have been proposed and adopted for minimising the risks. In some forms of apparatus the lime is laid on perforated shelves of the chlorine chambers, and the raking of the half-finished bleaching powder is entirely worked from outside by mechanical appliances. In the *Bachmann Plant* a series of super-imposed shelves rotate slowly around a central shaft. Lime is fed in at the top and chlorine at the bottom. See *Ind. Chem.*, 1933, 9, 300; also G. ANGEL, *Chem. Ztg.*, 1928, 52, 962.

2. Manufacture of Bleaching Powder from Dilute Deacon Chlorine.

—The diluted chlorine evolved from the Deacon process is not suitable for making a good bleaching powder from the chamber process above described, and so an entirely different sort of apparatus is usually employed, being known, from the name of its inventor, as "Hasenclever's Cylinder Apparatus" (English Patent, 17,012, 1888). It is illustrated in Fig. 1.

The apparatus consists of six or eight cast-iron cylinders, lying vertically one above the other, of length some 12-20 ft., each provided with a feeding worm *w*, which is kept revolving slowly by means of the cog-wheels *z*. The slaked lime is poured in at *A* into the topmost cylinder, and is gradually moved downwards, as indicated by the arrows, from cylinder to cylinder until it finally escapes from the bottom cylinder at *B*. Meanwhile the Deacon chlorine, freed as much as possible from HCl and CO_2 , is passed at *c* into the bottom cylinder, and streams along in a direction opposite to that of the moving slaked lime, finally escaping at the topmost cylinder by the pipe *D*. The chlorine is all absorbed by the lime, and there escapes at *D* a practically chlorine-free gas. The bleaching powder is let out from *B* from time to time into a wooden cask situated below. Since chlorine gas might attack the iron work of the spur wheels, the latter are painted with BaSO_4 (Blanc fixe). Each of the cylinders is provided with a number of lids *k, k*, which can be removed when the apparatus becomes blocked up, or when some other disturbance necessitates the interior of the cylinders being investigated.

By this apparatus no danger results to the workmen (as in the chamber process), because they do not come into contact either with the lime dust or with the chlorine fumes. The resulting bleaching powder contains about 36 per cent. of available chlorine.

The apparatus cannot be used for the production of bleaching powder from concentrated chlorine, such as comes from the Weldon or electrolytic processes, because the lime would heat up too quickly.

Deacon's Apparatus consists of chambers provided with large numbers of shelves; the lime is spread in 1-in. layers on these shelves, and the chlorine allowed to circulate over them in such a manner that the strongest Cl comes into contact with nearly finished bleaching powder, and the last gas, containing only traces of Cl , is passed into fresh lime.

Manufacture of Pure Calcium Hypochlorite.—Pure calcium hypochlorite, $\text{Ca}(\text{ClO})_2$, has recently been manufactured by the Griesheim-Elektron Company (German Patent, 188,524, of 27th April 1906) by slowly passing chlorine gas into a cold aqueous milk of lime, filtering the liquid, and evaporating the still alkaline liquid in vacuum when colourless crystals of $\text{Ca}(\text{ClO})_2$ separate. These are washed and dried *in vacuo* when a dry white powder, free from moisture and water of crystallisation, is obtained in which no less than 80-90 per cent. of the chlorine present is in the form of available chlorine. It is claimed that this kind of bleaching powder is more stable and keeps better than that obtained by usual methods. The crystals, if not rapidly deprived of water, lose much chlorine.

According to another patent taken out by the same firm (German Patent, 195,896, of 10th March 1907) if the chlorination be carried out with a concentrated solution of slaked lime, so that the specific gravity of the filtered solution exceeds 1.15, then we get precipitates of double compounds of lime and calcium hypochlorite, of composition $\text{Ca}(\text{OCl})_2 \cdot 2\text{Ca}(\text{OH})_2$ and $\text{Ca}(\text{ClO})_2 \cdot 4\text{Ca}(\text{OH})_2$. These insoluble substances require a considerable volume of water to split them up and withhold from effective use a considerable amount of available chlorine, causing much of the milkiness in the ordinary solutions of bleaching powders. However, if the passage of chlorine into the liquid is continued these compounds are gradually attacked, the $\text{Ca}(\text{OH})_2$ taking up chlorine and being converted into $\text{Ca}(\text{ClO})_2$. Hence, in order to prepare very strong solutions, we must first of all add to a chlorinated slaked lime solution a weighed quantity of slaked lime, when a precipitate occurs of the above compounds; then chlorine gas is passed in until the precipitates are dissolved again by the complete chlorination of the lime. By repeating the addition of lime and leading in chlorine again, it is possible to obtain calcium hypochlorite solutions of almost any strength until the pure $\text{Ca}(\text{OCl})_2$ crystals begin to separate. The presence of CaCl_2 solutions favours the crystallisation.

Valuation of Bleaching Powder.—For typical analyses of bleaching powder see p. 391. Bleaching powder is a very unstable substance. It is decomposed by atmospheric moisture, the carbon dioxide of the air acting as a feeble acid as above indicated (p. 392). It even decomposes slowly when kept in a well-stoppered bottle. The loss of available chlorine on storage in a cool, dark place (where it is at a minimum) amounts to $\frac{1}{4}$ per cent. to $\frac{1}{2}$ per cent. per month. In sunlight the loss is much more rapid than this, and is attended with the evolution of oxygen. The solution is much more unstable than the dry solid, decomposing on warming in two different directions, as represented by the two equations:—

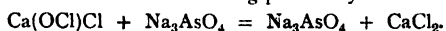


It is, of course, very important to determine the amount of "available" chlorine present in a sample of bleaching powder.

This is done as follows:—

A weighed quantity of bleaching powder is thoroughly ground with water and made up to a measured volume by dilution with water. This solution is then titrated by adding excess of KI solution. On adding acetic acid, chlorine is liberated from the bleaching powder, which sets free its equivalent of iodine ($\text{Cl}_2 + 2\text{KI} = 2\text{KCl} + \text{I}_2$), which latter is then titrated in the usual way with starch and sodium thiosulphate. 1,000 c.c. of $\frac{N}{1}$ sodium thiosulphate used up correspond to 35.5 g. of available chlorine present.

Another method is to titrate the bleaching powder solution with decinormal sodium arsenite solution, the end of the reaction being determined by means of starch, and KI used as an outside indicator. When the titration is complete a drop of the liquid, removed and placed on paper impregnated with starch and KI, will no longer give a blue stain. The amount of sodium arsenite solution used up is related to the amount of bleaching powder by the following equation:—



In other words, 1,000 c.c. of $\frac{N}{1}$ sodium arsenite solution used up correspond to 35.5 g. of available chlorine.

In some works, especially in Germany, bleaching liquids are obtained on the spot as required, by passing chlorine gas (evolved from liquid chlorine in steel cylinders) directly into milk of lime. Sometimes a solution of bleaching powder is treated with solutions of sodium, magnesium, or aluminium sulphates, when strong bleaching solutions of sodium hypochlorite, magnesium hypochlorite, or aluminium hypochlorite are obtained. These solutions bleach in alkaline solution somewhat more rapidly than bleaching powder (calcium hypochlorite) solution, but they cannot be obtained in the solid form (see, however, p. 395).

Use of Bleaching Powder as a Disinfectant.—A solution of bleaching powder is a very valuable disinfectant. One part of bleaching powder will, in three hours, sterilise 2,000 parts of ordinary sewage.

Electrolysed brine (see p. 402) has been used as a disinfecting fluid. It is claimed that it is cheaper (even if produced by the local authority) and more effective than most other materials.

Electrolytic Bleaching.—When an electric current is passed through a solution of common salt without the intervention of a diaphragm, so that the liquids around the cathode and the anode are free to mix, we do not get chlorine gas evolved as such, but rather a solution of sodium hypochlorite is produced by the interaction of the nascent chlorine evolved at the anode and the caustic soda produced at the cathode, thus:—



This solution may then be run off immediately and used for bleaching purposes.

Within the last twenty years this method has largely displaced the use of bleaching powder in certain works, and the process is said to be rapidly extending. The process was first brought to a commercially successful issue by Hermite and Kellner, and on the Continent the plants most in use are those of Schuckert, Kellner, and Öttel.

It is usual to electrolyse a 10 per cent. neutral salt solution, keeping the liquid cool by special arrangements. The best electrodes to use are platinum-iridium

(since hypochlorites attack most other substances rapidly), and for success it is essential that the electric current "density" should be about 1,000-1,500 amperes per square metre electrode surface. At first a yield of hypochlorite of over 90 per cent. is obtainable by the electric current employed, but this soon sinks (on account of the reducing action of the evolved hydrogen at the cathode) until it becomes impossible, without the expenditure of very large amounts of electrical energy, to obtain solutions containing more than 3 per cent. of available chlorine. With low current densities much of the hypochlorite is reduced by the nascent hydrogen evolved at the cathode to chloride, $\text{NaClO} + 2\text{H} = \text{NaCl} + \text{H}_2\text{O}$, whilst at the anode the NaClO tends to oxidise to NaClO_3 (see p. 386). Much better yields are obtained when some CaCl_2 is added to the solution, and when concentrated NaCl solutions are used. For example, a 20 per cent. NaCl solution can yield a liquid containing 3 per cent. available chlorine, with a yield of 50 per cent. of that theoretically obtainable from the current employed, whereas a 10 per cent. NaCl solution, with the same expenditure of current, will only give a liquid containing 2 per cent. available chlorine. However, the concentrated NaCl solutions use up

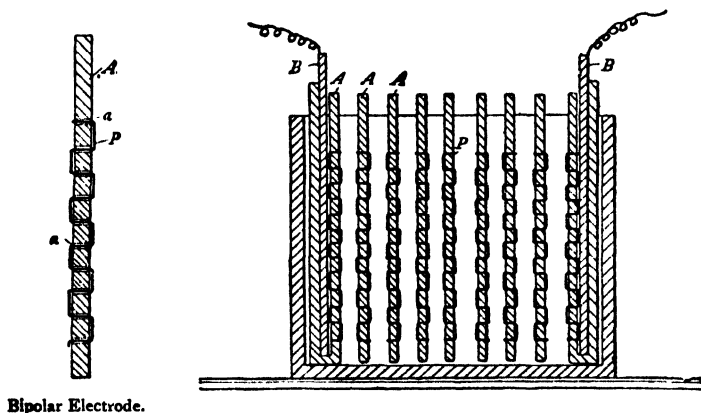


FIG. 2.—Kellner's Electrolytic Cell for Hypochlorites.

more NaCl than the more dilute, and in practice it seems to be more economical to employ 10 per cent. solutions rather than more concentrated ones. Moreover, careful cooling of the liquid must be resorted to, otherwise a great loss of hypochlorite results owing to its conversion into chlorate (see p. 386).

The subject of the formation and preservation of hypochlorites in solution was attacked by Muspratt and Smith in 1898 and 1899. By passing chlorine into the strongest possible solution of NaOH , they obtained needle-shaped crystals of the formula $\text{NaClO} \cdot 6\text{H}_2\text{O}$. They showed that in order to obtain a highly concentrated solution of hypochlorite the temperature must not exceed 27°C . and alkali must be always present in excess, and be so concentrated that any NaCl formed is precipitated (NaCl and KCl are very insoluble to concentrated NaOH or KOH solutions, see p. 378). They showed that solutions containing more than 35 g. available chlorine per 100 c.c. will not keep. The presence of iron salts causes the decomposition of concentrated hypochlorite solutions, attended by the evolution of oxygen and the formation of soluble sodium ferrate; in general, other salts did not cause this oxygen solution.

Other workers who have investigated the subject are Förster and Jorre, Lunge and Landolt (see *Journ. Pract. Chem.*, 2, 59, 53; 63, 141); and Sünder (*Bull. Soc. Ind.*, Mulhouse, 72, 255), who claims that the decomposition of sodium hypochlorite solutions, which is occasionally met with when a solution of bleaching powder is decomposed with sodium carbonate, is due to the presence of sodium bicarbonate as an impurity, 5 per cent. of bicarbonate sufficing to completely decompose a solution of NaOCl in the course of twenty-four hours in a manner not yet understood; in order to obviate this decomposing action it is necessary that some free NaOH solution should be present.

We will now briefly describe some of the more successful apparatus in use for producing electrolytic bleaching liquids.

Kellner's Process.—This is one of the oldest and most successful processes (see German Patents, 99,880, 1894, and 104,442, 1896). The electrodes consist of glass or non-conducting plates covered over with wire, bands or strips of platinum-iridium alloy. A non-conducting plate Λ (Fig. 2) of glass or similar material has its surface penetrated by numerous holes, a, a, a, a , through which fine platinum-iridium wire is drawn so that the surface of the plate looks as if it were covered with a wire network. The holes are then carefully cemented up with non-conducting material. In some forms of the apparatus the glass plates are simply wound round with platinum wire.

The plates so formed are placed vertically in a stoneware or glass trough, side by side, as shown in Fig. 2, only a narrow space being left between the successive plates. These plates slide into vertical grooves in the sides of the trough, so as to divide the cell into a number of compartments. The whole apparatus is filled with NaCl solution, and an electric current is led through the liquid by means of two conducting plates B, B , placed at the extreme ends of the apparatus. Fig. 3 shows a modern form of this electrolytic cell. The brine enters through two inlets a, a placed at the bottom of the vessel, and flows up between the wire-covered

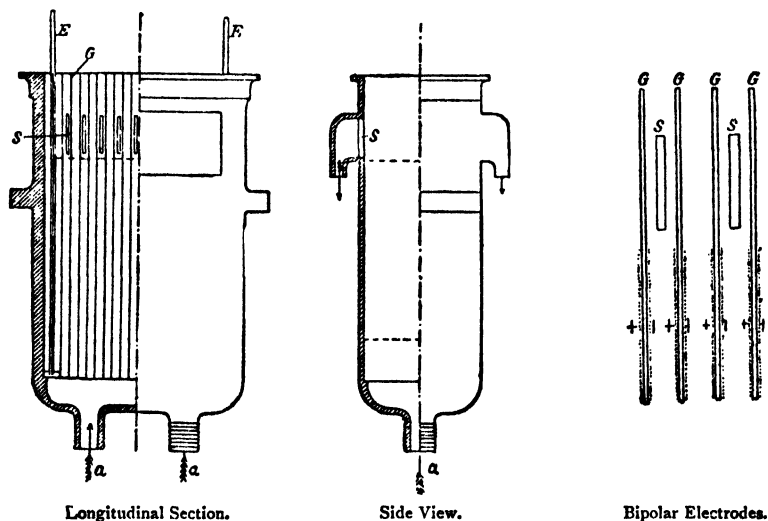


FIG. 3.—Modern Form of Kellner's Electrolytic Cell.

plates G, G, G , which form the electrodes, escaping through the slits s, s in the walls of the trough. E, E are the two terminal electrodic plates where the current enters and leaves the apparatus. The brine flowing up from the bottom of the cell from a, a between the wire-covered plates G, G, G, G is subjected to the action of an electric current flowing between each pair of plates, and thus a considerable amount of hypochlorite is produced. The brine used is usually 10 per cent. NaCl solution, and the drop in the voltage between each two successive plates of the apparatus is usually some 5-6 volts; in the apparatus just illustrated (in which there are twenty cells) the potential difference between the end electrodes E, E is usually about 110 volts, with a current of 120 amperes. One of the intermediate wire-covered plates of the apparatus requires some 150 m. of platinum-iridium wire of 0.1 mm. diameter, or 75 m. on each side of the plate.

It can be shown that this use of thin wire gives an extraordinary high current density. *E.g.*, if we assume that only half the surface of the wire is effective (*viz.*, that facing the opposite electrode of a cell), and neglecting the parts of wire in the grooves and other non-effective parts of the plates, we will see that the effective surface carrying the current of 120 amperes is only 0.1177 sq. m., giving a density of 10,200 amperes per square metre. This high current density is an essential condition for success in producing hypochlorites.

The method of using this electrolytic cell, *e.g.*, for bleaching purposes in the textile industry, is indicated in Figs. 4 and 5, which gives the plant of *Siemens and Halske*. *s* is a chamber filled with salt through which a stream of water trickles. The brine solution thus obtained flows out at the bottom of the salt holder, through

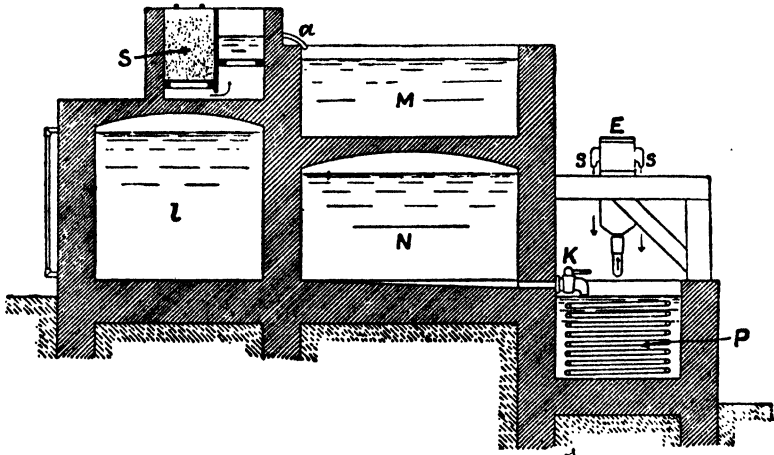


FIG. 4.—Siemen's and Halske's Apparatus for Electrolytic Bleaching.

a filter cloth, and then through a leaden pipe *a*, into a tank *M*, where it is mixed with water in any required volume in order to bring the brine solution up to its correct strength for use. From *M* mixed brine is let down into the storage reservoir *N*. By means of a tap *K* it is from time to time allowed to fill a tank *P*, which contains a cooling worm of hard lead (so that the brine in *P*

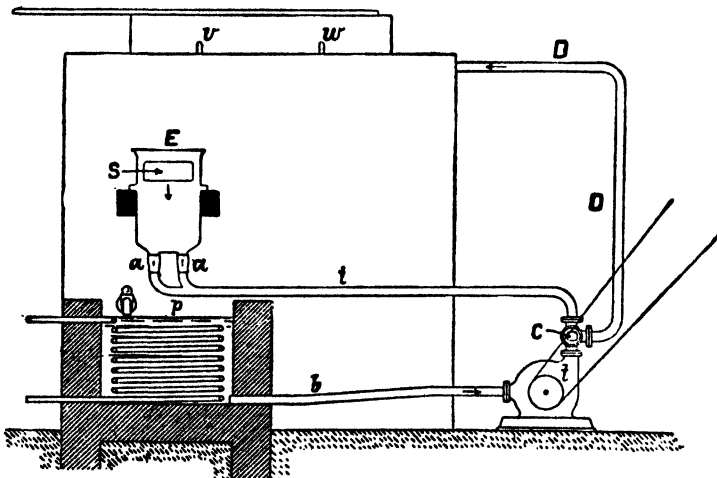
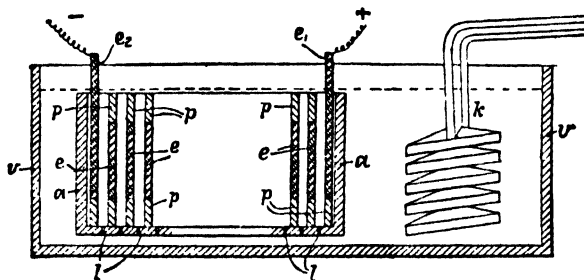


FIG. 5.—Siemen's and Halske's Apparatus for Electrolytic Bleaching.

can be kept at as low a temperature as is convenient). Just above *P* is fixed the electrolytic cell *E*, which we have just described. Through the electrolytic cell *E* the centrifugal pump (Fig. 5) sucks the brine along the pipe *b* and then forces it through the pipe *i* (the tap *c* being turned so as to shut off the pipe *D, D*)

into the bottom of the electrolyser ϵ , where it rises up between the wire-covered plates; and, after being subjected to the action of the electric current, flows out of the apparatus through the slits s in the sides, the liquid falling back again into the tank p . The circulation of brine through the electrolyser ϵ is maintained until the proper percentage of active chlorine is attained, when the tap c is turned so as to cut off i and the electrolyser ϵ , at the same time opening communication between the pipes d, d and b . The pump then forces the active



Longitudinal Section.

FIG. 6.—Haas and Öttel's Cell for Electrolytic Bleaching.

brine out of the tank p , up through d into the storage tank l , where it is run off, as required, for bleaching purposes.

A considerable number of firms in the paper trade and textile industry use this plant, especially in Germany.

Haas and Öttel's apparatus (see the German Patents, 101,296, of 17th May 1896, and 114,739, of 3rd February 1900) consists of two earthenware vessels, one a large one v, v and the other a smaller one a, a , placed within the large vessel just below the level of the brine which fills the large vessel. The smaller interior vessel a, a has a number of wire electrodes, as in the previous system, stretched over a number of vertical plates. e, e, e show these electrodes, which are separated from the base of the vessel and the top by non-conducting supports, p, p . e_1, e_2 are

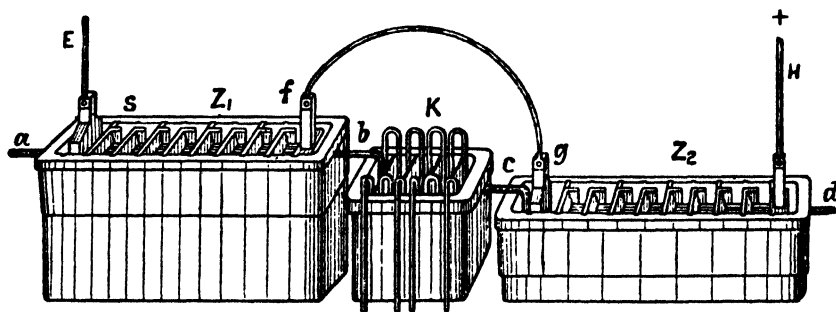


FIG. 7.—Schuckert's Cell for Electrolytic Bleaching.

the two terminal electrodes through which the current flows. Between each compartment of the interior vessel a, a is a small hole l , which maintains communication between the brine in the outer vessel v, v and that in the interior vessel. The action is as follows:—The current, entering at e_1 and emerging at e_2 , flows through the successive electrolytic compartments of the interior vessel, and the brine is electrolysed. Partly owing to the rise of temperature produced by the passage of the electric current through the liquid, and partly owing to the rise of hydrogen

bubbles, the brine inside the successive compartments of the interior vessel becomes specifically lighter than the brine in the exterior vessel, and rises up to the surface between the walls of the compartments of the interior vessel. Thus a current is produced, cold brine from outside entering the holes *l, l'* at the bottom of the interior vessel, rising up between the electrolytic plates of the interior vessel, and escaping at the surface; thus all the brine in the exterior vessel in time streams through

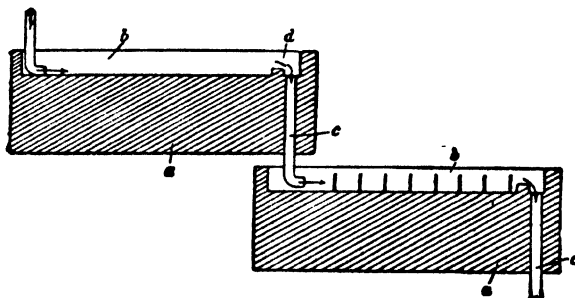


FIG. 8.—Schoop's Electrolyser.

the interior vessel and is electrolysed. The cooling coil *k* keeps the brine in the exterior vessel as cool as possible.

Fig. 7 shows **Schuckert's** apparatus, as used by the Siemens-Schuckert Werke. This is also stated to be very successful in practice. The two stoneware troughs *z₁* and *z₂* each contain nine cells, each with an electrode of platinum wire (+ pole) and a graphite (-) electrode. The current passes in at *h* and comes out at the terminal *e*, the tension between *h* and *e* being about 110 volts, which,

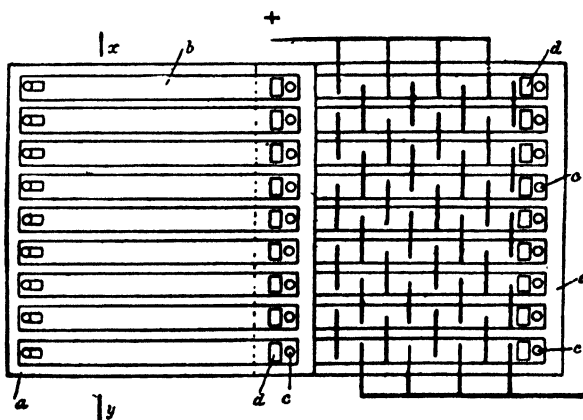


FIG. 9.—Schoop's Electrolyser.

distributed over the eighteen cells, gives a voltage through each cell of 6 volts. A 10 per cent. NaCl solution flows in at *a*, and passes in a continual stream right through the cell, emerging again at *d*, where it passes away. It is found advisable to add a little CaCl₂ solution and some sodium rosinate to the liquid. After passing out from *z₁* the liquid, before entering the second trough *z₂*, flows through an intermediate trough *x*, where it is thoroughly cooled by the cooling coils represented

as dipping into the various compartments of κ . The liquid emerging at d finally contains some 2 per cent. of active chlorine, and for use the liquid is diluted with water until it contains some 0.2-0.5 per cent. active chlorine. The apparatus is described in the German Patent, 141,724 (1902).

Schoop's Apparatus, as described in the German Patents, 118,450, of 1899, and 121,525, of 1900, electrolyses a stream of brine gradually flowing down a number of narrow channels, the walls of which contain the electrodes, formed of fine foil projecting into each chamber (see Figs. 8, 9). The process is successfully worked in several works in Germany.

Other processes, all of which have been practically worked with more or less success, are described in the German Patents:—

K. Kellner, D.R.P., 165,486, of 6th November 1902; W. Kother, D.R.P., 180,562, of 15th August 1905; A. Vogelsang, D.R.P., 205,110, of 9th March 1906; G. Thiele, D.R.P., 205,087, of 11th July 1906 (who adds to the NaCl solution some CaCl₂ and an organic sulphur compound (not aromatic) of high molecular weight, thereby obtaining a liquid with over 5 per cent. active chlorine in it).

Solid Sodium Hypochlorite, containing 60 per cent. available Cl, and melting at 43° C., has been prepared (see Muspratt, *Journ. Soc. Chem. Ind.*, 1903, p. 592. See also p. 397).

Hypochlorites as Disinfectants.—Like bleaching powder (p. 396) hypochlorites can be used for disinfecting purposes, a solution containing 10 per cent. of available chlorine being twenty-five times as effective as phenol.

Recently Dr Dakin and Dr Carrel have used hypochlorites with success in treating wounds. A solution of sodium hypochlorite, carefully neutralised with boric acid to remove alkalinity, and to reduce the irritant action of the original solution, very rapidly dissolves away necrotic tissues and sterilises even very badly infected wounds. This cheap and powerful disinfectant is very easily prepared.

Stabilising Bleaching Powder.—The instability of ordinary bleaching powder under elevated climatic conditions has been traced to the normal moisture content of the bleach. A high-strength stabilised product is now produced by **Imperial Chemical Industries** (J. W. Moore and A. Lambie, British Patent 317,572) by removing the water liberated during the reaction, by circulating large volumes of dilute chlorine through a rotary tube into which lime is introduced and from which bleaching powder is removed. Removal of water picked up by the circulating vessel is effected outside the vessel.

See also British Patents 348,992 (1931), 349,358 (1931), 338,940 (1931).

SECTION XL

THE BROMINE INDUSTRY

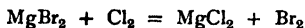
BY GEOFFREY MARTIN, D.Sc., Ph.D.

LITERATURE

- GEOFFREY MARTIN and ERNEST DANCASTER.—“The Halogens.” Vol. 8 of “Modern Inorganic Chemistry.” Edited by Newton Friend. 1915.
- M. KALTENBACH.—*Chem. et Ind.*, 1931, **25**, 543.
- M. A. NOVEMEYSKY.—*Chem. Trade Journ.*, 1931, **88**, 508; *Chem. Met. Eng.*, 1933, **40**, 437.

SMALL quantities of bromine occur in many silver ores, but much greater quantities occur associated with potassium, magnesium, calcium, sodium, etc., in various mineral waters, springs, and in sea water. The waters of the Atlantic Ocean contain 0.007 per cent. Br., while in the Dead Sea 0.42 g. Br per litre is present. However, the largest sources are the saline deposits of Stassfurt, which contain about 1 per cent. of magnesium bromide, and the mineral springs in Ohio, which contain from 3.4-3.9 per cent. of magnesium bromide. Bromine is now manufactured from the **Dead Sea Salts**.

Manufacture.—The bulk of the bromine placed on the market is made at Stassfurt from the mother liquor remaining after the separation of the potassium salts contained in the salt deposits (see p. 332). The residual mother liquor contains about 0.25 per cent. of bromine in the form of magnesium bromide, $MgBr_2$, from which the bromine is liberated by treating with chlorine:—



The apparatus now employed at the Leopoldshall Chemical Works (German Patent, 19,780, of 1882) is shown in Fig. 1. The bromide-rich mother liquors pour through the pipe *a* (which has a water seal at *m*), through a sandstone drum *b* over a perforated plate *c*, whereby it is uniformly distributed over the whole area of a tower *A* filled with glass or earthenware balls, which expose a large surface area to the percolating liquids.

A stream of chlorine gas, issuing from the still *D* (in modern works the still is replaced by a cylinder of liquid chlorine, which affords better control of the Cl), pours through the chamber *B* up the tube *d* (which is sufficiently wide to allow of the simultaneous passage of the chlorine gas to the tower *A*, and the waste liquors from *A* to the chamber *B*) into *A*, where it meets with the descending stream of bromide-rich liquors. Bromine vapour is set free, which, ascending, escapes by the tube *o* through the condenser *E*, and collects as a liquor in the bottles *F*, the last traces of bromine and chlorine being removed by the vessel *G*, which contains iron filings kept moist by a stream of water.

In order to free the waste liquor flowing away from *A* completely from all traces of bromine and fluorine, it is allowed to flow into the chamber *B*. In order to escape from *B* the liquor must flow over sandstone shelves in the direction of the arrows, and while so doing is subjected to a current of high-pressure steam blown into the apparatus through the pipe *c*. The chlorine and bromine are completely driven out of the liquid, escaping with the excess of steam up the pipe *d* into the tower *A*. The chlorine and bromine free liquid flows away by the pipe *i*.

Manufacture by Electrolytic Process.—In this process mother liquors are electrolysed in open vessels, using carbon electrodes. The magnesium bromide $MgBr_2$, is decomposed by the electric current before the magnesium chloride. The bromine is thus separated.

Processes have been devised by Dow, Pemsel, Höpfner, Wünsche, Nahnsen, Kossuth, and others. Most employ diaphragms to effect the separation, with the exception of Kossuth. The liberated bromine remains dissolved in the liquid, and must be separated by distillation and purified.

Purification.—The crude bromine thus obtained is always purified by redistillation, small quantities of chlorine present being removed by the addition of ferrous bromine or calcium bromide, when the chlorine displaces the bromine from combination, setting the latter free.

Sometimes the liquid is purified without chemicals by fractional distillation (see German Patents, 174,848 and 205,448), the more volatile portions (1-4 per cent. of distillate) which contain any

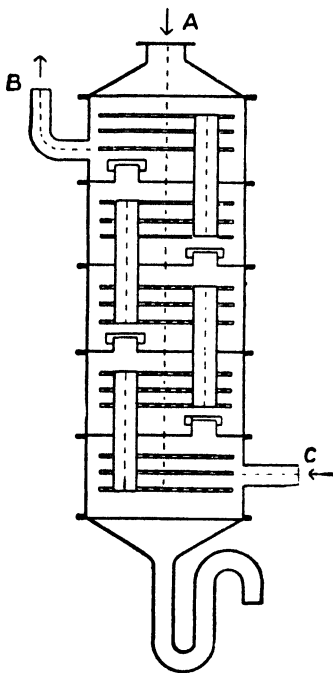


FIG. 2.—Kubierschky's Plant for Bromine Manufacture.

Cl or chlorine bromide being collected separately. If anhydrous Br is needed it is distilled over concentrated H_2SO_4 . If I is present this is removed by treating with a Ca salt, Ca_2I_2 being precipitated.

In the preparation excess of chlorine should be avoided, otherwise much chlorine bromide is formed.

Properties of Bromine.—A heavy, mobile, dark red liquid of sp. gr. 3, 1883 at $0^\circ C$. It freezes to a brown crystalline mass at $-7^\circ C$. Boils at $59^\circ C$. The liquid has a disagreeable smell, attacking the eyes and the mucous membrane of throat and nose. It is poisonous, producing painful sores on the skin, which are difficult to heal.

100 g. of water dissolve 4.3 g. Br at $0^\circ C$., and 3.2 g. at $20^\circ C$., but it is much more soluble in organic liquids such as ether, carbon disulphide, chloroform, acetic acid, etc. It resembles chlorine in properties, but is not so energetic, and is displaced from its compounds by chlorine.

Uses.—Bromine is used fairly largely in the colour industry and other branches of synthetical organic chemistry, also in metallurgy, photography, and especially in the manufacture of medicine, where bromides and other derivatives of bromine are of considerable value. It is used as a mild oxidising agent and also as a disinfectant, it being for the latter purpose absorbed in kieselguhr (which takes up 75 per cent. of its weight of Br), and sold as "*bromum solidification*" (German Patent, 21,644).

Bromide of Iron, Fe_3Br_8 , is made at Stassfurt, serving as a raw material for the manufacture of sodium or potassium bromide. Steel wire and turnings are treated in a closed stone trough with Br vapour and steam at a temperature of $170^\circ C$. When the temperature falls to 100° the brown-red solution of Fe_3Br_8 is run off into transport barrels, where it is allowed to crystallise.

Bromine Salt, $NaBrO_3 + 2NaBr$, is made by saturating concentrated NaOH with Br, draining off the mother liquor from the resulting solid salt, and adding $NaBrO_3$ (electrolytically prepared) until the above composition is attained. The mixture is then ground and packed in kegs. It is used in the extraction of gold ores.

Potassium Bromide, KBr, is made (1) by running a concentrated solution of iron bromide (Fe_3Br_8 , see above) into a hot concentrated solution of K_2CO_3 , until the resulting liquid is almost neutral, or at most, faintly alkaline. 100 parts of iron bromide require 56-60 parts of potassium carbonate. Iron hydroxide is precipitated and KBr goes into solution. The liquid is boiled, filtered from the precipitated iron hydroxides, evaporated to dryness, lixiviated with sufficient water to take up the soluble KBr and leave undissolved the difficultly soluble K_2SO_4 ; concentrated to 1.53 sp. gr. at a boiling heat, then allowed to evaporate at a very gentle heat, when hard crystals of KBr separate. The crystals are washed and dried at 40° - $50^\circ C$. (not above). Any chloride in the bromide cannot be easily removed, hence the necessity of employing chlorine-free bromine.

Formerly KBr was made by saturating KOH with Br, evaporating with a little charcoal to destroy any $KBrO_3$ formed ($6Br + 6KOH = 5KBr + KBrO_3 + 3H_2O$), then lixiviating with water and separating the KBr by crystallisation.

About 120 tons of KBr are made annually in Germany, and the same amount in U.S.A.

Properties.—White cubes, 100 parts H_2O , dissolve 62 parts KBr at $15^\circ C$. M.P. $750^\circ C$. Volatilises at higher temperatures.

Uses.—In photography and in medicine.

Statistics.—Bromine was first manufactured at Stassfurt in 1865. The following figures show the output:—1865, $1\frac{1}{4}$ tons; 1885, 260 tons.

Considerable quantities are also manufactured in America from the bromine-rich springs in Ohio and elsewhere:—1885, 120 tons; 1902, 230 tons.

SECTION XLI

THE IODINE INDUSTRY

BY GEOFFREY MARTIN, D.Sc., Ph.D.

LITERATURE

- GEOFFREY MARTIN and ERNEST DANCASTER.—“The Halogens,” forming Vol. 8 of “Modern Inorganic Chemistry.” Edited by Newton Friend. 1915.
- NEWTON.—*Journ. Soc. Chem. Ind.*, 1903, 22, 469.
- G. G. HENDERSON.—Article. “Iodine,” in Thorpe’s “Dict. Applied Chem.” Vol. 3. 1912.
- W. GANS and R. GRIESENBACH.—*Z. Pflanz-Düng.*, 1929, A13, 321.
- G. LUNDE.—*Chem. Reviews*, 1929, 6, 45.
- ORROLEITCH.—*Medical Research Council*, Special Report, No. 123, 1929.
- See also British Patent 298,670 (1929), United States Patents 1,843,354, 1,843,127, 1,848,081, 1,710,255.

IODINE (I = 126.92) is a fairly widely distributed element, occurring, combined with metals, in small quantities in the soil, the sea, sea plants, and animals. Certain sea plants, especially the deep sea weed, *Fucus palmatus*, possess the power of storing up a considerable amount of iodine, and from these plants a portion of the iodine of to-day is obtained. The deep sea plants contain more iodine than shallow sea plants.

This is shown by the following table, which gives the percentage of iodine in the dried plant :—

		Per Cent.
Cut weed from shallow water	}	<i>Fucus filum</i> 0.0894
		“ <i>vesiculosus</i> 0.001 to 0.0297
		“ <i>serratus</i> 0.0856
		“ <i>ascophyl nodosum</i> traces to 0.0572
Drift weed from deep water	}	<i>Laminaria digitata</i> (stem) 0.4535
		“ “ (frond) 0.2946
		“ <i>stenophylla</i> 0.4777
		“ <i>saccharina</i> 0.23 to 0.2794

Consequently the manufacture of iodine from shallow water weed has been largely abandoned in favour of drift weed from deep water.

The bulk of the iodine of commerce, however, is now derived from crude Chile saltpetre or caliche, NaNO_3 . The mother liquors remaining after the NaNO_3 has crystallised out contain 5-20 per cent. of sodium iodate, crude caliche containing 0.2 per cent. of iodine.

Manufacture of Iodine from Caliche.—The mother liquor remaining after the crystallisation of the sodium nitrate is treated with sodium bisulphite solution, and the iodine separates out in a solid form :—

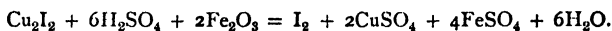


The solid iodine is settled, washed, pressed into blocks, and purified by sublimation in iron retorts, the vapours condensing in a series of earthenware receivers.

An account of the process is given by Newton (*Journ. Soc. Chem. Ind.*, 1903, 22, 469), from whose paper the following details are taken :—

Sodium bisulphite is prepared by mixing together some 85 parts of impure sodium nitrate, 15 parts of fine coal, and water. The mixture is made into a conical mound, surrounded by a trench, and ignited. The crude sodium carbonate thus obtained is made into a saturated solution, settled in an iron tank, and then sulphur dioxide gas is blown through the liquid by means of a steam blower. The sulphur dioxide gas is made by burning native sulphur on an iron plate in a “sulphur furnace”

(see Section XX., pp. 254-256 for modern sulphur burners), which consists simply of an iron oven with a flue passing from it to the cylindrical tank. The sulphur dioxide is passed into the crude sodium carbonate until it is all converted into sodium bisulphite. The bisulphite solution is then run into the *reservoir tanks*, which are placed a foot above the level of the large lead-lined (or pitch-coated) wooden "precipitation" tanks, which are about two-thirds filled with the final mother liquor obtained during the purification of the nitrate, and which contains all the sodium iodate. The bisulphite solution is next run into these "precipitation" tanks, the liquids being thoroughly stirred by means of wooden paddles or by air forced in through perforated pipes in the bottom of the tanks. Iodine is precipitated according to the foregoing equation. It is collected and removed, the last traces which remain after the bulk has been removed being collected by means of a calico bag at the end of a stick. The iodine is then water-washed, filter-pressed, and sublimed in iron retorts. These consist of horizontal cast-iron cylinders, tapering at one end to a conical form. The outlet, which is 6 in. in diameter, is connected to a series of eight or ten ordinary earthenware drain pipes (or aludells similar to those used in the manufacture of iodine from kelp) which are luted together by clay. Many different variations of this process have been suggested. Sometimes SO₂ gas is passed directly into the mother liquors, and any iodide, NaI, remaining is decomposed by adding chlorine water. Sometimes the iodide—especially in liquors very poor in this substance—is directly precipitated as cuprous iodide, Cu₂I₂, by adding CuSO₄ and FeSO₄, the Cu₂I₂ is then distilled with MnO₂ and H₂SO₄ and the I distilled over. Sometimes the Cu₂I₂ is heated with H₂SO₄ and ferric oxide (see German Patent, 209,501):—



Electrolytic Iodine.—Attempts have been made to prepare iodine electrolytically (see Rink, German Patent, 182,298) from the caliche mother liquors.

The anodic compartment contains as anode a carbon plate immersed in a concentrated NaCl (or halogen salt) solution. The cathode consists of an iron plate immersed in a slow-moving stream of the liquor to the electrolyser. Separating the anodic from the cathodic space is an asbestos cloth diaphragm. Under the influence of the electric current the iodine ions pass away from the cathodic space to the anode and are discharged into the concentrated solution of halogen salt, which possesses an extremely highly developed power of dissolving iodine. The anodic liquors with the iodine therein is run off from time to time and the iodine expelled therefrom. If no diaphragm is used for separating the anodic and cathodic spaces, a process analogous to the Bell process (see p. 375) is used, the less dense cathodic liquors being separated from the heavier anodic liquors by their specific gravity.

Parker and Robinson (English Patent, 11,479, 1888) place a solution of alkali iodides, acidified with sulphuric acid, in an electrolytic cell, which is divided into two compartments by a diaphragm, and provided with a carbon or platinum anode and an iron cathode. An electric current is sent through the fluid, and the iodine which is liberated at the anode is collected, washed, and dried.

Manufacture of Iodine from Seaweed.—The seaweed (chiefly *Laminaria digitata* and *L. stenophylla*) cast up in the spring after stormy weather on the coasts of France and Ireland, Scotland and Japan, is dried in the sun during the summer, and is then burnt in large heaps in shallow pits; the ash¹ may contain from 0.1-0.3 per cent. of iodine.

Since much iodine is lost by volatilisation during this burning process, Stanford, in 1862, subjected the weed to destructive distillation in closed retorts, the whole of the iodine remaining in the ash, while the tar and ammoniacal liquors were also recovered. However, the cost of plant and fuel rendered the process unremunerative.

Next the ash is lixiviated, and the iodine passes into solution as KI. The carbon remaining after the lixiviation of the ash resembles animal charcoal, and is used for similar purposes.

Several processes have been worked in which the plants are not carbonised at all. In one process the plants are stated to be simply directly lixiviated, the residual apparently unaltered plants being converted into "algin," a gelatinous substance used as a substitute for isinglass, bladder skins, etc. In another process the plants are heated with dilute sulphuric acid or other acid; here, again, previous carbonisation is avoided, and the residue of seaweed is utilised as manure. Stanford heated the weed with Na₂CO₃.

There results from the lixiviation (which is systematically carried out) a concentrated solution of alkali carbonates, sulphates, chlorides, sulphites (traces)

¹ According to Ernest A. Dancaster, in this country the term **kelp** is applied to both the weed and the ash, although the latter is also known as **kelp ash**. In France the term **varech** is applied to all seaweed (the word being allied to our word **wrack**), and the burnt ashes are known as **condres de varech**.

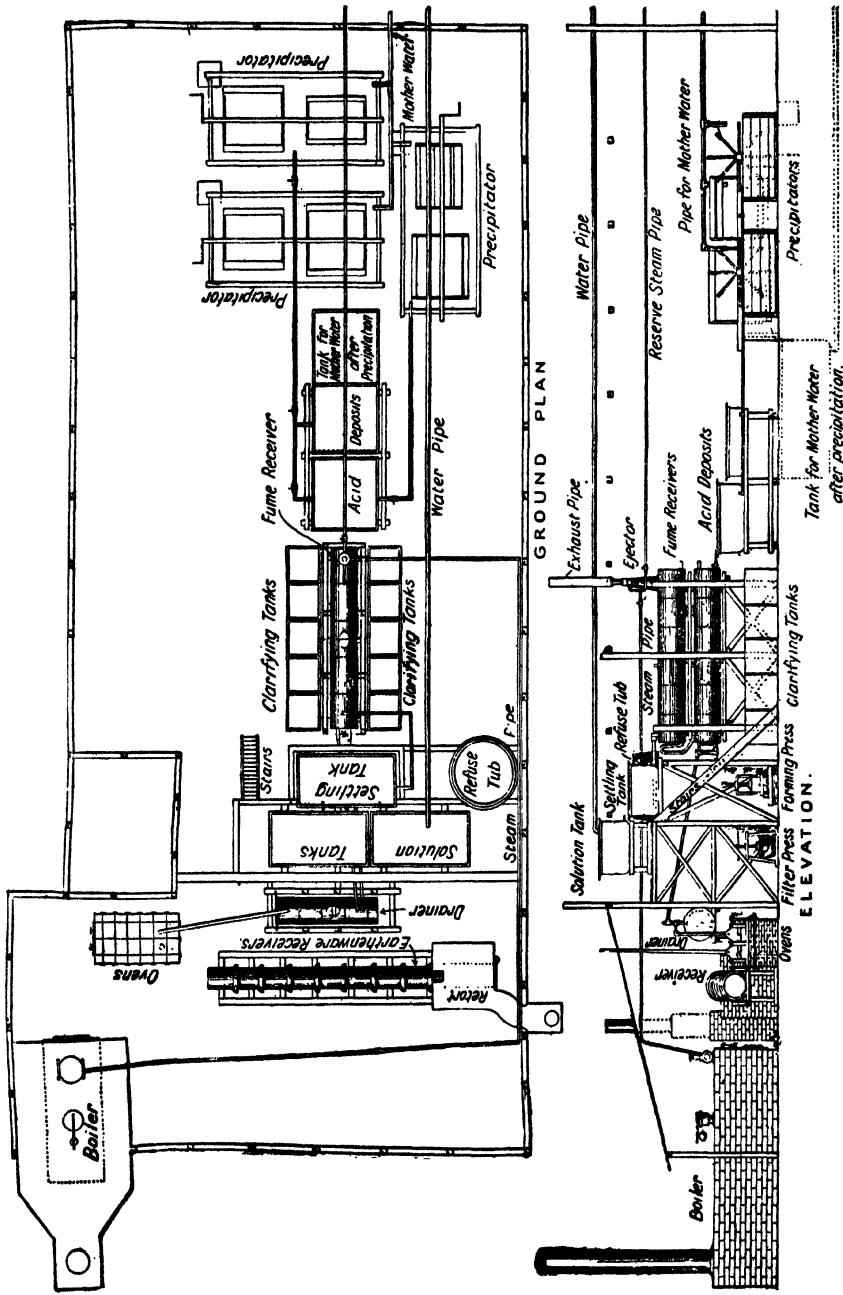


FIG. 1.—Plant for Manufacturing Iodine from Caliche.
 ("Taken, by kind permission, from Thorpe's "Dictionary of Applied Chemistry." Published by Longmans & Co)

sulphides (traces), bromides, and iodides of the alkali metals. The solution is evaporated, and the chlorides, carbonates, and sulphates allowed to crystallise out. The mother liquors then contain the bromides and iodides. This liquor is then worked for iodine by the following processes:—

(1) Excess of H_2SO_4 is added to decompose sulphites and sulphide, and after removing any separated crystals, the liquid is run into a hemispherical iron boiler mounted in brickwork over a fire, and fitted with a leaden hood provided with a still head (Fig. 2). Manganese dioxide is thrown in, and when the temperature reaches about 60°C . iodine is evolved, and, escaping through the still head, condenses in a series of glass or earthenware receivers termed "udells." The joints of the apparatus are luted gas-tight by clay. The iodine distilling over condenses in the earthenware or glass condensers or "udells." When no more iodine comes over, the stills are connected with another set of receivers and Woulff's bottles, and more manganese dioxide is added. Bromine is evolved, and is thus collected separately from the iodine. The equation representing the change is thus:—

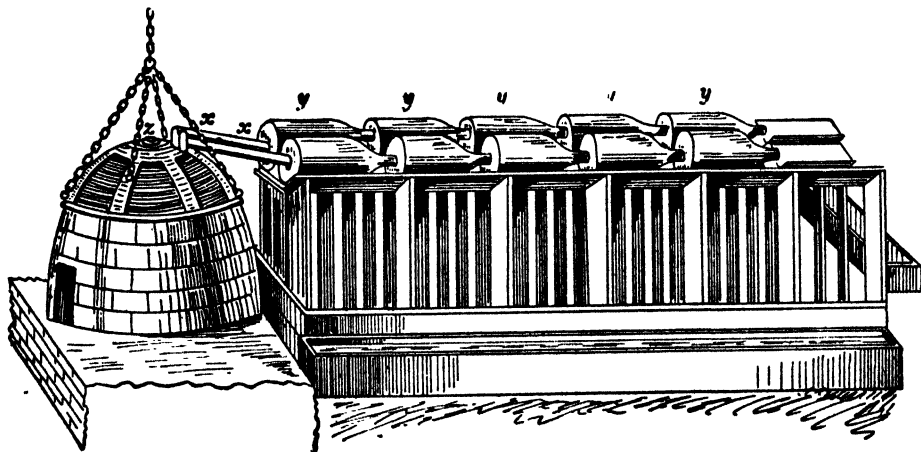
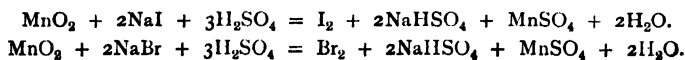


FIG. 2.—Iodine Still.

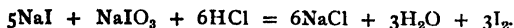
The iodine thus obtained is impure, containing chloride, bromide, and cyanide of iodine. It is purified by sublimation as above described.

(2) Other processes are to heat the liquor with sulphuric acid and ferric chloride, FeCl_3 , with sulphuric acid and nitric acid, sulphuric acid and chlorate, or bichromate, etc. All the oxidising agents liberate the iodine from the liquid. Sometimes the calculated amount of Cl gas is led into the liquid when iodine is precipitated. However, the chlorine must not be in excess, or iodine chloride would be formed.

When the liquid is very poor in iodine, it may be precipitated as cuprous iodide, Cu_2I_2 , by adding ferrous sulphate and copper sulphate to the liquid. From the Cu_2I_2 the iodine can then be liberated by heating with sulphuric acid and manganese dioxide.

(3) Occasionally a process of extraction with organic solvents is resorted to. Thus, after liberating the iodine by adding sulphuric and nitric acid, the liquid is agitated with petroleum naphtha or benzol, when the iodine dissolves, and the petroleum or benzol layer of iodine is then separated from the aqueous layer, and shaken up with an aqueous caustic soda, whereby the iodine is fixed as iodide or

iodate of sodium, and so is withdrawn from the hydrocarbon. The petroleum or benzol is drawn off, and the iodine is then liberated by HCl thus:—



More recently, instead of using a volatile solvent, the use of vaseline oil (the heavy oil from Galician petroleum) has been used for extracting the iodine. The liquor containing the iodine is treated with vaseline oil in such a manner that those portions of the liquor from which the bulk of the iodine has already been extracted are treated with fresh vaseline oil, which takes up all the iodine out of the liquor. Also those portions of the vaseline enriched in iodine come only into contact with the iodine-rich liquors. In this way efficient extraction is secured.

Next the oil is distilled with steam; the iodine coming over, the oil is left behind and used again.

In general, one ton of carbonised seaweed yields 10-12 lbs. of iodine.

Iodine from Phosphates.—Thiercelin (*Bull. Soc. Chem.*, 1874 (2), 22, 435) places a mixture of equal quantities of iodine-rich phosphate, sulphuric acid, and water in a vat, and keeps the mass well stirred. The iodine is liberated and passes over into a condensing chamber.

Purification.—Commercial iodine always contains traces of chlorine and bromine, either chemically combined or in solid solution. The purification is best effected by dissolving the resublimed iodine in a concentrated solution of KI, when it dissolves to a dark solution, possibly containing the compound KI_3 . On adding excess of water the iodine is precipitated, and is washed and dried. The dry iodine is then mixed with solid KI and slowly sublimed. The sublimate consists of practically pure iodine. Pure iodide can also be obtained by heating cuprous iodide, Cu_2I_2 , to about 240°C . in a stream of air.

Properties.—Pure iodine is a dark bluish-black, lustrous, crystalline solid. Atomic weight of I = 126.92; M.P., 116.1°C .; B.P., 184.35° ; specific gravity of solid, 4.933 at 4°C .; vaporises slowly; very sparingly soluble in cold water. 100 vols. of a saturated solution at 25°C . contains only 0.32 g. of iodine. At 15°C . 1 part iodine dissolves in 3,750 parts of water, and in 2,200 at 30° . It is much more soluble in a concentration solution of KI (where it possibly forms the component KI_3), and also in alcohol, ether, acetone, chloroform, benzene, carbon disulphides, and other organic solvents. The tincture of iodine of the *Pharmacopœia* contains $\frac{1}{2}$ oz. iodine, $\frac{1}{4}$ oz. KI, and 1 pint of rectified spirits. Potash or soda at once decolorises a solution of iodine, forming potassium iodide and iodate, thus:—



With concentrated HNO_3 iodine is oxidised to iodic acid, HIO_3 .

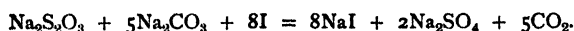
Test.—Iodine produces a splendid blue colour with starch paste. The blue colour disappears on warming the solution, but reappears on cooling.

Alkali Iodides.—(1) In order to produce potassium iodide, KI (or sodium iodide, NaI), the usual process is to add iodine in small portions to hot KOH (or NaOH) and evaporate. A mixture of potassium iodide, KI, and potassium iodate, KIO_3 , is obtained (NaI or NaIO_3 if NaOH is used). The mixture is next mixed with carbon and ignited, which decomposes all iodate, and the iodide is then extracted with cold water and crystallised out. Improvements on this method of manufacture are suggested in the German Patent, 138,008.

(2) In another process the formation of iodate is prevented by allowing iodine to act on alkali in the presence of a reducing substance such as potassium thiosulphate. The following change occurs:—



Sometimes sodium carbonate is used:—



On evaporating, the K_2SO_4 or Na_2SO_4 is easily separated by crystallisation from the much more soluble iodides.

Statistics relating to Iodine.—Most of the iodine at present produced comes from the mother liquors of the sodium nitrate (caliche) works of South America :—

1879	-	-	77.35 tons	1904	-	-	458.21 tons
1881	-	-	200.06 „	1905	-	-	564.20 „
1890	-	-	419.74 „	1906	-	-	351.20 „
1900	-	-	306.13 „				

Chile alone exported in 1904, 9,961 Spanish cwt.

The amount of iodine produced from seaweed is small, being principally worked in France, Norway, and England. However, in recent years Japan has begun to make large quantities of iodine from seaweed, and if the U.S.A. seriously attempt the recovery of potash from seaweed on the Pacific coast on a large scale, an important additional source will be added to those existing. The following figures give the Japanese export of KI (potassium iodide) in kin (1 kin = 1.3 lbs.) :—

1902	1903	1904
3,051.	22,371.	52,012.

The following statistics relate to the German import and export of iodine :—

Year.	Total Import.		Imported from		
	Quantity in Tons.	Value in Million Marks.	Great Britain.	Japan.	Chile.
1890	138	3.7	77	...	41
1900	236	5.4	110	6	100
1904	270	6.0	50	20	170
1905	377	12.8	60	20	200
1906	297	5.8
1907	147	2.65	27	17	76
1908	194	3.5	55	...	112

The German export of iodine in 1901 was 30 tons. In 1907 it rose to 44 tons.

Germany exports large amounts of finished iodine products, fine chemicals containing iodine, as shown by the following figures :—

GERMAN EXPORT OF IODINE PREPARATIONS

Year.	Total Import.	
	Quantity in Tons.	Value in Million Marks.
1890	106	2.9
1900	138	3.0
1904	170	4.2
1905	170	5.3
1907	145	2.5

SECTION XLII

THE HYDROFLUORIC ACID INDUSTRY

BY GEOFFREY MARTIN, D.Sc., Ph.D.

LITERATURE

GEOFFREY MARTIN and E. DANCASTER.—“The Halogens,” forming Vol. 8 of “Modern Inorganic Chemistry.” Edited by Newton Friend. 1915.

A. G. BETTS.—*Eng. and Min. Journ.*, 1907, p. 153.

ZELLNER.—“Die künstlichen Kohlen.” Berlin, 1903.

See also United States Patent 1,842,092 (1933); British Patents 387,614 (1933), 323,211 (1930); United States Patent 1,748,735; British Patents 315,769, 289,383, 303,760.

AQUEOUS hydrofluoric acid, HF, is usually obtained by heating calcium fluoride, CaF_2 , with concentrated sulphuric acid: $\text{CaF}_2 + \text{H}_2\text{SO}_4 = \text{CaSO}_4 + 2\text{HF}$. In recent years the technical importance of hydrofluoric acid has considerably increased, as it is used on a fairly large scale for the purification of artificial carbon and graphite, in dyeing, in etching glass, in the brewery, etc., and consequently considerable improvements have been effected in the apparatus for preparing this substance. Many factories which prepare acids for use in chemical industry have their own special plant for producing hydrofluoric acid.

Manufacture.—Fig. 1 shows a small scale apparatus for preparing aqueous HF. A leaden retort A, on which a leaden head B is cemented, has placed

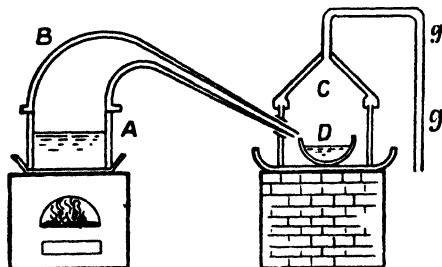


FIG. 1.—Small Still for Hydrofluoric Acid.

within it a mixture of calcium fluoride and oil of vitriol. On heating the gaseous mixture HF is evolved and passes into a leaden receiver C, which contains a vessel of water D, best made of platinum, in which the HF condenses. The tube g serves as air and gas exit.

On a large scale, however, it is usual to use iron stills. Fig. 2 shows a large scale plant, working according to the Eckelt vacuum process.

a is a semispherical cast-iron pan, some 2 m. in diameter, and some 3.5 cm. to 4.5 cm. thick. This serves as the HF generator. On this stout pan rests a hemispherical leaden lid b. The lead of the semispherical lid is held rigid by being soldered over a framework of iron bands, which run together to a ring at the top, to which is fastened a ring d which serves to lift the lid

when necessary. The lid is 1 cm. thick, and has at the base a broad 12 cm. flange, which fits exactly over the similar flange belonging to the iron pan beneath, and which forms an air-tight joint, the two flanges being securely clamped together by strong screw clamps.

The thin lead sheet is turned up on the edge *e*, so as to form a sort of trough, which is kept filled with running cold water, which serves as a condensing arrangement and keeps the leaden cover from becoming too hot.

The heat of the furnace beneath might otherwise overheat the lead and cause it to melt. The cooling water flows in and out through special funnels.

Inside the lid is a protecting sheet of lead which runs round the periphery of the inside of the lid, and projects over the iron pan.

It serves to protect the latter from the cold dilute sulphuric acid, which keeps condensing on the leaden lid, and would otherwise run down the cast-iron surface of the lower pan, and rapidly corrode it.

The cast-iron pan is set in brickwork in such a manner that it is protected from the direct action of the flames. The hot gases come into contact with the metal at the opening *h*, and in order to prevent the cast-iron pan burning away locally at *h*, the whole cast-iron pan *a* is turned through an angle of 60° after every second charge, by means of iron hand grips attached to the iron pan. The tendency to burn is fairly pronounced, because towards the end of the operation solid crusts of calcium sulphate separate. Some 800-900 kg. of fluorspar is placed in the iron pan *a*, then some 1,200-1,300 kg. of concentrated sulphuric acid is run out of a lead-lined tank (using compressed air to expel the acid) *m* into the iron pan *a*. The HF vapours escape up

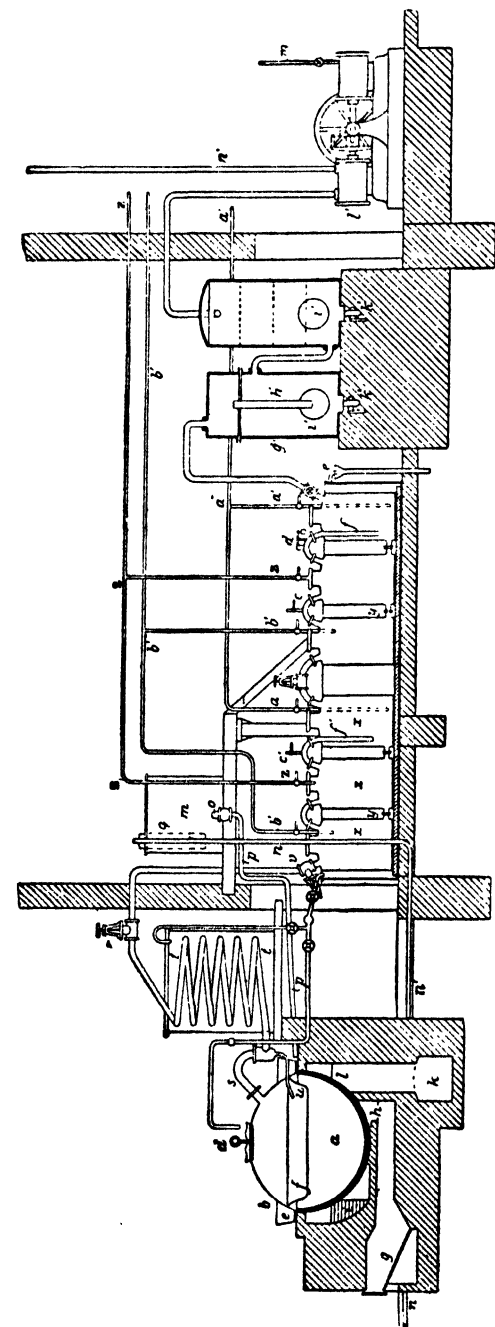


FIG. 2.— Plant for the Manufacture of Hydrofluoric Acid.

leaden tubes *s* and *t*, any sulphuric acid simultaneously carried over with the gas being condensed in the coil *l*, which is immersed in a tank of running cold water, and flows

back again through the tube u into the pan a . The HF gas escapes and passes into the leaden vessels x, x, x , which are filled with water and connected together at the bottom in two sets of three by means of the tubes y, y . Each set of three vessels is placed in a tank filled with a running stream of cold water, being immersed right to the base of their necks. In the first two of each set of three the tubes do not dip below the surface of the water, so that the absorption of gas in the water takes place at the surface only. In the last vessel, however, the entry tube t dips into the water, so that the gas has to pass through the water before issuing out into the vacuum apparatus. This provision is necessary in order to avoid the necessity for using a very high vacuum to work the condensing arrangement. The acid gases escaping finally from the last vessel x are led into absorption towers (each about 2 m. high by 1 m. diameter), of which the first contains milk of lime or caustic soda solution, and the second is filled with dry slaked lime, placed on wooden gratings. The inside of each tower is well tarred to make it acid-resisting.

The gases then pass out, free from all acid fumes, into the cylinder l , whence by means of the vacuum pump they are forced out into the air through a long tube n . In general, to every set of absorption vessels there are two hydrofluoric acid generating stills employed, the absorption being regulated by the valve at r . It takes about forty-eight hours to work off a charge.

Bett (see *Engineering and Mining Journal*, 1907, p. 153) describes another process which is in use in various parts of the world. Shallow cast-iron pans are provided with lids, which are hermetically sealed by means of concentrated sulphuric acid. All the condensers, etc., which consist of leaden vessels, stand totally immersed in water. The charge is 1,000 kg. of ground fluorspar to 1,000-1,200 kg. concentrated sulphuric acid (66° Bé.).

All these methods suffer from the defect that a crust of calcium sulphate sets on the bottom of the decomposing pans, causing great difficulties. Several efforts have been made to overcome these defects. The proposal of L. Meyer (German Patent, 142,931, 1900) deserves mention. The retort is fixed in a furnace, and the decomposing pan consists of an iron trolley, running on wheels, which can be moved in or out of the furnace as desired. The fluorspar and sulphuric acid are mixed cold to a syrupy mass in this trolley, which is then run into the retort, the door shut, and the distillation carried out in the usual way. When the distillation is finished, the door is opened, and the trolley run out, while another similar trolley, freshly charged, is run in again. So that neither time nor heat is lost between the separate charges. A similar apparatus for making acetone is described in **Martin's** "Industrial Chemistry: Organic," German Patent, 134,977, in the Section on "Wood Distilling".

Sodium or potassium bisulphate (NaHSO_4) or (KHSO_4) may be used instead of sulphuric acid in decomposing CaF_2 (see German Patent, 116,848).

Purification.—Technical hydrofluoric acid solution invariably contains hydrofluorsilicic acid, H_2SiF_6 , derived from the silica, SiO_2 , almost invariably present in the commercial fluorspar, CaF_2 , used. It usually contains, as well, some H_2SO_4 , HCl , SO_2 , As , Fe , Pb , Ca , etc., derived from impurities in the materials used in the manufacture.

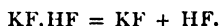
K. F. Stahl (*Zeit. angew. Chem.*, 1896, 9, 225; *Journ. Amer. Chem. Soc.*, 18, 415) gives the composition of the commercial acid as follows:—

HF	-	-	-	39.6-54.2 per cent.
H_2SiF_6	-	-	-	2.7-14.9 "
H_2SO_4	-	-	-	0.8-4.0 "

By repeated distillation an acid of constant composition and boiling point may be attained (at 75° min. and 111° C. B.P. the acid contains $\text{HF} = 43.2$ per cent., $D^{18} = 1.138$ according to Deussen, *Zeit. anorg. Chem.*, 1906, 49, 207), but the pure acid can only be obtained by special chemical treatment, as with distillation the H_2SiF_6 simply goes over with the acid.

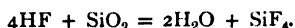
Gore (*Phil. Trans.*, 1869, 173; *Journ. Chem. Soc.*, [2], 7 (1869), 368) purifies commercial by diluting the technical acid until it contains less than 40 per cent. HF (with more than this H_2S will not precipitate lead), passes in excess of H_2S (to precipitate the Pb , As , etc.), adds more than enough of K_2CO_3 to combine with all the H_2SiF_6 and H_2SO_4 present (which precipitates most of the H_2SiF_6 as K_2SiF_6 , decants the liquid, removes any H_2S present, by adding Ag_2O or AgF or Ag_2O , and then distils from a leaden retort, leading the vapour through a platinum condenser into water contained in a platinum basin.

The pure acid must not come into contact with Pb. Thorpe and Hambly (*Journ. Chem. Soc.*, 1889, 55, 163) treat with KMnO_4 , then convert the acid into KF.HF by adding KF , and then dry this compound and decompose it by heating in a platinum retort:—



See also Moissan (*Ann. Chem. Phys.*, [6], 24 (1891), 224). The pure acid is now invariably prepared by heating the salt KF.HF .

Properties.—The aqueous acid is a highly corrosive, dangerous liquid, contact of the vapour with the eyes and skin being highly dangerous. The acid, and some of its salts (*e.g.*, NH_4F), are principally used for etching glass, acting on the SiO_2 of glass as follows:—



The SiF_4 escapes as a gas. It is acted on by water thus:—



According to W. Winteler (*Zeit. angew. Chem.*, 15, 33, 1902) the density of the aqueous acid at 20° C. is given by the following table:—

Per Cent. HF.	Sp. Gr.	° Bé.	Per Cent. HF.	Sp. Gr.	° Bé.
1	1.003	0.5	26	1.092	12.0
2	1.007	1.0	27	1.095	12.4
3	1.011	1.5	28	1.098	12.7
4	1.014	2.0	29	1.101	13.1
5	1.018	2.5	30	1.104	13.4
6	1.023	3.0	31	1.106	13.7
7	1.027	3.5	32	1.109	14.1
8	1.030	4.0	33	1.112	14.4
9	1.035	4.5	34	1.114	14.7
10	1.038	5.0	35	1.117	15.0
11	1.041	5.5	36	1.120	15.4
12	1.045	6.0	37	1.122	15.7
13	1.049	6.5	38	1.125	16.0
14	1.052	7.0	39	1.127	16.3
15	1.055	7.5	40	1.130	16.5
16	1.059	8.0	41	1.133	16.8
17	1.062	8.4	42	1.136	17.2
18	1.066	8.8	43	1.138	17.5
19	1.069	9.3	44	1.141	17.8
20	1.072	9.7	45	1.143	18.1
21	1.076	10.1	46	1.146	18.4
22	1.079	10.5	47	1.149	18.7
23	1.082	10.9	48	1.152	19.0
24	1.086	11.3	49	1.154	19.3
25	1.089	11.7	50	1.157	19.5

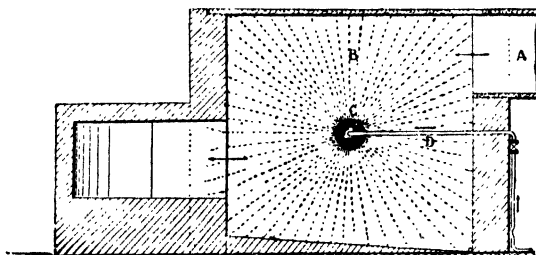
Eckelt (*Chem. Zeit.*, 1898, 22, 225) gives another table which differs in some respects from that given. The density of aqueous HF may be determined by using an ebonite pycnometer with ends which screw off and on (see Zellner, *Monath.*, 18, 749, 1897). With acids which are not very strong, a simple metal floating hydrometer may be used, the metallic surface being painted over with a hard pitch.

Storage and Transport.—Large quantities of the aqueous acid may be transported in vessels of lead (see Stahl, *Zeit. angew. Chem.*, 1896, 9, 225, and also Eckelt, *Chem. Zeit.*, 1892, 16, 17). It may also be transported in cast-iron vessels, or glass vessels coated internally with guttapercha, bakelite, etc. Small quantities are usually kept in indiarubber, ebonite, or guttapercha bottles (see Bendikt, *Chem. Zeit.*, 1891, 15, 881). Flasks made of paraffin wax or ceresin are also suitable.

Uses.—Formerly HF was used almost solely for glass etching. The glass is covered with a layer of wax, the portions to be etched being uncovered by removing the wax with a sharp instrument. The acid, when applied (either as vapour by gently warming, or else in an aqueous solution), leaves a sharp mark. Ammonium fluoride in HF solution is also used for dull etching glass.

More recently, however, the importance of HF has greatly increased owing to its use in other directions; e.g., considerable quantities are used for purifying artificial graphite from SiO_2 , etc. (see Zellner, "Die Künstliche Kohlen," Berlin, 1903). In dyeing, double fluorides of antimony are widely used as a substitute for tartar emetic. In the spirit and brewing industry HF is used extensively on account of its antiseptic effect, yeast being not nearly so sensitive to the acid as other organisms, and so the fermentation proceeds more uniformly when HF is used (see **Martin's** "Industrial Chemistry: Organic"; also Effront, *Bull. Soc. Chem.*, 1890, [3], 4, 337). Stahl (*Zeit. angew. Chem.*, 1896, 9, 225) recommends the use of a 1-2 per cent. HF solution to open out petroleum bores, and also for cleaning iron castings from sand (SiO_2), and also for cleaning copper articles.

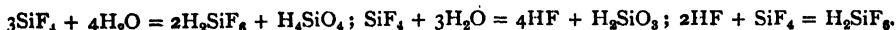
Dilute aqueous HF has been used for removing the weighting matters from silk (see *Zeit. f. Farben und Textilchemie*, 1903, 2, 160, 210, 261; Gnehm and Dürsteler, *Farber. Zeit.*, 1906, 17, 217; Ristenpart, 18 (1907), 273).



Ground Plan.

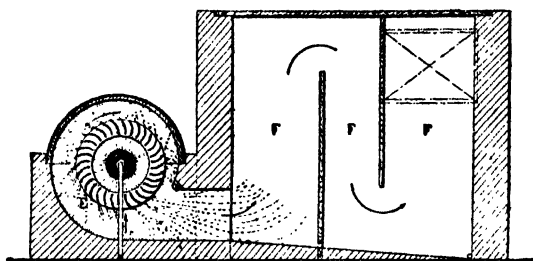
FIG. 3.—Superphosphate Den.

Hydrofluorsilicic Acid, H_2SiF_6 .—This acid is obtained by leading silica tetrafluoride, SiF_4 (which is evolved by allowing silica to act on HF:— $\text{SiO}_2 + 4\text{HF} = \text{SiF}_4 + 2\text{H}_2\text{O}$), into water:— $3\text{SiF}_4 + 4\text{H}_2\text{O} = \text{H}_4\text{SiO}_4 + 2\text{H}_2\text{SiF}_6$. Gelatinous silicic acid is simultaneously produced. H_2SiF_6 is thus produced whenever the gases evolved by treating material containing fluorides with siliceous materials and concentrated sulphuric acid are led into water. Thus large quantities of H_2SiF_6 and its salts are obtained as by-products in the **superphosphate** industry (see Vol. II. of this work, under **Manures**). Natural and artificial phosphates, often containing considerable amounts of fluorides and siliceous matter, are in this industry treated with concentrated sulphuric acid in order to produce the phosphate in a soluble form, suitable for manuring purposes. The gases thus evolved in the furnaces (which contain SiF_4 , free HF, H_2O , CO_2 , etc.) are sucked out and are led into large condensing "dens" or chambers (of 100 cub. m. capacity), best built of pitchpine and provided with a number of dividing walls, against which the gases impinge. The steam and SiF_4 here condense and react according to the equations:—



The gases not absorbed in the first chamber pass out into another similar absorption chamber, in which the gases come into contact with a spray of *cold* water (steam does not react so well with SiF_4), and the gases not absorbed here escape by means of a tall chimney into the air.

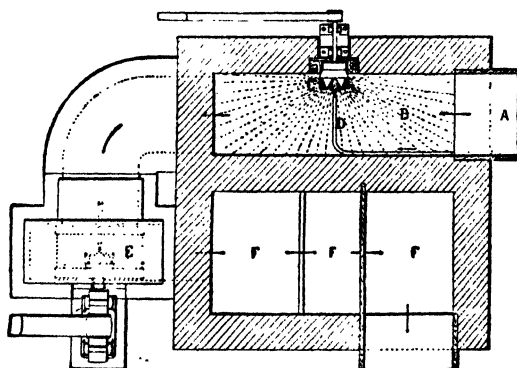
A more efficient system of absorbing the SiF_4 containing gas is that devised by Paul Kestner, Düsseldorf (see Figs. 3, 4, and 5). The gases from the pan wherein the phosphate is treated with H_2SO_4 pass by means of the pipe A into the space B. This contains a rapidly rotating "centrifugal atomiser" c, which fills the whole chamber with a fine spray or mist of water particles. This cools and partially absorbs the entering gases, which then pass on through the "turbo-atomiser" E. This consists of a fan wheel E, which is built up of small blades



Elevation.

FIG. 4.—Superphosphate Den.

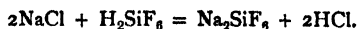
after the manner of a turbine. In the centre of this fan is a rotating "atomiser" which ejects a fine spray of water through the rapidly rotating blades of the surrounding fan wheel E, and thus causes the gas coming from the chamber B to be so thoroughly churned up and mixed with water that complete absorption of the acid components follow, the escaping gases passing away quite free from acid fumes through a chamber F provided with baffles, and so out to the chimney. The



Ground Plan.

FIG. 5.—Superphosphate Den.

water, falling as drops, flows away from F in the form of a solution of fluorsilicic acid, the liquors containing gelatinous silicic acid in suspension. The liquid is passed through a filter press and then stirred up with NaCl solution, when there separates out a white gelatinous precipitate of sodium silicofluoride, Na_2SiF_6 , which is produced thus:—



This Na_2SiF_6 , when washed over with cold H_2O , dried, and passed through a sieve, contains $\text{Na}_2\text{SiF}_6 = 98.6$ per cent., $\text{NaCl} = 0.72$, $\text{SiO}_2 = 0.54$, $\text{H}_2\text{O} = 0.14$.

It is sold to enamelling works, and finds some application in the manufacture of "milk" glass.

H_2SiF_6 is also obtained as a by-product when earthenware vessels are treated with HF in order to increase their porosity, high tension steam being afterwards blown through them (see Prior, *Zeit. angew. Chem.*, 1903, 195), or when graphite is treated with HF (to free it from SiO_2). See also German Patent, 105,734 (1898). The German Patent, 116,848, describes a process for manufacturing the acid.

Properties.— H_2SiF_6 is a strong acid: it attacks the skin. When concentrated it is hygroscopic, and attracts moisture from the air until a certain definite concentration is attained. The acid, when boiled or evaporated, volatilises without a residue.

Uses.—The acid now finds considerable application as a disinfectant, for delimiting skins in tanning (**Martin's** "Industrial Chemistry: Organic"), and in the electrolytic precipitation of lead. Its sodium salt is used (see above) in enamelling and in the manufacture of "milk" glass. Fluorsilicates (fluates) are now used as a hardening agent of certain cements used in building "Artificial Stone" (see Vol. II. of this work).

Fluorides are extensively used for spraying fruits, etc., as they possess a powerful antiseptic action. However, they must be used with caution as they are **cumulative poisons**. See **M. C. Smith** and **R. M. Leverton**, "Comparative Toxicity of Fluorine Compounds," *Journ. Chem. Ind. Eng.*, 1934; also the *Analyst*, vol. lix., 1934, p. 710.

SECTION XLIII

PEROXIDES AND PERACIDS

BY G. W. CLOUGH, D.Sc.

LITERATURE

L. LÖWENSTEIN.—*Z. Elektrochem.*, 1928, **34**, 784.
See also British Patents 297,880 (1928), 316,919, 294,265, 277,628.

I.—PEROXIDES

A PEROXIDE is an oxide containing more oxygen, combined with a certain weight of an element, than is contained in the highest basic or acidic oxide of the element. The true peroxides, or **superoxides** as they are frequently called, differ from the "false" peroxides or **polyoxides** in that they yield hydrogen peroxide as a product on treatment with excess of water or a dilute acid. Since hydrogen peroxide possesses acid properties in aqueous solution, the superoxides may be regarded as salts of hydrogen peroxide. In consequence of the ease with which they are converted into the parent substance, they find wide application as oxidising, bleaching, and disinfecting agents.

Sodium Peroxide, Na_2O_2 , is manufactured by passing a current of air, carefully freed from moisture and carbon dioxide, over slices of sodium resting on aluminium trays which pass through a tubular iron vessel. The temperature is maintained at about 300° . The oxidation is effected slowly by applying the principle of counter-currents; the fresh sodium comes into contact with air poorest in oxygen, whereas the fresh air first passes over the almost completely oxidised material (German Patents, 67,094 and 95,063). The hydrate, $\text{Na}_2\text{O}_2 \cdot 8\text{H}_2\text{O}$, is prepared by mixing sodium peroxide with six to eight times its weight of powdered ice or snow.

Properties.—Commercial sodium peroxide is a pale yellow powder containing 92-98 per cent. Na_2O_2 . It is exceedingly soluble in water, which at the ordinary temperature decomposes it, yielding sodium hydroxide and oxygen. Although sodium peroxide only evolves oxygen at a high temperature, it is a vigorous oxidising agent, usually causing organic materials to burst into flame. An aqueous solution ($\frac{1}{2}$ per cent.) is employed for bleaching textile fabrics, but in the case of animal fibres (silk and wool) the soda formed must be neutralised with dilute sulphuric acid. Sodium peroxide is a constituent of some washing powders. "**Oxone**" is compressed sodium peroxide, and "**Oxylith**," which evolves oxygen on treatment with water, is a compressed mixture of sodium peroxide and bleaching powder.

The amount of active oxygen in sodium peroxide may be ascertained by treating 1 g. of the sample with 15 c.c. water and 2 drops of concentrated cobalt chloride solution, and measuring the oxygen evolved (Archbutt, *Analyst*, **20**, 3).

Barium Peroxide, BaO_2 , is manufactured by passing air, freed from carbon dioxide and moisture, over barium monoxide, BaO , heated uniformly in retorts at 500° - 600° . The success of the operation depends on the monoxide being in a porous condition. Several methods are in use for the preparation of the monoxide in a suitable physical state for conversion into peroxide. It may be produced (1) by heating barium nitrate (German Patent, 128,500); (2) by heating at a high temperature an intimate mixture of witherite and carbon free from hydrogen (German Patent, 149,803); (3) by heating barium carbonate or barium hydroxide with barium carbide in the absence of air (German Patents, 135,330 and 142,051);

or (4) by heating in an electric furnace barium sulphate (4 mols.) with carbon (5 atoms) in the form of coke (United Barium Co., of Niagara Falls).

In order to obtain pure barium peroxide from the commercial product, the latter is rubbed into a paste with water and is stirred into well-cooled dilute hydrochloric acid. To the resulting turbid liquid baryta is added until the precipitation of silica and metallic oxides is complete. After filtration, excess of baryta is added, when pure hydrated barium peroxide, $\text{BaO}_2 \cdot 8\text{H}_2\text{O}$, is precipitated, and subsequently filtered, washed, and dried.

Properties.—Technical barium peroxide is a grey mass, whereas the pure compound is a white powder. At 700° it evolves oxygen yielding the monoxide. Barium peroxide is used for the manufacture of hydrogen peroxide, as a bleaching agent, and mixed with paraformaldehyde as a disinfectant. It is also employed for removing organic impurities from sulphuric acid, and as an addition to lithophone for preventing that pigment from becoming grey in sunlight (German Patent, 163,455).

Calcium Peroxide, CaO_2 , cannot be prepared by heating quicklime in air. Hydrated calcium peroxide is precipitated in the form of fine needles when aqueous hydrogen peroxide is added to lime-water. It is also prepared by adding a compressed mixture of sodium peroxide and slaked lime in molecular proportions to iced water (German Patents, 128,617 and 132,706). According to American Patent, 847,670, aqueous calcium chloride may be mixed with hydrogen peroxide, and the calcium peroxide precipitated by the addition of concentrated ammonia.

Properties.—Hydrates containing 8, 4, and 2 molecules of water are said to exist. The usual product contains $4\text{H}_2\text{O}$, and is a yellow crystalline powder, sparingly soluble in water, yielding an alkaline solution. Calcium peroxide is used as a bleaching agent, and is a component of some tooth powders. It may be employed with sulphuric acid for bleaching cotton seed oil and for removing rancidity from oil.

Magnesium Peroxide, MgO_2 , may be obtained by decomposing magnesium sulphate with sodium peroxide. A very antiseptic and stable product is produced by adding water to a mixture of sodium peroxide and magnesium hydroxide (or basic carbonate) (German Patent, 107,231). If sodium peroxide and alcohol are successively added to aqueous magnesium chloride at 20° , a powder containing 27 per cent. MgO_2 is precipitated, whereas if the precipitation occurs at a very low temperature (in a freezing mixture of sal ammoniac and ice) a product containing nearly 40 per cent. MgO_2 is obtained (English Patent, 2,743, 1902). Merck prepares "**magnesiumperhydrol**" by treating anhydrous magnesium oxide with chemically pure hydrogen peroxide; the product contains 15-25 per cent. MgO_2 (German Patent, 171,372).

Properties.—Magnesium peroxide is a white amorphous powder which is only sparingly soluble in water. It finds application as a bleaching agent and as an antiseptic (for wounds and skin diseases in the form of ointment).

Zinc Peroxide, ZnO_2 , is produced when aqueous solutions of zinc salts are decomposed with sodium peroxide, the product having a variable composition ($\text{ZnO}_2 + \text{ZnO}$). Merck treats anhydrous zinc oxide with hydrogen peroxide; the product, "Zinc perhydrol," contains about 50 per cent. ZnO_2 (German Patent, 171,372). For other methods of preparation see German Patents, 141,821 and 151,129.

Properties.—Zinc peroxide is a white or very pale yellow powder. It is used as an antiseptic (both in the form of powder and ointment), and is also serviceable for arresting bleeding.

Hydrogen Peroxide, H_2O_2 , is usually prepared from the cheaper peroxide, barium peroxide. The barium peroxide, finely powdered, is added gradually to a suitable dilute acid, e.g., hydrochloric acid. In this case the barium in solution is subsequently precipitated with sodium sulphate, so that after filtration a solution containing hydrogen peroxide and sodium chloride is obtained. If dilute sulphuric acid is employed instead of hydrochloric acid, after filtering off the insoluble barium sulphate, an aqueous solution of hydrogen peroxide is obtained, containing, however, some impurities derived from the barium peroxide. Phosphoric acid is also frequently used for decomposing the barium peroxide. Well washed carbon dioxide may be passed through cooled water in which finely powdered barium peroxide is suspended (Merck, German Patent, 179,771); the insoluble barium carbonate is separated by filtration.

In order to obtain a pure aqueous solution of hydrogen peroxide, the pure hydrated barium peroxide is prepared as previously described (see **Barium Peroxide**). The moist product is added gradually with constant stirring to dilute sulphuric acid (1 : 5) maintained below 10° by the addition of ice. When the acid is neutralised, the mixture is stirred for some hours, allowed to settle and filtered. The usual concentration of hydrogen peroxide is 3 per cent. by weight.

A concentrated solution of hydrogen peroxide may be prepared by adding sodium peroxide to well-cooled dilute sulphuric acid (20 per cent. calculated amount). On standing, about two-thirds of the sodium sulphate crystallises and is separated by filtration. The filtrate is distilled under diminished pressure (Merck). Merck's "**perhydrol**"—the so-called 100 per cent. hydrogen peroxide—contains 30 per cent. H_2O_2 , one volume of the solution yielding 100 volumes of oxygen. If a concentrated solution of hydrogen peroxide be distilled under diminished pressure, water distils over first, and subsequently nearly pure hydrogen peroxide (96 per cent.) distils over; boiling point, $84.85/68$ mm. or $69/26$ mm. Staedel found that on cooling the 96 per cent. product by ether and liquid carbon dioxide (-80°), crystallisation occurred, and when a nucleus of this product was introduced into the 96 per cent. liquid, pure transparent crystals of hydrogen peroxide, M.P. -2° , separated.

Hydrogen peroxide may also be manufactured by the hydrolysis of permono-sulphuric acid in the presence of sulphuric acid. The hydrogen peroxide may be obtained by distillation under reduced pressure or by extraction with a suitable solvent.

Properties.—Pure hydrogen peroxide is unstable, sometimes decomposing with explosive violence. The dilute aqueous solution, however, is fairly stable, but the decomposition (into water and oxygen) is particularly susceptible to catalytic influence (colloidal or finely divided metals, especially silver and platinum, carbon, iodine, and alkalis). The solution, however, may be preserved by the addition of a little acid (phosphoric, tannic, and barbituric acids have been recommended). Hydrogen peroxide is an oxidising agent. It is employed for restoring pictures, the black lead sulphide, formed by the action of sulphuretted hydrogen on white lead, being oxidised to white lead sulphate. It liberates iodine from potassium iodide in the presence of ferrous sulphate—a very delicate test for hydrogen peroxide, and distinguishing it from other oxidising agents. When a solution of hydrogen peroxide is added to a colourless solution of titanium dioxide in sulphuric acid an orange or yellow colour is produced. One part of H_2O_2 in ten million can be thus detected. Hydrogen peroxide is widely used as a bleaching agent, and as the only products of its decomposition are water and oxygen, it is serviceable for bleaching materials that are destroyed by acids, alkalis, chlorine, etc. Ostrich feathers, bone, ivory, wood, silk, cotton, teeth, and hair are all bleached by hydrogen peroxide, aqueous solutions of which constitute "**auricome**," "**golden hair water**," etc. For bleaching wool, which is rendered a pure white and does not subsequently become yellow, the wool, after soaking in a dilute solution of sodium silicate, is placed in a peroxide bath containing sodium silicate. For very delicate materials 1 vol. of hydrogen peroxide (10 vols.) is diluted with 10 vols. of water. Some dentifrices consist of hydrogen peroxide mixed with gypsum and starch.

Hydrogen peroxide is a constituent of "**Sanitas**," and is extensively used in medicine as an antiseptic, being especially valuable in the treatment of alveolar abscesses and scrofulous and syphilitic sores.

The concentration of hydrogen peroxide solutions may be ascertained (1) by titration with standard potassium permanganate ($\frac{N}{10} = 3.16$ g. KMnO_4 per litre) in the presence of dilute sulphuric acid (1 c.c. $\frac{N}{10}$ $\text{KMnO}_4 = .0017$ g. H_2O_2); (2) by treatment with excess of potassium iodide solution and subsequent titration of the liberated iodine with standard thiosulphate.

A 3 per cent. solution of hydrogen peroxide on decomposition yields approximately ten times its own volume of oxygen ("10 vol. peroxide").

II.—PERACIDS AND THEIR SALTS

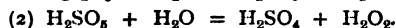
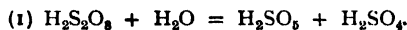
LITERATURE

T. SLATER PRICE.—"Per-Acids and their Salts." 1912.

PERACIDS and the salts derived from them contain relatively more oxygen than the acids and salts bearing the same names without the prefix. The peracids, like the peroxides, may be divided into two classes:—(1) The *true* peracids, which may either be formed by the action of hydrogen peroxide on the lower acids or produce hydrogen peroxide as a product when decomposed with dilute sulphuric acid; and (2) the *pseudo* or false peracids (*e.g.*, perchloric acid) which are not related to hydrogen peroxide in this manner. The true peracids and their salts only are dealt with in this section.

Two persulphuric acids are known; permonosulphuric acid (Caro's acid), H_2SO_5 , and perdisulphuric acid (usually called persulphuric acid), $\text{H}_2\text{S}_2\text{O}_8$.

Persulphuric Acid, $\text{H}_2\text{S}_2\text{O}_8$, is produced when sulphuric acid (D. 1.35-1.5) is electrolysed at low temperatures (5° - 10°) with a high current density at the anode. (Elbs and Schönherr, *Zeit. Elektrochem.*, 1, 417 and 468; 2, 245). The current density at the anode may be about 100 amperes per square decimetre. In the presence of sulphuric acid, persulphuric acid gradually undergoes hydrolysis to Caro's acid, which in turn is further hydrolysed to hydrogen peroxide and sulphuric acid.



Anhydrous persulphuric acid is prepared by adding anhydrous hydrogen peroxide (1 mol.) to chlorosulphonic acid (2 mols.).

Properties.—The anhydrous acid is a crystalline solid melting at 65° . The aqueous solution has strong oxidising properties.

Permonosulphuric Acid (Caro's acid), H_2SO_5 , may be prepared by treating potassium persulphate with concentrated sulphuric acid, or by the action of concentrated sulphuric acid on concentrated hydrogen peroxide (Baeyer and Villijer, *Ber.*, 1900, 33, 124, 858, and 1569). The pure anhydrous acid is prepared by the gradual addition of the calculated amount of 100 per cent. hydrogen peroxide to well-cooled chlorosulphonic acid, $\text{H}_2\text{O}_2 + \text{ClSO}_3\text{H} = \text{H}_2\text{SO}_5 + \text{HCl}$.

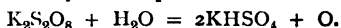
Properties.—The anhydrous acid is a crystalline solid melting at 45° . The aqueous solution is fairly stable, and possesses an odour resembling that of bleaching powder. In the presence of sulphuric acid, Caro's acid undergoes hydrolysis to hydrogen peroxide. This reaction is used for the manufacture of hydrogen peroxide, *e.g.*, by distilling a mixture of potassium persulphate with sulphuric acid (D. 1.4) under diminished pressure (German Patents, 199,958, 217,538, 217,539; English Patents, 24,507 (1905), 23,660 (1910)).

The best known salts of persulphuric acid are the ammonium and potassium salts, which were first prepared by Marshall in 1891 (*Trans. Chem. Soc.*, 1891, 59, 771; *Journ. Soc. Chem. Ind.*, 1897, 16, 396).

Ammonium Persulphate, $(\text{NH}_4)_2\text{S}_2\text{O}_8$, is prepared by the electrolysis of a saturated solution of ammonium sulphate at a low temperature. To avoid cathodic reduction a diaphragm is used, saturated ammonium sulphate solution is placed in the anodic compartment, and sulphuric acid (1 : 1) in the cathodic compartment. The temperature of the anodic solution is maintained at about 15° by a stream of water running through coils. The anode consists of smooth platinum wire, the anodic current density being 500-1,000 amperes per square decimetre. Crystals of ammonium persulphate separate at the anode, and fresh ammonium sulphate must be supplied. The yield is increased by the presence of excess of sulphuric acid, and also by the addition of hydrofluoric acid. The current efficiency is about 70 per cent. (Elbs, *Journ. pr. Chem.*, 1893, **48**, 185; Müller and Schellhaas, *Zeit. Electrochem.*, 1907, **13**, 257). The electrolysis may be carried out without a diaphragm if the electrolyte is kept acid, and a high cathodic current density is employed (German Patents, 155,805, 170,311, 173,977).

Potassium Persulphate, $\text{K}_2\text{S}_2\text{O}_8$, may be prepared in a similar manner, or by the double decomposition of ammonium persulphate with potassium carbonate.

Properties.—Ammonium persulphate forms monoclinic crystals and potassium persulphate, either small prisms or tabular crystals. The latter salt is only sparingly soluble in water (1.76 in 100 at 0°). The dry persulphates are quite stable, but their aqueous solutions gradually decompose thus:—



The persulphates are oxidising agents, liberating iodine from potassium iodide, oxidising ferrous salts to the ferric condition, etc. Silver salts exercise a marked catalytic effect on the oxidising properties of persulphates. Alkaline as well as acid solutions of persulphates have bleaching properties. Ammonium persulphate is used technically for introducing the hydroxyl group directly into the benzene nucleus, e.g., *o* nitrophenol is oxidised in alkaline solution to nitrohydroquinone. The ammonium salt is also used as a density reducer for negatives; the potassium salt, under the name "**anthion**," is used as a hypo-eliminator in photography, but its use appears to be open to objections. Many of the alkaloids give colour reaction with persulphates, and some of them (e.g., strychnine) are precipitated.

The estimation of persulphates is carried out by heating the solution with ferrous sulphate at 60° - 80° , and titrating the excess of ferrous iron by means of standard potassium permanganate.

Perboric Acid has not been prepared in the free state, but **sodium perborate**, $\text{NaBO}_3 \cdot 4\text{H}_2\text{O}$, is a compound of considerable technical importance, and its preparation is the subject of many patents. When a 3 per cent. solution of hydrogen peroxide (120 parts) is added to a saturated solution of borax (20 parts) containing sodium hydroxide (4 parts), the resulting solution slowly deposits sodium perborate in a very pure but rather unstable form (Tanatar, *Zeit. physikal. Chem.*, 1898, **26**, 132; and 1899, **29**, 162). A coarsely crystalline and very stable product is obtained by dissolving borax (76.5 parts) and sodium hydroxide (21.6 parts) in 140 parts of boiling water, and pouring the resulting solution, cooled to about 60° , into a 3 per cent. solution of hydrogen peroxide (950 parts). After the solution has been well stirred, it is cooled to below 10° and allowed to crystallise slowly by standing undisturbed for some hours. The crystals are drained and washed with ice-cold water. A further crop may be obtained by stirring powdered salt into the mother liquor. The yield is 88 per cent. (Girsewald, German Patent, 1907, 204,279). See also Giordani and Intoni, *Rend. Accad. Sci. Napoli*, 1928, [3] 34, 30.

A sodium perborate called **perborax**, $\text{Na}_2\text{B}_4\text{O}_8 \cdot 10\text{H}_2\text{O}$, is prepared by gradually adding an intimate mixture of boric acid (248 g.) and sodium peroxide (78 g.) to well-cooled water (2 l.). The separated crystalline product, after drying in air, contains 4.2 per cent. of active oxygen. It cannot be recrystallised from water, the first fraction which separates containing more active oxygen and the later fraction less active oxygen than the original salt.

If hydrochloric acid equivalent in amount to half the sodium in perborax is added to an aqueous solution of the salt, ordinary sodium perborate separates.

Properties.—Sodium perborate contains a high proportion of active oxygen (10.4 per cent.). The aqueous solution is distinctly alkaline, and contains hydrogen peroxide. The salt is only sparingly soluble in water, but if it is added to dilute sulphuric acid, a highly concentrated solution of hydrogen peroxide is obtained. The aqueous solution exhibits oxidising properties, liberating iodine from potassium iodide, oxidising ferrous to ferric salts, etc. Sodium perborate is employed as a washing and bleaching agent. As a washing agent it possesses all the advantages of sodium peroxide, without many of the disadvantages of that compound. The older "dry" soaps consisted of soda, borax, and soap, but most of the modern washing powders contain sodium perborate or "**perborin**." "**Perborin M**" is a mixture of soap, soda, and sodium perborate; "**persil**" consists of soap, soda, sodium silicate, and sodium perborate; and "**clarax**" of sodium phosphate, borax, and sodium perborate.

Ammonium Perborate, $\text{NH}_4\text{BO}_3 \cdot \frac{1}{2}\text{H}_2\text{O}$, is obtained by adding ammonia to a solution of boric acid in aqueous hydrogen peroxide (2.5 per cent.). Barium, calcium, strontium, and copper perborates have been prepared, but they are unstable. The amount of active oxygen in a perborate is ascertained by titration with standard potassium permanganate in the presence of dilute sulphuric acid. Another method consists in treating 0.1 g. of the sample with an acidified solution of ferrous ammonium sulphate, the excess of which is subsequently titrated with titanous chloride (*Journ. Soc. Dyers*, 1910, 26, 81).

Percarbonic Acid has not been prepared, but the potassium salt was prepared by Constam and Hansen in 1897.

Potassium Percarbonate, $\text{K}_2\text{C}_2\text{O}_6$, is prepared by the electrolysis of a saturated solution of potassium carbonate at -10° to -16° . When the current density is 30-60 amperes per square decimeter, aqueous potassium carbonate of density 1.56 on electrolysis at -10° gives a yield of percarbonate equal to 85.95 per cent. (*Zeit. Elektrochem.*, 1896-7, 3, 137).

Properties.—Potassium percarbonate is a pale blue hygroscopic powder, which decomposes readily on warming:—



It dissolves in ice-cold water with practically no decomposition. Potassium percarbonate is an oxidising agent, oxidising lead sulphide to lead sulphate, decolorises indigo, and bleaches cotton, wool, and silk. It is used as a bleaching agent and in photography under the name "**Antihypo**." By adding alcohol to a solution of sodium carbonate in 3 per cent. hydrogen peroxide, Tanatar obtained a product having a composition corresponding with the formula $\text{Na}_2\text{CO}_4 \cdot 1\frac{1}{2}\text{H}_2\text{O}$. This product, however, in many respects differs from true per-salts, and consequently some chemists believe it to be sodium carbonate with hydrogen peroxide of crystallisation, $\text{Na}_2\text{CO}_3 \cdot \text{H}_2\text{O}_2 \cdot \frac{1}{2}\text{H}_2\text{O}$.

Sodium Percarbonate, $\text{Na}_2\text{C}_2\text{O}_6$, is prepared by adding sodium peroxide slowly to ice-cold absolute alcohol. Dry carbon dioxide is then passed into the mixture at 0° - 5° for some hours. The crystalline mass is separated and washed with alcohol and ether.

The preparation of a sodium percarbonate, $\text{Na}_2\text{CO}_4 \cdot \frac{1}{2}\text{H}_2\text{O}$, from hydrated sodium peroxide and carbon dioxide, is described by Wolfenstein and Peltner (*Ber.*, 1908, 41, 280; see also German Patents, 145,746 and 188,569).

This product is used as a disinfectant and for the preparation of hydrogen peroxide.

Percarbonates are estimated by treating a weighed quantity of the sample with dilute sulphuric acid, and titrating the hydrogen peroxide formed with standard potassium permanganate.

Salts of several other peracids have been prepared, but at present have no technical importance.

SECTION XLIV

CIRCULATION OF NITROGEN IN NATURE

BY GEOFFREY MARTIN, Ph.D., D.Sc.

LITERATURE

CROSSLEY.—*Pharm. Journ.*, 1910, 30, 329.

FOWLER.—“Bacteriological and Enzyme Chemistry.” 1911.

BRAUN.—Abegg's “Handbk. d. anorg. Chem.,” vol. 3, pt. 3, 216.

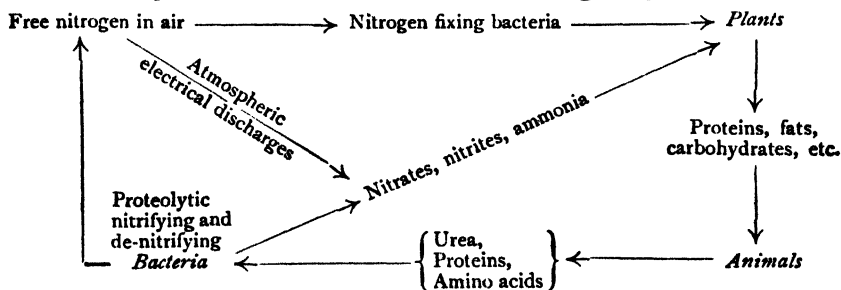
NITROGEN is an essential component of animal and vegetable living matter, and must be supplied to them in an assimilable form.

Animals obtain their nitrogen in an “organically combined” form from vegetable matter. Plants, however, obtain their nitrogen principally in the form of nitrates or ammoniacal salts, which they absorb from the soil. To a much smaller extent they take up (at least some varieties do) nitrogen directly from the atmosphere.

When animal and vegetable matter decays, the combined nitrogen passes again in the form of ammonia and nitrates into the soil. Part, however, is set free as nitrogen gas, which thus escapes into the atmosphere.

According to Arrhenius (“Das Werden der Welten,” pp. 130, 131, 1908) no less than 400,000,000 tons of nitrogen are annually withdrawn from the atmosphere either by direct assimilation by plants or by union with oxygen by means of electrical discharges which occur in the air. The combined nitrogen is washed into the soil and there taken up by plants, whence it passes into circulation in the animal world. (The amount of atmospheric oxygen annually absorbed by plants and animals from the atmosphere is about 100 times greater than the amount of nitrogen absorbed.) Now, since nitrogen does not accumulate to any great extent in the soil, these 400,000,000 tons of atmospheric nitrogen are yearly set free again as inert nitrogen gas by the decomposition of organic matter, and so are restored again to the atmosphere. Consequently there is continually going on in nature an immense and endless circulation of nitrogen.

The following scheme shows the course of the **nitrogen cycle** in nature:—

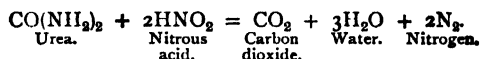


Every scrap of nitrogen in every plant and every animal, and in the soil, came originally from free atmospheric nitrogen. The fixation occurs principally by means of silent electrical discharges, which continually go on in the atmosphere. Under the influence of electricity the atmospheric nitrogen becomes active, and unites with the oxygen of the air to form nitric oxide, thus $N_2 + O_2 = 2NO$. The nitric oxide, NO , at once combines with the oxygen of the air to form nitrogen peroxide, NO_2 , thus $NO + O = NO_2$. The NO_2 is then dissolved by

falling rain, forming nitrous and nitric acid ($2\text{NO}_2 + \text{H}_2\text{O} = \text{HNO}_2 + \text{HNO}_3$), and in this form it enters the soil, where the nitric acid and nitrous acid combine with bases in the soil like lime, potash, etc., to form calcium or potassium nitrate or nitrite; these substances are finally absorbed by the roots of growing plants. This is the main method whereby nitrogen is absorbed from the atmosphere, and for many years it was thought that this was the only way of absorbing nitrogen. However, it is now known, thanks to the researches of Hellriegel and Wilfarth, that certain plants, especially those belonging to the Leguminosæ, directly absorb nitrogen by means of certain bacteria. Peas and beans possess this capacity highly developed. Clover also is a plant which absorbs large amounts of nitrogen from the air during its growth. Practical examples of utilising this fact have long been known. After a crop has been grown which tends to exhaust nitrogen from the soil (e.g., wheat) it is usual to grow a crop of clover, which is then ploughed into the soil. The nitrogen absorbed by the clover from the atmosphere is thus returned to the soil when the clover rots, and so a fresh crop of wheat can now be grown. This is known as "rotation of crops."

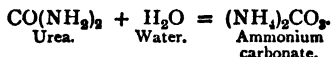
The nitrogen as nitrate in the soil is absorbed by the plant and turned into complex protein matter. The plant is eaten by animals, and the nitrogenous protein is, by the processes of peptic and tryptic digestion in the animal body, converted into end products, largely consisting of amino acids. These amino acids are again built up into the body substance through biotic energy inherent in the cells, part having been utilised as fuel in maintaining that energy.

In the case of **flesh-eating mammals** most of the nitrogen not used in maintaining the body substance is eliminated in the form of **urea**, $\text{CO}(\text{NH}_2)_2$, in the urine. From this urea much nitrogen is set free in the free state by the action of nitrous acid, HNO_2 , thus:—



Thus the nitrogen, in part at least, finds its way back to the atmosphere.

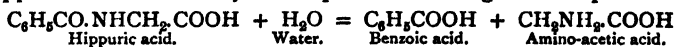
In the case of animals, whose diet is wholly vegetable, most of the nitrogen is eliminated as **hippuric acid**, $\text{C}_6\text{H}_5\text{CO.NHCH}_2\text{COOH}$. These two main end products of animal metabolism, viz., **urea** and **hippuric acid**, are not directly available for plant food. They must first be converted into ammonia, NH_3 , by means of certain organisms contained in the soil. The most prominent of these organisms are the *Micrococcus ureæ* and the *Bacillus ureæ*. These organisms, being widely distributed, soon cause urine when exposed to the air to evolve ammonia. They are not contained in freshly excreted urine. The following is the change which takes place:—



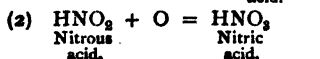
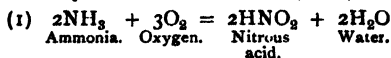
It is supposed that the change is brought about by an "enzyme" called **urease**, secreted by the micro-organisms.

The ammoniacal fermentation of the urea proceeds until about 13 per cent. of ammoniacal carbonate is formed in solution, when it ceases. Nitrogen in the form of ammonium carbonate is directly assimilable as a plant food, being built up again into vegetable proteins, which form the food of animals.

The hippuric acid is similarly decomposed according to the equation—



Plants, however, not only absorb their nitrogen in the form of ammonia, but also in the form of oxidation products of ammonia, viz., nitrites and nitrates.

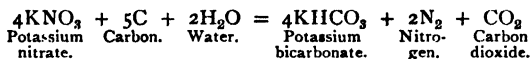


The process of oxidation of ammonia into nitrous and nitric acid is known as **nitrification**, and occurs in two distinct stages by means of two separate lots of organisms. The one kind of organism oxidises the ammonia to **nitrite**, and the other kind oxidises the nitrites to **nitrates**.

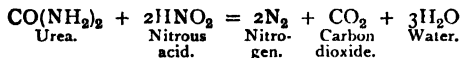
According to Boullanger and Massol there are two well-defined organisms which convert the ammonia into nitrites, viz., *Nitrosococcus*, a large, nearly spherical, organism, existing in two varieties, one found in Europe and the other in certain soils of Java. The other smaller organism is called *Nitrosomonas*.

The **nitric** organism is a very small bacterium, slightly longer than broad. The nitrous and nitric organisms exist side by side in nature, and neither can perform its work without the aid of the other, e.g., the nitrous organism alone cannot carry the oxidation of the ammonia further than the stage of nitrite, while the nitric organism is incapable of directly oxidising ammonia.

In addition to the oxidising of ammonia to nitrites and nitrates (**nitrification**), there also goes on a reverse process (**denitrification**) whereby nitrites and nitrates are *destroyed* by the action of certain organisms, e.g., a nitrate is converted directly into nitrogen, the final result being shown by some such den equation such as this :—



The denitrifying organisms may be divided into two classes. (1) True denitrifying organisms, which actually destroy nitrates, converting them into free nitrogen. (2) Indirect denitrifying organisms, which reduce nitrates to nitrites, and these nitrites, when brought into contact with amido compounds such as urea, in the presence of acid, are decomposed with liberation of nitrogen, thus :—



By means of these changes much nitrogen from the animal or vegetable body is again thrown back into the atmosphere in its original form, thus maintaining the nitrogen cycle in nature.

The chief nitrogenous artificial manures used are ammonium salts and sodium or potassium nitrate. The quantities of these substances, however, at the disposal of agriculturists, is far less than the demand.

Until quite recently the supply of nitrates, and also of nitric acid, was derived almost exclusively from the natural deposits of **sodium nitrate**, NaNO_3 , found in Chile (Chile saltpetre). The ammonium salts were principally derived from coal-tar and gas-making works, coming into the market as ammonium sulphate. The high price of these products, and the urgent need for more nitrogenous manure for agriculturists, has caused the successful invention recently of several processes for combining atmospheric nitrogen artificially, in a form assimilable by plants. The economic "fixation of nitrogen" has been achieved by three distinct methods which we will later deal with in detail, viz. :—(1) Direct oxidation of atmospheric nitrogen to nitric acid or nitrates. (2) Fixation of atmospheric nitrogen by means of calcium carbide, with formation of calcium cyanamide. (3) Direct formation of ammonia, NH_3 , by direct combination of atmospheric nitrogen and hydrogen.

Other nitrogenous compounds much used are cyanides, ferro- and ferricyanides, etc. Cyanides find their chief use in the extraction of gold from quartz.

Statistics—

ESTIMATED WORLD PRODUCTION AND CONSUMPTION OF NITROGEN

(In terms of pure Nitrogen)

(Long Tons)

Production.	1930.	1931.
By-product sulphate of ammonia -	392,000	313,000
Synthetic sulphate of ammonia -	396,000	434,000
Cyanamide - - - -	232,000	168,000
Nitrate of lime - - - -	121,000	95,000
Other forms of synthetic nitrogen -	410,000	373,000
Other forms of by-product nitrogen	41,000	31,000
Chilean nitrate of soda - - -	357,000	210,000
Total Production - -	1,949,000	1,624,000
Consumption.		
Manufactured nitrogen - - -	1,482,000	1,399,000
Chilean nitrate of soda - - -	304,000	191,000
Total consumption - -	1,786,000	1,590,000
Agricultural consumption about -	1,603,000	1,432,000

SECTION XLV

THE NITRATE INDUSTRY

BY GEOFFREY MARTIN, D.Sc., Ph.D.

LITERATURE

- NORTON.—“Consular Report on the Utilisation of Atmospheric Nitrogen.” Washington, 1912.
- NEWTON.—*Journ. Soc. Chem. Ind.*, 1900, 408.
- STURZER.—“Nitrate of Soda.” 1887.
- BILLINGHURST.—*Chem. Zeit.*, **11**, 752.
- Sir WILLIAM CROOKES.—“The Wheat Problem.”
- THIELE.—“Saltpeterwirtschaft und Saltpeterpolitik.” 1905.
- W. GLUND.—United States Patents 1,855,393 (1933), 1,710,636 (1929).
- For economic conditions see *Financial News*, 4th Oct. 1932; *Chemical Trade Journal*, 1932, **91**, 317; *Chemical Age*, 1932, **27**, 328; *The Times*, 17th July 1931; *Chem. and Ind.*, 1930, **49**, 393.
- See also British Patent 391,276.

SODIUM NITRATE (CHILE SALTPETRE), NaNO_3

SODIUM nitrate occurs in enormous quantities in the valleys of the Tarapaca and Tacoma, along the coast of Chile and Peru. Deposits also occur on the coast of Bolivia. The whole district is now a desert (rain only falling once in three years or so), but signs of former fertility are evident.

The main nitrate bed of Tarapaca is $2\frac{1}{2}$ miles wide, and about 260 miles long, stretching along the eastern slope of the Cordilleras and the sea. The average distance from the sea coast is 14 miles, although some rich deposits occur inland as far as 90 miles. The deposits are some 500-600 ft. higher than the valley of the Tamaragal, the deposits thinning out as the valley is approached, all nitrate vanishing at the bottom.

The nitrate (locally called “caliche”) forms a rock-like mass 3-6 ft. deep; it is covered over to a depth of 6-10 ft. by rocky matter, which in its turn is covered to a depth of 8-10 in. by fine loose sand. The nitrate lies upon a bed of clay, free from nitrate, which covers primitive rock. The colour of the nitrate varies from pure white to brown or grey.

The crude caliche contains from 10-80 per cent. of NaNO_3 , much NaCl , a little KNO_3 , some sodium perchlorate, NaClO_4 , and sodium iodate, NaIO_3 .

A caliche containing 40-80 per cent. NaNO_3 is regarded as of the best quality; 25-40 per cent. NaNO_3 is second quality caliche, while anything below 25 per cent. NaNO_3 is regarded as inferior quality.

The richest beds, it is stated, have been practically worked out, but it is asserted that sufficient caliche still exists in Northern Chile and the neighbouring lands of Peru and Bolivia to supply the world's markets for another 150 years at the present rate of consumption. Until recently the **Shanks** system was employed.

The caliche is worked for refined nitrate on the places of production in about one hundred and fifty factories. The ground is broken by blasting, and the big blocks are broken into smaller ones by means of crowbars, and the lumps of caliche are separated from the rocky over-layer by hand. The caliche is crushed into 2-in. lumps, placed in long iron tanks heated with steam coils, and is there boiled with water. The earthy residue is left on a false bottom about 1 ft. from the real bottom of the tank, while the mother liquors, containing the NaNO_3 in solution, are run into the next tank. The extraction of the caliche is carried out systematically. The tank containing nearly exhausted caliche is treated with fresh water, while the liquor from this tank is run through a 9-in. pipe into

the second tank, where it meets with a partly extracted caliche. From this, still rich in nitrate, the mother liquors pass on, finally emerging from the last tank of a battery of six filled with freshly charged caliche. The hot mother liquors from the last tank, at a temperature of 112° , and containing about 80 lbs. of sodium nitrate per cubic foot, are run off into the crystallising pans where, after cooling for four to five days, much nitrate is deposited in a crystalline condition.

The mother liquors now contain about 40 lbs. of nitrate per cubic foot, and are used in the systematic lixiviation of the caliche described above, being run (in addition to the weak liquor from the final exhaustion of the caliche) on to the subsequent caliche. These mother liquors, however, contain much iodine in the form of sodium iodate, from which the iodine must first be recovered in the manner described in the section on **Iodine** in this Volume, p. 407. From the iodine house the mother liquors are passed on to the lixiviating tanks, to be used once more, as above described, in extracting crude caliche. The iodine recovered in this way is now an important article of commerce.

The crystals of nitrate deposited in the crystallising tanks are covered with a little water, drained, and allowed to dry in the sun for five or more days. They have then the following composition:—

	Best Quality.	Second Grade.
NaNO ₃	96.5	95.2
NaCl	0.75	2.5
Na ₂ SO ₄	0.43	0.7
H ₂ O	2.3	1.6

About 1 ton of coal is required for the production of 7 tons of nitrate.

This 95-96 per cent. NaNO₃ is shipped, and can be used directly as manure. About 20 per cent. of total export is used for the manufacture of nitric acid and other nitrogen compounds.

The second grade 95 per cent. NaNO₃ contains (as is evident from above analyses) much NaCl, and sometimes a little KNO₃ and sodium perchlorate, NaClO₄. This latter substance is especially undesirable in manurial nitrate, as it acts as a poison for plants. The nitrate is usually valued on the basis of its nitrogen content, the pure nitrate containing 16.47 per cent. N against 13.87 per cent. N in potassium nitrate (KNO₃, saltpetre).

The **Shanks** system has recently been substituted by the **Guggenheim** flotation system, but the success of the latter has been questioned. See *Financial News*, 4th Oct. 1932; *Chem. Trade Journ.*, 1932, 91, 317; *Chem. Age*, 1932, 27, 328; *Chem. and Ind.*, 1930, 44, 393.

Properties of Sodium Nitrate.—The substance forms colourless transparent anhydrous rhombohedra whose form closely approximates to cubes (hence the term "cubic nitre"). It fuses at 316° , and at higher temperatures evolves oxygen with formation of nitrite. At very high temperatures all the nitrogen is evolved, and a residue of Na₂O and Na₂O₂ is left. The salt, *when quite free from chlorides of calcium and magnesium*, is not hygroscopic; as usually obtained, however, it is slightly hygroscopic. One hundred parts of water dissolve:—

Temperature -	0° C.	10°	15°	21°	29°	36°	51°	68°
NaNO ₃ -	66.7	76.3	80.6	85.7	92.9	99.4	113.6	125.1

Statistics.—The shipments of sodium nitrate from Chile and Peru are rapidly decreasing, as the following figures show:—

Year.	Tons (Metric).	Year.	Tons (Metric).
1850	25,000	1910	2,274,000
1870	150,000	1911	2,400,000
1890	1,000,000	1912	2,542,000
1900	1,400,000	1930	2,407,205
1908	1,746,000	1931	1,107,960
1909	2,100,000	1932	682,700

In 1912 the 2,542,000 tons of nitrate were divided among the following countries:—United Kingdom, 5.60 per cent. of total; Germany, 33.30 per cent.; France, 14.30 per cent.; Belgium, 12.2 per cent.; Holland, 5.90 per cent.; Italy, 2 per cent.; Austria-Hungary, 0.25 per cent.; Spain and Portugal, 0.50 per cent.; Sweden, 0.15 per cent.; United States, 22.2 per cent.; Japan and other countries, 3.60 per cent.

In view of the rapidly increasing demand for sodium nitrate, there is grave doubt as to the possibility of any great extension in the demand being met by Chile. The caliche beds are spread over great areas in a desert region where fuel and water are expensive, and are not uniform in

quality. The richer and more easily extracted nitrate, the first to be worked, is stated to be confined to the valleys of the Tarapaca and Tacoma. 100-150 years is the limit assigned for the working out of the less valuable beds in the hands of the Government. However, it must be remembered that perfectly enormous supplies of inferior nitrate remain in the soil, now regarded as not worth working, and possibly with improved methods these supplies will last much longer than the estimated time.

Uses of Sodium Nitrate.—The main use of sodium nitrate is for manurial purposes, no less than 80 per cent. of total product being used for this purpose in 1912 (see British Patent 315,262). Of the remaining 20 per cent. used for manufacturing nitrogen compounds about 15 per cent. was used for making nitric acid, and the remaining 5 per cent. for manufacture of potassium nitrate (saltpetre) for use in the lead chamber process for making sulphuric acid, and for other purposes as well.

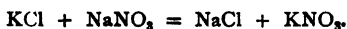
For the manufacture of old black gunpowder or for fireworks the slightly hygroscopic nature of NaNO_3 renders it inapplicable as a substitute for potassium nitrate, KNO_3 .

POTASSIUM NITRATE, KNO_3

Potassium Nitrate, KNO_3 , crystallises in large prisms, isomorphous with rhombic aragonite, and so is sometimes known as "prismatic" saltpetre. It is used principally for the production of black shooting powder and for fireworks.

However, since the production of the new smokeless powders, the manufacture of black powder has greatly decreased, and with it the use of potassium nitrate has also decreased.

Manufacture.—Germany alone produces 20,000 tons of KNO_3 , and Great Britain imports annually 10,000 tons, while over 30,000 tons are produced in other lands, almost entirely by the so-called "conversion process," using as raw materials the German potassium chloride, KCl (mined at Stassfurt), and Chile saltpetre, sodium nitrate, NaNO_3 . This process depends upon the fact that under certain conditions of temperature and pressure, solutions of potassium chloride, KCl , and Chile saltpetre, NaNO_3 , when mixed, undergo a double decomposition, sodium chloride being deposited and potassium nitrate remaining in solution:—



This conversion takes place all the more readily because KNO_3 is much more soluble in hot and much less soluble in cold water than is sodium nitrate. 100 g. of water dissolve:—

	KNO_3 .	NaNO_3 .	NaCl .	KCl .
At 20° C.	32 g.	88 g.	36 g.	34 g.
„ 100° C.	246 g.	176 g.	39.6 g.	56.5 g.

The potassium nitrate thus obtained is exceedingly pure. In fact, that technically produced for the manufacture of black powder must not contain more than 0.1-0.5 per cent. NaCl .

The process is carried out as follows:—In a large iron pan, provided with a stirring apparatus and indirect steam heating arrangement, there is added 188 kg. potassium chloride (88 per cent., containing NaCl) and 180 kg. Chile saltpetre (95 per cent.) and 160 kg. of mother liquors from a previous operation. The solution is boiled by indirect steam. The amount of water present is not sufficient to dissolve all the difficultly soluble NaCl present, whereas the readily soluble KNO_3 at once goes into solution. The liquid is filtered hot, and the residual salt, after covering with a little water and draining, is sold as such. The hot mother liquors are allowed to cool, when "raw" KNO_3 crystallises out—still in a crude state, however, containing several per cent. of NaCl .

The crude KNO_3 is once more dissolved by hot water, and allowed to crystallise in copper pans provided with stirrers. "Refined" potassium nitrate is thus

obtained, which, after passing through a centrifugal machine, washing with very little water, and drying, is almost quite free from NaCl. The various mother liquors resulting from these operations are evaporated and added to the mother liquors for the initial treatment of the KCl and NaNO₃ as above described.

There is thus but little loss, although the calcium and magnesium salts which gradually accumulate in the mother liquors must from time to time be removed by the cautious addition of sodium carbonate. Sometimes a considerable amount of sodium perchlorate, NaClO₄, and sodium iodate accumulate in these mother liquors, and occasionally they are worked up for perchlorate and iodine.

See also British Patents 360,237, 360,259, 362,162, 377,131.

Potassium nitrate, KNO₃, is one of the oldest known salts of potassium, and is characterised by the fact that when mixed with oxidisable matter it gives rise to readily inflammable products, such as black powder and mixtures used in fireworks. KNO₃ is the final result of the oxidation of nitrogenous organic material, and so it is steadily produced in the soil from decaying organic matter by means of special bacteria. It thus occurs, together with other nitrates, as an efflorescence in the soil in tropical countries like Bengal, Egypt, Syria, Persia, Hungary, etc. In India, and especially Ceylon, considerable quantities, e.g., 20,000 tons per year, of potassium nitrate are obtained by the lixiviation of certain porous rocks, which yield from 2.5-8 per cent. of their weight of nitrate.

Whether derived from rocks or from efflorescences in the soil near stables, urinals, etc., the nitrate is invariably produced by the decay of nitrogenous organic material, first into ammonia, and later, by oxidation, into nitrous and nitric acids, which, in the presence of alkali, produce potassium nitrate.

At one time much potassium nitrate was produced in Europe by the Governments of the different countries for supplying themselves with the necessary nitrate for making gunpowder, the operation being carried out in "*saltpetre plantations.*"

For this purpose nitrogenous organic matter of animal or vegetable origin was allowed to putrefy by exposure to air in a dark place; it was then mixed with lime, mortar, and wood ashes (containing salts of potassium and sodium) and heaped into low mounds. These were left exposed to the air, being moistened from time to time by urine and the drainage from dung-heaps.

After a couple of years the outer surface of the saltpetre earth was removed, and the nitrates extracted by lixiviation with water. To the solution potassium carbonate was added, and on concentration and filtering from the precipitated calcium and magnesium salts, the clear solution was evaporated for KNO₃.

This industry, however, since the introduction of the cheap NaNO₃, has almost entirely ceased, the KNO₃ being now made from the NaNO₃ by the conversion process described above. It is possible that, in a modified form, this old industry may revive.

Thus Muntz and Laine (*Compt. rend.*, 1905, 141, 861; 1906, 142, 430, 1239) impregnated peat with sufficient lime to combine with the nitric acid formed, and then inoculated it with nitrifying bacteria and passed through it a 0.75 per cent. solution of ammonium sulphate (NH₄)₂SO₄, at 30° C., thereby obtaining a 1 per cent. solution of calcium nitrate, Ca(NO₃)₂. The bacteria would oxidise quickly only *dilute* solution of ammonium salts, but even 22 per cent. nitrate in the solution did not interfere with the process. Consequently, by sending the ammonium sulphate solution five times through the peat beds there was finally obtained a solution containing 41.7 g. of Ca(NO₃)₂ per litre.

Yield.—6.5 kg. of Ca(NO₃)₂ in twenty-four hours per cubic metre of peat. The old saltpetre plantations yielded 5 kg. KNO₃ in two years per cubic metre.

Properties.—White soluble crystals which readily dissolve in water, producing a great lowering of temperature, a fact which was once utilised for making freezing mixtures. 100 parts of water dissolved:—

Temperature	-	0° C.	10°	20°	40°	60°	80°	100°	114.1°
KNO ₃	-	13.3	20.9	31.6	63.9	109.9	169	246	311

The saturated solution boils at 114.1° C. When heated, KNO₃ evolves oxygen, and so is a powerful oxidising agent.

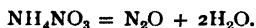
Uses.—Chiefly for the manufacture of black powder and fireworks, but also for pickling or salting meat, to which it imparts a red colour. It is also used in medicine and in the laboratory.

Calcium Nitrate, $\text{Ca}(\text{NO}_3)_2 + 4\text{H}_2\text{O}$, containing 11.86 per cent. N, is now made by allowing nitric acid (made by the electrical oxidation of the atmosphere) to act on limestone (see p. 446). At the present time it is being produced in rapidly increasing quantities, and is now competing with Chile saltpetre (sodium nitrate) for manurial purposes. One great disadvantage to its use is its very hygroscopic nature; it is too readily washed from soils without complete assimilation of the nitrogen. It is now produced in Norway on a large scale; it is put on the market in coarse lumps, in a partly dehydrated condition, containing 13 per cent. N., being sold as "Norwegian saltpetre," or "nitrate of lime." It is largely used for preparing barium nitrate, $\text{Ba}(\text{NO}_3)_2$, and ammonium nitrate.

Ammonium Nitrate, $(\text{NH}_4)_2\text{NO}_3$, is a product of increasing importance. It is used in large quantities for the manufacture of certain safety explosives, being especially suitable for this purpose because it leaves no solid residue on explosion, and develops heat when it decomposes according to the equation:—



also for making nitrous oxide:—



Manufacture.—It may be produced by leading vapours of ammonia into nitric acid, using synthetic ammonia and Ostwald's nitric acid (see p. 448).

Regarding the production of ammonium nitrate by Ostwald's process of directly oxidising the ammonia to ammonium nitrate by catalytic platinum, the reader should see the following patents:—English Patents, 698 and 8,300, 1902; 7,908, 1908; American Patent, 858,904, 1907.

For a description of the process see Ostwald, *Berg. u. Hüttenm. Rundschau*, 1906, 3, 71; see also Kaiser, English Patent, 20,305, 1910; see also Schmidt and Böcker, *Ber.*, 1906, p. 1366.

Frank and Caro (D.R.P., 224,329) propose to use thorium oxide as the catalyst. M. Wendriner (*Chem. Ind.*, 1911, p. 456) suggests uranium compounds as catalyst.

The Deutschen Ammoniak-Verkaufs-Vereinigung, in Bochum, produced by Ostwald's process in 1908, 651 tons; 1909, 1,096 tons; 1910, 1,237 tons.

In 1915 one firm alone in Germany estimate that they will produce 90,000 tons annually of this ammonium nitrate by this process.

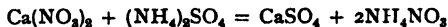
Traube and Biltz (Swedish Patent, 8,944, 1897) oxidise ammonia gas by electrolytic oxygen, using as catalysers copper hydroxide, and claim an excellent yield.

Siemens and Halske (D.R.P., 85,103) oxidise ammonia gas by silent electrical discharges.

Nithack (D.R.P., 95,532) electrolyses water, containing nitrogen, dissolved under a pressure of 50-100 atmospheres.

See also British Patent 367,660; United States Patent 1,811,712; British Patents 357,396, 358,295, 358,301, 360,165; United States Patent 1,801,677.

The bulk of the ammonium nitrate at the time of writing is made, however, by treating calcium nitrate (made as above described) with rather less than the equivalent quantity of ammonium sulphate:—



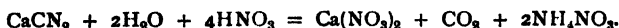
(see Wedekind's patent, English Patent, 20,907, 1909).

The yield is quantitative, the CaSO_4 being removable without difficulty.

For a complete summary of patents see *Zeit. gesamt. Scheiss. Sprengstoffwesen*, 1914, 9, 81.

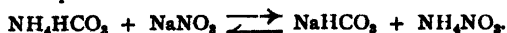
Regarding the manufacture of ammonium nitrate from calcium nitrate the reader should consult the patents:—Dyes, English Patent, 15,391, 1908; Nydegger and Wedekend, English Patent, 20,907, 1909.

The Norsk Hydro-Elektrisk-Kraeilstof-Aktieselskab (D.R.P., 206,949 of 1907) prepare ammonium nitrate by leading nitrous gases through calcium cyanamide:—



See also the French Patent, 417,505, of 1910; English Patent, 19,141, of 1910; Colson, *Journ. Soc. Chem. Ind.*, 1910, p. 189; Garroway, English Patent, 7,066, 1897.

Preparation of Ammonium Nitrate by the Ammonia Soda Process.—In 1875 Gerlach (English Patent, 2,174) attempted to produce ammonium nitrate from ammonium carbonate and Chile saltpetre according to the equation:—

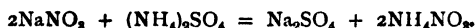


The process, however, failed on account of the incomplete decomposition (see *Journ. Soc. Chem. Ind.*, 1889, p. 706).

The following patents bear on this:—Lesage & Co. (French Patent of 20th Jan. 1877), Chance (English Patent, 5,919, 1885), Fairley (D.R.P., 97,400; English Patent, 1,686, 1896), cf. Lunge ("Sulphuric Acid and Alkali," Vol. III.). Feld (English Patent, 5,776, 1906; American Patent, 839,741; D.R.P., 171,172, 178,620) has recently improved the process.

The theory of the process, according to the Phase Law, has been worked out in full by Fedotieff and Koltunov, *Zeits. anorg. Chem.*, 1914, 85, 247-260.

Numerous attempts have been made to realise the production of ammonium nitrate from the equation:—

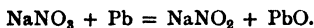


Concerning this the following patents should be consulted:—Roth (D.R.P., 48,705, 53,364, 55,155, 149,026), F. Benker (D.R.P., 69,148), T. Fairley (English Patent, 1,667, 1896), J. V. Skoglund (D.R.P., 127,187, 1901), E. Naumann (D.R.P., 166,746), Caspari, Nydegger, and Goldschmidt (American Patent, 864,513; D.R.P., 184,144), C. Craig (English Patent, 5,815, 1896; D.R.P., 92,172), R. Lennox (D.R.P., 96,689), Wahlenberg (English Patent, 12,451, 1889), Campion and Tenison-Woods (English Patent, 15,726, 1890).

Ammonium nitrate is extremely soluble in water and hygroscopic. These properties mitigate to some extent against its usefulness as a manure. When dissolved in water a lowering of temperature up to -16.7°C . is attainable. Owing to its great solubility in water it cannot be manufactured by the double decomposition of sodium nitrate with ammonium salts.

Sodium Nitrite, NaNO_2 .—Some 5,000 tons of this substance are now annually produced for the purpose of diazotisation in the manufacture of dyes (see **Martin's** "Industrial Chemistry: Organic").

Until recently it was made solely from Chile saltpetre by heating with metallic lead to 450°C .:—



See J. Turner, *Journ. Soc. Chem. Ind.*, 1915, 34, 585, for details.

At the present time it is now almost exclusively produced by the cheaper process of leading the hot nitrous gases coming from the furnaces for the manufacture of nitric acid by the Birkeland-Eyde process (pp. 443-446) up a tower down which streams NaOH or Na_2CO_3 solution.

When the hot nitrous gases from the furnace are thus treated when at a temperature of $200^\circ\text{--}300^\circ\text{C}$. (when they consist of a mixture of NO and NO_2 molecules), there is produced a nitrate-free sodium nitrite, NaNO_2 , which is now manufactured in this way in Christiansand. For further particulars see p. 447.

PRODUCTION OF NITRATES (NATURAL)

(Long Tons)

Producing Country and Description.	1930.	1931.	1932.
BRITISH EMPIRE			
India— Nitrate of potash (estimated) - . . .	4,600	7,000	9,000
FOREIGN COUNTRIES			
Spain— Nitrified earth -	900	(a)	(a)
Egypt— Nitrate shale (5 per cent. nitrate) (b) -	1,634	2,603	1,556
Chile— Nitrate of soda -	2,407,205	1,107,900	682,700
China— Nitrified earth -	5,300	5,350	5,100

(a) Information not available

(b) One company only.

SECTION XLVI

THE NITRIC ACID INDUSTRY

BY GEOFFREY MARTIN, D.Sc., Ph.D.

LITERATURE

- G. FAUSER.—*Chem. Met. Eng.*, 1930, **37**, 604; 1932, **39**, 430; *Chim. et Ind.*, 1931, **25**, 556.
- Chemical Age*, 1930, **23**, 612, 613.
- A. W. CROSSLEY.—“The Utilisation of Atmospheric Nitrogen” (Thorpe’s “Dictionary of Applied Chemistry,” Vol. III., p. 698). 1912. (An excellent account.)
- T. E. NORTON.—“Consular Report on the Utilisation of Atmospheric Nitrogen.” Washington, 1912. (Gives statistics.)
- J. KNOX.—“The Fixation of Atmospheric Nitrogen.” 1914. (Gives much of the literature.)
- DONATH and INDRA.—“Die Oxydation des Ammoniaks zu Salpetersäure und Salpetriger Säure.” 1913.
- DONATH and FRENZEL.—“Die technische Ausnutzung des atmosphärischen Stickstoff.” 1907.
- ESCARD.—“Fabrication électrochimique de l’Acide Nitrique et des Composés Nitrés à l’Aide des Éléments de l’Air.” Paris, 1909.
- CARO.—*Chemical Trade Journal*, 1909, **44**, 621.
- HABER and KOENIG.—*Zeitsch. Elektrochem.*, 1910, **16**, 17.
- E. KILBURN SCOTT.—“Production of Nitrates from the Air,” *Journ. Soc. Chem. Ind.*, 1915, **34**, 113.
- P. GAVELLE.—*Chim. Ind.*, 1932, **28**, 3,267.
- T. MCKNIGHT.—*Chem. Met. Eng.*, 1932, **39**, 490.
- TAYLOR, CHILTON and HANDFORTH.—*Ind. Eng. Chem.*, 1931, **23**, 860.
- H. GROSSMANN.—*Chem. Ztg.*, 1929, **53**, 661.
- L. LHEURE.—*Chim. et Ind.*, 1929, **21**, 619; *Chem. Met. Eng.*, 1929, **36**, 481.
- W. M. MITCHELL, *Ind. Eng. Chem.*, 1929, **21**, 442.
- See also the following patents: United States Patents 1,859,863, 1,872,638, 1,878,676, 1,855,393, 1,840,063; British Patents 390,066 (1933), 360,778, 367,709, 363,436, 361,161, 378,894, 355,178.

NITRIC ACID, HNO₃

WITHIN the last thirty to forty years a very great change has come over the character of the nitric acid manufactured. At one time the only acid placed on the market was an acid of 55-68 per cent. HNO₃ (1.35-1.41 sp. gr.), and the somewhat stronger “red fuming” acid; at the present time the bulk of the nitric acid made has a strength of 95 per cent. and over (1.5-1.52 sp. gr.). In order to produce an acid of this strength very considerable difficulties have to be overcome, since 100 per cent. HNO₃ is only stable below 0° C., and begins to boil at 86° C., evolving red fumes and partially decomposing according to the equation:—



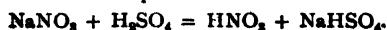
As the nitrous gases escape the boiling point of the acid rises, and it is only when a liquid containing 65 per cent. HNO₃ (1.4 sp. gr.) is attained that the mixture distils over unchanged under atmospheric pressure at 120° C. These difficulties are now almost completely overcome with modern apparatus.

Nitric acid is now made on the large scale by three distinct processes:—

- (1) *Manufacture from Chile Saltpetre and Sulphuric Acid.*
- (2) *Manufacture by Electrical Oxidation of the Atmosphere.*
- (3) *Manufacture by Catalytic Oxidation of Ammonia.*

We will consider each process in detail.

(1) **Manufacture of Nitric Acid from Chile Saltpetre.**—Nearly equal weights of Chile saltpetre, NaNO₃, and “oil of vitriol” are heated together in large iron retorts, often capable of holding some 5 tons or more of the mixture. The quantities taken correspond to the equation:—



This reaction is carried to completion at a temperature under 150° C., thereby avoiding much loss by decomposition of the nitric acid. A much higher temperature with half the amount of sulphuric acid is necessary to cause the formation of the neutral sulphate, according to the equation:—



This latter action, however, in the best practice is never used, because the high temperature necessary to complete the action causes a very considerable decomposition of the nitric acid formed; also the neutral sodium sulphate remaining sets to a solid mass, and causes great difficulty as regards removal from the retort; also the action takes a much longer time to complete, and requires more fuel.

By working not much over 150° C. and using more sulphuric acid, as corresponds to the first equation, the "bisulphate" is obtained as an easily fusible mass, which is withdrawn in a fluid condition from the retort merely by opening a plug at the base. However, in actual practice,

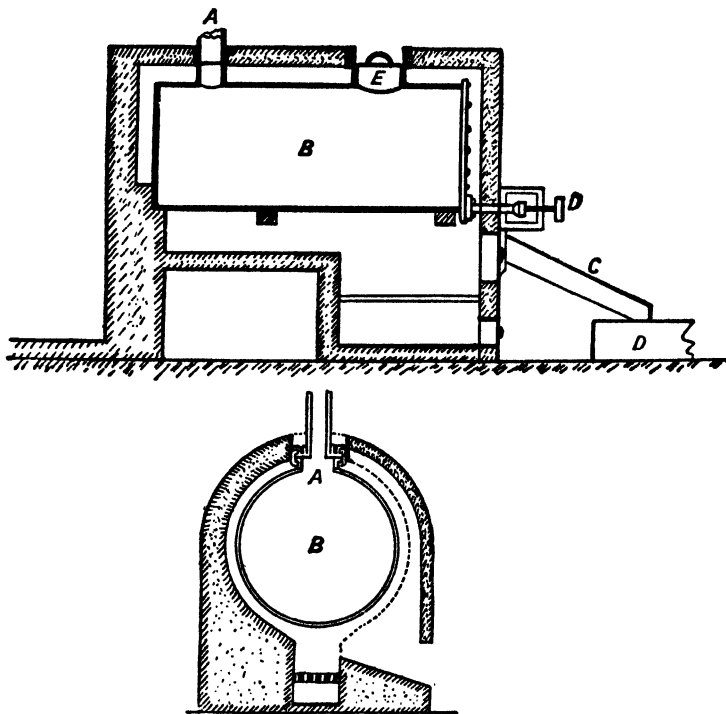
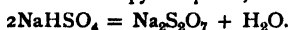


FIG. 1.—Nitric Acid Still.

right towards the end of the action the temperature is raised somewhat, when the bisulphate foams somewhat and is probably converted into pyrosulphate, thus:—



This pyrosulphate (or disulphate) is run off in a fluid condition into iron pans, where it solidifies and is used for the manufacture of normal sodium sulphate by heating with salt, NaCl, in mechanical sulphate furnaces. Part of this "nitre cake," as the product is called, is now converted into sodium sulphide, Na_2S .

The kind of sulphuric acid used varies with the nature of the nitric acid it is desired to produce. For a dilute nitric acid of 1.35-1.4 sp. gr. it is sufficient to use 60° Bé. (141° Tw.) sulphuric acid direct from the Glover tower. The first distillate will be strongest, and the last nearly pure water. Should, however, a stronger HNO_3 of over 1.5 sp. gr. be required (as is now nearly always the case), a more concentrated 66° Bé. (167° Tw.) sulphuric acid must be employed, and the NaNO_3 is often previously melted.

Excess of H_2SO_4 is bad, for although it does not injure the quality of the HNO_3 produced,

yet it diminishes the value of the NaHSO_4 or $\text{Na}_2\text{S}_2\text{O}_7$ (nitre cake) produced as a by-product for the manufacture of sodium sulphate.

We have seen above that when nitric acid boils, a mixture of NO and NO_2 gases is produced, and the NO_2 , condensing, would cause the nitric acid produced to be contaminated with nitrous acid ($2\text{NO}_2 + \text{H}_2\text{O} = \text{HNO}_2 + \text{HNO}_3$). This contamination may be very simply avoided by keeping the condensed distillate hot until it escapes from the cooling worm, or else by blowing air through the hot acid by means of an injector.

The plant used in practice is shown in Fig. 1, which shows the usual cylindrical cast-iron boiler B, the sulphuric acid and nitrate being introduced at E, while the nitric acid distils away through A. Such a cylinder will hold over 5 tons of the mixture, and is heated over a free fire. The cast iron is scarcely attacked by the nitric acid vapour.

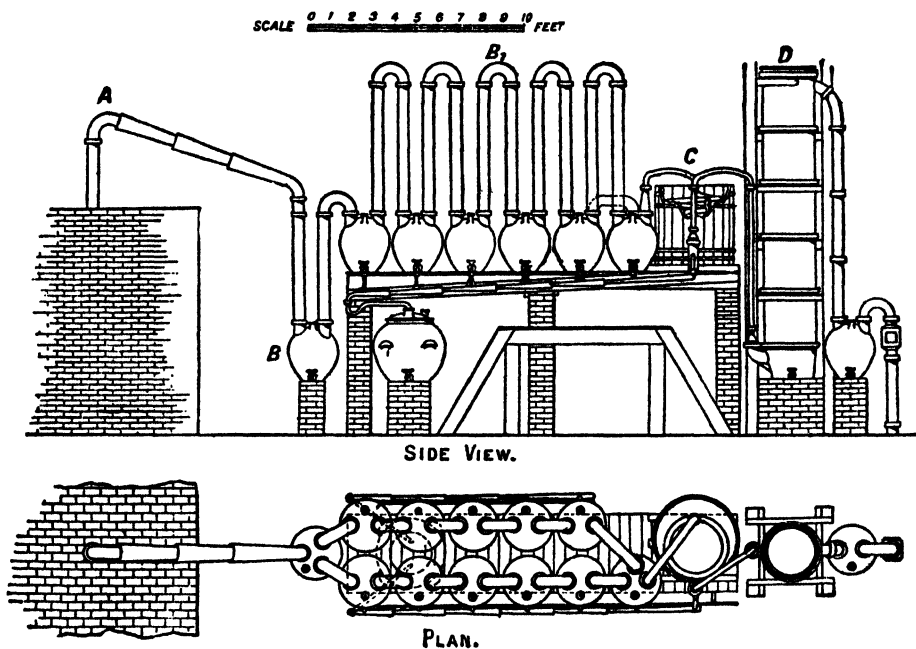


FIG. 2.—Doulton's Nitric Acid Condensing Plant.

The retort is emptied after the distillation by turning the screw stopper D, when the fused bisulphate and pyrosulphate pours away through the trough C into an iron pan E.

For very small installations sometimes an earthenware "pot" retort is used.

Since the specific heat of strong nitric acid is small, the fuel consumption for distillation is low; the condensation of the vapours is readily effected.

The condensing arrangement consists of a series of earthenware or stoneware vessels, pipes, etc., which are luted together by means of an asbestos water-glass lute.

Fig. 2 shows an air-cooled condensing arrangement made by Doulton & Co., of Lambeth, London. A is the still head, the nitric acid from which passes into a preliminary stoneware receiving vessel B, and thence into a series of air-cooled vessels B₁. C is an earthenware condensing worm immersed in a cooling tank of water, while D are condensing towers, usually packed with glass balls or cylinders, or sometimes provided with plate columns, down which trickles water to absorb the last trace of free acid.

Fig. 3 shows a "Griesheim" condensing system, much used in Germany. Here the nitric acid, distilling out of retort A, passes first into B and then into an earthenware condensing coil E, standing in cold water. The vapours then pass through the pipe F, through a series of earthenware receivers, and then into the plate column condensing tower G.

First of all, at the lowest temperature the strongest acid distils over, contaminated, however, by HCl, NO_2Cl , and similar chlorine-containing volatile compounds. Next, there distils over the main quantity of strong acid, fairly pure, but contaminated with red nitrous fumes. To oxidise these a stream of hot air is blown in at *k*.

In some forms of apparatus (*e.g.*, Oscar Guttman's) the oxidation is automatically effected by causing the gases coming from the still to pass into an enlargement in the pipe, where they produce an injector action and suck in a quantity of air through perforations in the socket pipe, thus causing oxidation of the nitrous to nitric acid.

The air not only purifies the condensed nitric acid from nitrous acid, but also frees it from volatile chlorine compounds, such as NO_2Cl . By regulating the temperature of the water in which the cooling coil E (Fig. 3) is immersed, the quality of the acid collecting in B can be also regulated to some extent, and the acid can be withdrawn in successive fractions as it comes over into the receiver C. In the tower G (Fig. 3) all the nitrous fumes finally escaping condensation are absorbed by the down-streaming water, so as to form a dilute nitric acid of 1.35-1.36 sp. gr. The water enters at *h*.

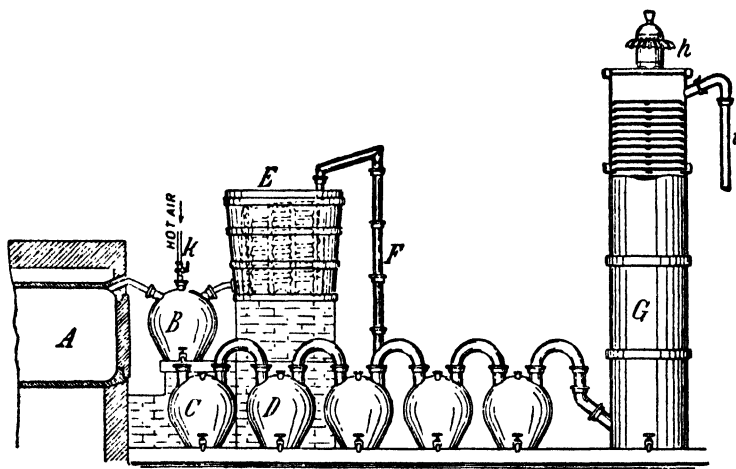


FIG. 3.—The Griesheim Nitric Acid Plant.

Other excellent condensing systems have been devised by Hart, Thomson, and others.

Valentiner's Vacuum Process.—In this process the outlet pipe from the still passes into a small receiver, half filled with pumice stone, so that any acid or solid coming over as spray or foam from the still is retained. The vapours then pass on through two water-cooled stoneware coils arranged in series; the vapour is next passed through two separate series of receivers.

Here, by means of a three-way tap, the condensed acid may, either at the beginning or end of the distillation, be collected in a large receiver while the concentrated 96 per cent. HNO_3 , coming over intermediately, may be collected in the separate receivers. From these receivers the vapours pass into a reflux condenser consisting of an earthenware coil immersed in water.

Next, the vapours pass through eight receivers, alternately empty and half-filled with water. Finally come seven receivers, alternately empty and half-filled with milk of lime, which removes the last traces of the nitrous gases. The last receiver is connected with a vacuum pump.

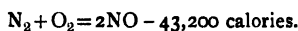
This system offers great advantages since the decomposition of the strong acid is largely avoided under the diminished temperature of distillation resulting from the diminished air pressure over the still. The time of distillation is also greatly reduced, thereby causing a great saving in fuel. The process is gaining ground, since no leakage of injurious fumes and a larger and purer yield of acid is claimed. The first cost, however, is heavy (see United States Patent 920,224). See also British Patents 361,161, 378,894 for other methods.

(2) **Manufacture of Nitric Acid from the Atmosphere.**—The atmosphere contains about 4,041,200,000,000,000 tons of nitrogen, together with about one-fifth this amount of oxygen gas. There is thus an inexhaustible supply of nitrogen available for conversion into nitric acid or nitrate, and thus available for manurial purposes. The nitrogen in the air over a single square mile of land amounts to nearly 20,000,000 tons of nitrogen—sufficient, if suitably combined as nitrate or nitric acid, to supply at the present rate of supply the world with manure for over half a century.

The problem of directly uniting the oxygen and nitrogen of the air to form nitric acid and nitrate was first solved in a commercially successful form in 1903 by Birkeland and Eyde. In 1907 they established a factory at Notodden, in Norway, utilising the 40,000 H.P. there available from waterfalls. In the same year the Badische Anilin- und Soda-Fabrik built an experimental works at Christiansand, in Norway, and an agreement was come to between the interested firms whereby a company possessing a total capital of 34,000,000 kronen came into existence, which in 1911 opened a large works on the Rjukan Falls, near to Notodden, with 125,000 H.P. However, the Badische Anilin- und Soda-Fabrik have since withdrawn all their capital from the concern, selling all their rights in the manufacture of nitric acid from the atmosphere to the French Scandinavian Co. The cause of this is the perfection by the B.A.S.F. of their process for making synthetic ammonia cheaply and thence oxidising it into nitric acid (see p. 448). Other works are building or are built in Norway and Sweden, and similar factories, using different systems as described below, have come into existence at Innsbruck, in Italy, France, the United States and other countries possessing considerable water power for the generation of electrical power. According to *Chem. Met. Eng.*, 1929, 36, 481, the arc processes are now all replaced by the ammonia oxidation processes.

The process adopted for making nitric acid from the air is to oxidise the latter by means of an electric arc, whereby the nitrogen and oxygen directly unite to form nitric oxide, NO. This latter takes up oxygen from the air to form nitrogen peroxide, and the nitrogen peroxide is then absorbed by water, with the production of nitric and nitrous acid.

Theoretical.—When air is strongly heated, atmospheric oxygen and nitrogen directly unite to form nitric oxide, NO, according to the equation—



The process is reversible, and depends upon the equilibrium represented by the expression :—

$$K = \frac{P(\text{O}_2) P(\text{N}_2)}{P^2(\text{NO})}$$

where P represents the partial pressures of the respective gases, and K is the reaction constant.

Also the reaction is endo-thermic (*i.e.*, the formation of NO is attended with the absorption of heat), and consequently is favoured by a high temperature, as is shown by the following results of Nernst (*Zeit. anorg. Chem.*, 1906, 49, 213; *Zeit. Elektrochem.*, 1906, 12, 527) interpolated for simplicity :—

1. Temperature C.	2. Per Cent. Volume NO Observed.	3. Per Cent. Volume NO Calculated.
1,500	0.10	...
1,538	0.37	0.35
1,604	0.42	0.43
1,760	0.64	0.67
1,922	0.97	0.98
2,000	1.20	...
2,307	2.05	2.02
2,402	2.23	2.35
2,500	2.60	...
2,927	5.0 (approx.)	4.39
3,000	5.3	...

The second column represents the volume of NO found in 100 volumes of air, which have been exposed to the temperature indicated in the first column. The third column represents the amount of NO which should have been found as calculated from the law of mass action and the heat of formation.

It will be seen from this that the reversible reaction, $N_2 + O_2 \rightleftharpoons 2NO$, is very incomplete, only a small but definite amount of NO being produced, the quantity, however, increasing as the temperature rises, a very large quantity of NO being found above 3,000° C. Now Nernst and Jellinek showed that the equilibrium, $N_2 + O_2 \rightleftharpoons 2NO$, is almost immediately established (in a fraction of a second) at temperatures over 2,500°, but below this an appreciable time is required to establish equilibrium, hours being required below 1,500°.

This is clear from the following table, compiled from Jellinek's results (*Zeit. anorg. Chem.*, 1906, 49, 229):—

Absolute Temperature.	Time of Formation of Half the Possible Concentration of NO from Air.
1,000°	81.62 years
1,500°	1.26 days
1,900°	2.08 mins.
2,100°	5.06 secs.
2,500°	1.06×10^{-2} secs.
2,900°	3.45×10^{-5} secs.

Consequently, the decomposition of NO into N_2 and O_2 proceeds so slowly that its isolation is possible in appreciable quantities, if the cooling to below 1,500° C. is carried out rapidly enough.

To make this clear to the technical student, we will suppose that (according to Nernst results above tabulated) air is exposed to a temperature of 3,000° C. Then in 100 vols. of this air will be found 5.3 vols. of NO, and this equilibrium will be established in the fraction of a second. Let now this 100 vols. at 3,000° C. of air be suddenly cooled to say 1,500° C. Then, according to the equilibrium conditions tabulated by Nernst in the above table, the 5 per cent. of NO in the 100 vols. of air will gradually decrease, according to the equation, $2NO \rightleftharpoons N_2 + O_2$ until, after waiting until complete equilibrium is attained at 1,500° C., only 0.1 per cent. vol. of NO is left, as corresponds to equilibrium at this temperature of 1,500° C. However, to reach this equilibrium at the lower temperature requires some time, and if the cooling takes place in a fraction of a second, practically all the 5.3 per cent. of NO in the air at 3,000° will be found in the air at 1,500° (as the NO will not have had time to decompose), and if the air be kept for many hours at 1,500° the percentage of NO will gradually decrease from 5 per cent. in the sample of air until it reaches that which corresponds to true equilibrium at 1,500° C., viz., 0.1 per cent. NO. But now suppose we do not stop the cooling process at 1,500°, but cool it in a fraction of a second from 3,000° C. down to 1,000° C., then practically we will have 5 per cent. NO in our sample of air at 1,000° C., and although the equilibrium at this temperature requires that practically all the NO would decompose into O and N, thus:— $2NO \longrightarrow N_2 + O_2$, yet we would have to wait years for this action to proceed to completion, and so we could keep our specimen of air containing 5 per cent. NO for many hours at 1,000° C. without much loss.

Hence we may formulate the conditions of practical success for the isolation of NO as follows:—

NO is endothermic, and like other endothermic substances its stability increases as the temperature rises, and it is capable of existing in very large quantities at very high temperatures, such as 3,000°-5,000° C. It is also capable of existing stably below 1,000° C., but is unstable at intermediate temperatures. Hence in order to isolate reasonable quantities of NO we must (1) cause the formation of NO to take place at very high temperatures, such as 3,000°-10,000° C., when large amounts are formed; (2) then extremely rapidly cool the NO formed through the intermediate unstable range of temperature, 2,500°, to a stable low temperature, e.g., 1,000° C. If the cooling is effected quickly enough, although some of the NO is decomposed as it cools through the unstable lower temperature, yet sufficient survives so as to make an appreciable amount still existing at 1,000° C., which then ceases to decompose further, and so is available for conversion into nitric acid. Now in practice the intense heating of the air to very high temperatures such as 3,000°-5,000° C., necessary to cause a reasonable oxidation of the air to NO, is always produced by a high-tension alternating current of some 5,000 volts.

This electric current not only produces the union of the O and N as a purely thermal effect, but also ionises the air and causes a direct union by means of electrical energy, much as ozone is formed from oxygen by means of a silent electrical discharge. So that much larger quantities of NO are obtainable than strictly corresponds to the thermal conditions, e.g., Haber and Koenig (*Zeit. Elektrochem.*, 1907, 13, 725; 1908, p. 689), by means of a (relatively) cold electrical arc of

only 3,000° C., were able to isolate no less than 14.5 vols. of NO by mixing equal volumes of nitrogen and oxygen gases together. The union takes place in the proportions $N_2:O_2$, and therefore the mixture of gases in the atmosphere, e.g., 21 per cent. O to 78 per cent. N, is not the most favourable mixture for the formation of NO. Technically, however, the addition of O to the atmosphere to improve the yield of NO is inapplicable at present on account of cost.

For technical success it has been found essential to use a high-tension alternating arc. By employing a low-tension electrical arc (e.g., such as is used for manufacture of calcium carbide or for ordinary arc lamps) or by employing electrical sparks from a Rühmkorff coil, only very small amounts of NO were obtainable.

Another essential condition for technical success is the sudden and rapid cooling of the enormously hot gas in the arc (e.g., 3,000°-10,000° C.) to a temperature below 1,500° C.

We will describe only the following three electrical furnaces, all of which have been used on a large scale with technical success for combining atmospheric oxygen and nitrogen.

- (1) *The Birkeland-Eyde Furnace.*
- (2) *The Pauling Furnace.*
- (3) *The Schönherr Furnace.*

(1) **The Birkeland-Eyde Furnace.**—Fig. 4 is a diagrammatic sketch of this furnace. The electrodes consist of two copper pipes A and B, kept cool by a current of water, and separated by 8-10 mm. They are connected with a high-tension powerful alternating current of 5,000 volts, which forms an arc between them. The arc is placed between the poles of a powerful electromagnet, which then blows it out into a wheel-like disc of flame, 2 m. in diameter, composed of burning oxygen and nitrogen. The whole is enclosed in a refractory casing, shown in section in Fig. 5 and a general view in Fig. 6. The section, Fig. 5, shows how air is blown in to feed the flame. The air enters at A,A and passes in through holes in the refractory lining. The electric flame plays down the disc-like space CC, and the burnt gases come out at D and then pass away to the absorption plant, as indicated in Fig. 5. E,E are the wires of the electromagnets.

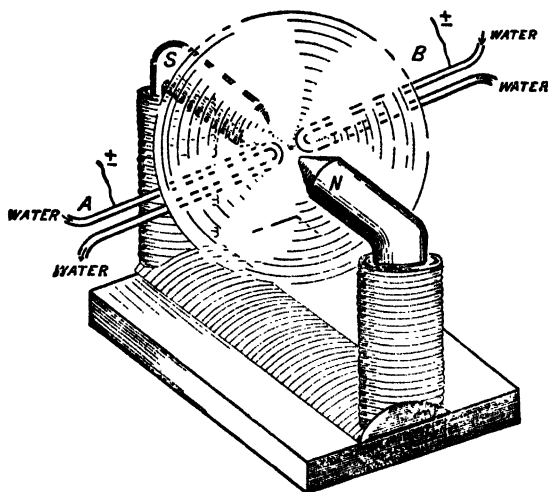


FIG. 4.—Diagrammatic View of the Birkeland-Eyde Electric Furnace.

The electric flame plays down the disc-like space CC, and the burnt gases come out at D and then pass away to the absorption plant, as indicated in Fig. 5. E,E are the wires of the electromagnets.

For further particulars the reader should see Crossley, *loc. cit.*; also the *Zeit. Elektrochem.*, 1905, II, 252; Birkeland, *Trans. Faraday Soc.*, 1906, 2, 98; Eyde, *Journ. Roy. Soc. Arts*, 1909, 57, 565; Scott, *Journ. Soc. Chem. Ind.*, 1915, 34, 114.

In spite of the enormously high temperature of the disc flame (over 3,500° C.), the temperature of the walls does not rise above 800° C. owing to the cooling effect of the current of air. The temperature of the gases escaping from the furnace is 800°-1,000° C. They contain 1.5-2 per cent. NO. In 1907 no less than thirty-six furnaces were employed at Notodden in Norway, each taking up 800 kw., and 26,000-28,000 l. of air per minute pass through each furnace. The 40,000 H.P. employed is derived from water power. Still larger furnaces taking 3,000 kw. are now in use. The copper electrodes last 400-500 hours before they must be repaired.

According to Haber and Koenig (*Zeit. Elektrochem.*, 1910, 16, 11) the Birkeland-Eyde furnaces yield 70 g. of HNO_3 per kilowatt-hour, and the concentration of the NO produced is 2.0 per cent. It may be taken as approximately correct that 1 H.P. per year can produce about $\frac{1}{4}$ -1 ton of calcium nitrate.

(2) **The Pauling Furnace.**—This is shown in Fig. 7. The main electrodes

A and B are bent into the shape of a V, A,HH being a section of one main electrode, and B,KK a section of the other. The base of the electrodes thus forms

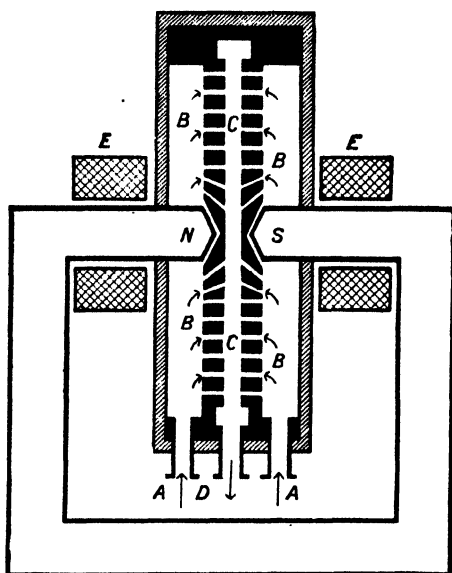


FIG. 5.—Section through the Birkeland-Eyde Furnace.

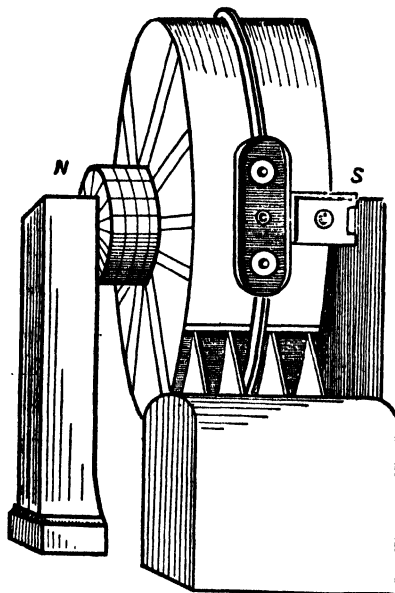


FIG. 6.—External View of the Birkeland-Eyde Furnace.

at MN a vertical slot, through which are introduced thin "lighting knives F,F." These "knives" can be brought very close together, 2-3 mm., by the screwing

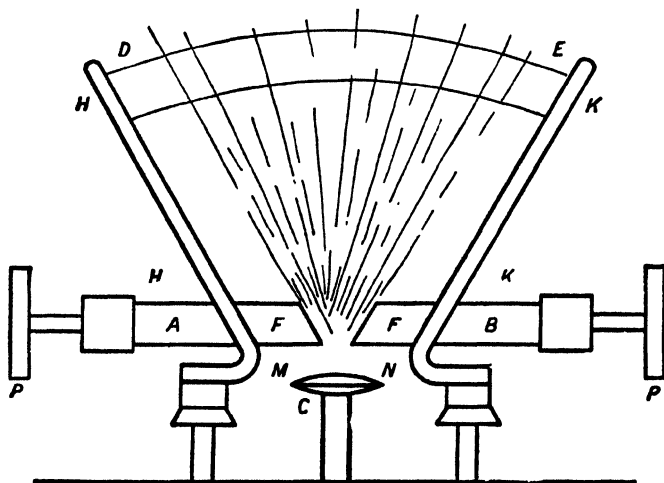


FIG. 7.—The Pauling Furnace.

arrangement P,P, and the arc, thus lighted at the narrowest portion of the spark gap, shows a tendency to rise up between HH and KK, owing mainly to the upward pull of the hot gases, but is interrupted at every half period of the alternating current, only to be reformed at the lowest and narrowest part of the electrodes.

At Christiansand, in Norway, the Badische Anilin- und Soda-Fabrik erected in 1907 a factory employing these furnaces, each being supplied with 600 H.P. at 4,200 volts. Others are projected using 750 H.P. and requiring 40,000 cub. ft. of air per hour, producing arcs 7 yds. long.

The gases leave the furnace at a temperature of 850°C ., and contain 2-2.5 per cent. NO. According to Haber and Koenig, *Zeit. Elektrochem.*, 1910, 16, 11, the yield in grams HNO_3 per kilowatt-hour is 75 g. and the NO produced amounts to 2.5 per cent.

For further particulars of this process see Schönherr, *Trans. Amer. Elektrochem. Soc.*, 1909, 16, 131.

E. K. Scott (*Journ. Soc. Chem. Ind.*, 1915, 34, 113) describes a new type of furnace.

General Plan of Plant for the Manufacture of Nitrates by Electrical Oxidation of the Air

How the manufacture of nitric acid and nitrates from the air is carried out technically by means of the electrical furnaces above described will be seen from the diagrammatic sketch, Fig. 9. A is an air compressor which drives the air into the electrical furnace B (which may be any of the kinds described above). In this chamber B, the air is passed into a very hot electrical arc flame, where it is heated to a very high temperature, say $5,000^{\circ}$ - $10,000^{\circ}\text{C}$., in the immediate path of the arc. Here union takes place, NO being formed. The hot gases passing away from the arc experience a sudden fall of temperature (although the fall is so slow

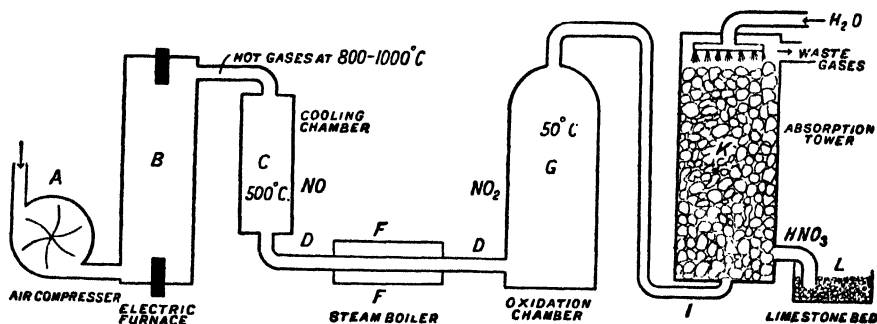
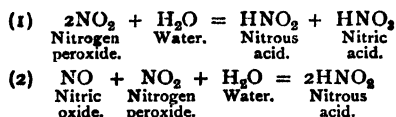


FIG. 9.—Plan of Plant for the Manufacture of Nitrates by the Electrical Oxidation of the Air.

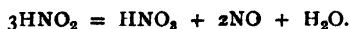
that in practice most of the NO formed is decomposed again), and the gases escape from the furnace at a temperature of 800° - $1,000^{\circ}\text{C}$. containing only 1.5-2 per cent. by volume of NO, the rest being unchanged oxygen and nitrogen (e.g., 30 mg. HNO_3 per litre). The hot gases at 800° - $1,000^{\circ}\text{C}$. stream into a cooling chamber C, where the temperature falls to about 500°C ., and then are passed, still very hot, through a series of tubes contained in a number of tubular boilers. Here they give up their heat to the water in the boilers, the latter developing a pressure of 130 lbs. on the square inch, and thus sufficient steam is generated to work all the necessary machinery in the works, the use of coal being thus entirely done away with. The gases leave the boilers at a temperature of only 200° - 250°C ., and by passing through another cooling arrangement their temperature is further lowered to about 50°C ., when they finally enter a large oxidation chamber G, consisting of a series of vertical iron cylinders with acid-proof lining. Now the nitric oxide only begins to unite ($2\text{NO} + 2\text{O}_2 = 2\text{NO}_2$) with the oxygen of the excess air at a temperature below 500°C ., and so the formation of nitrogen peroxide, NO_2 , already begins in the gases, and this oxidation is nearly completed in the large oxidation chamber G, the gases finally leaving G consisting of 98 per cent. of air, and 2 per cent. of a mixture of 75 per cent. NO_2 and 25 per cent. NO.

Next the gases pass from the oxidation chambers into a series of absorption towers K (one tower only being shown), where they meet a stream of descending

water, and the nitrous peroxide is absorbed with the formation of nitric and nitrous acids thus:—



According to these equations much nitrous acid is formed. However, in practice, *with increasing concentration, the nitrous acid becomes unstable* and decomposes into nitric acid and nitric oxide, thus:—



Under certain conditions of temperature, and by diminishing the amount of water, the instability of nitrous acid is so marked that practically only nitric acid is finally left in solution.

The absorption of the nitrous fumes takes place in such a way that the first absorption tower contains the strongest acid and the last the weakest acid, the practical result being that the first tower not only contains the strongest nitric acid, but also an acid practically free from nitrous acid. The NO passes on from absorption tower to absorption tower, and is oxidised to NO₂ and absorbed according to the equations given above. Hence the amount of nitrous acid, HNO₂, increases in each succeeding tower, until in the fifth tower (which is fed with a solution of sodium carbonate) only pure sodium nitrite is formed.

The absorption towers consist of three series of stone towers, 20 m. high and 6 m. internal diameter. Each series contains five towers, viz., three acid and two alkali towers. The acid towers are built of granite slabs bound together by iron rods, having a capacity of 600 cub. m. They are filled with broken quartz, over which water (or the dilute nitric acid formed) is slowly flowing. The alkali towers are built of wood bound together by wooden rods, and having a capacity of 700 cub. m.; they also are filled with broken quartz, down which flows a solution of sodium carbonate. The passage of the gases from tower to tower is aided by aluminium fans.

The water is allowed to flow down the third absorption tower (being once more pumped to the top when it reaches the bottom) until it attains a strength of 5 per cent. HNO₃ by volume. This liquid is then pumped to the top of the second tower, where it is allowed to circulate until it attains the strength of 20 per cent. HNO₃ by volume. Next the acid is pumped to the top of the first tower, where, meeting the fresh gases from the oxidation chambers, it attains the strength of 40-60 per cent. HNO₃ by volume, and thus, nitrous acid being under these conditions unstable, the first tower is made to contain not only the strongest nitric acid, but also an acid free from nitrous acid (see above).

The tower coming after the third tower is the alkali tower, being fed with sodium carbonate solution, and in this fourth tower a mixture of sodium nitrate and nitrite is produced (sodium nitrate). The fourth tower, likewise fed with sodium carbonate solution, produces practically pure sodium nitrite, as above explained.

The total absorption in these towers is over 98 per cent.

The main product of manufacture is the 40 per cent. by volume nitric acid obtained from the first tower. 1 kilowatt-year gives 550-650 kilos of HNO₃ (calculated as 100 per cent.).

Five finished products are made in the works:—

(1) 40 per cent. HNO₃, from the first tower.

(2) Calcium Nitrate, CaNO₃, made by running the crude nitric acid through a series of granite beds filled with limestone (CaCO₃) until the liquid contains under 0.5 per cent. free HNO₃. The liquor is neutralised with lime, evaporated in vacuum pans until of 1.9 sp. gr., and allowed to solidify. It is then either exported in drums, or ground up and put into casks, being sold as "Norwegian saltpetre." It is reddish brown to black. It is further described on p. 435. See *Chem. Age*, 1930, 23, 612, 613.

(3) Sodium Nitrite, NaNO₂.—The liquid from the fifth absorption tower is evaporated, run into shallow tanks, allowed to crystallise, centrifuged, and the crystals dried in a current of hot air. The product contains 99 per cent. NaNO₂, being sold as a fine white powder (see p. 436 for properties).

Nitrites are also made from the *furnace gases* by passing the latter, still at a

temperature of 200°-300° C., directly up an absorption tower fed with sodium carbonate solution. Under these conditions only nitrite is produced according to the equation:—



In the experimental factory at Christiansand all the nitrite produced is made by this process.

(4) **Sodium Nitrite Nitrate**.—A yellow crystalline material produced by the first alkali tower. It contains 50 per cent. NaNO_2 , 43 per cent. NaNO_3 , and 7 per cent. H_2O , together with a little unchanged sodium carbonate. The substance is used instead of Chile saltpetre for the manufacture of sulphuric acid by the chamber process.

(5) **Ammonium Nitrate**, NH_4NO_3 .—Produced by neutralising the 40 per cent. HNO_3 directly with ammonia liquor of 0.880 sp. gr. The liquid is evaporated to 1.35 sp. gr., is allowed to crystallise, centrifuged, dried in hot air, when it contains 99.9 per cent. NH_4NO_3 .

Manufacture of Nitric Acid from Synthetic Ammonia

(The Ostwald Process)

Recently ammonia, NH_3 , has been manufactured extremely cheaply by several methods, e.g., directly from its elements, also by passing steam over nitrolime. It has, consequently, greatly fallen in price, and has thus become available as the starting-point for the manufacture of nitric acid.

Kühlmann in 1830 oxidised ammonia, using platinum as a catalyst, but ammonia was in those days too expensive for practically producing nitric acid by this process. About 1900 Prof. Wilhelm Ostwald, together with his assistant Dr Brauer (see *Chem. Zeitung.*, 1903, 457, also English Patents, 698, 1902; 8,300, 1902; 7,909, 1908; American Patent, 858,904, 1907; Ostwald, *Berg. u. Hüttenm. Rundschau*, 1906, 3, 71; Schmidt u. Böcker, *Ber.*, 1906, p. 1366), reinvestigated the process and an experimental plant was erected in which some 150 tons of dilute nitric acid were produced per month. Even at that time, however, ammonia seems to have been too expensive for the process to compete with the sodium nitrate process of manufacture.

Recently, however, ammonia has been produced at one-fourth its former price (by the synthetic process), and so the difficulty as regards the first cost of ammonia appears to have vanished.

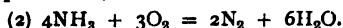
Also, the process in its original form was imperfect. The technical details were gradually improved, and in 1909 a factory was built at Gerte, Westphalia. Numerous other factories are now being erected. Works exist in Belgium, near Dagenham on the Thames, Trafford Park, Manchester, in Scotland and Ireland. Rudolph Messel (*Journ. Soc. Chem. Ind.*, 1912, 31, 854) has pointed out that the production of nitric acid from the air (see above) is at present confined to countries producing water power, and that the resulting nitric acid is very difficult to transport; on the other hand, ammonia is producible almost everywhere (since not much energy is required in its production) and can, with an Ostwald plant, be readily oxidised on the spot to nitric acid. Consequently this new process, especially since the production of synthetic ammonia, has now replaced the **arc processes** for manufacturing nitric acid.

For further details see Donath and Indra, "Die Oxydation des Ammoniak zu Salpetersäure und Salpetriger Säure" (Stuttgart, 1913); see also under **Ammonium Nitrate**, p. 435; also see Taylor, Chilton and Handforth, *Ind. Eng. Chem.*, 1931, 23, 860; Kaltenbach, *Chem. and Ind.*, 1929, 21, 701.

Under the influence of a catalyst, ammonia, NH_3 , can be oxidised by air to form water and nitric acid or oxides of nitrogen; thus:—



However, unless certain conditions are maintained, the oxidation may be incomplete and only nitrogen gas be produced, thus:—



This formation of nitrogen was one of the chief difficulties to be overcome.

Now, in order to obtain a technically useful result, the operation must be so conducted that the first reaction (1) is practically complete, whilst (2) must be as small as possible. This result is attained by using, for example, smooth or solid platinum, which causes the first action, viz., the production of nitric acid, to take place almost quantitatively, the production of free nitrogen being unnoticeably small. However, the action is slow with the use of smooth platinum alone. On the other hand, finely divided platinum, or platinum black, accelerates both re-

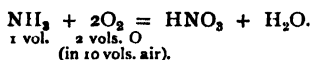
actions, but accelerates the second one (*i.e.*, the production of free nitrogen) more than the first. However, by moderate use of the finely divided platinum (platinum black) with the smooth platinum the operation can be so performed that the action takes place rapidly, but without any great formation of free nitrogen.

W. Ostwald, therefore, in his English Patent, 698, 1902, advised that the platinum should be partly covered with platinum black, and that the gas current should pass at the rate of 1.5 m. per second through a length of 1 cm. or 2 cm. of contact substance maintained at about 300° C.

It is unnecessary to heat the platinum, since heat is liberated in the course of the reaction, which raises the temperature of the platinum to a sufficient extent.

The actual contact between the gas and the platinum should not last longer than one hundredth second, and so a rapid stream of gas is essential in order to fulfil this condition.

The ammonia is mixed with about 10 vols. of air in order to conform to the equation:—



The catalysts are arranged in a kind of semi-parallel system, so as to allow the cutting out of any section. The nitric acid vapours are condensed in towers in which they meet nitric acid; the addition of water is unnecessary, since it is formed during the oxidation of the ammonia.

The plant in operation at the Lothringen Colliery Co., near Bochum, was in 1912 producing 1,800 tons of nitric acid and 1,200 tons of ammonium nitrate annually. At these works the carefully purified ammonia mixed with 10 vols. of air is sent through enamelled iron pipes into a chamber containing the special platinum catalyst. The nitric acid vapours here produced pass through aluminium tubes to an absorption plant, consisting of six towers packed with broken earthenware, down which a stream of nitric acid trickles, being continually pumped again to the top of the tower as soon as it reaches the bottom. Here acid forms which produces directly a nitric acid containing 55 per cent. HNO₃. By altering the condensing arrangements a nitric acid of 66 per cent., or even 92 per cent., can be produced as a sole product, and of a purity sufficient for its direct utilisation for the manufacture of explosives. About 85-90 per cent. of the ammonia is thus transformed into nitric acid.

In the works above mentioned the nitric acid is neutralised by ammonia, and thus ammonium nitrate is produced in bulk.

Other catalysts besides platinum will oxidise ammonia. Thus Frank and Caro (German Patent, 224,329) showed that the expensive platinum can be replaced by a mixture of ceria and thoria, which at 150°-200° C. gives a yield of 90 per cent. HNO₃ or HNO₂. The mixture is not so efficient as platinum, but is far cheaper.

Fr. Bayer & Co. (German Patent, 168,272) showed that at 600°-750° burnt pyrites (iron oxide containing some copper oxide) oxidises ammonia, N₂O₃ being the sole product of the oxidation. By absorbing in alkali, this gave nitrite; see also under **Ammonium Nitrate**, p. 435.

G. Fauser oxidises ammonia under pressure (*Chem. Met. Eng.*, 1932, 39, 430; 1930, 37, 591; also *Chem. Age*, 1930, 23, 612, 613; see also Cederberg, United States Patents 1,859,863, 1,872,638, 1,840,063; British Patents 360,778, 367,709, 363,436, 309,583, 313,513, 331,728).

However, much cheaper sources of ammonia gas are calcium cyanamide (which yields NH₃ and CaCO₃ when treated with superheated steam, Ca = N - CN + 3H₂O = CaCO₃ + 2NH₃) and synthetic ammonia produced by the Badische Anilin- und Soda-Fabrik by direct union of N and H (see p. 469).

The Nitrates Products Co. Ltd. have secured the world's rights of this process outside Westphalia and Rhineland. They intend to produce their ammonia from the action of steam on nitrolime (calcium cyanamide).

The Badische Anilin- und Soda-Fabrik will probably produce nitric acid, using their synthetic ammonia (see below).

Properties of Nitric Acid.—The strong nitric acid, possessing a specific gravity of 1.50-1.52, is a powerful oxidising agent. In fact, it will spontaneously

in flame wood or straw if poured upon them in quantity, and, consequently, is always technically transported in glass balloons, with a packing of sand or kieselguhr. It is usually only sent by special trains, much in the same way that explosives are sent.

Owing to the difficulty of transport, concentrated HNO_3 is usually made on the place of consumption, *e.g.*, it is far more economical to manufacture nitric acid directly in the neighbourhood where it is to be consumed than to manufacture it in distant countries, where the conditions are more favourable, and then send it long distances by sea or rail to the point of use—as is nearly always done in the case of other heavy chemicals, such as sodium sulphate or alkali.

Concentrated nitric acid is used, mixed with concentrated sulphuric acid, for nitrating purposes, especially for the manufacture of nitroglycerine and nitrocellulose collodion and celluloid.

For example, for the manufacture of nitroglycerine a mixture of 36.5 per cent. HNO_3 (of 91.6 per cent. strength) and 63.5 per cent. H_2SO_4 (of 97 per cent. strength), together with 5 per cent. H_2O , is used. Such an acid must be free from chlorine, and must not contain more than 0.2-0.3 per cent. of nitrous acid.

For making such substances as nitrobenzene, picric acid, and other organic nitrogenous bodies, a weaker acid of 1.35-1.40 sp. gr. mixed with 1-2 parts of sulphuric acid (66° Bé., 67° Tw.) is used.

A nitric acid of 1.35-1.40 sp. gr. is also used for the Glover towers in the manufacture of sulphuric acid.

A more dilute nitric acid is used for making silver nitrate and other nitrates, for etching copper plates, and for dissolving metals.

The *red fuming nitric acid*, of specific gravity 1.4-1.5, contains dissolved in it oxides of nitrogen, and is a more powerful oxidising medium than the colourless acid of the same specific gravity.

This acid is made sometimes by adding a little starch to strong nitric acid, which causes its partial reduction, and sometimes by distilling sodium nitrate with a smaller amount of sulphuric acid, and at a higher temperature than is required for the production of the ordinary acid.

The following table, after Lunge and Rey (*Zeit. angew. Chem.*, 1891, 167; 1892, 10), gives the strengths of solutions of nitric acid :—

Specific Gravity.	Baumé°.	100 g. contain g. HNO_3 .	100 c.c. contain g. HNO_3 .
1.000	0	0.10	0.10
1.025	3.4	4.60	0.47
1.050	6.7	8.99	9.7
1.075	10.0	13.15	14.1
1.100	13.0	17.11	18.8
1.125	16.0	21.00	23.6
1.150	18.8	24.84	28.6
1.175	21.4	28.63	33.6
1.200	24.0	32.36	38.8
1.225	26.4	36.03	44.1
1.250	28.8	39.82	49.8
1.275	31.1	43.64	55.6
1.300	33.3	47.49	61.7
1.325	35.5	51.53	68.3
1.350	37.4	55.79	75.3
1.375	39.4	60.30	82.9
1.400	41.2	65.30	91.4
1.425	43.1	70.98	101.1
1.450	44.8	77.28	112.1
1.475	46.4	84.45	124.6
1.500	48.1	94.09	141.1
1.510	48.7	97.10	148.1
1.520	49.4	99.67	151.5

Statistics.—According to the “Report on First Census of Production,” 1907, p. 571, the United Kingdom in 1907 produced 60,000 tons of nitric acid, valued at £91,000. The exports are shown by the following figures:—

1908.		1909.		1910.	
Tons. 257	Value. £5,468	Tons. 269	Value. £7,093	Tons. 185	Value. £4,972

Germany produces annually about 100,000 tons of HNO_3 , calculated as 100 per cent. Obviously, the corrosive nature of nitric acid causes the acid to be sold principally in the form of salts.

SECTION XLVIII

THE AMMONIA AND AMMONIUM SALTS INDUSTRY

BY GEOFFREY MARTIN, D.Sc., Ph.D.

For Synthetic Ammonia see p. 469

LITERATURE

- P. PARRISH.—*Chemical Age*, 1930, **22**, 170, 608.
 LUNGE.—“Coal Tar and Ammonia.”
 R. ARNOLD.—“Ammonia and Ammonium Compounds.”
 G. T. CALVERT.—“The Manufacture of Sulphate of Ammonia.” 1911.
 CARO.—“Die Stickstofffrage in Deutschland.” Berlin, 1908. *Chem. Zeit.*, 1911, 505.
 FRANK and CARO.—*Zeit. angew. Chem.*, 1906, 1569.
 WOLTERECK.—English Patents, 16,504, 1904; 28,963, 1906; 28,964, 1906.
 BEILBY.—*Journ. Soc. Chem. Ind.*, 1884, 216.
 NORTON.—“Consular Report on the Utilisation of Atmospheric Nitrogen.” Washington, 1912.
 DONATH and INDRA.—“Die Oxydation des Ammoniaks zu Salpetersäure und Salpetrige Säure.” 1913.
 H. TERN.—*Chem. Zeit.*, 1929, **53**, 833.
 H. PINCASS.—*Chem. and Ind.*, 1933, 74.
 See also *Chem. Age*, 1930, **22**, 476; *Gas Journal*, 1930, **192**, 743; *Gas World*, 1930, **93**, 637.
 Also references and patents given in text; see also “Synthetic Ammonia.”

Ammonia and Ammonium Salts.—Ammonia, NH_3 , is a decomposition product of organic matter, resulting either from its destructive distillation or from its putrefaction and decay.

Until quite recently, practically the total supply of ammonia was obtained as a by-product in the destructive distillation of coal for the purpose of making illuminating gas, much also being produced by coke ovens, and the processes now worked for the gasification of coal, peat, oil-shale, etc.

The amount of nitrogen in coal amounts to 1.2 per cent., and only a relatively small proportion of this (from 12.20 per cent. of the total nitrogen present) is converted into ammonia during the process of destructive distillation or gasification. At least half of the nitrogen remains in the residual coke, and is not expelled completely even at a white heat. Much nitrogen escapes from the coal in the form of N_2 gas, being formed by the decomposition of the NH_3 , which begins to decompose at 600°-800° C. A small proportion of the nitrogen distils over in the form of cyanide, pyridine, and other organic nitrogenous substances. The following figures show how the nitrogen contained in various sorts of coal is disposed of during the ordinary process of destructive distillation of 100 parts of their total N. We have:—

Kind of Coal.	English.	Westphalian.	Saar.
	Per Cent.	Per Cent.	Per Cent.
N in coke	48.65	30.36	64
N as NH_3	11.17	11.15	16
N as gaseous N_2	21.35	47.55	16
N as cyanide	0.2-1.5	1.2	} 4.0
N in tar	1.2	1.1.5	

In general, 100 kilos of average coal on destructive distillation yield 0.25-0.3 kg. of ammonia or 1.0-1.2 kg. of ammonium sulphate. When, however, the coal undergoes destructive distillation in a stream of superheated steam (as in the processes of producing “water-gas” or “Mond-gas” from crude coal) we can obtain as much as 3 kilos of ammonium sulphate per 100 kilos of coal treated.

The following may be considered as the chief sources of ammonia and ammonium salts, as they at present exist:—

(1) **The Coking of Coal.**

(a) **For the Production of Metallurgical Coke.**—Already in Germany no less than 90 per cent. of total output of ammonium sulphate is manufactured in recovery ovens; in England some 60 per cent., and in the United States only 20 per cent. is thus obtained. About 55 per cent. of the world's total output of ammonia in 1911, and 74 per cent. of that of the U.S.A., is derived from the carbonisation of coal in by-product ovens. There is little doubt that the output will increase as the amount of coal carbonised increases.

(b) **For the Production of Coal-Gas.**—30 per cent. of the world's output in 1910 was obtained from the retorting of coal for the manufacture of illuminating gas.

(2) **The Distillation of Shale.**—Large amounts are recovered in Scotland by the distillation of bituminous shale. The following figures, taken from the "49th Annual Report on Alkali, etc., Works," p. 130, show this:—

Year.	Total Shale Mined and Quarried in Scotland.	Total Sulphate of Ammonia Recovered from the Shale in Paraffin Oil Works.	Yield in Lbs. per Ton of Shale.
	Tons.	Tons.	
1903	2,009,265	37,353	41.6
1904	2,331,885	42,486	40.8
1905	2,493,081	46,344	41.6
1906	2,545,724	48,534	42.7
1907	2,690,028	51,338	42.7
1908	2,892,039	53,628	41.5
1909	2,967,017	57,048	43.1
1910	3,130,280	59,113	42.3
1911	3,116,803	60,765	43.7
1912	3,184,826	62,207	43.7

Considerable undeveloped deposits of bituminous shale exist in Newfoundland, Australia, and other parts of the world.

(3) **The Distillation or other Treatment of Peat.**—Much nitrogen is combined in peat (which, therefore, has found some application as a fertiliser), and many processes are either worked or are projected for directly transforming this nitrogen into the form of ammonium sulphate. The destructive distillation of peat has been proposed by Ziegler and others.

More promising is the partial combustion of peat with production of producer-gas (Frank, Caro, Mond, described under "Producer Gas") or the slow wet-combustion of peat (Wolterreck). There are 20,000 million tons of undeveloped peat in the U.S.A., while equally enormous quantities exist in Ireland, Canada, Newfoundland, Sweden, Norway, Russia, Germany (Prussia alone containing 5,000,000 acres).

The average nitrogen content of these peat deposits may be taken as 2.05 per cent. (sometimes reaching 4 per cent. in the case of dry peat), so that if only 50 per cent. of this was recovered, very large amounts of ammonium sulphate would become available.

(4) **Producer-Gas.**—The ammonia contained in the coals used in producing this gas—the main type of plant used being the Mond Gas-Producer—is now very large and is likely to increase. The process is described in this Volume under "Producer Gas."

(5) **Blast-Furnace Gas.**—The nitrogen in the coal used in blast furnaces escapes in part as ammonia, much, however, being decomposed by the high temperatures in the furnace.

Some of the combined nitrogen, however, comes from the nitrogen of the air by actions taking place inside the furnace, principally the formation of cyanides, which are then decomposed into ammonia by aqueous vapour in the furnace. In the United Kingdom, for 1910, about 20,130 tons of ammonium sulphate were recovered, 20,130 tons being recovered in 1911, and 17,026 in 1912.

(6) **Production from Beetroot Sugar Waste, "Schlempe" or "Vinasse."**—The thick brown liquid remaining after the extraction of all the possible sugar from the syrup is known as "vinasses" or "schlempe."

It contains much nitrogen and potassium salts. Until recently it was the custom merely to calcine this material so as to obtain the potash salts in the form of "schlempe kohle." Bueb of Dessau and Vennator now recover nitrogen from this by distilling the schlempe from iron retorts, leading the evolved vapours through chambers filled with brick cheque-work maintained at a red heat, whereby the complex vapours decompose into HCN, NH₃, etc.

The ammonia and cyanogen are then recovered as in the purification of coal-gas. The process is described on p. 488, "Cyanide and Prussiate Industry."

(7) **By Distillation of Bones, Leather, and other Nitrogenous Organic Matter.**—The distillation of bones, for the production of "bone black," formerly yielded a considerable supply of ammonia, but the industry is now not so prominent as formerly.

The ammonia may be extracted from the evolved gases by scrubbing, as in coal-gas manufacture. The treatment of animal refuse for the manufacture of prussiate is now obsolete. It is more profitably employed as manure. See p. 491, "Cyanide and Prussiate Industry."

(8) **From Sewage and Urine.**—A very rich source of ammonia is ordinary urine. 100,000 heads of population could produce per year about 6,000 tons of NH₃. If all the ammonia corresponding to London urine were collected, more than 60,000 tons of ammonium sulphate could be annually produced therefrom.

The method of collection of urine and its working up into ammoniacal compounds has been carried on at Paris and at Nancy. In 1909 France obtained 13,000 tons of ammonium sulphate therefrom, 10,000 being obtained in Paris alone. However, the collection and utilisation of animal excrement is so nauseous and costly and dangerous a process, that the bulk of the enormous ammonium supplies producible from this source are run to waste.

The process consists in allowing the urine to ferment into ammonium carbonate. The clear liquor is distilled and the ammonia recovered as in gas liquor.

For further details see Ketjen, *Zeit. angew. Chem.*, 1891, 294; Butterfield and Watson, English Patent, 19,502, 1905; Taylor and Walker, U.S. Patent, 603,668; Young, English Patent, 3,562, 1882; Duncan, German Patents, 27,148, 28,436.

(9) **Synthetic Ammonia.**—Enormous supplies of ammonia are now becoming available by the synthesis of ammonia, either directly from atmospheric N and H, or else from cyanamide or nitrides. These processes are discussed in detail in a separate article, p. 469.

The production of ammonium sulphate is increasing rapidly in order to meet the increasing demand for nitrogenous manures. The following figures refer to Great Britain:—

AMOUNT OF AMMONIA RECOVERED IN THE UNITED KINGDOM
(EXPRESSED IN TERMS OF SULPHATE)—TONS

	1910.	1911.	1912.	1913.	1914.
Gas works - - - - -	167,820	168,783	172,094	182,000	177,000
Iron works - - - - -	20,139	20,121	17,026	20,000	19,000
Shale works - - - - -	59,113	60,765	62,207	63,000	62,000
Coke-oven works - - - - -	92,665	105,343	104,932
Producer-gas and carbonising works (bone and coal)	27,850	29,964	32,049	167,000	163,000
Total - - - - -	367,587	384,976	388,308	432,000	421,000

The following figures refer to the output of the chief countries:—

	1900.	1909.	1911.	1931.
	(Metric Tons.	(Metric Tons.	(Metric Tons.	(Long) Tons.
England - - - - -	217,000	349,000	378,000	777,090
Germany - - - - -	104,000	323,000	400,000	1,900,000
United States - - - - -	58,000	98,000	127,000	1,285,000
France - - - - -	37,000	54,000	60,000	357,000
Belgium, Holland - - - - -	68,000	134,000
Austria, Russia, etc. - - - - -				

The world's production of ammonium sulphate is estimated as:—

1900.	1909.	1911.	1932.
484,000 tons.	950,000 tons.	1,150,000 tons.	3,935,000 tons.

Great Britain exported ammonium sulphate:—

1911.	1912.	1914.	1930.	1932.
292,000 tons.	287,000 tons.	314,000 tons.	557,930 tons.	419,871 tons.

Great Britain produced of ammonium sulphate:—

1930.	1931.	1932.
671,060 long tons.	514,000 long tons.	612,000 long tons.

The chief product of the ammonia industry is, at present, *solid ammonium sulphate*, $(\text{NH}_4)_2\text{SO}_4$, which is principally used in agriculture as a manure. It is valued on the percentage of nitrogen it contains, containing when pure, as $(\text{NH}_4)_2\text{SO}_4$, about 21.2 per cent. N against 16.5 per cent. N in NaNO_3 , or Chile saltpetre, which is at present its great competitor as a manure.

The price of ammonium sulphate sunk from 50s. per ton in 1880 to 20s. to 30s. in 1909, and no doubt in consequence of the production of cheap synthetic ammonia, both from cyanamide and by direct synthesis, the price will probably still further decrease.

Manufacture of Ammonium Sulphate from Gas - Water or Ammoniacal Liquor.—At present the bulk of the ammonium sulphate on the market is derived from the “gas-water” or “*ammoniacal liquor*” produced in the numerous coal-gas producing plants, coke ovens, etc.

In the coke ovens, however, the gases now are passed directly through sulphuric acid, and the ammonium sulphate thereby directly fixed, thus avoiding the initial production of an “*ammoniacal liquor*” such as is indispensable to coal-gas production.

Ordinary ammoniacal liquors contain some 1.5-3 per cent. NH_3 , united with various acids. The chief acid is carbonic, H_2CO_3 , but besides this we get H_2S , HCN , $\text{HCNSH}_2\text{S}_2\text{O}_6$, H_2SO_4 , HCl , and ferro- and ferri-cyanic acids.

The ammonium salts are, in practice, divided into (a) volatile, (b) fixed. The “volatile” ammonium salts on boiling with water dissociate, evolving ammonia. The chief volatile salts are:—Ammonium carbonate, $(\text{NH}_4)_2\text{CO}_3$; ammonium sulphide, $(\text{NH}_4)_2\text{S}$ and NH_4HS ; ammonium cyanide, NH_4CN .

The “fixed” ammonium salts (e.g., ammonium sulphate, $(\text{NH}_4)_2\text{SO}_4$; ammonium chloride, NH_4Cl , etc.) are not decomposed by water, but the ammonia has to be driven out of them by boiling with milk of lime.

Different ammoniacal liquors, however, have an extremely variable composition. An average sample would contain per 100 c.c. from 1.4-3.3 g. volatile ammonia (principally in the form of ammonium carbonate), and 0.2-0.6 g. NH_3 in the form of “fixed” salts. The composition of the ammoniacal liquor naturally largely depends upon the nature of the coal used, and some coals, rich in chlorides, yield ammoniacal liquors containing much NH_4Cl .

The following analyses give the composition of some average ammoniacal liquors, the numbers giving grams per 100 c.c. :—

	Gas Works.	Coke Ovens.	Blast Furnaces.	Shale Works.	Coalite Works.
Volatile NH_3 - - -	1.4-3.3	0.84	0.2-0.4	0.9	1.5
Fixed NH_3 - - -	0.6-0.2	0.10	0.008-0.009	0.03	0.17
Total NH_3 - - -	2.5-3.5	0.94	0.2-0.4	0.9	0.7
$(\text{NH}_4)_2\text{S}$ - - -	0.9-0.8	0.47	...	0.1	0.23
$(\text{NH}_4)_2\text{CO}_3$ - - -	5.0-8.8	1.96	1.1	2.9	6.4
$(\text{NH}_4)\text{Cl}$ - - -	1.1-0.5	0.22	0.006	0.015	0.1
$(\text{NH}_4)_2\text{SO}_4$ - - -	0.2-0.0	0.03	0.009	0.016	0.05
$(\text{NH}_4)_2\text{S}_2\text{O}_8$ - - -	0.17-0.0	0.04	0.002	0.09	0.4
NH_4CNS - - -	0.53-0.07	0.04	0.003	...	0.3
NH_4CN - - -	0.036-0.07	0.07	0.003
$(\text{NH}_4)_4\text{Fe}(\text{CN})_6$ - - -	0.038

Organic substances such as phenol, pyridin, acetonitrol, etc., also occur in small amounts.

The method of working the ammoniacal liquor for ammonium sulphate is first to boil it until all the “volatile” ammonium salts have been distilled off. To the residual liquid containing the “non-volatile” ammonium salts the theoretical amount of milk of lime is added, and the boiling continued until all their ammonia is also expelled.

The evolved vapours are usually led directly into H_2SO_4 of $42^\circ\text{--}46^\circ$ B \acute{e} . ($81^\circ\text{--}93^\circ$ Tw.), and the ammonia fixed in the form of solid ammonium sulphate, $(\text{NH}_4)_2\text{SO}_4$, which can be sold without further refining for manurial purposes.

The plant used consists of "column" apparatus similar to those described in detail in **Martin's** "Industrial Chemistry: Organic," for distilling alcohol; the apparatus, however, is modified so that the ammoniacal liquor alone is distilled in the upper part of the apparatus so as to expel all volatile ammonia; while in the lower part of the apparatus the "fixed" ammonium salts in the residual liquid are boiled with milk of lime.

There are a great many different plants on the market, some of which are extremely efficient. **Feldmann's Apparatus** (D.R.P., 21,708, see English Patent, 3,643, 1882) is shown in Fig. 1.

The ammoniacal "gas-water" flows into a tube from the regulating tank **A**

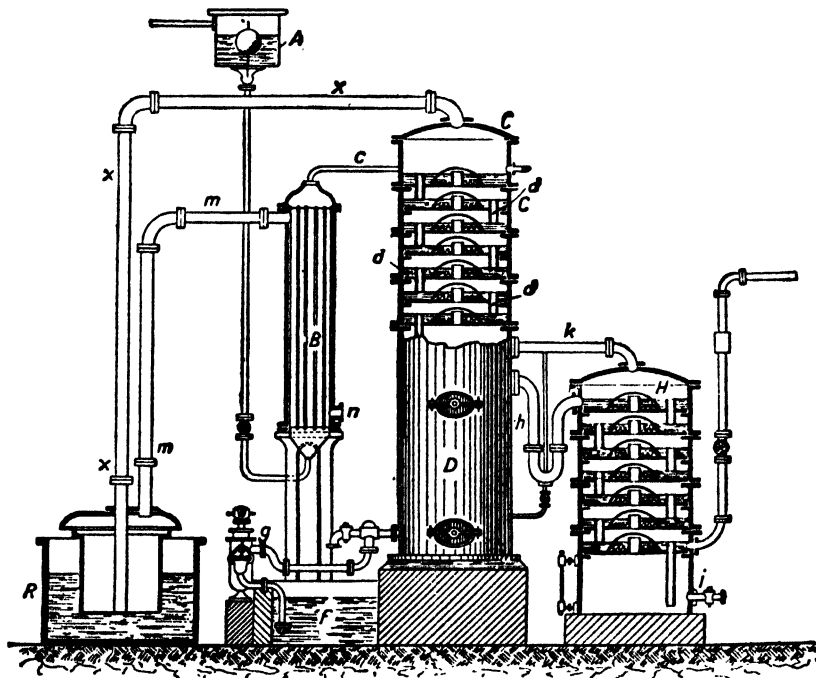


FIG. 1.—Feldmann's Ammonia Still.

and enters the multitubular "preheater" **B**, consisting of a series of tubes through which the ammoniacal liquor flows, which are themselves heated by the steam and hot gas coming from the saturator **R** by the pipe *mm*. From the "preheater" **B** the now hot ammoniacal fluid flows into the top chamber of the column **C**. This is provided with a number of compartments each provided with an overflow pipe *d*, so that in each compartment the liquor accumulates to an appreciable depth. In the centre of the floor of each compartment is a wider pipe covered over with a "bell" or "mushroom" (*e*), provided with serrated edges (see this Volume under "Ammonium Soda Industry"). Through this central pipe the ammoniacal gases and steam come up from below and stream through the liquor surrounding the "mushroom," and thus boil out all the volatile NH_3 .

The liquid in **C**, from which all volatile ammonia has been boiled out, now enters the lower part of the still **D**. Into this compartment a stream of milk of lime is continually pumped by means of the pump *g*, the lime being sucked out

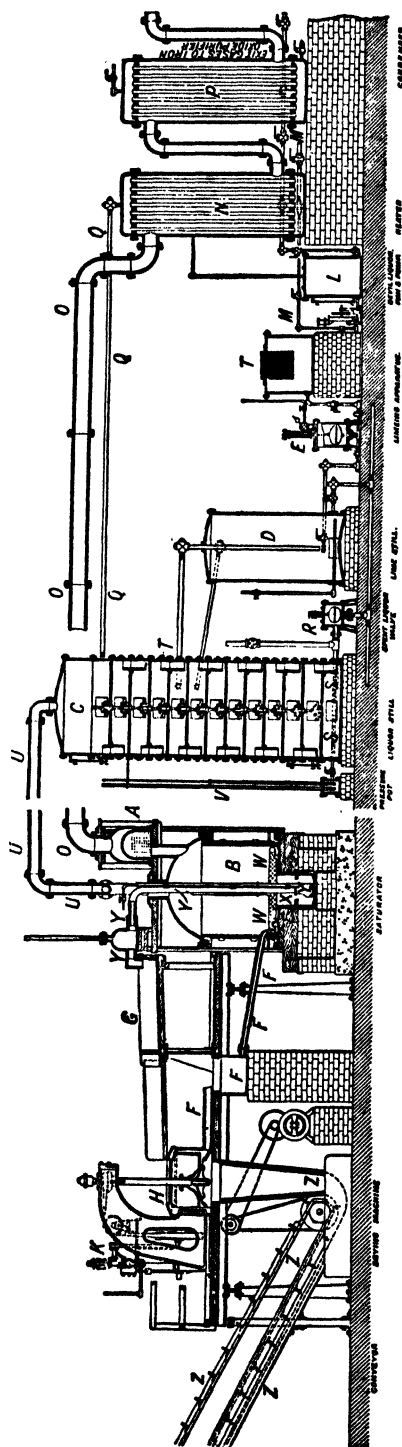


FIG. 2.—Ammonium Sulphate Plant of the Chemical Engineering Co., Hendon, England.

of the tank *f*. The mixed fluids flow through a filtering sieve (to retain large particles) through the tube *h* into the column *H*, through which is passed from below a current of steam from a boiler. This steam maintains the whole liquid at a boiling temperature and completely expels all the ammonia from the "fixed" ammonium salts, the ammonia being, in the first place, set free by the milk of lime.

The waste ammonia-free liquors run away through *i*.

The mud-like mass of lime escapes through an opening at the bottom of *D*.

In some plants a special separate mixing vessel is provided, standing outside the column. Into this the liquid coming from the middle part of the column *C* is run, and is then intimately mixed with milk of lime, and then the mixed fluids are run back into the lower column *B*, and subjected to the boiling by means of steam. A still of this type is manufactured by the Chemical Engineering Co., Hendon, and is shown in Fig. 2.

Many special modifications of this apparatus are used. We may here mention the apparatus of Grüneberg and Blum (D.R.P., 33,320); Wilton (English Patent, 24,832, 1901); Scott (English Patents, 3,987, 1900; 11,082, 1901).

The escaping steam, carrying with it the NH_3 gas, passes out at the top of the column *C* and through the tube *xx* into the lead-lined (or volvic stone) "saturator" *R* constructed as shown, with a leaden "bell" dipping under the surface of sulphuric acid (90° Tw. , 45° Bé.) which enters in a continual stream. The NH_3 as it enters unites with the sulphuric acid to form solid ammonium sulphate ($2\text{NH}_3 + \text{H}_2\text{SO}_4 = (\text{NH}_4)_2\text{SO}_4$) which separates out in the liquid.

It should be noted also that much heat is evolved by the union of the sulphuric acid and the ammonia in the saturator, the heat of interaction being sufficient not only to maintain the saturator at the boiling point, and compensate for unavoidable losses by radiation, etc., but also to more than evaporate the whole of the water contained in the acid, amounting to 20-30 per cent., so that the apparatus can be washed out from time to time, as necessary, without wasting the washings, or evaporating them down externally.

The saturator just described belongs to the "partly open" type, the hot waste gases being led off by the pipe *m* to the heater *B*, and the sulphate accumulating on the floor of the saturator, the workman removing the latter as it separates by means of a perforated ladle inserted through the

open part of the tank. The crystals of sulphate are then placed on a lead-lined drainer, so that the mother liquors flow back to the saturator.

More often the ammonium sulphate crystals are removed from the saturator by means of a steam discharger (working on the principle of the air-lift), which drives it in the form of a coarse mud, together with a considerable amount of mother liquor, on to the drainer, and thence it is passed into the centrifugal machines, the mother liquors invariably running back into the saturator. In this type of plant a closed saturator is used, as described below:—

Fig. 2 shows a modern ammonium sulphate plant, erected by the Chemical Engineering Co., of Hendon, London, N.W., for the Grangetown Gas Works, Cardiff, in 1911. This plant is capable of producing 3 tons of ammonium sulphate per twenty-four hours.

The ammoniacal liquor enters the multitubular heater *N* at the bottom through *H*, passes up the pipes' insides, and is thereby heated to the boiling point by the steam and hot waste gases from the saturator *B*. These hot vapours issue from the saturator at *A*, pass along the pipe *OO*, then encircle the tubes in the interior of the heater *N*, heating the ammoniacal liquor therein contained to the boiling point, and being partially condensed in so doing. The condensed steam (known as **Devil Liquor**, on account of the H_2S , NH_3 , HCN , etc., contained therein) runs off into the sealed closed tank *I*, and is pumped back through *MM*, and mixed with the gas liquor, the whole thus passing through the liquor still *C*, which renders it inodorous, the liquors being finally run to waste after passing through the liquor still in the form of "spent liquor." Any moisture not condensed by the heater *N* is finally condensed in the condenser *P* (two are employed) of similar construction to *N*. The H_2S and CO_2 from the saturator *B*, however, pass for the most part away from the exit gases, being purified with oxide of iron, and the H_2S recovered is sulphur.

The ammoniacal liquor, heated to boiling in *N*, passes along the pipe *QQ*, and enters the liquor still *C* at the top, and slowly flows by a series of weirs, in a downward direction, through the fifteen chambers to the automatic exit, which is controlled by the spent liquor valve *R*. *V* is an arrangement for controlling the pressure in the still. Steam is admitted at the bottom of the still by the perforated pipe *SS*, and bubbles through the liquor in each chamber, travelling in a reverse direction to the liquor, and carrying with it the ammonia and the gases, H_2S and CO_2 , which pass away from the top of the still to the acid saturator *B*; the H_2S and CO_2 thence escape along *OO* to the condensers, and reappear in the "devil liquors" at *N*, as previously explained, and in the waste exit gases from *P*.

In order to complete the removal of fixed ammonium salts from the liquor lime are automatically admitted to the middle chamber of the still at *T*, *D* being the auxiliary limeing still (see p. 458), which acts as a reservoir, and retains the lime sludge. The lime is slaked in *T* with spent liquor from the stills, and forced into the still *C* at boiling temperature at the required rate, by means of automatic pumps. *E* is the automatic valve controlling the admission of lime to *D*. The saturator *B* is of the round closed type, constructed of 40 lbs. chemical lead. In this saturator the ammonia coming from the still *C* passes through the pipe *UU* nearly to the bottom of the saturator, and bubbles through the acid bath by means of the perforated pipe *WW*. The saturator is continuously fed with sulphuric acid in proportion to the amount of entering ammonia. The chemical action, caused by the ammonia uniting with the acid to form ammonium sulphate, develops sufficient heat to cause vigorous boiling; the uprising steam, together with H_2S and CO_2 from the ammoniacal liquors, and some ammonia escape at a high temperature through the tube *OO* to the heater *N* and condensers *P*, as above explained.

The sulphate of ammonia is deposited in a crystalline form into the well *X* at the bottom of the saturator *B*, from which it is pumped by means of the steam discharger *YY* to the receiving tray *G*, whence it gravitates at intervals to the centrifugal machine (described in *Martin's "Industrial Chemistry: Organic"*), the tray holding a charge of about 4 cwt. The centrifugal machine separates the mother liquor, which flows back to the saturator by *FFF*. After two minutes' spinning the centrifugal machine *H* is stopped, and the dry sulphate of ammonia is dropped through the centre valve on to the elevator conveyor *ZZ*, and deposited in the store.

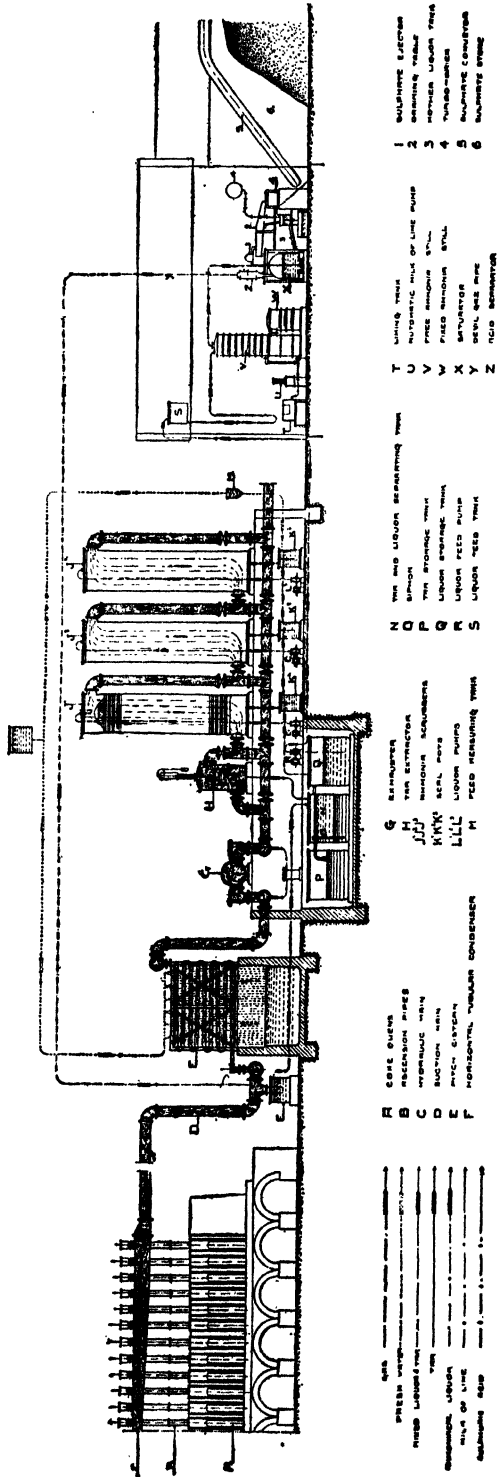
The apparatus used for the manufacture of ammonium sulphate by the Coppée Gas Co. is shown in Fig. 3. The diagram, Fig. 4, explains the mode of working of the apparatus.

The crystals of sulphate thus obtained are sometimes washed with a very little water, dried, and put on the market for manurial purposes, containing 25.1-25.3 per cent. NH_3 . $(NH_4)_2SO_4$ requires $NH_3 = 25.8$ per cent. less than 0.4 per cent. free H_2SO_4 , and no cyanide, since the latter is very injurious to vegetation.

Chemically pure ammonium sulphate is sometimes, although rarely, obtained from this raw ammonium sulphate by crystallisation.

Treatment of the Waste Exit Gases from the Ammonium Sulphate Plant.—The acid gases, such as H_2S , HCN , and CO_2 , which pass with the ammonia into the sulphuric acid in the

DIAGRAM OF BYE PRODUCT PLANT WITH WET SULPHATE RECOVERY



- A. PRESSURE VESSEL
- B. PRESSURE VESSEL
- C. PRESSURE VESSEL
- D. PRESSURE VESSEL
- E. PRESSURE VESSEL
- F. PRESSURE VESSEL
- G. CONDENSER
- H. CONDENSER
- I. CONDENSER
- J. CONDENSER
- K. CONDENSER
- L. CONDENSER
- M. CONDENSER
- N. CONDENSER
- O. CONDENSER
- P. CONDENSER
- Q. CONDENSER
- R. CONDENSER
- S. CONDENSER
- T. CONDENSER
- U. CONDENSER
- V. CONDENSER
- W. CONDENSER
- X. CONDENSER
- Y. CONDENSER
- Z. CONDENSER

THE COPPÉE COMPANY (GREAT BRITAIN) LTD., KING'S HOUSE, KINGSWAY, W.C.

FIG. 3.—By-Product Plant with Wet Sulphate Recovery.

Fig. A

Sulphate Plant Ordinary method of recovery

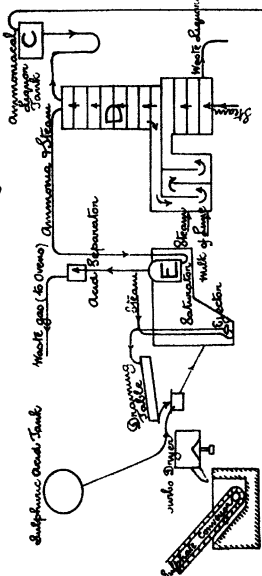


Fig. B

Gas Scrubbing

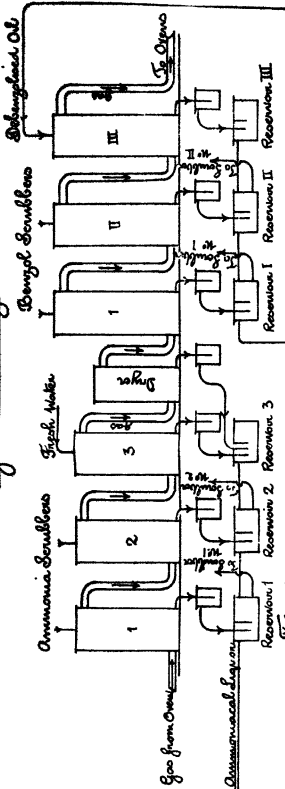
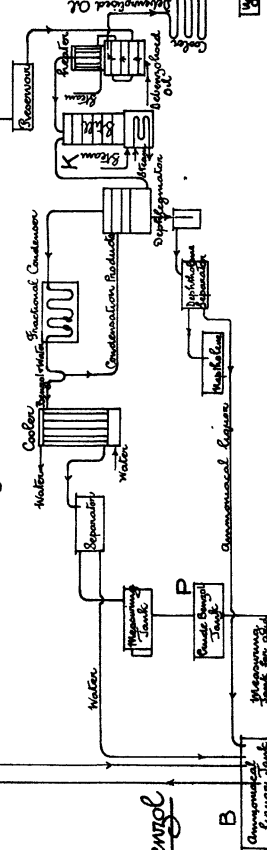


Fig. C

Crude Benzol Plant



Diagrammatic Arrangement of Complete Plant for recovery of Ammonia & Benzol

Fig. D
Benzol Rectifying Plant

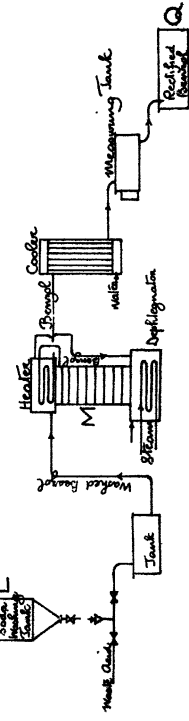


FIG. 4.—PLANT FOR RECOVERY OF AMMONIA AND BENZOL.
(By Permission of the Coppitt Co., Ltd., London.)

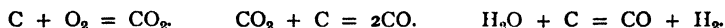
saturation are not absorbed therein, but escape with steam into the multitubular preheaters and condensers, and after heating the entering ammoniacal liquors in the tubes in the preheater as they pass on their way to the still, the cooled gases, consisting of H_2S , HCN , and CO_2 , finally escape either (1) directly into a furnace, where they are burnt in order to destroy the poisonous HCN , the H_2S burning to SO_2 ; or (2) into an absorption apparatus using iron oxide purifiers (as in coal-gas works for purifying coal-gas) (see Martin's "Industrial Chemistry: Organic"); or (3) where the H_2S is recovered as sulphur, and nitrogen recovered as Prussian blue, the gas is burnt in a limited supply of air according to the Claus process, whereby the H_2S burns, depositing S, which is thereby recovered.

However, in most works the gases are simply burnt, the products of combustion escaping, unutilised, up the chimney.

MANUFACTURE OF AMMONIUM SULPHATE FROM MOND GAS¹

Very similar is the production of ammonium sulphate from **Mond Gas**.

The coal is charged into a distributor and hopper from an elevator, and then falls into the "generators" where, under the influence of a mixture of air and steam, it is gasified in the manner described in Section XLVIII. See also the section on "Producer Gas," in this Volume, the equations being:—



There is thus produced a gas consisting mainly of CO , admixed with some hydrogen. The N in the coal escapes in 70-80 per cent. as NH_3 with the issuing gas. The gases next stream through a series of "coolers," in which they exchange their heat with the air which is streaming into the generators, the air being thus preheated, and the Mond gas cooled. Next, the gas passes through a washer, where it is largely freed from tar and dust. Finally, the gas passes up a tower, where it meets a stream of descending sulphuric acid, which combines with all the ammonia in the gas, forming ammonium sulphate. This acid solution is pumped by an acid pump up a tower, a continual circulation of the acid in the tower being kept up until the acid is practically saturated with ammonium sulphate, when it is run off and evaporated in a special apparatus, and the ammonium sulphate recovered. From the tower the gases pass through another tower, where they are treated with a stream of cold water, whereby the gas is cooled (and the water heated), and passes away directly to the gas engines or furnaces for use. The hot water obtained from the second tower is now pumped up the third tower, where it is allowed to flow down against an incoming current of cold air, which it thus saturates with water vapour, the air current then going on to the furnaces for the production of the CO by partial combustion of the coal.

While in coal-gas works and coke ovens scarcely ever more than 20 per cent. of the N in the coal is obtained in the form of ammonia, in the Mond-gas process no less than 70-80 per cent. of the nitrogen present in the coal is ultimately converted into ammonia, and recovered as ammonium sulphate, e.g., each ton of coal yields over 40 kg. of ammonium sulphate, against 10 kg. obtained in coke ovens. Over 4s. per ton profit can be made out of the ammonium sulphate thus recovered, which leads to a further reduction in the price of the gas for power.

According to Caro, even the waste obtained by washing certain coals—containing only 30-40 per cent. C and 60-70 per cent. ash, and so useless for burning in the ordinary way—can be gasified by the Mond process, and a very considerable percentage of the nitrogen recovered as ammonium sulphate, 1 ton of this waste material yielding 25-30 kg. of ammonium sulphate and 50-100 H.P.-hours in the form of electrical energy.

Also moist peat can be gasified in the generators, and the contained nitrogen recovered as ammonium sulphate (Woltereck).

For further details the reader should see this Volume under "Producer Gas"; also Caro, "Die Stickstofffrage in Deutschland" (1908); *Chemiker Zeitung*, 1911, 505; Frank, Caro, and Mond, *Zeit. angew. Chem.*, 1906, 1569; Norton, *Consular Report*, pp. 40, 170; Lange, "Coal Tar and Ammonia," 1913, 861; Woltereck, English Patents, 16,504, 1904; 28,963, 1906; 28,964, 1906.

¹ See this Volume under "Producer Gas," where the composition of the gas and the nature of the furnaces, fuels, etc., are discussed.

MANUFACTURE OF AMMONIUM SULPHATE BY THE DIRECT PROCESS FROM COKE-OVEN GAS, BLAST-FURNACE GAS, PRODUCER-GAS, AND SIMILAR GASES RICH IN AMMONIA

This is a problem on which a great deal of elaborate work has been expended during the last fifteen to twenty years, and even at the present time it does not seem to have been completely solved.

Ammonium carbonate is very volatile, and consequently passing the gases directly through water only causes the formation of a dilute ammoniacal "gas liquor" (as in gas works), the direct distillation of which would be expensive on account of fuel consumed.

It is, therefore, much more economical to pass the gases directly into fairly concentrated sulphuric acid, whereby matters must be so arranged that solid ammonium sulphate separates directly, that the concentrated sulphuric acid is not greatly diluted by the steam, etc., in the gases driven through it, and finally, that the resulting tar is not spoiled by the treatment.

One of the most successful systems is that embodied by the **Kopper Ammonia Recovery Plant**. The gases coming from the coke ovens, etc., are first cooled

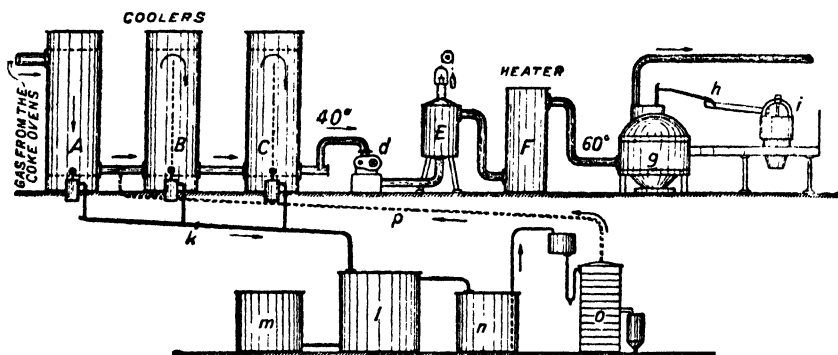


FIG. 5.—The Kopper Ammonia Recovery Plant.

to 40° C., whereby the heavy tar oils and the bulk of the steam (with 20-25 per cent. of the total ammonia) is deposited in the liquid form.

The gases are next passed through tubes whereby they are reheated to 60°-80° C.—the hot furnace gases in counter-current being used for this purpose—and the hot gases are then directly passed into 60° Bé, 141° Tw., H_2SO_4 ; simultaneously the NH_3 which has been expelled from the condensed liquors by heating them with lime is also passed into the H_2SO_4 . The NH_3 directly combines with the H_2SO_4 and ammonium sulphate separates in a solid form in the saturator and is withdrawn from time to time, centrifuged, and dried as previously described.

Fig. 5 shows **Kopper's Plant**.

The hot furnace or coke-oven gases are passed through coolers A, B, C, until they are cooled to about 30°-40° C., and then are led through a Pelouze tar separator (Martin's "Industrial Chemistry: Organic"), E, so that almost all the tar (but not the light oils) are condensed, together with most of the water, which contains 25-75 per cent. of the total ammonia (according to the temperature), all the fixed ammonium salts (NH_4Cl , etc.), etc., etc. The tar and the ammoniacal water flows into a holder *l*, the tar being run off at the bottom into another holder *m*, while the ammoniacal water runs into a second holder *n*.

The tar-free gases are again reheated in F to 60°-80° C., and then are passed directly into the holder *g*, containing concentrated 60° Bé. (141° Tw.) sulphuric acid. The solid ammonium sulphate immediately separates, and is forced out from time to time by means of compressed air into the collecting tray *h*, thence into the centrifugal machine *i*, where excess of acid is drained off.

The reheating of the gas, before passing into the sulphuric acid, aids the evaporation of the water

from the sulphuric acid. The heat of the reaction going on in *g* is alone often sufficient to achieve this, especially if all the fixed ammonium salts have been previously removed. The gases escaping from *g* contain benzene, and are passed on through heavy oils to extract this substance, as described under **Coke Ovens** in this Volume.

The ammoniacal water in *n* is distilled in a column with lime in the usual manner for ammonia (see p. 457), and the gaseous ammonia evolved is often directly sent back into the gas stream (between the coolers A and B) to be fixed by the sulphuric acid in *g*. Since the amount of deposited gas-water here only amounts to about 20 per cent. of the washing water formerly needed to extract the ammonia in scrubbers, it is stated that the cost of the distillation of the ammonia and the quantity of the troublesome waste water is much less than by the ordinary process of the ammonia extraction.

In the **Otto-Hilgenstock Ammonia Recovery Process** (Fig. 6) the old condensing plant is entirely dispensed with, the tar being removed from the entering gases by a tar spray at *A* at a temperature above the dew-point of the liquors.

After depositing the tar in *B* the gases pass directly through an exhauster *E* into the saturator *F*, where the whole of the ammonia is caught by the sulphuric acid. The gases coming from the saturator are hot, and contain all their moisture in the form of steam; the gases are, therefore, passed forward to the oven flues, and the troublesome and offensive waste liquors are thus got rid of. *C* is the tar-spray pump, *D* the tar-spray feed pipe, *G* is the acid-spray catch box, *H* the mother liquor return pipe, *J* the tar store, *K* the tar-spray overflow pipe, *L* the condensing tank, *M* the pump delivering tar to railway trucks, *N* the pump delivering condensers to the saturator *F*.

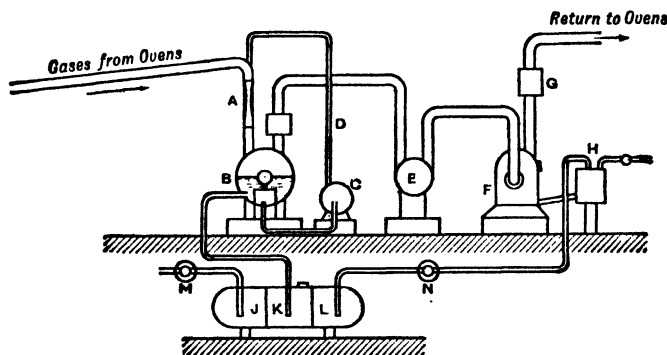


FIG. 6.—The Otto-Hilgenstock Ammonia Recovery Plant.

The ammonium sulphate produced contains 25-25.5 per cent. N and contains less than 0.1 per cent. of tar.

The Coppée Company's Process of Semi-Direct Sulphate Recovery is illustrated in Figs. 7 and 8.

In the **Fausser Process** (see Pincass, *Chem. and Ind.*, 1933, 74) sulphuric acid mist enters at the top of a chamber while anhydrous ammonia enters at the bottom.

See also *Chem. Age*, 1930, 476; *Chem. Met. Eng.*, 1930, 37, 591.

O. Piette (British Patent 327,488, 1930) precipitates ammonium sulphate from a cold saturated solution by ammonia.

See also French Patent 630,426; British Patents 330,945, 309,565.

MANUFACTURE OF CAUSTIC AMMONIA (LIQUOR AMMONIA)

A crude aqueous solution of ammonia, containing ammonium sulphide and sometimes carbonate, is manufactured under the name "**Concentrated Ammonia Water**" by distilling ordinary gas-water without addition of lime in column apparatus.

Concentrated Ammonia Water is used as a convenient source of ammonia either for ammonia-soda factories, or for factories which, possessing no ammonia plant of their own, require ammonia gas in a concentrated form, *e.g.*, for manufacturing salts such as NH_4Cl , NH_4NO_3 , etc., or liquid NH_3 . It contains much less CO_2 and H_2S than the ordinary diluted ammoniacal liquors of gas-works, because these gases, in general, escape during the distillation before the NH_3 gas. This liquor is much cheaper than the pure aqueous solution, and the presence of some CO_2 and H_2S does not affect the manufacture of many chemicals.

[To face page 464.]

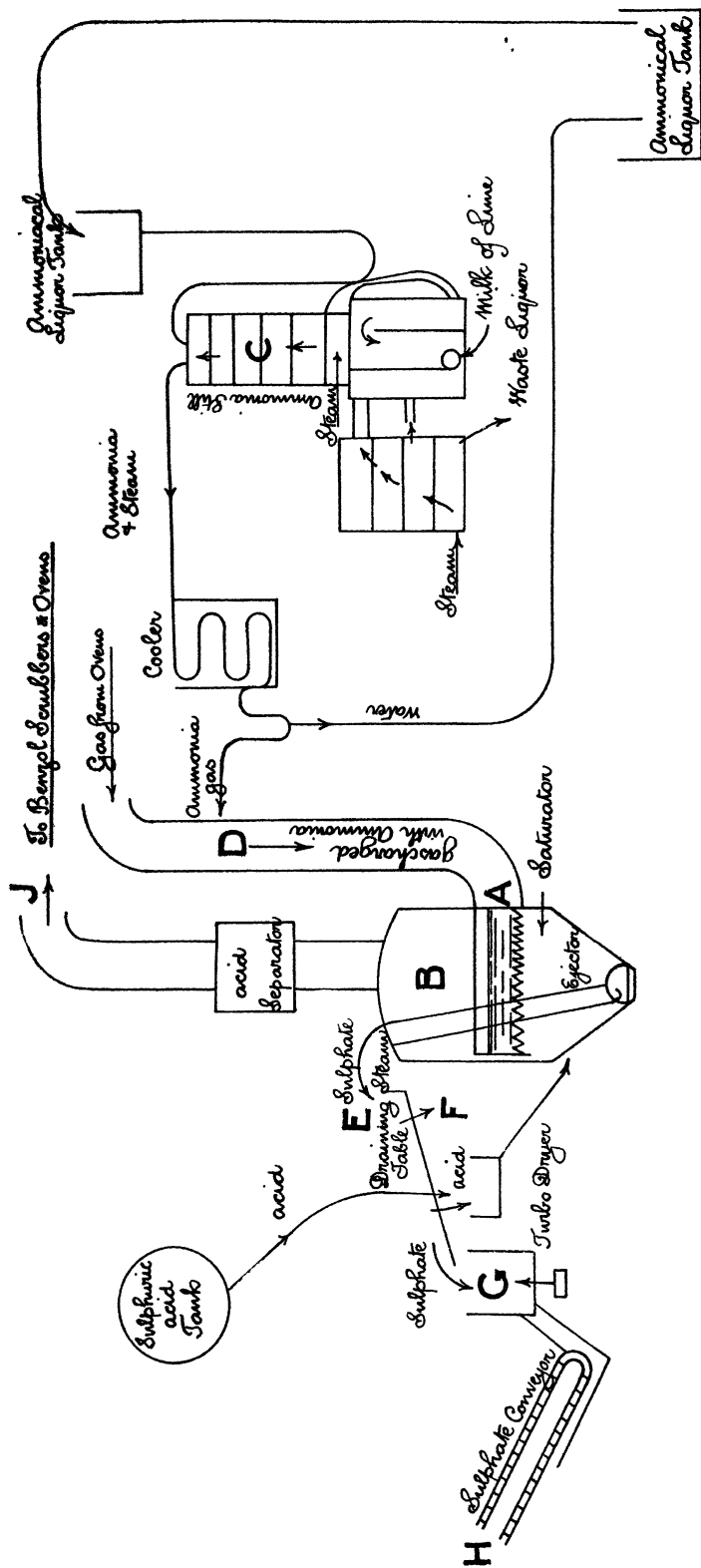


FIG. 8. Sulphate Plant for Direct Recovery Process

(By Permission of the Coppée Co., Ltd., London.)

[To face page 464.]

Two varieties of "concentrated ammonia water" are manufactured:—(1) One containing 15-18 per cent. of NH_3 with both sulphide and carbonate present; (2) one containing 18-26 per cent. NH_3 containing some sulphide but practically no carbonate.

(1) The first liquid is made by passing the ammoniacal gases from the still (as described above) through a reflux condenser, whereby some moisture is removed, and then into a direct condenser, the gases from which are washed through water. The formation of ammonia carbonate and resulting blockage of the pipes prevents a higher concentration of NH_3 being obtained in this manner.

(2) To manufacture the second liquid we proceed as before, but the vapours from the still are passed first through the reflux condenser and then through vessels containing milk of lime which removes the CO_2 and some H_2S . The vapours are then condensed and contain 22-26 per cent. NH_3 , some H_2S , but little or no CO_2 .

Manufacture of Pure Aqueous Solutions of NH_3 .—The ammoniacal liquor is first heated to 70°-80° C. in order to expel most of the CO_2 and H_2S . The liquid is next distilled in a columnar apparatus, as previously described, and the vapours are passed, first through a reflux condenser (to remove some water), then through milk of lime washers to remove CO_2 and H_2S (the partly used lime being run back into the still to decompose the fixed ammonium salts), the last traces of H_2S being removed by either passing the gases through FeSO_4 solution, or through a little NaOH solution. J. Louis Foucar recommends ammonium persulphate or sodium permanganate.

Lastly, the vapours pass through wood charcoal, which removes tarry matters, and then (sometimes) through a non-volatile fatty or mineral oil. The fairly pure NH_3 gas is then led into distilled water until the required concentration (up to about 36 per cent. NH_3 is attainable) is obtained.

The charcoal filters are revived from time to time by ignition in closed retorts.

The following table gives the specific gravity of aqueous ammoniacal solutions of various strengths (after Lunge and Wiernek):—

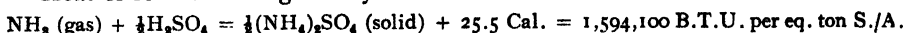
SPECIFIC GRAVITY OF AQUEOUS SOLUTIONS OF AMMONIA AT 15° C.

Specific Gravity.	NH_3 per Cent.	1 Litre contains g. HN_3 .	Specific Gravity.	NH_3 per Cent.	1 Litre contains g. NH_3 .
1.000	0.00	0.0	0.936	16.82	157.4
0.998	0.45	4.5	0.934	17.42	162.7
0.996	0.91	9.1	0.932	18.03	168.1
0.994	1.37	13.6	0.930	18.64	173.4
0.992	1.84	18.2	0.928	19.25	178.6
0.990	2.31	22.9	0.926	19.87	184.2
0.988	2.80	27.7	0.924	20.49	189.3
0.986	3.30	32.5	0.922	21.12	194.7
0.984	3.80	37.4	0.920	21.75	200.1
0.982	4.30	42.2	0.918	22.39	205.6
0.978	5.30	51.8	0.916	23.03	210.9
0.974	6.30	61.4	0.914	23.68	216.3
0.972	6.80	66.1	0.912	24.33	221.9
0.968	7.82	75.7	0.910	24.99	227.4
0.966	8.33	80.5	0.908	25.65	232.9
0.964	8.84	85.2	0.906	26.31	238.3
0.962	9.35	89.9	0.904	26.98	243.9
0.960	9.91	95.1	0.902	27.65	249.4
0.958	10.47	100.3	0.900	28.33	255.0
0.956	11.03	105.4	0.898	29.01	260.5
0.954	11.60	110.7	0.896	29.69	266.0
0.952	12.17	115.9	0.894	30.37	271.5
0.950	12.74	121.0	0.892	31.05	277.0
0.948	13.31	126.2	0.890	31.75	282.6
0.946	13.88	131.3	0.888	32.50	288.6
0.944	14.46	136.5	0.886	33.25	294.6
0.942	15.04	141.7	0.884	34.10	301.4
0.940	15.63	146.9	0.882	34.95	308.3
0.938	16.22	152.1

TECHNICAL AMMONIUM SALTS

Ammonium Sulphate, $(\text{NH}_4)_2\text{SO}_4$.—Manufacture and properties are described on p. 456 *et seq.* See also under **Manures**, Volume II. of this work.

Heat of formation is given by:—

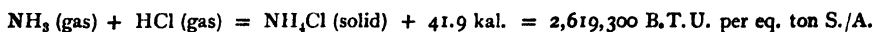


Ammonium Chloride (Sal Ammoniac), NH_4Cl .—Prepared by passing vapours of ammonium into HCl, or *vice versa*. Sal ammoniac is the sublimed chloride. It is somewhat expensive to sublime owing to the difficulty of obtaining suitable vessels into which to sublime the chloride. Cheap earthenware is often used, which, however, can only be used once as it has to be broken to remove the sublimate of sal ammoniac.

Also prepared by treating ammonium sulphate with sodium chloride (see **R. Freitag**, *Ind. Eng. Chem.*, 1932, 24, 1235; see also British Patent 333,098; *Chem. Zeit.*, 1930, 54, 162).

The substance is used in galvanising, in soldering, in galvanic cells, in the manufacture of colours, in calico-printing, in pharmacy.

Heat of formation is given by:—



Ammonium Carbonate.—Commercial ammonium carbonate is usually a mixture of ammonium bicarbonate, NH_4HCO_3 , and ammonium carbonate, $\text{NH}_4\text{O.CO.NH}_2$.

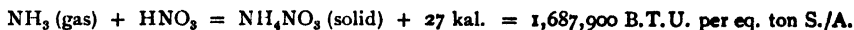
The ammonia content of the mixture varies between 25-58 per cent., the usual percentage of ammonia being 31 per cent.

It is most easily made by direct combination of ammonia, carbon dioxide, and water vapour, the substance being condensed on water-cooled surfaces of aluminium. The substance is volatile, and should at once be packed into air-tight vessels in order to avoid loss.

It is used in the manufacture of baking powders, dyeing, in extracting colours from lichens, in caramel making, smelling salts, etc. Also as a general detergent, and for removing grease from fabrics.

Ammonium Nitrate, NH_4NO_3 .—See p. 435 for manufacture and properties. Its main use is for safety explosives, sporting powders, fireworks, etc. Much is used for the preparation of nitrous oxide, "laughing gas."

Heat of formation is given by:—



Ammonium Perchlorate, NH_4ClO_4 , is prepared by the double decomposition of NaClO_4 and NH_4Cl .

For patents bearing on its manufacture see **Alvisi**, D.R.P., 103,993; **Miolati**, D.R.P., 112,682; see also **Witt**, *Chem. Ztg.*, 1910, p. 634.

The salt is obtaining extended use as an explosive and oxidising agent, soluble in 5 parts cold water, insoluble in alcohol, sp. gr. 1.89.

Ammonium Phosphate, $(\text{NH}_4)_2\text{HPO}_4$, is made by neutralising phosphoric acid with ammonia, evaporating, and crystallising. Used in the manufacture of sugar (Lagrange process), and in the impregnation of matches.

Ammonium Persulphate, $(\text{NH}_4)_2\text{S}_2\text{O}_8$, prepared by electrolysing an acid saturated solution of ammonium sulphate at 7° C., using 5 volts in a specially designed apparatus. Much used as an oxidising agent in dyeing and photography; see the D.R.P., 155,805, 170,311, and 173,977; also **Marshall**, *Trans. Chem. Soc.*, 1891, p. 777.

Ammonium Thiosulphate, $(\text{NH}_4)_2\text{S}_2\text{O}_3$, prepared by double decomposition, thus— $2\text{NHCl} + \text{Na}_2\text{S}_2\text{O}_3 = (\text{NH}_4)_2\text{S}_2\text{O}_3 + 2\text{NaCl}$. Used in photography.

Ammonium Acetate, $\text{NH}_4\text{OOC.CH}_3$, prepared by neutralising acetic acid with ammonia, and used for making acetamid.

Ammonium Fluoride, NH_4F , made by neutralising HF with NH_3 , is used for etching glass, decomposing minerals containing rare earths, for the manufacture of incandescent mantles, for preparing antimony fluoride and other technically important metallic fluorides, and also, to some extent, in dyeing.

Ammonium Sulphocyanide, NH_4CNS , occurs in gas liquor, and is often prepared by adding flowers of sulphur to an ammoniacal coal-gas washer, ammonium polysulphide being formed and cyanogen absorbed. It can also be made from CS_2 and NH_3 :— $\text{CS}_2 + 2\text{NH}_3 = \text{NH}_4\text{CNS} + \text{H}_2\text{S}$. Used in photography, calico-printing, and dyeing.

Ammonium Chlorate, NH_4ClO_3 , used in fireworks and explosives.

Ammonium Bromide, NH_4Br , used in pharmacy and photography.

Ammonium Oleate is used in ammonia soaps.

Dry Ammonia, $\text{CaCl}_2 \cdot 8\text{NH}_3$, containing 60 per cent. of NH_3 , is made by direct combination, and has in Germany a market as a portable and compact form of ammonia.

"**Solid Ammonia**" is manufactured by the Chemische Fabrik Betterhausen, Marquart & Schultz, by adding to a mixture of 3.5 parts of sodium stearate (dissolved in 10 parts of aqueous ammonia or 80 per cent. spirits of wine) about 85 or 90 parts of ammonia solutions containing 25-33 per cent. of ammonia. The mixture has a consistency nearly equal to that of solid paraffin. When heated or left exposed to air it gives up the whole of its ammonia, leaving behind the solid sodium stearate.

Large quantities of ammoniated superphosphates are made in the United States of America, containing up to 6 per cent. NH_3 , and made by treating the superphosphate with ammonia or merely by mixing in ammonium sulphate into the superphosphate. Products are used for manurial purposes.

Anhydrous Ammonia (Liquid Ammonia) is simply the purified NH_3 gas liquefied under pressure and filled into steel cylinders.

It is the most suitable and efficient working substance for refrigerating machines, and is used in some wool-washing institutions for cleaning purposes, the substance being an excellent solvent.

The liquid boils at 34°C . At 15°C . the liquid has a vapour tension of 6 atmospheres. As a liquid it has a very large coefficient of expansion, and a specified weight at 15°C . of 0.614, at 60°C . of 0.540.

In order to manufacture the substance, excess of lime is added to crude gas-water so as to fix all the CO_2 and H_2S , as well as to set free all the ammonia from the "fixed" ammonium salts. The liquid is then distilled in a special column apparatus, somewhat similar to that described on p. 456 for ammonium sulphate, but somewhat more complicated, the large masses of mud-like lime requiring special vessels for mixing, depositing the precipitated mud, and for boiling out the ammonia. The NH_3 gas emerging from the columns is cooled and then made to traverse a number of vessels containing milk of lime, whereby the last traces of CO_2 , H_2S , etc., are removed. The vapour then passes through a layer of paraffin oil, which retains tar and pyridine, etc. Then the gas passes through charcoal filters to remove the last traces of tarry matters, etc. The dry and pure vapour next passes to the pumps, where it is liquefied under 8 atmospheres' pressure. The operation is usually carried out in two stages, the gas heated in the first compression pump being cooled by water cooling before being passed into the next pump where the final liquefaction takes place.

The liquid is stored in steel cylinders, usually made to hold either 20 kg. or 50 kg. of liquid ammonia. The cylinders should be tested every four years at 30 atmospheres' pressure. For each 1 kg. liquid ammonia there is allowed a volume of 1.86 l. The liquid ammonia, on evaporation, should not leave behind more than 0.1 per cent. residue, consisting of water, machine oil, pyridine, etc.

Chloroamine, NH_2Cl , obtained by the action of sodium hypochlorite on ammonia, is finding favour in the purification of water, as a disinfectant for sewage, condenser water, etc., and as a mild bleach for rayon. See *Chem. Met. Eng.*, 1930, 37, 555.

SECTION XLVIII

SYNTHETIC AMMONIA

BY GEOFFREY MARTIN, D.Sc., Ph.D.

LITERATURE

- G. P. POLLITT.—*Chemical Age*, 1930, **23**, 8, 23.
 F. HABER and LE ROSSIGNOL.—“Technical Preparation of Ammonia from its Elements,”
Zeit. für Elektrochemie, 1913, **19**, 53, 72. (There is a good abstract of this paper in
 the *Journ. Soc. Chem. Ind.*, 1913.) *Ber.*, 1907, **40**, 2144; *Zeit. Elek.*, 1908, **14**,
 181, 513.
 HABER and VAN OORDT.—*Zeit. Anorg. Chem.*, 1905, **43**, 111; 1905, **44**, 341.
 BERNTHSEN.—“Eighth International Congress of Applied Chemistry.” New York, 1912.
 Abstract, *Journ. Soc. Chem. Ind.*, 1912, **31**, 982.
 DONATH and INDRA.—“Die Oxydation des Ammoniaks zu Salpetersäure und Salpétriger
 Säure,” pp. 54-67. Stuttgart, 1913.
 LUNGE.—“Coal Tar and Ammonia.” Fourth Edition, pt. 2, p. 815.
 KNOX.—“The Fixation of Atmospheric Nitrogen.” 1914.
 NORTON.—“Utilisation of Atmospheric Nitrogen.” 1912.
 CARO.—“Die Stickstofffrage in Deutschland.” 1908. *Zeitsch. Angew. Chem.*, 1910, **23**,
 2412.
 SERPEK.—English Patent 13,086 (1910).
 J. W. RICHARDS.—*Trans. Amer. Electrochem. Soc.*, 1913, **23**, 351.
 FRAENKEL.—*Zeitsch. Elektrochem.*, 1913, **19**, 362.
 S. A. TUCKER.—*Journ. Soc. Chem. Ind.*, 1913, **32**, 1143; *Journ. Ind. and Eng. Chem.*,
 1913, **5**, 191.
 C. TONÍOLO and G. GIAMMARCO.—*Giorn. Chem. Ind. Appl.*, 1933, **15**, 219.
 British Reports of Applied Chem., B., 1933, 60, 188, 306, 463.
 For Compression Plant see the *Chem. and Ind.*, 1929, 591.
 See also United States Patents, 1,844,963, 1,850,732, 1,878,682 (1933).

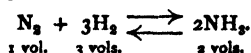
SEVERAL methods of making atmospheric nitrogen unite to form ammonia have been proposed and have been commercially successful.

(1) AMMONIA BY DIRECT UNION OF NITROGEN AND HYDROGEN BY MEANS OF A CATALYST

LITERATURE

- F. HABER and R. LE ROSSIGNOL.—“Technical Preparation of Ammonia from its Elements,” *Zeitschrift für Elektrochemie*, 1913, **19**, 53-72.

Under certain conditions nitrogen directly unites with hydrogen to form ammonia according to the equation:—



Heat evolved according to the equation:—



This equation is reversible, depending upon the equilibrium represented by the expression:—

$$K = \frac{P_{\text{NH}_3}}{P_{\text{N}_2}^{\frac{1}{2}} P_{\text{H}_2}^{\frac{3}{2}}}$$

where P_{NH_3} , P_{N_2} , P_{H_2} represent the partial pressures of the respective gases, NH_3 , N_2 , H_2 and K is the reaction constant.

It will be noticed that 4 vols. of the mixture of nitrogen and hydrogen produce 2 vols. of ammonia, and consequently, as in the case of all gaseous reactions where the products of interaction occupy a smaller volume than the original components, and increase of pressure favours the formation of the products possessing the least volume. Haber and his co-workers found that by employing a very high pressure, about 200 atmospheres, and a temperature of between 500° - 700° C., and by passing the mixture of gases over a catalyst, such as osmium or uranium, the combination of nitrogen with hydrogen proceeded so favourably that from 3-12 per cent. of ammonia was formed in the reacting gases.

It will be seen from the above equation that large amounts of energy are not required for the production of ammonia from its elements, and that, therefore, the manufacture of synthetic ammonia need not be confined to districts where large amounts of cheap water power are available, as is the case with the electrical production of nitric acid, cyanamide, etc.

The Badische Anilin- und Soda-Fabrik have now erected works at Oppan, near Ludwigshafen, for the large scale preparation of synthetic ammonia by this process.

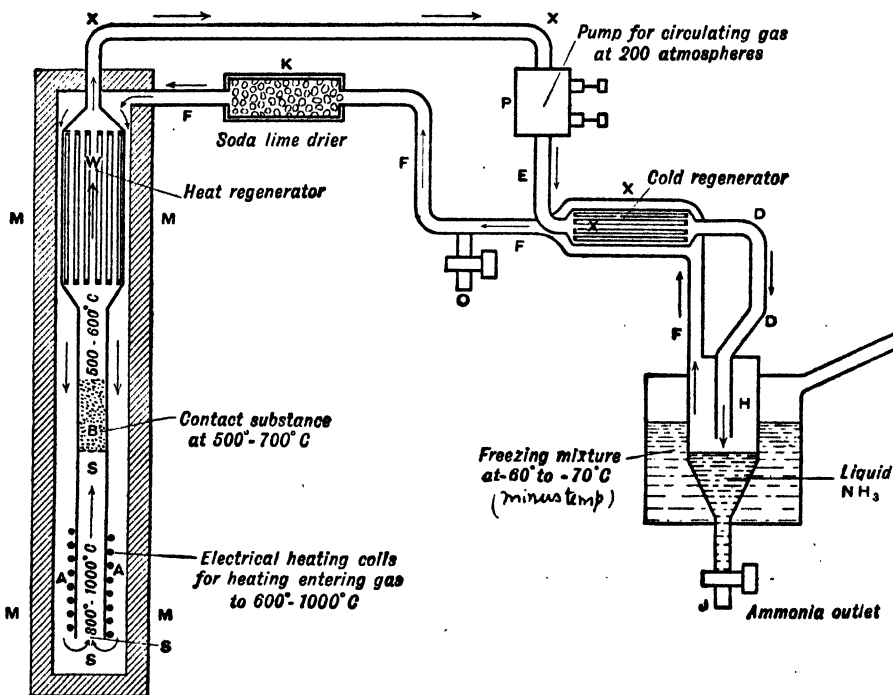


FIG. 1.—The Haber and Le Rossignol Process for Synthetic Ammonia.

Although the details of the plant employed on the large scale have not been published, the details of the experimental plant employed by Haber and Le Rossignol have been described in the above publication.

A diagrammatic sketch of Haber and Le Rossignol's experimental apparatus is given in Fig. 1.

Through the tube F a mixture of 1 vol. nitrogen and 3 vols. of hydrogen under a pressure of 200 atmospheres enters the strong steel vessel MM. After passing over the outer surface of a number of capillary metallic tubes w—which serve as a heat interchanger and regenerator as we will presently explain—the gas passes down the tube as shown, over the surface of an electrical heating coil AA, where the temperature of the gas is increased to 800° - $1,000^{\circ}$ C., then back up an interior from tube SS, over the layer of catalytic substance B, thence through a number of capillary tubes w, out through the tube XX, thence through the compressing pump P, working at 200 atmospheres pressure, thence out through the tube E, through the set of capillary tubes x, and so into the vessel H, which is surrounded by a freezing mixture of solid CO_2 and ether at a temperature of -60° or -70° , which causes the ammonia in the gas to separate in the liquid state, whence it can be drawn off by the cock J. From H the gases pass away by the tube F, over the exterior surface of the system

of capillary tubes *x*, thence after passing over a soda-lime drier *k*, the gas enters *m* as previously described.

The mode of action of the apparatus is as follows:—The cold gas entering *mm* by the pipe *F* is heated by passing over the bundle of capillary tubes *w* conveying the hot gas away from the contact substance *B*. Thus the entering gas is, by the time it has left *w*, preheated to a temperature of 400°-500° C., and in so doing has abstracted practically all the excess heat from the hot gas passing away from *B*, so that this latter, by the time it reaches the pipe *xx*, is practically at atmospheric temperature, while at the same time the entering gas, by the time it reaches the heating coil *A*, is already at a high temperature, so that practically no loss of heat occurs. For this reason *w* is called the "heat regenerator." The hot gas thus entering the tube *ss* is further heated in its passage by the electrical heating coils surrounding the end of the tube *ss* to a temperature of 800°-1,000° C. The hot gas then passes into the contact substance *B*, which is maintained by the hot gas at a temperature of 500°-700° C. Here the formation of ammonia takes place, 3.7 per cent. of the entering nitrogen and hydrogen escaping as NH_3 , along with excess of uncombined nitrogen and hydrogen. The hot mixture of gases from *B* then streams through the series of fine capillary tubes *w*, and in so doing gives up practically all its heat to the cold entering stream of gas coming into the apparatus at *F*. The gaseous mixture, now cooled to ordinary temperatures, passes away through the pipe *xx* into the pump *P*, working at 200 atmospheres, and then passes through the series of metallic capillary tubes *x*. While passing through these it meets with a cold stream of gas at -60° C. coming from the vessel *H*. Consequently the gas in the capillary tubes *xx* parts with its heat to the cold gas coming from *H*, being itself chilled in so doing, and passes out of *x* through the pipe *DD* into *H* at a temperature only slightly above that of the cold gas escaping from *H*. The cold gas passing from *H* up *F* is heated almost up to atmospheric temperature by the capillary tubes *x*, and thus passes away through the drier *k* and enters *mm* at *F* at a temperature only very slightly below atmospheric. For this reason the tubes *x* are called the "cold regenerator."

The gas entering *H* contains 3.7 per cent. of NH_3 , and this condenses in a liquid form at the low temperature (-60° C. to -70° C.) prevailing therein, owing to the surrounding freezing mixture of solid CO_2 and ether. This ammonia can be drawn off in a liquid form by the tap *J*, or, if required in a gaseous form, can be so obtained by opening the outlet valve to a suitable extent.

As the ammonia is withdrawn a fresh supply of nitrogen and hydrogen is added through the valve *O*, so that the operation is a continuous one.

In practice, the very serious engineering operations of working continuously a plant with gas at 200 atmospheres, without leakage, has been got over by carefully turned screw joints, one part of an angle of 16° screwing into another part of an angle of 20°, so that perfectly gas-tight connections were made in this way. For special details of construction the original memoirs should be consulted.

Haber and his co-workers have made numerous experiments on the most suitable catalysts to use as contact substances, describing the results of experiments with cerium and allied metals, manganese, tungsten, uranium, ruthenium, and osmium. The best catalyst proved to be finely divided osmium, but as this substance is limited in quantities and very expensive, it was found that uranium (pieces the size of a pin's head) also acted efficiently.

Thus, in one series of experiments, commercial uranium, broken up with a hammer, was used in a column 4.5 mm. diameter and 3.3.5 cm. long. At 600° C. a vigorous formation of ammonia took place. At 190 atmospheres and with the gas mixture passing through the apparatus at 20 l. per second (measured at atmospheric pressure and temperature) it issued with an ammonia content of 5.8 per cent. by volume.

The nitrogen can be obtained from the atmosphere, either by liquefying it and fractionally distilling it with a Linde or Claude machine, as described in this Volume under "Liquefaction of Gases," or simply by passing air over heated copper. The hydrogen can be obtained industrially by any of the methods discussed in this Volume under "Industrial Hydrogen" (see p. 109).

In 1913 ammonia in the form of commercial 25 per cent. (NH_3) ammonium sulphate possessed a value of 4.75d. per lb. (89 Pf. per kilo), while the nitrogen and hydrogen contained therein may be valued at 1.07d. per lb. (2½ Pf. and 17½ Pf. for the H and N respectively, in 1 kilo of ammonia).

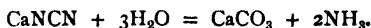
It has been stated that the total costs of manufacturing ammonium sulphate from this synthetic ammonia only amounts to £2. 6s. 6d. per ton, and so the process appears to be the one which has a greater chance of success as regards low cost than any other method yet proposed, especially as the plant can be erected anywhere (see Martin's "Industrial Chemistry," Vol. II.).

Other Processes for Making Synthetic Ammonia from Atmospheric Nitrogen and Hydrogen.—De Lambilly (German Patents, 74,274 and 78,573) passes a mixture of N_2 , steam, H_2 and CO over Pt (or other catalyst) at 80°-130° C., when ammonium formate is formed ($\text{N}_2 + 3\text{H}_2 + 2\text{CO} + 2\text{H}_2\text{O} = 2\text{H}.\text{COONH}_2$). With CO_2 at 40°-60° C. ammonium bicarbonate is formed ($\text{N}_2 + 3\text{H}_2 + 2\text{CO}_2 + 2\text{H}_2\text{O} = 2\text{NH}_4\text{HCO}_3$).

Schlutius (English Patent, 2,200, 1902) passes Dowson gas (39 per cent. CO , 4 per cent. CO_2 , 43 per cent. N_2 , 14 per cent. H_2) and steam over Pt in the presence of a silent electrical discharge. Below 80° NH_3 is produced, above 80° C. ammonium formate.

The reader may also see the patents:—Young, English Patent, 1,700, 1880; Hooper, U.S. Patent, 791,194; Cassel, German Patent, 175,480; Gorianoff, French Patent, 368,585; see also Davies, *Zeit. physical. Chem.*, 64, 657; Briner and Mettler, *C. R.*, 144, 694; Donath and Indra (*loc. cit.*, pp. 54-67) and Lunge, "Coal Tar and Ammonia," Fourth Edition, pt. 2, p. 815, give details of other processes.

(2) **Ammonia from Cyanamide.**—Cyanamide is made by causing atmospheric nitrogen to directly unite with calcium carbide, as described on p. 473. Ammonia is next made from the cyanamide by passing superheated steam over it, when the following change takes place:—



The operation may be carried out as indicated in Fig. 2.

Superheated steam is led in through the pipe A into the chamber B filled with the cyanamide on trays as indicated.

Ammonia is here generated, which may be directly drawn off or else led into acid and fixed.

The crude calcium cyanamide contains, it will be remembered, much carbon in the form of graphite, the substance as put on the market having the approximate composition $\text{CaNCN} + \text{C}$.

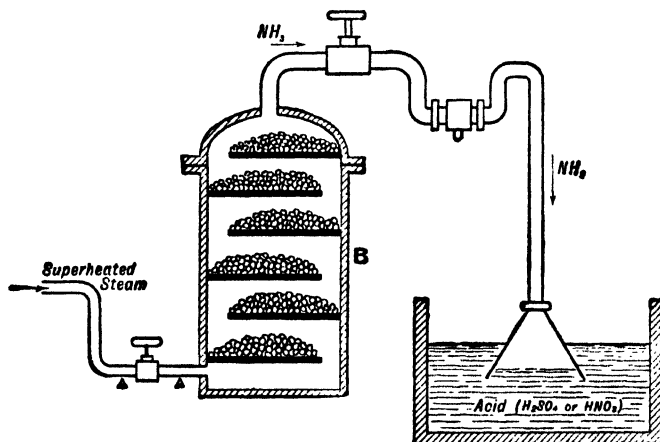


FIG. 2.—Ammonia from Cyanamide.

After treating with steam, as above described, we have the residue of $\text{CaCO}_3 + \text{C}$ left. This may be either worked for graphite (by dissolving the CaCO_3 in acid which leaves the C as graphite unaffected), or the residue may be returned to the lime furnaces, and be there calcined for the production of CaO , the lime thus produced containing one-third the proper amount of free carbon necessary for the production of calcium carbide when returned to the calcium carbide factory ($\text{CaCO}_3 + \text{C} = \text{CaO} + \text{C} + \text{CO}_2$ and $\text{CaO} + 3\text{C} = \text{CaC}_2 + \text{CO}$).

According to J. Louis Foucar, since cyanamide has to be made from calcium carbide and nitrogen, and the calcium carbide in its turn from lime and a plentiful supply of electrical energy, the ammonia made by this process could not, theoretically, be produced as cheaply as the direct synthetic ammonia prepared by direct union of nitrogen and hydrogen. Foucar (private communication) worked out the costs of manufacture of ammonium sulphate from cyanamide as follows:—

Cost of carbide	-	-	-	£3 5 0 per ton.
Cost of nitrogen	-	-	-	0 2 0
Cost of steam	-	-	-	0 0 6
Cost of sulphuric acid	-	-	-	0 16 0
				£4 3 6
Less value of graphite	-	-	-	0 5 6
				£3 18 0 per ton.
Total net cost for materials	-	-	-	0 7 6
Cost for powder (cyanamide only)	-	-	-	
Labour (cyanamide, steaming, etc.), power, repairs, depreciation, rent, taxes, amortisation, salaries of staff, and other charges	-	-	-	0 7 6
				£4 13 0 per ton.

The selling price of ammonium sulphate in England in 1912 was £14 per ton, and the total cost of manufacture from gas liquor was £3 per ton.

(3) **Ammonia from Nitrides.**—A great many proposals have been made to use nitrides, either directly as fertilisers, or to produce ammonia therefrom by the action of superheated steam.

One process actually in use is the **Serpek Process**,¹ in which aluminium nitride, AlN, is used.

Bauxite (a naturally occurring impure hydrated alumina) is heated with coal in an atmosphere of nitrogen at a temperature of 1,700°-1,800° C. in a specially designed electric furnace, when N is absorbed, thus:—



The absorption of N begins at 1,100° C.; at 1,500° C. the absorption is rapid, the velocity increasing up to 1,800°-1,850° C., where almost violent absorption takes place, nearly chemically pure AlN being produced. Above 2,000° the nitride decomposes.

The reaction is strongly endothermic, Fraenkel calculating the heat absorbed in the above reaction to be -243,000 calories, and Richards, -213,220 calories.

According to Richards (*loc. cit.*) two superimposed cylinders, A and B, Fig. 3, which rotate in opposite directions, are used. Powdered bauxite is sent into A at C

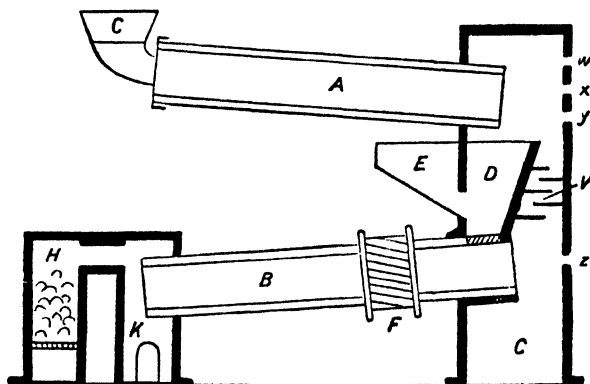


FIG. 3.—The Serpek Process.

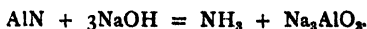
and is calcined in its descent by the hot gases from the reaction going on in the lower cylinder B, and also by the combustion of the CO gas coming from the producer K and evolved in the reaction, this combustion being carried on in the side furnace C, air being admitted by the flues w, x, y, z, and the baffle plates v remove dust from the ascending gases. As the result of this the highly heated bauxite falls into a hopper D, and is there mixed with the requisite amount of carbon by means of the side hopper E. The bauxite and carbon fall into the lower rotating cylinder B (made of iron lined with compressed aluminium nitride), and thence pass into the electric resistance furnace F (made of a series of bars of compressed carbon and AlN, crossing the furnace diametrically or embedded longitudinally in the lining of the furnace), where the mixture is heated to 1,800°-1,900° C., and there meets the nitrogen from the producer-gas plant H (evolving 70 per cent. N₂ + 30 per cent. CO at 400° C.) placed at the lower end of the apparatus.

The nitrogen is absorbed, and the resulting aluminium nitride, in the form of a grey powder, passes on to an air-tight chamber K at the bottom of the apparatus.

¹ For a description of the process see Serpek's patent, English Patent, 13,086, of 1910. Also J. W. Richards, *Met. and Chem. Eng.*, 1913, 11, 137; also *Trans. Amer. Electrochem. Soc.*, 1913, 23, 35; S. A. Tucker, *Journ. Soc. Chem. Ind.*, 1913, 32, 1143; *Journ. Ind. and Eng. Chem.*, 1913, 5, 191; Fraenkel, *Zeitsch. Elektrochem.*, 1913, 19, 362.

The siliceous impurities in the charge are largely volatilised out; consequently, using crude bauxite, the mass contains 26 per cent. N, but using pure alumina, Al_2O_3 , 34 per cent. N can be obtained, corresponding to pure AlN .

The resulting aluminium nitride, AlN , is next decomposed by caustic soda to form ammonia and sodium aluminate:—



From the sodium aluminate thus produced, pure alumina can be obtained in the manner described in Volume II. of this work.

According to the Badische Anilin- u. Soda-Fabrik patents (German Patents, 235,300, 235,765, 235,766, 235,868, 236,395) the elimination of ammonia by alkalis is facilitated by the addition of NaCl and other soluble salts. The decomposition of the AlN can be effected by acids, thus:— $2\text{AlN} + \text{H}_2\text{SO}_4 + 6\text{H}_2\text{O} = 2\text{Al}(\text{OH})_3 + (\text{NH}_4)_2\text{SO}_4$. These patents work out methods for recovering the $\text{Al}(\text{OH})_3$ in a pure state.

The same firm in the German Patent, 243,839, states that the formation of nitride from alumina and coal is greatly accelerated by the addition of 5-10 per cent. of the oxides of certain elements, which themselves yield stable nitrides, among which SiO_2 and the oxides of Ti, Zr, V, Be, Mo, U, Ce, Cr, also silicates, vanadates, etc. Iron oxide does not influence the catalytic action of these oxides.

Aluminium nitride, as prepared by Serpek, is of value both for its combined nitrogen and also for the production of pure alumina for the manufacture of metallic aluminium. Without the sale afforded by this alumina it is doubtful whether the process would be economical, as the alumina would have to be used over and over again. As it stands, however, the alumina produced as a by-product finds a ready sale, and the ammonia simultaneously produced is also a valuable product.

The process is being worked by the Société Générale des Nitrates in France.

OTHER NITRIDES

Various suggestions have been made to use boron nitride, BN , but the high temperature required for its formation and the volatility of the resulting boric acid when the nitride is decomposed by superheated steam for ammonia ($2\text{BN} + 3\text{H}_2\text{O} = 2\text{B}(\text{OH})_3 + 2\text{NH}_3$) have formed insuperable difficulties.

Calcium nitride, Ca_3N_2 , containing 18.9 per cent. of N, and lithium nitride, Li_3N , containing 38.8 per cent. N, are easily prepared from the elements and easily decompose, giving ammonia. Magnesium nitride, Mg_3N_2 , containing 27.7 per cent. N, is likewise easily prepared by heating magnesium in nitrogen gas. When heated in hydrogen it is converted into ammonia and hydride ($\text{Mg}_3\text{N}_2 + 6\text{H}_2 = 2\text{NH}_3 + 3\text{MgH}_2$).

However, none of the processes suggested to employ these reactions as technical sources of ammonia appear to be successful.

The attempts to utilise titanium nitride by heating it in a mixture of nitrogen and hydrogen have also been unsuccessful.

Silicon nitride, Si_3N_4 , containing 42.5 per cent. N, has been suggested for direct use as a fertiliser, as giving results possibly superior to ammonia and cyanamide. The Badische Anilin- und Soda-Fabrik (English Patent, 16,368, of 1910) have patented processes for fixing atmospheric nitrogen by means of silicon nitride. They point out that in preparing silicon-nitrogen compounds from silicic acid, carbon and nitrogen, this operation formerly had to be conducted in the electric furnace owing to the high temperature necessary. They find, however, that it is possible to conduct the reaction at a low temperature if oxides, hydroxides, or salts of metallic elements are added to the mixture of silicic acid and carbon. They also suggest the employment of siliceous materials such as the silicates of iron, aluminium, calcium, etc. Instead of pure nitrogen they employ gaseous mixtures containing N.

They give as an example 75 kilos of finely divided silica mixed with 25 kilos of powdered wood charcoal, and heated in a stream of nitrogen for ten to twelve hours at $1,300^\circ\text{--}1,400^\circ\text{C}$., allowing the product to cool in N gas. When the product is treated with saturated or superheated steam, ammonia is produced.

It is doubtful, however, whether any of these processes are likely to be a commercial success, in view of the successful production of synthetic ammonia directly from the elements.

However, the reader may consult the following patents:—Basset, English Patent, 4,338, 1897; Lyons and Broadwell, U.S. Patent, 816,928; Borchers and Beck, German Patent, 196,323; Roth, German Patent, 197,393; Kaiser, English Patent, 26,803, 1905; Wilson, English Patent, 21,755, 1895; Mehner, English Patents, 12,471, 1895; 2,654, 1897; 28,667, 1903.

SECTION XLIX

THE CYANAMIDE INDUSTRY

BY GEOFFREY MARTIN, D.Sc., Ph.D.

LITERATURE

- F. E. ALLISON.—*Chem. Age*, 1929, 21, 401.
 SCOTT.—*Journ. Roy. Soc. Arts*, 1912, 60, 645.
 CARO.—*Chem. Trade Journ.*, 1909, 44, 621, 641; *Zeit. angew. Chem.*, 1909, 22, 1178.
 FRANK.—*Zeit. angew. Chem.*, 1903, 16, 536; 1905, 18, 1734; 1906, 19, 835; *Journ. Soc. Chem. Ind.*, 1908, 27, 1093; *Trans. Faraday Soc.*, 1908, 4, 99.
 CROSSLEY.—Thorpe's "Dict. of Applied Chem.," Vol. III. (1912), gives an excellent account. See also *The Pharmaceutical Journal and Pharmacist*, 12th March 1910.
 See also British Patents 333,353, 326,117.

Calcium Cyanamide, Nitrolime, Kalkstickstoff, CaN_2C .—Calcium carbide, CaC_2 , which has been manufactured for many years for the production of acetylene gas, unites with nitrogen when heated with it to about $1,000^\circ\text{C}$., forming calcium cyanamide, $\text{CaC}_2 + 2\text{N} = \text{CaN}_2\text{C} + \text{C}$.

It is supposed that a sub-carbide is first formed:—



This calcium cyanamide has been found to be a valuable manure, and, containing as it does some 20 per cent. of available nitrogen against only 15 or 16 per cent. of sodium nitrate, it is now being made on an increasing scale for the manufacture of artificial fertilisers.

Works for the manufacture of the crude mixture of calcium cyanamide and carbon, known as "Nitrolime" or "Kalkstickstoff," have been erected in Norway, Germany, Italy, Austria-Hungary, Switzerland, United States, India, Japan, and other countries. The largest of these works is at Odda, on the Hardanger Fjord, Norway. The Alby United Carbide Co. combined with the Nitrogen Products and Carbide Co. Ltd. to erect new factories at Odda. These factories were supplied with 23,000 H.P. (later increased to 80,000) from the river Tysse.

Although the new industry was only begun on a commercial scale in 1907, the world's output for 1913 is estimated to be 223,600 tons, of which the works of the Nitrogen Products Co. at Odda and Alby, Sweden, are now producing together 88,000 tons per year. However, further developments are going on in Scandinavia, whereby the energy derived from three other water powers in Norway (Aura, Toke, and Blekestad-Bratland), capable of producing 600,000 H.P., of which 100,000 H.P. are now being harnessed for the annual production of 200,000 tons of calcium cyanamide. The Detti-Foss water power in Iceland—capable of generating over 400,000 H.P.—will also be utilised for the production of the same product. The Nitrogen Products and Carbide Co. claim to have at its disposal sufficient water power for an output of 2,000,000 tons of crude calcium cyanamide, which, containing as it does 20 per cent. of combined nitrogen, represents an output of fixed nitrogen equal to the whole present consumption of Chile saltpetre. These immense industrial undertakings are undoubtedly destined to change the face of the world, and entirely alter agricultural conditions of the future.

Process of Manufacture.—The calcium carbide, CaC_2 , used for making the nitrolime is made by heating together in an electric furnace at about $3,000^\circ\text{C}$. a mixture of lime and anthracite coal in the manner described in Volume II. of this work. The molten carbide is tapped off from the furnaces at intervals of forty-five minutes, conveyed on trays to a cooling bed, then it is crushed to a powder in special grinding plant.

Calcium carbide is very hard, and the crushing is performed in several stages. In order that no risks may be run through the liberation and detonation of acetylene gas, the later stages of the crushing process are performed in an atmosphere of nitrogen. The carbide is reduced to the consistency of flour, much resembling cement in appearance.



FIG. 1.—Cyanamide Furnace House at Odda (Nitrogen Products Co.).

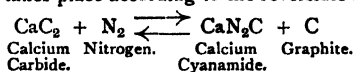
The finely divided carbide is then conveyed to the cyanamide furnaces for treatment with nitrogen gas.

Here the process deviates into two distinct lines of treatment, according to the type of furnace employed. We will first describe the practice at Odda, and then the practice at Westerregeln and Piano d'Orta, as typical of the two lines of treatment

At Odda the crushed carbide is placed in cylindrical vertical retorts lined with fireproof material and covered with sheet iron, and holding 300-500 kilos, as seen in our illustrations, Figs. 1 and 2.

Each furnace has regulating valves and control meters. The nitrogen gas is passed into each furnace under slight pressure, and the retort is heated to about 800° by sending an electric current through carbon rods placed inside, which act as a heating resistance.

Absorption of nitrogen then takes place according to the reversible action:—



The action once started proceeds with the evolution of heat, and so the temperature tends to spontaneously increase. However, the temperature of reaction must not be allowed to increase beyond 1,400° C., otherwise the back action, $\text{CaN}_2\text{C} + \text{C} \longrightarrow \text{CaC}_2 + \text{N}_2$, proceeds to an increasing extent, and the cyanamide formed is thus largely destroyed again. It is essential that the temperature of reaction be kept as low as possible.

After the absorption of nitrogen has begun the heating current is switched off, as the heat developed by the action is sufficient to cause the maintenance of the proper degree of temperature. The absorption of nitrogen proceeds for thirty to forty hours, and is known to be complete by reading the controlling meter.

In this process there is no superheating, and therefore no reversal of the action. The action proceeds from the inside outwards, and thus the material shrinks inwards and away from the furnace walls. Hence the cyanamide formed is easily removed in a solid coke-like block from the furnace (after cooling in a current of air for nine hours), and is then ground to a fine powder in an air-tight grinding mill, stored in a large silo until required, and is then packed in bags with a double lining, and sent into commerce under the name "Nitrolim."

The substance contains 20-22 per cent. N = 57-63 per cent. calcium cyanamide, CaN_2C , 20 per cent. lime, 14 per cent. C as graphite, 7-8 per cent. of silica, iron oxide, and alumina. The substance should be free from unchanged calcium carbide and free lime, CaO .

At Westerregeln, Piano d'Orta, and other Continental works the process of manufacture is quite different.

Here the powdered carbide is placed in horizontal retorts similar to the retorts used in making coal-gas; these are heated **externally** to 800°-1,000° C. by being placed in a gas-fired furnace, while a stream of nitrogen is forced into the retorts for absorption by the carbide.

Fig. 3 shows a rough diagram of the system employed in Piano d'Orta in Italy. Air is driven through retorts A, A, partially filled with copper, and heated in a furnace. The oxygen of the air is absorbed by the copper, forming copper oxide ($\text{Cu} + \text{O} = \text{CuO}$), while the nitrogen passes on into the calcium carbide retort B, B, heated in a furnace as shown. Here the absorption of nitrogen and resulting formation of calcium cyanamide takes place as described. The copper is regenerated by passing producer-gas through the CuO .

Serious difficulties, however, have here been encountered. The absorption of nitrogen commences slowly, but then the temperature suddenly goes up as heat is developed by the action, and, unless great care in working is employed, it may exceed 1,400° C., when a considerable loss of nitrogen in the formed cyanamide occurs owing to the back-action previously discussed.

Moreover, overheating of the walls ensues, and the cyanamide, on cooling, sets to a rock-like mass on the walls of the retorts, and has to be forcibly knocked out. Hence the retorts are subjected to a severe wear and tear.

These difficulties have to some extent been obviated by adding calcium chloride, CaCl_2 (Polzenius), or calcium fluoride, CaF_2 (Carlson), to the crushed carbide, so as to lower the temperature of reaction. With CaCl_2 the temperature of reaction is lowered to 700°-800°, and with CaF_2 the reaction temperature is about 900° C.

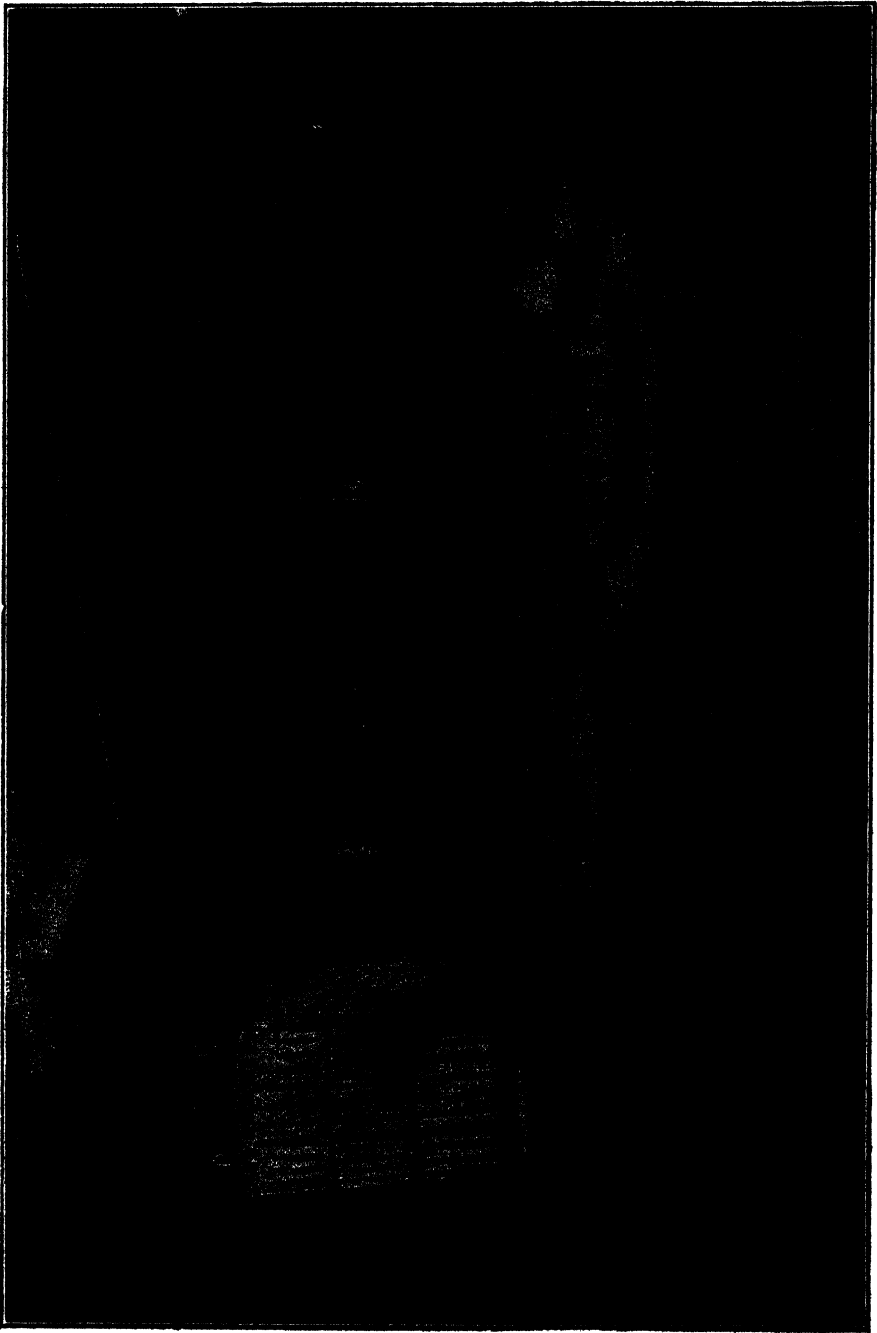


FIG. 2.—Cyanamide Furnaces at Odda, showing Carbon Resistances (Nitrogen Products Co.).

This favourable influence is supposed to be due to the fact that CaCl_2 or CaF_2 mixes with the cyanamide formed on the surface of the carbide, and causes it to fuse at a lower temperature than it would in a pure state. In the absence of these salts the cyanamide forms an impervious layer over the surface of the carbide, and thus prevents the entrance of the nitrogen into the interior of the carbide unless the temperature is about $1,000^\circ \text{C}$. In the presence of CaCl_2 or CaF_2 , however, the melting point of the cyanamide is much lowered; it melts or softens at $700^\circ\text{--}800^\circ \text{C}$., and thus no longer serves as a protecting layer for hindering the absorption of the nitrogen by the interior layers of carbide.

It was supposed that this process would cause an outlet for the now practically waste CaCl_2 produced as a by-product in many chemical operations.

The Gesellschaft für Stickstoffdünger, at Westerregeln, add anything up to 10 per cent. CaCl_2 to the powdered carbide, the absorption temperature of the N being only 700°C . The product, containing 20 per cent. N, 45 per cent. Ca, 19.5 per cent. C, 6.5 per cent. Cl, and 9 per cent. impurities, is put on the market under the name "Stickstoffkalk."

The disadvantage of the presence of CaCl_2 is that the product is hygroscopic, and so cannot be stored easily. It is, therefore, sold principally in spring, but it is stated that the process has been abandoned (1910).

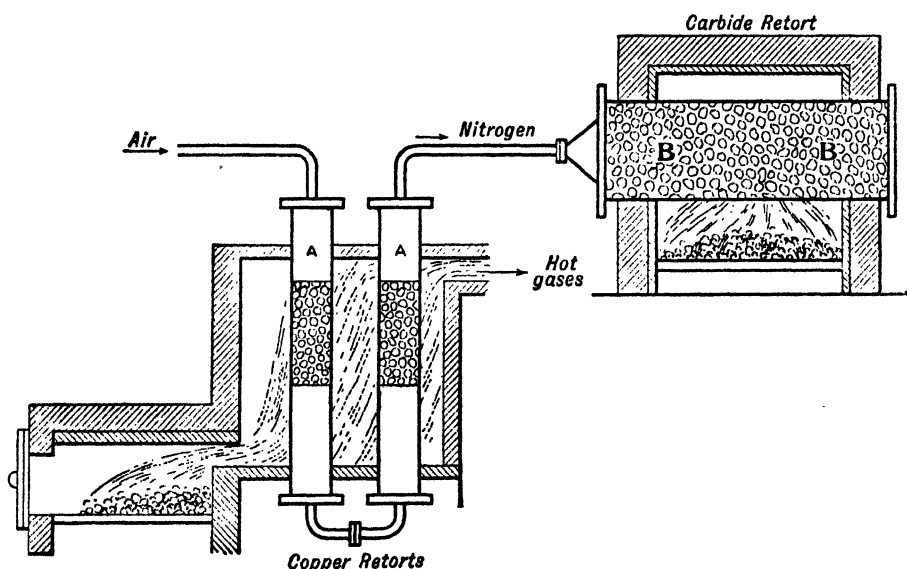


FIG. 3.

The **Nitrogen** required for the manufacture of nitrolime is obtained at Odda by liquefying the atmosphere, and separating the oxygen and nitrogen by fractional distillation.

The Linde plant used at Odda for the purpose is the largest in the world, liquefying 100 tons of air daily, from which about 77 tons of nitrogen are obtained.

The new works at Odda, however, are fitted up with a Claude plant, which is stated to be simpler to work than the Linde.

In some Continental works the nitrogen is produced by passing air over hot copper, which retains the oxygen as copper oxide, and allows the nitrogen to pass on, as explained above. The copper is regenerated by passing water-gas over the treated copper.

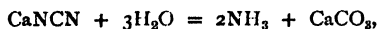
The nitrogen produced must be free from moisture and oxygen. The Linde plant already in use gives 100,000 cub. ft. of nitrogen per hour, containing less than 0.4 per cent. oxygen. In the Claude machines, now installed in the new works at Odda, the nitrogen supplied contains less than 0.1 per cent. O. The presence of moisture would decompose the calcium carbide thus:—



Oxygen would decompose the calcium cyanamide, forming CaCO_3 , thus reducing the percentage of nitrogen in the finished product. CO_2 or CO , if present in the air, would act thus on the carbide :—

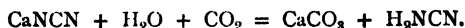


Uses of Calcium Cyanamide.—This body is mainly used as a **nitrogenous manure**. When placed in the soil under suitable conditions its nitrogen is set free in the form of ammonia by means of bacteria. The end results can be expressed by the equation :—

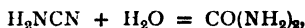


and so it may be used directly as a substitute for ammonium sulphate or Chile saltpetre.

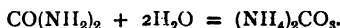
The decomposition of the cyanamide in the soil undoubtedly takes place in stages. Atmospheric CO_2 and moisture first liberate cyanamide, thus :—



The cyanamide is then converted into urea :—



which is speedily transformed by bacterial fermentation into ammonium carbonate :—



This latter is either directly absorbed by the plants, or is first oxidised to nitrate and nitrite by nitrifying organisms in the manner explained in Section XLIV., p. 427 ("Circulation of Nitrogen").

Calcium cyanamide must be applied as a manure below the surface of the soil some time before the seed is sown. It must not be applied to plants actually growing. It is also mixed with Bessemer slag or potassium salts as a component of mixed manures. 150 lbs. per acre, mixed with 100-125 parts of potassium salts, is the mixture most used.

Calcium cyanamide, however, also serves as the basis for the manufacture of many nitrogenous compounds. For example :—

Ammonia, NH_3 , is manufactured from it by treating it with superheated steam ($\text{CaNCN} + 3\text{H}_2\text{O} = \text{CaCO}_3 + 2\text{NH}_3$), see p. 472. The ammonia can be easily combined with nitric acid to form **ammonium nitrate**. Nitric acid itself is now manufactured from the ammonia by oxidising it by **Ostwald's Process** (p. 448). From the ammonium nitrite and nitric acid thus produced, **explosives, dyes**, and other useful nitrogenous substances are now made. The manufacture of **cyanides** from calcium cyanamide is also now an important industry (see p. 490). Sodium cyanide, NaCN , is now produced by fusing calcium cyanamide with common salt, 90-95 per cent. of the cyanamide being converted into sodium cyanide, which is much used for recovery of gold in South Africa, Australia, U.S.A., Mexico, etc. Calcium cyanamide is stated by Clancy (*Metall. Chem. Eng.*, 1910, 8, 608, 623; 1911, 9, 21, 53, 123) to be capable of replacing cyanides in gold extraction.

Dicyandiamide is made in a crystalline form by extracting technical calcium cyanamide with hot water :—



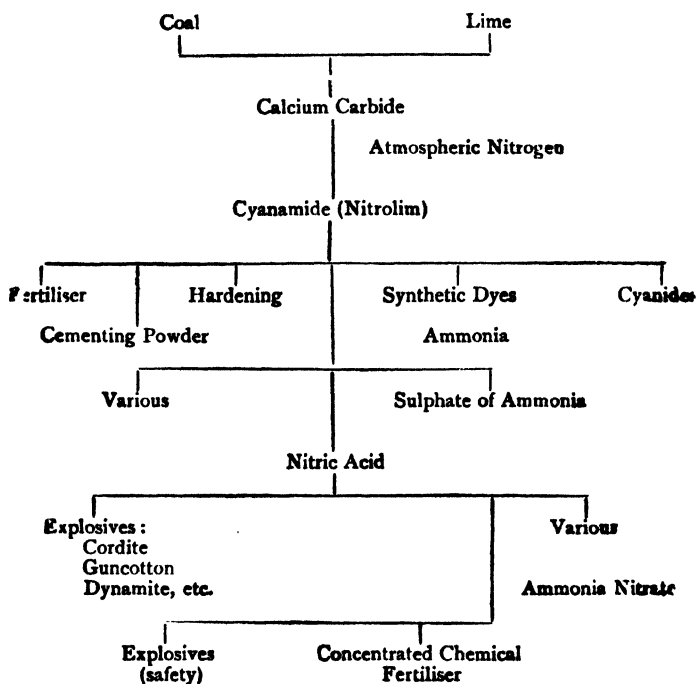
It is used for making organic dyes, also for reducing the temperature of combustion of explosives, since its decomposition produces little heat, and gives a strong pressure owing to it containing 66.6 inert N. Hence the addition of the substance to powders like cordite, which rapidly destroy rifling on account of high temperature of combustion (see **Martin's** "Industrial Chemistry: Organic," under "Explosives").

Urea, $\text{CO}(\text{NH}_2)_2$, **Guanidine**, $\text{C}(\text{NH})(\text{NH}_2)_2$, **nitroguanidine**, etc., are also nitrogenous substances manufactured at Spandau by treating calcium cyanamide with aqueous acids, etc.

Bailey (United States Patent 1,884,509, 1933) manufactures cyanogen chloride and substituted guanidines by the action of chlorine on aqueous hydrocyanic acid.

The body, "ferrodur," used for case hardening and tempering iron and steel, contains nitrolim.

The whole family of nitrogen products may be traced in the following table :—



Statistics.—The following figures are available as regards output of Cyanamide—

1930.	Tons.	1930.	Tons.
Canada	147,782	Poland	82,786
France	68,600	Sweden	20,523
Germany	500,460	Switzerland	15,000
Italy	100,673	Japan	144,658
Norway	49,009		

The world output in 1913 was 48,000 tons. In 1929 it was 1,050,000 tons, and of this 75ⁿ per cent. of the total production was applied directly to the soil, 9 per cent. used in commercial fertilisers, and 11 per cent. used in the production of ammonium phosphate and sulphate, while 5 per cent. was used for ammoniæ production.

SECTION L

THE CYANIDE AND PRUSSIATE INDUSTRY

BY GEOFFREY MARTIN, D.Sc., Ph.D.

LITERATURE

- O. F. LUBATTI.—*Journ. Soc. Chem. Ind.*, 1933, 52, 316.
 C. H. BUCHANAN.—*Chem. et Ind.*, 1932, 28, 1024.
 BERTELSMANN.—“*Technologie der Cyanverbindungen*” (1906).
 LUNGE.—“*Coal Tar and Ammonia*,” 4th Edition.
 T. EWAN.—“*Cyanides*” in Thorpe’s “*Dict. Appl. Chem.*,” Vol. II., 1913.
 BEILBY.—*Journ. Soc. Chem. Ind.*, 1898, 28th Feb.
 CONROY.—*Journ. Soc. Chem. Ind.*, 1899, 18, 432.
 OST.—*Zeit. angew. Chem.*, 1906, 19, 609.
 G. ERLWEIN.—“*Fifth Internat. Kongress angew. Chem.*” Berlin, 1903, I., 646.
 P. E. WILLIAMS.—*Journ. Gas Lighting*, 1st Oct. 1912, p. 31 *et seq.*
 HOFMANN and CO-WORKERS.—*Annalen*, 1904, 337, 1; 1905, 340, 267; 1905, 342, 364.
 D. HATT.—*Chem. et Ind.*, 1932, 28, 777.
 See United States Patents 1,872,923, 1,887,608, 1,884,509; British Patents 395,761, 394,004, 325,860.

Also references and patents in the text.

UNTIL the year 1890 only comparatively small quantities of the very poisonous potassium cyanide, KCN, were made, being used principally in the electroplating industry and in photography.

This use was founded on the fact that KCN possesses the property of dissolving the salts of metals like gold, silver, and nickel, etc., the metal going into solution as a double cyanide. From these solutions the metal can be readily deposited electro-chemically in a coherent layer by making the surface of the object to be coated with the precious metal the negative pole in a solution of the double cyanide.

Up to 1890 the annual output of KCN was about 100 tons, the product being usually prepared by fusing ferrocyanides with alkali.

In 1887 M'Arthur and Forrest took out their patents (English Patents, 14,174, 1887; 10,223, 1888) for using dilute KCN or NaCN solutions for extracting gold from ores, and in a few years from that date the manufacture of cyanides on an industrial scale was well established.

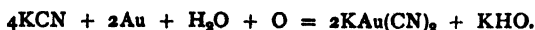
In 1903 about 6,300 tons of cyanide were placed on the market.

In 1910 Great Britain exported of cyanide of sodium or potassium, 7,770 tons, value £633,000. Germany, in 1895, exported 6,280 tons at 1,400 marks per ton.

In 1895 only 120 tons at 3,200 marks were produced. The German production of ferrocyanide of potassium of sodium was in 1895 valued at 361 tons at 1,480 marks. In 1909 this had become 1,450 tons at 870 marks per ton.

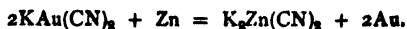
The development of the vast Transvaal gold industry has been mainly dependent upon the discovery that gold can be dissolved out of its ores by treating with dilute cyanide solution. The peculiar formation of “blanket” ore, the small proportion of gold per ton which it contains, the finely divided state of the gold in these ores, as well as the production of “slimes” and “tailings” containing some gold, all combined to render the ordinary methods of gold extraction difficult of application.

When these gold-bearing materials are treated with dilute KCN solution the gold passes into solution, thus:—



The gold thus passes into solution as potassium aurocyanide, $\text{KAu}(\text{CN})_2$.

The gold is next precipitated on zinc according to the equation:—



The maximum effective solution is that containing 0.25 per cent. KCN, solutions containing as little as 0.0005 per cent. KCN having a perceptible solvent action. The quantity of solution used is 33 per cent. of the amount of ore in the charge.

Previous to the introduction of the process into South Africa no tailings had been treated by lixiviation with the KCN solution. The "Robinson" works put up a plant costing £3,000, and made £2,000 per month working profit!

This great success led to the extension of the process to all the gold-bearing countries of the world, such as Australia, New Zealand, India, America, etc. In 1898 the cyanide treatment of Rand "tailings" cost 2s. 3d. to 2s. 9d. per ton, using $\frac{1}{4}$ lb. to $\frac{1}{2}$ lb. of cyanide per ton; this cyanide cost 3d. to 6d. at that date. Since then the cost of the cyanide has considerably decreased. According to Beilby (*Journ. of the Soc. of Chem. Ind.*, 28th Feb. 1898), the total production of gold by the cyanide process in 1897 was 1,215,000 oz. of fine gold. In 1910 the world's output of gold was 23,000,000 oz. of fine gold, 5,750,000 oz. of this (about 25 per cent.) being recovered by the use of cyanide. The value of the cyanide process may be judged from the fact that the value of the cyanide bullion produced by the Rand in 1910 was equal to the whole profit earned by the mines. The actual figures being:—

Yield from cyaniding	:	:	:	:	£11,552,743
Total profit of working	:	:	:	:	£11,567,099

MANUFACTURE OF SODIUM OR POTASSIUM CYANIDE

Potassium cyanide or sodium cyanide is now manufactured by several different sources, viz.:—

1. From ferrocyanide or ferricyanide (prussiate).
2. From ammonia, carbon, and an alkali metal (Na), or alkali salt.
3. From sulphocyanides.
4. From "schlempe," a residue from the refining of beet sugar.
5. From cyanamide (nitrolim).
6. From atmospheric nitrogen.

MANUFACTURE OF CYANIDE FROM FERROCYANIDES (PRUSSIATE)

Previous to the introduction of the gold-cyaniding process almost all the cyanide manufactured was made from sodium or potassium ferrocyanide, which was produced from animal matter, such as dried blood, horns, hoofs, and the residues of slaughter-houses (see under **Ferrocyanides**, p. 491).

When potassium ferrocyanide thus obtained is heated with well-dried potassium carbonate, the following action occurs:—



When this process was employed, potassium cyanide sold at 2s. 6d. per lb. as against 7½d. per lb. in 1911. Only about 20 per cent. of the nitrogen of the animal matter was used, and barely 80 per cent. of the potash, the remainder being lost.

Potassium (or sodium) ferrocyanide is no longer made from refuse animal matter, but is now recovered from gas-works; the recovered ferrocyanide ("prussiate") is largely worked for the manufacture of cyanide by **Erlenmeyer's process of fusing with metallic sodium**, when the following changes take place:—



In this process, first worked between 1890 and 1900, all the cyanogen is recovered in the form of sodium or potassium cyanide, the sodium cyanide being technically of the same value as the potassium cyanide, provided the CN content is the same.

The process is carried out as follows:—In covered iron crucibles, some 30-40 cm. in height, dehydrated potassium ferrocyanide, $\text{K}_4\text{Fe}(\text{CN})_6$, is mixed with the proper amount of metallic sodium in the form of short bars, and the crucible is then heated over a free fire until the contents are completely fused. The molten contents of a number of these crucibles are next poured into an iron crucible, heated by direct fire as before, but provided with a filtering arrangement made of

spongy iron (obtained in the above-mentioned melting process), below which are outlet tubes. The molten cyanide is forced through this filter by means of compressed air and a compressing piston. The filtered cyanide as it flows away from the filtering crucible solidifies to a white crystalline mass. It contains some cyanate, KCNO or NaCNO, along with a little alkali carbonate and free caustic soda or potash. Nevertheless, in practice the cyanide is always valued on the basis of the KCN it contains, and since 75.3 parts of NaCN are technically equivalent to 100 g. KCN, the cyanide can be placed on the market as "100 per cent. KCN" in spite of the presence of these impurities. It is only the CN which counts, technically; whether the CN is united with K or Na is immaterial.

It was this process of cyanide manufacture which created the sodium industry, the sodium used being principally produced by the Castner electrolytic process. The production of metallic sodium is now an integral part of the cyanide industry. It is described in Volume III. of this work, which is devoted to metallurgy.

The use of sodium resulted in the production of a sodium-potassium cyanide, the ratio of sodium to potassium being varied within wide limits. The larger the amount of Na salt present the higher the strength of the cyanide. At first considerable opposition was encountered to the use of a cyanide containing sodium, owing to commercial reasons. It has been shown, however, that sodium cyanide is as effective as potassium cyanide, and is cheaper; consequently, whereas formerly only potassium ferrocyanide, $K_4Fe(CN)_6$, was manufactured, at the present time it has been almost entirely superseded (since 1905) by the cheaper sodium ferrocyanide (prussiate), $Na_4Fe(CN)_6$, which can be obtained very pure, and yields, when fused with metallic sodium as above described, practically pure sodium cyanide, NaCN.

Commercial sodium cyanide, NaCN, containing as it does about 30 per cent. more cyanogen than KCN, can be used in smaller quantities than KCN for producing the same gold-dissolving effect. Moreover, it is stated to be more convenient for making up solutions.

MANUFACTURE OF CYANIDES FROM AMMONIA, CARBON AND ALKALI METAL, OR ALKALI SALT

Several important processes are worked.

Siepermann's Process (see English Patents, 13,697, of 1889; 9,350 and 9,351, of 1900).—One part of sodium carbonate and two parts of charcoal (that is, sufficient charcoal to keep the mass from fusing during the process) are heated to dark redness in the upper part of a vertical iron tube while a current of ammonia gas is sent through the mixture. Potassium cyanate, KCNO, is formed thus:—



The mixture is then allowed to fall to the bottom of the tube, where it is heated to bright redness. The cyanate is decomposed with formation of cyanide:—



The final product is thrown into air-tight vessels, cooled, lixiviated with water, the solution being evaporated *in vacuo* until the KCN crystallises out. KCN is soluble with difficulty in the presence of much KOH or K_2CO_3 , and crystallises out before these salts in the form of anhydrous crystals. As first made the KCN was a damp deliquescent mass, which had to be fused with the product of the ferrocyanide process. The working of the process is difficult. It has been worked at Stassfurt since 1892.

Beilby Process (see English Patent, 4,820, of 1901).—The principle is much the same as the **Siepermann Process**, but differs in important details.

Much less carbon is used, so that at the end only slight excess remains. The charcoal is added gradually during the operation, so that the material is always present as a molten liquid through which the ammonia gas is forced under a slight pressure, when the following action takes place:—



The final molten product is filtered from the small excess of unchanged charcoal, and thus a white saleable product is directly obtained without the difficulties of lixiviation. However, since the melting point of the pure potassium carbonate is inconveniently high (about 890° C.), ready-made cyanide is added to it in order to reduce the temperature of fusion.

The Beilby process has been worked since 1892 by the Cassel Gold Extracting Co. at Glasgow, and has achieved remarkable success.

In 1899 Beilby's process was estimated to supply fully 50 per cent. of the world's output of high-strength cyanide.

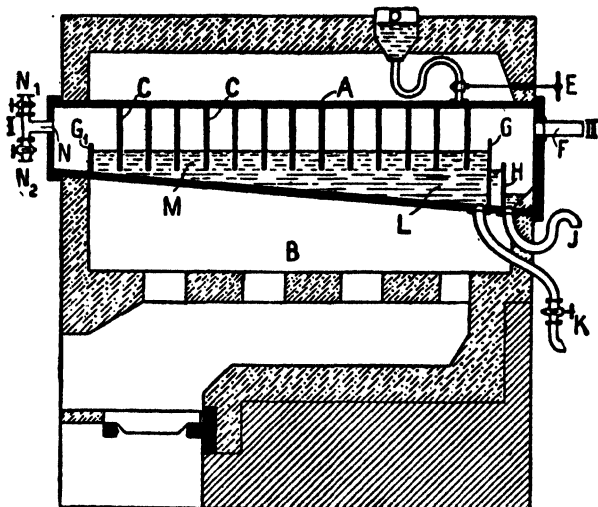


FIG. 1.—Castner's Sodamide Furnace (Longitudinal Section).

The Castner Process (see English Patents, 12,219, of 1894; 21,732, of 1894. See also the German Patents, 117,623, 124,977, 1900; 126,241, 1900; 148,045, 1901).—One of the most important syntheses of cyanide from ammonia was successfully worked on the large scale by the **Frankfurter Scheideanstalt** in 1900, the process having been worked out by H. Y. Castner some years

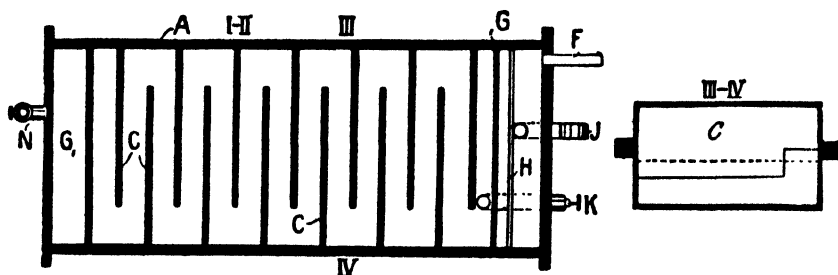
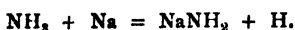
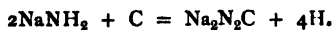


FIG. 2.—Castner's Sodamide Furnace (Horizontal Section).

previously. Dry ammonia gas led over molten sodium in the absence of air yields sodamide, NaNH_2 , as a crystalline product, thus:—



On adding to the fused sodamide some powdered charcoal or coal, sodium cyanamide, $\text{Na}_2\text{N}_2\text{C}$, is formed, thus:—



At a still higher temperature the excess of carbon reacts with the cyanamide to form cyanide, thus:—



Acetylene gas (German Patent, 149,678, 1901) can be used instead of carbon as the reducing agent. Like the Beilby process, the final product is a fused mass containing very small quantities of solid impurities, which are easily removed by filtration. The operations involved are simple, but the temperatures employed at each stage of manufacture must be carefully regulated. The process is carried out as follows:—

Into an iron crucible heated to 500° C. some 70 kg. of wood charcoal is discharged, and the whole is heated in a slow stream of ammonia gas. Next 115 kg. of metallic sodium is added to the crucible, the current of ammonia is increased, and the temperature is raised to 600° C. until all the sodium is converted into sodamide. The temperature is finally increased to 800° C., when the carbon acts on the sodamide and converts it into cyanide, with intermediate formation of sodium cyanamide, as above explained. The process proceeds quantitatively, and the final molten cyanide is poured off and filtered while still in a fluid condition, and cast in iron moulds. It then forms pure white cakes, containing 97.5-98 per cent. NaCN (equivalent to 128-130 per cent. KCN).

Figs. 1 and 2 show Castner's sodamide furnace. It consists of an iron retort A, the upper part of which is provided with a series of vertical baffle plates C, arranged as indicated. The retorts are heated to 300°-400° C., ammonia entering at N and molten metallic sodium at D, while the fused fuel products can be run off by K.

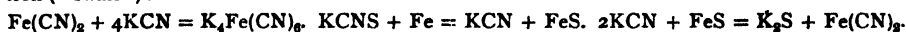
This process, going hand in hand with the fall in the price of metallic sodium, caused an enormous reduction in the price of cyanide from £160 per ton in 1895 to only £70 per ton in 1909. No doubt, in consequence of the production of cheap synthetic ammonia (see p. 469), a further fall in price of cyanide may be anticipated.

MANUFACTURE OF CYANIDE FROM SULPHOCYANIDES

Many attempts to produce cyanides directly from sulphocyanides without the intermediate production of ferrocyanides have been proposed, and some have been worked on the industrial scale, without, however, producing more than a small amount of the total cyanide.

Playfair, in 1890 (English Patent, 7,764, of 1890; see also *Journ. Soc. Chem. Ind.*, **II**, 14, 1892; Conroy, *ibid.*, **15**, 8, 1896), found that fusing at 400° C. lead or zinc with sulphocyanide abstracted the sulphur, leaving cyanide, $\text{NaCNS} + \text{Pb} = \text{NaCN} + \text{PbS}$.

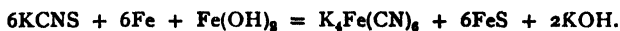
Ferrocyanide (prussiate) was produced from sulphocyanide by treating with finely divided iron ("swarf") :—



The usual process was to heat the sulphocyanide in retorts to a dull red heat, cool in absence of air, and extract the product with water in the retorts themselves, so that contact with air, and subsequent oxidation, are thus entirely avoided.

This process, or some modification, has repeatedly been worked since 1860, when Gelis took out his patent (English Patent, 1,816, of 1860). See also the following patents :—English Patents, 1,148, 1878; 1,359, 1879; 1,261, 1881; 5,830, 1894. The British Cyanide Co. have worked the process at Oldbury since 1894.

A different method of work is suggested in the Patent, 361, 1896, where copper is used instead of iron. In the German Patent, 32,892, of 1882, KCNS is heated with iron filings, ferrous hydroxide, and water to 110°-120° :—



Raschen, in 1895 (see English Patents, 10,476, 1895; 10,956, 1895; 21,678, 1895; 19,767, 1898, 12,180, 1900; see also Conroy, *Journ. Soc. Chem. Ind.*, 1899, **18**, 432), invented a daring method of converting sulphocyanide into cyanide, which was worked by the United Alkali Co. A 15 per cent. NaCNS solution flows into boiling dilute HNO_3 , when HCN and NO are formed thus :—



The hydrocyanic acid gas, together with the nitric oxide, is passed through alkali, whereby all the HCN is absorbed as alkaline cyanide, and is recovered by evaporating. The nitric oxide passes forward, mixed with air, through towers

packed with flints down which water trickles. It is thus converted into nitric acid once more, and is thus used again.

The corrosive natures of the solutions employed, combined with the enormous volumes of highly poisonous gas to be dealt with, presented engineering problems of great difficulty which, however, were successfully overcome. The sulphocyanide was produced synthetically from carbon bisulphide and ammonia.

It should be noted that sulphocyanides can be directly reduced to cyanides by treating with hydrogen at a dull red heat:—



Seventy per cent. of the N is obtained as cyanide, and 20 per cent. as HCN gas. See Playfair, *Journ. Soc. Chem. Ind.*, 1892, II, 14; Conroy, Heslop, and Shores, *loc. cit.*, 1901, 20, 320.

MANUFACTURE OF CYANIDES FROM "SCHLEMPE"

Bueb of Dessau has introduced a successful process for extracting cyanide by heating "schlempe," a waste product of beetroot sugar manufacture (Martin's "Industrial Chemistry: Organic").

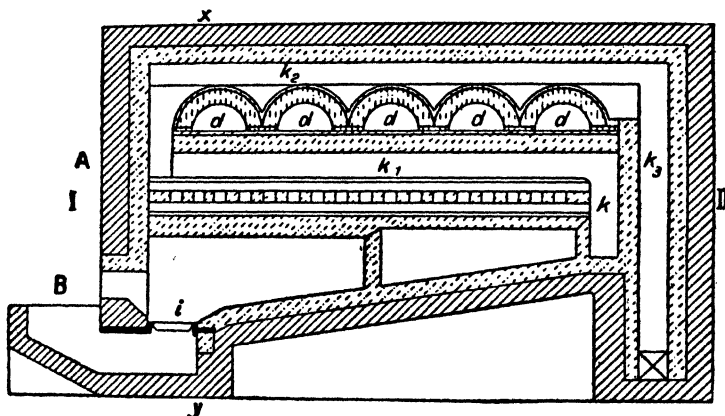


FIG. 3.

The beet juice is clarified, and as much as possible of the crystalline sugar is separated by evaporation in vacuum pans and crystallisation. There remains a thick, viscid, highly coloured, and strongly smelling liquid, still containing 50 per cent. sugar, 20 per cent. organic impurities, 10 per cent. salts, and 20 per cent. water. This is beet sugar molasses. To extract more sugar from it the molasses is treated with alkaline earths, when the sugar combines with the base to form feeble salts, known as "sucrates," which crystallise in well-defined crystals, and are easily separated from the adhering molasses. The sugar is set free from the sucrates by treating with carbon dioxide gas in excess of water, or simple excess of water, the alkaline earth separating from the sugar as an insoluble precipitate. The brown liquid from which the sugar has been separated contains all the impurities of the original beet juice, together with much potash and other salts. It is called "schlempe," and contains about 4 per cent. of nitrogen.

A few years ago this schlempe was simply burnt in furnaces so as to obtain the potash salts in the form of a residue known as "schlempe kohle," all the nitrogen being lost.

Vincent in France, about 1878, attempted to utilise and recover the nitrogen at a red heat, when ammonia, methylamines, methyl alcohols, and gases were obtained. The manufacture of the methylamines was abandoned in 1881 for want of a market.

In 1898, however, Bueb (see English Patents, 7,171, 1895; 26,259, 1898) introduced his process of working the schlempe for cyanide and ammonia in a molasses refinery at Dessau, and the process is now worked in a great many factories

The schlempe, concentrated to 1.4 sp. gr., is run into earthenware retorts, and subjected to dry destructive distillation.

The gases which escape, consisting of CO_2 , CO , H , CH_4 , NH_3 , N_2 , and much trimethylamine, $\text{N}(\text{CH}_3)_3$ (the latter being derived from betaine, $\text{HO.N}(\text{CH}_3)_3 \text{CH}_2\text{COOH}$, contained in the schlempe), do not at this stage contain any cyanide. However, when these gases are passed into "superheaters," consisting of cylindrical chambers filled with brick chequer-work maintained at a red heat (about $1,000^\circ \text{C}$.), hydrocyanic acid is obtained by direct decomposition of the methylamine, thus:—



The superheating of the gases must not last long, as HCN is unstable and the yield would soon diminish. As a rule, two chambers are used alternately, one being heated while the gases from the retort are passing through the other.

Figs. 3, 4, 5 show Bueb's plant. d, d, d are the schlempe retorts, which are heated to $700^\circ\text{--}800^\circ \text{C}$. by the furnace gases passing through the flues k_1, k_2, k . The superheater lies beneath the retorts as indicated, and is heated to about $1,000^\circ \text{C}$. by the furnace gases. The charge for each retort consists of 180 kg. of schlempe, and the distillation takes three to four hours.

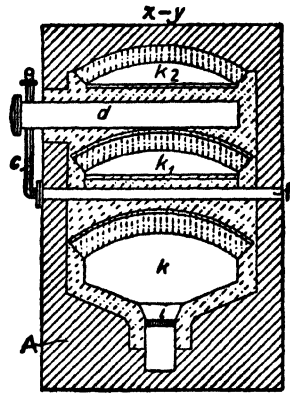


FIG. 4.

The "cyanised" gas leaving the decomposition chambers, containing 10 per cent. HCN and 5-8 per cent. NH_3 by volume, passes through a series of coolers, and then into dilute sulphuric acid, where the ammonia, pyridine, and similar bases are absorbed.

Next they pass through a "cyanide absorber," where the HCN is absorbed in water, and, after treating with NaOH , is obtained as a concentrated solution of NaCN .

The combustible gases escaping this treatment are burnt under the retorts, and so are used for heating purposes. All the retorts and leading tubes are worked under a somewhat diminished pressure, so that no poisonous gases escape into the air. The issuing gas is tested for traces of HCN by passing through an NaOH solution to which a little FeSO_4 has been added, when the slightest trace of HCN is revealed by a precipitate of Prussian blue.

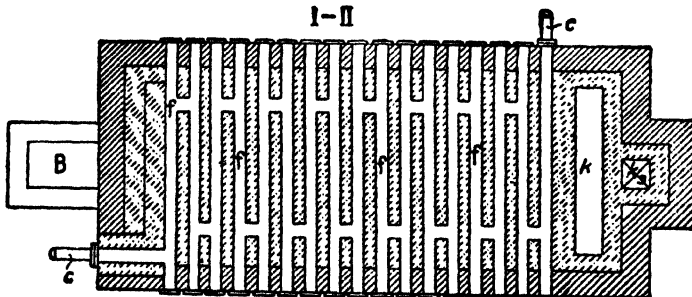


FIG. 5.

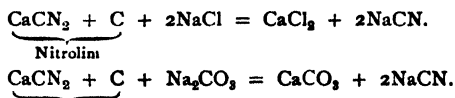
The concentrated aqueous solution of NaCN , obtained, as above described, as a weakly alkaline solution, is evaporated in vacuum vessels, and allowed to crystallise in a nodular form, a temperature above 30°C . being essential, as under this temperature the NaCN separates as $\text{NaCN} \cdot 2\text{H}_2\text{O}$. The crystals are centrifuged, dried, and pressed to hard cakes, containing sodium cyanide equivalent to 120-125 per cent. KCN .

About 35 per cent. of the N in the schlempe is thus recovered as cyanide, 25 per cent. as NH_3 , while 40 per cent. is lost in the form of nitrogen gas.

Ost (see *Zeit. angew. Chem.*, 1906, 19, 609) calculates that from the 13,000,000 tons of beetroot annually worked in Germany for sugar, about 10,000 tons of KCN would be obtainable from the schlempe by Bueb's process. Otherwise the N in schlempe has no commercial value.

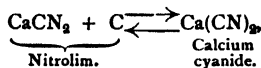
MANUFACTURE OF CYANIDES FROM CALCIUM CYANAMIDE (CaCN_2)

When the mixture of calcium cyanamide and carbon ($\text{CaCN}_2 + \text{C}$), which is known commercially as **nitrolim** or **kalkstickstoff** (p. 475), is fused either with salt, NaCl, or sodium carbonate, Na_2CO_3 , it is converted to the extent of 90-95 per cent. into sodium cyanide, NaCN, thus:—



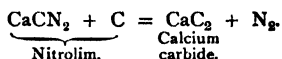
In practice, salt is employed for fusion; the product, containing about 30 per cent. of NaCN, can be used directly for gold extraction. When pure NaCN is required the fused mixture is decomposed by acids and the liberated HCN absorbed in NaOH.

The formation of cyanide from cyanamide is reversible:—

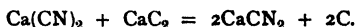


so that special precautions have to be adopted to prevent reformation of cyanamide after complete fusion.

Moreover, at the temperature of fusion the cyanamide may be partially reconverted into calcium carbide with loss of nitrogen by the reaction:—



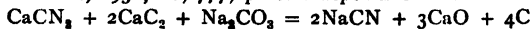
The liberated carbide then destroys some cyanide by reconvertng it into cyanamide, thus:—



All these side reactions tend to diminish the yield of cyanide. Technically these difficulties are stated to have been overcome by "using appropriate appliances for melting and cooling the materials" (although no details have been published), and the conversion of cyanamide into cyanide is stated to be practically quantitative.

The Nitrogen Products Co. state that they use metallic sodium in the manufacture of cyanide from cyanamide.

D. Hatt (*Chem. et Ind.*, 1932, 28, 777) process depends on the exothermic reaction:—



which occurs at 450-500° C.

CYANIDES FROM ATMOSPHERIC NITROGEN

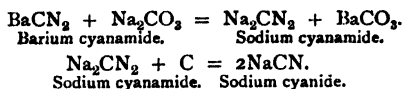
A great many attempts have been made to manufacture cyanides directly from atmospheric nitrogen, and no doubt a large industry may ultimately result from these attempts.

Possoz and Boissière's process (English Patent, 9,985, 1843) consists in soaking wood charcoal in KOH, drying and heating to bright redness in retorts through which a mixture of nitrogen and CO_2 and CO gas (furnace gas) was passed. Nitrogen was taken up, 50 per cent. of the alkali in the charcoal being converted into cyanide, which was finally extracted by lixiviation. The process was not a commercial success.

Later, in 1860, Marqueritte and De Sourdeval (English Patent, 1,171, 1860) attempted to use barium oxide and carbon for absorbing nitrogen, and Mond (English Patent, 433, 1882) worked up a process in detail, Ba(CN)_2 being formed best at a temperature of 1,400° C. Readman (English Patent, 6,621, 1894), using the same materials, but with electrical heating, worked the process at the Scottish Cyanide Co. works between 1899 and 1907, but although much cyanide was produced, the venture was not commercially successful.

Frank and Caro (English Patent, 15,066, 1895) and Wilson (English Patent, 21,997, 1895) found that the carbides of the alkaline earths absorb nitrogen, and attempts have been made to manufacture cyanides from the product.

Finely divided barium carbide, heated at 700° C. in nitrogen gas, takes up 11 per cent. of N, 30 per cent. of which is fixed as barium cyanide, $\text{Ba}(\text{CN})_2$, the rest being present as barium cyanamide, BaN_2C . The material is heated with dry Na_2CO_3 and C., when the cyanamide is converted into cyanide, the change being, according to Dreschel :—



The product is extracted with water, the cyanide is converted into ferrocyanide, fused with sodium, and 86 per cent. of the fixed nitrogen is thus converted into saleable sodium cyanide. The process was not commercially successful.

FERROCYANIDES (PRUSSIATES)

Potassium Ferrocyanide, $\text{K}_4\text{Fe}(\text{CN})_6 + 3\text{H}_2\text{O}$, and **Sodium Ferrocyanide**, $\text{Na}_4\text{Fe}(\text{CN})_6 + 12\text{H}_2\text{O}$, both crystallise in large yellow crystals, are moderately soluble in cold water, very soluble in hot, and possess the valuable property of not being poisonous. They are completely dehydrated above 100° C., and decompose at red heat, forming KCN, C, and Fe, N escaping.

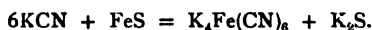
Solubility of $\text{K}_4\text{Fe}(\text{CN})_6$.—100 parts water dissolve (Étard, *Ann. Chem. Phys.*, 1894 [7], 2, 546) :—

Temperature°	0°	20°	40°	60°	75°	80°	89°	98°	157° C.
Grams $\text{K}_4\text{Fe}(\text{CN})_6$	14.5	24.5	36	49.5	64	70	72	74	88

Solubility of $\text{Na}_4\text{Fe}(\text{CN})_6$.—100 parts water dissolve (Conroy, *Journ. Soc. Chem. Ind.*, 1898, 17, 103) :—

Temperature°	20°	30°	40°	50°	60°	70°	80°	90°	100° C.
Grams $\text{Na}_4\text{Fe}(\text{CN})_6$	17.9	23.5	29	35.5	42.5	51.5	59.2	61	63

Ferrocyanides are easily produced when solutions of potassium or sodium cyanides are brought into contact with ferrous hydrate or ferrous sulphide :—



Old Process of Manufacture.—This is practically obsolete, although a little ferrocyanide is still produced therefrom.

Into iron crucibles containing molten potash, scraps of nitrogenous animal matter, such as horns, hoofs, hair, wool, etc., are thrown. KCN is thus formed. Into the mass iron filings are introduced, which at once unite with the organic sulphur present to form FeS. This iron sulphide then unites with the KCN to form ferrocyanide, as explained above.

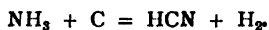
The mass is extracted with water, the ferrocyanide going into solution, and being finally recovered by crystallisation. The mother liquors are used over again.

Only a poor yield is thus obtained. The residue left after lixiviation is a black mass, possessing powerful decolorising properties; it is used for decolorising paraffin and ceresin wax. In fact, the manufacture of the "animal black charcoal" is at present the main object of the industry.

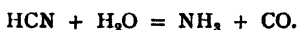
Modern Process for Ferrocyanide Manufacture from Coal-Gas.—

Practically all the ferrocyanide of to-day is recovered from coal-gas. 100 kg. of coal yield on destructive distillation some 30-40 g. of hydrocyanic acid gas, HCN. In 100 volumes of unpurified coal-gas there are 0.1-0.2 per cent. by volume of HCN gas. In general, of the 1-2 per cent. N found in coal, some 15 per cent. is converted into NH_3 , 2½ per cent. as HCN, and 48 per cent. remains behind in the coke. The rest of the N escapes as such. The exact amount of HCN produced depends upon many factors, such as the moisture in the coal (which acts unfavourably), the rapidity and length of heating, etc. Rapid heating and a high temperature favours the formation of HCN.

The coal-gas, as it leaves the retorts, contains the whole of its cyanogen as HCN, which is produced by the action of ammonia on red-hot carbon :—



Now, at a high temperature, steam reacts with HCN, and reconverts it into NH_3 , thus :—



(See Carpenter and Linder, *Journ. Soc. Chem. Ind.*, 1905, 24, 63.) Consequently, moisture in the coal diminishes the yield of cyanide, and increases that of ammonia.

This is the reason why Mond gas and the gas from coke ovens (where much moisture is present) always contain less HCN than ordinary coal-gas.

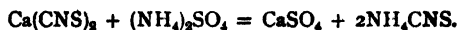
In general, the gas from coal-gas plants contains more HCN than the gas from coke ovens ; very little HCN occurs in Mond gas.

Consequently the HCN is principally recovered in coal-gas plant, not in coke ovens, as it scarcely pays in the latter case.

There are a great many different methods of treating the gas for cyanide, but we may roughly divide them into two main processes :—

- (1) The old **dry process**, whereby the gas is simultaneously freed both from HCN and H_2S by passing through a dry mass of spent iron oxide (see under **Illuminating Gas** in **Martin's** "Industrial Chemistry: Organic").
- (2) The **Bueb's wet process**, whereby the gas is scrubbed with a concentrated ferrous sulphate solution (see **Martin's** "Industrial Chemistry: Organic").

(1) **Dry Process of Prussiate Recovery from Coal-Gas.**—The spent oxide, as it comes from the gas works, contains 35-50 per cent. free sulphur, 10-15 per cent. cyanide (in the form of Prussian blue), calculated at present as crystallised ferrocyanide, 1-5 per cent. ammonium sulphocyanide, NH_4CNS , and 1-7 per cent. ammonium sulphate. The substance is valued technically on the cyanogen contents. The mass is usually extracted with water, whereby the NH_4CNS is obtained, together with ammonium sulphate. Sometimes the NH_4CNS is recovered by fractional crystallisation from the dissolved ammonium sulphate, but where this separation is difficult the solution is simply boiled with lime ; the ammonia gas is thus driven out and collected as described under ammonia. The solution is filtered from depositing calcium sulphate, CaSO_4 , and it then contains the soluble calcium sulphocyanide, $\text{Ca}(\text{CNS})_2$. This is treated with ammonium sulphate and converted into ammonium sulphocyanide, thus :—



The CaSO_4 separates out and leaves the sulphocyanides in solution. Sometimes, however, the sulphocyanide is precipitated in the form of the insoluble copper sulphocyanide, CuCNS .

The mass remaining after lixiviating with water is usually treated by Kunheim's process of heating with slaked lime, when all the iron cyanide present is transformed into the soluble calcium ferrocyanide, $\text{Ca}_2\text{Fe}(\text{CN})_6$. The clear filtered solution of calcium ferrocyanide is now treated with KCl , when the difficultly soluble calcium potassium, $\text{K}_2\text{CaFe}(\text{CN})_6$, separates in the form of small crystals. The equivalent amount of potassium carbonate, K_2CO_3 , is added to these, and thus we get formed insoluble CaCO_3 and the soluble potassium ferrocyanide, $\text{K}_4\text{Fe}(\text{CN})_6$. The solution, after filtration, is evaporated, and the potassium ferrocyanide recovered by crystallisation.

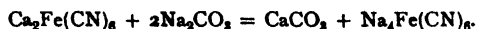
The cyanide-free residue, containing much free sulphur, is sold to sulphuric acid manufacturers, who burn the mass (see **Sulphuric Acid** in this Volume), and the SO_2 escaping is used for the manufacture of sulphuric acid.

Between the years 1885 and 1895 the spent oxide of gas works was the principal source of prussiate, but since 1895 the more efficient wet methods of recovering HCN have been introduced by Bueb, and so the importance of the process has diminished.

In general, when gas is purified by the old process of ammonia scrubbers and iron oxide purifiers, about 33 per cent. of the HCN condenses with the ammonia, and only 50-70 per cent. in the iron oxide purifiers, the rest of the HCN passing away with the coal-gas, causing corrosion of the gas holders and meters.

With the more efficient wet processes of cyanogen recovery, whether by **Bueb's process** (below) or by the **sulphocyanide process** (p. 495), practically all the HCN is removed from the coal gas and recovered.

(2) **Bueb's Wet Process of Cyanide Recovery from Coal-Gas.**—In this process the coal-gas, after leaving the retorts and after the deposition of tar, is passed through a saturated solution of ferrous sulphate, FeSO_4 (see English Patent, 9,075, 1898). Over 98 per cent. of the HCN gas is removed from the coal-gas (more than three times the amount withdrawn by the "dry process") in the form of a sludge of prussiate, consisting essentially of the insoluble ammonium ferrocyanide, $(\text{NH}_4)_6\text{Fe}(\text{Fe}(\text{CN})_6)_2$, or $2\text{NH}_4\text{CN} + \text{Fe}(\text{CN})_2$, together with some soluble ammonium ferrocyanide, much ammonium sulphate, some ammonium carbonate, and some iron sulphide. The sludge usually contains 15-20 per cent. cyanogen, calculated as being present in the form of crystallised potassium ferrocyanide, $\text{K}_4\text{Fe}(\text{CN})_6 \cdot 3\text{H}_2\text{O}$. The mud is boiled, whereby the soluble cyanide interacts with the FeS present, and is converted into the insoluble ferroammonium cyanide, $2\text{NH}_4\text{CN} \cdot \text{Fe}(\text{CN})_2$. Next the mass is filter-pressed; the liquid, containing much ammonium sulphate, is worked up separately for NH_3 . The mass of insoluble cyanide remaining in the press is heated with lime (NH_3 again escaping and being collected), whereby the soluble calcium ferrocyanide, $\text{Ca}_2\text{Fe}(\text{CN})_6$, is formed. This is then treated with the equivalent amount of sodium carbonate, Na_2CO_3 , whereby sodium ferrocyanide, $\text{Na}_4\text{Fe}(\text{CN})_6$, is formed:—



The calcium carbonate is filtered off and the clear solution is evaporated for $\text{Na}_4\text{Fe}(\text{CN})_6$.

By Bueb's process it is possible to directly manufacture sodium ferrocyanide. This is owing to the purity of the calcium ferrocyanide solution. In the case of the spent oxide process, previously described, it is not practical to work the cyanides in the mass directly for sodium ferrocyanide. The spent oxide contains so many impurities that in practice the insoluble $\text{K}_2\text{CaFe}(\text{CN})_6$ is always first prepared (an analogous sparingly soluble sodium salt, $\text{Na}_2\text{CaFe}(\text{CN})_6$, does not exist), which is then converted into $\text{K}_4\text{Fe}(\text{CN})_6$ by treating with K_2CO_3 .

Potassium Ferricyanide, $\text{K}_3\text{Fe}(\text{CN})_6$, or $3\text{KCN} \cdot \text{Fe}(\text{CN})_2$, contains ferric iron. It is prepared by oxidising a solution of potassium ferrocyanide, $\text{K}_4\text{Fe}(\text{CN})_6$, ($4\text{KCN} \cdot \text{Fe}(\text{CN})_2$), by means of chlorine ($2\text{K}_4\text{Fe}(\text{CN})_6 + \text{Cl}_2 = 2\text{K}_3\text{Fe}(\text{CN})_6 + 2\text{KCl}$), or by electrolysis in the presence of some calcium salt, the oxygen coming off at the anode serving as the oxidising agent. The substance crystallises as deep red monoclinic crystals; 100 g. of water dissolve 36 parts of salt at 10°C ., 75.5 at 100°C .

The substance is used as an ordinary agent in dyeing. It also finds some application in the production of blue prints of engineering and other drawings. Paper is coated with a solution of ferric ammonium citrate, or oxalate, and is then exposed to light beneath the transparent drawing. When the light falls on the surface the ferric iron is reduced to the ferrous state. On immersing the print in a solution of potassium ferrocyanide a deposit of Prussian blue is formed on the parts exposed to light, the shaded parts appearing white.

Prussian Blue (Berlin Blue) is the fine mineral colour containing both ferrous and ferric iron united with the cyanogen radicles. It has been on the market since 1700. Together with ultramarine and the coal-tar blues it is still much used for the manufacture of paint, for paper and cloth printing, etc. For the latter purpose it is often produced on the fibre itself by imprinting with potassium ferrocyanide, followed by steaming (see **Martin's "Industrial Chemistry: Organic"**).

Prussian blue is an important colour, since it is fast towards light and acids. Towards bases, however, it is not so fast. Tissues dyed with Prussian blue gradually lose their colour in sunlight, but regain it in the dark. When heated to 170°C . in air it glows and burns away to a brown residue of iron oxide.

Chlorine turns a suspension of Prussian blue in water greenish, but the blue colour is restored by washing with water.

Prussian blue is usually regarded as **Ferric ferrocyanide**, $\text{Fe}''_4(\text{Fe}''(\text{CN})_6)_3$, or $3\text{Fe}(\text{CN})_{24}\text{Fe}(\text{CN})_6$, or $\text{Fe}_7(\text{CN})_{18}$. The dry substance contains water (which cannot be driven off without decomposition), corresponding approximately to $\text{Fe}_7(\text{CN})_{18}10\text{H}_2\text{O}$.

There is little doubt, however, that the commercial Prussian blue is really a mixture of several different substances, all possessing a blue colour (see Hofmann, Heine, and Hochtlen, *Annalen*, 1904, 337, 1; Hofmann and Resenscheck, *ibid.*, 1905, 340, 267; 1905, 342, 364, for an examination of the whole subject). Among blue bodies which are sometimes present may be mentioned "**soluble Prussian blue**," $2[\text{KFe}''(\text{Fe}''(\text{CN})_6)] + 3.5\text{H}_2\text{O}$. **Hofmann's blue**, $\text{KFe}'''(\text{Fe}''(\text{CN})_6) + \text{H}_2\text{O}$. **Stable soluble blue**, $\text{Fe}''\text{K}(\text{Fe}''(\text{CN})_6) + \text{H}_2\text{O}$; **Williamson's blue or violet**, $\text{KFe}'''(\text{Fe}''(\text{CN})_6) + \text{H}_2\text{O}$. A full account of these different blues is given in Hofmann's papers above referred to.

Manufacture.—Several different varieties of Prussian blue are on the market. The finest commercial Prussian blue goes under the name **Paris blue**, and is made by dissolving 50 kilos of potassium ferrocyanide in 250 kilos of water, and making simultaneously a solution of 43-45 kilos of ferrous sulphate (green vitriol) in 259 kilos of water, best in the presence of scrap iron to avoid formation of ferric salts. The two solutions are now run simultaneously into a vessel containing 250 kilos of water, and the almost white precipitate which forms is allowed to settle and is drained on a cloth filter.

The paste is now heated to boiling, transferred to a wooden vessel, and 25.5 kilos of concentrated HNO_3 (1.23 sp. gr.) mixed with 18 kilos of concentrated sulphuric acid (1.84 sp. gr.) are added. This oxidises the paste to a fine blue colour. After standing twenty-four hours the mixture is suspended in large excess of cold water and settled. The mass is washed with cold water by decantation until the bulk is free from sulphuric acid. It is then collected on linen filters, pressed to cakes, and dried in air at $39^\circ\text{-}40^\circ\text{C}$. Yield, 39-40 kilos.

Another method is to acidify the paste with hydrochloric acid and pass chlorine gas through it, until the solution gives a deep blue colour with potassium ferrocyanide.

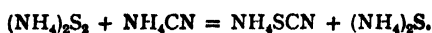
Still a third method is to oxidise ferrous sulphate with nitric acid and run into the solution potassium ferrocyanide solution. The deep blue precipitate is collected and washed until free from iron.

The best qualities of Prussian blue (known as Paris blue) are made as above described. But inferior qualities (known as **Mineral blue**) are sold in which the Paris blue is mixed with starch, gypsum, burnt and finely-ground kaolin, heavy spar, etc.

The mixture is made by adding the white finely-ground material to the Paris blue paste, and passing through a colour mill.

Sulphocyanides or Thiocyanates—Recovery from Coal-Gas.—Sulphocyanides are now obtained solely from coal-gas. At one time synthetic sulphocyanides were made, but apparently the manufacture has been abandoned.

Gas liquor, when quite fresh, contains ammonium sulphide, $(\text{NH}_4)_2\text{S}$, and ammonium cyanide, NH_4CN . When stored, the atmospheric oxygen sets free sulphur, which dissolves to form polysulphides, and these then react with the cyanide present to form sulphocyanide, thus:—

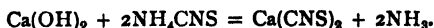


By means of this reaction, Wood, Smith, Gidden, Salamon, and Albright (English Patent, 13,658, 1901) introduced a successful process of recovering practically all the cyanogen (98 per cent.) of coal-gas, which is now worked by the British Cyanides Co. Ltd., and by several gas works. It yields practically the whole of the sulphocyanides now made.

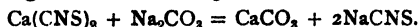
The coal-gas coming from the retorts is first led through a tar extractor, and then through a special scrubber, after which it passes on to the ammonia scrubber of the works. The water in this special scrubber is rendered ammoniacal by the passage of the gas, and sulphur in small lumps is then added.

As the sulphur is rotated by the scrubber, polysulphides of ammonia are formed, which are in turn decomposed by the hydrocyanic acid, HCN, of the coal-gas, with the production of sulphocyanide of ammonia.

The ammonium sulphocyanide, NH_4CNS , is next distilled with lime, and the ammonia is expelled and recovered, thus:—



The calcium sulphocyanide, $\text{Ca}(\text{CNS})_2$, is next converted into sodium or potassium sulphocyanide by treating with sodium or potassium carbonate:—



The sodium or potassium sulphocyanide can then be converted either into cyanide or into prussiate (ferrocyanide), as described on p. 487.

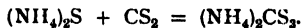
In 1909 P. E. Williams, engineer at Poplar, designed a special purifier box, which merely contains moistened spent oxide—about 50 per cent. S. The box arrests sulphur, in some way which is not yet quite clear, and it is claimed that the CS_2 in the gas is also reduced. The saving effected over the former method, using a mechanically driven washer fed with specially prepared sulphur, must be considerable.

It will thus be seen that the recovery of cyanogen from coal-gas is either effected as ferrocyanide, as described on p. 493, or as sulphocyanide. The *advantage of the ferrocyanide process* is that it gives a product which itself has a fairly wide market, and can be easily transformed into either Prussian blue or alkali cyanides. Its disadvantage is that it is almost impossible—with the intentional admission of a small proportion of air to the coal-gas before purification in order to effect some continuous revivification of the oxide, *quite* impossible—to avoid the formation of sulphocyanides during the process of purification. The recovery of this where a ferrocyanide process is worked is usually too costly, and it is generally lost. The great *disadvantages of the sulphocyanide processes* are the facts that it has not been found practicable to manufacture alkali cyanides direct from sulphocyanide and that the sulphocyanide liquor is very corrosive to wet iron.

SYNTHETIC SULPHOCYANIDES FROM CARBON DISULPHIDE AND AMMONIA

At one time considerable amounts of synthetic sulphocyanides were made and worked for cyanides or sulphocyanides, as described above. At the present time the process appears to have been abandoned, but may later revive, and so we will describe the process.

Gelis (English Patent, 1,816, 1860) manufactured sulphocyanide by agitating a concentrated solution of ammonia and ammonium sulphide with carbon disulphide, CS_2 , when ammonium sulphocarbonate is formed, thus:—



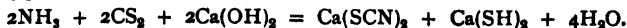
The solution is next heated to 90° – 100° C. with potassium sulphide, when potassium sulphocyanide is formed with the evolution of much sulphuretted hydrogen:—



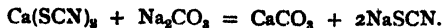
The disposal of the sulphuretted hydrogen evolved caused much expense, and the process was not successful commercially. Günzburg and Tcherniac (see English Patents, 1,148, 1878; 1,359, 1879; 1,261, 1881) improved the process by simply heating a 20 per cent. NH_3 solution to 100° in an autoclave provided with stirrers, until the pressure of 15 atmospheres was reached, when ammonium sulphocyanide is quantitatively produced, thus:—



The process, also, was not commercially successful. In 1894, however, Brock, Raschen, and others (see Crowther and Rossiter, English Patent, 17,846, 1893; Bock, Hetherington, Hurter, and Raschen, English Patent, 21,451, 1893) modified the process by adding lime to the charge, thus diminishing the pressure in the autoclaves and reducing the amount of ammonia required, the action taking place according to the equation:—



Excess of ammonia must be present to prevent formation of sulphocarbonate. At the end of the process this is distilled off, CO_2 gas is driven through the liquid to expel the sulphuretted hydrogen (as in the Claus-Chance treatment of alkali waste), and any precipitated calcium carbonate is filtered off. The soluble calcium sulphocyanide is treated with sodium carbonate and converted into sodium sulphocyanide, thus:—



The United Alkali Co. worked this process for some years, converting the synthetic sodium sulphocyanide into cyanide by Raschen's process of oxidation by nitric acid, as described on p. 487.

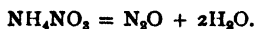
SECTION LI

MANUFACTURE OF NITROUS OXIDE

(Laughing Gas, Nitrogen Monoxide), N_2O

By GEOFFREY MARTIN, Ph.D., D.Sc.

THE usual process is to heat ammonium nitrate, NH_4NO_3 , in retorts, when it decomposes, thus:—



The substance begins to decompose at $170^\circ C.$, and the heat must be carefully regulated (best by gas firing), otherwise explosions can occur.

It is important to use pure ammonium nitrate. If the temperature is too high, N , NH_3 and the very poisonous NO are produced. The gas must be purified by passing through solutions of ferrous sulphate, $FeSO_4$, caustic potash, KOH , and milk of lime. NO is caught by the $FeSO_4$; and is held back by the KOH and lime, which also retains any CO_2 .

1 kilo NH_4NO_3 gives 182 litres N_2O .

See Baskerville and Stephenson (*Journ. Ind. Eng. Chem.*, 1911, 3, 579) for a full account of its preparation and the requisite purity for use as an anæsthetic.

Lidoff (*Journ. Russ. Phys. Chem. Soc.*, 1903, 35, 59) mixes the ammonium nitrate with sand, and washes the gas with ferrous sulphate solution, drying it with an emulsion of ferrous sulphate in concentrated sulphuric acid.

Smith and Elmore (D.R.P., 71,279, of 1892) heat dry KNO_3 with dry $(NH_4)_2SO_4$. The evolution of gas begins at $230^\circ C.$ and ends at $300^\circ C.$ Thilo (*Chem. Zeit.*, 1894, 18, 532) uses $NaNO_2$ and heats to $240^\circ C.$ Campari (*Chem. Cent.*, 1888, 1569) heats 5 parts $SnCl_2$, 10 parts HCl (sp. gr. 1.21), and 0.9 parts HNO_3 (sp. gr. 1.38), when gas is evolved. Pictet (French Patent, 415,594, of 1910) and Södermann (French Patent, 411,785, of 1910) obtain it from an electrically produced nitrogen-oxygen flame by rapid cooling.

Properties.—Colourless gas with pleasant odour and sweet taste. Density 1.5301 (air = 1). 1 litre weighs 1.9774 g. at $0^\circ C.$ and 760 mm. Coefficient of expansion, 0.0037067.

The liquefied gas has density 1.2257 ($H_2O = 1$), and refractive index 1.193 at $16^\circ C.$ Critical temperature, $35.4^\circ C.$; critical pressure, 75 atmospheres. Liquid boils at $-88^\circ C.$, and thereby partially solidifies (at $-115^\circ C.$). Mixed with CS_2 , evaporated *in vacuo*, a temperature of $-140^\circ C.$ is attained.

Burning oxidisable bodies (such as P, S, etc.) continue to burn in the gas as in pure oxygen. With H gas it forms an explosive mixture. Heat of formation, 21,700 calories.

Solubility in water:—

1 volume water	$5^\circ C.$	$10^\circ C.$	$15^\circ C.$	$20^\circ C.$	$25^\circ C.$
dissolves	1.048	0.8778	0.7377	0.6294	0.5443 vols.

When breathed, nitrous oxide is a valuable anæsthetic for short operations; 22-26 litres of gas are needed to produce insensibility. Prolonged breathing causes death. It is advisable to mix 0.1 per cent. of atmospheric air with the gas; the limit is 0.25 per cent. air. Mixed with oxygen the breathing of the gas produces intoxication. Also used for making sodium azide.

Analysis.—Best by burning with H according to Bunsen's method. See W. Hempel (*B.*, 15, 903; *Journ. Soc. Chem. Ind.*, 1882, 200). A. Wagner (*Journ. Soc. Chem. Ind.*, 1882, 332) gives a method of estimating the NO in N_2O . See also Lunge, *Journ. Soc. Chem. Ind.*, 1881, 428.

Transport.—In liquefied form in iron, steel, or copper cylinders. See R. Hasenclever, *Chem. Ind.*, 1893, 373.

