

BIRLA CENTRAL LIBRARY

PILANI (Rajasthan)

Class No:- 669.1

Book No:- B95455 v.2

Accession No:- 45386

Acc. No... ..

ISSUE LABEL

Not later than the latest date stamped below.

~~1920 Oct 7~~

~~11 Nov 79~~

2 Feb 71

634

—

STEEL *and Its* HEAT TREATMENT

Volume II · Tools, Processes, Control

STEEL AND ITS HEAT TREATMENT

BY

D. K. BULLENS

AND

THE METALLURGICAL STAFF OF THE
BATELLE MEMORIAL INSTITUTE

Fifth Edition

VOL. I. PRINCIPLES. The principles which relate to the heat treatment of steel in general, whether it be plain carbon or alloy steel. 489 pages, $5\frac{7}{8}$ by 9. 262 figures. Cloth.

VOL. II. TOOLS, PROCESSES, CONTROL. The practical application of heat treatment. 293 pages, $5\frac{7}{8}$ by 9. 118 figures. Cloth.

VOL. III. ENGINEERING AND SPECIAL-PURPOSE STEELS. A discussion of engineering carbon, simple alloy, complex alloy and special-purpose steels. In preparation.

PUBLISHED BY

JOHN WILEY & SONS, INC.

STEEL
and Its
HEAT TREATMENT

Volume II · Tools, Processes, Control

Fifth Edition

BY

D. K. BULLENS

AND

THE METALLURGICAL STAFF

Of the Battelle Memorial Institute

JOHN WILEY & SONS, INC., NEW YORK
CHAPMAN & HALL, LIMITED, LONDON

1948

COPYRIGHT, 1916, 1917
BY DENISON K. BULLENS
1916 Copyright renewed 1943
1917 Copyright renewed 1944

COPYRIGHT, 1927
BY D. K. BULLENS
Copyrighted in Great Britain

COPYRIGHT, 1935
BY DENISON K. BULLENS
Copyrighted Canada, 1935, International Copyright, 1935
International Copyright, 1938, Copyrighted Canada, 1939

COPYRIGHT, 1939
BY BATTELLE MEMORIAL INSTITUTE
Copyrighted Canada, 1948, International Copyright, 1948

COPYRIGHT, 1948
BY BATTELLE MEMORIAL INSTITUTE

All Rights Reserved

*This book or any part thereof must not
be reproduced in any form without
the written permission of the publisher.*

FIFTH EDITION
Second Printing, April, 1949

PRINTED IN THE UNITED STATES OF AMERICA

IN MEMORY OF

Albert Nelson Bullens

AND

TO OUR FRIEND

J. A. Doyle

PREFACE

The keynote of successful heat-treating practice is the securing of the desired temperature at the desired location, in the piece being treated, for the desired time, whether in heating or cooling. This is more easily said than done. How nearly the ideal laid down by the principles underlying heat treatment can be reached depends on the care given by the heat treater and on the suitability of the tools he has to work with. The principles underlying many of the steps in heat treatment are described in Volume I. There are penalties attending either willful or forced transgression of the principles.

Means for avoidance of these penalties, some processes not discussed in Volume I, and the tools of heat treatment, such as furnaces and other heating devices and quenching media, form the topics of this volume. As in Volume I, there is no sharp dividing line between plain-C and alloy steels in these matters. The specific effects of alloying elements have to be casually commented on in various connections, but the general survey of these effects will come in Volume III.

CONTENTS

	PAGE
PREFACE	vii
TEMPERATURE CONVERSION TABLE	xii
STEEL NUMBERING SYSTEMS	xiii
METALLURGICAL JOURNALS	xxiii

SECTION I. CONTROL OF SURFACE CONDITIONS

CHAPTER

1 NEED FOR SURFACE STRENGTH	1
Hard cases. Brittleness of hard-surfaced objects. Core properties. Decarburization. Springs.	
2 FLAME AND INDUCTION HARDENING	15
Steels and methods for flame hardening. Mechanism of induction hardening. Induction hardening in the production line. Quenching, structures, pretreatment.	
3 NITRIDING AND CYANIDING	31
The nitriding process. Dissociation of ammonia. Time required. Precautions. Cyaniding. Dry cyaniding, operating times, and temperatures. Liquid cyaniding with aid of ammonia. Straight liquid cyaniding, reactions. Composition and depth of case. Activated baths.	
4 CARBURIZING PROCESSES	58
Reactions. Carbon pressure. Gas ratios. Carbon monoxide behavior. Hydrogen and water vapor. Carrier gases. Carburizing gases. Combination carburizing. Diffusion cycle. Carburizing rates. Solid carburizers, carburizing rates. Type of carbon. Energizers. Decarburization in cooling. Gradient control. Measurement of case depth. Reuse of carburizer. Lower carbon cases. Stopoffs. Boxes. Packing the charge. Heating rates. Furnaces.	
5 HEAT TREATMENT OF CARBURIZED STEEL	91
Types of steel. Pretreatment. Grain size, abnormality. Oxygen. Cementite distribution. Machinability. Endurance transition zone, core toughness, economic aspects. Heat treatment, single and double. Warping. Tempering. Retained austenite. Temperatures of treatment. N.E. steels. Austempering. Distortion. The human element.	

6	CONTROLLED ATMOSPHERES	109
----------	-------------------------------	------------

Sealing. Its mitigation. Decarburization. High-speed steel. Sealing versus time and temperature. Annealing, normalizing, hardening. Furnace types. Protective gases, nitrogen. Alloy versus carbon steels. Simple-gas pairs, CO-CO₂; inactivity of pure CO and H₂. Dilution. Dry H₂; wet H₂. Experimental studies. Time-temperature effect. Mixed gases. Wet CO. Permissible amount of CO₂. Sulphur. Historical development. Removal of H₂O and CO₂. Gases produced at different fuel-gas : air ratios. Charcoal gas. Generator gas. Its purification. Equipment used. Recirculation of gas. Charcoal tower purification. Straight charcoal gas. Control devices. Gas types. Lithium drying. Equipment for different-sized shops. Use of cast-iron borings, carbon blocks, charcoal packing. Repair of decarburized surfaces. Summary, bright annealing, bright normalizing, spheroidizing, hardening ordinary and high-speed steel. Contamination of gases, effect on heat-resistant alloys.

7	FUSED BATHS	163
----------	--------------------	------------

Lead and alloys. Salts. Decarburization. Bath compositions for various temperatures, uses.

SECTION II. HEATING AND COOLING

8	GENERAL CONSIDERATIONS	170
----------	-------------------------------	------------

Modes of heat transfer. Temperature uniformity. Temperature head. Internal stresses. Distortion. Heating in grinding.

9	PROPER HEATING IN FORGING AND ROLLING PRACTICE	176
----------	---	------------

Open furnaces. Heating rates. Overheating. Structures and properties. Forging furnaces. Uniform heating. Slot furnaces. Electric heating.

10	SOURCES OF EFFECTIVE HEAT FOR HEAT-TREATING OPERATIONS—FUELS AND FURNACES	190
-----------	--	------------

Internal heating. Forced circulation, in fuel-fired and electric salt-bath furnaces. Insulation. Sources of radiant heat. Electric resistors. Controls. Radiant tubes. Globar elements. Direct resistance. Induction heating. Choices. Fuel versus electricity. Combination heating. Fuel cost versus over-all cost.

11	APPLICATION OF HEAT IN HEAT TREATING	212
-----------	---	------------

Uniformity of temperature in furnace and charge. Forced convection. Packs and coils. Modes of heat transfer. Radiation. Shielding. Control. Loading the charge. Important factors.

12	CONTROL OF THE COOLING PHASE. COOLANTS	228
-----------	---	------------

Individual cooling. Coolants. Pressure cooling. Contact with coolant. Coolant temperature, oils. Brine and other solutions.

CONTENTS

xi
PAGE

CHAPTER

Gas quenching. Salt. Lead. Cooling in the low-temperature range. Die quenching.

SECTION III. HEAT TREATMENT OF FERROUS CASTINGS

13 QUENCHING STEEL CASTINGS. HEAT TREATMENT OF CAST AND MALLEABLE IRONS 241

Mechanical properties of steel castings. Difficulties. Time quenching. Effects of section. Gray iron. Heat treatment in relation to graphite. Softening for machining. Quenching and tempering. Treatment for wear resistance. Malleable iron. First- and second-stage graphitization. Ductility and strength. Cupola malleable. Decarburization, white heart. Pearlitic malleable. Alloying. Controlled atmosphere. Quenching. Arrested malleabilization. Austenitizing. Effect of silicon. Ford alloys. Shot.

14 GRAPHITE AND STEELS 255

Wrought graphitic steels. Uses, properties. Stability of carbide. Influence of aluminum. Use of chromium. Porous steels. Powder metallurgy. Mechanical properties. Filling of voids.

SECTION IV. OTHER APPLICATIONS OF HEAT TREATMENT

15 HEAT TREATMENT IN RELATION TO WELDING AND MACHINING 272

Welding. Cracking. Applicability of S curves. Solution of cementite. Underbead cracking. Stress relief. Steel composition. Machinability. Mechanism of machining. Cold work. Optimum properties. Grain size. Pearlitic structures. Spheroidization. Free-machining steels. Structures for various types of machining. Variability. Major relations.

16 THE HUMAN ELEMENT 285

Batch versus continuous operation. Variables and their control. Human experience required.

INDEX 291

TABLE I

TEMPERATURE CONVERSION TABLE

By Dr. Leonard Waldo

Reprint from *Metallurgical and Chemical Engineering*

C°	0	10	20	30	40	50	60	70	80	90		
-200	-328	-346	-364	-382	-400	-418	-436	-454	-472	-490		
-100	-148	-166	-184	-202	-220	-238	-256	-274	-292	-310		
-0	+32	+14	-4	-22	-40	-58	-76	-94	-112	-130		
0	32	50	68	86	104	122	140	158	176	194		
100	212	230	248	266	284	302	320	338	356	374	C°	F°
200	392	410	428	446	464	482	500	518	536	554	1	1.8
300	572	590	608	626	644	662	680	698	716	734	2	3.6
400	752	770	788	806	824	842	860	878	892	914	3	5.4
500	932	950	968	986	1004	1022	1040	1058	1076	1094	4	7.2
600	1112	1130	1148	1166	1184	1202	1220	1238	1256	1274	5	9.0
700	1292	1310	1328	1346	1364	1382	1400	1418	1436	1454	6	10.8
800	1472	1490	1508	1526	1544	1562	1580	1598	1616	1634	7	12.6
900	1652	1670	1688	1706	1724	1742	1760	1778	1796	1814	8	14.4
1000	1832	1850	1868	1886	1904	1922	1940	1958	1976	1994	9	16.2
1100	2012	2030	2048	2066	2084	2102	2120	2138	2156	2174	10	18.0
1200	2192	2210	2228	2246	2264	2282	2300	2318	2336	2354		
1300	2372	2390	2408	2426	2444	2462	2480	2498	2516	2534		
1400	2552	2570	2588	2606	2624	2642	2660	2678	2696	2714		
1500	2732	2750	2768	2786	2804	2822	2840	2858	2876	2894		
1600	2912	2930	2948	2966	2984	3002	3020	3038	3056	3074		
1700	3092	3110	3128	3146	3164	3182	3200	3218	3236	3254	F°	C°
1800	3272	3290	3308	3326	3344	3362	3380	3398	3416	3234	1	.56
1900	3452	3470	3488	3506	3524	3542	3560	3578	3596	3614	2	1.11
2000	3632	3650	3668	3686	3704	3722	3740	3758	3776	3794	3	1.67
2100	3812	3830	3848	3866	3884	3902	3920	3938	3956	3974	4	2.22
2200	3992	4010	4028	4046	4064	4082	4100	4118	4136	4154	5	2.78
2300	4172	4190	4208	4226	4244	4262	4280	4298	4316	4334	6	3.33
2400	4352	4370	4388	4406	4424	4442	4460	4478	4496	4514	7	3.89
2500	4532	4550	4568	4586	4604	4622	4640	4658	4676	4694	8	4.44
2600	4712	4730	4748	4766	4784	4802	4820	4838	4856	4874	9	5.00
2700	4892	4910	4928	4946	4964	4982	5000	5018	5036	5054	10	5.56
2800	5072	5090	5108	5126	5144	5162	5180	5198	5216	5234	11	6.11
2900	5252	5270	5288	5306	5324	5342	5360	5378	5396	5414	12	6.67
3000	5432	5450	5468	5486	5504	5522	5540	5558	5576	5594	13	7.22
3100	5612	5630	5648	5666	5684	5702	5720	5738	5756	5774	14	7.78
3200	5792	5810	5828	5846	5864	5882	5900	5918	5936	5954	15	8.33
3300	5972	5990	6008	6026	6044	6062	6080	6098	6116	6134	16	8.89
3400	6152	6170	6188	6206	6224	6242	6260	6278	6296	6314	17	9.44
3500	6332	6350	6368	6386	6404	6422	6440	6458	6476	6494	18	10.00
3600	6512	6530	6548	6566	6584	6602	6620	6638	6656	6674		
3700	6692	6710	6728	6746	6764	6782	6800	6818	6836	6854		
3800	6872	6890	6908	6926	6944	6962	6980	6998	7016	7034		
3900	7052	7070	7088	7106	7124	7142	7160	7178	7196	7214		
C°	0	10	20	30	40	50	60	70	80	90		

EXAMPLES: 1347°C 2444°F + 12°.6F = 2456°.6F: 3367°F = 1850°C + 2°.78C = 1852°.78C

STEEL NUMBERING SYSTEMS

TABLE II

BASIC OPEN-HEARTH AND ACID-BESSEMER CARBON STEELS

<i>AISI</i> <i>Number</i>	<i>Semi-</i> <i>finish</i>	<i>Bars</i>	<i>Wire</i> <i>Rods</i>	<i>C</i>	<i>Mn</i>	<i>P</i> <i>(b)</i>	<i>S</i> <i>(b)</i>	<i>1942 SAE</i> <i>Number</i>
C 1005	✓	0.06 max.	0.35 max.	0.04	0.05
C 1006 *	Q, R	✓	✓	0.08 max.	0.25-0.40	0.04	0.05
C 1008 *	Q, R	✓	✓	0.10 max.	0.30-0.50	0.04	0.05	1008
CB 1008	..	✓	✓	0.10 max.
C 1009	Q	0.07-0.12	0.25-0.40	0.04	0.05
C 1010 *	Q, R	✓	✓	0.08-0.13	0.30-0.50	0.04	0.05	1010
C 1012	Q	✓	✓	0.10-0.15	0.30-0.50	0.04	0.05
CB 1012	..	✓	..	0.15 max.
C 1013	✓	0.11-0.16	0.60-0.90	0.04	0.05
C 1014	Q	✓	✓	0.13-0.18	0.40-0.60	0.04	0.05
C 1015 *	Q, R	✓	✓	0.13-0.18	0.30-0.50	0.04	0.05	1015
C 1016	Q	✓	✓	0.13-0.18	0.60-0.90	0.04	0.05	{ X1015 1016
CB 1017	..	✓	..	0.10-0.25
C 1017	Q	✓	✓	0.15-0.20	0.40-0.60	0.04	0.05
C 1018	Q	✓	✓	0.15-0.20	0.60-0.90	0.04	0.05
C 1019	Q	✓	✓	0.15-0.20	0.70-1.00	0.04	0.05
C 1020 *	Q, R	✓	✓	0.18-0.23	0.30-0.50	0.04	0.05	1020
C 1021	Q	✓	✓	0.18-0.23	0.40-0.60	0.04	0.05
C 1022	Q	✓	✓	0.18-0.23	0.70-1.00	0.04	0.05	{ X1020 1022
C 1023	Q	✓	✓	0.20-0.25	0.30-0.50	0.04	0.05
C 1024	..	✓	..	0.20-0.26	1.35-1.65	0.04	0.05	1024
C 1025 *	Q, R	✓	✓	0.22-0.28	0.30-0.50	0.04	0.05	1025
C 1026	Q	✓	✓	0.22-0.28	0.40-0.60	0.04	0.05
C 1027	✓	0.24-0.30	0.40-0.60	0.04	0.05
C 1029	Q	✓	..	0.25-0.31	0.60-0.90	0.04	0.05
C 1030	Q	✓	✓	0.28-0.34	0.60-0.90	0.04	0.05	1030
C 1031	Q	0.28-0.34	0.40-0.60	0.04	0.05
CB 1032	R	✓	..	0.25-0.40
C 1033	Q	✓	..	0.30-0.36	0.60-0.90	0.04	0.05
C 1034	✓	0.32-0.38	0.50-0.70	0.04	0.05
D 1034	✓	0.32-0.38	0.50-0.70	0.05	0.05
C 1035	Q	✓	..	0.32-0.38	0.60-0.90	0.04	0.05	1035
C 1036	..	✓	..	0.32-0.39	1.20-1.50	0.04	0.05	1036
C 1037	C.r. strip	0.32-0.38	0.40-0.60	0.04	0.05
C 1038	Q	..	✓	0.35-0.42	0.60-0.90	0.04	0.05
C 1039	C.r. strip	0.37-0.44	0.40-0.60	0.04	0.05
C 1040	Q	✓	✓	0.37-0.44	0.60-0.90	0.04	0.05	1040
C 1041	✓	0.36-0.44	1.35-1.65	0.04	0.05
C 1042	Q	✓	..	0.40-0.47	0.60-0.90	0.04	0.05
C 1043	Q	✓	..	0.40-0.47	0.70-1.00	0.04	0.05
C 1044	✓	0.43-0.50	0.50-0.70	0.04	0.05
C 1045	Q	✓	..	0.43-0.50	0.60-0.90	0.04	0.05	1045
C 1046	Q	0.43-0.50	0.70-1.00	0.04	0.05
C 1047	C.r. strip	0.43-0.50	0.40-0.60	0.04	0.05

TABLE II (Continued)

BASIC OPEN-HEARTH AND ACID-BESSEMER CARBON STEELS

ASTM Number	Semi-finish	Bars	Wire Rods	C	Mn	P (b)	S (b)	1942 SAE Number
C 1049	C.r. strip	0.48-0.55	0.40-0.60	0.04	0.05
D 1049	✓	0.43-0.50	0.50-0.70	0.05	0.05
C 1050	Q	✓	..	0.48-0.55	0.60-0.90	0.04	0.05	1050
C 1051	✓	0.45-0.56	0.85-1.15	0.04	0.05
C 1052	..	✓	..	0.47-0.55	1.20-1.50	0.04	0.05	1052
C 1054	✓	0.50-0.60	0.50-0.70	0.04	0.05
D 1054	✓	0.50-0.60	0.50-0.70	0.05	0.05
C 1055	Q	✓	..	0.50-0.60	0.60-0.90	0.04	0.05	1055
C 1056	C.r. strip	0.50-0.60	0.40-0.60	0.04	0.05
C 1057	✓	0.50-0.61	0.85-1.15	0.04	0.05
C 1058	C.r. strip	0.55-0.65	0.40-0.60	0.04	0.05
C 1059	✓	0.55-0.65	0.50-0.70	0.04	0.05
D 1059	✓	0.55-0.65	0.50-0.70	0.05	0.05
C 1060	..	✓	✓	0.55-0.65	0.60-0.90	0.04	0.05	1060
C 1061	..	✓	..	0.54-0.65	0.75-1.05	0.04	0.05
C 1062	✓	0.54-0.65	0.85-1.15	0.04	0.05
C 1063	0.57-0.67	0.60-0.85	0.04	0.05
C 1064	..	✓	✓	0.60-0.70	0.50-0.70	0.04	0.05
D 1064	✓	0.60-0.70	0.50-0.70	0.05	0.05
C 1065	Strip	0.60-0.70	0.60-0.90	0.04	0.05
C 1066	..	✓	✓	0.60-0.71	0.80-1.10	0.04	0.05	{ X1065 1066
C 1068	..	✓	..	0.65-0.75	0.50 max.	0.04	0.05
C 1069	✓	0.65-0.75	0.50-0.70	0.04	0.05
D 1069	✓	0.65-0.75	0.40-0.60	0.05	0.05
C 1070	..	✓	..	0.65-0.75	0.70-1.00	0.04	0.05	1070
C 1074	..	✓	✓	0.70-0.80	0.50-0.70	0.04	0.05
D 1074	✓	0.70-0.80	0.40-0.60	0.05	0.05
C 1075	✓	0.70-0.80	0.60-0.80	0.04	0.05
C 1076	Q	0.65-0.85	0.60-0.85	0.04	0.05
C 1078	..	✓	✓	0.72-0.85	0.30-0.50	0.04	0.05
D 1078	✓	0.70-0.85	0.30-0.50	0.05	0.05
C 1080	..	✓	..	0.75-0.88	0.60-0.90	0.04	0.05	1080
D 1083	✓	0.80-0.95	0.30-0.50	0.05	0.05
C 1084	Q	0.80-0.93	0.60-0.90	0.04	0.05
C 1085	Q	✓	..	0.80-0.93	0.70-1.10	0.04	0.05	1085
C 1086	..	✓	✓	0.82-0.95	0.30-0.50	0.04	0.05
C 1090	Q	0.85-1.00	0.60-0.90	0.04	0.05
C 1095	..	✓	✓	0.90-1.05	0.30-0.50	0.04	0.05	1095
D 1095	✓	0.90-1.05	0.30-0.50	0.05	0.05
B 1006	✓	0.08 max.	0.45 max.	0.11 max.	0.06 max.
B 1008	R	✓	..	0.10 max.	0.30-0.50	0.11 max.	0.06 max.
B 1011	..	✓	✓	0.13 max.	0.50-0.70	0.11 max.	0.06 max.

* Compositions are given for forging quality; rerolling quality differs slightly in analysis.

When silicon is specified in standard basic open-hearth steels, silicon may be ordered only as 0.10 per cent maximum; 0.10 to 0.20 per cent; or 0.15 to 0.30 per cent. In the case of many grades of basic open-hearth steel, special practice is necessary in order to comply with a specification including silicon.

Acid-Bessemer steel is not furnished with specified silicon content.

Code for prefixes:

A is basic open-hearth alloy steel.

B is acid-Bessemer carbon steel.

C is basic open-hearth carbon steel.

D is acid open-hearth carbon steel.

E is electric-furnace steel.

NE is National Emergency standard steel; designation promulgated by WPB.

Q is forging quality, or special-requirement quality.

R is rerolling quality billets.

TABLE III
FREE-CUTTING SULPHURIZED OR PHOSPHORIZED CARBON STEELS

AISI Number	Semi-finish	Bars	Wire Rods	C	Mn	P (b)	S (b)	1942 SAE Number
B 1106	✓	0.09 max.	0.50 max.	0.11 max.	0.04 -0.09
C 1108	✓	0.08-0.13	0.50-0.70	0.045 max.	0.07 -0.12
C 1109	Q	✓	✓	0.08-0.13	0.60-0.90	0.045 max.	0.08 -0.13
B 1110	..	✓	✓	0.13 max.	0.60 max.	0.11 max.	0.045-0.075
C 1110	..	✓	✓	0.08-0.13	0.60-0.90	0.045 max.	0.10 -0.15
B 1111	..	✓	✓	0.08-0.13	0.60-0.90	0.09-0.13	0.10 -0.15	1111
C 1111	✓	0.08-0.13	0.60-0.90	0.045 max.	0.16 -0.23
B 1112	..	✓	✓	0.08-0.13	0.60-0.90	0.09-0.13	0.16 -0.23	1112
C 1112	..	✓	..	0.10-0.16	1.00-1.30	0.045 max.	0.08 -0.13
B 1113	..	✓	✓	0.08-0.13	0.60-0.90	0.09 0.13	0.24 -0.33	{ X1112 1113
C 1113	Q	✓	..	0.10-0.16	1.00-1.30	0.045 max.	0.24 -0.33
C 1114	R	0.12-0.18	0.45-0.65	0.045 max.	0.075-0.15
C 1115	Q	✓	✓	0.13-0.18	0.70-1.00	0.045 max.	0.10 -0.15	1115
C 1116	Q	✓	✓	0.14 0.20	1.10 1.40	0.045 max.	0.16 -0.23
C 1117	..	✓	✓	0.14 0.20	1.00 1.30	0.045 max.	0.08 -0.13	{ X1314 1117
C 1118	Q	✓	✓	0.14-0.20	1.30-1.60	0.045 max.	0.08 -0.13	{ X1315 1118
C 1119	✓	0.14-0.20	1.35-1.65	0.045 max.	0.16 -0.23
C 1120 *	Q, R	✓	✓	0.18-0.23	0.60-0.90	0.045 max.	0.08 -0.13
C 1121	Q	✓	✓	0.18-0.23	0.70-1.00	0.045 max.	0.08 -0.13
C 1122	Q	✓	✓	0.17-0.23	1.35-1.65	0.045 max.	0.08 -0.13
C 1132	Q	✓	✓	0.27-0.34	1.35 1.65	0.045 max.	0.08 -0.13	{ X1330 1132
C 1137	Q	✓	✓	0.32-0.39	1.35 1.65	0.045 max.	0.08 -0.13	{ X1335 1137
C 1140 †	Q	0.37-0.44	0.60-0.90	0.045 max.	0.04 -0.07
C 1141	..	✓	..	0.37-0.45	1.35-1.65	0.045 max.	0.08 -0.13	{ X1340 1141
C 1144	..	✓	..	0.40-0.48	1.35-1.65	0.045 max.	0.24 -0.33
C 1145 †	Q	0.42-0.49	0.70-1.00	0.045 max.	0.04 -0.07	1145
C 1205	Q	..	✓	0.08 max.	0.25-0.40	0.04-0.07	0.05 max.
C 1206	R	..	✓	0.08 max.	0.25-0.40	0.06-0.10	0.05 max.
C 1209	R	..	✓	0.08 0.13	0.30 0.50	0.04-0.07	0.05 max.
C 1210	Q	..	✓	0.08-0.13	0.30-0.50	0.06-0.10	0.05 max.
C 1217	..	✓	..	0.14-0.19	0.70-1.00	0.09-0.13	0.20-0.29

* Compositions given are for forging quality; rerolling quality differs slightly in analysis.

(b) Phosphorus and sulphur are maximum for basic open-hearth and acid-Bessemer steels; sulphurized or phosphORIZED steels are not subject to check analysis for S or P.

Acid-Bessemer steels (B series) are not furnished with specified silicon content.

† Standard steels C 1140 and C 1145 may be ordered with silicon content either as 0.10% max., 0.10 to 0.20%, or 0.15 to 0.30%.

TABLE IV

OPEN-HEARTH ALLOY AND ELECTRIC-FURNACE CARBON AND ALLOY STEELS
Blooms, Billets, Slabs, Bars, and Hot-Rolled Strip

AISI Number	P		S		Ni	Cr	Mo	'42 SAE Number
	C	Mn	Max.*	Max.*				
A 1330	0.28-0.33	1.60-1.90	0.040	0.040	0.20-0.35			1330
A 1335	0.33-0.38	1.60-1.90	0.040	0.040	0.20-0.35			1335
A 1340	0.38-0.43	1.60-1.90	0.040	0.040	0.20-0.35			1340
A 1345	0.43-0.48	1.60-1.90	0.040	0.040	0.20-0.35			
A 1350	0.48-0.53	1.60-1.90	0.040	0.040	0.20-0.35			
A 2317	0.15-0.20	0.40-0.60	0.040	0.040	0.20-0.35	3.25-3.75		{ 2315 2317
A 2330	0.28-0.33	0.60-0.80	0.040	0.040	0.20-0.35	3.25-3.75		2330
A 2335	0.33-0.38	0.60-0.80	0.040	0.040	0.20-0.35	3.25-3.75		
A 2340	0.38-0.43	0.70-0.90	0.040	0.040	0.20-0.35	3.25-3.75		2340
A 2345	0.43-0.48	0.70-0.90	0.040	0.040	0.20-0.35	3.25-3.75		2345
E 2512	0.09-0.14	0.45-0.60	0.025	0.025	0.20-0.35	4.75-5.25		
A 2515	0.12-0.17	0.40-0.60	0.040	0.040	0.20-0.35	4.75-5.25		2515
E 2517	0.15-0.20	0.45-0.60	0.025	0.025	0.20-0.35	4.75-5.25		
A 3115	0.13-0.18	0.40-0.60	0.040	0.040	0.20-0.35	1.10-1.40	0.55-0.75	3115
A 3120	0.17-0.22	0.60-0.80	0.040	0.040	0.20-0.35	1.10-1.40	0.55-0.75	3120
A 3130	0.28-0.33	0.60-0.80	0.040	0.040	0.20-0.35	1.10-1.40	0.55-0.75	3130
A 3135	0.33-0.38	0.60-0.80	0.040	0.040	0.20-0.35	1.10-1.40	0.55-0.75	3135
A 3140	0.38-0.43	0.70-0.90	0.040	0.040	0.20-0.35	1.10-1.40	0.55-0.75	3140
A 3141	0.38-0.43	0.70-0.90	0.040	0.040	0.20-0.35	1.10-1.40	0.70-0.90	{ X3140 3141
A 3145	0.43-0.48	0.70-0.90	0.040	0.040	0.20-0.35	1.10-1.40	0.70-0.90	3145
A 3150	0.48-0.53	0.70-0.90	0.040	0.040	0.20-0.35	1.10-1.40	0.70-0.90	3150
A 3240	0.38-0.45	0.40-0.60	0.040	0.040	0.20-0.35	1.65-2.00	0.90-1.20	3240
E 3310	0.08-0.13	0.45-0.60	0.025	0.025	0.20-0.35	3.25-3.75	1.40-1.75	{ 3310 3312
E 3316	0.14-0.19	0.45-0.60	0.025	0.025	0.20-0.35	3.25-3.75	1.40-1.75	
A 4023	0.20-0.25	0.70-0.90	0.040	0.040	0.20-0.35		0.20-0.30	4023
A 4024	0.20-0.25	0.70-0.90	0.040	(a)	0.20-0.35		0.20-0.30	
A 4027	0.25-0.30	0.70-0.90	0.040	0.040	0.20-0.35		0.20-0.30	4027
A 4028	0.25-0.30	0.70-0.90	0.040	(a)	0.20-0.35		0.20-0.30	
A 4032	0.30-0.35	0.70-0.90	0.040	0.040	0.20-0.35		0.20-0.30	4032
A 4037	0.35-0.40	0.75-1.00	0.040	0.040	0.20-0.35		0.20-0.30	4037
A 4042	0.40-0.45	0.75-1.00	0.040	0.040	0.20-0.35		0.20-0.30	4042
A 4047	0.45-0.50	0.75-1.00	0.040	0.040	0.20-0.35		0.20-0.30	4047
A 4063	0.60-0.67	0.75-1.00	0.040	0.040	0.20-0.35		0.20-0.30	4063
A 4068	0.64-0.72	0.75-1.00	0.040	0.040	0.20-0.35		0.20-0.30	4068
A 4119	0.17-0.22	0.70-0.90	0.040	0.040	0.20-0.35		0.40-0.60	4119
A 4120	0.17-0.22	0.70-0.90	0.040	0.040	0.20-0.35		0.60-0.80	4120
A 4125	0.23-0.28	0.70-0.90	0.040	0.040	0.20-0.35		0.40-0.60	4125
A 4130	0.28-0.33	0.40-0.60	0.040	0.040	0.20-0.35		0.80-1.10	{ X4130 4130
A 4131	0.28-0.33	0.50-0.70	0.040	0.040	0.20-0.35		0.80-1.10	4131
E 4132	0.30-0.35	0.40-0.60	0.025	0.025	0.20-0.35		0.80-1.10	4132
A 4134	0.32-0.37	0.40-0.60	0.040	0.040	0.20-0.35		0.80-1.10	4134
E 4135	0.33-0.38	0.70-0.90	0.025	0.025	0.20-0.35		0.80-1.10	4135
A 4137	0.35-0.40	0.70-0.90	0.040	0.040	0.20-0.35		0.80-1.10	4137
E 4137	0.35-0.40	0.70-0.90	0.025	0.025	0.20-0.35		0.80-1.10	4137
A 4140	0.38-0.43	0.75-1.00	0.040	0.040	0.20-0.35		0.80-1.10	4140
A 4141	0.38-0.43	0.75-1.00	0.040	0.040	0.20-0.35		0.80-1.10	4141
A 4142	0.40-0.45	0.75-1.00	0.040	0.040	0.20-0.35		0.80-1.10	4142
A 4143	0.40-0.45	0.75-1.00	0.040	0.040	0.20-0.35		0.80-1.10	4143
A 4145	0.43-0.48	0.75-1.00	0.040	0.040	0.20-0.35		0.80-1.10	4145
A 4147	0.45-0.52	0.75-1.00	0.040	0.040	0.20-0.35		0.80-1.10	4147

TABLE IV (Continued)

OPEN-HEARTH ALLOY AND ELECTRIC-FURNACE CARBON AND ALLOY STEELS

Blooms, Billets, Slabs, Bars, and Hot-Rolled Strip

AISI Number	C	Mn	P		S	Si *	Ni	Cr	Mo	'42 SAE Number
			Max.*	Max.*						
A 4150	0.46-0.53	0.75-1.00	0.040	0.040	0.20-0.35	0.80-1.10	0.15-0.25	4150	
E 4150	0.48-0.53	0.70-0.90	0.025	0.025	0.20-0.35	0.80-1.10	0.20-0.27	
A 4317	0.15-0.20	0.45-0.65	0.040	0.040	0.20-0.35	1.65-2.00	0.40-0.60	0.20-0.30	
A 4320	0.17-0.22	0.45-0.65	0.040	0.040	0.20-0.35	1.65-2.00	0.40-0.60	0.20-0.30	4320	
A 4337	0.35-0.40	0.60-0.80	0.040	0.040	0.20-0.35	1.65-2.00	0.60-0.80	0.30-0.40	
E 4337	0.35-0.40	0.60-0.80	0.025	0.025	0.20-0.35	1.65-2.00	0.70-0.90	0.23-0.30	
A 4340	0.38-0.43	0.60-0.80	0.040	0.040	0.20-0.35	1.65-2.00	0.70-0.90	0.20-0.30	{ X4340 4340	
E 4342	0.40-0.45	0.60-0.80	0.025	0.025	0.20-0.35	1.65-2.00	0.70-0.90	0.23-0.30	
A 4608	0.06-0.11	0.40 max.	0.040	0.040	0.25 max.	1.40-1.75	0.15-0.25	
A 4615	0.13-0.18	0.45-0.65	0.040	0.040	0.20-0.35	1.65-2.00	0.20-0.30	4615	
E 4617	0.15-0.20	0.45-0.65	0.025	0.025	0.20-0.35	1.65-2.00	0.20-0.27	
A 4620	0.17-0.22	0.45-0.65	0.040	0.040	0.20-0.35	1.65-2.00	0.20-0.30	4620	
E 4620	0.17-0.22	0.45-0.60	0.025	0.025	0.20-0.35	1.65-2.00	0.20-0.27	
A 4621	0.18-0.23	0.70-0.90	0.040	0.040	0.20-0.35	1.65-2.00	0.20-0.30	
A 4640	0.38-0.43	0.60-0.80	0.040	0.040	0.20-0.35	1.65-2.00	0.20-0.30	4640	
E 4640	0.38-0.43	0.60-0.80	0.025	0.025	0.20-0.35	1.65-2.00	0.20-0.27	
A 4645	0.43-0.48	0.60-0.80	0.040	0.040	0.20-0.35	1.65-2.00	0.20-0.30	
A 4815	0.13-0.18	0.40-0.60	0.040	0.040	0.20-0.35	3.25-3.75	0.20-0.30	4815	
A 4820	0.18-0.23	0.50-0.70	0.040	0.040	0.20-0.35	3.25-3.75	0.20-0.30	4820	
A 5120	0.17-0.22	0.70-0.90	0.040	0.040	0.20-0.35	0.70-0.90	5120	
A 5130	0.28-0.33	0.70-0.90	0.040	0.040	0.20-0.35	0.80-1.10	
A 5140	0.38-0.43	0.70-0.90	0.040	0.040	0.20-0.35	0.70-0.90	5140	
A 5145	0.43-0.48	0.70-0.90	0.040	0.040	0.20-0.35	0.70-0.90	
A 5150	0.48-0.55	0.70-0.90	0.040	0.040	0.20-0.35	0.70-0.90	5150	
A 5152	0.45-0.55	0.70-0.90	0.040	0.040	0.20-0.35	0.90-1.2j	
E 52095	0.95-1.10	0.25-0.45	0.025	0.025	0.20-0.35	0.40-0.60	
E 52098	0.95-1.10	0.25-0.45	0.025	0.025	0.20-0.35	0.90-1.15	
E 52100(b)	0.95-1.10	0.25-0.45	0.025	0.025	0.20-0.35	1.20-1.5j	
E 52101	0.95-1.10	0.25-0.45	0.025	0.025	0.20-0.35	1.30-1.60	
A 6120	0.17-0.22	0.70-0.90	0.040	0.040	0.20-0.35	0.70-0.90	0.10 min.V	
A 6145	0.43-0.48	0.70-0.90	0.040	0.040	0.20-0.35	0.80-1.10	0.15 min.V	
SAE 6150	0.48-0.55	0.65-0.90	0.040	0.040	0.20-0.35	0.80-1.10	0.15 min.V	6150	
E 6151	0.47-0.53	0.70-0.90	0.025	0.025	0.20-0.35	0.80-1.10	0.15 min.V	
A 6152	0.48-0.55	0.70-0.90	0.040	0.040	0.20-0.35	0.80-1.10	0.10 min.V	
A 9255	0.50-0.60	0.70-0.95	0.040	0.040	1.80-2.20	
A 9260(c)	0.55-0.65	0.75-1.00	0.040	0.040	1.80-2.20	
A 9262	0.55-0.65	0.75-1.00	0.040	0.040	1.80-2.20	0.20-0.40	

* Lowest standard maximum phosphorus or sulphur content for acid open-hearth or acid electric-furnace alloy steel is 0.05% each; silicon is 0.15% min.

(a) Sulphur range: 0.035 to 0.050%.

(b) See 52100 variations, page xix.

(c) See 9261 variation, page xix.

The 8600 and 8700 series, originally designated as N.E. steels, and given on the next page, were later incorporated into the regular series.

TABLE V
THE NATIONAL EMERGENCY STEELS

Revised May 26, 1944

In this revision of the N.E. steel composition limits, the 8700 series has been restored in a wider variety of carbon ranges. A new series, the 9700 series, has been established having hardenability characteristics similar to those of the 4000 series. A new series, the 9800 series, has been established having hardenability characteristics about half-way between those of the 8700 series and those of the 4300 series, in the thorough-hardening carbon ranges. A new series, the 9900 series, has been established in the low-carbon ranges, designed especially for carburizing and having hardenability characteristics similar to or slightly in excess of the 8700 series.

Classification	Designation	Composition					
		C	Mn	Si	Ni	Cr	Mo
C-Mn	N.E. 1330	0.28-0.33	1.60-1.90	0.20-0.35
	N.E. 1335	0.33-0.38	1.60-1.90	0.20-0.35
	N.E. 1340	0.38-0.43	1.60-1.90	0.20-0.35
	N.E. 1345	0.43-0.48	1.60-1.90	0.20-0.35
	N.E. 1350	0.48-0.53	1.60-1.90	0.20-0.35
	Ni-Cr-Mo	8000 and 8400 series, see below					
	N.E. 8612 *	0.10-0.15	0.70-0.90	0.20-0.35	0.40-0.70	0.40-0.60	0.15-0.25
	N.E. 8615	0.13-0.18	0.70-0.90	0.20-0.35	0.40-0.70	0.40-0.60	0.15-0.25
	N.E. 8617	0.15-0.20	0.70-0.90	0.20-0.35	0.40-0.70	0.40-0.60	0.15-0.25
	N.E. 8620	0.18-0.23	0.70-0.90	0.20-0.35	0.40-0.70	0.40-0.60	0.15-0.25
	N.E. 8622	0.20-0.25	0.70-0.90	0.20-0.35	0.40-0.70	0.40-0.60	0.15-0.25
	N.E. 8625	0.23-0.28	0.70-0.90	0.20-0.35	0.40-0.70	0.40-0.60	0.15-0.25
	N.E. 8627	0.25-0.30	0.70-0.90	0.20-0.35	0.40-0.70	0.40-0.60	0.15-0.25
	N.E. 8630	0.28-0.33	0.70-0.90	0.20-0.35	0.40-0.70	0.40-0.60	0.15-0.25
	N.E. 8632	0.30-0.35	0.70-0.90	0.20-0.35	0.40-0.70	0.40-0.60	0.15-0.25
	N.E. 8635	0.33-0.38	0.75-1.00	0.20-0.35	0.40-0.70	0.40-0.60	0.15-0.25
	N.E. 8637	0.35-0.40	0.75-1.00	0.20-0.35	0.40-0.70	0.40-0.60	0.15-0.25
	N.E. 8640	0.38-0.43	0.75-1.00	0.20-0.35	0.40-0.70	0.40-0.60	0.15-0.25
	N.E. 8642	0.40-0.45	0.75-1.00	0.20-0.35	0.40-0.70	0.40-0.60	0.15-0.25
	N.E. 8645	0.43-0.48	0.75-1.00	0.20-0.35	0.40-0.70	0.40-0.60	0.15-0.25
	N.E. 8647	0.45-0.50	0.75-1.00	0.20-0.35	0.40-0.70	0.40-0.60	0.15-0.25
	N.E. 8650	0.48-0.53	0.75-1.00	0.20-0.35	0.40-0.70	0.40-0.60	0.15-0.25
	N.E. 8712	0.10-0.15	0.70-0.90	0.20-0.35	0.40-0.70	0.40-0.60	0.20-0.30
	N.E. 8715	0.13-0.18	0.70-0.90	0.20-0.35	0.40-0.70	0.40-0.60	0.20-0.30
	N.E. 8717	0.15-0.20	0.70-0.90	0.20-0.35	0.40-0.70	0.40-0.60	0.20-0.30
	N.E. 8720	0.18-0.23	0.70-0.90	0.20-0.35	0.40-0.70	0.40-0.60	0.20-0.30
	N.E. 8722	0.20-0.25	0.70-0.90	0.20-0.35	0.40-0.70	0.40-0.60	0.20-0.30
	N.E. 8725	0.23-0.28	0.70-0.90	0.20-0.35	0.40-0.70	0.40-0.60	0.20-0.30
	N.E. 8727	0.25-0.30	0.70-0.90	0.20-0.35	0.40-0.70	0.40-0.60	0.20-0.30
	N.E. 8730	0.28-0.33	0.70-0.90	0.20-0.35	0.40-0.70	0.40-0.60	0.20-0.30
	N.E. 8732	0.30-0.35	0.70-0.90	0.20-0.35	0.40-0.70	0.40-0.60	0.20-0.30
	N.E. 8735	0.33-0.38	0.75-1.00	0.20-0.35	0.40-0.70	0.40-0.60	0.20-0.30
	N.E. 8737	0.35-0.40	0.75-1.00	0.20-0.35	0.40-0.70	0.40-0.60	0.20-0.30
	N.E. 8740	0.38-0.43	0.75-1.00	0.20-0.35	0.40-0.70	0.40-0.60	0.20-0.30
	N.E. 8742	0.40-0.45	0.75-1.00	0.20-0.35	0.40-0.70	0.40-0.60	0.20-0.30
	N.E. 8745	0.43-0.48	0.75-1.00	0.20-0.35	0.40-0.70	0.40-0.60	0.20-0.30
	N.E. 8747	0.45-0.50	0.75-1.00	0.20-0.35	0.40-0.70	0.40-0.60	0.20-0.30
	N.E. 8750	0.48-0.53	0.75-1.00	0.20-0.35	0.40-0.70	0.40-0.60	0.20-0.30
	N.E. 9415	0.13-0.18	0.80-1.10	0.20-0.35	0.30-0.60	0.30-0.50	0.08-0.15
	N.E. 9417	0.15-0.20	0.80-1.10	0.20-0.35	0.30-0.60	0.30-0.50	0.08-0.15
	N.E. 9420	0.18-0.23	0.80-1.10	0.20-0.35	0.30-0.60	0.30-0.50	0.08-0.15
	N.E. 9422	0.20-0.25	0.80-1.10	0.20-0.35	0.30-0.60	0.30-0.50	0.08-0.15
	N.E. 9425	0.23-0.28	0.90-1.20	0.20-0.35	0.30-0.60	0.30-0.50	0.08-0.15
	N.E. 9427	0.25-0.30	0.90-1.20	0.20-0.35	0.30-0.60	0.30-0.50	0.08-0.15
	N.E. 9430	0.28-0.33	0.90-1.20	0.20-0.35	0.30-0.60	0.30-0.50	0.08-0.15
	N.E. 9432	0.30-0.35	0.90-1.20	0.20-0.35	0.30-0.60	0.30-0.50	0.08-0.15
	N.E. 9435	0.33-0.38	0.90-1.20	0.20-0.35	0.30-0.60	0.30-0.50	0.08-0.15
	N.E. 9437	0.35-0.40	0.90-1.20	0.20-0.35	0.30-0.60	0.30-0.50	0.08-0.15
	N.E. 9440	0.38-0.43	0.90-1.20	0.20-0.35	0.30-0.60	0.30-0.50	0.08-0.15
	N.E. 9442	0.40-0.45	1.00-1.30	0.20-0.35	0.30-0.60	0.30-0.50	0.08-0.15
	N.E. 9445	0.43-0.48	1.00-1.30	0.20-0.35	0.30-0.60	0.30-0.50	0.08-0.15
	N.E. 9447	0.45-0.50	1.20-1.50	0.20-0.35	0.30-0.60	0.30-0.50	0.08-0.15
	N.E. 9450	0.48-0.53	1.20-1.50	0.20-0.35	0.30-0.60	0.30-0.50	0.08-0.15

TABLE V (Continued)

THE NATIONAL EMERGENCY STEELS

Revised May 26, 1944

Classification	Designation	Composition					
		C	Mn	Si	Ni	Cr	Mo
	9500 and 9600 series, see below						
	N.E. 9722	0.20-0.25	0.50-0.80	0.20-0.35	0.40-0.70	0.10-0.25	0.15-0.25
	N.E. 9727	0.25-0.30	0.50-0.80	0.20-0.35	0.40-0.70	0.10-0.25	0.15-0.25
	N.E. 9732	0.30-0.35	0.50-0.80	0.20-0.35	0.40-0.70	0.10-0.25	0.15-0.25
	N.E. 9737	0.35-0.40	0.50-0.80	0.20-0.35	0.40-0.70	0.10-0.25	0.15-0.25
	N.E. 9742	0.40-0.45	0.50-0.80	0.20-0.35	0.40-0.70	0.10-0.25	0.15-0.25
	N.E. 9745	0.43-0.48	0.50-0.80	0.20-0.35	0.40-0.70	0.10-0.25	0.15-0.25
	N.E. 9747	0.45-0.50	0.50-0.80	0.20-0.35	0.40-0.70	0.10-0.25	0.15-0.25
	N.E. 9750	0.48-0.53	0.50-0.80	0.20-0.35	0.40-0.70	0.10-0.25	0.15-0.25
	N.E. 9763	0.60-0.67	0.50-0.80	0.20-0.35	0.40-0.70	0.10-0.25	0.15-0.25
	N.E. 9768	0.64-0.72	0.50-0.80	0.20-0.35	0.40-0.70	0.10-0.25	0.15-0.25
	N.E. 9830	0.28-0.33	0.70-0.90	0.20-0.35	0.85-1.15	0.70-0.90	0.20-0.30
	N.E. 9832	0.30-0.35	0.70-0.90	0.20-0.35	0.85-1.15	0.70-0.90	0.20-0.30
	N.E. 9835	0.33-0.38	0.70-0.90	0.20-0.35	0.85-1.15	0.70-0.90	0.20-0.30
	N.E. 9837	0.35-0.40	0.70-0.90	0.20-0.35	0.85-1.15	0.70-0.90	0.20-0.30
	N.E. 9840	0.38-0.43	0.70-0.90	0.20-0.35	0.85-1.15	0.70-0.90	0.20-0.30
	N.E. 9842	0.40-0.45	0.70-0.90	0.20-0.35	0.85-1.15	0.70-0.90	0.20-0.30
	N.E. 9845	0.43-0.48	0.70-0.90	0.20-0.35	0.85-1.15	0.70-0.90	0.20-0.30
	N.E. 9847	0.45-0.50	0.70-0.90	0.20-0.35	0.85-1.15	0.70-0.90	0.20-0.30
	N.E. 9850	0.48-0.53	0.70-0.90	0.20-0.35	0.85-1.15	0.70-0.90	0.20-0.30
	N.E. 9912	0.10-0.15	0.50-0.70	0.20-0.35	1.00-1.30	0.40-0.60	0.20-0.30
	N.E. 9915	0.13-0.18	0.50-0.70	0.20-0.35	1.00-1.30	0.40-0.60	0.20-0.30
	N.E. 9917	0.15-0.20	0.50-0.70	0.20-0.35	1.00-1.30	0.40-0.60	0.20-0.30
	N.E. 9920	0.18-0.23	0.50-0.70	0.20-0.35	1.00-1.30	0.40-0.60	0.20-0.30
	N.E. 9922	0.20-0.25	0.50-0.70	0.20-0.35	1.00-1.30	0.40-0.60	0.20-0.30
	N.E. 9925	0.23-0.28	0.50-0.70	0.20-0.35	1.00-1.30	0.40-0.60	0.20-0.30
Si Mn	N.E. 9261	0.55-0.65	0.70-1.00	1.80-2.20	0.10-0.25
C Cr	N.E. 52100A	0.95-1.10	0.25-0.45	0.20-0.35	0.35 max.	1.30-1.60	0.08 max.
	N.E. 52100B	0.95-1.10	0.25-0.45	0.20-0.35	0.35 max.	0.90-1.15	0.08 max.
	N.E. 52100C	0.95-1.10	0.25-0.45	0.20-0.35	0.35 max.	0.40-0.60	0.08 max.
Other N.E. compositions are, or were, as follows: S and P each 0.04 max.							
	N.E. 8020	0.18-0.23	1.00-1.30	0.20-0.35	0.10-0.20
	N.E. 8024	0.22-0.28	1.00-1.30	0.20-0.35	0.10-0.20
	N.E. 8124	0.22-0.28	1.30-1.60	0.20-0.35	0.25-0.35
	N.E. 8233	0.30-0.36	1.30-1.60	0.20-0.35	0.10-0.20
	N.E. 8245	0.42-0.49	1.30-1.60	0.20-0.35	0.10-0.20
	N.E. 8339	0.35-0.42	1.30-1.60	0.20-0.35	0.20-0.30
	N.E. 8442 *	0.40-0.45	1.30-1.60	0.20-0.35	0.30-0.40
	N.E. 8447	0.43-0.50	1.30-1.60	0.20-0.35	0.30-0.40
	N.E. 8547	0.43-0.50	1.30-1.60	0.20-0.35	0.40-0.60
	N.E. 8613	0.12-0.17	0.70-0.90	0.20-0.35	0.40-0.70	0.40-0.60	0.15-0.25
	N.E. 8724	0.22-0.28	0.70-0.95	0.20-0.35	0.40-0.60	0.40-0.60	0.20-0.30
	N.E. 8739	0.35-0.42	0.75-1.00	0.20-0.35	0.40-0.60	0.40-0.60	0.20-0.30
	N.E. 8744	0.40-0.47	0.75-1.00	0.20-0.35	0.40-0.60	0.40-0.60	0.20-0.30
	N.E. 8749	0.45-0.52	0.75-1.00	0.20-0.35	0.40-0.60	0.40-0.60	0.20-0.30
	N.E. 8817	0.15-0.20	0.70-0.95	0.20-0.35	0.40-0.60	0.40-0.60	0.30-0.40
	N.E. 8949	0.45-0.52	1.00-1.35	0.20-0.35	0.40-0.60	0.40-0.60	0.30-0.40
	N.E. 9537 *	0.35-0.40	1.20-1.50	0.40-0.60	0.40-0.70	0.40-0.60	0.15-0.25
	N.E. 9540 *	0.38-0.43	1.20-1.50	0.40-0.60	0.40-0.70	0.40-0.60	0.15-0.25
	N.E. 9542 *	0.40-0.45	1.20-1.50	0.40-0.60	0.40-0.70	0.40-0.60	0.15-0.25
	N.E. 9550 *	0.48-0.53	1.20-1.50	0.40-0.60	0.40-0.70	0.40-0.60	0.15-0.25
	N.E. 9630	0.28-0.33	1.20-1.50	0.40-0.60	0.40-0.70	0.40-0.60	0.15-0.25
	N.E. 9635	0.33-0.38	1.20-1.50	0.40-0.60	0.40-0.60
	N.E. 9637	0.35-0.40	1.20-1.50	0.40-0.60	0.40-0.60
	N.E. 9640	0.38-0.43	1.20-1.50	0.40-0.60	0.40-0.60
	N.E. 9642	0.40-0.45	1.30-1.60	0.40-0.60	0.40-0.60
	N.E. 9645	0.43-0.48	1.30-1.60	0.40-0.60	0.40-0.60
	N.E. 9650	0.48-0.53	1.30-1.60	0.40-0.60	0.40-0.60

* Recommended for large sections only.

Many of the N.E. compositions are no longer available, but technical literature often refers to such steels, requiring that even those now considered obsolete be recorded.

TABLE VI

AMERICAN IRON AND STEEL INSTITUTE LIST OF H STEELS; CHEMICAL COMPOSITION RANGES

Electric-Furnace or Open-Hearth Bars, Billets, or Blooms

SAE or AISI Designation	Chemical Composition *					
	C	Mn	Si	Ni	Cr	Mo
2512H	0.08-0.15	0.35-0.65	0.20-0.35	4.70-5.30
2515H	0.11-0.18	0.35-0.65	0.20-0.35	4.70-5.30
2517H	0.16-0.21	0.35-0.65	0.20-0.35	4.70-5.30
3310H	0.07-0.14	0.35-0.65	0.20-0.35	3.20-3.80	1.35-1.75
3316H	0.13-0.20	0.35-0.65	0.20-0.35	3.20-3.80	1.35-1.75
4130H	0.27-0.34	0.35-0.65	0.20-0.35	0.80-1.15	0.15-0.25
4132H	0.30-0.37	0.35-0.65	0.20-0.35	0.80-1.15	0.15-0.25
4135H	0.32-0.39	0.60-0.95	0.20-0.35	0.80-1.15	0.15-0.25
4137H	0.35-0.43	0.60-0.95	0.20-0.35	0.80-1.15	0.15-0.25
4140H	0.37-0.45	0.70-1.05	0.20-0.35	0.80-1.15	0.15-0.25
4142H	0.40-0.48	0.70-1.05	0.20-0.35	0.80-1.15	0.15-0.25
4145H	0.42-0.50	0.70-1.05	0.20-0.35	0.80-1.15	0.15-0.25
4147H	0.44-0.52	0.70-1.05	0.20-0.35	0.80-1.15	0.15-0.25
4150H	0.46-0.54	0.70-1.05	0.20-0.35	0.80-1.15	0.15-0.25
4317H	0.14-0.21	0.40-0.70	0.20-0.35	1.50-2.00	0.35-0.65	0.20-0.30
4320H	0.16-0.23	0.40-0.70	0.20-0.35	1.50-2.00	0.35-0.65	0.20-0.30
4340H	0.37-0.45	0.60-0.95	0.20-0.35	1.50-2.00	0.65-0.95	0.20-0.30
4620H	0.17-0.24	0.40-0.70	0.20-0.35	1.50-2.00	0.20-0.30
4640H	0.37-0.45	0.55-0.85	0.20-0.35	1.50-2.00	0.20-0.30
4815H	0.12-0.19	0.35-0.65	0.20-0.35	3.20-3.80	0.20-0.30
4820H	0.17-0.24	0.45-0.75	0.20-0.35	3.20-3.80	0.20-0.30
8620H	0.17-0.24	0.60-0.95	0.20-0.35	0.35-0.75	0.35-0.65	0.15-0.25
8622H	0.20-0.27	0.60-0.95	0.20-0.35	0.35-0.75	0.35-0.65	0.15-0.25
8625H	0.22-0.29	0.60-0.95	0.20-0.35	0.35-0.75	0.35-0.65	0.15-0.25
8627H	0.25-0.32	0.60-0.95	0.20-0.35	0.35-0.75	0.35-0.65	0.15-0.25
8630H	0.27-0.34	0.60-0.95	0.20-0.35	0.35-0.75	0.35-0.65	0.15-0.25
8632H	0.30-0.37	0.60-0.95	0.20-0.35	0.35-0.75	0.35-0.65	0.15-0.25
8635H	0.32-0.39	0.70-1.05	0.20-0.35	0.35-0.75	0.35-0.65	0.15-0.25
8637H	0.35-0.43	0.70-1.05	0.20-0.35	0.35-0.75	0.35-0.65	0.15-0.25
8640H	0.37-0.45	0.70-1.05	0.20-0.35	0.35-0.75	0.35-0.65	0.15-0.25
8642H	0.40-0.48	0.70-1.05	0.20-0.35	0.35-0.75	0.35-0.65	0.15-0.25
8645H	0.42-0.50	0.70-1.05	0.20-0.35	0.35-0.75	0.35-0.65	0.15-0.25
8647H	0.44-0.52	0.70-1.05	0.20-0.35	0.35-0.75	0.35-0.65	0.15-0.25
8650H	0.46-0.54	0.70-1.05	0.20-0.35	0.35-0.75	0.35-0.65	0.15-0.25
8720H	0.17-0.24	0.60-0.95	0.20-0.35	0.35-0.75	0.35-0.65	0.20-0.30
8722H	0.20-0.27	0.60-0.95	0.20-0.35	0.35-0.75	0.35-0.65	0.20-0.30
8725H	0.22-0.29	0.60-0.95	0.20-0.35	0.35-0.75	0.35-0.65	0.20-0.30
8727H	0.25-0.32	0.60-0.95	0.20-0.35	0.35-0.75	0.35-0.65	0.20-0.30
8730H	0.27-0.34	0.60-0.95	0.20-0.35	0.35-0.75	0.35-0.65	0.20-0.30
8732H	0.30-0.37	0.60-0.95	0.20-0.35	0.35-0.75	0.35-0.65	0.20-0.30
8735H	0.32-0.39	0.70-1.05	0.20-0.35	0.35-0.75	0.35-0.65	0.20-0.30
8737H	0.35-0.43	0.70-1.05	0.20-0.35	0.35-0.75	0.35-0.65	0.20-0.30
8740H	0.37-0.45	0.70-1.05	0.20-0.35	0.35-0.75	0.35-0.65	0.20-0.30

TABLE VI (Continued)

AMERICAN IRON AND STEEL INSTITUTE LIST OF H STEELS; CHEMICAL COMPOSITION RANGES

Electric-Furnace or Open-Hearth Bars, Billets, or Blooms

SAE or AISI Designation	Chemical Composition *					
	C	Mn	Si	Ni	Cr	Mo
8742H	0.40-0.48	0.70-1.05	0.20-0.35	0.35-0.75	0.35-0.65	0.20-0.30
8745H	0.42-0.50	0.70-1.05	0.20-0.35	0.35-0.75	0.35-0.65	0.20-0.30
8747H	0.44-0.52	0.70-1.05	0.20-0.35	0.35-0.75	0.35-0.65	0.20-0.30
8750H	0.46-0.54	0.70-1.05	0.20-0.35	0.35-0.75	0.35-0.65	0.20-0.30
9420H	0.17-0.24	0.80-1.15	0.20-0.35	0.25-0.65	0.25-0.55	0.08-0.15
9422H	0.20-0.27	0.80-1.15	0.20-0.35	0.25-0.65	0.25-0.55	0.08-0.15
9425H	0.22-0.29	0.80-1.15	0.20-0.35	0.25-0.65	0.25-0.55	0.08-0.15
9427H	0.25-0.32	0.80-1.15	0.20-0.35	0.25-0.65	0.25-0.55	0.08-0.15
9430H	0.27-0.34	0.85-1.25	0.20-0.35	0.25-0.65	0.25-0.55	0.08-0.15
9432H	0.30-0.37	0.85-1.25	0.20-0.35	0.25-0.65	0.25-0.55	0.08-0.15
9435H	0.32-0.39	0.85-1.25	0.20-0.35	0.25-0.65	0.25-0.55	0.08-0.15
9437H	0.35-0.43	0.85-1.25	0.20-0.35	0.25-0.65	0.25-0.55	0.08-0.15
9440H	0.37-0.45	0.85-1.25	0.20-0.35	0.25-0.65	0.25-0.55	0.08-0.15
9442H	0.40-0.48	0.95-1.35	0.20-0.35	0.25-0.65	0.25-0.55	0.08-0.15
9445H	0.42-0.50	0.95-1.35	0.20-0.35	0.25-0.65	0.25-0.55	0.08-0.15
9447H	0.44-0.52	1.15-1.55	0.20-0.35	0.25-0.65	0.25-0.55	0.08-0.15
9450H	0.46-0.54	1.15-1.55	0.20-0.35	0.25-0.65	0.25-0.55	0.08-0.15

These chemical compositions apply to steels produced to definite hardenability limits. Composition limits and hardenability bands are intended to apply to steels manufactured to "fine-grained steel practice."

Sizes and Shapes. The ranges and limits in this table apply only to material not exceeding 100 sq in. in cross-sectional area, or 18 in. in width, or 7000 lb in weight, per piece as the total product of the ingot, and exclude all plate, shapes, sheet, strip and slabs.

* *Permissible Chemical Variations.* Phosphorus and sulphur in open-hearth steel to be 0.040% max. each.

Phosphorus and sulphur in electric-furnace steel to be 0.025% max. each.

Small quantities of certain elements may be found in alloy steel which are not specified or required. These elements are to be considered as incidental and acceptable to the following maximum amounts: Copper 0.35%, nickel 0.25%, chromium 0.20%, molybdenum 0.06%.

The chemical ranges and limits shown are subject to the standard permissible variations for check analysis over the maximum limit or under the minimum limit. These permissible variations are: 0.01 for all ranges of carbon; 0.03 for manganese up to and including 0.90%, and 0.04 for over 0.90 to 1.55% inclusive; 0.005 for either phosphorus or sulphur; 0.02 for silicon; 0.03 for nickel up to and including 1.00%, 0.05 for nickel over 1.00 up to and including 2.00%, and 0.07 over 2.00 up to and including 5.30%; 0.03 for chromium up to 0.90% inclusive, and 0.05 for chromium over 0.90 to 1.75% inclusive; 0.01 for molybdenum up to 0.20% inclusive, 0.02 for molybdenum over 0.20 to 0.30% inclusive.

Quality Conditions. All conditions and quality features, except as detailed above, shall be in accordance with the regulation, shown in the American Iron and Steel Institute's *Steel Products Manual*, Section 10 on Alloy Steels.

TABLE VI (Continued)

LATER H STEELS

In June 1947 the list of H steels was expanded to include the following:

SAE or AISI Designation	Chemical Composition					
	C	Mn	Si	Ni	Cr	Mo
1320H	0.17-0.24	1.50-2.00	0.20-0.35
1330H	0.27-0.34	1.50-2.00	0.20-0.35
1335H	0.32-0.39	1.50-2.00	0.20-0.35
1340H	0.37-0.45	1.50-2.00	0.20-0.35
4812H	0.10-0.17	0.30-0.60	0.20-0.35	3.20-3.80	0.20-0.30
4817H	0.14-0.21	0.35-0.65	0.20-0.35	3.20-3.80	0.20-0.30
5140H	0.37-0.45	0.60-0.95	0.20-0.35	0.65-0.95
5145H	0.42-0.50	0.60-0.95	0.20-0.35	0.65-0.95
5150H	0.46-0.54	0.60-0.95	0.20-0.35	0.65-0.95
6150H	0.46-0.54	0.60-0.95	0.20-0.35	0.80-1.15 V, 0.15 min.
8617H	0.14-0.21	0.60-0.95	0.20-0.35	0.35-0.75	0.35-0.65	0.15-0.25
8641H	0.37-0.45	0.70-1.05	0.20-0.35	0.35-0.75	0.35-0.65	0.15-0.25 S, 0.04-0.06
8655H	0.50-0.60	0.70-1.05	0.20-0.35	0.35-0.75	0.35-0.65	0.15-0.25
8660H	0.55-0.65	0.70-1.05	0.20-0.35	0.35-0.75	0.35-0.65	0.15-0.25
9260H	0.55-0.65	0.70-1.05	1.80-2.20
9261H	0.55-0.65	0.70-1.05	1.80-2.20	0.05-0.35
9262H	0.55-0.65	0.70-1.05	1.80-2.20	0.20-0.50

The following were omitted:

8722H
8725H
8227H
8332H
9420H
9422H
9425H
9427H
9430H
9435H
9447H
9450H

METALLURGICAL JOURNALS

Specifications, Cross Indices. A variety of specifications exist for closely similar steels. Useful lists of these are:

Cross index of chemical equivalent specifications and identification code, 1945, General Motors Corp., Detroit, Mich.

Preferred aeronautical steel specifications, *Steel*, V. 114, March 13, 1944, pp. 104-08.

Abbreviations. In the bibliographies at the ends of the chapters, the names of journals cited are abbreviated, as follows:

Journals of National Societies

ASM—American Society for Metals, 7301 Euclid Avenue, Cleveland, Ohio: *Metals Handbook* (periodically revised); *Metal Progress* (monthly); *The Metals Review* (monthly—current abstracts of current literature); *ASM Metal Literature Review* (annual). Many special volumes of symposia or of special lecture series are issued in book form.

ASTM—American Society for Steel Treating, 7301 Euclid Avenue, Cleveland, Ohio (earlier name of ASM).

AIME—American Institute of Mining & Metallurgical Engineers, 29 West 39th Street, New York 18, N. Y.: Some articles on heat treatment are in the annual *Transactions* of the Iron and Steel Division. Others appear as "Technical Publications" in *Metals Technology* (monthly).

ASTM—American Society for Testing Materials, 1916 Race Street, Philadelphia 3, Pa.: *Proceedings* (annual); *Bulletin* (monthly); Standard and Tentative Specifications, both for materials and methods of testing, are published every few years. Those for metals are in a separate volume.

AFA—American Foundrymen's Association, 222 West Adams Street, Chicago, Ill.: *Transactions* (annual); *Bulletin* (monthly); Handbooks (periodically revised).

SAE—Society of Automotive Engineers, 29 West 39th Street, New York 18, N. Y.: *Transactions* (annual); *Journal* (monthly).

AISI—American Iron and Steel Institute, 350 Fifth Avenue, New York, N. Y.: *Yearbook*.

I&S.I.—(British) Iron & Steel Institute, 4 Grosvenor Gardens, London SW 1, England: *Proceedings and Abstracts* (semiannual); *Current Abstracts* (monthly).

AISI—American Iron & Steel Institute, 4 Grosvenor Gardens, London SW 1, England: *Proceedings and Abstracts* (semiannual); *Current Abstracts* (monthly).

ASME—American Society of Mechanical Engineers, 29 West 39th Street, New York 18, N. Y.: *Transactions* (annual); *Mechanical Engineering* (monthly); *Journal of Applied Mechanics* (monthly).

AWS—American Welding Society, 29 West 39th Street, New York 18, N. Y.:
Welding Journal (monthly); Welding Research Council, separate (monthly);
Transactions (annual).

Other Metallurgical Journals Often Cited

Iron Age—100 East 42nd Street, New York 17, N. Y. (weekly).

Steel—Penton Building, Cleveland 13, Ohio (weekly).

The Foundry—Penton Building, Cleveland 13, Ohio (monthly).

Machine Design—Penton Building, Cleveland 13, Ohio (monthly).

Materials and Methods (formerly *Metals and Alloys*)—330 West 42nd Street,
New York 18, N. Y. (monthly).

Product Engineering—330 West 42nd Street, New York 18, N. Y. (monthly).

Canadian Metals and Metallurgical Industries—137 Wellington Street, Toronto
1, Ontario, Canada.

Industrial Heating—Union Trust Building, Pittsburgh, Pa.

Iron and Steel—Dorset House, Stamford Street, London SE 1, England.

Journal of Research—National Bureau of Standards, Government Printing
Office, Washington, D. C. (Earlier, Scientific Papers of the Bureau of
Standards, Technologic Papers of the Bureau of Standards).

Metal Treatment—49 Wellington Street, Strand, London WC 2, England.

Metallurgia—21 Albion Street, Gaythorn, Manchester 1, England.

Sheet Metal Industries—49 Wellington Street, Strand, London WC 2, England.

Steel Processing—108 Southfield Street, Pittsburgh 30, Pa.

Wire and Wire Products—300 Main Street, Stamford, Conn.

SECTION I. CONTROL OF SURFACE CONDITIONS

CHAPTER 1

NEED FOR SURFACE STRENGTH

Wear and fatigue start at the surface. Even when these factors are not present, the surface is still the "Achilles' heel."

Rarely indeed is a metal piece in actual service uniformly stressed throughout its section. Even in the laboratory, it is difficult to align a tensile specimen in a testing machine so accurately as to avoid having some one location on the circumference more highly stressed than any other. Engine connecting rods are supposed to be uniformly stressed, but they never are. Somewhere on the surface comes a stress higher than the one figured. The rod, however, must not take a permanent set.

Tension members of bridges likewise have initial misalignment, and slight plastic deformation at the overstressed surface or slip in riveted joints, or both, occur until the stress does become uniform. Extremely small deformations are usually sufficient.

Rotating shafts have maximum stress at the surface, minimum at the center. The surface of a metal part must either withstand maximum stress, by virtue of having a yield strength greater than that stress, or yield until the local excess stress has been distributed.

It is at the surface, also, that stress concentration appears, from nicks, scratches, toolmarks, poor fillets and the like, and so the surface must be capable of withstanding the local overstress thereby developed. Wear (whether of the abrasive or the battering type), seizure, and galling also occur at the surface and produce stress raisers. If only single static loads had to be withstood, with no need for combating wear or fatigue, the surface condition would cause little concern, for design necessarily applies materials of suitable yield strength. However, fatigue failures occur at lower nominal stresses, since the endurance limit, and particularly the notched endurance limit, come, especially in the stronger steels, far below the yield strength, as Fig. 95, Vol. I, shows.

As that figure also shows, the notched fatigue limit remains low in the stronger steels, although the fatigue limit for polished specimens rises as static strength increases. When wear or other external damage would produce a stress-raising notch on a soft surface, the surface is often hardened to prevent the formation of a notch. Case carburizing is the oldest method of hardening the surface. Many considerations affecting carburized cases apply also to other ways of surface hardening.

For reasons of cost, machinability, and amenability to processing, material equally hard all the way through may be inapplicable. The inapplicability is more often in relation to prior processing than to service performance.

Shallow-hardening high-C steels, hardened after machining, might appear suitable for providing a wear-resistant surface, but the desired combination of machinability, surface hardness, depth of hard exterior, freedom from quench cracking, and core properties after a heat treatment that is suitable for the wear-resisting surface is not easy to achieve, especially in irregular objects.

The traditional approach has been to create an extremely hard surface or case of a different chemical composition upon an extremely tough core. The needed properties of the case can be readily visualized. Those of the core are not so obvious. The value of core toughness has, however, been vastly overestimated, on the basis of laboratory tests on the core material by itself. The actual object has both case and core. The composite piece is brittle rather than tough.

Necessary Properties of the Core. The core needs two rather contradictory properties. It needs to be relatively strong in order to support the thin case. (The heavier the case, the more it tends to be self-supporting, but the greater the tendency of the case toward brittleness.) The core also needs to be "tough," but the toughness is not necessarily of the kind that is measurable by the standard tensile, impact, and bend tests. What is really desired is resistance to notch propagation. That is, if the case does crack, the crack should stop when it reaches the core, instead of continuing on through the core. Mere ductility, as ordinarily measured, does not guarantee resistance to notch propagation. For example, if an annealed brass wire that, uncoated, can be twisted about itself is given a thin Cr plating, the plated wire will snap off on being bent through a small angle. If the plating is dissolved off, the bared wire will again stand severe twisting. The crack formed in the brittle coating progresses through the wire, which is tough and ductile by all ordinary criteria.

The desired end is that the carburized piece, core and case together, shall show toughness, as a structure. However, in most instances, any appreciable distortion of a carburized part in service would be a functional failure, so that there is a growing degree of skepticism as to the necessity for large deformation of a carburized part before it will snap. Almen and Boegehold¹ decided that, in rear-axle-gear service, impact is not much of a factor and that a choice among carburizing steels cannot be made on the basis of impact results alone, even when the impact test is made on an unnotched bar with the case present.

Much of the emphasis laid on the "toughness" of a carburizing steel, put through the carburizing and heat-treating cycle and tested to simulate the core, without the case (or carburized and the case ground off before testing), seems of doubtful import since the core is not actually used without the case, and the toughness measured without the case may be quite illusory. The chief need for great resistance to notch propagation is not in normal service, but, instead, in allowing the straightening of warped carburized parts before they are put in service. A better engineering solution is to choose a steel and a treatment that do not cause severe warping.

Brittleness. The impact properties of the toughest carburized steels are low. The core alone, put through the heat-treating cycle, but without being carburized, may show 50 to 100 ft-lb Izod. Tested as carburized notched bars, McQuaid and McMullan² found that only 1 to 10 ft-lb was obtained in many cases, and values of 20 ft-lb or over were obtained only on certain Ni-Mo steels. Other Ni-Mo steels of similar composition gave 3 to 6 ft-lb, the difference probably being due to difference in grain size.

Gerstman and MacPherson¹⁰ used a specimen $10\frac{1}{4}$ in. long by $\frac{7}{16}$ in. in diameter, carburized along with work of like section, which was tested on a 8-in. span, deflected with a 12-in.-radius bending block. The deflection is noted at which a snap is heard from the cracking of the case. Free carbide in the case or slack quenching which produces bainite reduce the deflection, from the figure of around 0.25 in. obtained with suitable case thickness and structure. They found thinner cases preferable when the core hardness was relatively high.

McMullan³ has presented a large amount of data on case and core properties of carburizing steels, all in three conditions of treatment. Carburizing was at 1700°, the steels being either (1) direct-quenched, (2) single-treated, that is, slow-cooled, heated, and quenched, or (3) double-treated, that is, slow-cooled, reheated, quenched, again

reheated, and quenched. Except 1020, all were quenched in oil. The temperatures used in single and double treatments are shown in Table 1. Either the single or the double treatment was concluded with a 325° draw.

TABLE 1

Steel	TEMPERATURE	
	Single Deg.	Double Deg.
1020	1425 water	1625 (oil) 1425 (water)
2315	1475	1550 - 1380
3115	1475	1550 - 1425
4615	1500	1550 - 1400
2512	1450	1550 - 1350
6115	1625	1650 - 1475
Cr-Ni-Mo	1500
Krupp	1450	1550 - 1400
4820	1475	1550 1400

The compositions and McQuaid-Ehn grain sizes are shown in Table 2.

TABLE 2

	Grain Size	C %	Mn %	Ni %	Cr %	Mo %	V %
1020	2-7	0.16	0.59
1020	2-3	0.19	0.54
2315	7	0.19	0.61	3.62
2315	2-3	0.16	0.42	3.60
3115	2-7	0.18	0.48	1.32	0.65
3115	2-6	0.15	0.47	1.30	0.59
4615	7-8	0.17	0.54	1.77	0.25
4615	3	0.16	0.54	1.82	0.24
2512	6-7	0.15	0.53	5.00
2512	5	0.16	0.45	4.94
6115	8	0.18	0.76	0.89	0.18
Cr-Ni-Mo	4	0.16	0.82	1.75	0.80	0.40
Cr-Ni-Mo	4	0.25	0.67	1.76	0.80	0.40
Krupp	7	0.08	0.48	3.99	1.48
4820	7	0.18	0.63	3.49	0.24

The properties for the three treatments are shown in Tables 3, 4, and 5.

All these specimens were carburized to give the usual high-C case. Impact tests were also made on specimens with low-C cases, not file hard. With such cases the core toughness was more nearly approached.

TABLE 3
CORE PROPERTIES—DIRECT QUENCH 1700° OIL* (Unless Noted)

Steel	Grain Size	Tensile	Yield †	Elong., %	R.A., %	Average Izod			Avg. Rockwell-C Hardness of Case	File Test
						Notched		Un-notched, with Case		
						Without Case	With Case			
1020	2-7 §	102,000	45,000	18	54.5	42	5	9	64	hard
1020	2-3 §	109,000	40,000	14	33.5	16	4	14	64	hard
2315	7	166,500	75,000	14.5	44.7	34	8	25	54	soft skin
2315	2-3	155,000	75,000	13.5	45	31	10	30	55	soft skin
3115	2-7	127,000	60,000	18.5	52	42	5	13	58	hard
3115	2-6	108,000	45,000	23.5	63.5	83	7	20	59	hard
4615	7-8	115,000	55,000	25.5	64.5	96	8	18	59	hard
4615	3	134,000	55,000	15	55	30	7	15	58	hard
2512	6-7	191,000	110,000	13.5	50	32	8	26	53	soft
2512	5	197,000	120,000	14.5	50.5	29	6	20	53	soft
6115	8	131,000	70,000	20.5	61.5	80	6	13	56	soft
Cr-Ni-Mo	4	168,000	80,000	15.5	56	42	8	18	53	hard, light soft skin
Cr-Ni-Mo	4 ¶	225,000	135,000	12.5	47.5	33	6	15	50	hard, light soft skin
Krupp	7	157,000	75,000	17.5	65	77	9	23	50	hard, light soft skin
4820	7	142,000	65,000	19	55	..	9	28	59	hard, light soft skin

* To correspond to pot quench.

† Johnson limit.

‡ High-C case—specimens notched before carburizing.

§ Water.

|| Variable.

¶ Machined to size before treating.

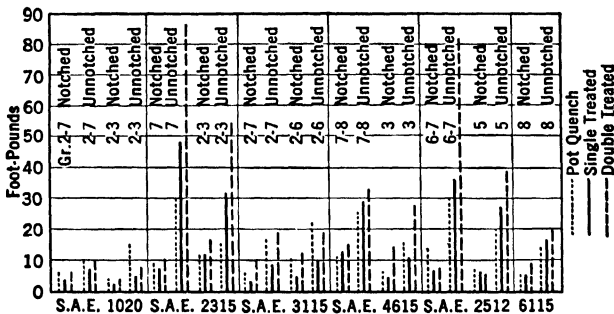

The grain size shown is by the McQuaid-Ehn test. (McMullan 3)

TABLE 4
CORE PROPERTIES—SINGLE TREATMENT

Steel	Grain Size	Tensile	Yield	Elong., %	R.A., %	Average Izod			Avg. Rockwell-C Hardness of Case	File Test
						Notched		Un-notched, with Case		
						Without Case	With Case			
1020	2-7	83,000	30,000	32.5	62	60	3	6	63	hard
1020	2-3	92,000	30,000	24.5	45.5	13	2	4	63	hard
2315	7	149,000	65,000	18.5	50.5	48	7	40 *	58	soft
2315	2-3	131,000	50,000	19	59	56	9	18 *	58	soft
3115	2 7	125,000	40,000	23.5	50.5	49	2 1/2	7	62	hard
3115	2-6	100,000	30,000	28	59.5	66	3	6	62	hard
4615	7-8	114,000	50,000	27.5	62	87	12	16 *	61	hard
4615	3	125,000	55,000	20.5	61	40	4	8 *	61	hard
2512	6-7	187,000	105,000	15.5	54.5	32	7	30 *	56	soft
2512	5	197,000	115,000	15	56.5	27	4	15	57	soft
6115	8	127,000	65,000	23.5	59.5	81	5	34 *	62	hard,
Cr-Ni-Mo	4	150,000	65,000	15.5	62	58	8	14	61	soft skin
Cr-Ni-Mo	4 †	231,000	135,000	14	49.5	33	4	9	61	hard,
Krupp	7	151,000	70,000	18	64.5	65	5	13 *	61	soft skin
4820	7	135,000	60,000	21	59.5	61	6	25	60	hard

* Results variable.

† Machined to size before treating.

Average impact results for all case depths and C contents are lumped together for six of the steels in the accompanying chart. By comparing this chart with the data of the tables, for specimens without cases, it may be seen that the toughness of the core itself is *not* necessarily closely reflected in the toughness of the carburized part.

Unnotched impact specimens are often used to evaluate the toughness of the core, since, at the low draws used to maintain file hardness of the case, the impact resistance is so low that the differentiation between steels is none too clear with notched bars. Impact results on unnotched case-hardened bars are usually quite variable.

Almen and Boegehold,¹ using unnotched impact specimens, studied a series of steels, carburized at 1650° for 4 and 8 hr, and tested with the case removed from all but one face of the impact bar. The steels were given a variety of heat treatments, that is, direct-

TABLE 5
CORE PROPERTIES—DOUBLE TREATMENT

Steel	Grain Size	Tensile	Yield	Elong., %	R.A., %	Average Izod			Avg. Rockwell-C Hardness of Case	File Test
						Notched		Un-notched, with Case		
						Without Case	With Case			
1020	2-7	82,000	35,000	34	69	98	4½	10	65	hard
1020	2-3	86,000	35,000	30	59	51	4	14 *	65	hard
2315	7	125,000	35,000	29.5	54	57	8	28 *	56	fairly hard, soft skin
2315	2-3	113,000	35,000	28	57	76	11	30 *	57	fairly hard, soft skin
3115	2-7	117,000	40,000	28	52	59	6	13 *	59	hard, thin soft skin
3115	2-6	100,000	30,000	32.5	60.5	79	8	20 *	60	hard, thin soft skin
4615	7-8	108,000	40,000	32	64	93	9	20 *	60	hard, thin soft skin
4615	3	109,000	40,000	29.5	56.5	71	7	16 *	59	hard, thin soft skin
2512	6-7	153,000	60,000	15.5	55	42	8	26	53	soft, deep skin
2512	5	147,000	55,000	17.5	56	54	7	20	54	soft, deep skin
6115	8	112,000	40,000	27.5	56.5	56	6	13 *	57	hard, below soft skin
Cr-Ni-Mo	4	8	18	52	hard, below thin skin
Cr-Ni-Mo	4	5	14	50	hard, below thin skin
Krupp	7	156,000	75,000	19	65.5	67	8	33	50	hard, below thin skin
4820	7	134,000	60,000	21	60.5	60	9	28	58	hard, below thin skin

* Results variable.

quenched, slow-cooled, reheated, and quenched, reheated to and quenched from a range of temperatures. Although the original should be consulted for the data for each heat treatment, the ranges for the lower-C steels are shown in Table 6.

All specimens were drawn at 300°. When 0.30% C steels were used, the results shown in Table 7 were obtained.

A gradual transition, so that the case does not spall off, is wanted. With that accomplished, what carburized part will stand a degree of permanent bending that calls for extreme core toughness? Only

TABLE 6

	C %	Mn %	Ni %	Mo %	Range of Impact Tests, Unnotched Bars, ft-lb
2315	0.15-0.18	0.40-0.55	3.60-3.70	90-152
2512	0.12	0.47	4.90	56-119
4815	0.15	0.49	3.44	0.34	55-149
1315	0.14	2.14	6½-20 *, 90 †
.....	0.17	1.75	(Coarse grain) 0.23	10-25 ‡, 31-46 §, 61-90
				(Fine grain)	

* Direct-quench; slow-cool, reheat 1475°, quench; or cool direct to 1375° and quench from that temperature.

† Direct-quench, reheat 1400°, quench.

‡ Cooled direct to 1375°, quenched from that temperature or slow-cooled, reheated 1475°, quenched.

§ Quenched, reheated 1400°, quenched.

|| Direct-quench.

TABLE 7

	C %	Mn %	Ni %	Cr %	Unnotched Izod
2330	0.31	0.70	3.31	12-47 *
3130	0.31	0.64	1.14	0.70	10-14

* These extreme results were on duplicates, quenched direct, reheated 1330°.

one comes to mind: tire cross-chains.⁹ Here the case is applied in order to slow down initial wear. Wear is inevitable and goes on after the case is entirely removed from the wearing surface, when toughness comes into play. A thin hard surface is no great help in many other applications; for example, carburizing the jaws of a jaw crusher would do little good. Battering tools are not carburized; they are given a balance between hardness and toughness in the body. If greater wear resistance is sought, they are "hard-surfaced" with a special high-alloy layer, often an austenitic one, by welding.

If the piece is ruined for service when it becomes abraded or battered, as is true of most carburized parts, core hardness is more essential than core toughness, and the thickness of case on a core hard enough to support it need be only that corresponding to the permissible wear, plus whatever is needed to produce a good transition from case to core, plus whatever further is needed for proper cleaning up to the desired thickness of case in final grinding. The

worse the warpage, the heavier the case needs to be to provide this finish and leave the proper case thickness over the high spots of warpage. Prevention of warpage is therefore paramount in avoiding the necessity for applying a thick case and leaving more than is needed over most of the surface in order to leave as much as is needed over warped spots. Carburizing time that would be required for making a thick case is therefore decreased as warpage is decreased. The fewer the heatings and coolings, the less the opportunity for warping; hence the single quench, thin cases, and a hard core to support the thin case are coming into favor.

Hard surface layers, of any type, usually have different coefficients of thermal expansion from whatever has been used as the core and thus have a tendency to split off or spall, especially if drastic temperature changes are involved in processing or use. Hence a gradual blending of the case structure into the core structure is usually sought when hard surfaces are provided. Another reason is that of matching the strength gradient of the material with the applied stress gradient. If the fatigue-resistant layer is too thin and is underlain by one weak in fatigue, failure may occur in that region where the strength is inadequate. Under such conditions fatigue failures can and do start beneath the surface rather than at it. Thus the preference for thin cases is modified in connection with fatigue-resistant cases where the stress gradient is steep and failure would start beneath the case were the case too thin.

Soft Surfaces. The reverse case, that of a softer surface on a harder one, is seldom sought in heat-treated steel; indeed, every effort is usually made to avoid it. For deep drawing, the soft surface of rimmed or decarburized steel may be advantageous, but, for fatigue resistance or wear resistance, it is fatal. Figures 13 and 95, Vol. I, demonstrate how rapidly fatigue resistance decreases with strength and how the strength decreases as the C content of steel decreases. In hypereutectoid tool steels, where the properties are in part due to carbide particles, performance decreases even though the measured hardness is not lowered. Since fatigue resistance is a function of surface hardness, even slight decarburization greatly depreciates fatigue resistance. This is abundantly proved in the cases of springs and equally in aircraft tubing and automobile rear axles.

Low Endurance Limits of Commercial Springs. Hankins and co-workers⁵ took up the spring-fatigue problem in detail. They compared Si-Mn and Cr-V spring steel of

C %	Si %	Mn %	Cr %	V %	
0.54	1.95	0.94	1740° oil
0.55	0.29	0.68	1.16	0.27	1560° oil

Drawn back to 470 Brinell the Si-Mn had 152,000 proportional limit, and the Cr-V 157,000, and the endurance limits, on rotating-beam specimens polished after heat treatment, were 98,500 and 107,500; but, tested *as springs* in rolled unmachined heat-treated plates, neither one gave safe stress ranges greater than zero to 45,000.

This led to a study of endurance of the two steels as rotating-beam specimens, with the specimens tempered at 930° for the Si-Mn and 1110° for the Cr-V, which brought the Brinells to 450-470 and 380-395, respectively. The quenching temperatures used were, respectively, much higher for the Cr-V than the 1600-1625° specified by the ASM and somewhat lower than specified for the Si-Mn, and the comparison is marred by the difference in hardness. However, the comparison is of interest.

	Si-Mn	Cr-V
Surface completely polished after treatment...	103,000	94,000
Normal heating for quenching, not polished...	60,500	71,500
More heavily decarburized than normal, not polished.....	47,000	45,000
Heated in cyanide, not polished.....	105,000 *	98,000 †

* Brinell hardness surface 460, interior 400.

† Brinell hardness surface 550, interior 420.

Repeated bending tests of flat specimens, run to see whether results agreed with those from rotary bending, gave:

	Safe-Stress Range	
	Si-Mn	Cr-V
Completely polished.....	0-123,000	0-125,000
Normal heating, not polished.....	0- 85,000	0-101,000
Long heating, not polished.....	0- 57,000	0- 83,000
Cyanide heating, not polished.....	0-107,000	0-107,500

Effect of Decarburization on Endurance of Springs. The tests show that the difference in the endurance of the two steels is due to differences in surface condition, and that the Si-Mn steel is more prone to decarburize than the Cr-V. If the springs are polished free of the decarburized layer, or, if decarburization is prevented, any other differences become very small indeed. That results on spring materials may be extremely variable can be shown by tabulating

TABLE 8

Spring Steels	C %	Si %	Cr %	V %	Fracture Grain Size	Tensile	Rotating Beam, Endurance Limit Rod		Torsion, Endur- ance Limit 0-Max. Rod		Endur- ance Limit as Springs	Single- Blow Impact,* ft-lb
							Polished	60° V Notch	Polished	Notched		
Acid open-hearth carbon...	0.91	4	218,000	80,000	36,000	102,000	80,000	70,000	18
Basic electric carbon.....	1.04	4	237,000	98,000	48,000	123,000	95,000	93,000	10
Cr-V basic electric.....	0.52	..	0.88	0.21	8	237,000	104,000	28,000	128,000	73,000	77,000	15
Si-Mn basic electric.....	0.53	1.96	7	236,000	112,000	35,000	138,000	63,000	68,000	18
Basic open-hearth carbon.	1.05	4	206,000	100,000	64,000	110,000	73,000	..
Electric carbon.....	1.05	4	205,000	93,000	80,000	90,000	63,000	..
Si-V.....	0.94	0.63	..	0.17	..	205,000	102,000	70,000	58,000	..

* Round specimen 0.5-in. diam. 60° V notch. 0.38-in. diam. at base. 0.03-in. radius at bottom.

data from Johnson⁶ and from Edgerton⁷ for endurance of rod (with decarburization removed) from which coil springs were made, and of the springs themselves.

No type of endurance test of the spring stock placed the steels in exactly the same order as did the test on finished springs, which may be affected by differences in decarburization and in grain size.

If the stock is ground free from decarburization or if decarburization is prevented, most users appear to find that springs of equal yield strength are practically equivalent in ordinary service, if they have had quenching stresses well relieved.

The overwhelming importance of the avoidance of decarburization makes a discussion of spring steels practically synonymous with a discussion of controlled atmospheres for heating for hot working and for quenching without decarburization.

Decarburization of SAE 4130. In a study⁸ of the behavior of normalized 4130 steel, showing 115,000 psi tensile, 225 Vickers, the

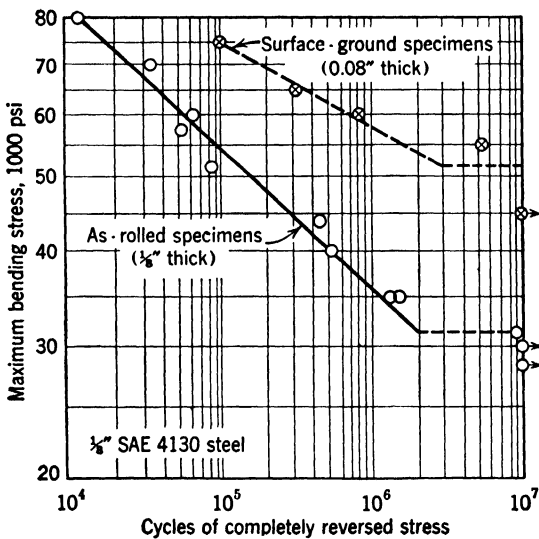

Fig. 1. S-N curves for unwelded plate-bending fatigue-test specimens, showing effect of surface grinding to remove decarburized as-rolled surfaces.

endurance limit of unnotched specimens tested in full thickness was 32,000 psi. When the skin was removed, the endurance limit was 52,000 psi, as shown in Fig. 1. The steel was of "aircraft quality" and represented commercial practice. The amount of decarburization was that normally expected by the mills producing such steel.

By taper-grinding the sheet and making closely spaced hardness determinations, it was found that 0.02 in. was affected by decarburization, the surface running around 150 Vickers, with some spots down nearly to 100, corresponding to some 60,000 psi tensile, which in turn corresponds to about 0.08% C at the surface, instead of the 0.29% present in the interior of the sheet. That is, the endurance test was telling that the endurance properties were those of the weak surface skin (and of the weakest spot on the surface skin), and not those of the strong interior.

Verification of the low C at the surface was obtained by water quenching, and taper grinding, as before. The center of the sheet quenched to 580 Vickers; the surface only to 320. For 0.02 in. in from each face of the sheet, or one third of its total thickness, quenching failed to produce full martensitic hardness. Lipson and Noll¹¹ show for steel forgings in some alloy steels the effect of decarburization, as follows:

Tensile strength, psi	100,000	150,000	200,000	225,000
Endurance limit, psi				
Ground and polished	45,000	70,000	85,000	90,000
As-forged	20,000-30,000	25,000 35,000	22,000-28,000	20,000 24,000

Remedies for Decarburization. There are several ways to cancel out the bad effect of decarburization. The surface may be mechanically hardened, as by shot peening, but this is not very effective on very soft badly decarburized surfaces. The C can theoretically be restored by various carburizing processes, but practical experience⁴ raises questions as to the efficacy of such a procedure.

When the fabrication process necessarily involves machining the surface anyhow, it will often be simpler and cheaper to use heavier stock and take a deep enough cut to get below the bark than to take precautions against decarburization. Here cutting down the depth of decarburization would be an advantage, though a minor one, because there is less to remove. But when the bark is not removed, an extremely thin soft surface, too thin to be very evident in hardness tests or scarcely to be found on metallographic examination, may be just as fatal in fatigue as a thicker bark, since it is the extreme outside surface that ordinarily determines fatigue behavior.

Hence processes that provide a hard, wear- and fatigue-resistant skin and those that avoid production of a soft poorly wear- and fatigue-resistant decarburized one form an important chapter in heat treatment. Some of these processes alter the chemical compo-

sition of the surface, but others merely apply the regular principles of heat treatment without altering chemical composition. Flame and induction surface hardening come into the latter class.

BIBLIOGRAPHY

1. J. O. ALMEN and A. L. BOEGEHOLD, Rear axle gears: factors which influence their life, *Proc. ASTM*, V. 35, Part 2, 1935, pp. 99-146.
2. H. W. McQUAID and O. W. McMULLAN, Selection of case hardening steels for highly stressed gears, *Trans. ASST*, V. 16, 1929, pp. 860-92.
3. O. W. McMULLAN, Physical properties of case hardened steels, *Trans. ASM*, V. 23, 1935, pp. 319-81.
4. O. J. HORGES and C. H. LIPSON, Automotive rear axles and means of improving their fatigue resistance, preprint 29 for 1946 American Society for Testing Materials meeting, 22 pp.
5. G. A. HANKINS and coworkers, Research on spring steels, see volumes of *J. Iron Steel Inst.*, 1926-36, inclusive.
6. J. B. JOHNSON, Fatigue characteristics of helical springs, *Iron Age*, V. 133, March 15, 1934, pp. 12-15; *Ibid.*, March 22, pp. 24-6.
7. C. T. EDGERTON, Abstract of progress report no. 3 on heavy helical springs, *Trans. ASME*, V. 59, 1937, pp. 609-16.
8. Appendix K in 1944 Report to Office of Scientific Research and Development, Project OEMSR 451, and U. S. Navy Bureau of Aeronautics, Contract NXS 7201, originally restricted, now released.
9. W. H. PARKER, The wearing qualities of tire chains, *Proc. ASTM*, V. 28, Part 2, 1928, pp. 332-40.
10. S. L. GERSTMAN and I. H. MACPHERSON, Mechanical properties of case-hardened materials, *Can. Metals and Met. Ind.*, V. 7, October 1944, pp. 32-3.
11. C. LIPSON and G. NOLL, Fatigue strength of steel forgings, *Product Eng.*, V. 17, September 1946, pp. 130-1.

CHAPTER 2

FLAME AND INDUCTION HARDENING

The principles of heat treatment were discussed in Vol. I under the general assumption that it was desirable to have the whole cross section of the piece of steel to be treated acquire heat in heating and lose it in cooling, as uniformly as the size of the piece will allow. Limitations to the accomplishment of this ideal confront the heat treater throughout his study of hardenability. In large sections, the engineer often has to put up with steel that is softer and weaker on the inside than on the surface.

However, even if there were no such stumbling blocks in the way of heat treatment, the engineer would often demand a piece with an intentional exaggeration of differences between surface and interior. He wants to be able to machine the part cheaply in production, but needs to have a hard wear-resistant skin on it for final use. He may have to grind or lap this skin to final dimensions, but he prefers to do only a minimum of such work.

As mechanisms become more refined, tolerances allowed for wear before the machine becomes too inefficient or too noisy are steadily being reduced; a loss of only a few thousandths of an inch is sufficient cause for scrapping the part. Hence the thickness of a useful hard skin may be very small indeed, if only it be backed up by an interior strong enough to support the skin without allowing it to crack or to be dented in service.

Moreover, if the tooth surface of a large gear, for example, is all that needs to have its properties altered, heating the whole gear is a wasteful process. In such cases the expedient presents itself of supplying heat to the surface so fast that the interior is but slightly heated, and quenching the surface at the split instant when the depth of the zone transformed to austenite, and hence ready to harden on cooling, has reached just the desired point. It is a well-known fact that materials that would be excessively brittle in a relatively large mass, are often not so brittle in an extremely thin layer. This holds for vitreous enamels, glue, and many other materials when backed

up by nonbrittle materials. (The converse is also true; a material that is soft and deformable in mass, such as babbitt or solder, backed up by stronger material, will stand remarkably high pressure without squashing.)

Although quench cracking would seem almost unavoidable in a surface-heating spray-quenching process of this sort, and great precaution has to be taken to avoid it, practical experience shows much less trouble than would be expected. Flame hardening has therefore become an important type of heat treatment. But it is a touchy process.

Requirements. In order to avoid too deep hardening it is necessary to establish a steep temperature gradient at the instant of quenching. This means that heating must be very rapid and the quench applied almost immediately after the surface comes to temperature; else thermal conduction will bring too thick a zone above the critical. The flame temperature should be high in order to allow establishing the steep gradient. The oxyacetylene flame is widely used.

Methods Used. Processes in which a gas flame is played on the surface to be hardened and immediately thereafter a water spray is applied are known in the United States as "flame hardening" and abroad by the trade names "Shorter," "Double Duro," etc., processes.

Symmetrical objects can be satisfactorily handled; on others warping naturally results unless special precautions are taken. Circular objects, such as piston pins, shafts, and the like are most readily treated. If these can be mounted on centers and rapidly spun under the flame, the whole surface can be heated uniformly and then spray-quenched from all sides.

If, however, the object is so large or the shape such that the whole surface to be hardened cannot be rapidly enough heated at the same time, progressive treatment has to be resorted to. For example, large gears may have their tooth surfaces hardened one at a time, with the gear mounted to rotate in a water tank so that the half of the tooth not being heated is immersed to keep it cool. The mounting, burners, and spray-quenching equipment are especially designed for each job, and the rate of heating and interval between heating and quenching are mechanically controlled, since these factors cannot be allowed to vary. A weakness of the flame-hardening method when progressive heating, rather than simultaneous heating from all sides, or spinning the object before the flame, is employed, is the overlap.

On the simplest shape, a cylinder, for example, one can progressively heat and quench as the cylinder rotates, with uniformity of hardening from beginning to end; but, when the complete circuit has been made, the heating of the last place tends to soften the first place, so that there is discontinuity of hardness at the overlap.

Necessity for Mechanization. Whereas many accounts appraise the flame-hardened objects as having a gradual transition zone from case to core and not being subject to spalling, Ricardo,¹ speaking from the point of view of a user automobile engineer, remarks that flame hardening of crankshafts is troublesome to accomplish and very uncertain as to quality. He remarks on the prevalence of surface cracks that lead to fatigue failure.

Many of the unsatisfactory results met in flame hardening have doubtless come from trying to do the work by hand, or with inadequate mechanization. The time of heating and the exact timing of the sequence of heating and quenching must be most exactly controlled. Mechanical devices for specific applications and some of the precautions necessary for good work are described in many publications.²⁻¹² Figure 2 shows burners being mechanically advanced in the heating for hardening of a tooth in a spur gear.

Steels Used. The C content of plain C steels used for surface hardening is ordinarily 0.40–0.60%. In alloy steels containing moderate amounts of depth-hardening alloying elements, the C may be down to 0.35% and, with still larger amounts of such alloys, to 0.30%. Checking during hardening of the more highly alloyed strongly depth-hardening steels leads to a general preference for the lower-alloy steels. Fine-grained steels are usually preferred. SAF 6135, 1340, and 1335 plus 0.20% Mo are representative of the alloy steels. A steel of 0.30 C, 2.50–2.75% Mn has been used on oil-well drill pipe with flame-hardened ends.

Jazwinski^{3a} suggests avoidance of water quenching in flame hardening by use of an air-hardening steel. Such a steel, he says, contains about 0.45 C, 0.20 Si, 0.30% Mo and about 1% each of Mn, Cr, and Cu, air quenching to 55 Rockwell C. There are, however, some drawbacks to the use of air-hardening steels.

A low-temperature stress-relieving draw should be given immediately after hardening. If the piece to be hardened has initial internal strains, care should be taken to relieve them before hardening.

In ordinary practice a depth of 0.1 to 0.2 in. is hardened in the flame-hardening process. Figure 3 shows sections of flame-hardened

objects. To get thinner cases, more rapid heating and quenching must be resorted to.

Horger and Cantley¹³ note the care required to avoid cracking of the surface in the deep flame hardening of large locomotive crank-pins. The 9½-in. pins were of 0.50% C steel, lowered through a heating ring with 20 flame heads, below which was a water-quenching

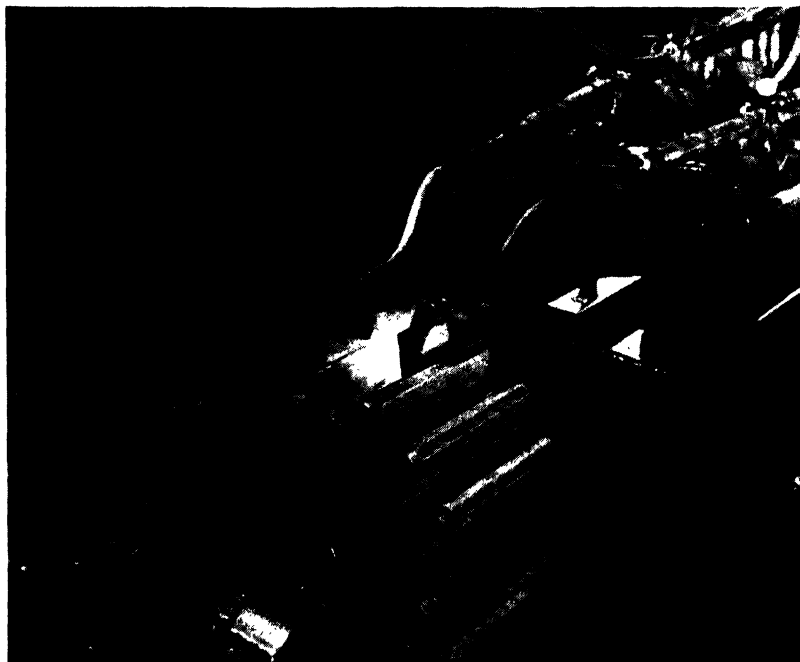

FIG. 2. Surface-hardening a spur gear. (Courtesy A. B. Kinzel)

ring. At a flame speed of 2¾ in. per minute, quenched with cold water, the hardened ring dropped from 650 Vickers at the surface to the original 175 of the untreated steel, in a quarter of an inch, the surface was cracked, and the cracks progressed deeper with grinding. It was necessary to remove practically all of the surface (around 0.1 in.) that was at the 650 Vickers level to get below the cracks.

Increasing the flame speed to 3⅛ in. per minute and using 85° quench water still gave surface cracks, detectable by Magnaflux but not so deep; they were removed by grinding off 0.04 in. However, in fatigue testing, it was later found that, because the compressive stress in the hardened layer held the cracks tightly closed, some thermal cracks were present that had been missed by Magna-

flux. In spite of this, the fatigue resistance was improved over that of unhardened pins. In other tests it appeared that heating the whole surface, with the piece spinning, and quenching it at one time, avoided the cracking which developed under progressive hardening. In these tests the stock was preheated through to 200° before the hardening flame was applied.

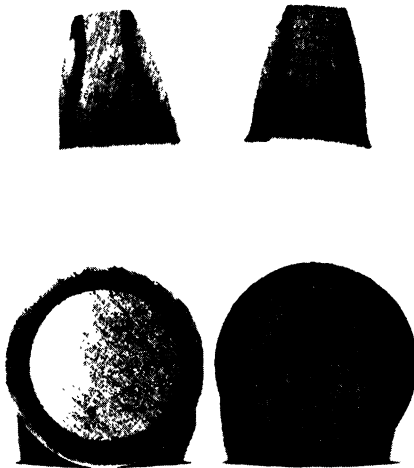

FIG. 3. Sections of flame-hardened objects. Top, gear teeth; bottom, 1 $\frac{3}{8}$ -in.-diameter rounds with heavy and light case. (Courtesy A. B. Kinzel)

Cold working the crankpin surface to only 225 Vickers, by rolling it with three rollers under pressure, gave a penetration of the cold work to 0.5 in. deep, down to the original 175. In spite of the relatively low hardness at the surface, this was more effective in fatigue than flame hardening.

Induction Hardening. There are limitations to the rate at which externally applied heat will travel inward, and limitations to the flame temperature that can be used, since the surface must not be melted. Many of the limitations are avoided when heat is generated, not *at* the surface by a flame, but *in* the surface by electrical induction. Fortunately for the purpose in hand, when high-frequency current is used the current, and hence the heating, produced in the work piece, which acts as the secondary winding of a transformer,

crowds to the surface rather than developing through the whole section. The higher the frequency, the closer the induced current hugs the surface.

Heating by electric induction at higher than usual frequencies has become common practice in melting metals, in automatic copper brazing and silver soldering, and, more recently, in heating for forging. From the point of view of heat treatment, high-frequency induction heating has three major applications: (1) hardening a thin *surface* skin for wear resistance, (2) *locally* heating for hardening through a section, and (3) heating at an extremely rapid rate for hardening, normalizing, or tempering.

"High frequency" ranges from as low as 500 cycles up to, say, 15 million cycles. The equipment for producing current varies with the frequency needed, and that differs with the application in question and the depths to which it is desired to harden. Benninghoff and Osborn¹⁴ give the data shown in Table 9.

TABLE 9

<i>Frequency, Cycles per Second</i>	<i>Depth Hardened, In., in 1-Sec Application of Suitable Kw</i>
3,000	0.06
9,600	0.04
120,000	0.03
500,000	0.02
1,000,000	0.01

It is practically impossible to measure the temperature produced by such rapid heating, control is effected through kilowatt input and time of application.

Mechanism of Induction Hardening. An ordinary transformer heats up a little in use, because of eddy currents set up as the current fluctuates through its cycle and the flux field changes. In this case the heating is not wanted, since it means lower transformer efficiency.

To use this phenomenon for heating, the eddy currents are encouraged. The flux field spreads out from the primary winding, getting weaker as the distance from the primary increases. The "secondary" is the object to be heated, which does not have to be a part of another circuit, as it is in a transformer, but can be anything that opposes suitable resistance to the flow of the secondary current. It is, in effect, a short-circuited secondary. The closer

the secondary is to the primary the more the secondary cuts the strong part of the flux field. Hence, "close coupling" is necessary; the object to be heated must be close to the primary coil. This is accomplished without danger to the primary coil by making the primary of copper tubing and maintaining a cooling water flow through the tubing, and by removing the object to be heated instantaneously after the heating is accomplished, or by applying a quenching water spray.

The more often the flux changes the more rapid the heating. Also, as the frequency increases, the induced current in the object heated is produced closer and closer to its surface, by a sort of "skin effect."

The resistivity of steel to the induced current decreases when the steel transforms to austenite. Hence, if steel is to be austenitized, the unit must be adequately powered to continue heating above the critical.

The rapidity of heating is amazing, when compared to other methods of heating. A 3-in. billet can be loaded into a high-frequency forging furnace, heated to forging temperature, and unloaded, in less than 4 min. Tubular propeller-blade shanks are heated to forging temperature in less than 2 min. The heating of a surface skin for austenitizing is only a matter of seconds.

Sherman¹⁶ cites a spur gear $2\frac{1}{2}$ in. O.D. \times $\frac{1}{4}$ in. thick, surface-hardened on the teeth in $1\frac{1}{4}$ sec, at 15 kilowatts at very high frequency. The heated layer is so thin that it is effectively self-quenched by the cold layer beneath it when the current is turned off. No water spray is needed.

Obviously, in this case, and in most cases of induction hardening, "split-second" timing would indeed be rough, splitting of tenths of a second is often necessary. However, suitable control devices are available.^{17, 37}

When through-heating of the whole section, as in hardening the nose of a projectile, is desired, the generation of heat should be deep, so as to leave as little need as possible for time for temperature equalization by thermal conduction from surface to center. This means the use of the lower frequencies, as well as of generating units of high kilowatt rating, since the greater volume to be heated requires more energy. These needs are met by high-frequency motor-generator sets, the motor being operated by the ordinary 60-cycle power supply. The generator produces high-frequency current, up to about 1200 cycles. These motor-generator sets are made in capacities up to 1000 kw.

The very rapid rate of heating gives little time for scaling, oxidation, or decarburization, but the compactness of the outfit makes it easy to provide a controlled atmosphere when completely bright hardening is wanted. Hence it is feasible to use higher frequency and get more skin effect, but allow time for thermal conductance. The current can be produced by spark-gap converters, which operate in the range of 15,000 to 300,000 cycles. Such an amount of energy is sufficient for many cases of surface hardening and for through-hardening of small pieces.

When the aim is to confine the heating to a very thin surface layer, and utilize the "skin effect" to the extreme degree, frequencies of 100,000 to 15,000,000 can be produced by electronic-tube equipment, available in capacities up to some 60 kw.

All these types of equipment¹⁶⁻²² are relatively expensive in first cost, and the efficiency of transformation from the ordinary current for the motor-generator set, or that used to energize spark-gap or vacuum-tube outfits, is not high. The efficiency of the transformation of high-frequency current into heat is high, if the coupling is close.

"Coupling" refers to the proximity of the primary coil to the piece forming the secondary coil. The closer they are, the less the leakage and the higher the efficiency. Variation in coupling can be utilized, as in heating certain projectiles whose noses are wanted hard,²³ with a gradual tapering off of hardness toward the base. Less close coupling, by flaring the primary coil where it surrounds the base, accomplishes this.

The actual British thermal units utilized as heat are relatively costly, but the great speed, small floor space, and especially the ability to put the heat-treating operation into a mechanized production line, often make high-frequency heating the cheapest over-all.²⁴

Although induction heating is peculiarly applicable to surface hardening, the speed of heating and the improved working conditions compared with conventional methods for through heating make it worth consideration for that purpose as well. Work can be automatically fed through an induction coil, quenched as it leaves the coil, and tempered by being passed through another coil, all in a production line, and with more precise control than can ordinarily be attained by conventional methods.

Suitable equipment is now available from a large number of makers, and so many different applications have been studied that the makers have a large background of users' operating experience

on which to base recommendations as to type and capacity of equipment for a given application.

A very large literature has grown up on induction heating. A good description of the principles and techniques is given by Curtis.²⁵ In a few short years inductive hardening has progressed from the stage where it took a laboratory to do it, after much cutting and trying in design of special inductor coils and adaptation of control devices to put in the proper amount of energy and no more, to a matter of engineering where equipment makers can design equipment and controls to handle a specific job by the mere pushing of a button, if they are given sufficient information on just what is to be accomplished. Formulae used in such design are cited by Osborn¹⁸ and Curtis.²⁵

Ordinarily the quenching fluid is sprayed on the part from a perforated fixture so that the quench immediately follows the heating. Water is more commonly used than oil because of fire hazard. It is possible to immerse both a small piece and its primary coil in oil, heat instantaneously, turn off the current, and let the oil quench the piece, but this is only feasible with small parts, like taps whose teeth are to be hardened.

Since every step in induction hardening must be timed to a split hair and automatic controls provided to accomplish this, the process is a natural for the application of "time quenching," in which stored heat serves to temper the hardened zone after the quench has been terminated.

Self-quenching, that is, quenching by extraction of heat from the heated skin by the cold interior is sometimes possible, especially at the higher frequencies. Even in ordinary spray quenching, this effect occurs to some extent, the outer layer thus being quenched from both outside and inside; this doubtless influences the internal stress in the martensite layer and accounts for some of the peculiarities noted in induction hardening.

In equipment for crankshaft hardening and allied problems, as has been described by Tran and Benninghoff²⁶ and by Cone,²⁷ the throws of the crankshaft are surrounded by split Cu collars, almost, but not quite, touching the surface to be hardened. High-frequency current is turned into these collars, called "inductors," by an automatic timing device, and very large amounts of energy are thereby induced into the surface to be hardened, heating up the outside shell with great rapidity. The equipment is shown in Fig. 4. It is a

characteristic of such heating that the induced current is strongest at the surface nearest the Cu collars. The collars themselves are not appreciably heated.

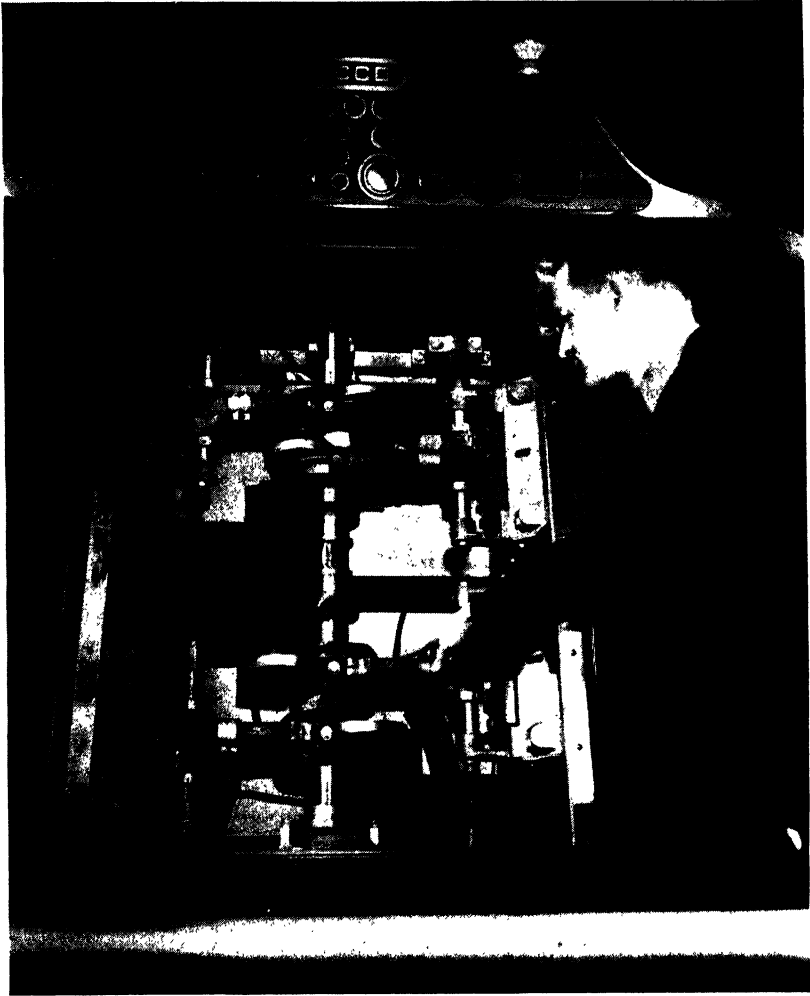

FIG. 4. Equipment for inductive heating and quenching of crankshaft bearing surfaces. (Courtesy Ajax Electrothermic Corp.)

General Precautions. Prior to hardening, the steel is given the degree of toughness desired in the core, and internal strains are relieved. Fine-grained steels, normalized, or normalized and drawn, or previously quenched and tempered to a fine sorbitic structure,

are usually employed. After hardening, the piece is given a low-temperature draw for strain release of the hardened surface.

The steels used generally run from 0.35 to 0.60% C with the lower C on the more highly alloyed steels.

Operation. The intensity of the induced current is regulated by the design of the equipment, and the time it is allowed to act can be regulated to a split second by suitable electric devices. Thus just



Fig. 5. Section of inductively hardened crankpin bearing. (Courtesy Ajax Electrothermic Corp.)

the desired amount of heat can be supplied, and the time allowed for the heat to soak toward the center of the piece can be regulated so that only a very shallow depth need be heated above the critical temperature before quenching.

Quenching is accomplished without moving the piece or the collars, since the collars are hollow and are perforated with many small holes so placed that jets of water passing through them will envelop the whole piece without any dead spots. High-pressure water jets are automatically projected through these holes at the proper instant.

Results Obtained. Thus entirely reproducible and thoroughly uniform treatment can be applied to the surface of a symmetrical object.

Figure 5 shows a section of a crankpin bearing. Crankshafts so hardened have come into considerable use. Boegehold²⁸ refers very favorably to crankshafts so hardened, from the point of view of a

user automotive engineer. He comments that where such treatment is applicable, plain C steel or slightly alloyed steel, for example, that with 0.25% Cr, may sometimes be substituted for more expensive alloy steels.

Roll Hardening. Figure 6 shows the horizontal and part of a longitudinal section of a 5-in.-diameter leveler roll 30 in. long, made of 0.96 C, 0.52 Mn, 0.19 Si, 0.52% Cr steel.

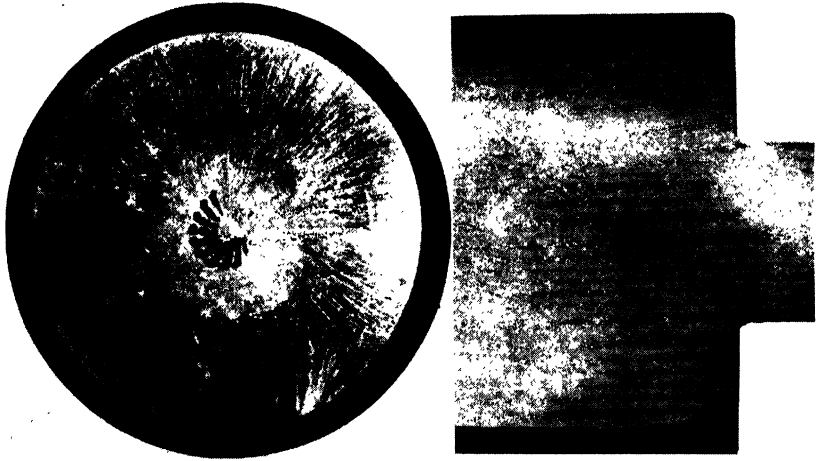

FIG. 6. Sections of 5-in.-diameter roll, inductively hardened. (Courtesy Ajax Electrothermic Corp.)

The roll was pushed through an inductor coil powered with 110 kw of 2000-cycle current, at the rate of 1 ft per 170 sec. The surface was heated to 1450° and held about 20 sec before reaching the quenching water spray at the end of the inductor coil. The roll was drawn at 350° . The surface hardness was 95 Scleroscope. The gradation of hardness is shown in Fig. 7.

Much of the inductive hardening is done on exterior surfaces, but equipment and methods for internal hardening of bores were worked out by Somes.²⁹ A useful application of flame hardening or induction hardening is the production of what might be termed an internal fillet, as suggested by Zimmerman.³⁰ Such an application is shown in Fig. 8.

Structures Produced. Much discussion has arisen as to differences in structure resulting from such rapid heating, as compared with the greater time for homogenization of austenite in even the most rapid

conventional heating. The rapidly heated austenite, under the drastic quench, becomes even harder than that conventionally treated. This appears to be due to the stress conditions.

Vaughn and coworkers³¹ and also Martin and Wiley¹⁵ noted that an inductively hardened 1050 steel becomes 3 or 4 points Rock-

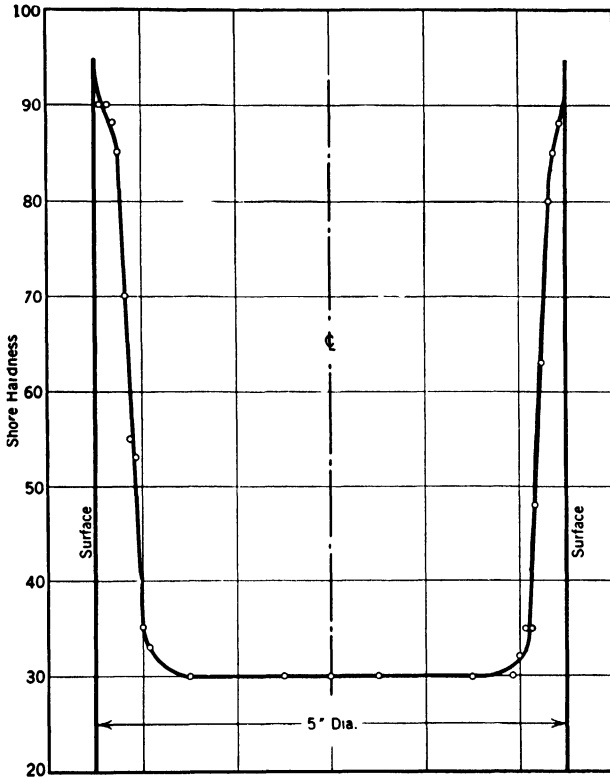
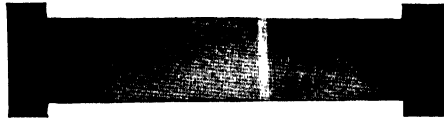

FIG. 7. Hardness gradient on transverse section of 5-in.-diameter inductively hardened roll. (Courtesy Ajax Electrothermic Corp.)

well-C-harder than a conventionally hardened one, owing to compressive stress at the surface of the former. This stress is released by a 210° temper. It is postulated that the rapidly formed austenite is inhomogeneous, leading to finer martensite and less retained austenite. In conformity with the findings of Greninger³² and of Payson and Savage,³³ undissolved carbides in austenite are considered to lower M_s and raise M_f . Self-quenched martensite, produced without external quenching, is not so hard as when produced by external quenching, according to Roberds.³⁴

It is common for the quenched structure to show "pearlite ghosts," blurred replicas of an original pearlite structure, which are evidence of incomplete diffusion of the C in the austenite.³⁵ There is also a suspicion that some ferrite may remain untransformed, in spite of



Macroetch of failed unfileted fatigue-test specimen showing flame strengthening at the regions of stress concentration.

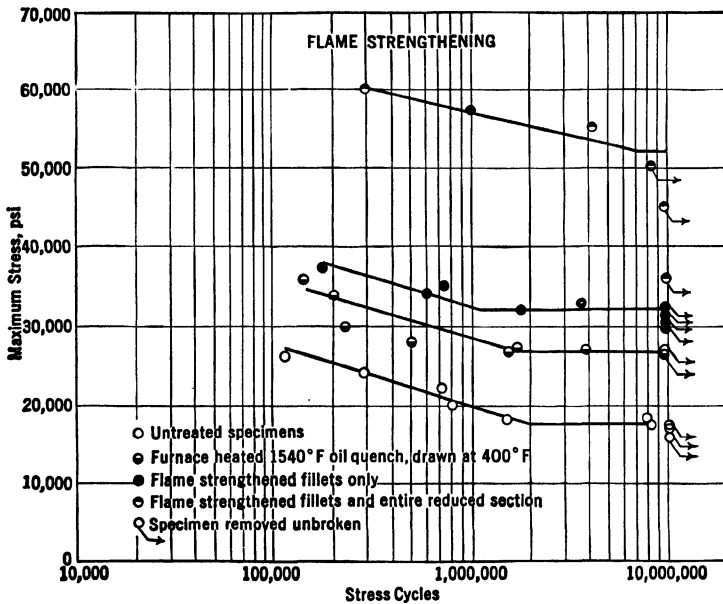

Fig. 8. Effect of flame-hardening sharp corners to produce the equivalent of a fillet. (Zimmerman)

the temperature having been above its transformation temperature on slower heating.

Pretreatment. It is customary to put the steel into an initial condition in which the carbide is as fine and as uniformly distributed as possible, that is, tempered martensite. Although many cases exist of satisfactory hardening when starting with structures other than tempered martensite, homogenization of austenite is generally considered desirable in induction hardening. In the pretreatment

to put the carbide into finely divided condition, spheroidized carbides are to be avoided, fine pearlite is preferred to coarse, and tempered martensite, produced by prequenching and tempering, is still better. Since alloy carbides and complex cementites are, as a rule, less readily dissolved than ordinary cementite, plain C steels are preferred from the technical as well as the cost basis.

As with any thin hard surface, the surface needs support, so that the composition and the pretreatment are adjusted to provide this. This point of view again leads to the choice of steels of the general class of 1045, or to low-alloy steels of the N.E. class, with nearly that C content, for induction hardening.

BIBLIOGRAPHY

1. H. RICARDO, Engine testing, *J. Inst. Fuel*, V. 10, 1937, pp. 266-74.
2. W. B. SHARAV, Flame hardening in the small shop, *Welding J.*, V. 25, January 1946, pp. 19-24.
3. R. H. BROOKS, Simple setup for small-lot flame-hardening of valve plugs, *Ibid.*, March 1946, pp. 245-6.
4. The basic flame-hardening setup, staff article, *Ind. & Welding*, V. 18, December 1945, pp. 39-41, 66-9.
5. Flame hardening, *Oxy-Acetylene Tips*, V. 16, October 1937, pp. 223-9.
6. New type of gear hardening machine developed, *Heat Treating Forging*, V. 23, 1937, pp. 231-3.
7. A. K. SEEMANN, Surface hardening with the oxy-acetylene flame, *Metal Progress*, V. 32, September 1937, pp. 247-51. Oxyacetylene surface hardening, *Mech. Eng.*, V. 60, 1938, pp. 535-46.
8. R. L. ROLF, Selective hardening with the oxyacetylene flame, *Steel*, V. 101, November 1, 1937, pp. 48-51.
9. L. A. LINDBERG, Flame hardening of machine parts, *Welding Engrs.*, V. 22, September 1937, pp. 37-9.
10. W. E. SYKES, Torch hardening of gear teeth, *Machinery*, V. 44, November 1937, pp. 196-8.
11. R. PURSEL, Flame hardening and metals, *Ind. & Welding*, V. 11, February 1938, pp. 35-6, 38.
12. J. T. HOWAT, Flame hardening, *Steel*, V. 102, February 28, 1938, pp. 60-3.
13. O. J. HORGER and W. I. CANTLEY, Design of crankpins for locomotives, *J. Applied Mechanics*, V. 13, March 1946, pp. A17-A33.
14. W. E. BENNINGHOFF and H. B. OSBORN, JR., Practical aspects of the selection of frequency and time cycles for the processing of metallic parts with induction heating, *Trans. ASM*, V. 34, 1945, pp. 310-34.
15. D. L. MARTIN and L. E. WILEY, Induction hardening of plain carbon steels, *Ibid.*, pp. 351-96. See also articles in *Trans. ASM*, V. 36, 1946, pp. 137-253.
16. V. W. SHERMAN, Megacycle induction heat for thin cases, *Metals & Alloys*, V. 19, June 1944, pp. 1409-14.

17. L. W. CURTIS, Induction heating advantages warrant new designing techniques, *Product Eng.*, V. 15, April 1944, pp. 242-5.
18. H. B. OSBORN, JR., Induction heating and heat treatment, *Metal Progress*, V. 48, October 1945, pp. 801-06. Frequencies up to 10,000 cycles, *Ibid.*, pp. 806-10.
19. J. J. FOX, Frequencies from 10,000 to 50,000, *Ibid.*, pp. 806-07, 810-13.
20. J. W. CABLE, Vacuum tube units, *Ibid.*, pp. 806-07, 813-14.
21. J. P. JORDAN, Motor generator and electronic units, *Metals & Alloys*, V. 19, May 1944, pp. 1153-4.
22. L. T. CHESTNUT, Spark gap converters, *Ibid.*, pp. 1155-6.
23. T. E. LLOYD, Induction hardening of A. P. shot, *Iron Age*, V. 154, July 6, 1944, pp. 58-60.
24. Continuous hardening of steel bars by induction on a commercial basis, staff article, *Ind. Heating*, V. 12, April 1945, pp. 610-18. E. E. ALEXANDER, Continuous induction hardening, *Metal Progress*, V. 49, March 1946, p. 538. See also W. BOYLE, Induction hardening of precision steel parts, *Materials and Methods*, V. 23, February 1946, pp. 425-8.
25. F. W. CURTIS, *High Frequency Induction Heating*, McGraw-Hill, 1944. 235 pp. How to design coils for induction heating, *Am. Machinist*, V. 90, January 31, 1946, pp. 75-8.
26. M. A. TRAN and W. A. BENNINGHOFF, Differential hardening by induction, *Trans. ASM*, V. 25, 1937, pp. 935-52.
27. E. F. CONE, Crankshafts and other parts surface hardened by inductive heat, *Metals & Alloys*, V. 9, 1938, pp. 1-7.
28. A. L. BOEGEHOLD, Plain carbon steel, *Metal Progress*, V. 31, February 1937, pp. 147-52.
29. H. E. SOMES, Induction heat treatment of internal surfaces as applied to automotive industries, *SAE J.*, V. 54, February 1946, pp. 45-54, 63. *Steel Processing*, V. 31, February 1945, pp. 90-6, 130. See also A. GENIOT, Induction heating of hollow metallic cylinders, *J. Applied Phys.*, V. 17, March 1946, pp. 195-200.
30. J. H. ZIMMERMAN, Flame strengthening, *Iron Age*, V. 145, February 1, 1940, pp. 38-9. Flametreating, *Welding J.*, V. 19, February 1940, pp. 104-10.
31. F. F. VAUGHN, V. R. FARLOW and E. R. MEYER, Metallurgical control of induction hardening, *Trans. ASM*, V. 30, 1942, pp. 516-38.
32. A. B. GRENINGER, The martensite thermal arrest in iron carbon alloys and plain carbon steels, *Trans. ASM*, V. 30, 1942, pp. 1-26.
33. P. PAYSON and C. H. SAVAGE, Martensite reactions in alloy steels, *Trans. ASM*, V. 33, 1944, pp. 261-75.
34. W. M. ROBERDS, High intensity induction heating, *Steel*, V. 18, March 18, 1946, pp. 104-07, 161-5.
35. O. W. ELLIS, Pseudomorphs of pearlite in quenched steel, *Trans. ASM*, V. 32, 1943, pp. 270-80.
36. S. T. JAZWINSKI, Flame hardened steel, *Steel*, V. 120, May 12, 1947, pp. 108-109, 146.
37. T. E. LLOYD, A new principle in induction heating, *Iron Age*, V. 159, June 12, 1947, pp. 46-8.

CHAPTER 3

NITRIDING AND CYANIDING

The surface skin produced by flame or induction hardening is adequate for many uses, but still more wear-resistant surfaces are often needed. These may be provided through carbides, by increasing the C content of the superficial layer, that is, by carburizing, or by producing a surface layer containing nitrides.

A nitride layer is obtained by subjecting the steel at a moderately elevated temperature (but usually low enough for the steel to be ferritic rather than austenitic), to the action of nascent, that is, active, H, produced at the surface of the work by decomposition of gaseous ammonia, NH_3 . The reaction is $\text{NH}_3 \rightarrow \text{N} + 3\text{H}$.

Carburizing is done by bringing nascent C, produced from CO or CH_4 , in contact with a steel or iron surface at higher temperatures, those at which the steel is austenitic. Such contact results in the reversible reactions,

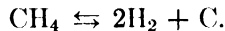

By operating at a low temperature, the N is more readily accepted by the steel; at a high, C is more readily accepted. Cases produced by treatment with molten cyanide contain both N and C, the ratio depending chiefly on the temperature.

Combined carburizing and nitriding may also be accomplished by supplying NH_3 as well as CO in gas or liquid carburizing, or as well as CH_4 in gas carburizing.

In all these cases the breakdown of the carburizing or nitriding compound must occur at the steel surface; else the nascent element will combine with itself or form other compounds, instead of entering the steel. After the nascent element has been taken up by the steel it diffuses beneath the surface, N diffusing into ferrite, but slowly, while C diffuses, more rapidly, into austenite. The solubility of ferrite for C is very low, that of austenite high.

Nitriding. The nitrided surface is exceptionally hard, correspondingly brittle, usually extremely thin, and hence must be supported by material itself quite strong. The hardness, compared to a case-

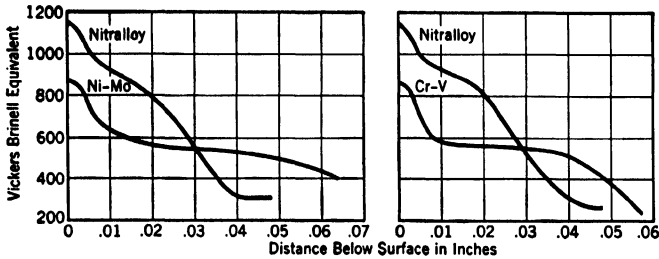

Fig. 9a. Hardness of nitrided versus case-carburized steels. Nitralloy, heat-treated, then nitrided 90 hr at 975°. NiMo, carburized, double oil-quenched, drawn at 300°. CrV, carburized, double oil-quenched, drawn at 300°. (Grossmann ¹)

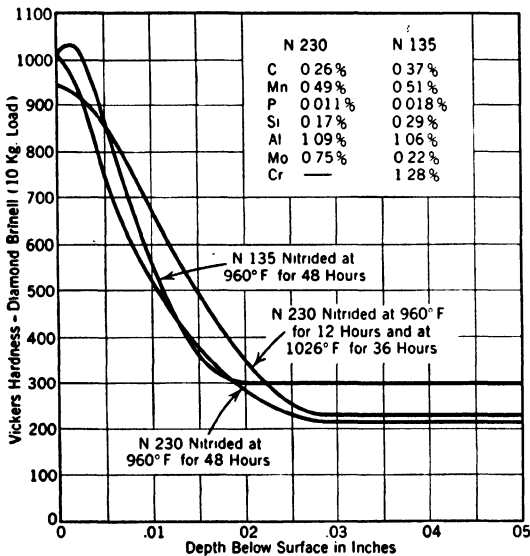

Fig. 9b. Hardness of nitrided steels.

carburized steel is shown by Fig. 9a and that for two different steels by Fig. 9b. Nascent N, obtained by the thermal decomposition of anhydrous ammonia, NH_3 , is led into the closed externally heated container and dissociates in contact with the work. The temperature used is very much lower than the temperature used in carburizing and cyaniding.

The diffusion of N beneath the surface is slow, the time required to build up even a thin nitrided case is a major drawback to the process. A straight Fe nitride case is more brittle than one containing certain alloy nitrides. Plain C steel can be and has been usefully nitrided, but cases of its successful application are rare.³ Plain C steels are more commonly given a less hard case containing both C and N, as by cyaniding and allied processes. The need for special alloy steel is another drawback to the regular nitriding process.

Use of Alloy Steels. Steels for practical nitriding always contain one or more of the elements that form nitrides very readily, Al, Cr, or V. Nitriding is carried on in the range of temperatures at which temper-brittle steels develop their temper brittleness. Molybdenum is a specific against temper brittleness. For this reason in respect to the core and because the presence of Mo is almost equally a specific against excessive brittleness of the nitrided case, about 0.20% Mo is included in the common Al-Cr nitriding steels. Or, Cr can be omitted, and the Mo raised in an Al-Mo steel, or the Al can be omitted and Cr plus V used. Si, Mn, Ni, and Cu need not be excluded, but they do not facilitate nitriding. The total content of Al, Cr, Mo, and V usually sums up to from 2 to 3%, although very much more highly alloyed steels may be used. The C content ordinarily runs from 0.20 to 0.40%, which in the presence of the rather large amount of alloying elements makes the steels readily heat-treatable and allows tempering temperatures high enough so that the core will not soften during nitriding too much to fail to support the case. By adding some Ni to an Al-containing steel, precipitation hardening, due to Ni-Al compounds, may be secured at nitriding temperature, to afford added strength to the core (see Chapter 10, Vol. I). High S may be present to make the steel free-machining, without interfering with nitriding. High-speed steel may be nitrided, and Gill² suggests such treatment for tools to be used for cutting Bakelite. For most tool purposes the nitrided edge is too brittle, and so cyaniding is generally preferred.

18:8 austenitic steel may be nitrided; surface hardness as high as 73 R.C. is said to have been secured. Floe⁴⁷ cites precautions needed when handling 18:8.

Haythorne³ examined the nitriding characteristics of other than the accepted nitriding steels and concluded that they did not respond well. Under conditions that gave the equivalent of 66 R.C. on the regular nitriding steel, no higher than 56 was obtained on 4130,

whereas 8630 and 9440 gave only about 50, 8640 gave up to 54, but 1095 only 42.

Jominy ⁴ reports that 1137, the 4300 series, and a 0.30 C, 0.75 Cr, 1 Ni, 1% Mo steel, are usefully nitrided.

Preparation for Nitriding. The presence of ferrite, at the surface, prevents the formation of a satisfactorily tough nitrided case. The best type of case results from quenching and drawing to tempered martensite, before nitriding. The usual nitriding steels may be forged at 1950–2200°, quenched from proper hardening temperature, and drawn at 1150–1350°. If during heating for quenching, the steel has been given a decarburized surface, that ferrite surface must be removed before nitriding. Use of suitable controlled atmospheres in the heating for quenching is therefore indicated.

Surface Defects. If the decarburized surface is not removed before nitriding, the case will spall very readily. This condition may arise because of improper centering during the machining whereby an insufficient amount of material is removed from some point. This may occur in the machining of forgings. Parts that are coated with rolling or forging scale necessitate the removal of $\frac{1}{32}$ to $\frac{1}{16}$ in. of material to eliminate the decarburized layer.

Although decarburization prior to nitriding is fatal, the nitriding steels, such as the common Al–Cr–Mo composition, are readily decarburized in the nitriding process. The NH_3 in decomposing to nascent N and nascent H naturally has a decarburizing action, though at the relatively low temperatures of nitriding the effect is not great. McQuaid and Ketcham ⁵ note that a 0.33% C nitriding steel with Al and Mo lost half of the C from its surface in 20 hr at 950°. Carbon seems to be removed from the surface during nitriding, simultaneously with the addition of N. This fact may explain the phenomenon often noted, that the extreme surface of a nitrided case may not be quite so hard as the layer next beneath, as if at the zone of maximum hardness the hardening effect of both the C and N were reinforcing each other.

Renitriding not Practiced. A nitrided part on which close dimensional tolerance is required must be correctly nitrided the first time, or else it is scrap. There is no satisfactory way of “denitriding” and then renitriding. The case can be denitrided to some extent, but on the attempt to renitride only a brittle case is produced. The nitrided surface could be removed by grinding or sandblasting and the piece then renitrided if the resultant change in dimensions could be tolerated.

Effect of Temperature in Nitriding. Contrary to experience with regular case carburizing, the hardness of nitride cases does not increase with increase in nitriding temperature, as Fig. 10 indicates. This figure clearly shows why nitriding temperatures of 950–1000°

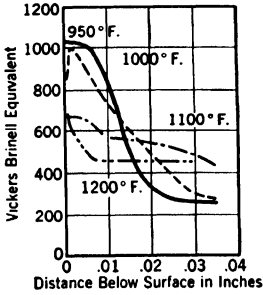

Composition of steel, 0.32 C, 0.63 Mn, 0.15 Si, 1.68 Cr, 0.19 Mo, 0.70% Al.

Temp., deg.	Time, hr	Dissociation, %	Flow, cc per min
950	48	25	200
1000	48	40	200
1100	48	75	500
1200	48	90	500

FIG. 10. Effect of variation in nitriding temperature upon hardness. (Grossmann¹)

are normally chosen. However, the cases formed at higher temperature, say 1200°, are both deeper and tougher though less hard. A sojourn at a temperature of 950–1000° to produce a hard case followed by one at 1150–1200° to produce penetration and toughness is advocated by some. Others start at the higher temperature and finish at

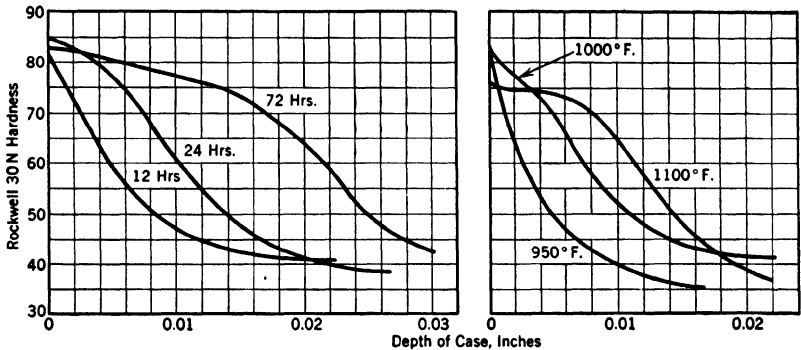

FIG. 11. (a) Depth hardness of steel nitrided for times shown, at 975°. (b) Depth hardness of steel nitrided 24 hr at temperatures shown. The steel used was like N 135 in Fig. 9b, but contained only 0.25% C. (Lysaght⁸)

the lower. Jones⁶ advocates 930° followed by higher temperature, up to 1020°. He says that such practice is applicable to the usual steels containing Al but not to those with Cr without Al. Kontorovich⁷ advocates a cycle of 930–1150–930° which he claims produces

equivalent results in half the time of a continuous 930° treatment. Ordinarily but one temperature is used, that being chosen to produce a case of the desired compromise between hardness and toughness. Lysaght⁸ shows Fig. 11.

Toughness. Toughness of the case is a relative term, since even the "tough" cases, if not well supported, are brittle. When the case is built up locally to too great depth, as occurs at a sharp point or edge, for example, on a sharp V-shaped thread, the apex will spall readily. Hence, parts for nitriding must be made with gradual fillets and avoidance of sharp edges. Nitrided cases are not employed to resist high local pressures unless very thoroughly supported, nor when impact or battering service is involved. High-speed tools can be nitrided, as would be expected from their composition, and such a treatment has been suggested for twist drills and the like. The usual criterion of toughness is to note whether the case spalls at the edges of an impression made by the hardness testing of the case, by the diamond cone of the Rockwell superficial hardness tester (30 N scale), the diamond pyramid of the Vickers, or the $\frac{3}{4}$ -mm-diameter diamond ball of the Monotron. The load required to crack the case in the ordinary Brinell test may be taken as a measure of its toughness. The regular Brinell test is of course inapplicable for hardness measurements on so thin a case. A torsion test was considered by French and Homerberg⁹ to be an especially searching one by which to study the cracking of the case.

Nascent Nitrogen Required. In the nitriding process it is essential that nascent N in sufficient amount be supplied to the surface of the steel. Ammonia broken down elsewhere in the container supplies only inactive molecular N_2 , and so the flow of NH_3 gas must be sufficient to supply fresh NH_3 to break down upon the work at the proper rate. For nitriding at the normal temperature, say 975°, such a flow that the exit gas contains 70% unused undissociated NH_3 , or, as it is generally termed, "30% dissociation," is used. In nitriding at higher temperatures the dissociation is greater even though the flow has been materially increased. Too high a dissociation tends to decarburize the case too much. In order to avoid undue decomposition of the NH_3 on the surface of the container, where such decomposition is not wanted, fused silica, vitreous-enameled steel, Ni, monel, or other alloys high in Ni, such as Inconel, are generally used for containers, baskets to hold the work, inlet and outlet tubes, etc.

Dissociation. A higher dissociation, up to 60%, is found advisable by Roth¹⁰ who describes the process and the very large-scale equip-

ment used in nitriding aircraft-engine cylinder liners and crankshafts. The actual nitriding time used, exclusive of heating up and cooling down, was 35 hr at 975–980°. The corrosion resistance of the case produced at high dissociations is not so good as at lower ones. Floe¹¹ discusses nitriding at high dissociations, pointing out that it saves NH_3 and speeds nitriding. If the process is started at 30%, dissociation may later rise as high as 85%, with production of satisfactory cases. However, high dissociation is feasible only when the atmosphere in the nitriding furnace is turbulent enough to avoid complete decomposition of NH_3 that might otherwise occur at stagnant points. If the NH_3 is completely broken down before it reaches a shielded spot, that spot obviously will not be nitrided. Loading of the stock so that gas circulation is not impeded, and good fan circulation within the furnace are essential. Without these, only low dissociation can be tolerated.

The useful breakdown of NH_3 is accomplished at the surface where the active N is to be utilized. Active N either diffuses into the steel, where it is wanted, or two atoms of active N, meeting away from the steel, combine to form an inactive N_2 molecule, which does no nitriding. Only some 2 or 3% of the N supplied as NH_3 is actually taken up by the steel.

The gas mixture leaving the furnace consists of H_2 , N_2 , and undissociated NH_3 . The NH_3 gas is very soluble in water, whereas the H_2 and the N_2 are insoluble. Advantage is taken of this fact in the determination of the extent of the NH_3 dissociation during the nitriding operation. The special pipette shown in Fig. 12 is used for making this determination.

At the time that a determination of the extent of the NH_3 dissociation is to be made, the stopcocks at *C* and *E* are closed while *D* is open, and the stopcock at *A* is turned so as to admit the gas mixture from the container into the graduated chamber. After the air has been expelled, stopcock *D* is closed and *A* is turned so as to by-pass the gas mixture. Reservoir *G* is filled with water, after which the

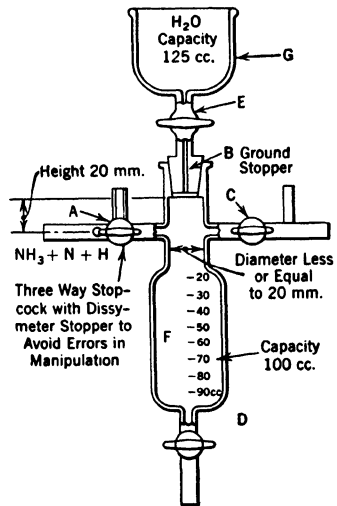
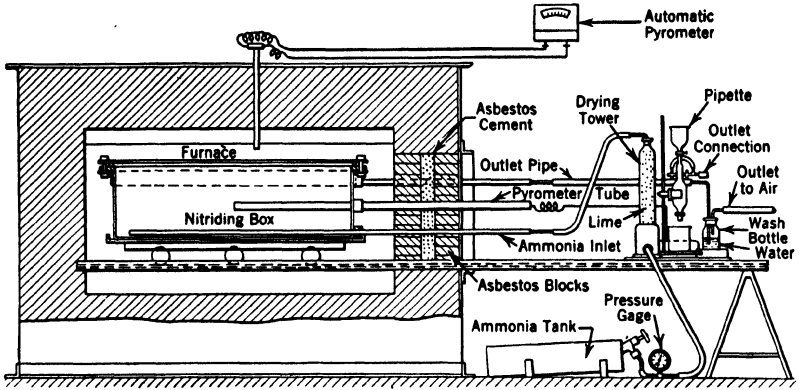
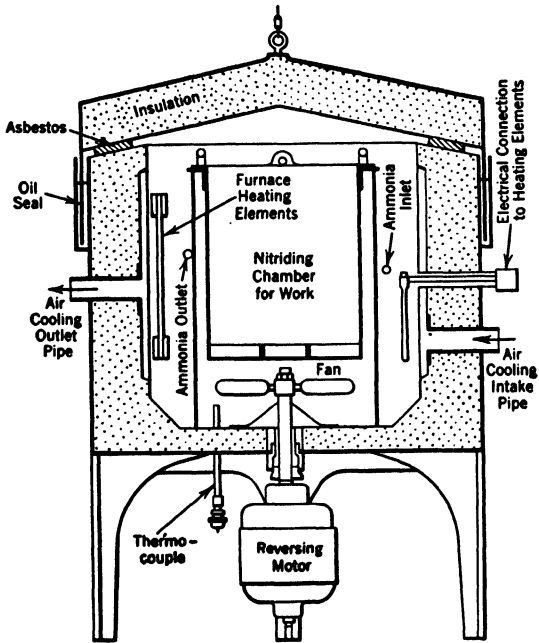

FIG. 12. Pipette for determining ammonia dissociation.



(a) Diagram of outfit for nitriding.



(b) A commercial type of nitriding furnace.

FIG. 13. Schematic diagrams for nitriding furnaces. (Grossmann 1)

stopcock *E* is opened to admit the water into the graduated chamber. The water immediately absorbs the NH_3 , and the atmosphere above this solution contains the insoluble H_2 and N_2 . The water solution should reach approximately the 30-cc mark, indicating the 30% dissociation ordinarily used. If it is much above this value the flow should be increased; if it is much below 30% the degree of dissociation can be increased by decreasing the flow of the gas.

Nitriding Equipment. The principles of proper heat application, as described elsewhere in this book, apply most emphatically to nitriding. The product to be nitrided must be heated uniformly to and at the required temperature for the stated time in a properly maintained atmosphere capable of forming nascent N.

A typical batch-type nitriding equipment is represented in Fig. 13*a* and *b*. The tank of ammonia must be placed in a position such that the bent tube inside the tank has its open end in the gaseous atmosphere and does not dip into the liquid ammonia. The use of a suitable needle valve ensures the control of a steady and even flow of gas. The inlet tube extends along the bottom of the box to the back; the outlet tube is at the front and near the top of the box. Pyrometers are inserted into both the container and the furnace. The gas mixture from the container passes through a wash bottle to indicate the back pressure (which should be about 1 to 2 in.), as well as the rate of flow of the gas, and finally passes into the atmosphere or is washed into a drain by means of a suitable baffle.

Large-scale equipment for nitriding is described by Roth;¹⁰ Landau¹² has dealt with nitriding furnaces.

Methods of Sealing Containers. Various sealing methods have been discussed by Sergeson and Deal.²¹ Figure 14 illustrates these types.

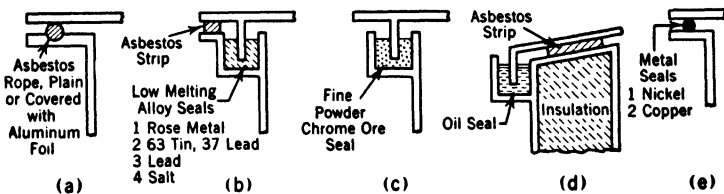

FIG. 14. Methods of sealing containers.

Time Required for Nitriding. Much effort has been spent on speeding up the rate of nitriding. It is claimed¹³ that the presence of Cu gauze or turnings is an accelerator. At best, however, the production of the type of case usually required takes 1 to 2 days. Ash-

down¹⁴ secured a case 0.02 in. deep in 25 hr at 1075° on Al-Mo steel, with a surface hardness of 950 Vickers. In order to get speed of nitriding with depth and toughness of case, a higher temperature than usual was chosen, and maximum hardness sacrificed. This slowing down of production, compared to the hour or so of gas carburizing or the even shorter time of cyaniding to produce cases of comparable depth, together with the increased cost of nitriding steels over carburizing steels, restrict the use of nitriding to those cases where the wear resistance or other properties of the extremely hard nitride cases are worth the delay in production.

Dunn, Mackay and Dowdell¹⁵ used ammonia, produced by the thermal decomposition of urea within the nitriding container, or better produced outside in a separate heating chamber where the urea is decomposed at 270°. Unusual thickness of the nitride layer was obtained in a relatively short treatment (26 hr), at 950° on N 135 (see Fig. 9b for the type composition), though the surface hardness was only 900 Vickers.

O'Brien⁴⁵ nitrifies the regular nitriding steel, by operating in a salt bath at the normal temperature, 975–1000°. Ammonia is passed through the (undescribed*) salt bath, which is said to act catalytically to speed up nitriding. The composition and hardness of the case produced is not stated, but it is implied that it is a N, not a C-N, case. Whatever the composition of the case, he reports a thickness of 0.01 in. in 7½ hr, compared to 15 hr at temperature and 28 hr total time for that depth secured by ordinary nitriding, besides greater convenience.

Floe⁴⁷ characterizes this as a "claim," since the depth of the case is, as in carburizing, a matter of diffusion from the exterior layer. This exterior white layer (white after a nital etch) is necessary to provide the reservoir for diffusion, but it is the underlying diffused layer that is the useful one. To hold the white layer to minimum thickness, Floe advocates nitriding for 5 hr at 30% dissociation, and then increasing the dissociation to 85% (with ample circulation) until the desired depth of diffusion has been obtained. Floe's article deals clearly and concisely with all phases of nitriding.

Protection Against Nitriding. It frequently happens that certain portions of an article are to be protected against nitriding. An efficacious protective agent is tin or a solder containing 80 parts of lead and 20 parts of tin. The coating should be as thin as possible. Although tin and the alloy of lead and tin melt at a lower temperature

* Floe⁴⁷ states that 60% NaCN, 40% KCN, is a common composition.

than that used in nitriding, ample protection is provided by the thin layer that is held to the article by surface tension. Too much of the protective agent may cause the excess amount to drop onto articles at points where protection is not desired. A liquid flux containing zinc chloride and some ammonium chloride should be used. This flux can be made by adding zinc to a solution containing 500 cc hydrochloric acid, 250 cc water, and 15 g of ammonium chloride until no further action takes place. Parts to be tinned should be entirely free from rust or scale. The procedure recommended in using tin or solder for various parts is as follows:

For protection of the end of a part, clean the part to be protected, apply flux, and dip part into molten tin or solder to the depth to be protected. Remove excess tin or solder with wire brush. For protection of the mid-section of a part, protect ends to be hardened with fireproof varnish (such as Bakelite varnish), apply flux, and dip piece into molten metal to required depth. Remove varnish and excess metal with wire brush. For protection of a very small surface or keyways, apply flux to area, then apply protective agent with a soldering iron.

Copper¹⁶ or nickel plating is an excellent means for providing protection, but the plate must be relatively thick to prevent penetration of nitrogen. An electrolytic bronze coating is also used⁴⁶ and considered more effective.

Painting with a mixture of glycerine and tin oxide, shellac and tin oxide, or sodium silicate and chrome ore is also used, although complete protection is not always obtained with these materials. A paste containing lead and tin in a very fine condition in a suitable vehicle gives satisfactory protection.

Warpage and Growth. The fact that the nitriding process is carried on below the previous tempering temperature assures freedom from warping due to internal stress, and, since no quenching is required, the production of the nitrided case upon a symmetrical object produces but little warping, if the object has been uniformly heated and the gas flow regulated so that all portions have the same case depth. However, few objects to be nitrided are entirely symmetrical.

There is a slight "growth" during nitriding, and a piece that is not symmetrical, or that is protected against nitriding on one side, may warp in consequence. The growth itself can be compensated for by prior machining to just the proper amount undersize. The growth is about 0.001 in. per 0.01 in. of total case depth, but has to be determined for the example in hand when dimensional changes of this mag-

nitride are of importance. Grinding or lapping the nitrided surface may be resorted to when necessary to correct warpage or to finish to very close dimensional tolerance. Lapping off, say 0.001 or 0.002 in. from the surface, may be desired in order to put the very hardest portion of the case at the wearing surface when a case like that of the 1000° run of Fig. 10 or that shown in Fig. 9 has been produced, or to work down to a layer that is less brittle than the extreme surface.¹⁷ The original unlapped surface is more resistant to corrosion than one with the skin removed. The original surface is quite rust resistant against atmospheric corrosion; it also resists corrosive oils, still, non-aerated, fresh or salt water, and alkalis. Under submerged, aerated, corrosion in fresh or salt water it is less resistant, and it will not resist mineral acids.

The nitrided case will crack under any attempt to straighten a severely warped piece. Warpage must therefore be prevented. Dobkin¹⁸ recommends determining the growth that will occur with the nitriding schedule used, and finish machining just enough under size to accommodate that growth, remembering that 0.0015 in. is usually to be removed by grinding to get down to the hardest material. After the final undersize is thus determined, the stock is machined to it in three stages, first to 0.06 in. oversize, followed by a 2-hr, 1150° stress relief anneal in controlled atmosphere, second to 0.03 in. oversize again followed by the anneal, and only then, going to the final machined dimension, prior to nitriding.

Stability of Nitrided Case. One outstanding property of nitrided cases is their stability at moderately elevated temperatures. There seems to be no loss in hardness upon heating at least as high as the original temperature at which the steel was nitrided. Homerberg

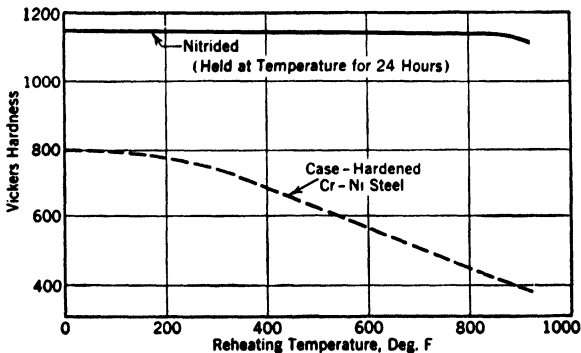

FIG. 15. Comparison of the hardness of nitrided and carburized cases at room temperature and after reheating as shown for 24 hr.

compares this behavior with that of ordinary carburized cases in Fig. 15. The hardness is only slowly reduced on heating even to 1600°.

Other Advantages. This fact, coupled with its corrosion resistance, adapts the nitrided case for faces on valves, for high-pressure, high-temperature steam, and other high-temperature service.¹ Mochel²⁰ has shown that nitrided steel is extraordinarily resistant to galling and seizure, either against itself or against quite a variety of other alloys.

Although the thin case cannot support a large core that itself has low creep resistance, some of the nitrided steels may be considered for high-temperature service on the basis of fair load-carrying ability, largely conferred by the Mo present.

The very hard case is of course very strong. If we calculate its strength by extrapolation of the Vickers-Brinell-tensile-strength relation, it would approximate 500,000 psi for some of the hardest cases. Even a thin coating of such strong material will notably raise the endurance limit of a nitrided steel shaft in rotary bending, since the maximum stress is at the outside of the shaft. This, plus the resistance to corrosion, makes nitrided steel useful in combating corrosion fatigue. However, if the repeated stress is applied axially, in straight tension and compression rather than in bending, the benefit of the strong but thin surface layer would be small.

Utility of Nitrided Parts. As an example Cone¹⁹ cites the production of nitrided cylinder barrels for airplane engines of a steel of 0.40 C, 1.15 Al, 1.60 Cr, 0.40 Mo, 0.55% Mn, which has been normalized from 1800°, then quenched from 1700°, and drawn at 1250° to put it into shape to nitride, and nitrided 50 hr at 1000° to produce a case of 800-1000 Vickers hardness. Freedom from warping and the ability to protect the outside of the cylinder against nitriding and thus keep it machinable, together with the great wear resistance of the case, were considered to justify its use. The long time required in processing has, however, brought nitrided cylinders into disfavor with some engine makers.

Precautions and Recommendations. Homerberg sums up the necessary precautions in nitriding as follows:

1. To ensure the best nitriding results, the steel should be heat-treated so as to possess a uniformly sorbitic structure.
2. Before nitriding the steel must be free from decarburization.
3. If freedom from distortion is of paramount importance, the internal stresses produced by machining or heat treating should be removed before nitriding by heating to a temperature of 1000 to 1300°.

4. Since some growth takes place on nitriding, this should either be allowed for in the final machining or grinding operation prior to nitriding or removed by lapping or by careful grinding. However, the removal of only a slight amount of the nitride case is permissible.

5. If maximum resistance to corrosion is desired, the parts should be used as they come from the nitriding container.

6. Nitrided steels of the nitralloy type should not be used where resistance to the corrosion of mineral acids is encountered or where resistance to sharp abrasive particles at high velocities is required, as in sand nozzles.

7. If straightening is required after nitriding, it should be done hot at 1200°, although some straightening may be done cold.

8. If maximum hardness and maximum resistance to impact are desired and the question of maximum corrosion resistance is not of vital importance, the removal of 0.001 to 0.002 in. of the nitrided case is desirable. The amount to be removed depends on the original case depth. This operation will remove the more brittle and somewhat softer surface layer.

9. If nitrided articles exhibit a shiny gray surface after their removal from the container, the results should be viewed with suspicion. Invariably, the case will be shallow and below normal hardness. The articles should have a matte gray appearance, although a slight discoloration does not indicate faulty nitriding. A slight vacuum may be created within the container when the furnace is shut off, and, if a small amount of air enters through the gasket, the articles may show various hues such as pink, blue, or light brown. Increasing the flow of NH_3 at this stage or nitriding in the presence of Cu turnings will frequently prevent this discoloration. The opening of the container at too high a temperature will also cause surface discoloration.

10. Specimens that can be checked for hardness and depth of case should be included with every charge.

11. Applications requiring a high core hardness to support the case when high compressive stresses are present require nitriding steels of special analyses.

12. Although special nitriding furnaces are desirable, such equipment is not absolutely necessary. In most instances these special furnaces are constructed so that they can be used for general heat-treating purposes when not used for nitriding. The most essential point is that a furnace must maintain a uniform temperature within the nitriding container and provide for uniform circulation or flow of the nitriding gases. The container should not react with the gases so as to rob the work of active N, or to produce too much H.

A precaution stressed by Jominy⁴ and Floe⁴⁷ is that the exterior white layer (higher in N than the layer beneath it) is excessively brittle, tends to flake and spall, and will not withstand high loads. Hence, removal of the outside layer is required. If it is not all removed, as by too light lapping, performance is poor. If, through warpage or poor machining setup, too much is ground away, a level is reached where hardness and wear resistance are inferior. The excessive thinness of the nitrided layer thus calls for high-class machine-shop work. Such comment emphasizes the importance of the stress-relief treatments prior to nitriding, suggested by Dobkin,¹⁸ and,

obviously, they are doubly important when the object to be nitrided is nonsymmetrical.

Discussion of steels for nitriding and their properties is given in Vol. III. The whole topic has been treated in a symposium,²² and has been especially well discussed by Jenkins.⁴⁹

Cyaniding. Nitride cases upon unalloyed steels containing large ferrite patches are brittle; the presence of well-distributed carbide seems necessary to give a proper transition zone. In cyaniding in molten baths, at 1350–1650°, both C and N are taken up. As Fig. 10 indicates, pure nitride cases produced at high temperatures are not so hard as those produced at ordinary nitriding temperatures. However, some increase in case hardness over straight carburizing is obtained in these combined C and N cases. The N is concentrated in the exterior of the case, since N does not diffuse so rapidly as C in steel. The combination case can be considered as one predominantly or largely of nitride on the outside, merging into and being backed up by a carbide case. Since only the thinnest skin of nitride is sought, and the operating temperature is higher, the time for its production is far less than that for straight nitriding, as even this shorter time allows the building up of the supporting carbide layer. A pure iron nitride layer on a plain C steel would be too brittle, but with the presence of carbide to improve the transition zone, plain C steels can be usefully given the carbide–nitride surface.

Dry Cyaniding. Such surfaces are produced by adding a source of active N to the gas supply in a gas-carburizing process. This is termed “dry cyaniding,” or gas cyaniding, although no cyanide is used. Another term is “carbonitriding.”

Carburizing–Nitriding Procedures. Machlet²³ suggested adding hydrocarbons to oppose the decarburizing tendency of the H freed from the NH₃ in regular nitriding, but, as is known from experience on gas and pack carburizing, carburizing action at 950–1000° is negligible, whereas decarburization can occur at low temperatures.

Berkhin and Laklitin²⁴ claim that bubbling the NH₃ gas through aniline (C₆H₅NH₂) before it enters the nitriding chamber accelerates nitriding. Whether any carburization occurs in such a process is not stated.

Egan²⁵ has reported the production of a case 0.007 in. thick, with 1000 Vickers–Brinell surface hardness, on a 0.25 C, 1.69 Cr, 0.63% V steel nitrided by NH₃ bubbled through C₆H₅NH₂, by only 4-hr exposure at 1580°.

Straight aniline vapor, from aniline fed into an electrically heated gas-carburizing outfit, was found, in tests kindly reported by H. E. Koch, to produce a case about 0.0025 in. thick in 4½ hr at 1500°. The case, quenched as for regular case hardening, showed 900 Vickers-Brinell at the very outside, and again at 0.0015–0.0020 in. depth, but from 0.0002 to 0.0014 in. depth the hardness was 850. The distribution of C and N in the case is not known, but the hardness curve would indicate that both elements were taken up.

Simultaneous gas carburizing and nitriding by leading in both a hydrocarbon gas and NH₃ has come into use. According to the early discussions^{26, 27} of the process, a thin case may be produced at 1150°, whereas heavier ones are produced at 1250–1500°. For some applications a sufficiently hard case may be secured without quenching. Wyzalek²⁸ states that gas carburizing with propane and air, to which NH₃ vapor is added, gives a case very similar to that obtained by cyaniding. On SAE1010, file-hard cases of 0.001 to 0.01 in. are produced without resorting to quenching.

Parshall⁴⁸ reports that cases produced by carburizing gas plus NH₃ are produced about 200° lower than in straight gas carburization and are satisfactorily hardened by oil quenching. One example, cited by him, is the production of 0.02-in.-thick cases by 1 hr at 1650°, cooling to 1550°, and oil quenching. Other examples give 0.02–0.025 in. in 3 hr at 1500°.

Cowan and Bryce²⁹ noted that the introduction of NH₃ lowered the temperature or shortened the time for carburizing to a desired depth, and increased the C content of the case over like processes without use of NH₃. A case with a nearly linear drop in both C and N from the high-C high-N exterior to unaffected steel, over a distance of 0.01 in. was produced in 1½ hr at 1450°. Allen³⁰ reports production of file-hard cases on 1010 thrust washers, with a case depth of 0.005 in. by continuous carbonitriding 5 hr at 1425°, in an atmosphere of H₂, N₂, CO carrier gas, plus natural gas and NH₃. The parts are slow-cooled. Quenching is not used on these thin washers for fear of distortion.

Trautschold³¹ reports more rapid formation of the case at a higher operating temperature, about 1600°, at which 0.001 in. is produced in 15 min and 0.035 in. in 4 hr. The composition of a case of intermediate thickness, at different depths, was as shown in Table 10, at the left. At the right are given, for comparison, similar data for a conventional liquid bath cyanide case of equal depth.

TABLE 10

Dry Cyanide Case			Liquid Cyanide Case	
Depth, In.	% C	% N	% C	% N
0.004	0.53	1.41	0.75	0.83
0.008	0.47	0.33	0.56	0.43
0.012	0.30	0.07	0.30	0.11
0.016	0.19	0.06	0.20	0.04

The ratio of NH_3 to carburizing gas also affects the relative pickup of C and N, as Fig. 16, from Woodward and Quinn³² shows. The reverse of the Machlet suggestion, mentioned previously, is cited by

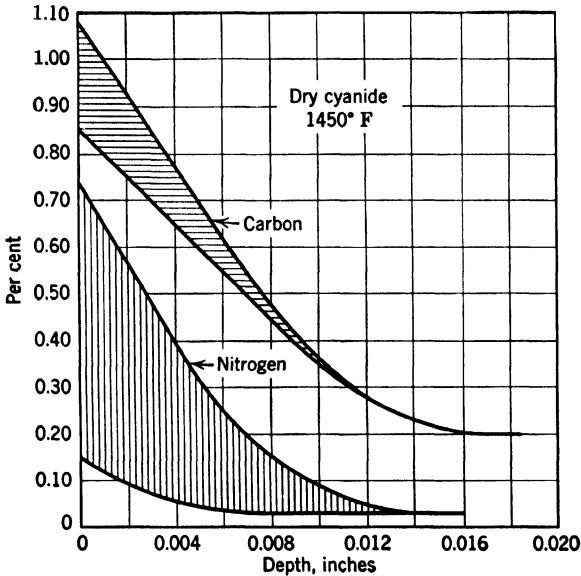

FIG. 16. Range of carbide-nitride cases produced on SAE 1020 steel by varying carburizing gases and proportions of ammonia used in conjunction with them.

Trautshold. In the slow cooling of pack-carburized parts, some surface decarburization can appear (see Chapter 4). To overcome this, or to add a still harder skin, a previously carburized and slow-cooled part, ground slightly under the desired dimensions, is dry-cyanided for an hour, to give it an N-containing skin 0.006–0.008 in. thick. This avoids the cleaning of the part from adhering salts, a step that would be necessary with liquid cyaniding.

Liquid Cyaniding with the Aid of Ammonia. This process, as developed by one commercial organization, has been termed "Chapmanizing."

Malcolm,³³ without giving details of the "Chapmanizing" treatment, cites equivalent Rockwell C on "chapmanized" gears with about 0.02 in. case depth as follows:

1025	58-59
2512	62
3250	63
3120	63

Brinelling the pieces for brittleness (10-mm ball, 3000-kg load) resulted in no visible cracking of the case.

The process consisted, in its early development, in bubbling NH_3 into a cyaniding salt bath, in order to secure more N in the case and

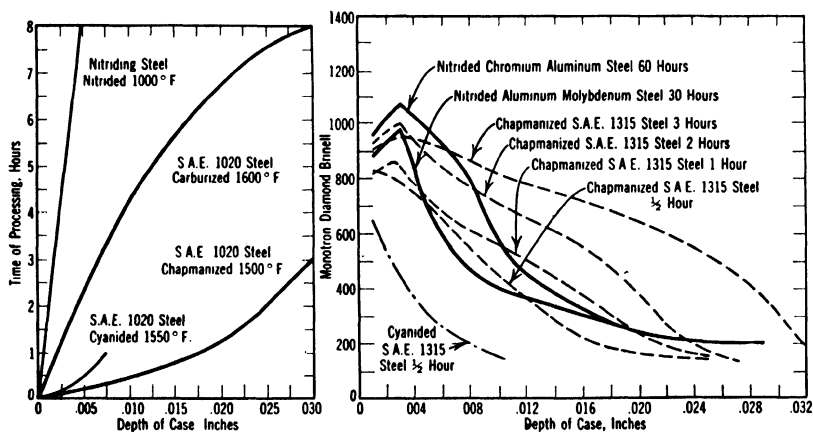

FIG. 17. Relative rates of producing cases and relative hardness, in cyaniding, nitriding, and "Chapmanizing." (After Rolf³⁴)

hence a harder case than in ordinary cyaniding, and to produce the case more rapidly than in ordinary nitriding. Securing suitable contact of the stream of NH_3 gas with the work immersed in the salt bath is not easy, and users commented on irregular cases in the early stages of development of the process.

Figure 17 shows curves as given by Rolf.³⁴ A surface hardness of 890 Vickers-Brinell on a 0.20% C steel casting is reported by Kerr³⁵ in studies of erosion by cavitation, which is in agreement with the curves shown.

According to Rolf the NH_3 is now dissociated by heating before the gas is led into the bath, the tubing being made of some material that will not deactivate the active N too rapidly. Some users consider the process as at present worked out quite satisfactory for thin cases. Rolf states that light cases consisting almost entirely of nitride rather than carbide may be obtained at 1250–1400°, but the usual case is best produced at 1500°. The rate of formation of the case on a 0.17% C steel without special alloys is given in Table 11.

TABLE 11
DEPTH OF CASE IN INCHES

<i>Time, Min</i>	<i>1450°</i>	<i>1550°</i>
30	0.005	0.008
60	0.011	0.017
90	0.016	0.021
120	0.019	0.026
150	0.023	0.027
180	0.026	0.031

Roshong³⁶ reports that introduction of NH_3 into the cyaniding bath gives better wear resistance than results from cyaniding alone and suggests dropping the temperature from 1550 to 1300° before quenching.

Holden³⁷ believes that active N, from NH_3 bubbled through a cyanide bath, the atmosphere above which is maintained under pressure, regenerates the cyanide that has been broken down.

The salt bath used is given as

KCl	20
Na_2CO_3	20
NaCN	36
K_2CO_3	19
NaF	5

The operating temperatures are 900–1200° for No. 135 nitralloy.

Ten hours at 975–1000° are said to produce a case 0.0014 in. thick, of 89–93 Rockwell superficial N.

Straight Liquid Cyaniding. Nascent N and nascent C are both produced by the decomposition of cyanides, such as NaCN, KCN, or $\text{Ca}(\text{CN})_2$.

A crude form of cyanide hardening, used by blacksmiths to produce a very thin case, is to heat the steel to 1550–1600°, plunge it into powdered NaCN (96% grade) or sodium ferrocyanide, or sprinkle

one of these compounds on the hot steel, reheat to 1550–1600° to melt the compound, repeat if necessary, and quench. In most liquid cyaniding, pure cyanide is not used, it is dissolved in other fused salts.

A pure cyanide treatment is advocated by Gill² for fine-edged high-speed steel tools like taps and reamers. The finished tool is slowly preheated to 1000° and immersed 5 to 60 min in an aged bath, originally made up of 50% NaCN and 50% KCN, held at 1050°. The tool is then cooled in air. The case is so thin that the method is applicable only to finished steel.

All these carburizing and nitriding processes are fundamentally alike in that an active freshly formed (nascent) atom of C or N is released at the steel surface, taken up by the steel, and then diffused beneath the surface. It might be supposed that the cyanogen radical, CN, would be taken up from cyanide, but this is evidently not the case, for the ratio of C to N is not constant. Instead, the cyanide must break down to produce both active C and active N.

Reactions. NaCN appears to decompose on heating in two different ways, according to Barsky,³⁸ though both are brought about by the effect of oxygen from the air.

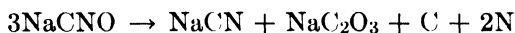
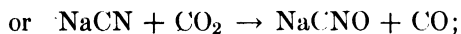
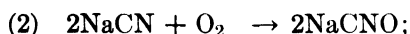
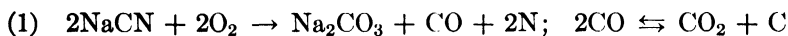

The effect of oxygen was checked by noting that in a deep bath action was less rapid at the bottom, where air had less access, and that action was slowed down if the air over the pot was displaced by N₂.

McClosky and Loux³⁹ give the reactions as

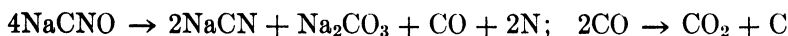

Whatever the intermediate steps are, NaCN is oxidized by O₂ or CO₂ to cyanate, NaCNO, several molecules of which get together and then break down, regenerating some NaCN, and producing Na₂CO₃, active N, and CO, which in turn breaks down into CO₂ and active C.

This leads to the conclusion that, since Na₂CO₃ is going to be produced anyhow, it is the logical salt in which to dissolve the NaCN. It also appears that NaCN will be used up, so that additions of it will be required from time to time.

Composition and Depth of Case. The composition of the cases produced by Na_2CO_3 - NaCN mixtures, according to composition of the bath, temperature, and time, are shown by Bishop,⁴⁰ in Fig. 18.

The case depth produced in a 50% NaCN , 50% Na_2CO_3 bath, with varying times and temperatures, as given by Thews and Snelling,⁴¹

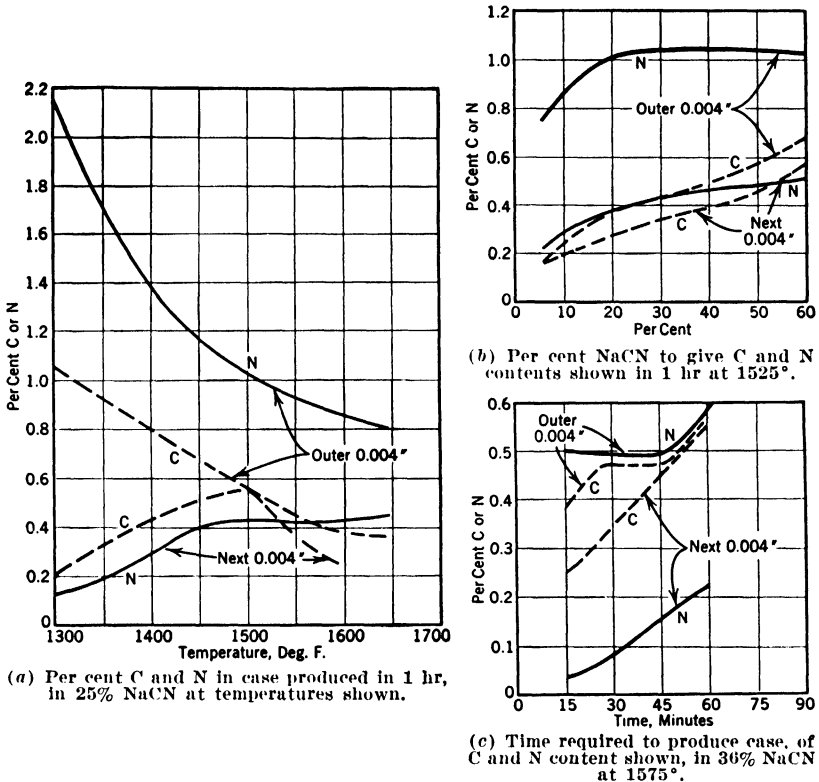

FIG. 18. Carbon and nitrogen in outer 0.004 and next 0.004 in., in cyanide cases produced on SAE 1020 steel under varying conditions. (After Bishop⁴⁰)

is shown in Fig. 19. Thews and Snelling state that 3% Ni steel is more rapidly cased by cyanide than are plain C steels. If this is correct, it is just the reverse from the ordinary behavior often claimed for box carburizing.

Many proprietary baths are on the market, with varying proportions of NaCN and Na_2CO_3 , with some Na_2CO_3 replaced by K_2CO_3 , and with varying amounts of NaCl .

The presence of chlorides opposes the take-up of N, and favors that of C. The chloride-containing baths are usually operated at a

higher temperature than the carbonate baths, which also operate in the same direction.

Great claims are made for speed of treatment and depth of case for the various mixtures; these usually resolve themselves into the behavior expected from the cyanide concentration and temperature.

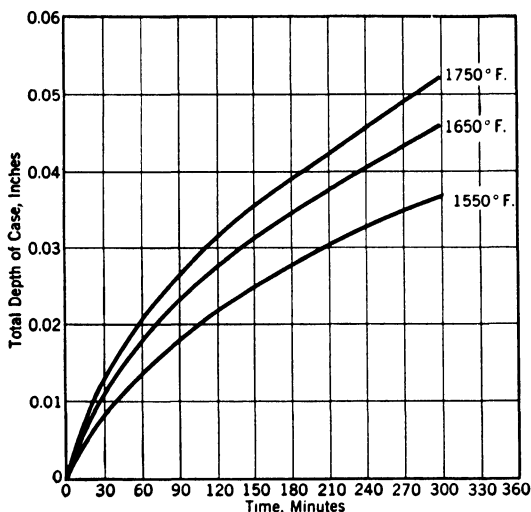

Fig. 19. Depth of case versus time in 50 NaCN, 50 Na₂CO₃. (After Thews and Snelling ⁴¹)

Case Depth. For normal concentrations, the general expectation is about as shown in Table 12, according to the *ASM Handbook*. The N content will vary also, as is shown in Fig. 18.

TABLE 12

Temperature, Degrees	Time, Hr	Case Depth, In.	Carbon Content of Case, %
1550	1	0.10–0.012	0.60
1550	3	0.018–0.020	0.70
1600	1	0.010	0.45
1600	3	0.015–0.018	0.65

According to the *ASM Handbook*, case depth in cyaniding does not vary greatly with the composition of the steel. SAE 1020, 2315, and 3115 all take on approximately the same depth of case under the same conditions, though the Ni and the NiCr steels may show slightly lower C in the case and a better gradient.

Cyanide Cases. Since in many applications like automotive gears, for example, very slight wear ruins the object, the high-C wear-resistant skin need be only very thin. In such cases it is necessary to carburize only for a short time, but to be sure that in that short time a surface skin of the proper C or C and N content is built up. Solid carburizers, as are shown in Chapter 4, do not readily build up a hypereutectoid case in a short time, and so, for very thin wear-resistant skins, either gas carburizing which can be adjusted to produce a hypereutectoid case or a cyaniding process is chosen. Cyaniding in baths of *low* cyanide content does not build up a thick case so rapidly as do the box and hydrocarbon-gas methods.

Schenck ⁴² prefers a cyanide case of about 0.002 in. on gears, on the theory that the least thickness that will provide wear resistance is the best. This is built up on SAE 3145 steel by heating in cyanide 6 min at 1325°, transferring in turn to two other cyanide pots, both at 1500°, and finally to another at 1325°, after which the gears are oil-quenched. The NaCN content used is low, being held between 3 and 6%. The depth of case increases with time, temperature, and with concentration of cyanide in the bath. Thus 30 min at 1500° will give 0.002 in. in 5% cyanide, 0.004 in. in 10%, and 0.006 in. in 30%.

Using 10% cyanide, a 30-min dip at 1300° will give 0.0005 in., at 1400°, 0.0025 in., at 1500°, 0.0040 in., and at 1600°, 0.0048 in. Stronger cyanide and shorter times are commonly used. Cyaniding is usually done just above the upper critical for the core, and the work is quenched directly. The C in the case will run from 0.50 to 0.75%, but about 0.50% N will also be taken up. The case is file-hard because of the presence of iron nitride in spite of the low C content.

The low NaCN-content baths are only a shade removed from a plain salt bath, such as is discussed in Chapter 7. "Activated" baths are intermediate between plain salt baths and the baths containing considerable NaCN. They are aimed to produce cases higher in C.

Activated Baths. The "activated" baths, chloride salt baths, which use calcium cyanide, $\text{Ca}(\text{CN}_2)$, instead of NaCN, react primarily according to the following reaction: $\text{Ca}(\text{CN}_2) \rightarrow \text{CaCN}_2 + \text{C}$, though some formation of nascent N occurs also. However, the liberation of nascent C is greater than the liberation of N, and the surface cases contain, depending on time and temperature, around 0.70 to 1.0% C, together with about 0.20–0.25% N.

Thus the cases from activated baths are less brittle than those from the NaCN baths and approach more closely to those obtained in box or gas carburizing.

Case Depths. The cases from the $\text{Ca}(\text{CN})_2$ -activated baths grow to a given depth somewhat faster than those from NaCN, the case being some 25 to 50% deeper for the same time and temperature.

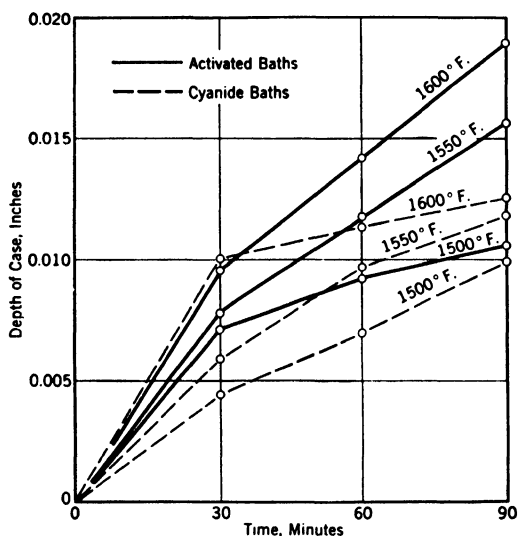

FIG. 20. Data obtained on $\frac{1}{16}$ -in. bars in commercial-scale tests. The cyanide bath contained 22–24% NaCN. Depth is average for SAE 1015, 3115, and 4615 steels. Hardness, determined by Rockwell Superficial Tester (15N scale), was the same (89.5–92.5) for all steels, all times of immersion, and for either bath. (Beckwith ⁴³)

That is, C diffuses in faster than N, again showing that the activated bath behaves more like ordinary carburizing than does the NaCN bath. Because of this difference in diffusion rate, the C–N cases tend to be richer in N on the outside.

Beckwith ⁴³ shows Fig. 20 for the relative rates of casing in cyanide and activated baths. He recommends 1450–1550° for operating cyanide baths and states that the automotive industry holds to that temperature range. In discussion, Tour ⁴⁴ argued for a lower temperature range, 1350–1450°, because of rapid decomposition of cyanide.

Cyanide Is Poisonous. The poisonous nature of all cyanides must be remembered and the greatest care taken not to get them into the mouth or into cuts or sores. The furnaces should be hooded and ven-

tilated so that fresh cyanide fumes are not breathed. The steel heated in a cyanide bath may be quenched into limewater to neutralize the adhering cyanide and prevent danger in handling the steel thereafter.

Cladding, Calorizing, and Analogous Processes. Carbon steel plate or sheet carrying a thin skin of stainless steel or of Ni on one or both surfaces, made by casting the steel against a plate of the corrosion-resistant material so that it welds to it and rolling the duplex billet down, or by equivalent methods, is commercially available. This plate is analogous to the composite plates of high- and low-C steel that have long been used for making plowshares and the like. These "clad" steels are fabricated by hot or cold forming and by welding, and suitable means are employed to protect the cut edges. Some irregular objects cannot be made by such methods, but it is, nevertheless, possible to provide objects of almost any shape with special alloy surfaces, by one method or another.

Surfaces high in alloy content can be built up by methods somewhat analogous to carburizing, in which the steel is heated in a granular packing of the metal to be applied and a suitable atmosphere maintained, or by heating in a gas from which the desired metal can be deposited, for instance, a volatile chloride of the metal. After the required thickness of metal has been secured on the surface, a further heating to allow diffusion is usually required.

Aluminum is added by heating in Al powder plus some inert material to keep the powder from caking. The coating is then given a diffusion treatment, and superficial oxidation is allowed, in order to secure a heat-resistant coating. This process is called "calorizing." Though it does not find very wide application, it is useful in specific cases.

Chromium or silicon may be added in similar fashion, usually in the presence of a volatile chloride, in the "chromizing" and "siliconizing" processes for production of corrosion-resistant surfaces. These processes have not yet been very completely worked out on the production basis, and their economic value cannot yet be appraised. The general principle of using an easily fabricated cheap steel as the base and giving it a surface of the sort necessary to resist scaling, corrosion, or wear will undoubtedly find increasing application. For the present, at least, these special processes will be carried out in plants specially equipped and experienced, rather than in the average heat-treating department, so they need not be discussed in detail here.

BIBLIOGRAPHY

1. M. A. GROSSMANN, Present position of nitralloy in industry, *Metals & Alloys*, V. 2, 1931, pp. 150-4.
2. J. P. GILL, The modern heat treatment of high speed steel tools, *Ind. Heating*, V. 4, 1937, pp. 827-34.
3. P. A. HAYTHORNE, Nitriding of aircraft steels, *Iron Age*, V. 157, January 31, 1946, pp. 44-8.
4. W. E. JOMINY, Aircraft engine metallurgy since World War I, *Steel*, V. 117, November 5, 1945, pp. 128-9, 192-9.
5. H. W. MCQUAID and W. J. KETCHAM, Some practical aspects of the nitriding process, *Trans. ASST*, V. 14, 1928, pp. 719-43.
6. B. JONES, Developments in the nitrogen-hardening of steels, *Metal Treatment*, V. 3, 1937, winter number, pp. 165-70. Also, The nitrogen hardening of high-chromium and austenitic steels, *Jour. Iron and Steel Institute*, V. 136, 1937, pp. 169-185.
7. J. E. KONTOROVICH, Rapid nitriding of steel, *Metal Progress*, V. 27, February 1935, pp. 43, 52.
8. V. E. LYSAGHT, The Rockwell superficial hardness tester, *Metals & Alloys*, V. 3, 1932, pp. 185-8.
9. H. J. FRENCH and V. O. HOMERBERG, The role of nickel in nitriding steels, *Trans. ASST*, V. 20, 1932, pp. 481-506.
10. W. ROTH, Nitriding engine parts, *Steel*, V. 117, November 19, 1945, pp. 123-4, 184.
11. C. F. FLOE, A study of the nitriding process, *Trans. ASM*, V. 32, 1944, pp. 134-7.
12. D. LANDAU, Nitriding furnaces, pamphlet, Nitralloy Co., New York, 99 pp.
13. A. B. KINZEL and J. J. EGAN, Nitriding in packing materials and ammonia, *Trans. ASST*, V. 18, 1930, pp. 459-73.
14. H. H. ASHDOWN, Nitriding plant and technique, *Metals & Alloys*, V. 3, 1932, pp. 210-13.
15. R. P. DUNN, W. B. MACKAY, and R. L. DOWDELL, Urea process for nitriding steels, *Trans. ASM*, V. 30, September 1942, pp. 776-91.
16. W. V. STERNBERGER and E. R. FAHY, Copper plating as a stop-off when nitriding, *Metal Progress*, V. 47, February 1945, pp. 278-9; V. 48, December 1945, pp. 1311-12.
17. V. O. HOMERBERG and J. P. WALSTED, Wear resistance of nitrified nitralloy, *Metal Progress*, V. 18, December 1930, pp. 68-71.
18. H. DOBKIN, Insuring dimensional accuracy through heat treatment, *Steel*, V. 118, February 18, 1946, pp. 90-1, 104-08.
19. E. F. CONE, Nitralloy cylinder barrels for airplane engines, *Metals & Alloys*, 1936, pp. 119-21.
20. N. L. MOCHEL, The seizing of metals at high temperatures, *Proc. ASTM*, V. 28, Part 2, 1928, pp. 269-77.
21. R. SERGESON and H. J. DEAL, Further investigations in nitriding, *Trans. ASST*, V. 18, 1930, pp. 474-501.
22. *Nitriding Symposium*, American Society for Steel Treating, 1929, 222 pp.

23. A. W. MACHLET, Hardening or treatment of steel, iron, etc., U. S. Pat. 1,092,925, April 14, 1914.
24. V. BERKHIN and Y. LAKLITIN, Rapid method of nitriding steel, *Novosti Tekhniki*, 1936, nos. 34-35, pp. 9-11. Abstract, *Chem. Abstracts*, V. 31, 1937, p. 2147.
25. J. J. EGAN, Short-time nitriding, *Trans. ASST*, V. 19, 1932, pp. 481-500.
26. Dry cyaniding—a new case-hardening process, *Ind. Heating*, V. 5, 1938, pp. 168, 170.
27. Dry cyaniding, *Steel*, V. 102, February 21, 1938, pp. 62, 64.
28. J. F. WYZALEK, discussion, *Carburizing Symposium*, October 18-22, 1937, American Society for Metals, pp. 83-216, 217.
29. R. J. COWAN and J. T. BRYCE, The process of dry cyaniding, *Trans. ASM*, V. 26, 1938, pp. 766-87.
30. A. H. ALLEN, Carburizing and nitriding, *Steel*, V. 117, September 24, 1945, p. 118.
31. R. TRAUTSCHOLD, Surface hardening, *Steel*, V. 111, October 26, 1942, pp. 64-5, 97-8.
32. E. R. WOODWARD and R. J. QUINN, Ammonia for processing metals, *Metals & Alloys*, V. 22, August 1945, pp. 418-24.
33. V. T. MALCOLM, Light cases, *Trans. ASM*, V. 26, 1938, pp. 743-50.
34. R. L. ROLF, Chapmanizing, *Steel*, V. 102, January 10, 1938, pp. 48-51.
35. S. L. KERR, Determination of the relative resistance to cavitation erosion by the vibratory method, *Trans. ASME*, V. 59, 1937, pp. 373-97.
36. R. G. ROSHONG, Practical applications of heat-treating processes, *ASM Review*, V. 10, December 1937, p. 2.
37. A. F. HOLDEN, U. S. Pat. 2,395,329, February 19, 1946.
38. G. BARSKY, The chemistry of liquid hardening baths, *Trans. ASST*, V. 20, 1932, pp. 347-56.
39. C. R. McCLOSKEY and J. H. LOUX, Theory of the mechanics of carburization, *Steel Processing*, V. 32, January 1946, pp. 53-5.
40. E. G. BISHOP, Case hardening and heat treatment with liquid cyanides, *Heat Treating Forging*, V. 22, 1936, pp. 282-8.
41. E. R. THEWS and R. W. SNELLING, Casehardening in cyanides, *Heat Treating Forging*, V. 22, 1936, pp. 517-20.
42. R. B. SCHENCK, Metallurgy of transmission gears, *SAE J.*, V. 38, June 1936, pp. 13-19.
43. B. B. BECKWITH, *Liquid Bath Carburizing Symposium*, October 18-23, 1937, American Society for Metals, pp. 326-36.
44. S. TOUR, discussoin, *Ibid.*, pp. 333-9.
45. T. F. O'BRIEN, Heat treatment of steel, *Metals & Alloys*, V. 21, May 1945, pp. 1336-50.
46. Tin bronze as nitriding stop-off, Staff article, *Can. Metals and Met. Ind.*, V. 9, June 1946, p. 43.
47. C. F. FLOE, The nitriding of steel, *Metal Progress*, V. 50, December 1946, pp. 1212-20.
48. H. M. PARSHALL, Gas cyaniding, *Steel*, V. 119, December 6, 1946, pp. 86-8.
49. I. JENKINS, Controlled Atmospheres for the Heat Treatment of Metals, Chapman & Hall, London, 1946, 532 pp.

CHAPTER 4

CARBURIZING PROCESSES

Carburizing processes involve two steps, production of nascent C at the surface of the steel, and diffusion of the C into the steel. These are followed by heat treatment.

The nascent C is produced by the breakdown of a gas, either CO or CH₄. The CO may be supplied as such, or produced within the carburizing container by reactions of a solid carburizing medium. Commercial carburizing is actually gas carburizing.

Reactions. Methane, CH₄, may be supplied as such, or as higher hydrocarbons, or other compounds which break down at the operating temperature into H and CH₄. Thus the mechanism of supplying C involves only CO or CH₄, though it is complicated by the presence of other elements or compounds in the gas. The reactions are

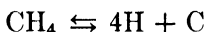

The requirement of diffusion inward of the nascent C, supplied at the surface of the steel, and taken up by that surface, means that the steel must be in the austenitic temperature range and that time must be allowed for diffusion. Austenite has high solvent power for C; ferrite very low solvent power. Carburizing is therefore done above A_{c_3} .

As the C content of austenite rises toward saturation, the pickup of C tends to slow down. To keep it up, the gas must be richer in CO or CH₄ than it need be when the C content was lower. The austenite acts as though it were setting up a resistance, or reverse pressure, acting against the carburizing gas, which is exerting a positive carburizing pressure.

Carbon Pressure. This leads to a useful concept, well stated by Cullen,¹ that steel of a given composition and C content, at a given temperature, has a given "carbon pressure," and that a carburizing atmosphere has a positive "C pressure"; a decarburizing one a negative "C pressure." The whole story is not quite so simple, because

a given atmosphere has a different "C pressure" in contact with C than with steel, and a different one in contact with steels of different C contents. However, it is true that, for each steel and temperature, a gas composition can be found that is inert to the steel at that temperature, but not at all temperatures, (it may be decidedly carburizing at 1700° and decidedly decarburizing at 1250°).

Likewise different carburizing gases have different reactivities with steel, for instance, methane, CH₄, plus hydrogen, H₂, has a higher-C pressure than does CO plus a very little CO₂. Both combinations are carburizing, but the former gives up more C, thus producing a higher C content at the surface of the steel at a given temperature than the latter.

Gas Ratios. If we look at it another way, that of temperature alone, the reversible reactions $2\text{CO} \rightleftharpoons \text{CO}_2 + \text{C}$ and $\text{CH}_4 \rightleftharpoons 4\text{H} + \text{C}$ bring about the deposition of soot when the temperature is such that they run toward the right, or they eat away soot when it is such that they run toward the left. Addition of CO₂ or H₂ to the gas will force the reaction toward the left. For each temperature there is a CO:CO₂ or a CH₄:H₂ ratio, at which C is neither deposited nor eaten away, that is, an equilibrium condition.

When steel is present, the reaction tends to run to the left; soot is more readily deposited than when the steel is absent. This is termed a catalytic action.

Moreover, the C in the carburized steel surface, being busy holding onto the Fe in which it is dissolving, does not exert so much pressure as does uncombined C. The lower the C content in the steel surface, the lower the C pressure exerted on the gas by that surface. From this arises the fact that, in "solid" carburizing, when the CO, reaching the steel surface, has broken down to CO₂ + C, and the C has been taken up by the steel, the CO₂ then diffuses away and gets into contact with the C in the solid carburizer, the reaction then goes the other way; that is, $\text{CO}_2 + \text{C} \rightarrow 2\text{CO}$. Thus a CO:CO₂ ratio, too low to carburize any more, is altered to one high enough to continue carburization when the gas again diffuses back to the steel surface. If the CO:CO₂ ratio in the gas hitting the steel is too low, and no solid C is present, the gas will take C out of the steel; that is, it will decarburize. Similar conditions hold for the CH₄:H₂ ratio. These facts are tabulated in Table 13.

They can be plotted in various ways, as in Figs. 21 and 22.

Pure CO:CO₂ mixtures are not used in gas carburizing. The gas is diluted with N₂, and the atmosphere produced in box car-

TABLE 13

PER CENT CO₂ (BALANCE IS CO) AT EQUILIBRIUM IN CONTACT WITH GRAPHITE OR STEEL

Becker²

Temperature, °F	Graphite	1.2% C Steel	0.8% C Steel	0.4% C Steel	0.1% C Steel
1200	62.6	55.7	55.7	55.7	55.7
1380	26.3	21.8	25.1	28.5	28.5
1560	5.85	5.7	7.1	12.5	26.7
1740	1.5	2.0	2.9	4.8	14.2

burizing also contains N₂, unless the air is all expelled during heating up. The CO:CO₂ ratios are slightly modified by the presence of the diluting N₂, and so the lower curve of Fig. 22 is the one most

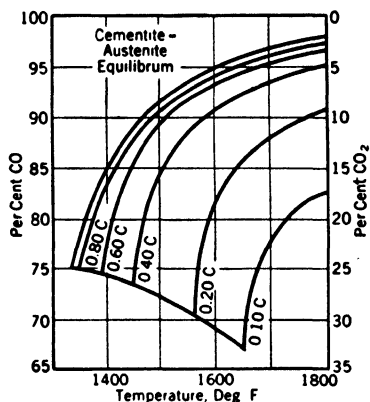

Schenck's curves for equilibrium of CO, CO₂ mixtures with steels of different C content. (Quoted by Webber³)

FIG. 21. This figure shows, for example, that, when sufficient time has been allowed for equilibrium, a 90 CO, 10% CO₂ gas at 1500° will carburize a low-C steel up to 0.80% C, but no higher. At 1600° this gas would carburize it only to 0.40% C. With a carburizing temperature of 1700°, to produce a hypereutectoid case, the gas needs to be 97% CO or more, with 3% CO₂ or less. In box carburizing, a reactive form of C, and an "energizer" are utilized to ensure a sufficiently high ratio of CO to CO₂.

nearly applicable to ordinary carburizing conditions. However, the difference is small, and, for ordinary purposes, attention need only be focused on the CO:CO₂ ratio, whether there is N₂ dilution or not.

Similarly to the case of CO:CO₂, the different CH₄:H₂ ratios are in equilibrium with steels of different C contents. This is shown in Fig. 23.

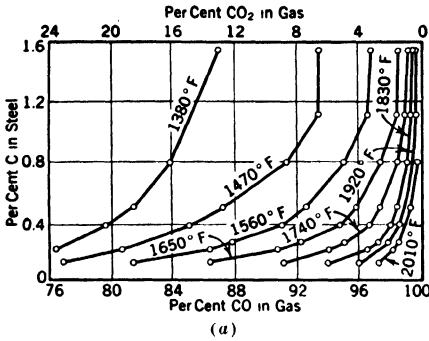

(a) CO:CO₂ equilibrium with steel (after Bramley and Lord, quoted by Grossmann 20). Gas of a ratio to the right of a curve is carburizing, that of a ratio to the left is decarburizing, for the temperature, and C content of steel shown.

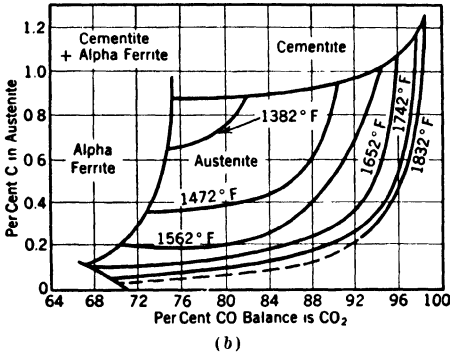

b) CO:CO₂ ratios equilibrium with steel, as shown by Takahashi, quoted by Webber.³

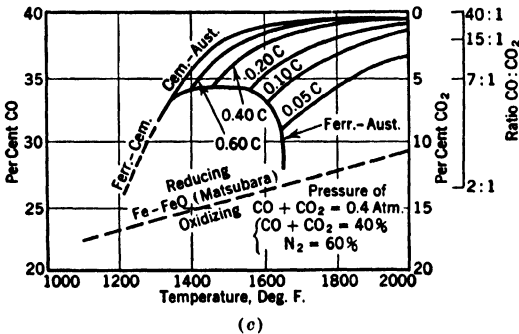

(c) Equilibrium CO:CO₂ ratios in gas mixtures containing 60% N₂. (After Johanson and von Seth, quoted by Webber 3)

FIG. 22. Various methods of plotting the relationships among gases of different CO:CO₂ ratios with steels of different C contents.

Figure 24a compares the ratios (curves *B* and *D*) of $\text{CH}_4:\text{H}_2$ and $\text{CO}_2:\text{CO}$. Curves *C* and *A* concern controlled atmospheres and need not be considered at this point in the discussion of carburizing. Figure 24b covers a wider range of temperature. Figure 24c shows the effect of dilution.

These figures show that, whichever carburizing gas is chosen, CO or CH_4 , the ratio of that gas to its respective decomposition product,

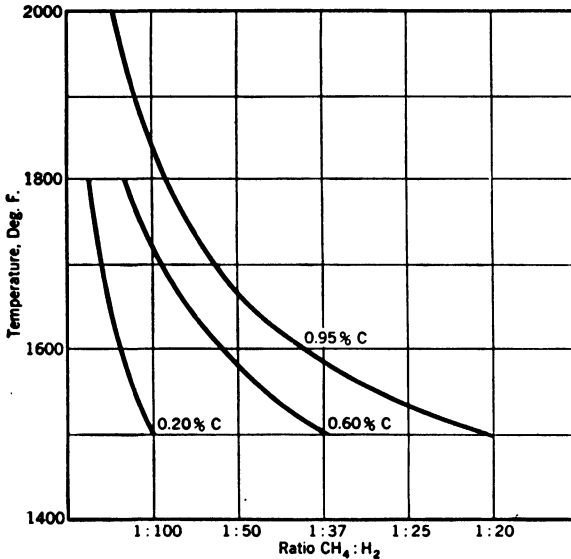

FIG. 23. Effect of various ratios of CH_4 to H_2 on steels of various C contents at various temperatures. A composition to the right of a curve is carburizing to that steel; a composition to the left is decarburizing. (After Sykes¹⁴)

CO_2 or H_2 , must be higher to carburize a high-C than a low-C steel. They also show that by holding the ratio exactly at that for equilibrium with a steel surface of a desired C content, at the chosen carburizing temperature, the C content of the steel surface will come to that figure and no higher. This is the principle used in "repairing" decarburized surfaces. If we wish to continue to raise the C content, a gas ratio richer in CO or CH_4 must be supplied. That is, for any given temperature and any given C content of the steel surface which they touch, there is some definite ratio of $\text{CO}:\text{CO}_2$ or $\text{CH}_4:\text{H}_2$ at which the carburizing and decarburizing tendencies are just balanced. At 1750° about 98 parts of CO to 2 parts CO_2 are required to keep the gas mixture slightly carburizing to high-C steels, whereas less than 1 part of CH_4 to 99 parts of H_2 is required.

Starting with pure CO, only a little CO₂ can be allowed to form without having carburizing stop; but starting with pure CH₄, a very large amount of H₂ can form without stopping it.

However, if the atmosphere is stagnant, and the gas at the steel surface is used gas, depleted of its carburizing power, that gas has to diffuse away and be replaced by richer gas, else carburizing will

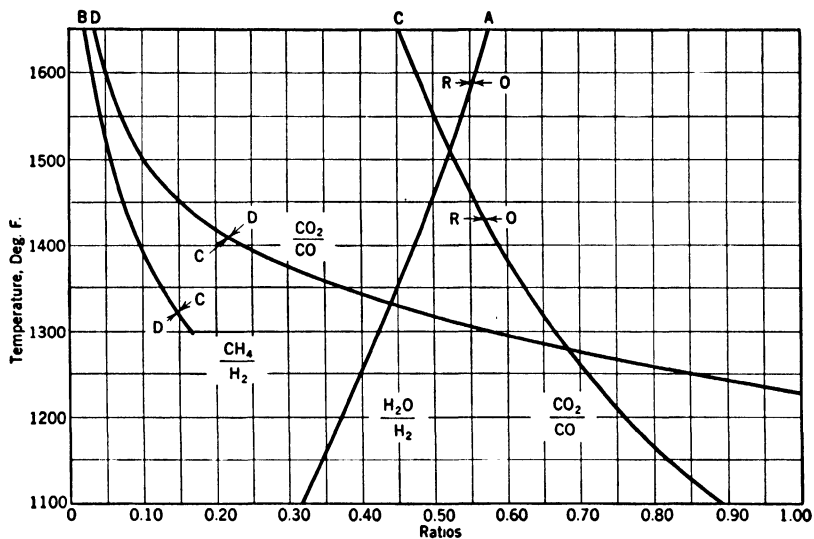

FIG. 24a. Equilibrium ratios for the CH₄:H₂, CO₂:CO and H₂O:H₂ reactions in contact with Fe-C alloys saturated with C at the temperature in question. (Stansel¹⁸)

O = Oxidizing
R = Reducing
C = Carburizing
D = Decarburizing

stop, or, if gas diffusion is slow, carburization will slow down. Hence, a turbulent gas flow is kept up in gas carburizing and, in solid carburizing, tumbling the articles in the container is sometimes resorted to.

Inactivity of Pure Carbon Monoxide. From the point of view of carburizing, it should be remarked that, though the equilibrium curves of Figs. 22 and 29 for CO:CO₂ indicate that pure CO or pure CO plus N₂ would be strongly carburizing, actually CO does not readily break down to deposit soot and form CO₂ by the reaction $2\text{CO} \rightleftharpoons \text{C} + \text{CO}_2$, and it appears essential, in order to have an actively carburizing gas, that a reversible chemical reaction should be going on, to produce nascent C. Thus at 1700–1750° a pure CO or pure CO + N₂ gas does *not* show a rapid rate of carburization.

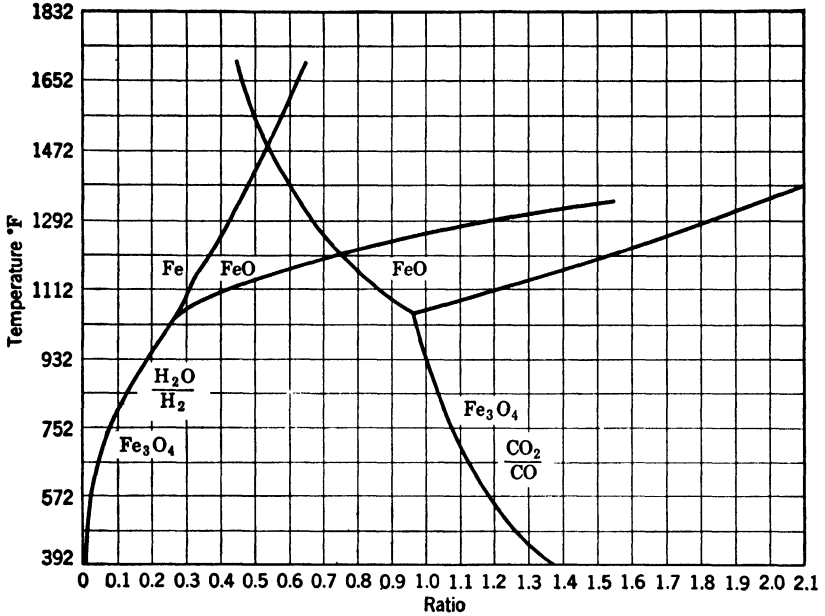

Fig. 24b. Same as Fig. 24a extended to a lower temperature range by calculation from data of Schenck.³³

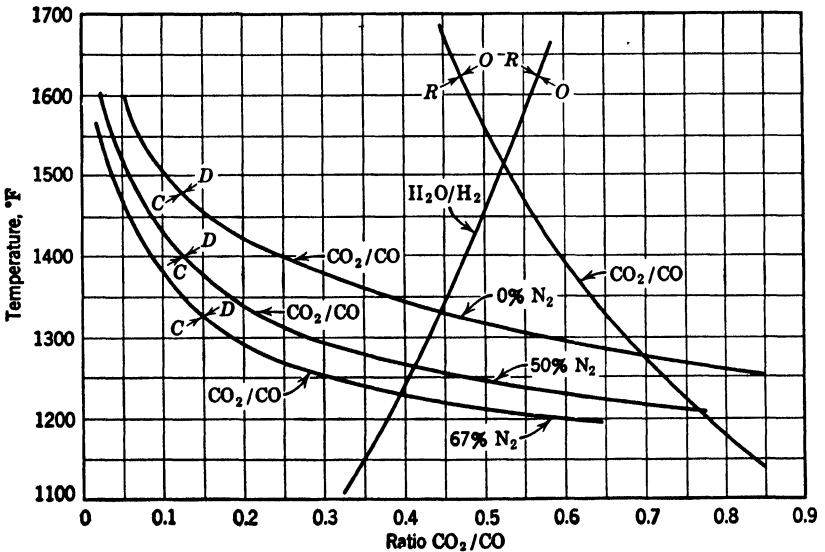
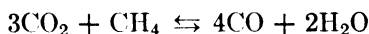
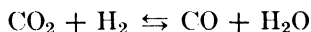

Fig. 24c. Variation of $\text{CO}_2:\text{CO}$ ratio at equilibrium when $\text{CO}-\text{CO}_2$ atmosphere is diluted with N_2 . Atmospheric pressure. (Turin³¹)

The behavior of any CO:CO₂ mixture, diluted only with N₂ and free from any other active gases, can be predicted from Figs. 22 and 24 for steel of any C content at any temperature. Figures 22 and 24 relate to stagnant gases. Varying rates of flow, especially at exposure times too short to reach true equilibrium, will somewhat modify the results, but the general relations are quite accurately shown by the curves. These relate to one atmosphere pressure of the gas mixture. Were heat treatment to be done at reduced pressure, somewhat modified curves would apply.

Hydrogen: Water Vapor. Commercial gases are not pure; moisture, that is, water vapor, is present unless the gas has been specially dried to remove it. The behavior of H₂O in presence of H₂, curve A, Fig. 24a is always decarburizing, never neutral. Even dry H₂ is somewhat decarburizing, and the reaction $\text{Fe}_3\text{C} + 2\text{H}_2 \rightleftharpoons \text{Fe} + \text{CH}_4$ is accelerated and forced to the right by the presence of H₂O; that is, C is removed from the steel. This will call for special emphasis under controlled atmospheres, Chapter 6.

While $2\text{CO} \rightleftharpoons \text{CO}_2 + \text{active C}$ and $\text{CH}_4 \rightleftharpoons 2\text{H}_2 + \text{active C}$ are the basic reactions, pure CO or pure CH₄, or mixtures of each with inert N₂, are relatively inert compared to their behavior in presence of even traces of H₂O. If both pairs CO, CO₂ and CH₄, H₂, or the pair CO, CO₂ and H₂ are present together, the CO₂ and the H₂ or CH₄ interact according to the reaction



which may first go

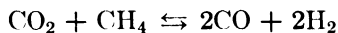

Thus, bringing both CO₂ and CH₄ into the gas surrounding the steel automatically produces a certain amount of H₂, which reacts with CO₂ to form H₂O, whose presence greatly accelerates both the carburizing and the decarburizing reactions. Commercial gases for carburizing are, in the case of CH₄, practically never free from some admixture of CO₂, nor, in the case of CO and CO₂, from some CH₄. Hydrogen, derived from anhydrous NH₃, can be had free from C-containing gases, but CH₄ or CO free from O-containing or H-containing gases, respectively, would be prohibitively expensive for carburizing (or controlled-atmosphere) use.

Commercial carburizing gases, as well as the gases formed in solid carburizing, therefore contain at least traces of H₂O when at

carburizing temperatures and in contact with steel. If these traces are insufficient to overcome the relative inertness of a relatively pure CO or CH₄, either H₂O as such, or something that will produce it, is intentionally added, to induce carburization. McClosky and Loux⁵ believe that CH₄ does not directly supply active C to steel, but indirectly through the reaction $\text{CH}_4 + \text{CO}_2 \rightleftharpoons 2\text{CO} + 2\text{H}_2$, and hence that CO is always the real carburizing agent.

Carrier Gases. Gier⁶ lists some commercial gases produced by controlled combustion of fuel gas with a deficiency of air, which mixture would ordinarily be insufficient to support combustion, but does burn in contact with a heated catalyst, in a heated enclosure, that are neutral to, that is, in equilibrium with, steels of differing C content, at 1700°, as shown in Table 14.

TABLE 14

% C in Steel						N ₂ , %	Dew Point, °F
	CO	CO ₂	H ₂	H ₂ O	CH ₄		
0.20	19.7	0.4	35.7	1.80	0.7	43.5	60
0.64	20.1	0.0 *	39.3	0.50	0.5	40.1	29
0.94	20.4	0.0 *	39.0	0.26	0.7	39.9	14
1.34	20.6	0.0 *	38.6	0.13	0.9	39.9	-4

* Permissible amounts below accuracy of ordinary analysis.

That is, in a gas of the CO, H₂, CH₄, and N₂ contents listed, only the low-C steel will be carburized at 1700°, unless CO₂ is absent and H₂O removed by chilling below the freezing point, or by other means. To carburize to the usually desired level, at a satisfactory rate, several per cent of CH₄ may be added to a neutral "carrier" gas of this type which has preferably been chilled to, say, 40°F or below.

Another relatively inert "carrier" gas favored by Harris⁷ is produced by burning fuel gas completely to CO₂. The resulting gas is cooled to room temperature, which condenses much of the water vapor from the H of the fuel gas, leaving around 2%. This N₂, CO₂, H₂O gas is then led over hot charcoal at 1850–1900°. The CO₂ is reduced to CO, the O of the H₂O makes more CO, and H₂ is freed. The resulting "reformed" gas contains about 20 CO, 2 H₂, 78% N₂, and has a dew point of 20°; that is, only a trace of water vapor persists. A mixture of from 85 volumes of this to 15 natural gas, up to around 70 volumes to 30 natural gas, is used, depending on the "C pressure" desired.

High Hydrogen Gas. From moisture adsorbed in the charcoal, H_2 is present, along with CO , in the atmosphere of a "solid" carburizer. Jenkins³² considers that the H_2 plays a useful rôle in reducing the CO_2 produced at the steel surface by decomposition of CO . He also finds that a $CO-H_2$ atmosphere is more carburizing than one of CO alone and points out that an atmosphere produced by passing steam over hot charcoal (at 1830°), then cooled and dried by activated alumina, containing 49 CO , $48\frac{1}{2}$ H_2 , $2\frac{1}{2}\%$ CH_4 , is an effective carburizing gas, of lower-C pressure than many commonly used gas mixtures, hence giving a lower-C content at the carburized surface and less need for a diffusion treatment.

Jenkins considers that starting gas carburization with a short *decarburizing* treatment, for example, using a $CO-H_2$ gas mixture that is not completely freed from CO_2 and which therefore reacts (water-gas reactions) at the steel surface and roughens or etches the steel as well as decarburizing somewhat, activates the surface so that, when the proper carburizing atmosphere is introduced, the steel takes up C more rapidly.

Gases for Carburizing. Given suitable equipment, a wide variety of carburizing gases may be used. Manufactured, or "city" gas, varies in composition according to the way it is made and is enriched to meet the local regulations as to British thermal units. It usually contains large amounts of hydrogen, H_2 and methane, CH_4 , with lesser, and often varying, amounts of higher hydrocarbons, unsaturated hydrocarbons, and illuminants. These more complex hydrocarbons tend to break down into CH_4 and H_2 at carburizing temperatures, but in so doing may deposit undesired soot upon the work.

Many different hydrocarbons will serve for carburizing. Methane, ethane, butane, propane, ethylene, turpentine, benzol, pine oil, mineral oil, etc., may be used. At carburizing temperatures they all tend to break down into soot, CH_4 and H_2 . Although their action may vary during the moment of breakdown, after the soot is deposited the atmosphere is primarily one of $CH_4 + H_2$. Hence they all act much alike, and give a $CH_4:H_2$ ratio high enough in CH_4 for carburizing.

Methane itself has a tendency for thermal decomposition, that is, cracking, and the deposition of soot, especially in the presence of a trace of H_2O , until this action is opposed by the presence of a high enough hydrogen content. This cracking reaction will go on in the absence of Fe. But even when equilibrium of the $CH_4:H_2$

ratio in presence of C has been established, contact of the CH_4 of that mixture with Fe produces more cracking, liberation of H_2 , and the formation of nascent C which is absorbed by the austenite just as is the nascent C from CO in the case of solid carburizing. Admission of some oxidizing gas, such as flue gas, to react with soot, is utilized to offset this. The oxidizing gas may be mixed with the carburized gas, or be admitted at intervals.

Surge Methods versus Steady Flow. McQuaid⁸ criticizes the intermittent-surge method and the method of introducing oxidizing gas along with a rich hydrocarbon to react with soot deposited from the latter. Admitting that both work in practice, he considers it more difficult to control them than to maintain a uniform turbulent flow of gas of regulated stability and dilution that will give up active C at the desired rate without strong tendency for the accumulation of soot. A more stable hydrocarbon, such as the methane of natural gas, diluted with city gas, is, therefore, preferred by McQuaid to propane or butane which are less stable and so have a stronger sooting tendency.

Gable and Rowland⁹ remark that practically all commercial installations utilize a steady flow of diluted gas rather than the intermittent-surge method.

The presence of O_2 or water vapor with a hydrocarbon gas introduces complicating factors, since O_2 will react with C, Fe, and Fe_3C , and water vapor with these and with CO_2 as well. Hence the diluent might better contain only N_2 , CO and H_2 , without free O_2 , and would preferably be chilled to a low and constant content of H_2O . If the moisture content varies, as is usually the case with city gas, it may be necessary to install equipment that will first dry the gas, irrespective of the fluctuations, and then humidify it back to just the desired extent.

In the use of a solid carburizer, to give CO, there is an excess of C present as charcoal and the operation is carried out in a closed chamber, whereas in carburizing with hydrocarbon gases, the used gas is run out and fresh gas admitted, to provide the needed C. Gas composition and rate of gas flow, in respect to area of steel surface to be carburized, therefore, are factors that may be varied.

Effect of Containers. An additional complication is that the material of the carburizing pot of the trays or baskets in which the stock is held in gas carburizing may exert a catalytic effect. Cowan¹⁰ remarks that the proximity of 35 Ni, 15% Cr trays to the work

slows down the rate of gas carburizing. If the trays are preoxidized before use, the rate of carburizing is not decreased.

Hydrocarbons Available for Gas Carburizing. Where it is available, and it is now very widely available, natural gas is a favorite carburizing gas. In any given location its composition is very constant, though different natural gases will differ, some running almost pure CH_4 , while others contain rather large amounts of higher hydrocarbons.

The higher hydrocarbons, propane and butane, are available in liquid form, being shipped in tanks or tank cars under pressure. The liquids gasify when the pressure is released. These commercial gases can be had quite pure and of quite constant composition at such prices that they can be considered as fuel gases where natural gas is not available. Hydrocarbon gases can be made on the spot by dripping mineral oil or vegetable oil (for example, pine oil) into the carburizing container, in which case it is necessary to be sure that coke from the cracking of the oil does not collect on the work, but that the oil drips directly onto a shield. Or the oil can be cracked in a separately heated unit, the coke and excess soot deposited there, and the cracked gas passed on to the carburizing unit.

Carburizing by a Combination of CO and Hydrocarbons. The rich hydrocarbon gases, natural gas, propane, especially butane and cracked oil vapor, are richer than necessary and may form troublesome soot deposits. They may be diluted by partial combustion with a deficiency of air, when the resultant gas will contain CO, CO_2 , unburnt CH_4 , H_2 , and water vapor. The water vapor may be mostly removed by chilling the gas. It is difficult to control partial combustion so that the gas produced will be sufficiently carburizing, but unburnt gas can be mixed with the partly burnt gas to enrich it.

When an unburned hydrocarbon is used that deposits too much soot, it may be diluted with flue gas containing CO_2 , or a little air may be admitted. In actual gas-carburizing practice straight hydrocarbon gases, free from CO, are seldom used, as the balance between a sufficiently active gas and one that will deposit too much soot is hard to maintain. Davis¹¹ reports that a hydrocarbon gas diluted with flue gas carburizes faster than the hydrocarbon alone, the increase being from a case depth of 0.04 in. in 5 hr without flue gas to that depth in 4 hr with it. This is doubtless due to simple mechanical obstruction by soot, preventing good access of gas to the surface.

Obviously the CO and CH₄ methods of carburization can be, and often are, combined. Oil is sometimes added to the charcoal-BaCO₃ solid carburizing mixture, to break down into CH₄ and H₂; and, conversely, when city gas, natural gas, or other hydrocarbon gas is used, some solid carburizer may be put in with the charge to supply some CO.

Thus there are many ways of producing a carburizing gas and the one chosen will depend on the cost of the gases or oils available and on the constancy of composition of those available. The effect of a given gas mixture on the particular steel being used, at the time and temperature chosen, can be so readily checked by examining the case produced that the details of control are worked out locally rather than by adhering to any general "recommended practice" set up by outsiders.

Nevertheless the tendency in gas carburizing is to use a carrier gas, plus a hydrocarbon addition sufficient to give the desired C pressure (but not to deposit appreciable soot, since soot on the work acts as a mechanical barrier), and to employ a steady, preferably turbulent, flow of gas.

As Brearley¹² put it in regard to box carburizing, "no man's word is law in an experimental craft like case hardening"; and this is equally true in gas carburizing.

The Diffusion Cycle. In order to obtain the desired surface C content, the desired gradient from case to core, and the desired depth of case, one may adjust the gas to give no higher C pressure than corresponds to the final surface C desired, and hold at temperature long enough for diffusion to give the desired depth of case. It is faster, however, to operate in two stages, first building up a surface C content higher than is finally desired, and then allowing a diffusion period in an atmosphere of the proper C pressure, lower than the initial pressure.

A steep gradient in C content tends toward a brittle case that readily spalls off; a gradual change is desired. This has to be produced by diffusion, and so sufficient time must be given for diffusion to keep pace with the build-up of C at the surface. If the surface is made higher in C than is desired by operating at high temperature, the carburizing agent must be replaced by one of lower-C pressure and a soaking period then allowed. If the atmosphere is decarburizing during diffusion or cooling, there will be a drop in surface C, the highest C layer appearing somewhat below the sur-

face. It is not too easy to avoid skin decarburization during such a soaking period, and so the access of a milder carburizing agent to the steel surface is usually continued, the original carburizing temperature being used during the second stage. In practical operation this means temperatures not far exceeding 1800°. Actually, most gas or solid carburizing is done at 1650–1750°.

Carburizing Ratios in Gas Carburizing. Harris⁷ reported on gas carburizing at 1600 to 1700° of 1020, 2515, 3115, 4320, 4620, 4820, 8620 and 8720, finding the C penetration curves for all practically identical, save that the surface C dropped from 1.24% with 1020 to 1.06% with 2515, steels of intermediate Ni content giving intermediate figures. (As Jameson¹⁴ commented, high Si also prevents a high build-up of C at the surface.)

Harris' case depths for all eight steels at 7½ hr carburizing time were close to

1700°	1650°	1600°
0.07 in.	0.06 in.	0.05 in.

Harris found that, although the surface C varied, the diffusion rate of C in austenite did not vary with composition of the steel. Assuming that the initial C gradient is approximately a straight line, that is, that an extreme surface C content (such as was found by Manning¹³ on the higher-Cr steels) is absent, Harris shows that by diffusion in an atmosphere of the proper C pressure the surface C may be lowered and the total case depth increased, the final gradient being also a fair approximation to a straight line. With these approximations Harris draws up a table and curve from which may be calculated the active carburizing time at a given temperature (to put a definite amount of C into the steel) and the subsequent diffusion time to produce the desired surface C content and depth of case. Naturally, the carburizing time and temperature must be such as to supply just enough C to suffice for the surface-C and case-depth specifications after diffusion.

For the calculation of time to be allowed in the first and second stages, the original article should be consulted. The second stage need not be at the same temperature as the first, though for convenience in processing it usually is.

The total time calculated by Harris as necessary to produce cases of given depths at different temperatures in gas of adequate C pressure are as shown in Table 15. The depth of case is here taken as the *total* depth in which C is increased.

TABLE 15

CASE DEPTHS IN INCHES FOR VARIOUS TIMES AND TEMPERATURES

Time in Hr	Temperature, °F										
	1350	1400	1450	1500	1550	1600	1650	1700	1750	1800	1850
1	0.006	0.008	0.010	0.012	0.015	0.018	0.021	0.025	0.029	0.034	0.040
2	0.009	0.011	0.014	0.017	0.021	0.025	0.030	0.035	0.041	0.048	0.056
3	0.011	0.014	0.017	0.021	0.025	0.031	0.037	0.043	0.051	0.059	0.069
4	0.013	0.016	0.020	0.024	0.029	0.035	0.042	0.050	0.059	0.069	0.079
5	0.014	0.018	0.022	0.027	0.033	0.040	0.047	0.056	0.066	0.077	0.089
6	0.015	0.019	0.024	0.030	0.036	0.043	0.052	0.061	0.072	0.084	0.097
7	0.017	0.021	0.026	0.032	0.039	0.047	0.056	0.066	0.078	0.091	0.105
8	0.018	0.022	0.028	0.034	0.041	0.050	0.060	0.071	0.083	0.097	0.112
9	0.019	0.024	0.029	0.036	0.044	0.053	0.063	0.075	0.088	0.103	0.119
10	0.020	0.025	0.031	0.038	0.046	0.056	0.067	0.079	0.093	0.108	0.126
11	0.021	0.026	0.033	0.040	0.048	0.059	0.070	0.083	0.097	0.113	0.132
12	0.022	0.027	0.034	0.042	0.051	0.061	0.073	0.087	0.102	0.119	0.138
13	0.023	0.028	0.035	0.043	0.053	0.064	0.076	0.090	0.106	0.123	0.143
14	0.023	0.029	0.037	0.045	0.055	0.066	0.079	0.094	0.110	0.128	0.149
15	0.024	0.031	0.039	0.047	0.057	0.068	0.082	0.097	0.114	0.133	0.154
16	0.025	0.032	0.039	0.048	0.059	0.071	0.084	0.100	0.117	0.137	0.159
17	0.026	0.033	0.040	0.050	0.060	0.073	0.087	0.103	0.121	0.141	0.164
18	0.027	0.033	0.042	0.051	0.062	0.075	0.090	0.106	0.125	0.145	0.169
19	0.027	0.034	0.043	0.053	0.064	0.077	0.092	0.109	0.128	0.149	0.173
20	0.028	0.035	0.044	0.054	0.066	0.079	0.094	0.112	0.131	0.153	0.178
21	0.029	0.036	0.045	0.055	0.067	0.081	0.097	0.114	0.134	0.157	0.182
22	0.029	0.037	0.046	0.056	0.069	0.083	0.099	0.117	0.138	0.161	0.186
23	0.030	0.038	0.047	0.058	0.070	0.085	0.101	0.120	0.141	0.164	0.190
24	0.031	0.039	0.048	0.059	0.072	0.086	0.103	0.122	0.144	0.168	0.195
25	0.031	0.039	0.049	0.060	0.073	0.088	0.106	0.125	0.147	0.171	0.199
26	0.032	0.040	0.050	0.061	0.075	0.090	0.108	0.127	0.150	0.175	0.203
27	0.033	0.041	0.051	0.063	0.076	0.092	0.110	0.130	0.153	0.178	0.206
28	0.033	0.042	0.052	0.064	0.078	0.094	0.112	0.132	0.155	0.181	0.210
29	0.034	0.042	0.053	0.065	0.079	0.095	0.114	0.134	0.158	0.185	0.214
30	0.034	0.043	0.054	0.066	0.080	0.097	0.116	0.137	0.161	0.188	0.217

The time for subsequent diffusion will vary according to the C content at the surface, which is controlled by the C pressure of the gas, and the amount of lowering of that surface C content it is desired to attain through diffusion. Because of these features, the table only goes part way and has to be supplemented by some such calculation as Harris describes, but it does give a good quali-

tative picture of the effects of time and temperature. A similar picture is given in Fig. 25.

Kopeci²⁸ has given a good summary of gas-carburizing principles and apparatus, with a bibliography including important recent articles. Jenkins³² also gives a comprehensive discussion.

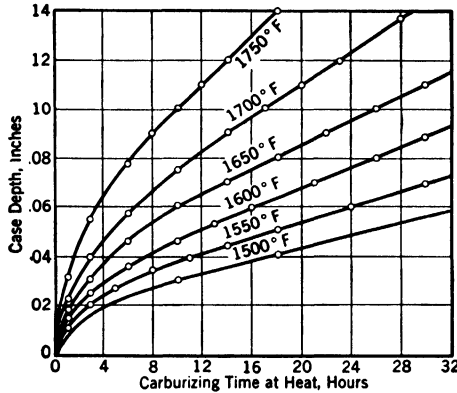

FIG. 25. Carburizing rates, using natural gas. (Schlumpf, cited by Williams¹⁹)

Solid Carburizers. Solid carburizers produce CO and CO₂, and the CO:CO₂ ratio varies with the nature of the carburizer as well as with the temperature. That is, these carburizers produce different C pressures.

High-C tool steels are sometimes heated in carburizing media in order to produce a very thin skin of higher-C content than the body of the metal, but more commonly the aim is merely to avoid decarburization. When tool steel is heated for hardening, packed in solid carburizers, the process is called “pack hardening,” whereas the solid carburizer process on usual steels is more commonly called “box carburizing,” or “pack carburizing.”

Carburizing Ratios in Solid Carburizing. Much discussion has been indulged in on the relative ease and speed of carburization of different alloy steels. Differences could exist in avidity of different elements to form carbides, at the surface or in rate of diffusion of C from the surface carbides. Manning¹³ found the following depths (to 0.60% C) after box-carburizing 10 hr at 1700°, using fine-grained Al-killed steels, and the same carburizing compound.

1022	0.048	4620	0.049
2317	0.045	4815	0.046
3120	0.046	5120	0.046
4120	0.046		

On the other hand, Jameson,¹⁴ in discussion, cited depths (to 0.50% C) for 8 hr at 1700°, as follows:

2317	0.032	4620	0.038
3120	0.040	5120	0.044
4120	0.050		

The literature of carburization is full of discrepancies, disagreements, and generalizations drawn from experiments performed under some particular set of conditions. Part of this is due to different methods of measurement of case depths, but most to the fact that two things are going on at the same time, absorption of C at the surface and diffusion of C from the surface inward. These two are both accelerated as temperature increases, but not to the same degree. Of the two, diffusion is not affected by external conditions, and is little, practically not at all, affected by chemical composition of the steel or its grain size.

Manning¹³ found that different carburizing compounds gave wide differences in depth of case. Some of the compounds produced extremely high surface-C on Cr steels, whereas they did not on C or Ni steels. Other compounds kept the surface C content to a moderate level, whatever the steel. The variation in behavior of the different steels was superimposed on the variation among carburizers, so that the general uniformity of the behavior of different alloy steels was more marked than in the gas-carburizing experiments of Harris, who was dealing with a gas of one particular C pressure. Strong carbide-forming elements in the steel, notably Cr, accelerate the decomposition of the carburizing gas or grab the C more promptly, and, hence, tend toward rapid surface pickup; non-carbide formers, such as large amounts of Ni or Si allow the active C to bounce off; that is, they slow down the surface pickup, but diffusion from a given surface C content, stays about the same, irrespective of steel composition. Other rôles of alloying elements are well discussed by McMullen in the 1937 Carburizing Symposium.¹⁵ If the C pressure of the atmosphere is not excessive and if time is given for diffusion, the C gradients and the case depth come out about the same, within wide variations in steel composition.

Types of Carbon. The mechanism by which a good solid carburizer produces the necessary CO:CO₂ ratio is somewhat in doubt. Obviously, there must be present both C and O.

It is possible to carburize in a closed container with only the use of hardwood charcoal and the air that was in the container when

it was closed.²⁷ The oxygen of the air unites with the charcoal to give the CO:CO₂ ratio obtaining at the temperature of operation. This ratio is just great enough to be carburizing to steel under 0.90-1.00% C and neutral or decarburizing to steel of higher C contents, so that the maximum C content in the surface layer is only of approximately the eutectoid composition. However, if coke is substituted for the hardwood charcoal, very little carburization results.

Charcoal, especially hardwood charcoal, gives a much more re-

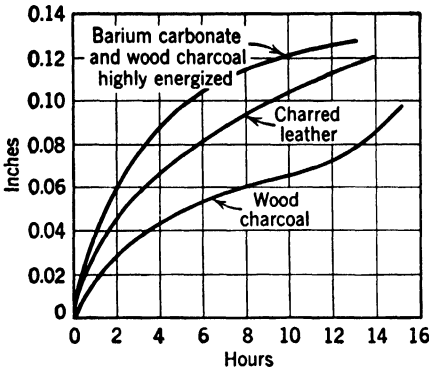

FIG. 26. Relative rate of carburization with different solid carburizers at 1650°. (Scott)

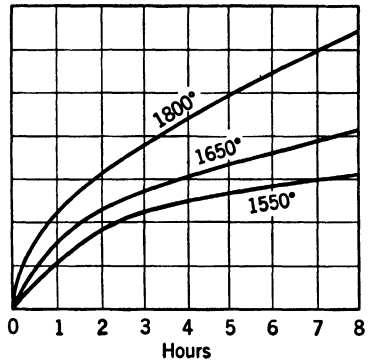

FIG. 27. Rate of carburization in ordinary solid compound. Case depth versus time and temperature.

active solid carburizer than coke. It is more energetic. Charcoal itself contains some "energizer," the usual explanation being that the ash from charcoal contains carbonates. Some authorities think that charcoal absorbs CO₂ preferentially from a CO:CO₂ mixture, but most authorities consider that the porosity of the charcoal, that is, its large surface for a given volume, is the major reason for its greater reactivity. Sugar charcoal is almost inert. Coke is considered pretty much as a diluent, though not entirely inactive, especially when the BaCO₃ content of the mixture is high. By regulating the amount of charcoal, coke, and BaCO₃, the carburizer can be given a high or a low "C pressure."

The addition of barium carbonate, BaCO₃, to wood charcoal increases its activity, as Fig. 26 shows.

Charred leather or charred bone were old-time favorite types of C, since their ash probably has energizing action and some hydrocarbons may be evolved on further heating of incompletely charred organic matter of this type. The charred-bone compounds are less

active carburizers than the energized charcoal type, Fig. 26, but retain their effectiveness in use without addition of fresh material. They do not shrink so much with use. They are especially applicable when deep cases with low C at the surface (eutectoid or only slightly hyper-eutectoid) are desired, and when long heating times are employed. They are "mild" carburizers.

Where a very rapid box carburizing, to produce a very thin but very hard surface layer, is desired, sodium or potassium ferrocyanide may be added to the carburizer in order to give a skin hardened both by C and by Ni, but this expedient is very little used, most such cases being produced by liquid-bath surface hardening.

Many solid carburizers contain Na_2CO_3 as the added energizer, but, as the Na_2O formed is more destructive to the carburizing box than BaO , the BaCO_3 is considered preferable. CaCO_3 is also used, but not usually by itself. Many authorities consider that CaCO_3 is either inert or at least a much less active energizer than BaCO_3 or Na_2CO_3 .

Varieties of Solid Carburizers. Quite a variety of carbonaceous materials may be used for carburizing. The usual solid carburizers are made up essentially of hardwood charcoal and barium carbonate (BaCO_3), the pulverized mixture being bonded with molasses or oil as binder and formed into pellets. Pellets are used to keep the BaCO_3 in close contact with the charcoal and avoid its settling out, to avoid dustiness when the charge is dumped, and to make the packing offer less resistance to the flow of heat into the charge. Modern practice in compounding carburizers is discussed by Widrig.¹⁶

Oil may be added to the solid carburizer when the box is packed, with the idea of displacing the air in the box by oil vapor before the work gets up to carburizing temperature, so that preliminary scaling may be avoided.

The action of the carbonate in the solid carburizer has been much discussed. CO_2 is needed for the carburizing reaction, and it has been postulated that a suitable rate of breakdown of certain carbonates at the operating temperature accounts for their effect. Fong and Ragatz¹⁷ show, however, that Na_2CO_3 and BaCO_3 , the more effective carbonates, merely help the reduction of CO_2 to CO . The CO_2 from the thermal decomposition of the carbonate, as well as that formed by the $2\text{CO} \rightarrow \text{CO}_2 + \text{C}$ reaction at the steel surface, is thus reduced.

Mechanism of Box Carburizing. We can picture the action as follows: two molecules of CO hit the steel surface and give up an atom of C to the steel, forming one molecule of CO_2 .

The CO_2 molecule wanders over to some nearby C and picks up one atom of C to re-form another pair of CO molecules, ready to repeat the performance. The solid carburizer does not need to touch the steel since the action is all by means of gas, but it is best to have the carburizer close to the steel in order that the gas may easily adjust itself in this way.

Energizers. The richness of the CO may be further enhanced by mixing barium or sodium carbonate with the C. These compounds, at these temperatures, slowly react with C as follows:

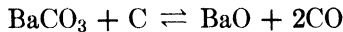

or

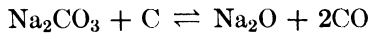

The Na_2O or BaO tends to react with the CO_2 (present from the reaction of CO with steel) as follows:

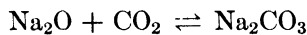
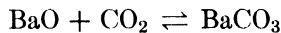

Thus the presence of these oxides tends to take up the CO_2 and so to give a gas lower in CO_2 , and thus higher in CO, than would be the case without them. These compounds are called "energizers" because they produce a more energetic carburization.

Another explanation for the effect of the energizer is the reversible formation and absorption of CO_2 according to the reactions,

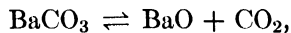
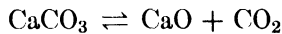

by which at low temperatures CaO or BaO absorbs CO_2 and at high temperatures gives it up. The added amount of CO_2 , reacting with C, forms more CO. This augmented supply of CO is postulated to be formed more slowly and steadily at carburizing temperatures, from BaCO_3 , and too early with CaCO_3 , thus accounting for the better performance of BaCO_3 . This is an explanation commonly given, but the explanation based on the catalytic effect of the oxide, that is, a displacement of the $\text{CO}:\text{CO}_2$ equilibrium, appears more satisfying.

That is, the energizer raises the C pressure of the gas. Solid carburizers show similar time-temperature relations to depth of case, Fig. 27, as appear in gas carburizing, Fig. 25. As Fig. 24 shows, it takes a vastly higher $\text{CO}:\text{CO}_2$ ratio to carburize at 1250° than at 1650° .

Grossmann³⁰ has shown that carburized steels packed in carburizing compound will decarburize if held at 1250°. That is, the CO:CO₂ ratio that exists at that temperature in equilibrium with C is so low that it is actually decarburizing to eutectoid and hypereutectoid compositions. The converse of this observation is the fact that, other things being equal, the higher the temperature used, the higher the C content of the case.

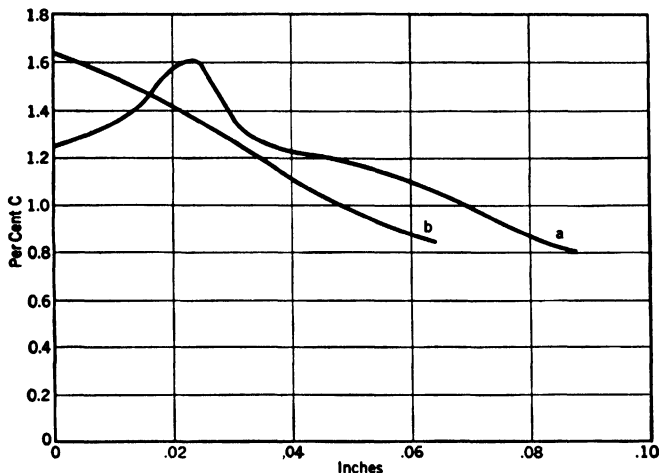

FIG. 28. Carbon gradients. Curve *a*, carburized 4 hr in ethylene at 1830°, slow-cooled in a decarburizing atmosphere. Curve *b*, carburized 4 hr in ethylene at 1830° and quenched. (Giolitti²¹)

Decarburization in Cooling. As there is no easy way of supplying a different gas to the closed container of the ordinary box-carburizing process, the gas composition that automatically results from the drop in temperature during cooling has to be accepted. Hence, if carburized parts are too slowly cooled in the box, the atmosphere becomes decarburizing and may have time enough to decarburize, and even to oxidize.³⁴ Hence, it is not uncommon for box-cooled parts to show a relatively soft skin. An exaggerated case of this is shown in Fig. 28.

When the diffusion and the cooling stages are carried out in an atmosphere of proper C pressure, the C gradient may be flattened without loss of surface C, as Fig. 29 indicates.

Control of the Gradient. Cookbook recipes for getting a good gradation between core and case are of little avail. If the depth of case needed and its proper structure and surface hardness, and the desired structure and properties of the core are known, the carburiz-

ing conditions and the heat treatment are juggled to fit the particular lot of steel used. Pilot pieces are put through along with the work, file-tested, and broken to show the nature of the case and the core and the adhesion between them.

Distribution of Carbon Within the Case. The surface needs a certain level of hardness and wear resistance, but the need for these properties is accompanied by an equal need for adherence of the case.

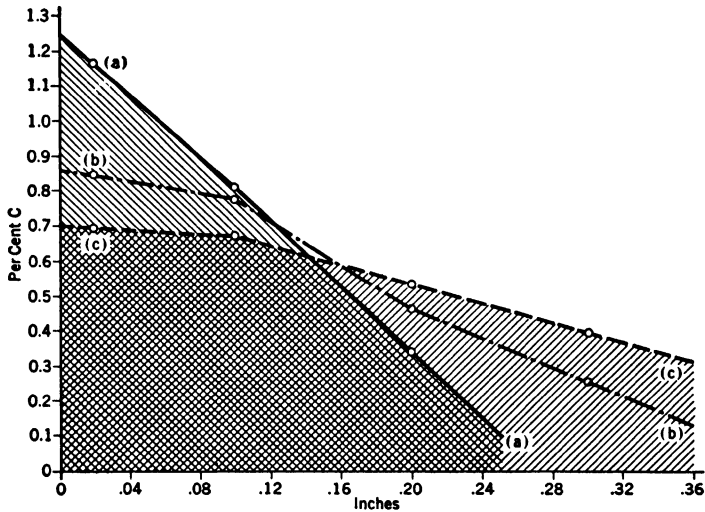

FIG. 29. Diffusion. (a) Carbon gradient after 10 hr in solid carburizer at 2010°. (b) Same, then held 5 hr at 2010° in CO. (c) Same as b but held 5 hr more at 2010° in CO. (Giolitti ²¹)

If the surface is too brittle, or is underlaid by a brittle layer, the case may spall off. Hypereutectoid steel is more brittle than eutectoid steel, and it is especially brittle when the cementite is in a network or in spines. On slow cooling of high-C austenite there is a strong tendency for separation of the excess carbides in these embrittling forms. On the other hand, if the carbide is distributed in something approaching a spheroidized form, the hypereutectoid carbide does not cause embrittlement, and adds to wear resistance. Unless there is opportunity for diffusion there may be a sharp line of demarcation between the case and the core; the case may be just a shell that can readily be peeled off. Such a condition is of course not met if the case is not hypereutectoid; and it would suffice to make a tough adherent case, to limit its exterior C content to the eutectoid composi-

tion, which can be done by using mild carburizers at low temperatures, and is done when case toughness is more important than its wear resistance. But the actual problem is more commonly to produce a case of 1.10–1.20% C at the outside, for wear resistance. The A_{cm} temperature for 1.10% C is at about 1600°, for 1.20% at about 1675°. If the C concentration rises above the A_{cm} percentage for a given carburizing temperature, or if with a C content close to that of

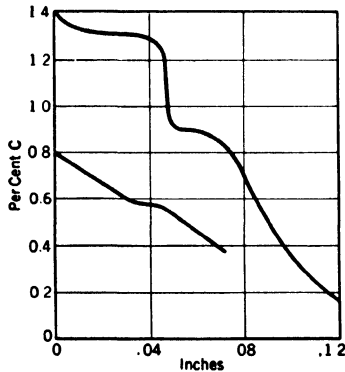

FIG. 30. Carbon gradients. Upper curve, carburized 4 hr at 1920° with ethylene. Lower curve, carburized 4 hr at 1830° with 97% CO, 3% ethylene. (Giolitti²¹)

A_{cm} at that temperature the temperature is allowed to drop, carbide will be thrown out. When the temperature is raised, it will not very readily be dissolved again.

The Carbon Gradient. Great stress is laid on avoiding sharp line of demarcation between case and core; that is, the C-content–depth–gradient curve should not be steep. This means that a deeper case is needed when the surface C is high. Such a curve as the upper one in Fig. 29 is to be avoided, for the sharp drop in C content at about the eutectoid composition makes such a case liable to peeling or chipping on that line, a phenomenon sometimes

called “exfoliation.” The gradient in the lower curve of Fig. 30 is obtained with a milder carburizer and at a lower temperature.

Measurement of Case Depth. Difficulties in comparing data as to depth of carburizing result from various investigators using different methods of measurement. The American Society for Metals²⁰ suggests that the total case be measured by fracturing or sectioning a quenched piece, etching in dilute nitric acid, or heat-tinting on a hot plate. The high-C rim will etch or blue on heating, before the low-C core. With the line of demarcation thus made more clear, depth may be measured under a low-power microscope.

The *effective case* can be determined by taper grinding and determining the hardness by Rockwell cone or Vickers diamond. Fifty-eight Rockwell C or 650 Vickers would usually be considered full hardening, though 60 Rockwell C or 700 Vickers might be required. The exact method of depth measurement used should always be stated.

Reuse of Spent Carburizer. Spent carburizer may be allowed to stand in the air for some time, say overnight, in order to be "regenerated" before reuse. The usual explanation is that the BaO must be allowed to take up CO_2 from the air and regenerate BaCO_3 . This explanation is not satisfying, for fresh carburizer made up with BaO works just as well as that made with BaCO_3 . Charcoal readily adsorbs air upon its surface and gives it off slowly on heating, so that an equally good explanation would depend on the replacement of the adsorbed air that had been driven off in use.

Obviously, there must be enough O_2 in the pot at carburizing temperature to make CO and CO_2 . If the new carburizer added contains oil or molasses as a binder, the cracking of these organic materials will tend to drive the air initially present in the box out through the clay luting, so that O_2 in some form that will not be displaced from the box before the carburizing temperature is reached must be supplied. When the carburizer is made up from charcoal and BaO, the O_2 that forms CO and CO_2 must largely be that adsorbed upon the charcoal. If the O_2 supplied had to come from the decomposition of carbonates, there would be more relation between the action of the various carbonates and their decomposition temperatures than there is. The actual relation appears to relate far more closely to the catalytic action of the Na_2O , BaO, etc.

If other means were taken to ensure the presence of the necessary small amount of oxygen, it should be possible to reuse "spent" carburizer without a period of storage.

Amount of Energizer. The amount of energizer added to the pellets varies from 5 to 20%. Excess energizer over perhaps 2 or 3% does not make for appreciably higher C content of the case, or for more rapid carburizing, but, since, with use, the energizer may sinter down with the ash of the C and become less effective, an excess is added at the start so that the carburizer may be reused. A mixture of some proportion of used and some of new carburizer is used in practice, the proportions varying with conditions and being usually established on a cut-and-try basis. According to Davis²² the only new carburizer added in modern practice is that required to make up losses from dusting and burning.

It has even been suggested that, when a low-C surface layer is desired, and when working at high operating temperatures to allow rapid diffusion, an "anticatalyzer" be added. Mahin and Spencer²³ claim that a small amount of ferrosilicon has such an anticatalytic effect.

Lower Carbon Cases. Rosenthal and Manning²⁴ obtained erratic results in trials of ferrosilicon, and class it as a mere diluent in a solid carburizer. When a commercial solid carburizer and a NiMo steel of 0.20 C, 0.21 Si, 0.33 Mn, 3.34 Ni, 0.20 Cr, 0.32% Mo were used, carburizing at 1700° for 24 hr, with no addition to the carburizer, the surface C was 0.95%. Adding 14% of ferrosilicon, FeSi, (50% Si grade) reduced this only to 0.90%, this effect being duplicated by like additions of silica flour, SiO₂; silicon carbide, SiC; or magnesia, MgO; which would be expected to be inert at 1700°, and produced cases of 0.85–0.95% maximum C. But when small amounts of some chlorides were added to the mixture containing FeSi or SiC, a decided inhibition was found. Sodium chloride was ineffective, but 4% NiCl₂ or CrCl₃, or 2% of each, with 15% 600-mesh SiC, or 200-mesh FeSi, dropped the surface C to 0.55–0.65%. This approximately 0.60% C at the surface was not affected by time. The diffusion and depth of case of course varied as time increased, but the surface C was within a few points for a period between 4 and 48 hr. With 20% FeSi, 2% each of NiCl₂ and CrCl₃, the figure was lowered to 0.45%. Surface C contents between 0.45% and the 0.95% for the carburizer with no additions were secured at will by increasing the mesh size of the SiC or FeSi, or by decreasing the amount of NiCl₂ or CrCl₃. These chlorides alone, in the absence of Si-bearing materials, acted as energizers, raising the surface C to 1.10%.

The theory back of these experiments presupposed that SiCl₄ would be formed and that this volatile compound would form an inhibiting film of Si on the work. However, no evidence was found of the correctness of that theory. The action seems to be in the nature of control of the C pressure of the gas. Ihrig²⁹ produces an Si case on steel by using what amounts to gas-carburizing equipment, heated to 1825–1850°, charged with steel, SiC, and provided with a stream of Cl₂. In the absence of CO and at the higher temperature, the steel is successfully siliconized.

Prevention of Carburization. Since the carburized case is un-machinable after hardening, any parts to be machined or drilled after carburizing must be kept soft and uncarburized, unless the work is cooled from the pot and the machining done before hardening. This is not possible in single-quench work. When the area to be left soft is large it is possible to pack a pot with inert material at the places to be left soft and active carburizer at those to be hardened, but it is difficult to keep the carburizing gas away from the places covered with

inert material. Holes or other places where such coatings will remain in place can be packed with a fire-clay water-glass cement.

Isolated spots to be kept soft are best protected by Cu-plating them. The parts to be hardened are "stopped off" with an insulating coat, like baking Japan, or a lacquer that will not strip during plating; the places to be coated are cleaned as meticulously as though it were a regular plating job and those places plated with Cu from a cyanide bath. Or the whole piece can be plated prior to finish-machining and the Cu machined off the portions to be hardened. If the Cu plate is sufficiently thick, pore-free, and adherent, it will protect the surface that it covers from carburization.

Boxes and Their Packing. It is necessary that the access of carburizing gas to all sides of the work be uniform. Work will carburize even if not submerged in the carburizer; but the CO:CO₂ equilibrium will not be so readily established at a distance from the charcoal, and the carburizing action will not be so uniform. Hence the boxes are packed so that, as the carburizer shrinks and settles, it will still envelop the charge. Tightly fitted covers, well luted on with clay, are used to avoid waste of carburizer by combustion with air or flue gas. Boxes and carburizer are dead weight to be heated up, and so the greater the amount of work to the weight of carburizer and box the better. Heavy cast boxes are being replaced by thinner boxes, often ribbed for stability, made of heat-resisting alloys to prevent scaling of the outside of the box.

Size of Carburizing Box. The inside of even a small box takes quite a while to come up to the temperature of the furnace; and, if a large box is used, the material in the center lags behind the indicated furnace temperature several hours, that is, several hundred degrees. The greater the size of the box, the larger will be this error, and the greater the actual difference in the thickness of case taken on by steel near the sides of the box as compared with that near the center of the box. No manipulation of the furnace can change this effect; it can be remedied only by altering the dimensions of the box itself.

The box should not be larger than is absolutely necessary, even where large quantities are to be carburized in it. It should be narrow in at least one dimension so that the heat may have a chance to penetrate quickly, at least from two sides, and reach all the contents at about the same time. Further, the boxes should not be made too deep in proportion to their other dimensions, as this makes packing the parts into them more difficult. The design of the box may, in special

cases, follow the outline of the piece to be carburized, about $\frac{1}{2}$ in. all around being allowed for clearance and packing, so that the surfaces may be heated uniformly and carburized alike. Several such containers may be mounted on a stand, the whole being handled as a unit. Roush and Dames²⁵ have given a good discussion of containers.

If the work is to be cooled in the box, it is important that the box is not so large that the work cools too slowly, for slow cooling makes the hypereutectoid C tend to assume the network form; rapid cooling avoids it. Hence the closer box cooling approaches to normalizing, the better, though a balance has to be struck when the work has to be machined after carburizing, and the case therefore is required in the annealed condition. Thin-walled boxes and the minimum of space for compound favor both rapid cooling and full efficiency.

Packing the Boxes. The method of packing should be such as will ensure as nearly as possible an even heating and a uniform carburizing of all pieces in the same box. The method of packing necessarily must vary with the type of article to be handled. For example, long slender pieces should be packed vertically, so that they will be held in position by the carburizing material and cannot sag under the influence of the high temperatures. Again, gears and similar pieces may be most suitably packed in tubes, so that the same amount of carburizing material and the same degree and length of heating may influence all parts of the periphery in equal proportion. Should a narrow or low box not be available in connection with small work, carburizing compound that has been used before may be put next to the sides of the box while new compound is placed in the center. In this way the difference in carburizing which might result from the different temperatures in various parts of the box may be offset.

The first step in the general operation of packing is to cover the bottom of the box with the compound to a depth of $1\frac{1}{2}$ to 2 in., tamping it solidly into place. The parts to be carburized are then placed firmly upon this bed so that the compound and work are in close contact with each other. The pieces should in no case touch the sides of the box, but should be placed about $\frac{1}{2}$ to 1 in. away from it. The articles should be separated from each other by about $\frac{1}{2}$ in. If the articles should touch one another at any point, soft spots would result. Nonuniformity of case may also result if there is not sufficient carburizing material in the box.

After the first layer of work has been placed in the box, it is entirely covered with the carburizing compound. This should be packed

and tamped down around and over the pieces so as to have the particles of compound in close contact with the steel, but yet not so tightly as to prevent the free circulation of the carburizing gases which are generated during the heating process. When the first layer has thus been suitably packed and covered, the same procedure is repeated until the box is nearly filled. The layers may be separated by cardboard. The point to be kept in mind is that each and every piece should be surrounded on all sides by a suitable amount of the carburizing compound.

At least 2 in. of the compound should form the top blanket over the last layer of work. Some shops adopt the following practice, with the aim of further preventing the escape of the gases: about 2 in. from the top of the box, sheet strips about $\frac{1}{16}$ in. thick are laid over the last layer of the carburizing material, and these, in turn, are covered with about 1 in. of powdered charcoal. When the box is finally packed, the cover is placed on the box, and the edges are carefully sealed with fire-clay or asbestos cement. The box is now ready for the heating operating.

The Heating. The two important points are: the heating, at least up to 1300° should be gradual; the heating beyond this temperature should be uniform over all parts of the carburizing box. An energetic liberation of gases commences very strongly at temperatures somewhat under 1300° for the majority of solid carburizing compounds, and it is advisable to diminish this as much as possible in order to obtain a more gradual carburization. Furthermore, it gives more opportunity for the steel to heat uniformly and avoid warping. The second point is self-evident: nonuniformity of heating must necessarily result in nonuniformity of product. The boxes can be heated in batch furnaces, or in continuous conveyor-type furnaces, sometimes made on the counter-current principle with two rows of boxes moving in opposite directions so that the emerging hot boxes give up some of their heat to incoming cold boxes, when the work is to be cooled in the box. If it is to be quenched from the box, the counter-current principle is not employed.

The temperature can be dropped toward the end of the run in batch carburizing, or a lower temperature zone can be provided in a continuous furnace, to allow a period of diffusion without continued pickup of C at the surface.

Furnaces for Solid Plus Gas Carburizing. In gas carburizing it is essential that the gas composition meeting the work shall be uniform.

If gas is passed in at one end of a charge, it will be somewhat depleted of its carburizing constituents by the first work it reaches, and so care is taken to produce turbulence of the gas and to avoid channeling in a packed charge of small parts whereby the gas would seek the open channels and avoid the more tightly packed portions.

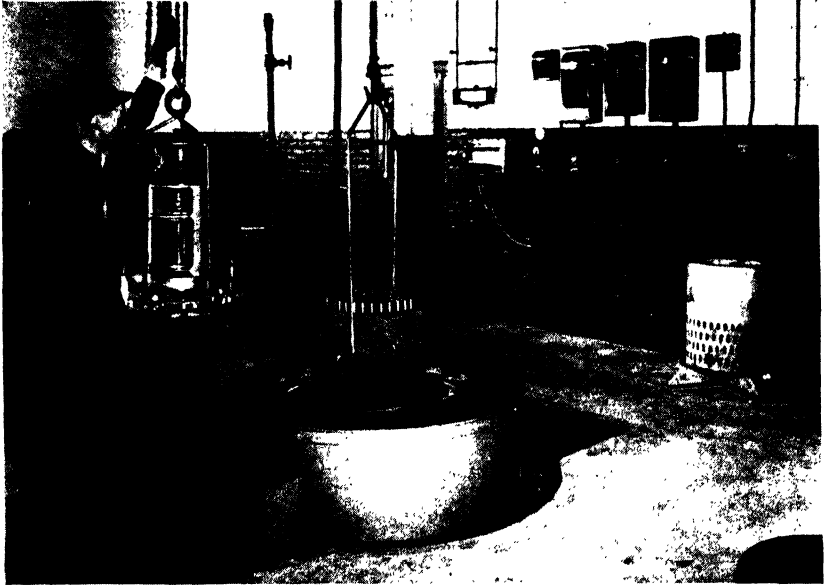

FIG. 31. The stock to be carburized is charged into a perforated pot so that the gas may be circulated. (Courtesy Hevi Duty Electric Co.)

Hence the charge may be tumbled in a slowly rotating drum when the work will stand agitation without damage, the gas may be led in at a number of places, or the gas may be circulated by a fan. In the rotating-drum type of furnace, some solid carburizer may be added, as well as a hydrocarbon gas.

In any case, the charge and carburizing gas must be held in a muffle-like shell or container to protect against air or flue gases. The container can be externally heated, usually either by gas or electricity.

When the work will not stand tumbling, the gas-carburizing furnace has an outer shell within which is a combustion space (or electric-heating elements), the container, and within the container a basket into which the work is loaded, and either a number of inlet pipes and an outlet for the carburizing gas, or one inlet with a fan either above

or below the basket to circulate the gas. Container, basket, and fan are all of heat-resisting alloys. Figures 31 and 32 show an electric carburizing furnace. Figures 33 and 34 show batch and continuous gas-fired, gas-carburizing furnaces.

McQuaid²⁶ cites an electric carburizing furnace which has the resistors inside the retort, radiating directly to the work. Straight



FIG. 32. Muffle being drawn from the heating pit. The carburizing gas is forced over the work by the fan in the top of the muffle. See Fig. 31 for the method of charging.

natural gas is led in and allowed to crack for 3 min; then the gas supply is cut off for a 27-min diffusion period, and the process is repeated. By this technique, short circuiting of the resistors by too thick a coating of soot is avoided. The thermal efficiency of a furnace of this type would be high. The resistors would have to be of material that does not itself carburize readily and deteriorate.

Whatever process is chosen for carburizing, the carburized product requires heat treatment.

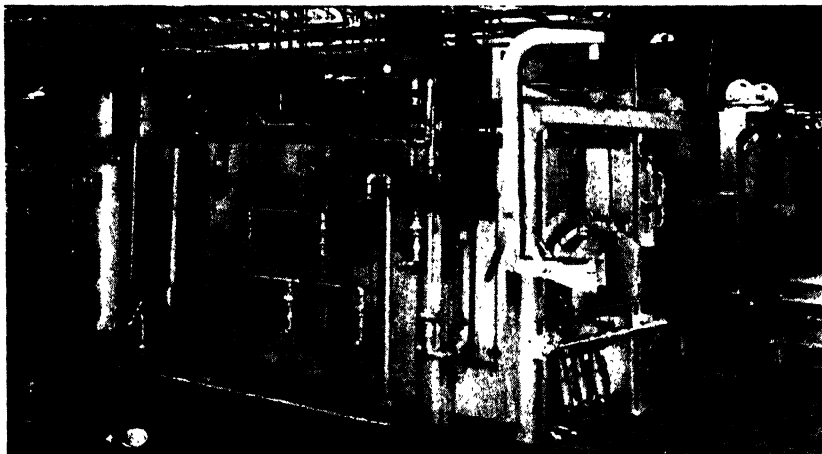

FIG. 33. Batch type gas-fired gas-carburizing furnace at Packard Motor Car Company. The gas flames heat a muffle. The work is loaded on trays. The trays are pushed through the furnace, progressively passing through three different temperature zones. Gas locks are used to prevent loss of carburizing gas. The carburizing gas is prepared in the equipment at the left. (Courtesy Surface Combustion Co.)



FIG. 34. Continuous gas-fired gas-carburizing furnace at Reed Roller Bit Company. (Courtesy Surface Combustion Co.)

BIBLIOGRAPHY

1. O. E. CULLEN, Skin recovery for decarburized steel surfaces, *Metals & Alloys*, V. 20, October 1944, pp. 955-8.
2. M. L. BECKER, Carburizing and graphitizing reactions between iron-carbon alloys and CO and CO₂, *J. Iron Steel Inst.*, V. 121, 1930, pp. 337-61.
3. J. A. WEBBER, Furnace atmospheres and decarburization, *Carburizing Symposium*, American Society for Metals, October 18-22, 1937, pp. 89-114.
4. W. P. SYKES, Carburizing iron by mixture of hydrogen and methane, *Trans. ASST*, V. 12, 1927, pp. 737-58.
5. C. H. McCLOSKEY and J. H. LOUX, Theory of the mechanics of carburization, *Steel Processing*, V. 32, January 1946, pp. 53-5.
6. J. R. GIER, Protective atmospheres for hardening steel, *Ind. Eng. Chem.*, V. 33, 1941, pp. 38-41.
7. F. E. HARRIS, Case depth, *Metal Progress*, V. 44, August 1943, pp. 265-72.
8. H. W. McQUAID, Gas carburizing. A discussion of shop practice, *Metal Progress*, V. 26, July 1934, pp. 22-7.
9. L. D. GABLE and E. S. ROWLAND, Commercial gas carburizing, *Carburizing Symposium*, October 18-22, 1937, American Society for Metals, pp. 280-316.
10. R. J. COWAN, Notes on continuous gas carburizing, *Trans. ASM*, V. 25, 1937, pp. 843-62.
11. E. F. DAVIS, Various methods of carburizing, *Ind. Heating*, V. 1, 1934, October, pp. 31-4, November, pp. 15-18.
12. H. BREARLEY, *The Case Hardening of Steel*, Longmans, Green, London, 1921, 2d ed., 207 pp.
13. G. K. MANNING, Carburizing characteristics of 0.20% carbon alloy and plain carbon steels, *Trans. ASM*, V. 31, 1943, pp. 8-32.
14. A. S. JAMESON, discussion, *Ibid.*, pp. 33-5.
15. *Carburizing Symposium*, American Society for Metals, 1938, 339 pp. See also *Trans. ASM*, V. 26, 1938.
16. S. L. WIDRIG, The physical and chemical characteristics of carburizing compounds and their handling in production, *Carburizing Symposium*, American Society for Metals, 1938, pp. 261-80.
17. T. C. FONG and R. A. RAGATZ, The action of carbonate catalysts in the carburization of steel, *Trans. ASM*, V. 32, 1944, pp. 162-81.
18. N. R. STANSEL, *Industrial Electric Heating*, John Wiley & Sons, 1933, 444 pp.
19. G. T. WILLIAMS, Gaseous media for carburizing, *Trans. ASM*, V. 26, 1938, pp. 463-83.
20. M. A. GROSSMANN, in reference 15.
21. F. GIOLITTI, *The Cementation of Iron and Steel*, McGraw-Hill, 1915, 407 pp.
22. E. F. DAVIS, Production carburizing revolutionized in 30 years, *Metal Progress*, V. 32, October 1937, pp. 347-50, 366.
23. E. G. MAHIN and R. C. SPENCER, Depth and character of case induced by mixtures of ferro-alloys with carburizing compounds, *Trans. ASST*, V. 15, 1929, pp. 117-44.
24. P. C. ROSENTHAL and G. K. MANNING, Carburized cases of hypoeutectoid carbon content, *Trans. ASM*, V. 39, 1947, pp. 801-15.

25. H. W. ROUSH and A. C. DAMES, A study of commercial carburizing containers, *Carburizing Symposium*, American Society for Metals, 1938, pp. 220-60.
26. H. W. McQUAID, discussion, *Ibid.*, pp. 314-16.
27. M. SUTTON and R. A. RAGATZ, Factors affecting the activity of carburizing compounds, *Trans. ASM*, V. 29, 1941, pp. 169-201.
28. E. S. KOPECKI, Gas carburizing, *Iron Age*, V. 156, 1945, October 18, pp. 50-3; October 25, pp. 56-8; November 1, pp. 60-3.
29. H. K. IHRIG, Silicon-impregnated steel, *Steel*, V. 157, April 1, 1946, pp. 73-8.
30. M. A. GROSSMANN, Oxygen in steel, *Trans. ASM*, V. 18, 1930, pp. 601-31.
31. J. J. TURIN, discussion, *Carburizing Symposium*, American Society for Metals, 1938, pp. 9-13.
32. I. JENKINS, Gas carburizing, advance copy, Iron & Steel Institute, June 1946, 21 pp. Also, *Controlled Atmospheres for the Heat Treatment of Metals*, Chapman & Hall, London, 1946, 532 pp.
33. H. SCHENCK, *Physikalische Chemie der Eisenhüttenprozesse*, V. 1, Berlin, 1932.
34. A. HULTGREN and E. HAGGLUND, Carbide and oxide in surface zones of carburized alloy steels, *Trans. ASM*, V. 39, 1947, pp. 820-37.

CHAPTER 5

HEAT TREATMENT OF CARBURIZED STEEL

Types of Steels Used. Several considerations dictate the C content of the steel used for carburizing. The rate of diffusion is greater the greater the difference in C content between outside and inside. For core toughness, also, the ductility of low-C steels has been sought. Hence the bulk of the steels used runs from about 0.10 to 0.20% C. When machining properties prior to carburizing are important, the higher end of the range is used.

However, if it is essential to give the case better support than the soft steels will give, higher C, around 0.35%, may be used to allow the core to be strengthened and hardened by heat treatment.

Alloys may be used in the steels to hasten the rate of C pickup at the surface, accomplished by the addition of carbide-forming elements, especially Cr or Mn, or to alter the response to heat treatment of case or core or both. Nearly all the alloying elements are usable for one purpose or the other, save Si in large amounts. Silicon is a graphitizer and decreases the rate of absorption of C, and the stability of the carbide. Some of the steels used are listed on p. 102, and their selection is discussed in Vol. III.

Treatment Prior to Carburizing. The only finishing operation possible after carburizing and hardening is grinding or lapping, the surfaces being too hard to machine, so the pieces are machined to size before carburizing. If much stock is to be removed in finish grinding a correspondingly thick case must be produced. Ordinary grinding allowances are of the order of 0.01 in. for heavily carburized stock and where warpage has not been avoided. On small pieces, with careful control of all conditions, the allowance for grinding may be as low as 0.002 in.

The preliminary machining of soft steel requires that it be of proper structure and grain size to machine quickly and cheaply, with the proper surface finish. The very low-C steels that might be chosen from the point of view of core toughness are likely to tear on machining, so the C content chosen is often a compromise.

Grain Size and Abnormality in Carburizing. Coarse-grained steels seem to carburize slightly more rapidly, that is, to give greater case depth after a given carburizing time, than fine-grained ones. This does not stem from differences in respect to C pickup, but rather from their different responses to quenching.

The coarse-grained steels are more readily hardenable, that is, they require less drastic quenching to harden, whereas a fine-grained case may be just on the border line of hardenability and prone to show soft spots. The fine-grained "abnormal" steels were once avoided for this reason. At present, fine-grained steels are ordinarily specified for carburizing, a suitable hardenability being secured by adding a little of one or more depth-hardening elements, Cr, Mo, Mn, or Ni.

Abnormality in carburizing is a combination matter, relating to the steel and the carburizing process. It is related to the presence of O. Presence of a slight amount of metallic Al in the steel and of CO and CO₂ in the carburizing medium both together produce abnormality.

The Introduction of Oxygen. Obviously, if in carburizing with CO:CO₂ gas, the CO₂ molecule meets Fe before it meets C, the reversible reaction,

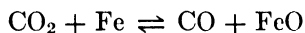

comes into play. In the body of the gas, CO is in great excess. The reaction can only momentarily go to the right, for diffusion of CO from the body of the gas will force the reaction to the left, that is, the FeO that has been momentarily formed will be reduced. In the interim between formation and reduction of FeO, the FeO may diffuse into the steel. As Grossmann¹ has shown, there may be a slight pickup of O₂ in box carburizing. This slight influx of O₂ is thought to account for the "abnormality" of the case in carburized steels containing traces of Al, the incoming O reacts with the Al to form Al₂O₃, and the presence of very finely divided Al₂O₃ particles interferes with the diffusion of C to the grain boundaries. The explanation is consistent with the fact that steels that are abnormal when box-carburized are normal when gas-carburized with a hydrocarbon gas free from oxygen-containing gas (compare Fig. 60, Vol. I). Derge, Kommel, and Mehl² show that Al₂O₃ particles present in the steel before carburization do not produce abnormality, nor does the presence of Al in solid solution (in the absence of O in the carburizer). The O₂ is introduced in pack carburizing. Bain³ has shown that very pure Fe, oxygen-free, and carburized in absence of O₂, is normal, whereas high-

purity Fe contaminated by O_2 may show abnormality even when carburized in oxygen-free hydrocarbons, so the presence of Al is not essential to abnormality. However, commercial steels used for carburizing contain so little O_2 in solid solution that they are ordinarily normal if carburized without addition of more O_2 .

Separation of Cementite. Many carburized parts are so carburized that the surface C content is about 1.15% or about 0.30% above the eutectoid. This corresponds to about 5% excess cementite. At 1650° or above, this amount of C can exist, dissolved in austenite without the separation of the excess cementite. If the case is quenched from that temperature the excess cementite will tend to separate into small particles rather than to collect into an enveloping network, but on very slow cooling, as when box-carburized steel is allowed to cool in the box, it will so collect. Ordinary carburizing steels slow-cooled after carburizing will show an outline of hypereutectoid cementite about the coarse austenite grains existing at the carburizing temperature, and this network size reflects also the size of the grains of the low-C core. Since production of this network is, or was at the time the name was applied, the normal behavior, steels that show it are called "normal."

If the austenite does not coarsen at the carburizing temperature, the carbide network (in most steels of high coarsening temperature) does not completely surround the small grains and the carbide remains in coalesced patches. Steel showing this behavior is termed "abnormal." The phrase does not now connote inferiority, since for most purposes the fine-grained abnormal (for example, Al-treated) steels are desired. When the phenomenon was first noted a certain degree of inferiority was implied because the fine-grained steels that were abnormal, having lower hardenability because of the fine grain, were more susceptible to soft spots when a gas bubble happened to cling to the surface during quenching. Introduction of elements that confer depth hardening, that is, do not require such high quenching rates to harden, or the use of more drastic quenches or better technique in quenching, have minimized trouble from this source.

It is now recognized that fine grain and coalescence of cementite are not necessarily companions, for fine-grained "normal" steels, in which the excess cementite does not coalesce but outlines the fine grains, are available. Such alloying elements as V or Ti are probably required to produce steels of this type.

Effect of Grain Size on Type of Heat Treatment. The response of the steel to the tendency toward grain growth is considered of para-

mount importance in the selection of the carburizing temperature and the heat treatment of the carburized steel. Specifications for carburizing steel no longer state merely the chemical composition; they include also the grain size according to the McQuaid-Ehn test. This test, if made at the carburizing temperature that will actually be used, is logical for the selection of carburizing steels, since it shows whether the steel will or will not coarsen in the carburizing operation, and, if it does, indicates the necessity for heat treatment to correct the coarsening.

If we use steel that does not coarsen at the carburizing temperature employed (even the fine-grained steels can be coarsened at very high temperatures), the core will be relatively tough on quenching direct from the carburizing temperature, not so much so as when it is given another quench from a lower temperature, but sufficiently tough for many purposes. (In such discussion of toughness it is to be remembered that toughness of the core plus case, not that of the core only, is the vital matter.)

The main reason usually advanced for sticking to fine-grained steels is their superior toughness, both in case and core, but other factors come in also. With a coarse-grained steel it is ordinarily necessary to employ four heating operations: one to carburize (during which grain coarsening occurs), followed by slow cooling; another above both A_{c3} and A_{cm} to refine the grain of the core and take excess carbide into solution, followed by quenching; third above A_{c1} to refine the high-C case, followed by another quench; and a final low-temperature draw to relieve quenching stresses.

With fine-grained steels one quench usually suffices and, with suitable steels, this may be carried out from the carburizing temperature. The fewer the heatings and coolings, the less the warpage.

When rapid carburization is desired and a high carburizing temperature is employed, the use of a steel whose grain coarsens badly at the necessary temperature may involve so much embrittlement, and so much warpage in the complicated heat treatment necessary to repair the embrittlement, that for measures of economy as well as quality the fine-grained steels are much superior.

The saving in time and expense when quenching may be done direct from the carburizing temperature is so great that, if, with the single quench, the case is not too brittle and the core sufficiently tough, this method will always be chosen. Hence fine-grained steels with the addition of ferrite-toughening and depth-hardening elements, balanced to permit the single quench, are deservedly popular. Fine-grained

Ni-Mo steel (4615) finds much favor for the single quench, and Cr-Mo (4120) of suitably fine grain is being similarly utilized. Chromium-Vanadium, for example, 6115, also has a good combination of hard carbides and fine grain on a single quench. Wyzalek ⁴ prefers the single quench for fine-grained Ni-Cr SAE 3115 steel. The lower carburizing temperatures are preferable when a single quench is to be used. N.E. 8620 is coming into wide use.

Machinability. The fine-grained steels that give the best core toughness rough-machine less readily than coarse-grained steels. Hence there is a demand for steels that will be fine-grained at the carburizing temperature but whose coarsening tendency is great enough to allow coarsening for machinability.

The stock is then normalized from a very high temperature so that the steel does coarsen and is suitable for rapid machining. Many fine-grained steels will coarsen at 1800°, but some require still higher temperatures.

In order that the stock will not warp from internal stress after machining, upon being heated to the carburizing temperature, as well as to ensure that its propensity toward grain growth is the same in all parts, stock not already in stress-free condition may have to be normalized or quenched and tempered prior to carburizing. Such treatments also make the stock have the same sort of machinability from piece to piece, whereas hot-worked bars or forgings finished at different temperatures, may not have.

Unless it is desired to coarsen the grain intentionally for machinability the treatment for uniformity will be a normalizing from the usual temperature for the particular steel being used, or a quench from the usual temperature followed by a high draw, say at 1100° for C steels, and somewhat higher or lower for some of the alloy carburizing steels.

McQuaid ⁵ points out that the carburizing steels with an air-hardening tendency, especially those of high Ni, accompanied by Mo or Mn, may be difficultly machinable if air-cooled for machining prior to carburizing. In such cases rapid cooling to 1200°, with slow cooling to 500°, or a reheat to 1200° and slow cooling to draw some of the hardness conferred by air cooling may be required. The ordinary C and low-alloy carburizing steels are, however, suited to the usual normalizing practice.

Carburizing for Endurance. Any rotating shaft carburized or similarly strengthened on its surface will show increased endurance under repeated stress applied to the rotating beam, because the stress is at a

maximum at the surface and is resisted by the stronger surface. In axial loading where the whole cross section is more nearly equally stressed, this improvement of endurance limit is nowhere nearly so marked.

In roller bearings, where the maximum compressive stress comes not at, but just below, the surface, fatigue failures may start within the core or at the junction of case and core of a carburized race or roller. Carburizing of antifriction bearings is, therefore, a special case in which depth of case and gradation of case to core, as well as the surface hardness and wear resistance, are of increased importance. In order to produce a harder type of carbide in the case, these steels normally contain Cr and sometimes also Mo, V, or higher Mn than usual, since all these are carbide formers.

Location of Transition Zone. Carburizing may be used primarily for wear resistance, or primarily for its surface-strengthening effect against fatigue. When wear alone is concerned, as long as the transition zone is gradual enough to avoid spalling, its width and location are not very material. In the case of fatigue, the location is material. The transition zone is weaker than the surface, both in static properties and in fatigue.

There is a stress gradient from surface to center of the piece in service. In rotary bending, as in a shaft, stress at the center, or, more accurately, at the neutral axis, is zero. The stress gradient is therefore steep, that is, there is relatively high stress for some distance below the surface. The endurance limit of the graded structure at each point on the way from the strong surface to the weak core must be greater than the local stress at each point; else subcutaneous failure will occur under repeated loadings. Hence, the case thickness and the width and location of the transition zone must be such as to give a "strength gradient" that lies wholly above the stress gradient.

In the event that the part is designed for ostensible axial loading, uniform over the cross section, carburizing would, offhand, appear to have little value because the weak interior would be so vulnerable that the strong case would not help much. Actually this is not quite true, because there is no such thing as truly uniform axial loading; some location on the surface always is subjected to the maximum stress, and so strengthening of the surface is beneficial. Under such conditions the stress gradient is not steep, but quite flat; the stress remains relatively high even to the center. Obviously, such a condition of service calls for a hard strong core rather than the soft "tough" core provided by low-C carburizing steels.

In considering the location of the transition zone, it is to be remembered that warpage, remedied by subsequent grinding, may leave the transition zone very close to the surface in some spots.

Core Toughness. Core toughness, determined on a "pseudocarburized" piece, put through the carburizing cycle but without presence of carburizer, then through the heat-treatment cycle, or on a carburized and heat-treated specimen with the case ground off, is a fictitious matter. A crack, started in a brittle case, then propagates with extreme rapidity even through so-called "tough" cores. The best core obtainable offers very little accident insurance against snapping of the part.

However, many parts are not carburized all over or are intentionally ground through the case, so that the "core" is exposed; at such locations it is not a core but an unprotected material of construction. If such unprotected locations carry notches, then notch toughness may be required. Such applications should be sharply differentiated from those in which the "core" is a core, and in which the "tough" ones would actually fail in brittle fashion because of the production of an initial crack in the case.

Economic Aspects. Production of thick cases and their adequate diffusion take time, and hence are expensive. Multiple heat treatments are also expensive. Examination of the service conditions to appraise the actual needs as to case thickness, core hardness, and toughness at uncased locations, and machinability, is worth while so that cheap carburizing and heat-treating cycles may be selected. A more expensive steel, amenable to a simple heat treatment, may be more economical than a cheap one requiring complicated treatment.

HEAT TREATMENT AFTER CARBURIZING

Single versus Double Quench. Even with these steels, the single quench does not give optimum properties to either the core or the case, the quench is from much too high a temperature for a high-C steel like the case, and the heating time has been too long and the temperature too high for the best properties in the core. With coarse-grained steels, the core will be brittle and the case may not have its carbide network sufficiently broken up on the single quench. An additional quench is called a "regenerative" quench because it regenerates or refines the structure of the case.

The carburizing process produces a duplex steel, with its original low-C core and a high-C case. Unless a low temperature and a weak

carburizing agent have been employed, the slow-cooled case will be hypereutectoid; that is, it will contain free cementite at the boundaries of the austenite grains existing while it was forming. This brittle network, left undisturbed, will make the case itself brittle.

Single Quench. The heat treatment of carburized steels must take into consideration the low-C core and the high-C case. A 0.10–0.20% C steel will normally be heated to 1600° for quenching, a eutectoid steel to around 1400°, and a 1.15% C tool steel would normally be hardened from about 1400°, but unless the carbide is already well spheroidized a preliminary treatment at about 1600°, that is, above A_{cm} , would be given to dissolve the carbide. In all these cases normal practice avoids heating much above the temperatures mentioned unless the steel is resistant to coarsening. Only when the steel remains fine-grained, at say 1650° or higher, may it be quenched direct from such a carburizing temperature. The quench may be either in water or oil, according to the case hardness and toughness desired and the hardenability of the steel, which is dependent on its alloy content and grain size. The austenitic grain size will be retained in both case and core. At some point where the C is high enough on the radius of the piece the cooling rate will produce bainite, and the still higher-C exterior zones will quench to martensite. In alloyed steels some austenite may be retained. In the hypereutectoid zone the carbide will be well distributed; it has no time to form a network. If the grain size is small enough, both core and case will be fairly tough. This very simple treatment of direct quenching is the one used whenever feasible. We may call this treatment 1. (See Fig. 35.)

Double Quench. Suppose now that the case produced by this treatment is satisfactory, but the core is not strong enough. We can disregard the case and treat for the core; that is, we can reheat to about 1600°, which will refine the grain of the core by passing through A_{c3} , and again quench. The core will then be tougher and the case much as it was before. Actually we are likely to want to avoid the original quench to minimize distortion and cracking, so we may slow-cool from the carburizing temperature, which allows carbide-network separation in the case; but, since we are going to heat above A_{cm} , it will again go into solution, though perhaps not entirely. The treatment is at a pretty high temperature for a tool steel, which is what the high-C case approximates, and, unless the steel is one that resists coarsening, the case may be too coarse. Hence for treatment 2 we shall need a steel resistant to coarsening.

Suppose on the other hand we want to make the core just as ductile as we can, by annealing. Then we slow-cool from the carburizing temperature to get an annealed core. The case is annealed too, and must be reheated and quenched to harden, but we do not want to harden the core. Then we reheat only to about 1400° and quench,

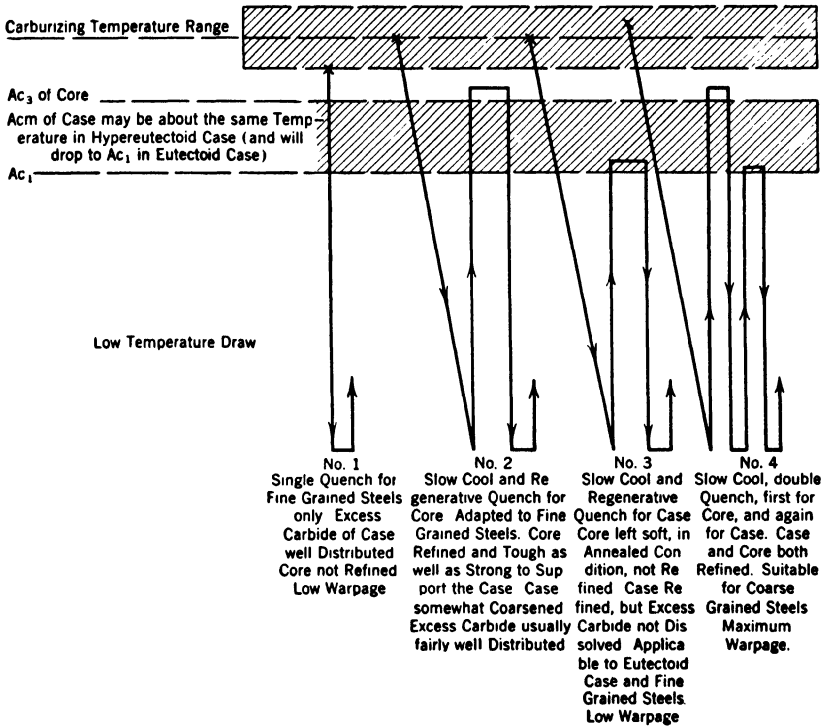

FIG. 35. Schematic representation of four methods of heat-treating carburized steels. (Slightly modified from chart of Int. Nickel Co.)

which leaves the core soft—treatment 3. In this case any excess carbide of the case thrown out on slow cooling is not redissolved. Thus the treatment is best applied to steels with only a eutectoid, not a hypereutectoid, case.

Compromise Treatment. By raising the temperature, say to 1550°, within the Ac_1 - Ac_3 range of the core but not above Ac_3 , we get the core partly refined, a bit tougher and stronger than in treatment 3, and some, but not all, of the free carbide of the case is dissolved. This is a compromise treatment, between 2 and 3. It is applicable to cases that are slightly hypereutectoid. In none of the foregoing is

the treatment just what would be selected as the best for an uncarburized steel of either high- or low-C content, and fine-grained steels are better adapted to, and less injured by, such treatments than coarse-grained ones.

Extended Treatment. If it is necessary to use a coarse-grained steel; or, if the maximum toughness of both case and core be required, a double quenching, first for the core and then for the case, is resorted to. The steel is slow-cooled, reheated above A_{c3} of the core and near, if not above, A_{cm} of the case, as in treatment 2, quenched, then reheated just above A_{c1} , and again quenched. This first heating refines the core and dissolves most or all of the excess carbide in the case, but this first heating is overheating for the case and leaves it with too large grains. Reheating just above A_{c1} and again quenching properly refines and hardens the case.

Treatment 4 gives the optimum mechanical properties and is applicable to steels of any grain size and to those with hypereutectoid cases. But the double quenching increases the likelihood of warping and cracking.

After any of these treatments the steel is given a low-temperature draw to remove quenching strains.

The tendency is to use treatment 1 wherever feasible, as it takes the least time, fuel, and labor, and warpage troubles are slight.

Treatment 4 is the one most certain to give a nonspalling surface on a hypereutectoid case when this is produced so as to have excess carbide particles for wear resistance. Method 4 is sometimes modified for highly hypereutectoid steels by giving an initial quench instead of a slow cool from the carburizing temperature so as to avoid separation of a cementite network, which may redissolve with difficulty on the next reheat. This method of three quenches is too prone to produce warping to be widely applicable.

It will be noted that the most expensive treatment 4, cooling in the box followed by the double regenerative quench, is required by the steels that coarsen materially in carburizing, whereas the cheaper and less complex treatments are only applicable, with satisfaction, to the fine-grained steels.

Warpage. Every heating and quenching involves added tendency toward warping, which is almost always harmful on carburized parts, and so one is often forced to use the single quench from the carburizing temperature. When only a single quench is contemplated, the optimum carburizing temperature is not over 1650° . The longer carburizing times required to get the proper depth of case at around

1600° lead to good diffusion and a smooth gradation from case to core.

Tempering after Quenching. Whatever the quenching cycle adopted, the steel after the final quenching is generally given a low-temperature heating for stress relief, but at so low a temperature that the case is not softened too much for the required service. Temperatures between 300° and 400° are used.

It is generally desired to leave the case file-hard, which is normally accomplished by not exceeding 350° in tempering. The toughness of the case is increased by tempering. A condition often sought is that in which the case remains file-hard but has had its Rockwell-C or Scleroscope hardness dropped materially from that in the quenched condition.

Retained Austenite. The condition of file hardness plus relatively low Rockwell-C or Scleroscope hardness may also be attained by the retention of austenite. Austenite retention is favored by high C content, high alloy content, high quenching temperature, and by oil quenching compared with water quenching.

More austenite is retained in treatment 1 or 2, Fig. 35, than in 3 or 4.

The virtues or evils of retained austenite are not clear. If austenite originally produced were certain to remain as such, the retention of a little might well be advantageous. But if it is going to transform to martensite during service with resulting internal stress the result is likely to be bad. The problem of the stability of retained austenite is most acute in high-speed steel, but is also present in carburized cases. In neither problem are the phenomena fully understood and, because they are not understood, they are not yet controllable.

It seems logical to produce the maximum attainable stability compatible with desired properties in a piece before it goes into service. Avoidance of retained austenite, by transforming it through cold treatment, is advocated by Boyer and Miller,⁶ on logical grounds. It appears that cold treatment may become regular practice on carburized cases.

Other precautions would be to avoid having the surface C any higher than it need be, since Cohen and Gordon⁷ show that austenite retention increases with C. That means ample time for diffusion of surface C or use of carburizers of low-C pressure and of the steels that are less prone to high-C surfaces through limiting the content of strong carbide-forming elements. Water quenching instead of oil

quenching would also help to minimize austenite retention, but is seldom applicable because of cracking.

Trouble from sluggish austenite in the case of 3312 was met by Dietz.⁸ The box cooling was arrested below A_{r_3} to anneal so as to soften for machining, but the results were erratic. It turned out that the austenite produced in carburizing was quite stable; some austenite persisted through the anneal, and in cooling from the annealing temperature transformed to martensite, making the surface un-machinable. The remedy was to cool to room temperature in order to let the austenite all transform to martensite, and then to reheat, holding an hour at only 1380°, so as to leave some undissolved carbide and not produce too stable an austenite. With austenite plus carbide, an arrested cooling to 1100° and holding there an hour decomposed the austenite so that there was no martensite formed on subsequent cooling.

Temperatures of Treatment. The temperature for treatment varies according to the criticals for the case and core; hence the Society for Automotive Engineers has listed suitable treatments for each of the steels on the SAE list. The selection of alloy steels for carburizing is discussed in Vol. III.

The SAE numbers, X1015, X1020, X1314 and X1315 become, in the present AISI numbering, 1016, 1022, 1117, and 1118, respectively.

The compositions for the various SAE carburizing steels are shown in Table 16. In all cases the suggested carburizing temperature is 1650–1700°. The treatments are given in Table 17.

N.E. Carburizing Steels. The N.E. steels were compared with SAE steels for carburizing, on the basis of core properties, by Jones.⁹ He shows that on this basis, 8820 is equivalent to 3120 and 8817 to 2320. Eddy¹⁰ reports that the N.E. steels are less prone to decarburization during box cooling than SAE compositions. Snyder¹¹ found that a higher quenching temperature was required for 8620 and 9420 than for 3115 and 6115, but concluded that 8620 made a better carburized piston pin than 3115.

Austempering of Carburized Steels. It was brought out in Vol. I that austempering, that is, quenching a steel from the austenitic field into a lead or other fused bath at a suitable temperature, can be made to result in the formation of bainite with a very interesting combination of hardness and toughness. This process is most applicable to high-C steels and to pieces of small cross section.

The case of a carburized steel is high C and is thin. Hence it would appear that austempering might be utilized in the heat treat-

TABLE 16

	C	Mn	Ni	Cr	Mo	V	S
1010	0.05-0.10	0.30-0.60	0.055 max.
1015	0.10-0.20	0.30-0.60	0.055 max.
X 1015	0.10-0.20	0.70-1.00	0.055 max.
1020	0.15-0.25	0.30-0.60	0.055 max.
X 1020	0.15-0.25	0.70-1.00	0.055 max.
1115	0.10-0.20	0.70-1.00	0.075-0.15
1120	0.15-0.25	0.60-0.90	0.075-0.15
X 1314	0.10-0.20	1.00-1.30	0.075-0.15
X 1315	0.10-0.20	1.30-1.10	0.075-0.15
2015	0.10-0.20	0.30-0.60	0.40-0.60	0.05 max.
2115	0.10-0.20	0.30-0.60	1.25-1.75	0.05 max.
2315	0.10-0.20	0.30-0.60	3.25-3.75	0.05 max.
2320	0.15-0.20	0.30-0.60	3.25-3.75	0.05 max.
2515	0.10-0.20	0.30-0.60	4.75-5.25	0.05 max.
2512	max. 0.17	0.30-0.60	4.75-5.25	0.05 max.
3115	0.10-0.20	0.30-0.60	1.00-1.50	0.45-0.75	0.05 max.
3120	0.15-0.25	0.30-0.60	1.00-1.50	0.45-0.75	0.05 max.
3215	0.10-0.20	0.30-0.60	1.50-2.00	0.90-1.25	0.05 max.
3220	0.15-0.25	0.30-0.60	1.50-2.00	0.90-1.25	0.05 max.
3312	max. 0.17	0.30-0.60	3.25-3.75	1.25-1.75	0.05 max.
3915	0.10-0.20	0.30-0.60	2.75-3.25	0.60-0.95	0.05 max.
4615	0.10-0.20	0.40-0.70	1.65-2.00	0.20-0.30	0.05 max.
4620	0.15-0.25	0.40-0.70	1.65-2.00	0.20-0.30	0.05 max.
4815	0.10-0.20	0.40-0.60	3.25-3.75	0.20-0.30	0.05 max.
4820	0.15-0.25	0.40-0.60	3.25-3.75	0.20-0.30	0.05 max.
5120	0.15-0.25	0.30-0.60	0.60-0.90	0.05 max.
6115	0.10-0.20	0.30-0.60	0.80-1.10	0.15 min.	0.05 max.
6120	0.15-0.20	0.30-0.60	0.80-1.10	0.15 min.	0.05 max.

(Silicon in basic open-hearth steels 0.15-0.30. Electric and acid open-hearth 0.15 min.)

ment of carburized steels, especially in cases where maximum file hardness is not required for wear resistance.

Queneau and Dowdell¹² quenched several carburized steels into molten salt at 400°. Holding for 5 hr gave a surface hardness of 60-62 Rockwell C. At 600° for 1 hr 55 Rockwell C was obtained.

The steels used were one of 0.64 C, 0.80% Mn; 0.42 C, 0.77% Mn, 0.20% Mo; SAE 2330 of 0.32 C, 0.65 Mn, 3.45% Ni, and SAE 3120 of 0.18 C, 0.65 Mn, 1.20 Ni, 0.64% Cr.

It was necessary to use ½-in. square bars of the first two steels to get a case of 60 Rockwell C by austempering at 400° after box carburizing 8 hr at 1700°, though 1-in.-diameter bars of the latter two hardened at the surface almost the same as in oil quenching. Impact results on all the steels, carburized in the regular Charpy size, showed no real difference between quenching and tempering, and austempering. In the bend test on carburized ½-in. square

TABLE 17

Steel	Carburize and Quench Direct	Carburize, Quench Direct, or Slow-Cool and		Carburize, Slow-Cool				Cyanide or Activated Bath *		Temper at
		Reheat to	Quench in	Reheat to	Quench in	Reheat to	Quench in	Heat at	Quench in	
1010 } 1015 } X1015 } 1020 }	Yes	1400-1450	Water	1400-1450	Oil or water	1400-1450	Water	1500-1650	Oil or water	250-325°
X1020 } 1115 } 1120 }	Yes	1400-1450	Oil or water				Oil or water	1500-1650	Oil or water	250-325°
X1314 } X1315 }	Yes	1400-1450	Oil or water				Oil or water	1500-1650	Oil or water	250-300°
2015 } 2115 }	Yes	1375-1425	Oil			1375-1425	Oil	1650-1700	Oil	250-300°
2315 } 2320 }	Yes	1350-1400 for case or 1450-1500 for core	Oil			1350-1400	Oil	1450-1650	Oil	250-300°
2515 † } 2512 † }	No	(Slow-cool) 1325-1375 for case or 1400-1475 for core	Oil			1325-1375	Oil			250-400°

* Temper after cyanide or activated bath if desired.

† First normalize or anneal to desired structure.

TEMPERATURES OF TREATMENT

TABLE 17 (Continued)

Steel	Carburize, Quench Direct, or Slow-Cool		Carburize at Same Temp., Slow-Cool				Cyanide or Activated Bath		Temper at
	Reheat to for Case	Reheat to for Core	Quench in	Reheat to	Quench in	Reheat to	Quench in	Heat at	
3115 * 3120 *	1400-1450	1450-1500	{ Oil or } { water }	1525-1575	Oil	1375-1425	{ Oil or } { water }	1500-1650	250-300°
3215 * 3220 *	1375-1425	1425-1475	Oil	1525-1575	Oil	1375-1425	Oil	250-500°
3312 †	1375-1425	1425-1475	Oil	1525-1575	Oil	1375-1425	Oil	250-300° 250-400°
3415 † 4615 † 4620 †	1375-1425 1425-1475	1450-1500 1475-1525	Oil	1500-1550 1525-1575	Oil	1375-1425 1375-1425	Oil	after direct quench
4815 † 4820 †	1350-1400	1450-1500	Oil	1550-1650	Oil	1350-1400	Oil	250-300° 250-500° after direct quench
5120 † 6115 † 6120 †	1425-1475	1475-1525	1600-1650	Oil	1425-1475	Oil	1500-1650	250-350° { Oil or } { water }

* First normalize above carburizing temperature for all save cyanide and activated baths.

† Normalize at least 50° above carburizing temperature. Anneal to desired machinability.

bars the last two steels also behaved the same, irrespective of the treatment, but the 0.64% C steel, water quenched and tempered, supported about 1000 lb, whereas, when austempered, it supported 4000. The 0.42 C, 0.20% Mo steel, water quenched and tempered, supported 3000; austempered, 4000.

Queneau and Dowdell conclude that austempering carburized parts has possibilities as it allows the use of a steel of higher-C content than could be used in the normal heat treatment of carburized steels, since, with the normal treatment, quenched samples would be weak because of the stresses set up in hardening.

These authors did not report on the properties of steels with cases austempered to 55 Rockwell C by quenching into salt at 600°. There are interesting possibilities in carburizing and austempering for strength, steel of either low- or medium-C content, especially when the case is brought to about 55 Rockwell C, that have not yet been explored.

Distortion of Gears. It is becoming accepted that most automotive gears are not subject to impact stresses,¹³ that impact resistance of gears is far less important than fatigue resistance, particularly resistance to repeated overstress, and that the main trouble with automotive gears is the slight distortion that occurs on carburizing. Hence a wider range of carburizing steels is being considered for such use.

Conclusions as to the best carburizing steels for a given gear are greatly affected by the gear-cutting method already in use. By cut-and-try methods a contour is found, which, after carburizing and hardening, gives the least lapping-in to be done. Another steel and another treatment, with a different degree or type of distortion, will give very bad results while the old contour is retained, but equally good results when the proper contour is found.

The conclusion that in these gears impact is a minor matter is not necessarily true for many other gears, or for many carburized parts in general.

The Human Element in Case Hardening. The factors of experience and personal judgment count heavily in all heat treatment, but nowhere more heavily than in the production of carburized parts. There are so many factors that can be intentionally or unintentionally altered which affect the final result that extreme care is required to ensure that the product is uniform.

Each different type of service has certain requirements as to hardness and toughness of the case and core, and as to the gradation be-

tween them. Such requirements are not easy for the engineer to state, nor is it easy for the metallurgist to measure the type of toughness involved. One may fairly question the real value of tests made on the core without the presence of the case, or of tests on bars carrying both case and core that are not of the shape used or subjected to the type of stresses that occur in service.

These difficulties are reflected in the varied opinions as to what steel should be used, what core hardness is needed to support the case, and what case thickness and carbon content should be secured. There is real unanimity only in that fine-grained steels afford superior service and that warpage is minimized by putting the steel through as few heating and quenching cycles as will serve. These facts combine to focus attention on those fine-grained steels that are suitable for single-quench treatment.

After a suitable steel and a suitable carburizing and heat-treatment practice have been selected, eternal vigilance is required to maintain the selected conditions. Examination of incoming stock, careful control of temperature, of the uniformity of the carburizing medium, and especially of the temperature uniformity of the charge are vital. Inclusion of pilot test pieces that are broken and examined for depth, and adhesion, of case and for hardness is essential as a final check.

BIBLIOGRAPHY

1. M. A. GROSSMANN, Oxygen in steel, *Trans. ASM*, V. 18, 1930, pp. 601-31.
2. G. DERGE, A. R. KOMMEL, and R. F. MEHL, Some factors influencing austenitic grain size in high purity steels, *Trans. ASM*, V. 26, 1938, pp. 153-72.
3. E. C. BAIN, Factors influencing the inherent hardenability of steel, *Trans. ASST*, V. 20, 1932, pp. 385-428.
4. J. F. WYZALEK, discussion, *Carburizing Symposium*, American Society for Metals, 1938, pp. 83, 216-17.
5. H. W. McQUAID, Selecting the proper hardening treatment, *Metal Progress*, V. 27, March 1935, pp. 25-30.
6. H. E. BOYER and H. C. MILLER, Subzero treatment simplifies hardening of alloy carburizing steels, *Materials & Methods*, V. 23, March 1946, pp. 730-4.
7. M. COHEN and P. GORDON, Heat treatment of highspeed steel, *Iron Age*, V. 157, 1946, February 28, pp. 42-7; March 7, pp. 52-7; March 14, pp. 68-73; March 21, pp. 61-5; March 28, pp. 55-62.
8. W. DIETZ, Short annealing cycle for carburized 3312, *Metal Progress*, V. 42, December 1943, pp. 1097-1100.
9. J. H. JONES, N.E. steels 8600 to 8900, *Metal Progress*, V. 41, June 1942.
10. W. P. EDDY, Effects of wartime development on future steels, *Steel*, V. 114, February 14, 1944, pp. 104-08, 136.

11. T. M. SNYDER, Automotive applications of N.E. steels, *Steel*, V. 114, March 6, 1944, pp. 128-30.
12. B. B. QUENEAU and R. L. DOWDELL, Case hardening by direct transformation of austenite, *Trans. ASM*, V. 25, 1937, pp. 904-22.
13. J. O. ALMEN and A. L. BOEGEHOLD, Rear axle gears, factors which influence their life, *Proc. ASTM*, V. 35, Part 2, 1935, pp. 99-146.

CHAPTER 6

CONTROLLED ATMOSPHERES

Scaling. The study of carburizing leads naturally to the consideration of controlled atmospheres in heat treatment. If steel is heated in a muffle to which air has access, or if, in an unmuffled furnace, the flue gases resulting from the economical combustion of fuel reach the hot steel, it oxidizes and scales.

Such flue gases from economical combustion have very little carbon monoxide (CO), much carbon dioxide (CO₂), and usually some free oxygen (O₂), that is, the fuel is burnt with a slight excess of air. The gases also contain a good deal of water vapor from the burning of the hydrogen (H₂) of the fuel.

The combustion engineer calls a flue gas containing excess O₂ "oxidizing"; one with no free O₂ and little or no CO, that is, resulting from practically perfect combustion, "neutral"; and one with considerable CO, "reducing." But these terms are *not* correct in relation to the action of the gases on steel. Flue gas even from such smoky combustion that the fuel is wastefully burnt is definitely oxidizing to red-hot steel.

Smoky Flames. Scaling may be slowed down by use of smoky flames, but not eliminated. The water vapor and CO₂ in the products of even very incomplete combustion make flue gases oxidizing. Of course anything that reduces the amount of active oxygen (either free O₂ or that combined as CO₂ and H₂O) that reaches the steel reduces scaling. Displacing the air or flue gases within an open furnace by putting in pieces of wood to char, charcoal to burn, dripping in oil vapor, or leading in a fuel gas which burns at the furnace vents will tend to lower the amount of active oxygen meeting the steel. Uphthegrove¹ finds that regulating combustion to give 3% CO in flue gas will cut scaling, in direct firing, by 75%, but the 25% still remains. According to Jominy² it takes 15% CO in flue gas to bring about practical elimination of scale. Even this does not give "clean" hardening. A huge proportion of the fuel

would be wasted in using so great a deficiency of air as to give 15% CO in the flue gas.

Smoke Burners. An obvious way to attack the problem is to lead the fuel gas into the furnace so that it surrounds the steel charge and does not meet the air for combustion till it passes beyond the charge. The gas will crack and deposit C on the work. This layer and the gas itself should protect the steel.

The incoming fuel gas is relatively cool when it hits the work; so the hottest gases of combustion do not wash the work, and much of the heating has to come by radiation from the furnace walls and from the hottest part of the flame itself. So-called diffusion burners have been devised to operate on such a principle. Obviously, any fluctuation in the gas currents within the furnace may displace the protective layer of gas and expose the work to scale-forming conditions. Fisher³ appraises such burners as hard to control and prefers to separate the function of supplying the heating flame with gas from that of surrounding the work with raw gas. He advocates good premixing of gas and air for the heating burners and special "smoke" burners which carry a smaller amount of gas to the work, where that gas—unmixed with air—cracks and deposits soot. Such an arrangement he believes to be the most feasible for scale mitigation in unmuffled fuel-heated furnaces.

Whether one should aim merely at the mitigation of scaling (taking care to avoid the production of a tight scale, difficult to pickle, and to avoid decarburization), and accept the necessity of pickling and grinding, or should seek complete elimination of both scaling and decarburization by elaborate controlled-atmosphere methods, is an economic problem to be decided by local conditions.

Decarburization. Scaling is an obvious aboveboard phenomenon. When it occurs, everyone knows that the scaled surface has to be machined away, to give a good surface condition. Decarburization is less obvious and more insidious. The clean surface may look all right, but, in respect to wear and fatigue, it is not all right. Fatigue behavior is conditioned by the surface layer, even though this be extremely thin. Figure 1 demonstrated this.

In soaking pits, billet heating furnaces, etc., decarburization occurs unless there is heavy and rapid scaling. In hot rolling and later cold rolling, the decarburized layer is thinned down, as the sheet, plate, or bar is elongated. Unless pickling is carried on so deeply as to remove appreciable metal (and pickling is aimed to remove scale, not metal), the final stock, as it comes from the mill,

has a decarburized layer, even though it may be excessively thin and its presence may not be evidenced by ordinary hardness determinations, and, in many steels, not apparent under the microscope.

Mawhinney ⁴ discusses decarburization in mill heating furnaces in considerable detail. As one example, a 9260 steel, heated 70 hr in a continuous billet furnace, then rolled to 300% increase in area, showed 0.215-in. decarburization, of which the outer 0.01 in. was carbonless, the next 0.10 in. decarburized to a pronounced degree, and the remainder slightly decarburized. A 0.01-in. C-free skin on a 0.60% C steel means that, in fatigue, the stock will act like ingot iron.

Another case cited is in annealing of 3140 at 1600°, this being at a lower temperature than in the case of billet heating. Complete decarburization was found up to 0.005 in. and partial to 0.03 in.

Mattocks ⁵ points out that, where some scaling can be permitted, operating with about 0.50% excess O₂ over that required for complete combustion avoids decarburization.

The effort to avoid scaling, where the flue gas can meet the work, is usually attended with greater evil from decarburization than the scaling evil that is avoided or lessened.

In heating for hot rolling or forging, where the steel will later scale somewhat anyhow in the hot working (which of course is done in the open air), it will more often be the economical method to aim merely at mitigation rather than elimination of scaling in the heating process. In such service Conway ⁶ reports that efficient preheating of combustion air in an oil-fired slab-heating furnace so that the time of heating is cut down, together with adjustment of flue gas to about 12% CO₂, makes the best compromise between fuel efficiency and scale thickness.

High-Speed Steel. In the hardening of high-speed tool steel at 2300–2400° in the open, it is customary to gage the tool temperature by eye, noting when the scale starts to melt and blister. Besides the loss of metal, the irregular blistered scale produces danger of irregular hardening in quenching. It is not easy to maintain muffles or metallic resistors at such a temperature; so controlled-atmosphere furnaces for high-speed steel tend to be electrically heated by Globar resistors. The controlled atmospheres for such furnaces used to be produced by partly burning a fuel gas with a deficiency of air, controlling the ratio by manometers and valves, and feeding the mixture directly into the furnace without elimination of water vapor. Most analyses of the gas atmosphere given in the literature tell

only the free O_2 , the CO_2 , and CO , disregarding the important factor of the water vapor, which will, of course, vary greatly with the H_2 content of the particular fuel gas used.

Recommendations for gas composition on the basis of CO_2 , CO , and O_2 usually agree in advocating complete freedom from unburned O_2 for the high-speed hardening heat, but vary considerably as to the proper ratio of CO to CO_2 . Conflicting statements as to effect of the atmosphere on the rate of heating and the propensity to grain growth in various atmospheres are also made, so that the whole matter should be handled by experimentation on the actual high-speed steel and the actual fuel gas to be used. Broadly speaking, adjustment of the atmosphere to be free from unburned O_2 , that is, so that wood will char but not burn in the furnace, is helpful in minimizing scale. If water vapor, which tends to decarburize, is present, then a thin scale is probably desirable to protect the surface from decarburization, and such a scale is produced when the atmosphere contains some CO_2 .

There would seem to be little objection to giving a high-speed tool a thin skin slightly higher in C , but in practice this is seldom attempted save by so-called "pack-hardening," that is, heating in charcoal or the like. This is often applied, for example, to high- C high- Cr tool and die steels, and more rarely to high-speed. When pack hardening is applied, the steel is heated to only about 2000° to avoid excessive carburization.

The usual effort for high-speed steel is to get a controlled atmosphere that contains no free O_2 and has 6 to 12% CO , with corresponding amounts of CO_2 , that is, an atmosphere that results from slightly incomplete combustion and is definitely oxidizing at this temperature. The moisture is not ordinarily removed from the gas in practice. However, Peck⁷ remarks that, in heating high-speed steel for quenching, *both* CO_2 and H_2O *must* be absent if decarburization is to be entirely prevented.

The high-speed steel preheat at 1400 – 1600° is generally carried out either in a definitely oxidizing atmosphere in order to form a thin adherent scale that will keep the high-heat atmosphere away from the metal itself, or in cast-iron borings. Because full muffle and electric furnaces are seldom used on high-speed steel, adjustment of the flue gas of the direct flame method is all that is ordinarily attempted in the high heat. When muffles and electric furnaces come into greater use for high-speed steel, slightly carburizing

atmospheres will probably be found applicable, provided they do not injure the muffles or resistors.

Gill⁸ finds that in heating high-speed steel for forging, it is better to scale than to run the risk of carburizing or decarburizing, though, were an atmosphere available whose action would be truly neutral for the time required in the slow heating and long holding necessary, it would of course be better. For annealing, a lime or sand pack with only a small amount of charcoal is suggested. In heating for hardening, Gill states, the preferred controlled atmospheres produce a surface carburization, the C content rising some 0.25% C for a depth of about 0.001 in., which is normally removed in finishing the tool. Were the conditions decarburizing, a much thicker soft skin would have to be removed.

Other Tool Steels. At the lower temperatures of C and low-alloy tool-steel hardening there is some effort to do really bright hardening by using a definitely carburizing atmosphere, such as that from cracked oil vapor. In more common practice a mildly but definitely oxidizing atmosphere is chosen, to minimize scaling while avoiding decarburization. Palmer⁹ advocates an atmosphere with some 10% free O₂ for various high-C low-alloy tool steels, only selecting atmospheres with no free O₂ and with 12% or more CO for high-C high-Cr and for Cr-W hot-work steel. Such recommendations are not made to give the greatest avoidance of scale but rather with the aim of avoiding decarburization while accepting considerable scale formation.

Palmer finds some interesting things about the effect of atmosphere on the toughness of C tool steel (1.10% C), with toughness evaluated by a torsion impact tester. The atmospheres studied are not stated in detail but are referred to as "oxidizing, neutral, and reducing" in the phraseology of the combustion engineer, which probably means that they are all oxidizing in varying degree. There is not a huge difference between the torsion impact results on a given type of steel heated in these various atmospheres, and the fine-grained "tough-timbre" steel, stands heating in any of the atmospheres studied by Palmer with very little loss of toughness compared to the result obtained in a lead bath. The coarse-grained "brittle-timbre" steel, however, is strongly affected by all the atmospheres, whereas if heated in the lead bath it is quite as tough as the "tough" steel at normal hardening temperature, and only slightly worse at still higher temperatures (d'Arcambal remarks¹⁰ that makers of small tools ordinarily heat in lead baths).

Thus the coarse-grained steel is shown to be seriously affected by surface attack. This peculiar phenomenon is not well understood nor satisfactorily explained. An analogous phenomenon, by which it has been alleged that, in the proper atmosphere, high-speed steel will stand exposure times in heating for hardening without grain growth that would, in the ordinary more oxidizing atmosphere, produce ruinous coarseness, has received much discussion. The mechanism involved is explained in several ways, none of them entirely convincing. However, these observations indicate that subsidiary effects may appear, arising from what is done to the surface by atmospheric attack during heating, so that atmosphere control may have more far-reaching results than appear at first sight.

Heating Ordinary Steels for Hardening. Heating in a muffle or electric furnace that is kept closed so there is no draft through it tends to restrict the oxygen meeting the steel to that originally in the furnace when the steel was charged. Such furnace atmospheres are not really controlled; they are merely mitigated in order to reduce scaling somewhat. The surfaces produced require machining or pickling to remove the scale that does form.

The scaling of steel is greatly increased by the presence of SO_2 , from fuels containing S.

Scale versus Decarburization. Precautions to cut down scaling, without entirely preventing it, often run into two difficulties—the thinner scale may be tighter and more difficult to remove on pickling, and, when too thin a scale is made, there may be a decarburized layer beneath it. A soft decarburized bark is to be avoided in cutting tools, where to have the cutting edge or, in springs, to have the most highly stressed surface soft and weak would ruin the performance of the piece.

For example, Boegehold¹¹ points out that in “knee-action” springs for automobiles the steel, for example, SAE 9260, must be heat-treated to 430–480 Brinell in order to stand the maximum applied stress of more than 115,000 psi in torsion. If the surface is decarburized, its strength is only some 30,000 psi in torsion; so surface cracks form and are propagated through the stronger core. Hence the steel, after hardening, must be ground to remove the decarburized bark, or else decarburization must be prevented by using a mildly carburizing atmosphere during heating for hardening. Similar arguments apply to axle shafts.

When scaling is heavy, oxidation progresses so fast that Fe is removed as fast as C. At a slower rate of scaling, C may be removed

faster than Fe and faster than diffusion of C from the inside can take place to replenish the depletion of C at the surface. Water vapor tends to decarburize rapidly, as it breaks down at the surface of the steel, the O combining chiefly with Fe, the hydrogen being freed to attack the C, forming CH_4 . Jominy² cites an interesting case where decarburization was met in an electric furnace, heating gears for hardening, when a breeze from an open window blew steam from a quenching tank into the furnace. In controlled atmospheres free O_2 and SO_2 are the most fatal, H_2O the next most dangerous constituent.

Effect of Time and Temperature on Scaling. The rate of scale formation increases greatly with temperature, and of course scaling increases with time at a given temperature. The curve for ordinary steels is of the type shown in Fig. 36. Tempering after hardening is usually done at such low temperatures that the resultant temper color or incipient scale is too thin to do harm, and tempering furnaces often circulate air over the work by a fan to secure better temperature uniformity.

On account of the time factor, scaling can be minimized by heating rapidly, but, as is brought out in Chapter 8, rapid heating is undesirable since the temperature of the inside and outside should be as closely as possible the same before forging or quenching. Only in the case of those types of electric heating where the heat is generated in the metal itself can rapid heating be accomplished and temperature uniformity be obtained. This internal heating of steel by its own resistance is feasible only in regular sections. Rods, tubes, and the like can be heated by passing heavy currents through them, as in the Snead process and in Berwick heaters, and the heating can be done so rapidly that even in air there is very little scale formation. High-frequency induction heating as applied to circular sections, like the bearing surfaces of crankshafts and piston pins, can be used to heat the surface rapidly and uniformly, without

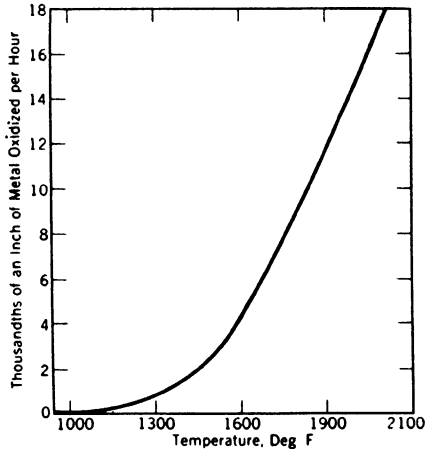

FIG. 36. Rate of scaling in air, with increase in temperature. (After reference 12)

such a degree of scaling as would be harmful. Indeed, the crankshaft-hardening process produces little more than a slight tarnish. Moderately irregular sections, like cam shafts, may also be hardened by induction heating.

Blueing. An oxidized surface may not always be detrimental. Production of a definite thin adherent scale, followed by H_2 reduc-

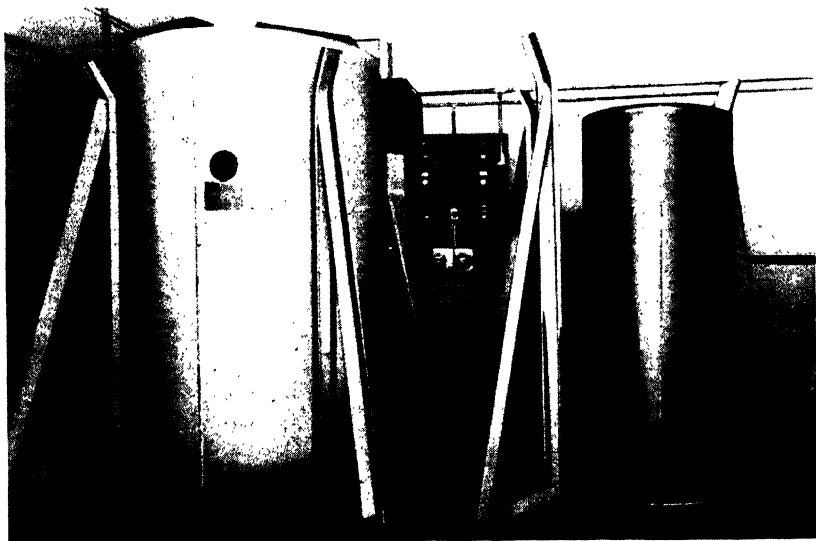

FIG. 37. Electric-bell annealer for coiled wire. The coils are piled and covered with the gas-tight container shown at the right. The protective gas atmosphere is led into this container. The furnace itself is at the left. The heating elements are on the inner wall. The furnace is lifted off the first container, by a crane, and set over a second container so that the second may be heating while the first is cooling. (Courtesy General Electric Co.)

tion just before hot galvanizing, is utilized in one process¹³ to form a clean matte surface to which the Zn coating will adhere strongly. Intentional blueing, somewhat analogous to the old Bower-Barff coating,¹⁴ produced by low-temperature heating in an atmosphere made oxidizing, as by admission of steam, is produced by admitting steam into an annealing box during the cooling cycle and is utilized in producing a commercial finish.¹⁵ Safety razor blades are produced with a blue finish. Blueing may be produced by air at low temperatures, as a "temper color," or in a salt bath compounded to have a controlled oxidizing power.¹⁶ A tenacious oxide film is sometimes produced on cast-iron piston rings, to cut down wear.

Heating to 1200° for an hour or so, in spent carburizer or in charcoal, followed by oil quenching, produces a thin adherent scale, indicating that the $C:CO:CO_2$ equilibrium for this temperature makes the gas atmosphere slightly on the oxidizing side for steel.

Annealing. At the annealing temperatures used to soften work-hardened low-C steel, for example, 1200 – 1250° , scaling may be of

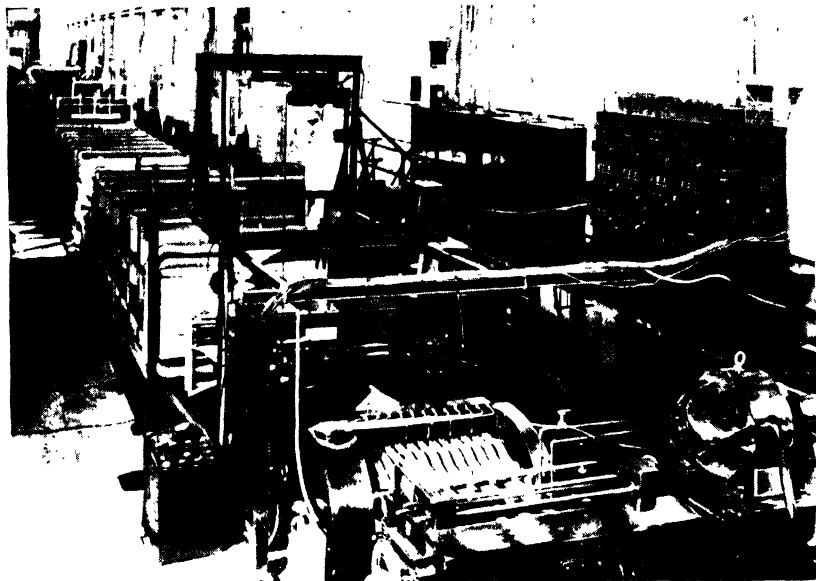

FIG. 38. Continuous controlled-atmosphere electric normalizing furnace at the Ford Motor Company. This furnace is 230 ft long. Another similar furnace in the same plant is 330 ft long. (Courtesy Westinghouse Elec. Corp.)

minor importance on heavy stock, but it is important on very thin sheet. Cold-rolled sheet or strip is annealed in packs or in coils; and, in order to drive the heat through the air spaces between the leaves of metal, since such air spaces are good heat insulators, very long heating periods must be used, and almost equally long cooling periods are required before the stock can be handled. A cycle may take 40 hr. Although the temperature is not high, if air is present the edges of the sheet will be badly scaled. When a clean surface is required, the pack or coil is subjected to “box” annealing, the stock being enclosed in a covered container heated from the outside. The “box” or “bell” is usually placed over the pack or coil (which may weigh several tons) and sets into a sand seal. On heating, the air expands and some of it escapes, the remainder attacking the steel.



FIG. 39a. Electric box annealer. (Courtesy Westinghouse Elec. Corp.)

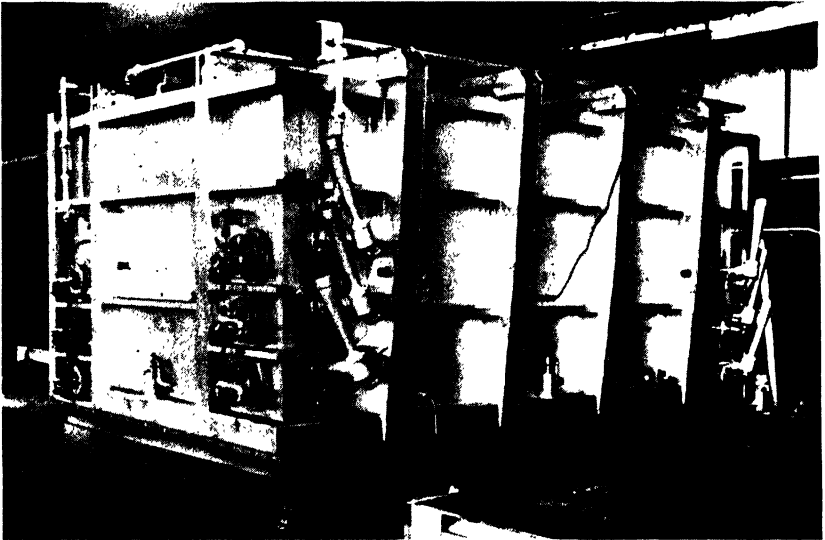

FIG. 39b. Radiant-tube box annealer. (Courtesy Surface Combustion Co.)

Box annealers. Stacks of steel sheet are covered by a rectangular box, within which the protective atmosphere is led. The furnace, with resistor elements, as in Fig. 39a, or with radiant tubes, as in this figure, is lifted off or on the inner cover for cooling or heating.

To prevent this, some nonoxidizing gas may be led into the box to displace the air. It is especially important that the gas be allowed to flow through it during the cooling period to prevent air inflow as the enclosed gas contracts on cooling.

Introduction of city or natural gas in box annealing was the first use of a "controlled atmosphere" in heat treatment. Raw fuel gas will deposit C on the work as it cracks, so that the next step was to crack it outside and lead in the H_2-CH_4 mixture so produced.

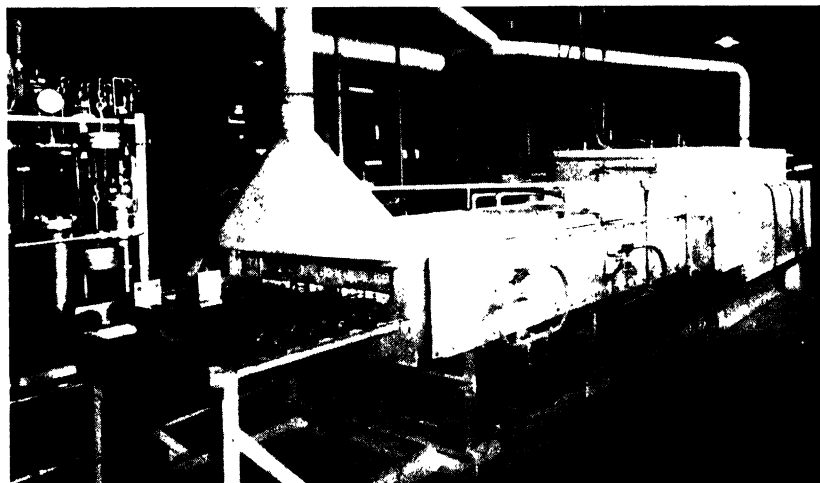

FIG. 40. Continuous controlled-atmosphere normalizing furnace, operating on cold-rolled strip. (Courtesy Westinghouse Elec. Corp.)

Still later, other protective gases, such as H_2 , or cracked NH_3 , or atmospheres specially prepared by burning a fuel gas with a deficiency of air, came into use. The H_2 and the 75% H_2 , 25% N_2 atmospheres (the latter produced by cracking anhydrous ammonia, NH_3) find some use commercially in annealing of silicon transformer sheet.

Bright Normalizing. The majority of "controlled-atmosphere" applications in use are in the box or bell annealing of very low-C sheet and strip (see Figs. 37-40), and the atmospheres are produced from some readily available fuel gas and air. Since the advent of continuous strip and wide strip mills, continuous normalizing of cold-rolled low-C steel in controlled atmospheres has also become important. Here the temperature may go up to 1750° , but the time at temperature is short, of the order of 5 to 15 min. Because of the great speed at which the strip travels, the furnaces may be

very large. One at the Ford Motor Company is 330 ft long, including the primary heating, cooling, reheating, and final cooling zones (compare Fig. 38). Seabold⁶⁷ describes a large furnace in which cold-rolled strip is annealed at 1330° in 2 min, or normalized at 1725° in 4 min, controlled atmospheres being used. Both the bright annealing and the bright normalizing processes normally relate to very low-C plain C steels.



FIG. 41. Continuous controlled-atmosphere brazing of balls at a plant of the General Electric Company. The furnace may also be used for bright annealing.

Spheroidizing annealing of high-C steel wire is also being done in controlled atmospheres, but *not* in the same atmospheres that are used for low-C steels.

Clean Hardening. The success of bright annealing and bright normalizing, with avoidance of the messy pickling process and the less of steel involved, has made the heat treater anxious to do "clean hardening" on his medium- and high-C plain and alloy steels. Hardening furnaces provided with means for surrounding the work with a suitably controlled atmosphere are on the market or are specially designed in the case of large continuous furnaces. The atmospheres employed are still far from standardized, nor are they wholly satisfactory from all points of view, including performance, ease of control, and cost. It is easy enough to avoid scaling, but to do so without decarburization is far less easy.

Furnaces for Controlled Atmospheres. Any controlled-atmosphere furnace must employ the "diving bell" principle of a container sealed against access of air or flue gases, with inlet and outlet to carry a stream of the desired gas at slightly above atmospheric pressure to avoid infiltration of air. This is not difficult in a batch



FIG. 42. Batch-type controlled-atmosphere furnace. The gas generator in which fuel gas and air are burned to produce the controlled atmosphere, together with equipment for condensing and removing most of the moisture, is shown at the left. (Courtesy General Electric Co.)

furnace. To allow charging and discharging of a continuous furnace without inward leakage of air, special seals, a more rapid gas flow, and a higher pressure are required (see Figs. 40-42). The container must be externally heated, like a muffle furnace, or, if internally heated, the heating must be by electric resistors or radiant tubes so that no products of combustion reach the inside of the container. Care must be taken to flush the air out of the furnace after a shutdown, before charging the steel. Sealing and purging involve obvious difficulties, which have been discussed by Hotchkiss,¹⁷ Weber,¹⁸ and DeCoriolis.¹⁹

Gases Used or Proposed. Given such a furnace, the problem resolves itself into providing a gas that will not scale or decarburize a given steel at the temperature and time required for heat treatment.

Nitrogen. Pure dry nitrogen (N_2) would be relatively inert to the work under most conditions (though at unusually high temperatures even a plain C steel can pick up some N_2). Some resistor alloys and some heat-resisting alloys, unless their surfaces are completely protected by a preformed oxide coating, are quite readily nitrided in, and hence deteriorated by, N_2 . Besides its cost, there is the difficulty of getting commercial N_2 entirely free from traces of O_2 or CO_2 , which are undesirable, nor does a wholly neutral gas provide any mitigation of the effect of infiltrated air.

Jominy²⁰ remarks that dry N_2 with as little as 0.1% O_2 will decarburize worse than air. Bramley and Allen²¹ (see also Jominy² and Weber¹⁸) have shown that N_2 which contains the 2% of water vapor that it can hold at 65° is badly decarburizing while even the 0.05% it can hold at -20° has a distinct action (compare Fig. 43).

Even in the laboratory, purification of tank N_2 is not an easy matter. Martin and Wiley²² passed tank N_2 over hot Cu chips, to combine with free O_2 , and through a phosphorus pentoxide drying tower, to remove H_2O . But the gas, so "purified," used as a protective atmosphere for heating a 1.10% C steel 1 hr at 1650°, decarburized the surface down to 155 Knoop hardness, from the original 740 of the undecarburized steel.

An "impure" N_2 carrying small amounts of some gas, such as CO, H_2 , or CH_4 , that will oppose the decarburizing effect of traces of H_2O , is much to be preferred.

Most commercial gases suggested for controlled atmospheres do contain appreciable amounts of the "reducing" gases H_2 or CO, or both, and perhaps of CH_4 . These reducing gases are likely to be accompanied by the oxidizing gases H_2O and CO_2 , so that a balance has to be sought. Unfortunately, this balance is a variable one, depending on the composition of the steel to be handled, as well as on the temperature at which heating is to be carried out.

Effect of Controlled Atmospheres on Carbon and Alloy Steels.

The main factor governing the behavior of a given gas as to staining, and to carburization or decarburization, is the C content of the steel. Broadly speaking, the moderately alloyed steels, of the SAE and N.E. series, for example, act very much like a plain C steel of the same C content. This is not exactly true, but it serves as a good general approximation, as the work of Slowter and Gonser²³

shows, in respect to carburization and decarburization. In respect to staining, there is one notable exception to this general rule. Steels high in Cr are stained by atmospheres containing CO, which do not

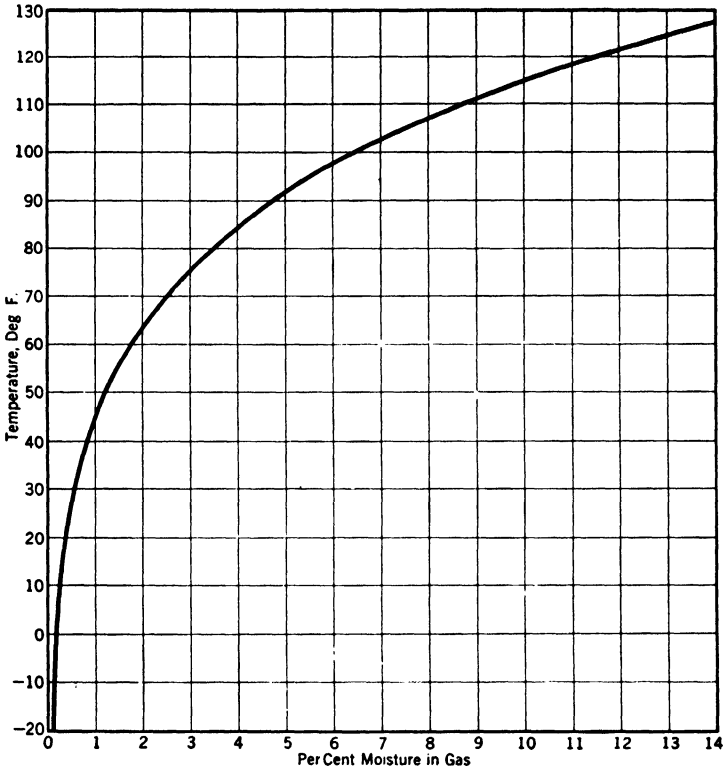

FIG. 43. Dew-point curve. A wet gas, cooled to the temperatures shown, will deposit its excess moisture, but will retain the amount shown. A wet gas can be dried by a water spray whose temperature is below that of the gas. Its final moisture content will be that of the temperature to which it is cooled by the water. If the cooling water, brine, or other medium does not contact the gas but is carried in pipes, the moisture condensed from the gas will collect on the pipes. To allow it to drip off, instead of forming frost, the temperature must be above 32°. Cooling coils are therefore used only down to about 35°, corresponding to 0.6% H₂O. For small H₂O content, the gas may be passed over activated alumina, by which the H₂O content can be brought down to about 0.01%.

stain C or other alloy steels. The low- and medium-Cr SAE steels for heat treatment have a tendency to be stained in atmospheres containing CO, but with such amounts of Cr the oxide film is something like a temper color on a C steel and is so thin and uniform

that it will probably exert little if any effect on the rate of cooling in quenching.

Were it necessary to bright-anneal the ordinary SAE steels containing Cr, the atmospheres containing CO would need to be avoided along with those containing free O₂, CO₂, or H₂O, but this avoidance of CO is not required in hardening. The high-Cr steels like 18 Cr 8% Ni stainless cannot be kept bright when heated at the usual temperature in gas containing CO. For this purpose only completely dried H₂ or H₂:N₂ will serve, and the merest traces of O₂, H₂O, CO₂, or CO must be avoided.

Simple-Gas Pairs. Unfortunately H₂ and CO are not merely *reducing* gases. Hydrogen always and CO under certain conditions are *decarburizing* gases, so that a gas mixture containing H₂ or CO that is just balanced to prevent oxidation, is decarburizing, and a further balance must be made to get out of the decarburizing field and onto the neutral line where decarburization may be avoided.

Before the more complex gas mixtures are considered, the two simplest cases, and the ones most directly related to gas carburizing, should be reviewed. The active agent in several of the gases used for ordinary gas carburizing is methane, CH₄, either supplied as such in natural gas or produced by decomposition of higher hydrocarbons into CH₄ + H₂. In ordinary box carburizing the active agent is CO, accompanied by a little CO₂.

In the case of H₂ and CH₄, with or without N₂ (in the absence of contaminating gases that contain active O), there is no problem of scaling or oxidation. Only one action, that of carburization or decarburization, needs to be considered. (This is not true if the gas contains H₂O, and this complication is discussed later. Soot deposition also has to be taken into account.) But no CH₄:H₂ ratio is inert to all steels at a given temperature, or to any one steel at different temperatures. For the gas to be inert to a given steel at a given temperature, the right CH₄:H₂ ratio must be used. Figure 23 gave information necessary for choice of the correct ratio.

Carbon Monoxide-Carbon Dioxide Mixtures. The simple gas pair CO:CO₂ (with or without some dilution by N₂), when a reactive form of free C is present, and especially when an energizer like BaO is also present, is carburizing to steels of all commercial C contents, at ordinary carburizing temperatures, as has been discussed in Chapter 4. The reason is that the reaction $\text{CO}_2 + \text{C} \rightleftharpoons 2\text{CO}$ at these temperatures, and especially with the energizer present, produces a gas mixture high in CO and low in CO₂ whatever the initial

ratio. If the free C is left out, or if a nonreactive form of C is used, and the energizer is omitted, conditions may be anything determined by the initial ratio.

Relative Inactivity of Pure Carbon Monoxide and Pure Hydrogen.

From the point of view of carburizing, it should be again remarked that, although these equilibrium curves *C* and *D* of Fig. 24 for CO:CO₂ indicate that pure CO or pure CO plus N₂ would be strongly carburizing, actually CO does not readily break down to deposit soot and form CO₂ by the reaction $2\text{CO} \rightleftharpoons \text{C} + \text{CO}_2$, and it appears essential, in order to have an actively carburizing gas, that a reversible chemical reaction should be going on, to produce nascent C. Thus at 1700–1750° a pure CO or pure CO + N₂ gas does *not* show a rapid rate of carburization.

Dilution. The CO₂:CO curves in Fig. 24*a* are modified when, instead of the pure-gas pair, N₂ is present as a diluent. The effect of such dilution was shown in Fig. 24*c* from Turin.²⁴

The behavior of any CO:CO₂ mixture, diluted only with N₂ and free from any other active gases, can be predicted from Figs. 21 and 24 for steel of any C content at any heat-treating temperature; and, were the commercial gases pure, controlling such an atmosphere would be simple. Figures 21 and 24 relate to stagnant gases. Varying rates of flow, especially at exposure times too short to reach true equilibrium, will somewhat modify the results, but the general relations are quite accurately shown by the curves.

Dry Hydrogen. An atmosphere that is very nearly neutral, but expensive, is cracked anhydrous NH₃. This is the only commercial atmosphere suitable for bright annealing of 18:8 stainless or other steels high in Cr, since the high-Cr steels react with CO.

Figure 44 shows the behavior of the 75 H₂, 25 N₂ atmosphere produced by cracking NH₃. The method of obtaining the curves is explained on p. 128.

As with CO, dilution with N₂ decreases the activity of H₂.

Wet Hydrogen. The pure H₂:H₂O gas pair is seldom intentionally met in practice, for, when H₂ is used as a protective gas, it is usually derived from anhydrous NH₃. Hence, no O₂ is present to form H₂O, unless by infiltration of air into the furnace chamber. As it was pointed out, pure CO and CO–N₂ mixtures are less reactive than would be expected; that is, they are not strong carburizers. Neither is pure dry H₂ strongly decarburizing. But commercial gases are not pure; moisture, that is, water vapor, is present unless the gas has been specially dried to remove it. Even dry H₂ is somewhat

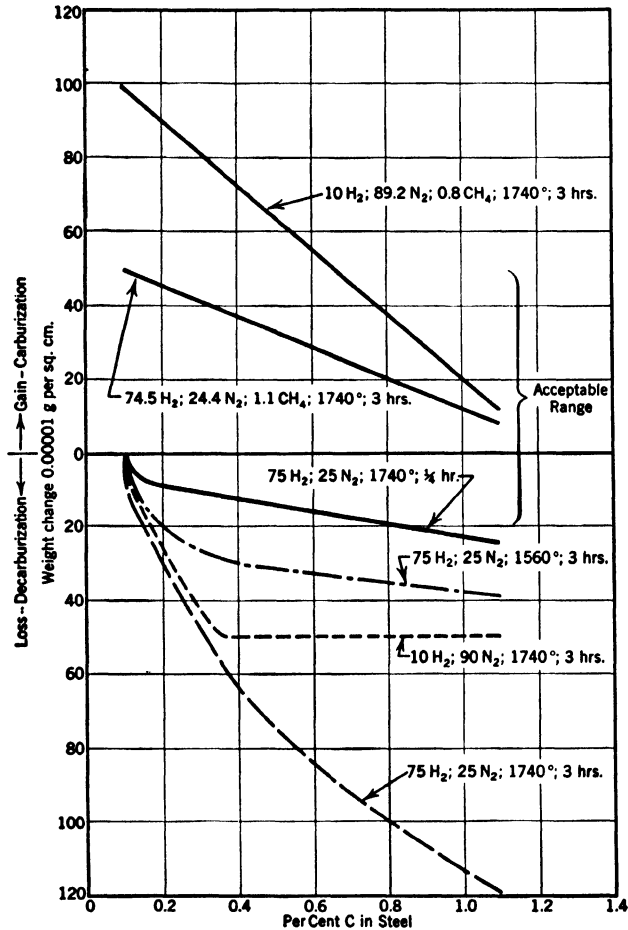

FIG. 44. Effect of dry hydrogen, in varying dilution, at various temperatures and for various times. The curve for 10 H₂, 90% N₂ at 1740°, 1 hr, is not plotted, since it falls practically on the zero line. The 75 H₂, 25% N₂ gas was cracked anhydrous ammonia. This shows that dry H₂ is decarburizing, but that decarburization is less at the time, the temperature, the percentage of H₂, or the C content of the steel is decreased. The samples were not stained. The upper curves show that the decarburizing tendency can be counterbalanced by addition of CH₄. By using some definite, still smaller amount of CH₄ the gas could be made neutral to steel of any C content. (Slower and Gonsler²⁵)

decarburizing, and the reaction $\text{Fe}_3\text{C} + 2\text{H}_2 \rightleftharpoons \text{Fe} + \text{CH}_4$ is accelerated and forced to the right by presence of H_2O . See Fig. 45.

In respect to scaling, H_2 may carry considerable H_2O at high temperatures and still be nonoxidizing; but, as the temperature drops, the tolerance for H_2O decreases. This is shown by curve A in Fig. 24a after Stansel,²⁶ and, at still lower temperatures, in Figs. 21 and 24b

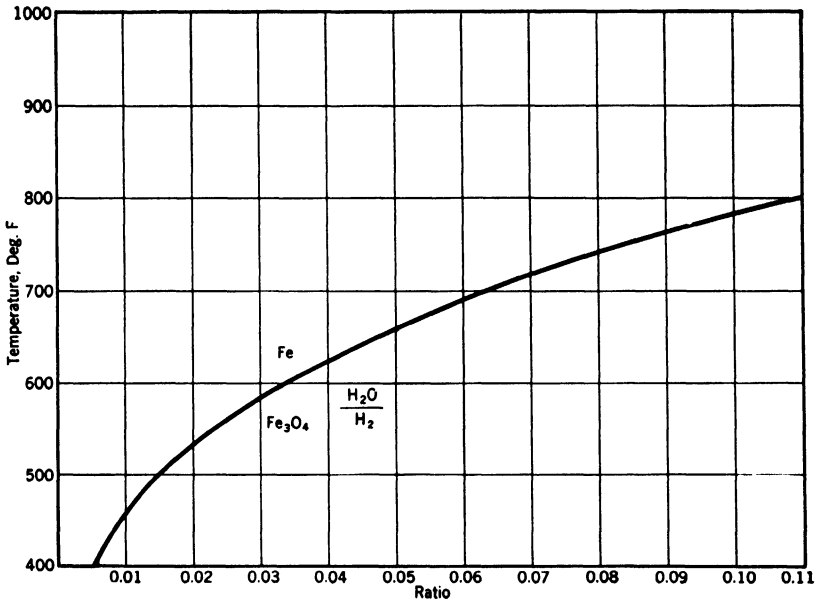

FIG. 45. Ratios of $\text{H}_2\text{O}:\text{H}_2$ lying below the curve will scale or stain steel at the temperatures shown. Ratios above the curve will not stain, though decarburization will occur. (After Schenck²⁷)

after Schenck.²⁷ This behavior is of commercial importance in bright annealing, when the steel has to be cooled down in the protective gas until it can be taken out in the air without danger of oxidation. In cooling steel that has been annealed or normalized in an atmosphere of H_2 , a $\text{H}_2\text{O}:\text{H}_2$ ratio of 1:200, will produce staining at 400° if sufficient time is given; and, from experience with temper colors, we know that steel must be cooled to about this temperature before it can be exposed to the air without oxidation.

Hence, unless the steel can be quenched while still in the protective gas, moisture has to be carefully avoided during the cooling period, if all traces of staining are to be avoided. Thum²⁸ takes 1:20 as the limiting ratio in practice for bright annealing; that is, in a gas with

10% H_2 not more than 0.5% H_2O can be tolerated. To reach that H_2O content by cooling a moist gas, it must be cooled below freezing, as is shown in Fig. 43; that is, drying by activated alumina would be required rather than spray cooling.

Experimental Decarburization by Simple Gases. Experimental evidence on the behavior of some of the simple gases in relation to decarburization on heating for hardening is available from the work of Slowter and Gonser.²⁵ In this work the gas in question was passed over a series of steels ranging in C content from about 0.05 to 1.10%, usually for a period of 3 hr at 1740°, and the steels were allowed to cool in the gas. The lower C steels were located at the gas inlet. The gas composition is affected by the presence of a steel of a C content with which the gas is not in equilibrium; but, since the steel surface exposed was small and the gas was passed through in a steady stream, the results, although somewhat modified by the presence of steels of more than one C content, will serve as a first approximation. The temperature used was higher and the time much longer than would be the case in most actual heating for hardening, in order to accentuate the tendencies of the gas toward carburization and decarburization. In instances where no staining occurred, the gain or loss of weight of the specimens is wholly due to carburization or decarburization. When staining did occur, in an active gas, the oxide coating was ordinarily of negligible weight compared to the weight change from gain or loss of C. Hence, weight changes may be taken as the measure of carburization or decarburization.

Assumption as to Acceptable Range. By microscopic examination it was found that it required a weight increase of 0.00010 g per square centimeter to produce detectable carburization or an equal loss for detectable decarburization, the weight changes being more sensitive than the microscope. It is calculated that a weight change of ± 0.00020 g per square centimeter in the 3-hr test would correspond to an entirely negligible action in the shorter time of ordinary heating for hardening. In a full spheroidizing anneal the time might be much longer, but the temperature would be much lower, so that one would expect that an atmosphere that produced only ± 0.00020 change in the test would probably serve for spheroidizing. However, if the data are to be applied to a much longer exposure at the test temperature, as might occur in the case of heavy die blocks, one might consider that a change of ± 0.00005 to 0.00010 would indicate detectable carburization or decarburization. The curves here shown are average ones, to indicate trends, without individual points being plotted. It is

seldom necessary to quench steels of less than 0.20% C. Since a small amount of carburization can ordinarily be borne, a gas that shows less than +50 or -20 units weight change on steels of 0.20% C or over might ordinarily be considered satisfactory for commercial hardening of such steels as give results in this test within that range.

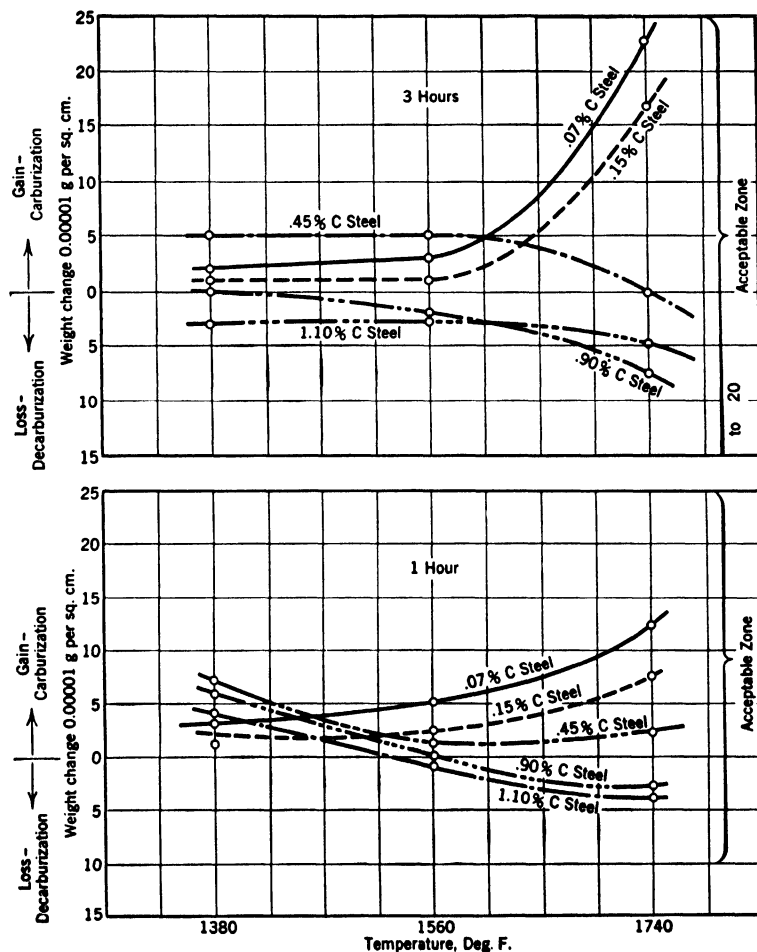

FIG. 46. Effect of dry 34 CO, 66% N₂ gas on steels of various C contents for 3 hr and 1 hr. In the absence of CO₂ or H₂O the carburizing and decarburizing effects of CO are very small. The samples were not stained. In the lower graph the "acceptable range" has been halved because of the shorter time. (Koebel²⁹)

Effects of Time and Temperature. The effects of changes in testing time, temperature, etc., are brought out in Fig. 44 which shows

that H_2 has a decarburizing action, decreased as the H_2 is diluted with N_2 , as the temperature is lowered, as the time is decreased, and as the C content of the steel is decreased. The decarburization can be offset and the gas made carburizing by very small additions of CH_4 . Figure 46, from Koebel,²⁹ shows the effects of these variables (other than dilution) with CO free from H_2O or CO_2 and brings out the fact that CO itself is a relatively inert gas, notwithstanding that it is usually considered to be a carburizing gas. Figure 47 shows that the already small effect of the 34 CO:66 N_2 gas is decreased as the dilution by N_2 is increased. The 5 CO:95 N_2 curve lies practically on the zero axis. Such a gas is suitable for steels of any C content, subject to the limitation that steels high in Cr will stain in CO.

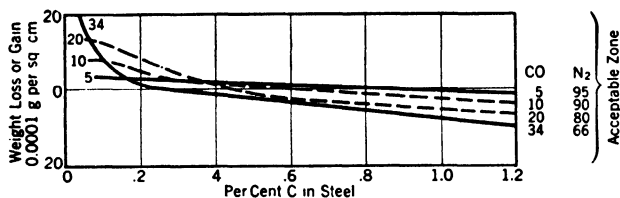

FIG. 47. Action of dry CO in various CO: N_2 ratios. Steels exposed to the gases 3 hr at 1740° . Samples not stained. (Slawter and Gonsler²⁵)

Mixed Gases. Effect of Hydrogen Additions to Carbon Monoxide.

If commercial heating for hardening were carried out in $H_2:CH_4:N_2$ or in $CO:N_2$ without any contamination by other gases, the problem would be simple. The commercial sources of CO usually involve contamination, so that purification may be required. In this connection the effect of mixtures of CO and H_2 may first be considered. Figure 48 shows that the mixture is a more active carburizer to low-C steels than CO alone and a more active decarburizer to high-C steels than H_2 alone. However, suitable additions of CH_4 would serve to make the mixture carburizing, or neutral, as desired, to steel of any one given C content, as is shown later.

Effect of Water Vapor with Hydrogen. A usual contaminant of a commercial gas is water vapor. The effect of moisture in H_2 is brought out in Fig. 49. The presence, with 11.5% H_2 , of 2.6% H_2O , an amount that would be held in the gas at 72° , vastly increased the decarburization. The H_2O reacted with the C of the steel, producing $CO + H_2$. The steel became stained on cooling, though, as Fig. 24 indicates, the gas was not oxidizing at the test temperature. When a large amount of CH_4 was added to H_2 carrying H_2O , in an attempt to oppose the decarburizing action of the wet H_2 , the gas became car-

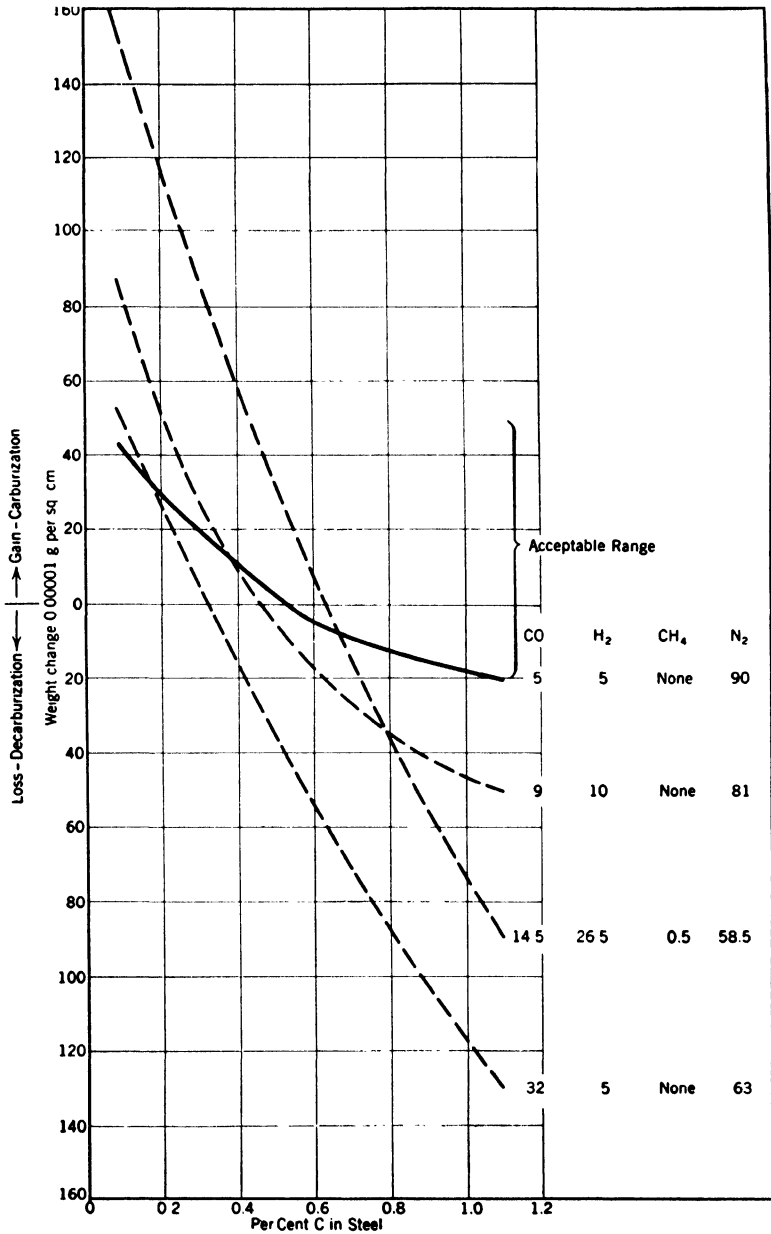

FIG. 48. Effect of dry CO₂-free mixtures of CO, H₂, and N₂ for 3 hr at 1740°. The mixture of CO and H₂ is more strongly carburizing than CO alone, and more strongly decarburizing than H₂ alone. The decarburizing effect can be counteracted, in the dry mixture, by proper addition of CH₄. Samples not stained. (Slower and Gonser²⁵)

burizing to the 0.05% C steel; but its carburization went only to 0.25% C since the gas is neutral to steel of that composition. The H_2O and CH_4 , as well as the C of the steel, reacted, as is shown by the composition of the exit gas. These samples were stained, also.

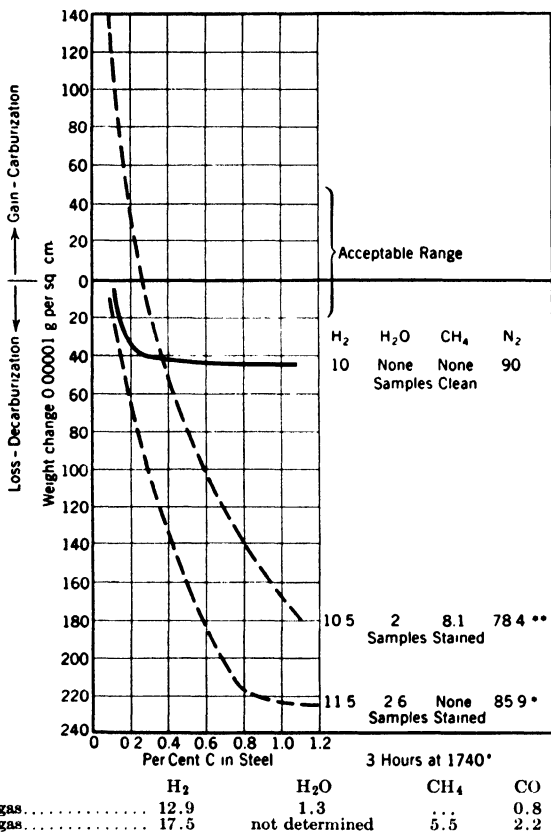

FIG. 49. Effect of dry H_2 , of H_2 with H_2O , and of the addition of a large amount of CH_4 to $H_2 + H_2O$. (Slower and Gonser²⁵)

Sykes³⁰ has studied this problem. He found that at 1650° a gas of 99.5 H_2 , 0.5 CH_4 was neutral to 0.18% C steel, but when 0.6% H_2O was present the CH_4 had to be raised to 2.5% to be neutral to the 0.18% C steel. The balancing of wet H_2 with CH_4 to prevent decarburization of medium- and high-C steel will be a difficult, if not an impossible, task. At temperatures necessary for hardening, the O in H_2O is so reactive that H_2 must be very thoroughly dried in order that the tendency toward decarburization may be kept in

check, and to make the balancing by CH₄ effective. Marshall³¹ considered that CH₄ was inactive, that is, a mere diluent, in his work on bright annealing at 1200°, but CH₄ is not inert at harden-

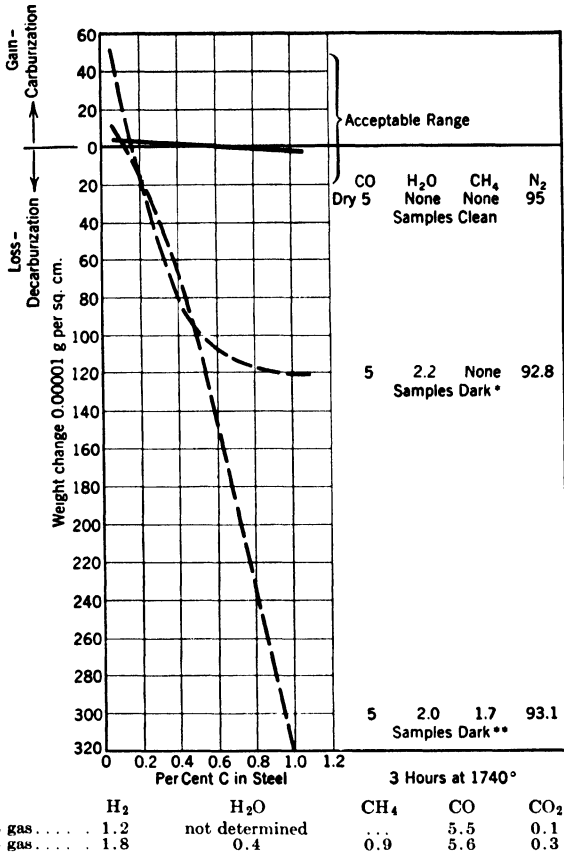

FIG. 50. Effect of H₂O in 5% CO, and of addition of CH₄ to wet CO. (Slower and Gonser²⁵)

ing temperatures. Austin³² has also studied the relations of H₂ and H₂O.

Effect of Water Vapor with Carbon Monoxide. The effect of water vapor with CO is shown, for 5% CO, in Fig. 50. Bad decarburization appeared and, as the exit gas showed, the gas was reactive. On adding CH₄ to the wet CO, the decarburization of the high-C steels was increased instead of decreased. The H₂O reacted with the CH₄ added as well as with the C of the steels.

Whereas a gas higher in CO might not be quite so sensitive to H_2O , it is plain that, to avoid severe decarburization of medium- and high-C steels in heating for quenching, moisture would have to be kept out of the CO: N_2 gases in general.

Effect of Carbon Dioxide. Unpurified commercial gases containing CO almost invariably contain considerable quantities of CO_2 as well. The effect of CO: CO_2 mixtures has been shown in Fig. 22 from which the tolerance of CO for CO_2 may be seen. If we remember that it is the ratio, rather than the absolute percentage, that counts, since, as Fig. 55 shows, a gas of some 30–35% CO must not only be dried but also have its CO_2 removed down to about 0.5%, it appears that one of around 10% CO would need to be freed from CO_2 down to around 0.2% in order to protect medium- and high-C steels from decarburization in heating for hardening. This is getting close to the sensitivity of the usual methods of gas analysis.

With gases low in CO the permissible CO_2 becomes less than “a trace,” because the equilibrium CO: CO_2 ratio must not be exceeded, if the gas is to be truly inactive. Removal of CO_2 by the usual ethanolamine method under commercial conditions of gas purification is likely to be incomplete. Mawhinney⁴ gives 0.3–0.5% CO_2 as often present in commercially purified gases, whether they originally contained 5 or 10% CO_2 . One such gas is 9.5 CO, 0.8 CH_4 , 15.8 H_2 , 73.6 N_2 with 0.3% max CO_2 , dried to a dew point of -60° . The CO_2 :CO ratio is 0.03 which as Fig. 24 shows, is just on the border line at 1525° but on the decarburizing side at lower temperatures. Another is 5.5 CO, 0.1 CH_4 , 7.7 H_2 , 86.4 N_2 , 0.3 max CO_2 , with a ratio a bit above 0.05 which, even considering the larger dilution with N_2 , will certainly decarburize high-C steels at heat-treating temperatures often desired, especially since the presence of H_2 will produce H_2O , with its activating tendency. These cases illustrate how Figs. 21–24 may be used to predict the behavior of a particular gas mixture.

Maintaining a truly neutral condition is a ticklish matter with the gas composition on the border line. Only when the time of exposure is short, is it possible to get away with gases that actually decarburize in attempting “bright hardening.”

Sulphur. Contamination of the protective gas by SO_2 leads to scaling or staining, and S-free fuel gases must be chosen, or elaborate precautions taken to remove even traces of H_2S , mercaptans, or other S-containing constituents from the gas. City gas whose S content is satisfactory for its use as household fuel may be much too high in S to be used as a source of a controlled atmosphere.

Historical Sequence of Controlled Atmosphere Development. As Figs. 23 and 24 show, low-C content and low temperatures, resulting in low-C pressure from the steel, require less C pressure in the gas. Moreover, decarburization of the surface of such low-C steels may not injure them for their intended service. Hence, the application of controlled atmospheres to process annealing and even to normalizing of low-C steels was more for avoidance of scaling or staining than for avoidance of decarburization. Rather cheap "lean" gas atmospheres produced by partial combustion of a fuel gas with only a small deficiency of air, and without much purification, serve for such use.

Indeed, some of the early furnaces led the fuel gas and air into the furnace itself, without prior combustion, but with steels of usual C content for heat treatment, while scaling was avoided, decarburization was much worse than when heating in air, largely because of water vapor produced by burning the H_2 of the fuel gas. Such experiences soon led to preparation of the gas in a separate equipment, and to removal of some of the water vapor by chilling the gas before admitting it to the furnace. However, the water vapor remaining, as well as the high $CO_2:CO$ ratio still made the lean gas decarburizing. "Rich" gas was then produced using a large deficiency of air, and removal of water vapor was accomplished by silica gel or alumina dryers. However, the rich gas contains considerable H_2 and this reacts with CO_2 , producing water vapor when the gas reaches furnace temperature, so that chemical purification from CO_2 became necessary.

In order to reduce the amount of CO_2 that must be removed, the next step was to cut the proportion of air still further, using a mixture very rich in fuel gas, so rich that it will not burn by itself, but must be externally heated. This leaves a few per cent of unburned CH_4 in the gas. Unless such a gas is thoroughly dried and its CO_2 thoroughly removed, it deposits soot in the furnace and has a high "C pressure." Its $CO:CO_2$ ratio is satisfactory, but the CH_4 is too high for neutrality to medium-C steels. The H_2 content is high.

By using suitable catalysts, such gas can be produced with the decomposition of most of the CH_4 , the gas consisting essentially of CO and H_2 . However, with the high H_2 , the CO_2 , produced as the CO is decomposed at the steel surface, reacts to form some H_2O , so this gas is still rather active.

Charcoal Gas. To produce a gas high in CO and low in H_2 , charcoal is burnt with a deficiency of air.

The products of combustion are allowed to pass through a column

of hot charcoal, the initial CO_2 is reduced back to CO , and the moisture in the charcoal and in the air is also reacted with C to form CO and H_2 . This, if carried out at a very high temperature, results in a gas of about 34% CO with 1 to 2% H_2 , which is quite inert, applicable to a steel of wider range of C content than any of the gas mixtures previously mentioned.

Cost. The use of more fuel gas and less air, or of charcoal, and the purification of the products of fuel gas-air combustion render these gases progressively more expensive, in the order named.

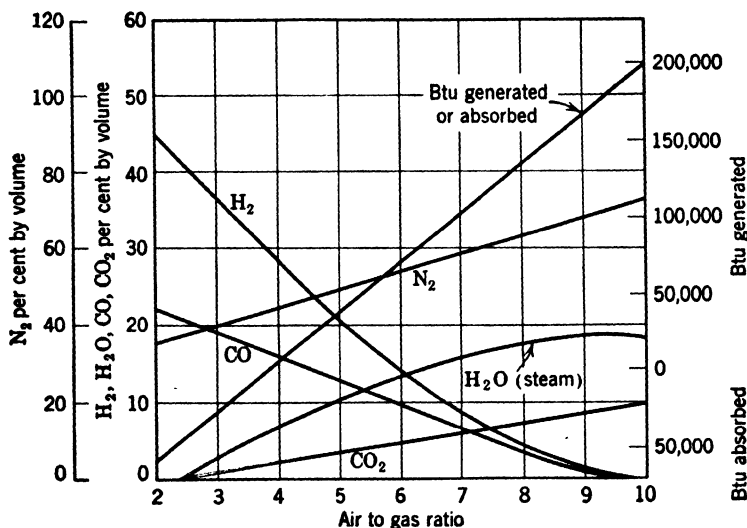

FIG. 51. Analyses of protective atmospheres produced from natural-gas generator at various air-gas ratios. (Hotchkiss and Weber¹⁷)

A relatively cheap gas can be produced by first making a "lean" gas, using only a small deficiency of air, then removing CO_2 and moisture, to give around 97% N_2 with, say, $1\frac{1}{2}\%$ each of CO and H_2 . This gives a tiny content of reducing gas to combat infiltration of air or air adsorbed on the surface of the work, but the margin is small. As Fig. 24 shows, any readily measurable amount of CO_2 will raise the $\text{CO}_2:\text{CO}$ ratio above the proper one. Hence the removal of CO_2 and of H_2O must be extremely complete if the gas is to be really neutral.

The 97% N_2 gas might serve as a good diluent for the more expensive charcoal gas, if a sufficient volume of gas is needed to justify the installation of two different gas-producing outfits.

Generator Gas. The urge, of course, is always for cheaper gas. Air is cheap, and, if its N_2 can be used as a diluent for cheapening the cost, per cubic foot supplied to the furnace, of a richer gas containing the proper gases in the proper ratio, savings result.

Hence, much attention has been paid to making a basic gas by burning all the O_2 of the air with some excess of a fuel gas, in a "generator." At the theoretical ratio of gas to air, the gas would burn completely to CO_2 and H_2O ; as the gas ratio increases, CO and H_2 appear in increasing quantities, CO_2 and H_2O correspondingly decreasing. At a very high gas-air ratio, some unburned CH_4 also appears.

The composition of the gases resulting from partial combustion of natural gas, coke-oven gas, and propane, are shown in Figs. 51-54. It is also possible to burn gasoline, or some of the fuel gases, in an engine.³⁰ By varying the rich-

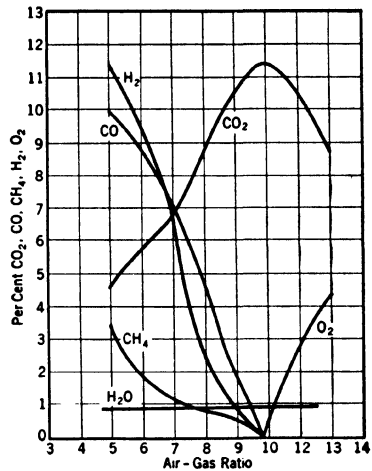

FIG. 52. Effect of variation in air ratio on the products of combustion of natural gas, after cooling to 40° . (Heyn³³)

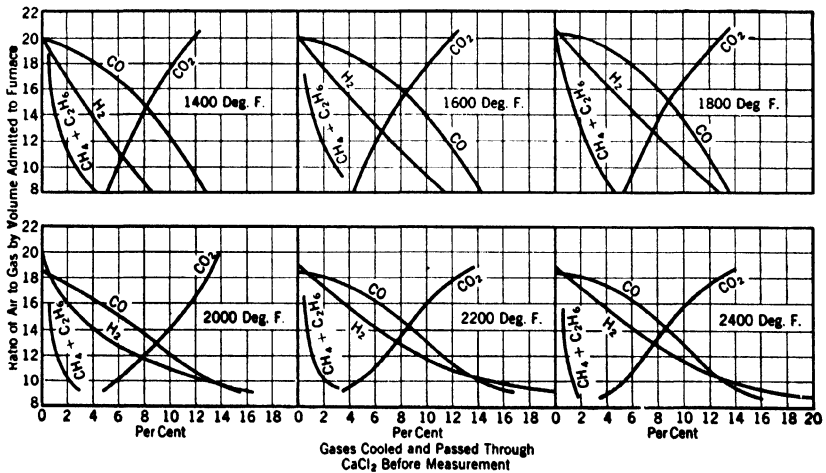

FIG. 53. Change in composition of products of combustion of propane with varying air ratios and temperatures of combustion. (Krogh³⁴)

ness of the mixture, exhaust gases can be produced corresponding to the products of combustion shown in Figs. 51-54.

As Fig. 51 shows, on the rich-gas side, at around a 3 gas:1 air ratio, combustion will not go on in a cold mixture, and external heat must be provided. An Ni catalyst may be used to produce more cracking of CH_4 , at ratios where more CH_4 is produced than is wanted.

The raw burnt gas from a generator always contains far more H_2O and CO_2 than can be endured for bright hardening. Separation or

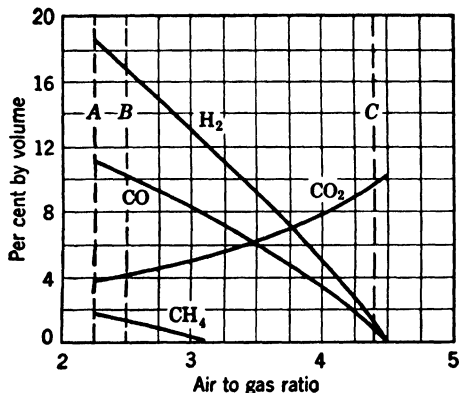

FIG. 54. Gas produced by various ratios of input air to fuel gas (coke-oven gas). *A*—Reducing mixture for brazing and scale-free hardening; flammable. *B*—Reducing mixture for bright annealing or normalizing steel; this mixture is flammable. *C*—Inert mixture for bright annealing copper; nonflammable. (Birdsall³⁵)

absorption of H_2O and some chemical means for removing CO_2 must follow.

The need for this was demonstrated by Gonser and Slowter²⁵ who tried generator gas, undried, dried, and dried with CO_2 completely removed, on a series of C and alloy steels, using three temperatures instead of one, so as to secure data in the neighborhood of the temperature likely to be used in heating the different steels for hardening. Some of their data are given in Table 18.

The generator gas contained 9-10% CO , 9-10% H_2 , 0.5-1% CH_4 , 5% CO_2 , and, if used raw without drying, would also carry more than 15% moisture. The losses or gains in weight tabulated are given in the usual unit of 0.00001 g per square centimeter.

The decrease in the decarburizing tendency with drying and with removal of CO_2 is evident. Steel AA could be bright-normalized in the dry CO_2 -free gas without staining, but not in the presence of the

TABLE 18

	Steel				Undried Generator Gas	Dried Gas	Dried and CO ₂ Removed	Temper- ature, Degrees
AA	0.07 C				+ 17 *	+ 1 *	+ 76 †	1740
G	0.19 C				- 43	- 24	+146	1650
H	0.44 C				- 91	- 4	+ 85	1470
D	0.87 C				-147	- 27	+ 94	1470
E	1.02 C				-389	-366	- 76	1650
S	C	Si	Mn		-104	- 99	+ 23	1650
	0.50	2.00	0.75					
O	C	Cr	V		-134	-105	+ 56	1650
	0.45	0.95	0.18					
J	C	Cr	Al	Mo	+ 48 *	+ 37 *	+ 36 ‡	1740
	0.23	1.58	1.24	0.20				

* Stained.

† Bright.

‡ Not stained, but showed "chromium fog."

moisture or CO₂. A transformer steel of 0.03% C, 4% Si was not carburized at 1650° for 3 hr in any of these atmospheres, but was stained unless the CO₂ was removed. In general the dry CO₂-free gas is carburizing to everything but the very high-C steel. The addition of a little more CH₄ would make it carburizing to that steel at the temperature used. At 1740° the dry CO₂-free gas was faintly carburizing to the high-C steels, steel *D* gained 16 units in 3 hr, and steel *E*, 10 units. Raising the CH₄ to 3.5% increased the carburization on these steels, at 1740° for 3 hr, to 38 and 24 units, respectively.

It is of some interest to note that Si-Mn spring steel, which is very prone to decarburization when heated in air or in flue gas with some free O₂, and is appreciably decarburized in the raw or the dried generator gas, is not decarburized in the dry CO₂-free gas. Also that the Al-Cr-Mo nitriding steel, which, as is mentioned in Chapter 3, must be free from decarburization in order to be satisfactorily nitrated, is mildly carburized at 1740° by the gas in any of the three conditions, as might be expected from its low-C content. These examples indicate that, when protective gases of this type are used, the degree of purification must be fitted to the particular steel and temperature.

Purification and Adjustment of Generator Gas for Hardening. The effect of removing CO₂ is shown in Fig. 55. If the assumption that +50 to -20 units is the acceptable range be correct, it appears that a degree of purification from CO₂ that would represent very

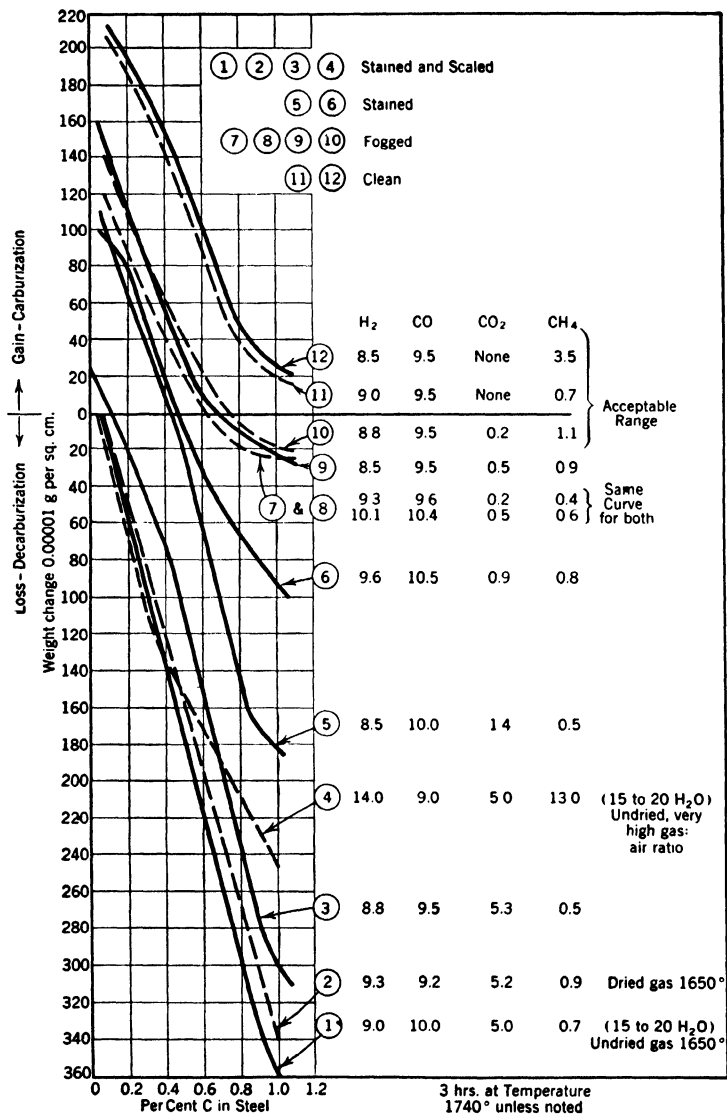

FIG. 55. Effect of drying, of purification from CO₂, and of addition of CH₄, on the behavior of "generator gas." See text for composition of exit gases. (Slower and Gonser^{25, 27})

good commercial practice would be required to make dry generator gas sufficiently neutral for use of very high-C steel.

It will be noted that in the operation of the generator at the given setting for the natural gas-air ratio used, the unburnt CH_4 varies from about 0.5 to 1%, and the variation in CH_4 should not be neglected. To find whether a generator gas from which CO_2 had been incompletely removed could be compensated by adding CH_4 , Gonser and Slowter³⁷ made the experiments shown in Fig. 55 which indicate that, with a gas of 10% CO , and 10% H_2 , the CO_2 should be removed down to about 0.2% and the CH_4 held at about 1% in order to make the gas satisfactory for use with steels of more than 40% C. With CO_2 ranging from 0.5 to 2%, the CH_4 content is quite critical. Slight variations materially alter the behavior of the gas. Gonser and Slowter pointed out that with 10 CO , 10 H_2 0.2–0.5% CO_2 , the amount of CH_4 (in volume percentage) required to make the gas neutral to a steel is roughly the same as the percentage of C in the steel. With CO_2 all removed, the CH_4 content is not critical, since, as curves 11 and 12 in Fig. 55 show, 0.7% and 3.5% CH_4 give similar results. An excess would naturally be avoided to prevent deposition of soot.

Active Gases Seek Equilibrium. If the gas is neutral to the steel and if its own components do not react together at the operating temperature, the outlet gas will have the same composition as the inlet gas. Gonser and Slowter found, in tests at 1740°, passing the

TABLE 19

	CO_2	CO	H_2	CH_4
{ In	1.4	10.0	8.5	0.5
{ Out	0.3	11.0	9.1	0.5
{ In	1.0	10.0	9.5	0.9
{ Out	0.3	11.0	10.0	0.9
{ In	1.0	10.0	8.3	0.5
{ Out	0.2	10.5	9.7	0.5
{ In	0.9	10.5	9.6	0.8
{ Out	0.4	10.8	10.1	0.6
{ In	0.5	10.4	10.1	0.6
{ Out	0.2	10.8	10.5	0.7
{ In	0.5	9.5	8.5	0.9
{ Out	0.2	10.1	9.2	0.9
{ In	0.2	9.6	9.3	0.4
{ Out	0.2	9.6	9.3	0.4
{ In	0.2	9.5	8.8	1.1
{ Out	0.15	9.6	9.5	0.9
{ In	None	9.5	9.0	0.7
{ Out	None	9.5	9.0	0.7

gas over steels ranging from 0.05 to 1.05% C, that the inlet and outlet gases from generator gas dried, and purified from CO_2 to various degrees, gave results like those shown in Table 19.

It may be noted that with inlet gas ranging from about 1.5 to 0.25% CO_2 the outlet gas runs about 0.25% CO_2 . This is strong evidence that the gas is reactive and seeks to attain an equilibrium. Inlet gas of the equilibrium composition should be more nearly inert to the steel than a gas that is reactive, and it ought to be easier to correct such a gas by regulated CH_4 additions. Leading a prepared gas with active constituents over steel chips of the composition of the work to be treated, and at its temperature, in a separate reaction chamber before it meets the work, or even through a hot steel tube inserted in the furnace, gives the gas some opportunity to reach equilibrium. A scheme of this sort has been mentioned by Lewis.³⁸

Equipment. Rather elaborate equipment is required to produce and purify generator gas and adjust its composition. Commercial outfits have been described by Harris,¹⁶ by Slowter and Gonser,³⁶ and others.^{4, 39} The simple generator in which gas-air ratios are controlled, Fig. 56, is supplemented by cooling equipment to separate some of the H_2O , even when the gas is only used for bright annealing of low-C steels and decarburization can be permitted.

For more complete removal of H_2O , silica gel or activated alumina dryers are used, Fig. 57.

For really complete removal of CO_2 , considerable equipment is needed.⁶¹ In the commercial purification of a gas from CO_2 , it is difficult to obtain complete removal of the CO_2 . Caustic towers, or, more commonly, some amine, like ethanolamine, are used. With the latter, after the solution has absorbed so much CO_2 as to be inefficient in further absorption, the solution is regenerated by boiling. In practice the gas will not be switched from the spent absorber to the fresh one until the last possible minute, whether NaOH or an amine is used, and the removal of CO_2 will, at times, be somewhat incomplete.

A more elaborate, continuous system in which the amine is circulated, the CO_2 being boiled off in one part of the system, the purified amine then cooled and recirculated to the absorbent chamber, ensures constant activity of the absorbent. More absorbent is required in such a system, but the gas is more consistently purified.

Recirculation of Gas. Outlet gas can, of course, be returned to the purification system, its composition adjusted, and the gas reused. Similarly, if the purification system is suitable, and the "generator

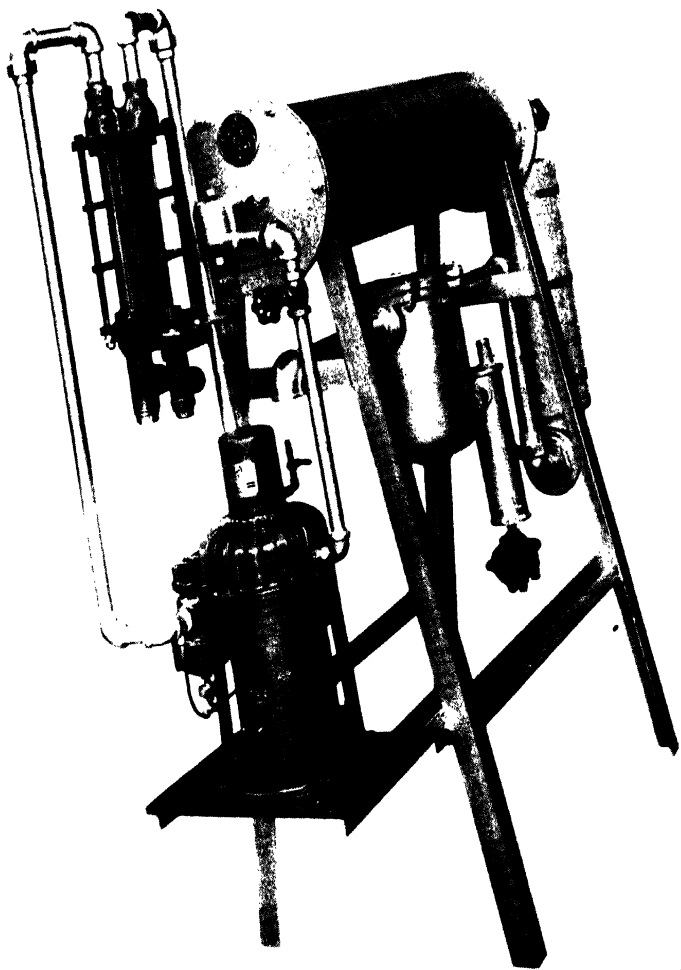

FIG. 56. Small-scale generator equipment in which definite ratios of gas and air are mixed and burned at regulated temperature. The resultant gas is cooled to condense part of the moisture. (Courtesy General Electric Co.)

gas" desired is that resulting from a low gas-air ratio such as will give reasonably efficient heating, flue gas from the heating of the muffle of the controlled-atmosphere furnace can be utilized. Dow⁵⁸

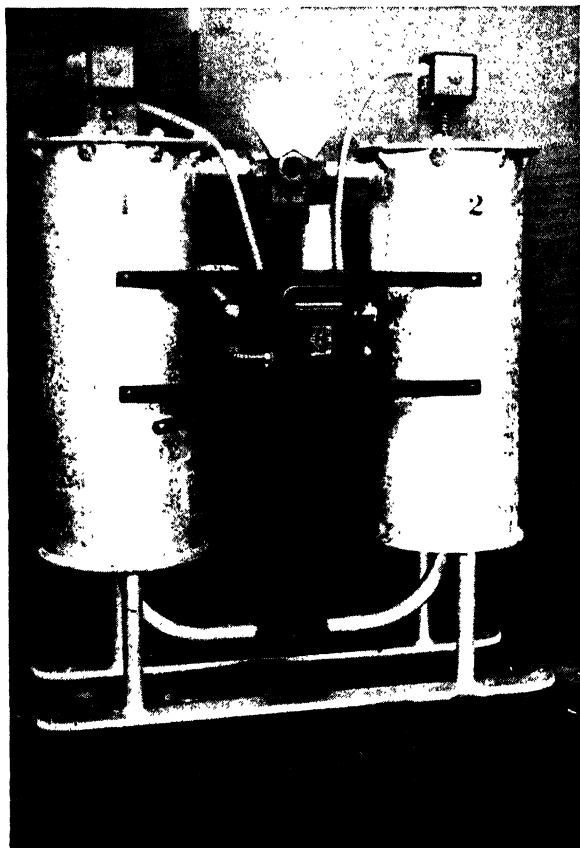

FIG. 57. Activated alumina dryer. Two chambers are filled with activated Al_2O_3 and provided with heating elements. When one chamber becomes so saturated with moisture that it no longer dries the gas properly, the gas is switched to the other chamber and the heating current turned on in the first chamber, to drive out the moisture and prepare the Al_2O_3 for further service in its turn. (Courtesy Pittsburgh Lectrodryer Co.)

cites a large continuous-gas-carburizing furnace in which part of the flue gas is recirculated to the charge, after enrichment with natural gas. Obviously, great care must be taken to avoid an excess of air and consequent presence of free O_2 , and to eliminate excess H_2O . When a neutral rather than a carburizing atmosphere is sought, this

practice would be hazardous. Separate generators are required in that case.

When it is desired to enrich with CH_4 , either this gas or a purified generator gas, mentioned just below, some readily regulated means of controlling the amount of natural gas, benzol, or other hydrocarbon, is also provided.

Charcoal Purification of Generator Gas. The reactions $\text{CO}_2 + \text{C} \rightarrow 2\text{CO}$ and $\text{H}_2\text{O} + \text{C} \rightarrow \text{H}_2 + \text{CO}$ can be used to convert a lean generator gas of, say, $10\frac{1}{2}\%$ CO_2 , $1\frac{1}{2}\%$ CO , 1% H_2 (with H_2O varying according to how it has been dried) into CO , H_2 , N_2 mixtures, which generally run around 20% CO , with H_2 from $1\frac{1}{2}$ to 2% . This "dry" purification requires that a hot charcoal outfit be added to the generator equipment.

Straight Charcoal Gas. Another approach does not start with a fuel gas, but directly with hot charcoal and air. Dry air, passed over

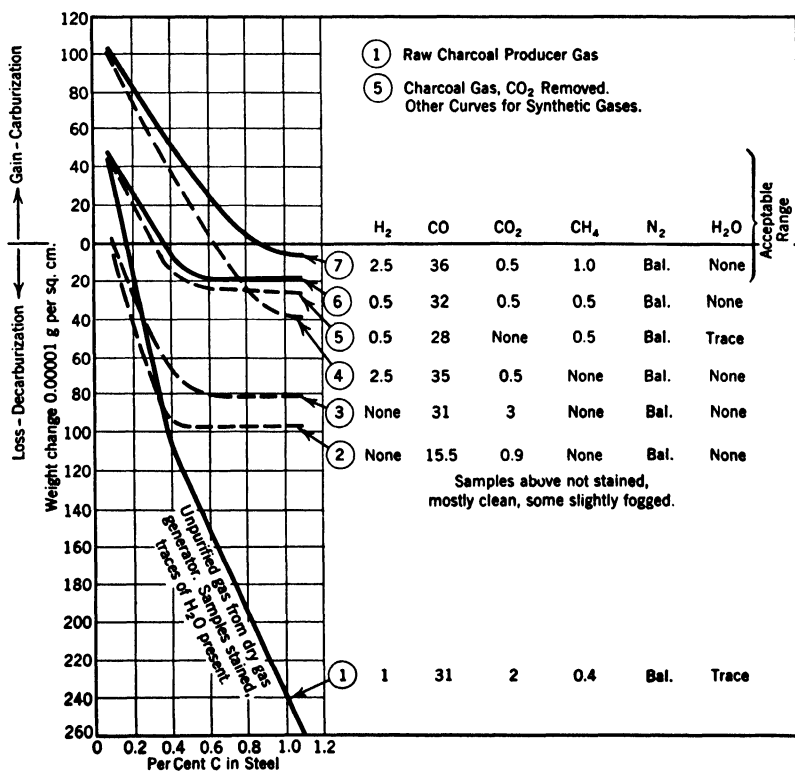

FIG. 58. Charcoal gas. Effect of varying CO_2 , H_2 , and CH_4 in dry $\text{CO}:\text{N}_2$ gas. Samples heated 3 hr at 1740° . (Slower and Gonser^{25, 37})

pure dry charcoal, at a sufficiently high temperature, would produce a gas of about 34% CO, 66% N₂, with only a trace of CO₂. As previously mentioned, this is relatively inert. If the charcoal gen-

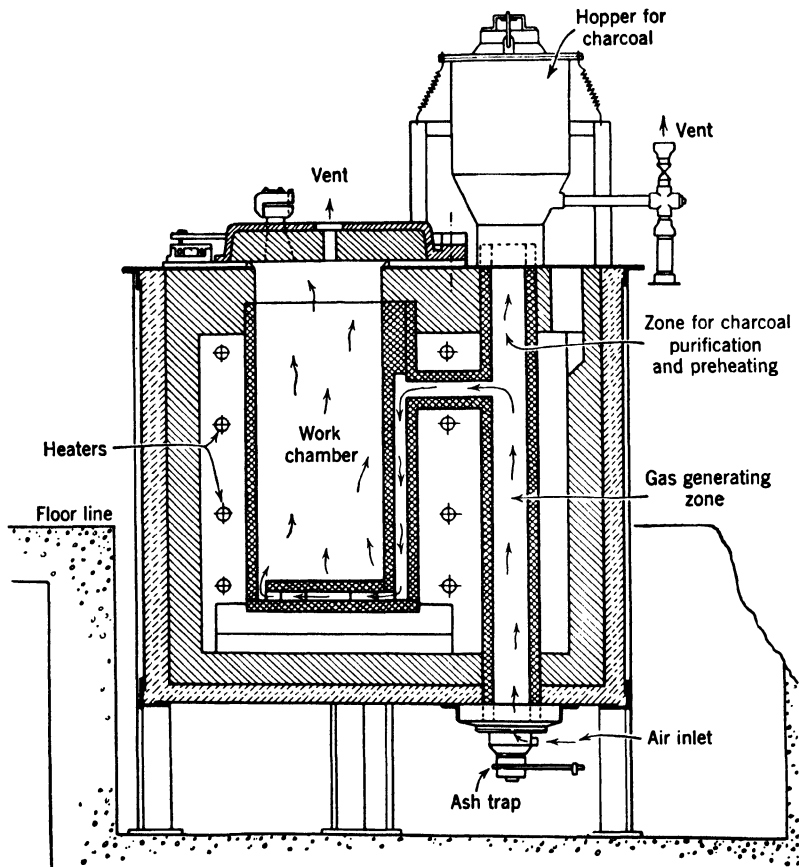

FIG. 59. Diagrammatic cross section of "Char-Mo" furnace (pit-type) for producing protective gas from hot C at the same temperature as subsequent use. (Surface Combustion Corp., Slower and Gonsler³⁶)

erators run at too low a temperature, as was the case with the unpurified gas, curve 1, Fig. 58, the CO₂ may be too high. Moreover, charcoal readily absorbs moisture, and, although, theoretically, the reaction $C + H_2O \rightarrow H_2 + CO$ should go on, and does go on, at a high enough temperature, the H₂O may be released before it can react, and a completely dry gas will not result. Hence, specially

dried charcoal is used and arrangement made to vent off the gas produced at the moment a fresh addition of charcoal is made, Fig. 59.

The difference between the first gas and that made afterward is shown in Table 20. Samples of the muffle gas have shown dew points as low as -25°F .

TABLE 20
EFFECT OF BY-PASSING TREATMENT

Component	Retort at 1550°F		Retort at 2200°F	
	Vent Gas	Muffle Gas	Vent Gas	Muffle Gas
CO_2	3.6	0.7	3.8	0.1
O_2	0.0	0.0	0.0	0.0
CO	28.7	33.1	30.6	34.5
H_2	7.4	2.1	7.7	1.2
CH_4	0.0	0.0	0.0	0.0
N_2	Balance	Balance	Balance	Balance

To lengthen the period between additions of charcoal, propane may be led into the charcoal generator, where it breaks down into soot and H_2 . The soot substitutes for charcoal.

Control Devices and Methods. Because of the necessity for an exact balance of the C pressure of the atmosphere to that of the steel, control must be rigorous. Many different control instruments and devices, described by Slowter and Gonser,⁴⁰ are utilized.

Various methods have been tried for the control of composition of the gas. Ordinary gas analysis is a help, but it tells nothing about H_2O , determination of small amounts of CH_4 is difficult, and differences in CO_2 that may be of moment are not always detectable. Sampling of gas at different locations within a controlled-atmosphere furnace is not so simple as might appear, since the sampling tube may exert a catalytic effect and affect the composition. Water-cooled quartz sampling tubes help to avoid this.⁴¹ Dew-point apparatus, with determinations on the incoming and exit gas, give necessary information on moisture content.

When things go wrong owing to infiltration of air or some other cause, the faulty condition is generally indicated by the composition of the exit gas, and, since too much H_2O usually exists in the exit gas when things go wrong, a dew-point test on the exit gas is a valuable indicator.

Various specific-gravity meters and thermal-conductivity meters have been reported as helpful in maintaining uniformity, but these properties depend on too many factors in a complex-gas mixture for the methods to be universally applicable, though they may be a help.

Gier⁴² developed a useful device, in which the incoming or exit gas is led over an electrically heated low-C wire, which takes up C according to the carburizing power of the gas. After the thin wire has come to equilibrium with the atmosphere, it is cooled, and its electrical resistance is determined, as a measure of its C content. Thus the "C equivalent" of the gas is determined, and, from previous knowledge of the "C equivalent" necessary for neutrality to the particular steel being treated, it can be seen whether the atmosphere is what it is supposed to be, or whether generator trouble, drier trouble, or infiltration of air into the furnace has occurred. For entire accuracy, the wire should be of the same composition as the steel being treated, and its temperature should be the same.

The loss or gain in weight method used in obtaining the data of such figures as 45-48 is considered by Koebel⁵⁷ to be the most accurate, though it is time-consuming for a control method. Surface-hardness measurements are not sensitive enough for the purpose. Cullen⁴⁴ suggests using a coil of fine wire for the weight determination, to give a high surface-to-volume ratio.

Much can be told about the probable behavior of an atmosphere from a full and accurate determination of its chemical composition, including moisture, as is brought out in articles by Austin and Day⁴⁵ and by Harris,⁴⁶ but, as Austin and Day point out, in border-line cases, such as often occur from the urge to make the controlled atmosphere as cheaply as possible, the physicochemical data on which calculations of equilibrium constants are based are not always sufficiently accurate. Moreover, the rate of reaction may be so slow that a theoretically inapplicable atmosphere may serve a practical purpose. Direct experiment is safer than calculation.

Summary of Gas Types. Gases of the general types that have been mentioned previously are made commercially in outfits provided by makers of heat-treating furnaces, each type being designated by various fancy names or by combinations of letters. Representative compositions of the main gas types are given in Table 21. More extended tabulations of this sort are given by Hotchkiss and Webber,⁶¹ Funk and von Ludwig,⁶² and Eeles and Shriner.⁶⁴

Lithium Drying. Claims have been advanced^{47, 64, 65} for the use of lithium (Li) as a drying agent. Mawhinney⁴ cites an astonishing composition, produced from partly burned hydrocarbon gas reacted with lithium vapor, the composition being 8 CO₂, 6 CO, 9 H₂, 77 N₂, the supposition being that Li will prevent reaction of CO₂ by removing all water vapor. How the water-gas reaction between CO₂ and

TABLE 21

	%					
	CO ₂	CO	H ₂	CH ₄	H ₂ O	N ₂
1. "Lean" gas, fuel gas with slight deficiency of air, cooled to 40°. Useless except for nonferrous applications	10½	1½	1	none	0.8	balance
2. Lean gas (freed from CO ₂ and H ₂ O), chiefly N ₂	none *	1½	1½	none	none *	balance
3. Rich gas, fuel gas with greater deficiency of air, cooled to 40°, usable in some low-C steel applications	5	10½	12½	½	0.8	balance
4. Still richer gas, externally heated, a carburizing gas used for short-cycle annealing at 1350-1650°	¼-½	20	35-40	1½-3½	0.1-0.5	balance
5. Same, externally heated with catalyst, CO ₂ removed and gas dried by silica gel or alumina. A less strongly carburizing gas	none or trace	21	38½	¾	none	balance
6. Properly made charcoal gas, nearly neutral to steels of a wide range of C content	none or trace	34	1½	none	none	balance
7. Lean gas, no. 1, passed through hot charcoal	none or trace	20	2	none	none	78
8. Cracked anhydrous NH ₃	none or trace	none	25	none	none	75

* This is important.

H₂ is prevented is unexplained. A mixture with 8 CO₂, 6 CO, and 9% H₂, is scarcely to be considered nonreactive in contact with steel at heat-treating temperatures without better evidence than has yet been presented.

Another peculiar assumption made in the claims for Li is that the alleged reactions, one oxidizing, one reducing, $\text{Li} + \text{H}_2\text{O} \rightarrow \text{LiO} + \text{H}_2$, $\text{Li}_2\text{O} + \text{CO} \rightarrow 2\text{Li} + \text{CO}_2$, occur in the same gas atmosphere, the latter reaction freeing Li to react with more H₂O. One would expect the latter reaction to go in the opposite direction, that is, that

Li would be oxidized by CO_2 , in a gas so high in CO_2 . The case should be similar to that of Zn vapor, which would likewise act as a drying agent.

It is understood that when Li is used as a drying agent, that is, to react with traces of H_2O , more emphasis is being placed on preliminary purification of the gas by conventional methods and less on the alleged miraculous action of Li. If CO_2 is absent, Li will react with moisture and dry the gas.

In earlier attempts to use Li, a different explanation was adduced, namely that Li_2O was formed and not reduced, but settled on the steel, mechanically coating it so as to prevent access of the atmosphere. It would also settle where it was not wanted, for example, on refractories. Use of enough Li to produce such a coating is obviously uneconomical, were there no other drawbacks.

Equipment for Large and Small Shops. The complicated and expensive equipment for large-scale work, that is, as in Fig. 60, and the necessity for precise control make it evident that the selection, installation, and operation of really effective controlled atmosphere are not matters for the novice nor for slapped-together makeshift equipment. A half dozen or more reputable furnace makers are in the market with well-engineered equipment.

Since the fundamentals of the requirements for a non-decarburizing gas became understood, through the work of the authors previously cited in this chapter, and by much unpublished work by furnace makers, the controlled-atmosphere situation has settled down. Efforts to make a cheap or unpurified atmosphere work when it cannot work have been abandoned, and a variety of furnaces, gas-generating and purifying equipment, and control devices have come on the market. The furnace makers have acquired the know-how for instructing users in the practical applications and in meeting plant difficulties. The large shop will naturally draw on this reservoir of experience, especially in selecting the cheapest atmosphere and the best automatic controls for a particular operation which is to be many times repeated. Where great flexibility is required, and where the expense of elaborate equipment cannot be borne, the cost per cubic foot of the atmosphere becomes of less importance. Cracked NH_3 plus regulated admission of CH_4 , which requires only simple equipment, Fig. 61, or a good charcoal gas, also with regulated CH_4 admission as needed, serves the purpose of the smaller shop, and rather simple furnaces outfitted for these gases are on the market.

Some information on investment costs for equipment and on operating costs for production of the different classes of controlled atmospheres is given by Slowter^{36, 48} and by Koebel.⁴³ The outfits are not

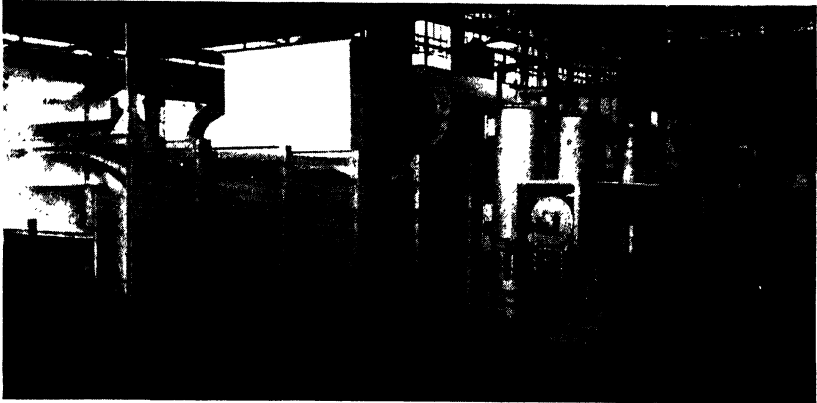

(a)

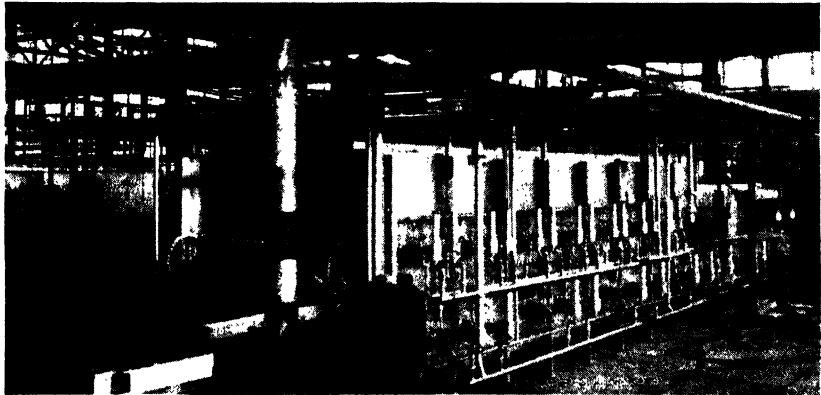

(b)

FIG. 60. Large-scale equipment for regulated combustion of fuel gas and air is shown at the right in *a*. The resulting gas is cooled to separate most of the moisture and led into the furnace. In *b* the other end of the furnace is shown. The furnace is at the Detroit Steel Products Company. (Courtesy Surface Combustion Co.)

cheap. Hence, there is considerable need for techniques by which the advantages of controlled atmospheres can be had for a special job without requiring a special furnace.

Gas from Reaction of Air with Cast-Iron Borings. Steel may be packed in cast-iron borings and heated for quenching without scaling

or appreciable decarburization if conditions are favorable. The O_2 of the air is mostly used up in oxidizing the iron of the borings, the remainder reacts with the graphite and C in the borings, and any moisture in the air has its O combined either with Fe or C and its H freed. The gas reaching the work is then N_2 carrying a little CO and H_2 . The effect of such a gas, prepared outside and led into the furnace chamber, is shown in Fig. 62. The gas from cast-iron borings behaved about like the 10 H_2 :90 N_2 gas of Fig. 49. While the effect

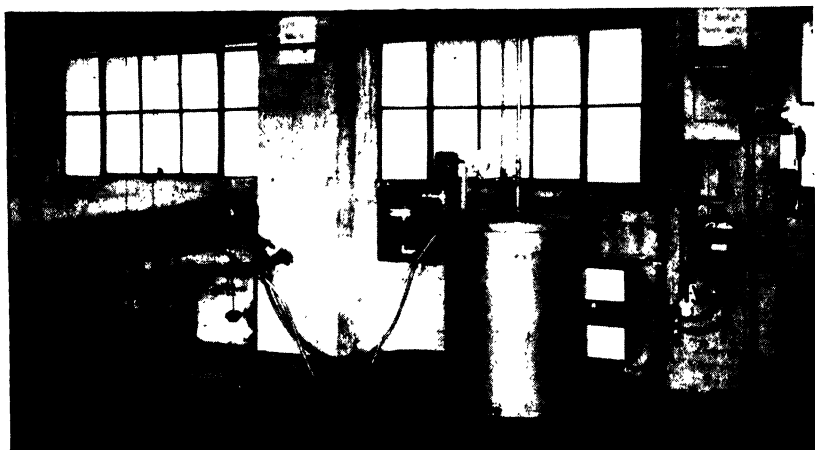

FIG. 61. Equipment for cracking ammonia. Anhydrous ammonia from tanks is led to an electrically heated dissociator in which it is cracked. The apparatus is very simple. (Courtesy General Electric Co.)

is slightly decarburizing, when the conditions are not too exacting, the simple expedient of packing work in cast-iron borings should be helpful. Obviously there is a limit to the reuse of the same chips.

Carbon Blocks. Carbon blocks in proximity to the work in a muffle furnace are commercially used to produce some approach to a pure $CO:N_2$ atmosphere. The contamination with CO_2 will depend on the temperature and the rate of air flow.

Electric furnaces with granular C or graphite resistors or heated by resistors composed of stacks of C plates, operating in air, also tend to produce atmospheres high in CO, and higher than when the C is heated only to the temperature of the work, since the resistors are much hotter, and this raises the ratio of CO to CO_2 . Such furnaces were once in use, but have been practically abandoned.

Koebel⁴⁸ shows that the C block method is applicable to the final high heating of high-speed steels, since this is at a temperature where

the CO:CO₂ ratio is satisfactory, but for high-C plain tool steels, hardened below 1700°, the atmosphere produced by the block is decarburizing.

In handling high-speed steel by this method, the usual preheat before placing in the high-temperature furnace should, according to Koebel, be limited to 1000°, because a preheat at 1350° in air produces some scale and some decarburization, and the preliminary decarburization defeats the purpose of the protective atmosphere of

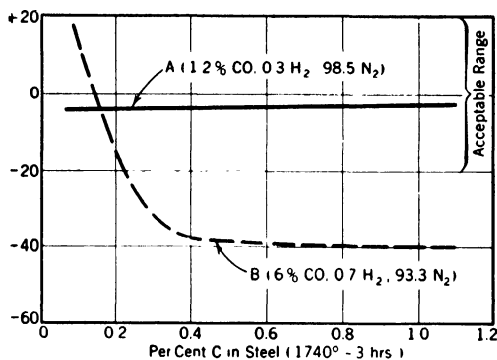

FIG. 62. Effect of gases made to simulate packing in steel or cast-iron chips. *A* was made by passing air over hot steel borings plus a very little C. *B* was made by passing air over cast-iron borings and scrubbing out any CO₂. *B* was slightly more reactive than the 5 CO, 5 H₂ synthetic gas of Fig. 16, perhaps because of S in the cast iron. Samples were bright in both *A* and *B*. (Slower and Gonsler²³)

the final heating. The 1350° preheat can, however, be done in a controlled atmosphere of the type used for plain C tool steels since this temperature is suitable for its application. Then a problem exists in avoiding superficial oxidation while the piece is being transferred from the preheat to the high heat-furnace.

In clean hardening of ordinary steels, when any trace of tarnish needs to be avoided for the sake of appearance or for practical purposes, the problem of avoiding contact with air between the austenitizing furnace and the quench likewise exists. This is often handled in continuous furnaces by furnace design to allow dropping the piece through a protective atmosphere. Buehler⁴⁹ heats aircraft-engine gears in a heat-resistant alloy can with a loose bottom. Can and contents are taken from the austenitizing furnace, trapping the controlled atmosphere. On quenching, the loose bottom slides up to admit the oil.

Gas from Charcoal Packing. Since pure charcoal, coke, or graphite, without energizer, has only a mildly carburizing action on high-C steels, as is shown by the long time necessary to bring the surface C content up above eutectoid composition on steels so carburized, packing in some form of nonactivated C or in sand mixed with C is often employed. Hankins and Becker⁵⁰ have discussed this in some detail in reference to spring steels, and Gill⁶⁶ in reference to tool steels. Grossmann⁵¹ and others point out that, during slow cooling of the charge in packing, decarburization can occur. Curran and Williams⁵² report that 1.15% C steel is strongly decarburized in 4 hr at 1425° and slightly decarburized in 2 hr at 1675° in nonactivated charcoal, but that by the addition of Na₂CO₃ or BaCO₃ the decarburization can be avoided. They suggest adjusting the amount of activating carbonate to make the packing neutral to high-C steels.

The SiC, or FeSi, plus NiCl₂, or CrCl₃, method of controlling C pressure, described by Rosenthal and Manning,⁵³ might be especially applicable to this problem.

Repair of Decarburized Surfaces. Allied to controlled atmospheres, and still more closely allied to gas carburizing, is the restoration of C to box-carburized steels, which have acquired surface decarburization while cooling in the box, see Fig. 28, or to as-received mill stock with decarburization, such as has been discussed on p. 111. Harris¹⁶ suggests gas carburizing to a surface C content suitably above that of the decarburized layer, followed by a diffusion treatment in an atmosphere of suitable C pressure, and shows Fig. 63 as an example.

Cullen⁴⁴ discusses a similar process, but, instead of producing a surface higher in C than the original and then diffusing this C back into the decarburized zone, he uses an atmosphere whose "carbon pressure" is exactly balanced to the C content of the steel, thus straightening out the C-versus-depth curve as shown by Fig. 64. Under such conditions excess time has no effect, once the C gradient has been flattened; hence irregularly decarburized surfaces can be given time enough for the restoration of C at the most deeply decarburized position. He points out that when such an atmosphere (plus sufficient time, which is the joker) is used in the hardening furnace, different lots having different degrees of decarburization come out uniform. He suggests that steel makers might well repair the decarburization on their mill products in this way and supply the trade with stock free from "soft bark."

That such repair of a decarburized surface must improve it is obvious. In theory, such repair can bring the endurance limit, ruined by decarburization, back to an approximation of its proper value. However, as Hankins, Becker, and Mills⁶⁰ found for springs, and as has been corroborated by other work,⁶⁰ the repair by carburizing or cyaniding of a decarburized surface often proves disappointing; the

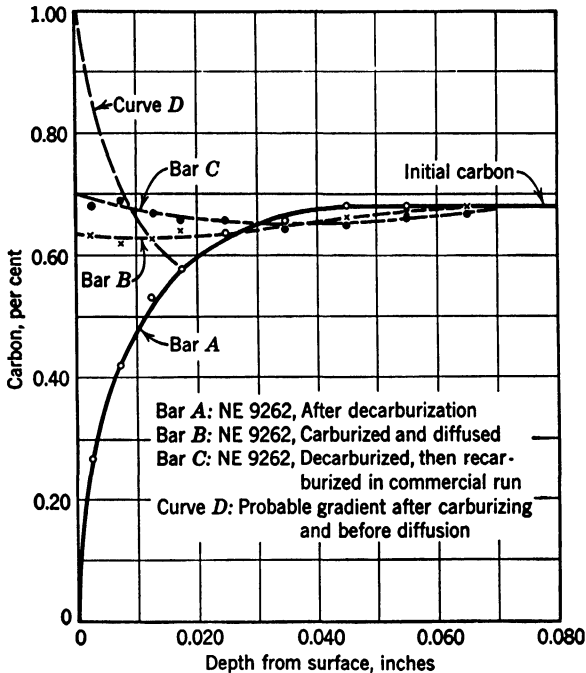

FIG. 63. Carbon-penetration gradients after test runs and a commercial run to restore carbon to decarburized plate of 9262 steel.

method cannot be considered as a cure-all for repair of a decarburized surface, especially when there is irregular depth of decarburization.

Copper Brazing. If two clean steel surfaces are fitted rather closely together, Cu is applied close to this joint, and it is heated above its melting point in a reducing atmosphere, the molten Cu shows remarkable fluidity, flowing into the joint by capillary attraction.^{55, 62} On freezing, the Cu joins the assembly. In a sufficiently reducing atmosphere the atmosphere serves to clean the steel surface so that no flux is required. Many assemblies to be Cu-brazed are soft steel stampings or other parts on which decarburization is no

drawback for their intended use; so it is often not necessary to worry about decarburization, and extreme purification of the gas mixture is not needed. Gas No. 3 of Table 21 might serve in such cases. If decarburization needs to be avoided, the atmosphere is chosen to fit the C content of the steel used, the tendency being to use a gas mixture rather high in H_2 . Cracked NH_3 is suitable, but cheaper gases are used in large production.

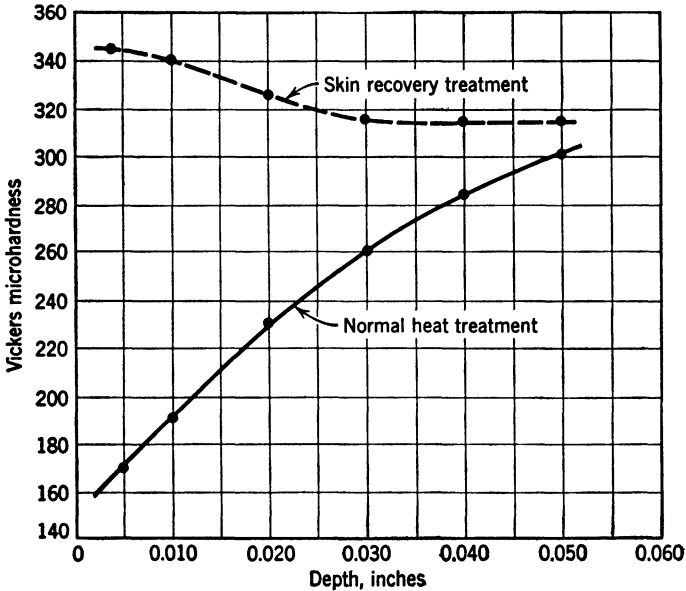

FIG. 64. Hardness versus depth readings on 4140 steel forgings before and after skin recovery.

The high temperature required to melt Cu results in complete annealing of the steel parts being brazed.

Summary. Bright Annealing. Bright annealing of low-C steels at 1200–1250° can be accomplished in a variety of atmospheres. The cheap generator gas from partial combustion of a fuel gas with a deficiency of air serves, if it is correctly dried and does not contain any free O_2 , or more than half as much CO_2 as CO , since the H_2O -forming reaction of H_2 or CH_4 with CO_2 is not active at this temperature. A higher $CO:CO_2$ ratio is better to aim at, since fluctuations of gas pressure to the generator or slight changes in the generator temperature may alter the ratio, and it is better to start with some leeway. Troubles with bright annealing are generally due to

incorrect drying, or to too high CO_2 in the entrance gas, or to infiltration of air into the furnace. If the inlet and exit gases are not only analyzed but *also* checked for moisture content, which is simple with the dew-point meter, the source of trouble should be easily traced. Operators are often inexcusably ignorant of the composition of the exit gas.

A small amount of water vapor, that in equilibrium with the gas at the temperature used, is desirable. If that tiny amount is not present, the reactions $2\text{CO} \rightarrow \text{CO}_2 + \text{C}$, and $\text{H}_2 + \text{CO}_2 \rightarrow \text{CO} + \text{H}_2\text{O}$ will be catalyzed at the surface of the steel, and, although no staining may occur, the steel will become slightly dulled or etched to a matte surface, as Marshall³¹ and Otis⁵⁴ have pointed out. This need for a trace of moisture at the annealing temperature is opposed by the necessity of avoiding an excess of moisture during the cooling period, so that a very close balance is necessary as to H_2O content of the gas.

Bright Normalizing. Bright normalizing of low-C steels at 1770–1750° requires that the gas shall be initially dry and also sufficiently low in CO_2 so that H_2O , beyond that which can be balanced by the H_2 present, will not be formed by reaction of CO_2 with H_2 or CH_4 . The tolerance for H_2O depends on the rate of cooling of the steel, since the staining occurs during cooling, and the steel may come out clean if cooled too fast for the reaction to produce a visible stain, even in an atmosphere that would stain on slow cooling. Removal of CO_2 from the gas would make bright normalizing more fool-proof.

Spheroidization. A long spheroidizing anneal of medium- or high-C steel in which decarburization is to be avoided is conveniently carried out in a suitably balanced $\text{H}_2:\text{CH}_4:\text{N}_2$ that is thoroughly dry. Exact information as to the behavior of generator gas in this service is lacking. Such gas must certainly be thoroughly dried, but the tolerance for CO_2 at these times and temperatures is not well established for gases containing H_2 as well as CO . Since carburization goes on so slowly at these temperatures, gases of the strongly carburizing type would be relatively inert. It would appear safer to remove CO_2 from generator gas for this service.

Hardening Without Decarburization. Heating medium- and high-C steels for hardening without decarburization requires careful choice of gas, the choice being the more limited the higher the C. Thorough drying of any gas is essential; moisture must be kept out. In order to remove the opportunity for H_2O formation in the furnace itself, CO_2 must likewise be kept out, or held to a low value in relation to

the CO, in order to prevent the reaction $\text{CO}_2 + \text{H}_2 \rightarrow \text{CO} + \text{H}_2\text{O}$. Furnace makers now realize that scrubbing out CO_2 from generator gas is as imperative as drying the gas, and CO_2 -scrubbing equipment has had to be provided in installations not originally supplied with it. Severe decarburization has thus been overcome; so there is ample commercial as well as theoretical evidence for the necessity of purifying the gas from CO_2 .

The degree of purification necessary varies with the C content of the steel to be treated and the CO content of the protective gas. Charcoal gas, with its higher CO, does not have to be as completely freed from CO_2 as does generator gas.

Compensation for the decarburizing tendency of $\text{H}_2:\text{N}_2$ or $\text{CO}:\text{H}_2:\text{N}_2$ can be accomplished by small additions of CH_4 . The presence of much CO_2 , however, prevents compensation.

High-Speed Steel. For the high-speed steel preheat, gases suitable for hardening ordinary steel without decarburization are applicable. Slightly carburizing atmospheres for the high heat seem theoretically advisable, but the short time at heat ordinarily requires a batch rather than a continuous conveyor-type furnace, and it is difficult to avoid infiltration of air in charging and discharging. Hence maintenance of sufficiently oxidizing conditions to avoid decarburization is generally adopted and the formation of some scale accepted.

Solid Packings. In small-scale operation, fair protection against decarburization may be secured by packing the work in cast-iron chips.

McMulkin⁵⁹ remarks that cast-iron chips tend to stick to the work, but that this can be avoided if the work is wrapped in common brown wrapping paper. Packing in charcoal, spent carburizer, or active carburizer may also be utilized, with proper regard to temperature of operation and C content of the steel in selecting the packing.

Contamination of Gases. Sulphur-bearing gases should be avoided in choosing a gas for a controlled atmosphere. Moisture or oil on the steel treated will affect the atmosphere and should be removed, or, if feasible, the atmosphere should be adjusted to compensate. Scale or rust on the steel treated, under usual operating conditions, will be reduced in the protective atmospheres, its O_2 forming H_2O or CO_2 . For example, a steel previously normalized in air and scaled but not decarburized, heated for hardening in a controlled atmosphere that would not decarburize clean steel, might produce enough H_2O to cause serious decarburization. Steel should be clean before one should try to handle it in a controlled atmosphere. Some investigators think

that gases adsorbed on the surface of the steel, or even evolved from the body of the steel, play a part, and need to be taken into account in special cases.

Effect on Heat-Resistant Alloys. A factor in over-all cost is the effect of the protective gas on the Ni-Cr and similar alloys used for resistors, radiant tubes, muffles, or conveyor parts in continuous furnaces.⁶⁶ Some atmospheres at some temperatures are deleterious to these alloys. The effect is especially to be avoided in the case of resistors, since, if the gas attack is of a localized type, the resistors will burn out at such a spot. Sulphur is generally considered harmful from this point of view. It is usually held that strongly carburizing gases should be avoided for long life of such alloys, though alloy carburizing boxes are in general use. An oxidizing atmosphere in which a tightly adhering oxide is produced on these alloys would be most suitable from this one standpoint.

The problem is being actively studied but, because of the long life demanded in service, the evaluation by rapid tests of deterioration that is so slow in actual service is a difficult matter.

Collected Information on Controlled Atmospheres. An extended discussion of controlled atmospheres, as well as of carburizing and nitriding, is given by Jenkins⁶⁸ in a book of 532 pages. This is comprehensive, authoritative and well worth study.

BIBLIOGRAPHY

1. C. UPTHEGROVE, Scaling at heat-treating temperatures, *Metal Progress*, V. 23, June 1933, pp. 30-3, 62.
2. W. C. JOMINY, The surface decarburization of steel at heat-treating temperature, *Univ. Michigan, Dept. Eng. Research, Bull.* 18, 1931, 49 pp.
3. A. J. FISHER, Furnace atmosphere, *Iron Steel Engr.*, V. 14, April 1937, pp. 35-43.
4. M. H. MAWHINNEY, *The Heating of Steel*, 1945 ed., Reinhold Pub. Corp., 265 pp.
5. E. O. MATTOCKS, discussion, *Carburizing Symposium*, American Society for Metals, 1936, p. 116.
6. M. J. CONWAY, Furnace pressure and temperature control for side door heating furnaces, *Iron Steel Engr.*, V. 14, April 1937, pp. 30-4.
7. C. E. PECK, Heat treating and controlled atmospheres, *ASM Review*, December 1937, p. 8.
8. J. P. GILL, The modern heat treatment of high-speed steel tools, *Ind. Heating*, V. 4, 1937, pp. 827-34.
9. F. R. PALMER, *Tool Steels Simplified*, Carpenter Steel Co., Reading, Pa., 1937, 316 pp.
10. A. H. d'ARCAMBAL, discussion, *Trans. ASM*, V. 22, 1934, p. 342.

11. A. L. BOEGEHOLD, Plain carbon steel, *Metal Progress*, V. 31, February 1937, pp. 147-52. Advantages of alloy steels, *Ibid.*, V. 31, March 1937, pp. 265-9.
12. *Review of Oxidation and Scaling of Heated Solid Metals*, Department Scientific and Industrial Research, British Government, His Majesty's Stationery Office, London, 1935, 103 pp.
13. T. SENDZIMIR, Process for coating metallic objects with layers of other metals, U. S. Pat. 2,110,893, March 15, 1938.
14. H. S. RAWDON, *Protective Metallic Coatings*, Chemical Catalog Co., New York, 1928, 277 pp.
15. T. N. KEELAN, Strip annealing, *Steel*, V. 102, 1938, January 24, pp. 56-9, February 14, pp. 40-4.
16. F. E. HARRIS, Atmosphere applications, equipment, methods, and process cycles, *Metal Progress*, V. 47, April 1945, pp. 713-23.
17. A. G. HOTCHKISS and H. M. WEBER, *Controlled Atmosphere Symposium*, American Society for Metals, 1942, pp. 57-69.
18. J. A. WEBBER, Furnace atmospheres and decarburization, *Carburizing Symposium*, American Society for Metals, 1936, pp. 89-114.
19. E. G. DECORLIOS, Applying prepared atmospheres to metal processing, *Mech. Eng.*, V. 66, February 1944, pp. 111-14.
20. W. E. JOMINY, discussion, *Carburizing Symposium*, American Society for Metals, 1938, p. 118.
21. A. BRAMLEY and K. F. ALLEN, The loss of carbon from iron and steel when heated in decarburizing gases, *Engineering*, V. 113, 1922, pp. 92-4, 123-5, 229-31, 305-06.
22. D. L. MARTIN and F. E. WILEY, Induction hardening of plain carbon steels, *Trans. ASM*, V. 34, 1945, pp. 351-96.
23. E. E. SLOWTER and B. W. GONSER, Comparative effects of controlled atmospheres on alloy and carbon steels, *Metals & Alloys*, V. 9, 1938, pp. 33-9, 59-62.
24. J. J. TURIN, discussion, *Carburizing Symposium*, American Society for Metals, 1938, pp. 9-13.
25. E. E. SLOWTER and B. W. GONSER, An experimental study of gases for controlled atmospheres, *Metals & Alloys*, V. 8, 1937, pp. 159-68, 195-205.
26. N. R. STANSEL, *Industrial Electric Heating*, John Wiley & Sons, New York, 1933, 444 pp.
27. H. SCHENCK, *Einführung in die physikalische Chemie der Eisenhüttenprozesse*, Berlin, J. Springer, 2 V., 1932-4.
28. E. E. THUM, Preparation of furnace gases for non-oxidizing atmospheres, *Metal Progress*, V. 32, October 1937, pp. 377-82.
29. N. K. KOEBEL, Controlled Atmospheres in Heat Treating Steel, thesis, Ohio State University, Columbus, Ohio, 1936.
30. W. P. SYKES, Carburizing iron by mixture of hydrogen and methane, *Trans. ASST*, V. 12, 1927, pp. 737-58.
31. A. L. MARSHALL, Bright annealing of steel in mixed gas atmospheres, *Trans. ASM*, V. 22, 1934, pp. 605-25.
32. C. R. AUSTIN, A study of the effect of water vapor on the surface decarburization of steel by hydrogen, *Trans. ASM*, V. 22, 1934, pp. 31-58.
33. H. M. HEYN, Atmospheres and furnaces in the wire industry, *Wire & Wire Products*, V. 11, 1936, pp. 507-20.

34. A. E. KROGH, Controlling a controlled atmosphere, *Metals & Alloys*, V. 8, 1937, pp. 47-51, 83-8.
35. G. W. BIRDSALL, Improved protective atmospheres, *Steel*, V. 116, May 21, 1945, pp. 109-10.
36. E. E. SLOWTER and B. W. GONSER, Controlled atmosphere generators, *Metal Progress*, V. 39, May 1941, pp. 560-6, 628.
37. E. E. SLOWTER and B. W. GONSER, Requirements for purification of gases for controlled atmospheres, *Metals & Alloys*, V. 9, 1938, pp. 163-8.
38. H. R. LEWIS, Bright annealing of seamless steel aircraft tubing, *Metals & Alloys*, V. 8, December 1937, pp. 331-4.
39. W. O. OWEN, Design and operation of equipment for the generation of controlled atmospheres for annealing and hardening, *Heat Treating Forging*, V. 23, 1937, pp. 353-4. Also, *Ind. Heating*, V. 4, 1937, pp. 558-60, 1074-6.
40. E. E. SLOWTER and B. W. GONSER, Instruments for control and analysis of controlled atmospheres, *Metal Progress*, V. 38, 1940, pp. 555-69.
41. J. E. WILKEY, discussion, *Trans. ASM*, V. 29, 1941, p. 729.
42. J. R. GIER, A balanced protective atmosphere, its production and control, *Trans. ASM*, V. 29, 1941, pp. 670-92; *Steel*, V. 109, December 22, 1941, pp. 54-6.
43. N. K. KOEBEL, *Industrial Controlled Atmospheres*, booklet, 1941, 71 pp. Reprinted from serial articles in *Iron Age*, V. 146, November 21-December 12, 1940.
44. O. E. CULLEN, Skin recovery for decarburized steel surfaces, *Metals & Alloys*, V. 20, October 1944, pp. 954-8.
45. J. B. AUSTIN and M. J. DAY, Chemical equilibrium as a guide in the control of furnace atmospheres, *Controlled Atmosphere Symposium*, American Society for Metals, 1941, pp. 20-49. Chemical equilibrium and the control of furnace atmospheres, *Ind. Eng. Chem.*, V. 33, January 1941, pp. 23-31.
46. F. E. HARRIS, Reactions between hot steel and furnace atmospheres, *Metal Progress*, January 1945, pp. 84-9. See also J. K. STANLEY, Reactions attendant with carburization-decarburization reactions, paper for Electrochemical Society *Symposium on Surface Reactions*, June 1946.
47. C. E. THOMAS, Principles and practice of lithium heat-treatment atmospheres, *Ind. Heating*, V. 11, 1944, September, p. 1405; November, p. 1810; V. 12, January 1945, p. 42.
48. E. E. SLOWTER, Cost of controlled atmospheres, equipment, instruments, and operating, *Controlled Atmosphere Symposium*, American Society for Metals, 1941, pp. 176-204.
49. J. H. BUEHLER, Heat treating aircraft gears, *Iron Age*, V. 147, June 26, 1941, p. 39.
50. G. O. HANKINS and M. L. BECKER, Effect of surface conditions produced by heat treatment on the fatigue resistance of spring steel, *J. Iron Steel Inst.*, V. 124, 1931, pp. 387-428. G. O. HANKINS, M. C. BECKER, and H. R. MILLS, Further experiments on the effect of surface conditions on the fatigue resistance of steels, *Ibid.*, V. 133, 1936, pp. 399P-419P.
51. M. A. GROSSMANN, Oxygen in steel, *Trans. ASST*, V. 18, 1930, pp. 601-31.
52. J. J. CURRAN and J. H. G. WILLIAMS, Decarburization of high carbon steel in reducing atmospheres, *Ibid.*, V. 14, 1928, pp. 809-30.

53. P. C. ROSENTHAL and G. K. MANNING, Carburized cases of hypoeutectoid carbon content, *Trans. ASM*, V. 39, 1947, pp. 801-15.
54. A. N. OTIS, Protective atmospheres for annealing furnaces in steel mills, *Iron Steel Engr.*, V. 15, February 1938, pp. 34-49.
55. H. C. BOSTWICK, Applications of electric furnaces and controlled atmospheres, *Ind. Heating*, V. 5, 1938, pp. 587-92.
56. E. E. THUM, Damage to muffles by controlled atmospheres, *Metal Progress*, V. 33, March 1938, pp. 277-80.
57. N. K. KOEBEL, Methods for determining the degree of carburization or decarburization and evaluating controlled atmospheres, *Controlled Atmosphere Symposium*, American Society for Metals, 1941, pp. 128-55.
58. J. A. DOW, discussion, *Carburizing Symposium*, American Society for Metals, 1938, pp. 115-16, 310.
59. F. J. McMULKIN, Practical tool room heat treatment, *Iron Age*, V. 157, June 13, 1946, p. 56.
60. O. J. HORGES and C. H. LIPSON, Automotive rear axles and means of improving their fatigue resistance, preprint 29 for 1946 American Society for Testing Materials meeting, 22 pp.
61. A. G. HOTCHKISS and H. M. WEBER, A new heat-treating atmosphere producer, *Iron Age*, V. 158, November 21, 1946, pp. 48-55.
62. Copper brazing intricate parts, staff article, *Steel*, V. 119, November 4, 1946, pp. 108-10.
63. E. J. FUNK, JR., and D. VON LUDWIG, A critical survey of controlled atmospheres, *Iron Age*, V. 158, 1946, September 19, pp. 42-7; September 26, pp. 74-8.
64. C. C. EELES and M. E. SHRINER, Prepared atmospheres, *Steel*, V. 119, December 2, 1946, pp. 110-13, 154-6.
65. R. S. BURPO, Some users' experience with lithium atmospheres, *Materials & Methods*, V. 24, September 1946, pp. 622-5.
66. J. P. GILL and collaborators, *Tool Steels*, 1944, American Society for Metals, p. 213.
67. E. J. SEABOLD, Continuous strip annealing, *Iron Steel Engr.*, V. 23, December 1946, pp. 74-86.
68. I. JENKINS, *Controlled Atmospheres for the Heat Treatment of Metals*, 1946, Chapman & Hall, London, 532 pp.

CHAPTER 7

FUSED BATHS

One way of avoiding the reaction between the steel surface and the surrounding atmosphere is not to have any atmosphere, that is, to heat in a fused bath, such as molten lead or molten salt. Rapid heating from all sides is accomplished. When cold or cool metal is plunged into such a bath, the bath freezes about the piece and then melts, thermal shock being thus minimized. If the bath is stirred, or automatically kept in motion by convection currents, heat transfer is rapid.

When a constant temperature is to be maintained, as in austempering and martempering, the heat storage of a fused bath makes control easier than in a gaseous atmosphere.

Molten Lead and Fusible Alloys. Molten lead can be used as a heating medium from about 650° to perhaps 1700°. In rare cases it is used at even higher temperatures. The higher temperatures involve danger of lead poisoning from lead or lead oxide fumes. Since lead is heavier than steel, the steel has to be held beneath the lead by some means, as by wiring it to a rod and clamping the rod in position. Since there is no "atmosphere" present, and clean pure lead does not alloy with or attack steel, there is neither scaling nor decarburization within the bath. In order to prevent oxidation of the lead, the bath is covered with charcoal or similar reducing agent. Dirty lead will both cling to the work and decarburize it. At high operating temperatures the work may oxidize in the air during transfer to the quenching bath, or, of course, on air cooling, so that, to avoid all scale or tarnish, transfer or cooling might be done in a controlled atmosphere.

Rate of Heating. Beside the freedom from atmospheric attack, lead and other fused baths have the advantage of much more rapid heating than is the case when the same object is heated by radiation. In radiation heating, the side of the object that "looks away" from the source of heat, or a part that is shaded from direct radiation, has

to be heated by conduction from the more highly heated portions of the object or by slow conduction from the furnace atmosphere. In the lead bath all sides of the object are heated simultaneously, and, since the thermal conductivity of lead is high, the bath may be kept

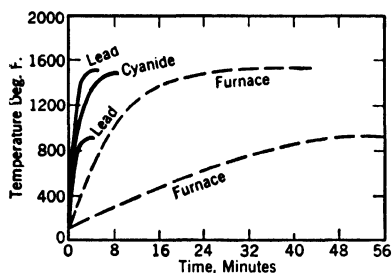

FIG 65. Relative rates of heating of steel in lead, in cyanide, and in an ordinary furnace. (After *ASM Handbook*)

at the temperature to which the steel is to be heated and sufficient heat transmitted through the lead to maintain it at that temperature without being strongly cooled locally by the insertion of the cold steel (see Fig. 65).

The uniformity of heating in lead allows irregular objects to be heated more rapidly without cracking or without overheating thin edges than is the case in an ordinary furnace.

Fusible Alloys. Lower temperatures than 650° can be had in fused-metal baths of lead and tin, or in the very low melting "fusible-alloy" baths. The lead-tin baths, approaching the ternary plate coating composition or even the composition of solder, are much more likely to "wet" the steel and adhere to it than pure lead. The lower the temperature of the lead bath, the less fluid it is and the more likely to show some adhesion to the metal. Dipping the steel in brine and heating so as to cover it with a film of salt as the water evaporates, or coating with some wash to prevent adhesion, has been practiced but is a dangerous procedure since the steel must be absolutely dry when immersed in the bath to avoid spattering. Adhering lead may be removed by dipping in fused caustic soda (NaOH).

Unfortunately, neither fused lead nor fused salts of suitable melting points are truly neutral after a brief period of use. Lead oxidizes readily and soon becomes not Pb but Pb plus PbO. The PbO will tarnish steel, or even produce scale (Figs. 96 and 97). Care must therefore be taken to keep the Pb bath well reduced. Because of the melting point of Pb and of its volatility at very high temperatures there is both a lower and an upper limit to the use of Pb.

Wood charcoal, reactive at low temperature, is useful for covering the surface of a Pb bath for low-temperature tempering. At austenitizing temperatures, petroleum coke or a carburizing compound serves as cover. A layer of fused salt may be kept over the Pb,

cyaniding salt baths or mixtures of Na and K carbonates plus salt ordinarily being used. Oxidizing salts are, of course, avoided. The fused salt layer protects the Pb and keeps the work clean, but applies a salt coating as the work is withdrawn. Ample ventilation is needed over a Pb bath operated at high temperature to avoid danger from Pb poisoning.

Lead baths have long been used in patenting wire, as mentioned in Vol. I.

Lorig¹ has suggested the use of molten cast iron as a high-temperature "pickle" for removing scale or dissolving away a decarburized skin, for example, on billets for rolling or bars for forging.

Fused Salts. Fused salt mixtures are frequently resorted to in place of lead. For the lowest temperatures, mixtures of nitrates and nitrites are used, but since these are strongly oxidizing they can be applied only at very low temperatures, as in mild tempering operations.

These oxidizing baths must not be allowed to have contact with carbonaceous materials, such as oil, grease, or cyanide, as an explosive reaction results.

For higher temperatures, comparable to those at which controlled atmospheres are used, the baths are chiefly made up of carbonates or chlorides, or mixtures of the two.

Decarburization. Pure Na_2CO_3 , melting at about 1560° , has been suggested for combined cleaning and annealing.² Such baths, without other additions, soon become decarburizing, and some of them dissolve some Fe from the steel, thus becoming contaminated.

Just as the more or less neutral controlled atmospheres are given additions to put them on the carburizing side, to offset slight infiltration of air, so the salt mixtures, more or less neutral at the start, are given carburizing additions to offset the decarburizing tendencies produced by operating the baths in contact with air. Cyanide additions are most frequently used, and so the fused salt baths that substitute for controlled atmospheres can be considered as a branch of the liquid carburizers, with low "C pressure."

A good description of the higher temperature salt baths in general is given by Stewart,³ whose article should be consulted for many details on rectification, plain steel pots, alloy pots, and ceramic pots.

Mixtures of sodium, calcium, or barium fluorides (NaF , CaF_2 , BaF_2) with borax are also used as high-temperature baths. MacNerland¹⁰ suggests fused boric acid for high-speed steel. The fused

TABLE 22
COMPOSITIONS FOR VARIOUS TEMPERATURES

<p>Low-temperature baths for tempering or isothermal treatment. 300–1100° nitrate–nitrite KNO₃, NaNO₂, and nitrate–nitrate KNO₃–NaNO₃, 500–1150°</p>	<p>Nitrate mixtures (NaNO₃–KNO₃) with nitrite (NaNO₂) for the very lowest temperatures. Oxidizing, and strongly so at the highest temperature. Keep all organic matter, including cyanides, out.</p>
<p>Medium temperature, 650–1700° Fused Pb</p>	<p>Fused Pb. Poisonous fumes given off at the high-temperature end. Bath should be covered with charcoal. Oxidized Pb will decarburize and cling to the work. Lead may be removed by dipping in fused caustic soda NaOH; melting at about 600°. Lower temperatures can be obtained by adding Sn to the Pb, with greatly increased cost and added likelihood of adherence to the work.</p>
<p>Molten caustic, (NaOH), 600–1800°</p>	<p>Used for cleaning. Addition of 1½ to 2% sodium hydride produces a reducing action and is used for descaling. With sodium hydride the bath is operated at about 700°.</p>
<p>Chloride baths, ternary, 1100–1800° NaCl, KCl, BaCl₂</p>	<p>Not very decarburizing, attacks steel unless additions of ferrosilicon plus boric acid, silicon carbide, or at the higher temperatures, C, are made. Used for preheating high-speed steel. With NaCN added, also used for salt quenching of high speed. Boric acid should not be used when NaCN is added.</p>
<p>Chloride baths, binary, 1300–1650° NaCl, KCl Sodium fluoride (NaF) may be added for use at the higher temperatures.</p>	<p>Decarburizing after they become oxidized by contact with air, they become basic. Small additions of BaCl₂, anhydrous boric acid, or NaCN combat the oxidation, which produces decarburization. Without ferrosilicon or silicon carbide additions, they tend to corrode alloy pots.</p>
<p>Chloride carbonate baths Na₂CO₃–KCl, 1200–1600°</p>	<p>Cannot be used in ceramic pots, which are corroded by the carbonate. Decarburizing, especially to tool steels. Periodic small additions of NaCN are required.</p>
<p>High-temperature baths BaCl₂, 1800–2350°</p>	<p>Used for heating high-speed steel. Rectification with ferrosilicon, boric acid, silica, or silicon carbide, necessary. The baths are universally internally heated, using their own electrical resistance.</p>
<p>95 BaCl₂, 5 NaCl, 1650–2400°</p>	<p>Rectified with graphite.</p>

bath is held at the hardening temperature. The steel is preheated to 700–1000° before immersion.

Other baths for salt quenching of high speed contain NaCN, KCl, and Na₂CO₃ or Na₂CO₃ plus BaCO₃. Zinc chloride, ZnCl₂, is sometimes advocated in low-temperature baths.⁹ Calcium salts are avoided in chloride or chloride carbonate baths used for heat treating because of difficulties in removal of the salt and rusting of the work if CaCl₂ is left on it. Zinc and calcium chlorides, ZnCl₂, CaCl₂, take up moisture from the air and are liable to produce dangerous spatter as the moisture is driven off on heating. They appear to have more tendency to corrode the work than do the NaCl–KCl mixtures.

The chloride baths tend to become oxidized with use and then have a decarburizing action on the work. Borax or boric oxide converts the oxychlorides to a sludge which can be periodically removed. These “rectifiers” are not effective in the presence of carbonates.

In carrying out rectification by ferrosilicon, ferrosilicon and boric acid, or silicon carbide, the temperature should be dropped somewhat, the addition should be allowed to act half an hour or so, and then any sludge that drops to the bottom or floats on top should be scraped out.

Rectification of BaCl₂ baths may be partially accomplished by addition of silica (SiO₂), which likewise produces a sludge. DePoy¹¹ points out that, in a bath of 95% BaCl₂, 5% NaCl, merely keeping a graphite rod in the bath gives better rectification than the sludge-forming methods. Sludge dropping on the metallic electrodes by which current is brought into the bath tends to produce poor contact with the salt and thus leads to overheating and short electrode life. It is alleged that, by locating the graphite rods directly over the electrodes, a type of oxide sludge is produced that is reduced to metal, adheres to the electrodes, and builds them up, though the claim is a surprising one.

DePoy cites figures to show that high-speed steel of 0.80–0.85% C may have its surface decarburized to under 0.60% C in an old unrectified bath operating at 2225–2250°, to about 0.70% in a bath daily rectified with SiO₂, but loses not over 0.05% in the graphite-rectified bath.

Rectifying agents are sometimes mixed with the salts added to make up for drag-out, so that the operator will not neglect to use them.

The high-melting salts do not drain well from the work and leave a film difficult to remove, unless the work is plunged into a lower-temperature salt bath, usually one of chloride plus carbonate.

For actual carburizing, rather than preservation of the surface, $\text{Ca}(\text{CN})_2$ is used in activated chloride baths, as discussed on p. 53.

Uses. In the case of cyaniding and activated baths, in lieu of controlled atmospheres, the C (and N) pressures are controlled by cyanide concentration, and, as is the case of the atmospheres, the composition has to be chosen with respect to C content of the steel and the temperature of heating.

Salt baths are sometimes used in "patenting" wire instead of lead, and are also used for process or regular annealing of wire, the strand of wire being run through the bath, or a coil being immersed in the bath.

In contrast to the slow penetration of heat into coils in ordinary box annealing, when a coil that is not too tightly wound is immersed in a fused bath, the fluid medium penetrates the coil and supplies heat directly. Annealing time can, therefore, be greatly reduced. However, the difficulty of removing adhering salt from a coil is a distinct limitation to such a process.

Strand annealing in molten glass at very high temperature, 1800–2400°, in a very few seconds is suggested by Caugherty.⁴ The wire is cooled so far that it will not oxidize in air before the frozen glass coating is broken off.

Stargardter⁵ and Morral⁶ have summarized the applications of salt baths in heat treatment of wire.

Gill⁸ gives a good discussion of salt baths in general, including those for high-speed steel. Bancroft¹² deals with baths for high-speed steel. Melting points of many compositions are given in the *ASM Metals Handbook*.

When a succession of fused salt baths are used, the work being preheated at a low temperature and then transferred to a higher-temperature bath, nitrate baths must not be followed by one containing cyanide, as violent explosive reaction will result when adhering nitrate meets cyanide.

Solakian⁷ describes the technique of salt-bath operation at 1750–1950° as required by some types of stainless steel and high-C high-Cr steels, with emphasis on ceramic pots, with internal electric heating.

For annealing 18:8 and stress-relieving welds in it, Whitcomb¹⁶ advocates pure Na_2CO_3 , operating at 1650–1725°. Baths based on BaCl_2 are classed as inferior for this purpose.

In connection with a general discussion of lead baths for heating for hardening, Thomas¹⁵ remarks that when a nitrate-nitrite bath is used as a mild quenching medium, even traces of moisture increase its hardening power and the danger of quench cracking, hence the bath is dehydrated at 650°.

The hazards connected with salt baths are well discussed in a publication¹³ that should be read by all users of such baths. Those relating to the use of cyanide in general have also been presented.¹⁴

BIBLIOGRAPHY

1. C. H. LORIG, U. S. Pat. 2,105,439, January 11, 1938.
2. G. A. REINHARDT, U. S. Pat. 1,989,884, February 3, 1935.
3. R. C. STEWART, Characteristics and uses of salt baths, *Iron Age*, V. 157, February 14, 1946, pp. 46–52.
4. J. J. CAUGHERTY, Glass processing wire products, *Wire & Wire Products*, V. 19, May 1944, pp. 299–303.
5. A. R. STARGARDTER, Salt baths in the wire industry, *Ibid.*, V. 20, June 1945, pp. 415–19.
6. F. R. MORRAL, Molten baths for the wire industry, *Ibid.*, V. 20, October 1945, pp. 736–41.
7. H. SOLAKIAN, Heat treatment of stainless steel, *Iron Age*, V. 157, May 30 1946, pp. 46–9.
8. J. P. GILL, *Tool Steels*, American Society for Metals, 1944, 577 pp.
9. A. F. HOLDEN, U. S. Pat. 2,400,511, May 21, 1946.
10. W. B. MACNERLAND, High-speed hardening without atmospheres, *Steel*, V. 118, June 3, 1946, pp. 107, 152.
11. S. M. DEPOY, Carbon rod rectification, *Steel*, V. 119, July 15, 1946, pp. 114–16.
12. W. E. BANCROFT, Salt baths for hardening high-speed steel, *Metal Progress*, V. 50, November 1946, pp. 941–7.
13. Potential hazards in molten salt baths for heat treatment of metals, Natl. report 2, National Board of Fire Underwriters, New York, 1946, 40 pp.
14. Precautions in handling cyanide, data sheet, *Metal Progress*, V. 50, 1946, p. 1010.
15. B. THOMAS, Lead hardening, *Metallurgia*, V. 36, May 1947, pp. 28–30.
16. K. WHITCOMB, Annealing salts for 18:8, *Steel*, V. 120, June 16, 1947, pp. 86–7, 105–09.

SECTION II. HEATING AND COOLING

CHAPTER 8

GENERAL CONSIDERATIONS

All heat treatment consists in bringing about structural changes which occur at a definite temperature and, save in the case of the transformation to martensite, for a definite time. Solution of carbides in austenite and diffusion after solution are time-temperature functions. So is softening in tempering. S curves demonstrate the vast influence of differences in temperature and time in the transformation of austenite to its various decomposition products. In determining S curves, it is necessary to use extremely thin specimens in order to produce the structure representative of a given temperature and time, rather than a mixture of structures representing different temperatures and times coming from the temperature lag between outside and inside. Slack quenching results from this lag. Temperature uniformity throughout the section must be had, the center must catch up with the outside, before uniformity of structure can be achieved.

When heat is fed in from the outside, the thermal resistivity of the steel has to be overcome. Stress is introduced in heating or cooling, because of greater thermal expansion or contraction of the outside. Only when the piece of steel has reached the exact temperature of the furnace and the outside stops heating up, can the center fully catch up. There is an added impediment to uniform heating when more than one piece is in the furnace, and when a furnace is packed full of pieces the charge has impediment added to impediment, because one piece shields another.

Modes of Heat Transfer. Heat is transferred (a) by conduction, as from the outside of one piece to its own inside, (b) by convection, hot gas or liquid bathing the pieces, and, when the gas or liquid has given up heat, constantly being replaced by fresh hot gas or liquid, and (c) by radiation. At high temperatures, most of the heat transfer is by radiation.

Radiant heat travels in straight lines; pieces in the shadow of another cannot be heated by the direct radiation from the source, but must await reflection of the radiation to some part of the furnace wall from which there is an unimpeded straight path to the piece. A completely buried piece can get no radiated heat, it can only acquire heat by conduction from its directly heated neighbors, or by convection from the furnace's gas. If the furnace gas is stagnant, convection heating is very slow.

To pick up radiant heat effectively, the piece must "see" the radiant source.

For these reasons the temperature of the furnace and the temperature of the charge, especially of the center of the charge, differ widely, and continue to differ for long periods. The outstanding example is a pack of sheets or coil of strip. The poor contact between the faces introduces huge thermal resistivity. A single thin sheet would heat up in a matter of seconds; a furnace load of packs or coils may not reach the desired temperature at the center of the load after a day in the furnace. In the effort to bring the center of a furnace load up to temperature, the furnace itself is likely to be run far above the desired temperature in the work, and the outer part of the load thereby overheated.

Temperature Uniformity. Methods for securing maximum temperature uniformity are obvious, but their economical application is not always simple. The major advances in heat-treatment methods reside in making temperature uniformity practically attainable.

Temperature uniformity can be obtained by

1. Creating heat within the part instead of outside it, by direct electric heating, using the electrical resistivity of the part itself, or by induction heating, preferably at the lower frequencies.
2. Forced convection, as by circulation of the furnace atmosphere or liquid bath.
3. Separately heating each piece by radiation direct from the source, avoiding anything that will throw a shadow.
4. Waiting for temperature uniformity to be established when the other methods are not applicable.

Heating, Temperature Head. Salt baths are run very little above the temperature it is desired that the work attain. Instead of a temperature head to supply heat, the mass of salt is a heat reservoir, and convection, or still better, actual circulation, serves continually to supply heat from this reservoir. Thin edges do not be-

come overheated while waiting for the center to reach the same temperature as the outside.

Irregular pieces that are liable to warp in conventional heating may be passed through a series of salt baths, each at a higher temperature than the previous one, so that temperature equalization never has to take place over a very sharp gradient. Since the time for equalization in each bath decreases as the temperature increases, one high-temperature bath can handle the work from a couple of lower-temperature baths.

Such methods of heating are not different in principle from putting the stock into a cold or merely warm furnace and slowly heating the furnace, but, with proper salt baths, they avoid the difficulties attending the use of controlled atmospheres over a wide range of temperatures in the same furnace.

Birdsall¹ gives an extended discussion of multiple bath heating. Haufe² discusses both the heating in an ordinary furnace and quenching and tempering of forging dies with irregular impressions.

Internal Stresses. Retained austenite would probably be useful in cushioning the internal stresses, during the initial transformation to martensite, but, if austenite remains after the first tempering and the piece is again cooled through the M_s - M_f range, more martensite may be produced, which, if untempered, promotes brittleness. Thus oil quenching, which favors austenite retention and gives better chance for relief of internal stress due to slower cooling through M_s - M_f than with water quenching, may avoid initial cracking, but leave the steel in poor condition. Cold treatment, immediately following the oil quench so as to avoid a sojourn at room temperature which tends to stabilize the austenite, could be applied to minimize this.

Allowing the temperature to equalize through the section before quenching, as in martempering, minimizes internal stress on quenching. If the internal stress is compressive at the surface, or even if it is tensile and not too high, but is balanced all over the surface, cracking is unlikely, and prompt tempering avoids later danger. But any condition, such as irregular shape of the piece, or irregular quenching, which leads to unbalanced stress, will produce either cracking or warping.

In quenching, the surface expands owing to change to martensite, but then the exterior layer contracts as it cools. The next layer underneath, transforming to martensite, expands in turn, exerting pressure on both the skin and the core. The core cannot give to pressure

exerted from all sides; there is no place for it to flow to, and so it exerts a reactive pressure on the outside layers, putting the outside in tension as the outside shrinks in cooling. As the core of a through-hardening steel in turn transforms, it expands and puts the outside still further into tension.

As the whole piece cools and the core shrinks, it may ultimately pull the outside layer into compression. These pressures, first in one direction, then in another, are exerted while the steel is becoming more and more rigid, and so it is no wonder that the quenched piece ends up with a variety of locally trapped stresses.

If the piece is symmetrical, so that the quenched layer advances uniformly, the surface stress is balanced, and the piece is not likely to crack or warp. Subsequent tempering at a high temperature relieves most of the internal stress, but, if the piece is only lightly tempered, the internal stress will remain and cause warping if it is slotted or machined eccentrically.

Distortion. An unsymmetrical object, or one not symmetrically quenched, has a great tendency to crack, or at least to warp. To quench uniformly and especially to avoid steam or oil vapor pockets, agitation of the coolant, or, still better, spray quenching from all sides and movement of the piece itself help.

In quenching gears, armor plate and other articles prone to warp, mechanical restraint upon warping by clamping the hot piece between dies, perforated so as to allow applying the coolant uniformly from all sides, applying pressure to straighten any warping that may have occurred in heating, and then supplying the coolant under pressure through the holes, minimizes distortion. The cold metal of the dies, kept cold by the coolant, abstracts the heat and itself co-operates as a quenching medium.

Grinding cracks, and an allied malady, heat checking in service, can occur without any transformation being involved, merely from local thermal expansion and contraction. Austenitic steels, and even Cu, are not immune. If one face is rapidly and uniformly heated and expanded while the underlying metal remains cold, the hot face tries to upset, and, since it cannot upset save at the edges, it acquires internal stress. On cooling, this stress, added to the contraction stress, exceeds the tensile strength, and cracking, in a more or less checkerboard or waffle-iron fashion ensues. That local stress exists, prior to actual cracking, can be shown by etching, as has been brought out in the summary by Tarasov.³

Repeated heating and cooling may be required to produce actual cracks, the behavior being reminiscent of fatigue.

Heating in Grinding. Martensitic surfaces, with their negligible ability to upset without cracking, are especially susceptible, and tetragonal alpha martensite is even worse in this respect than cubic beta martensite. Grinding, the usual method of finishing martensitic wearing surfaces, not only produces heat at the surface, but also produces it spottily rather than in a perfectly uniform sheet. If there be retained austenite, thus heated above M_s , when the ground surface cools, untempered martensite may form, and the next pass of the grinding wheel meets this especially susceptible material. Tempering the martensite to the beta form and avoiding retained austenite thus seem to be important in grinding carburized surface, or those of tool steel. Grain-boundary cementite also favors cracking.

Severe grinding may carry very tiny local spots on the surface of a ferritic steel into the austenite temperature range. These are quenched by the surrounding cold steel to form a spot of martensite. It is even possible to "surface-harden" the whole surface of a piece merely by severe grinding. Insufficient coolant may aggravate this by failing to keep the local surface temperature below the austenitic range, and then accentuate the quenching of the austenite. Somewhat less severe grinding of a hard surface may produce a soft tempered skin. A "glazed" wheel, loaded with soft debris, burnishes rather than cuts, raising the surface temperature greatly. This usually results in softening the surface and giving it a temper color characteristic of a wheel burn. A decarburized surface tends to load the wheel and produce burning. Removal of decarburization by abrasive blasting prior to grinding may help. Surface cracking is a sure indication of excessive tensile stresses. Relief of such stresses produced by grinding, when only stress and no actual cracking are concerned, is brought about by mild tempering, such as in boiling water (plus soda or chromate to avoid rusting) or in oil to, say, 350°; by shot peening, to introduce compressive stress sufficient to overcome the tensile stress; or by very gentle honing to remove the surface layer without starting cracks. The layer stressed in tension by grinding is very thin.

Many ground pieces contain unsuspected grinding cracks, which are not open enough to show up on visual inspection. Magnafluxing will reveal such cracks, but will not reveal whether or not the surface has dangerously high tensile stress. Actual cracks, and only

to a somewhat lesser degree, surface tensile stress, are extremely injurious to fatigue resistance.

Introduction of H by electrolytic etching, or chemical etching in acid, causes severely stressed surfaces to crack. Tarasov has discussed etching to reveal surface tensile stress, in considerable detail.

Avoidance of decarburization in cooling after carburizing, so as to decrease the depth to be removed by grinding on precision gears, is emphasized by Koether.⁴ How extremely localized heating may be when developed by highly concentrated local stress is brought out by Jones.⁵

BIBLIOGRAPHY

1. G. W. BIRDSALL, Improved processing methods help avoid heat treat distortion, *Steel*, V. 114, May 15, 1944, pp. 86-9, 134-49.
2. W. HAUFFE, Eliminating cracking in heavy forging dies, *Iron Age*, V. 153, May 18, 1944, pp. 66-71.
3. L. P. TARASOV, Detection, causes, and prevention of injury in ground surfaces, *Trans. ASM*, V. 36, 1946, pp. 389-440.
4. E. A. KOETHER, Grinding hardened steel precision gears, *Materials & Methods*, V. 22, December 1945, pp. 1754-8.
5. A. B. JONES, Metallographic observations of ball bearing fatigue phenomena, preprint 45 for American Society for Testing Materials 1946 meeting, 14 pp.

CHAPTER 9

PROPER HEATING IN FORGING AND ROLLING PRACTICE

Open Furnaces. In contrast to the muffle or bell-jar type of furnaces and the good provision for temperature control available for precise controlled-atmosphere heat treatment at moderate temperatures on ordinary steels, or the salt bath and other methods for the treatment of expensive tools whose value is high and whose size is seldom huge, much cruder, less controllable, types of furnaces are, of necessity, in use for the heating required in rolling and forging steel.

The temperatures required are high, and the pieces of steel are usually large. To heat the big pieces to these high temperatures quickly, and without excessive fuel cost, it is necessary to have a high-temperature source of heat and to develop the heat close to the piece to be heated, that is, to use an open rather than a muffle-type furnace.

At best, the big pieces come to temperature slowly. To get maximum production from a given heating furnace, there is a great temptation to run the furnace at a very high temperature. The effects of high temperature and the prevalence of overheating in forging were emphasized in the 1915 edition of this book, some of which comment is repeated hereinafter unchanged. That overheating is still prevalent and serious has been brought out by recent American and British writers cited in Vol. I, p. 349.

Heating Rates. Much damage can be done by heating too rapidly. An old rule-of-thumb says that heating for annealing, normalizing, quenching, or forging, should be not faster than a half-hour or hour for each inch of thickness of section. That "rule," while a commendable one for pieces of irregular section, likely to warp on rapid heating, is more honored in the breach than in the observance, especially with steels of low grain-coarsening tendency. The center of a heavy section comes to temperature much more slowly than the

outside, just as it cools more slowly, and, for the same reason, thermal conductivity is a bottleneck.

Heating curves for the center and outside of a couple of sections of a 0.41 C, 0.80% Mn steel from data of Jackson and coworkers¹

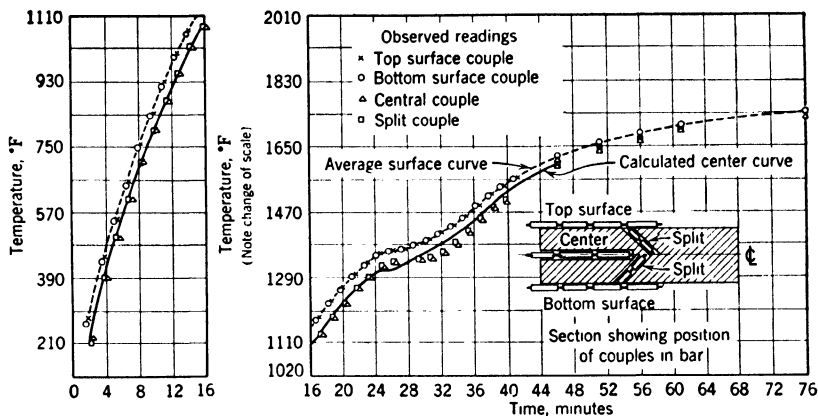

Fig. 66. Heating of 3½-in.-diameter bar.

are shown in Figs. 66 and 67. These were obtained by placing the cold steel in a hot furnace with unimpeded radiation to the specimens. Note that, unless time is allowed for “soaking,” the center

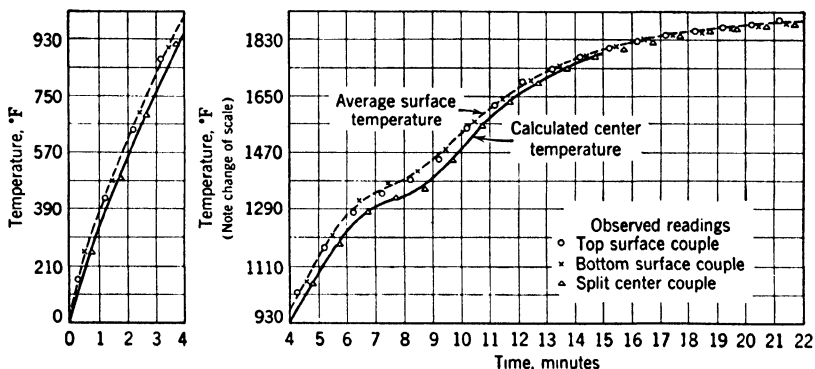

Fig. 67. Heating of 1¾-in.-diameter bar.

lags behind the surface in the usual temperature range for quenching. Figure 68 from Juppenlatz² shows the heating rate with the stock placed in a cool furnace, which is then heated. Heating rates for plates 3 in. to 6 in. thick, inserted into a furnace held at 1650°

are shown by Rosenthal and Manning,⁸ the times necessary for equalization ranging from 1 to 2 hr.

For forging, experiments^{5,7} on very rapid external heating with gas burners producing intense heat have been carried out in which 6-in.-diameter billets were heated to 2250° in 55 min. A $2\frac{1}{4} \times 2\frac{1}{4} \times 3$ -in. chunk of 1095 was heated to 2200° at the surface and 2000° at the center in less than 5 min, the 1500°-center 2100°-surface stage being reached at $3\frac{1}{2}$ min.

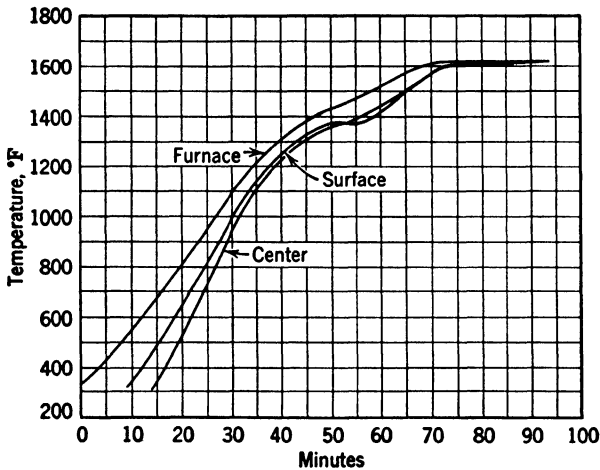

FIG. 68. Characteristic thermal gradients of $2 \times 6 \times 6$ " cast-steel block on heating.

Heating curves for a $5\frac{1}{2} \times 5\frac{1}{2} \times 10$ -in. billet of 4340 are shown in this reference. In this test the surface was heated to 2200° in $14\frac{1}{2}$ min at which time the center was at only 1800°. At 13 min, the center was at 1500°, the surface at 2100°. The symmetrical pieces used did not crack under the rapid heating.

Obviously, even for forging, a cold center does not lead to good results, and a soaking period was necessary, but only $4\frac{1}{2}$ min more were allowed for equalization to 2150°. Equalization would be even more necessary for heat treatment. Raising the surface to 2100° to reach the hardening temperature at the center would call for a steel very resistant to grain coarsening, and such a temperature gradient would be dangerous in respect to cracking an irregular section. In another case cited a $2 \times 2 \times 2\frac{1}{2}$ -in. slug of 1035 was heated to 1520° at the surface in $2\frac{1}{2}$ min, with the center then only

at 1330°, but it is claimed that after the gas had been turned off, the center and surface equalized at 1510° in 2 min more.

Such rates of heating, without a soaking period, are, however, suitable for surface hardening. In some such applications, parts a foot long were surface-hardened on a conveyor line past the high-speed burners, at the rate of one per minute.

Overheating. Steel severely overheated in forging may grow very coarse grains, surrounded by heavy ferrite envelopes, and may be very reluctant to homogenize, as discussed in Vol. I.

In such cases, as in steel castings, a double treatment is often required. The first treatment involves a high austenitizing temperature and long time to get an approach to homogenization, even though considerable grain growth of austenite is produced. The piece is then air-cooled, the austenite thus being converted to ferrite and pearlite; the proeutectoid ferrite is better distributed than it was in the first place. On re-austenitizing this structure, with thinner proeutectoid ferrite, the carbide in the pearlite does not have too far to go and the second austenitizing temperature and time can be lower and good homogenization still result without the excessive grain growth of the first austenitization. The austenite, now more homogeneous but fine-grained, is ready for annealing, normalizing, or quenching to products with better properties than would result from a single treatment.

However, the initial structure of a forging may make it an almost impossible task for the heat treater to produce good results. The evil effects of overheating or of attempting to forge with the outside dripping and the inside hard are in strong contrast with the good results from forging a piece that has had time to become thoroughly equalized in temperature, but not overheated, with the temperature so adjusted that forging is completed with the steel not far above its critical range. High heating and finishing temperatures and lack of sufficient working produce structures like that of Figs. 69 and 72, and the opposites produce structures like that of Figs. 70 and 73. These specimens represent the average work of the same crew, paid on the same basis of output, on the same size forgings. The poor results of Fig. 72 came from a furnace that had to be forced to heat the billets as fast as the hammer men needed them, so that the billets had badly overheated surfaces. When a different furnace was installed, one in which the steel could be given more time to attain temperature uniformity, with a lower furnace temperature, and which could supply sufficient properly heated stock to keep up with

the hammer so that the crew did not have to force it, the good result of Fig. 73 was produced.



FIG. 69. Structure of large shaft improperly heated.

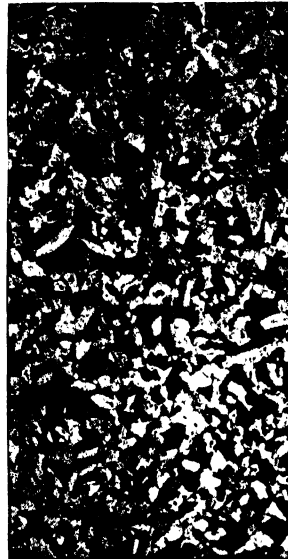

FIG. 70. Structure of large shaft properly heated.

× 100. (Bullens)

Properties Obtained. How such structures are reflected in the response of the steel to heat treatment is shown by the data in Table 23, and by the fractures of the corresponding tensile bars in Fig. 71.

TABLE 23

<i>Piece No.</i>	<i>Tensile</i>	<i>Yield</i>	<i>Elong., %</i>	<i>R.A., %</i>	<i>Fracture</i>
1	88,000	50,500	14	28.5	Angular: dead
2	80,500	50,000	11	13.5	Burnt
3	96,750	55,750	22	42	Dead: half cup
4	86,000	51,250	27.5	39	Dead: angular
5	85,750	51,750	22	34	Granular
6	96,000	54,000	12	36.5	Granular
7	81,750	54,000	32.5	65	Silky: full cup

All the shafts represented by the seven test pieces were made from the same heat of steel, were of approximately the same size, and were subjected to the same amount of working during forging; and

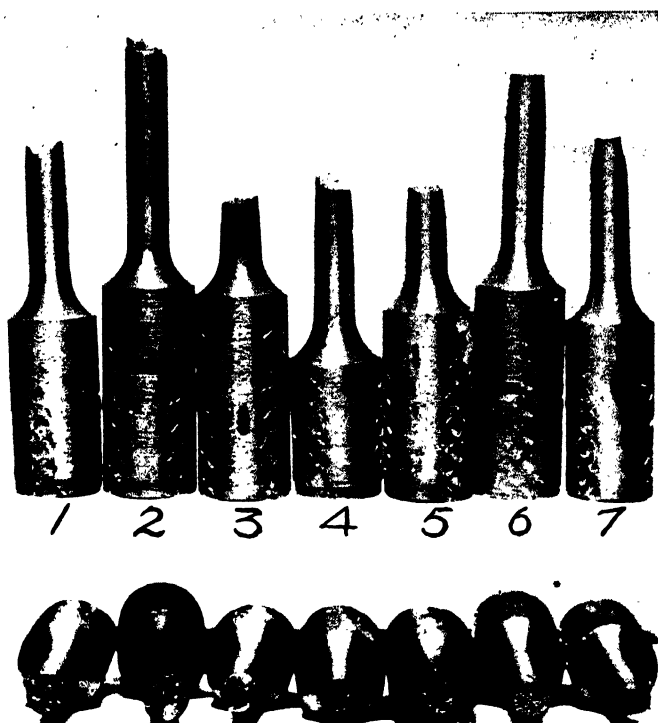

FIG. 71. Influence of forging on subsequent heat treatment.

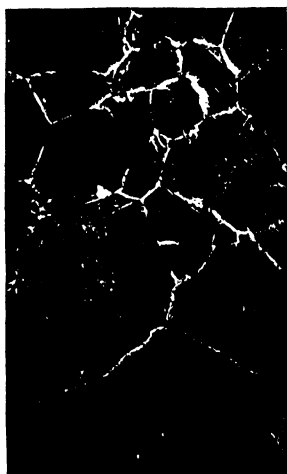

FIG. 72. Structure of test piece 6.

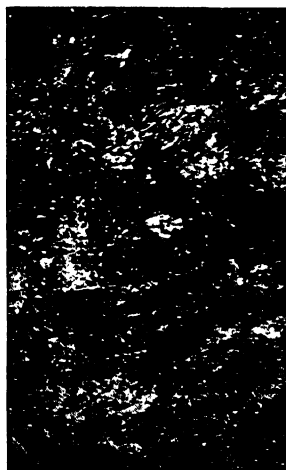

FIG. 73. Structure of test piece 7.

× 100. (Bullens)

all were treated in the same manner at one time. The structures corresponded to the fractures; 1-6 all showed severe overheating. The structure of 6 is shown in Fig. 72. The structure of 7 (Fig. 73), with a cup and cone fracture, as well as the tensile results, shows that 7 was properly heated and forged.

Scaling. Slow heating might be expected to lead to increased scaling, but since slow heating allows the use of a lower temperature this tendency is somewhat balanced. A gentle circulation of hot gases in the furnace instead of a sharp flame impinging on the work tends to reduce scaling. It is not often attempted to work in a controlled atmosphere since some scaling will occur in the forging operation anyhow, but the effort is to produce a thin easily detached scale, instead of a heavy one that is hard on dies. Avoidance of too strongly oxidizing an atmosphere will aid in getting the right type of scale. Moreover, as Sherman⁴ points out, the heat transfer from a luminous flame throughout the furnaces is better than from a non-luminous one. The luminous flame is a larger source of heat, and the furnace chamber is more uniformly heated.

Forging Furnaces. Many shops are finely equipped and well supervised in the heat-treating department proper, but lack of proper furnace equipment and supervision in the forge shop nullifies the efforts of the heat treater. Some comments on the design and operation of forging furnaces are therefore in order.

The selection and operation of suitable heating equipment resolves itself into a problem of determining: (1) the type, size, number, and arrangement of furnaces and the auxiliary equipment; (2) the form of fuel or electricity best adapted to specific manufacturing requirements and distinctive plant conditions; (3) efficient methods of heating, cooling, and handling the stock to be formed; and (4) reasonably comfortable working conditions for the operatives.

It is common to see furnaces hot at one side and cold at another, or hot at the top and cold at the bottom, and to hear complaints on lack of ability to heat steel properly in a furnace in which the burners blast directly against the stock, which may keep the stock nearest the burner cool and heat the pieces farther away. This is a common fault in many oil-fired forge furnaces, particularly those of "home-made" design, although it must be said that the products of many furnace builders are not altogether free from this criticism. Unfortunately, the common method of designing and building a forge furnace appears to be building a box with working opening at one end, placing a hole somewhere in the wall through which a burner

is to blast, providing one or more holes in the roof, and calling it a furnace. All this is done without any regard for the generation and proper application of heat to the stock and without provision for the control of the air entering the chamber or of the hot gases leaving it.

The average forge shop is underequipped in the matter of heating area with the result that the furnaces are pushed beyond capacity to the detriment of the steel, the operators, and the manufacturer who pays the bill. The general design of forge furnaces is far below the standard of heat-treating furnaces and is a point too commonly left to the forge man or to a bricklayer. The average forge furnace is designed poorly in the matter of size, structure, control, size of working opening, protection for the operatives, and unnecessary vents—the last-named representing little more than an unnecessary source of waste. Improvement will follow intelligent operation of larger and heavier furnaces of proper design which will pay for themselves and decrease the cost of operation. Such furnaces should be provided with larger heating chambers, arranged to prevent overloading and to permit of uniform application of heat to the stock without local heating.

It ought to be relatively easy to secure uniform temperature from piece to piece in a forging furnace, when the pieces are not piled one upon the other so that one shields the other from the source of heat, a matter which we shall see later is of vast importance in many heating operations.

Precautions for Uniform Heating. With the normal distribution of stock within the furnace it is necessary to provide relatively large heating chambers and to avoid local overheating or direct impingement of flame in oil- or gas-fired furnaces, which are the most common types. Several burners rather than one large one make it easier to avoid localizing the heat. Provision should be made for the circulation of hot gases, but not of the flame itself, about the stock. Gas circulation should be so controlled that the hot gases do not play into the faces of the operators when the door is opened to remove the stock.

Vents should be so placed that the combustion gases are not short-circuited from flame to vent without passing around the stock. Nor should the flame itself burn beyond the vents; sufficient combustion space should be afforded inside.

Vents should be supplied with adjustable dampers since greater vent area will be needed while the furnace is warming up than when

regularly operating. If it becomes necessary to heat one end only of a very large billet so that the other end must be allowed to project from the door, the space around the billet should be filled up with brick. The spaces between the bricks act as vents, and the regular vent should be nearly closed, to keep from pulling in excess air through the joints of the bricks. In general, all the air entering the furnace should be under control, so that there are no openings that cannot be closed tight. The same principle applies to the heating of smaller stock.

Slot Heating versus Slugs. Whereas the slot type of furnace is required when only the end of the piece is to be upset, and may be necessary in the case of a restriking operation that involves reheating, one may question the suitability of slot furnaces when the nature of the work allows the use of slugs.

The practice in which the bar stock is inserted in the slot or in holes, the end heated up, sheared off in the first dies, and the remainder of the bar stuck back into the furnace makes for hot working conditions and for low fuel efficiency. Any furnace designer well knows that "through metal" reaching from furnace chamber to the outside is to be avoided and that losses through open doors are so huge that quick-closing doors are necessary. The slot furnace operates with through metal or with open slots all the time. Slot openings should be adjusted in height and width to suit different sizes of stock; also the opening should be as completely filled with stock as possible at all times.

This adjustment may readily be effected by laying a course of loose brick on the sill and, when necessary, laying a loose brick at the side of the opening.

Unnecessarily high openings are responsible for high fuel consumption, unnecessary heat on the operator, fumes in the shop, and oxidation, particularly when the burner blasts through an uncovered hole. The fuel consumption is more affected by the size of the opening than by the burner.

Proper practice in slot furnaces is to take out the hottest piece and replace it by a cold one, that is, "one in and one out," rather than to do "batch" heating. In other words, the sequence should be such that each piece is in the furnace the same length of time.

Slot practice is defended on the score of supplying a tong hold; yet the cost of heating will generally overbalance the cost of the extra metal necessary for a tong hold when the charge is cut into slugs and passed through a closed furnace. One up-to-date plant

uses slugs, the first forging operation being in a press that elongates and reduces one end to form a thin tong hold without wasting stock. The result is a real saving in manufacturing cost.

One plant is operating on $3 \times \frac{3}{4}$ -in. stock formerly heated in a slot furnace, a heated length of 5 in. being required. With slot practice they used 50 gal oil per ton. By shearing to 5-in. lengths, and heating in the same furnace, merely providing an uninsulated boiler plate door over the slot and keeping the slot closed except when charging and discharging, the oil consumption was cut to 35 gal per ton. With a pusher type or other continuous furnace, properly insulated, the fuel consumption could, of course, have been cut still more.

Fuel Consumption. Fuel consumption alone is no criterion of the usefulness of a forging furnace. Were it necessary to use more fuel in order to secure properly soaked and uniformly heated stock, it would be economy to do so. However, properly designed furnaces with ample heating space operating at a moderate rather than an excessive temperature and with proper flow of hot gases seldom use as much fuel as the poorly planned furnaces they replace.

Delays. A special difficulty attends the operation of furnaces that operate at an excessive temperature when a hammer hold-up occurs and the stock has to remain in the overheated furnace. Even shutting the fuel off entirely may not prevent "burning" of the piece and coarsening of its structure. Automatic control of the ruling temperature of the furnace, through pyrometers, is helpful in continuous furnaces of the pusher type, for example, and indicating pyrometers are a great help in manual control; but it is rare indeed that nothing occurs to the flow of work through a forging furnace in the course of a day to vitiate temporarily the effectiveness of automatic control on the temperature of the stock itself.

Mitigation of Scaling. Scaling in heating for forging may be mitigated by adjusting the fuel-air ratio to give "soft" heat; but, when full atmosphere control is desired for entire prevention of scaling, electric heating may be resorted to, and a suitable protective gas led around the work. However, this will prevent only the scale formed during heating, not that which is formed during the actual forging operation.

Electric Heating. In the case of stock of uniform and not too large cross section, heating can be done as in the Berwick-type heater⁵ by passing an electric current through the work itself, which not only allows rapid heating without the cold core that accom-

panies rapid heating from an external source, but also, since the pieces are individually heated, allows an "electric eye" to shut off

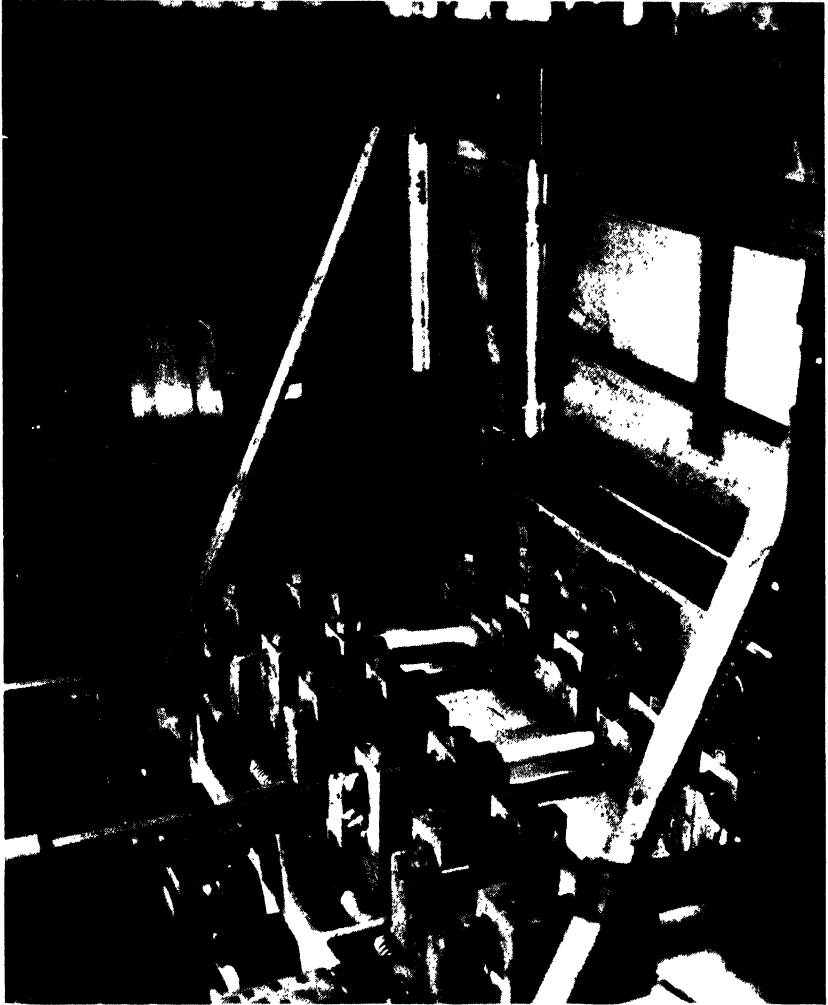

FIG. 74. Manual-feed Berwick electric forging heater in operation at Chevrolet Motors Corporation, Bay City, Mich. (Courtesy American Car & Foundry Co.)

the current automatically when the desired temperature has been reached and, then, if the piece is not withdrawn at once, and so drops below the proper forging temperature, to turn it on again. Hammer delays thus exert a minimum of detrimental influence on the heating process. Unfortunately, the range of stock that can

be so heated is limited; hence truly automatic control is not widely applicable to all heating for forging. Figures 74–76 illustrate the Berwick heater.

Induction heating by high-frequency current offers similar opportunity for individual heating and automatic control.⁶ Because of

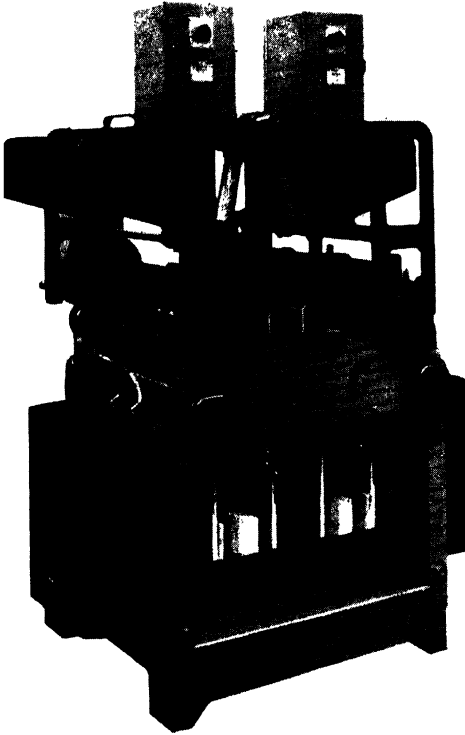

Fig. 75. Automatic electric forging heater. This is a double unit.

Note the "electric eyes" for temperature control. (Courtesy American Car & Foundry Co.)

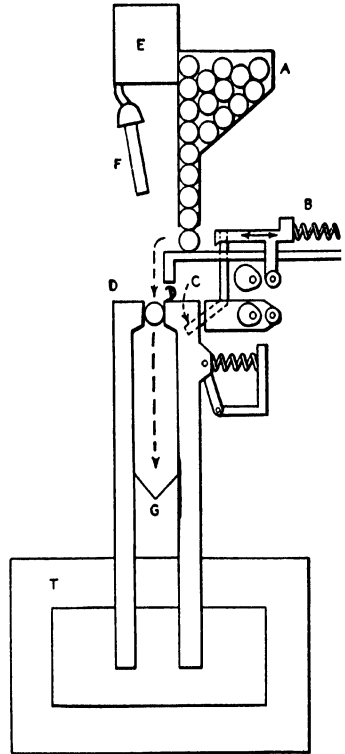

Fig. 76. Diagram of automatic feed.

the high temperature, neither metallic radiant tubes nor the ordinary NiCr resistors will survive in forging furnaces. Globar (silicon carbide) resistors or silicon carbide radiant tubes may be used. The problems of control of the actual temperature of the work and the distribution of the source of heat so as to get temperature uniformity in the Globar-heated furnaces are analogous to those in a gas- or oil-fired furnace. Since the resistor life is longer the lower

the temperature of operation, there is an added incentive in such furnaces to hold the maximum temperature down, which is to the benefit of the work. This type of furnace is in use, but is rather rare.

The Berwick-type heater is less rare, indeed, it is very common as a rivet heater, but it does not cover a large enough section of the field to vitiate the statement that, in general, no heating operation on solid steel depends as much on the "human element," the judgment of the heater, as does heating for forging.

Heating for Rolling. Practically all the comment made here on forging is equally applicable to heating for rolling, though the conditions of uniform flow of stock from the furnace to the mill are generally more favorable than to the hammer or press. However, an improvement in the uniformity of as-rolled stock that would often eliminate the necessity for normalizing prior to heat treatment might frequently be made in rolled products by better control of heating.

Personnel and Supervision. Proper heat treatment of steel is not possible without proper heating in the rolling mill and forge shop, and forgings cannot be produced as they should be without good men and good furnaces. Heating is a skilled occupation. "Any kind of a man" is not good enough for the expensive operation of forging and heat treating.

This factor is the weakest link in the chain of heat-treatment operations and must be strengthened, not only because it is necessary from the technical side, but also because it is profitable from the commercial side. The time and money which can be saved in scrap, fuel, power, repairs to furnaces and other equipment, machining operations, lost business owing to defective material, etc., should certainly be sufficient inducement to bring about the change, the necessity for which has been too long overlooked and the possibilities too little realized.

There should be continual supervision of the heating operation in order to check the temperature, the time of heating, the uniformity of heat throughout the chamber, the amount of waste gases, the oxidizing effect of the furnace atmosphere, the consumption of fuel and power, and the repairs to furnaces and other equipment. Personal supervision is made absolutely necessary by the very nature of the work. Pyrometers and the like are desirable and necessary, but vital errors may creep in, even though such appliances indicate they should not exist.

The need is for a better understanding of the cause of present-day conditions and of the factors that control the effort for improvement; and for operators or supervisors qualified to apply properly in practice the simple principles governing the conduct of such heating operations.

The practice of delegating one or more men to supervise the work of heating by checking the points previously enumerated, under the direct charge of the shop foreman, is steadily gaining.

Summary. Concisely, the trend of practice should be toward lower furnace temperatures, as close to the temperature actually required in the metal as is consistent; reasonable loading with due regard to the method of exposing the individual piece to the heat so that it will be subjected to the same temperature for the same time and in the same manner as every other piece (as is discussed for heat treating in general in Chapter 11); lower rate of heating, to permit of thorough saturation; furnaces that permit of better application of heat to the metal and better utilization of heat within the furnace; control of all the air entering the furnace; better working conditions for the operatives; and a watchful regard for the effect of the human element, indicated in terms of capable trained operators and competent supervision. All these factors contribute to better quality and greater production at less total cost in terms of finished product.

The heat treater is interested in these matters because poor practice in forging may vastly complicate the problem of heat-treating the forgings.

BIBLIOGRAPHY

1. R. JACKSON, R. J. SARJANT, J. B. WAGSTAFF, N. R. EYRE, D. R. HARTREE, and J. TIGHAM, Variable heat flow in steel, *J. Iron Steel Inst.*, V. 150, 1944, pp. 211P-267P.
2. J. W. JUPPENLATZ, Water quenching small steel castings, *Steel*, V. 114, May 22, 1944, pp. 84-8.
3. High speed heating with gas, *Steel*, V. 116, January 22, 1945, pp. 86-90, 129-30
4. R. A. SHERMAN, Radiation from luminous and nonluminous natural gas flames, *Trans. ASME*, V. 56, 1934, pp. 177-92.
5. F. P. PETERS, Direct electric resistance heating of steel for forging, upsetting, etc., *Metals & Alloys*, V. 8, 1937, pp. 281-7.
6. Fast heating in shell production, *Steel*, V. 101, December 13, 1937, p. 29.
7. F. O. HESS, Rapid heating of steels, *Iron Steel Engr.*, V. 23, April 1946, pp. 73-80.
8. P. C. ROSENTHAL and G. K. MANNING, Heat treatment of heavy cast-steel sections, *Steel*, V. 119, November 18, 1946, pp. 88-94, 111.

CHAPTER 10

SOURCES OF EFFECTIVE HEAT FOR HEAT-TREATING OPERATIONS—FUELS AND FURNACES

The suitability of a fuel for heat treating depends primarily on its ability to be controlled, so that the supply of heat may be continually adjusted to the needs of the charge. The burning of solid fuel on a grate or a stoker is difficult to adjust to these needs. Save for relatively few cases where precision of results is not aimed at, fluid fuels are preferred to solid fuels for heat treatment. Pulverized coal burners could be adapted to some operations of heat treatment, but the deposition of fly ash on the work would have to be avoided in a direct-fired furnace. Most modern heat-treating furnaces are gas- or oil-fired, or electrically heated. This fact itself shows that mere cost of a British thermal unit absorbed in the work is not the main criterion for choice, since coal firing would generally be cheaper on that basis alone.

Fluid Fuels. Confining ourselves hereafter to the fluid fuels, oil, gas, and electricity (since the last flows along wires), we find all these to show flexibility of application and control.

Composition of the gas is an important factor in the matter of selection. For instance—producer gas, water gas, city gas, and natural gas, have about the same control characteristics. However, the difference in composition frequently affects the choice. In certain forging operations city gas is not as desirable as some hydrocarbon fuels. The difference is frequently offset by maintaining the so-called "luminous flame." A difference in the percentage of sulphur might make one gas preferable to another.

It is the composition of the combustible mixture and the products of combustion, rather than the composition of the fuel itself, that are controlling factors.

Propane and butane are used extensively for heat-treating operations, and with excellent results. Among the fuel gases, natural gas is the usual choice in localities where it is available. Manufactured

or "city" gas and mixtures of this with natural gas, water gas, and producer gas are all usable. Because of the differences in British thermal units per cubic foot, burner design will vary according to the gas used. Recuperation to preheat the air for combustion may be necessary with producer gas or other low Btu gas.

Propane and butane may be shipped as liquids in cylinders or tank cars under pressure and stored under pressure. By release of pressure the liquids gasify and the gases are then handled like any other gas. Gas firing may thus be used where natural gas is not available and city gas is too costly.

Efficiency and Effectiveness. No cost comparison can be made on the Btu basis alone. The efficiency of the fuel in the particular furnace to be used and the actual manner of placing the work in it have to be considered also. A furnace and charging method that are "efficient" in the use of fuel but do not produce the necessary uniformity of temperature in the work itself, thus leading to rejections, might be very much more expensive to operate per unit of acceptable output than a less "efficient" furnace, on the thermal basis, but one that actually does the job it is necessary to do.

"Effective" might be a better term than "efficient" to use in discussing fuels and furnaces for heat-treating use, since the word efficiency is ordinarily used merely to express the ratio between thermal units supplied and thermal units absorbed by the work. If we recall the previous chapter on heating for forging it may be seen that, though the total thermal units in a piece with an overheated surface and an underheated interior might be just the same as in one properly heated, the quality is quite different in spite of the quantities being identical.

Although thermal efficiency of a heat-treating furnace is entirely secondary to its ability to heat the stock uniformly with as little scaling as possible, there is no reason to avoid those means by which thermal efficiency and greater output per man and per furnace might be obtained.

Internal Heating. One principle of the efficient application of heat which is seldom given much consideration in heat-treating furnaces is the principle of internal heating, that is, locating the source of heat inside the charge so that radiation is direct to the charge rather than to the walls. This is employed to some extent in the inside resistors for bell-type annealing furnaces for coils of wire or strip (Figs. 77 and 78) and in a somewhat analogous location of radiant tubes in some large annealing boxes (Figs. 79-81).

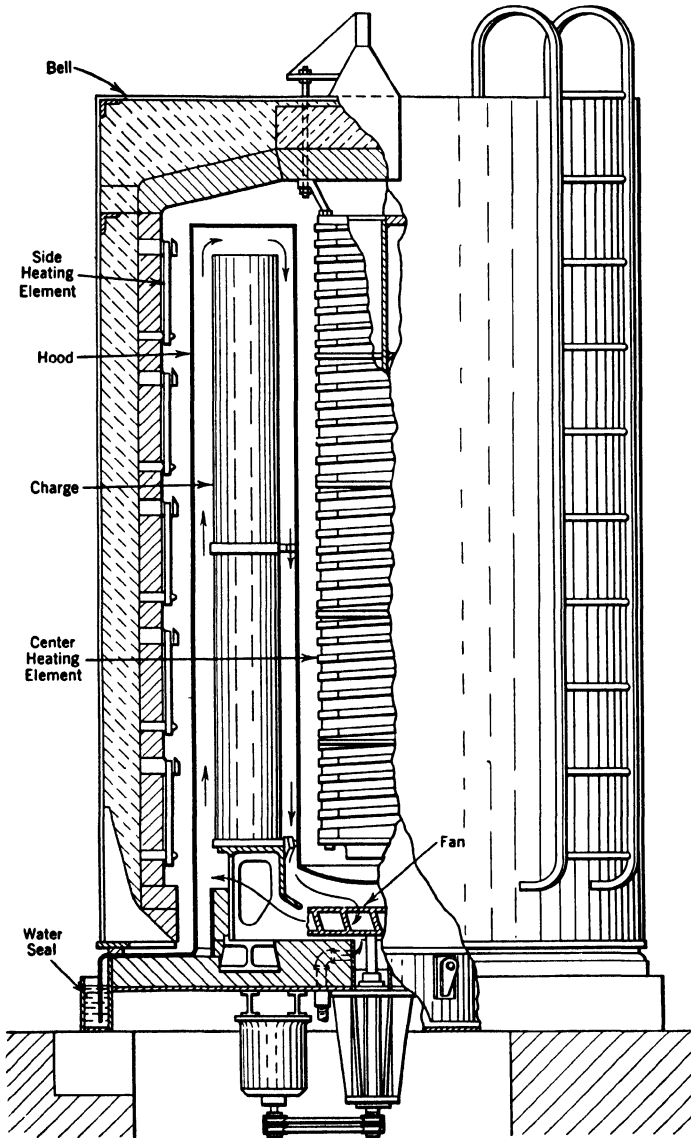

FIG. 77. Controlled-atmosphere bell-type annealing furnace for steel in coils. Note the fan in the base for circulation and the location of the electric resistors, not only at the sides, but also in the middle of the charge, to give uniform heating. (Courtesy Westinghouse Elec. Corp.)

Forced Circulation. Bringing the heat into the charge itself by forced circulation of a heated atmosphere is a big step in the right direction. Modern tempering and annealing furnaces (Fig. 82) use this principle as do gas carburizing furnaces (Fig. 32). Hardening temperatures can also be reached with forced circulation (Fig. 83). Certainly, no tempering furnace is modern without forced circulation.



FIG. 78. Battery of bell-type furnaces of the design shown in Fig. 77, installed at the plant of the Ford Motor Company. Each bell takes two coils of 52-in.-wide sheet. Each coil weighs 16,000 lb. The furnace battery consists of 37 bells and 111 bases. (Courtesy Westinghouse Elec. Corp.)

The urge to get high production out of equipment designed for less production often leads to packing a furnace full of charge, the charge itself so impeding heat flow that the outer layers are overheated and the center of the charge underheated. To provide heat throughout a closely packed charge, hot gas may be forced through it. If the method of packing is such that there are no open channels for the gas to pass through without giving up its heat, the conditions are much like salt-bath heating, save that the thermal capacity of the gas is much lower. The gas must be recirculated back to an external preheater.

Such a scheme, first applied only to low-temperature tempering furnaces, proved so effective for heating packed charges that it was applied to heating for quenching and other austenitizing operations. Use of heat-resistant alloy fans for circulating the gas is, of course, necessary. The upper temperature limit of such operation is steadily being pushed upward. In another field, the burning out of spent



Fig. 79. Radiant-tube annealing covers for coiled sheet. Note the three rows of heating tubes. (Courtesy Surface Combustion Co.)

catalyst masses in the petroleum industry, air is said to be preheated, in a zircon-lined furnace, to 3400° and allowed to pass through the catalyst. Preheating refractory "pebbles" by direct contact with combustion gases and then dropping the pebbles into contact with the air to be preheated are described¹⁰ as easily bringing the air to 2300° . If air can be so heated, controlled-atmosphere gases, suitable for contact with steel at austenitizing temperatures, could also be heated. Already forced circulation of controlled atmospheres has brought the operating temperature above 1750° .

A scheme, so far applied to direct firing, might conceivably apply to hot gas heating, or to controlled-atmosphere furnaces, heated electrically, or by radiant tubes, to avoid infiltration and produce atmosphere circulation. The scheme uses porous refractories. It has been

tried out in England.¹ Gas burners project as usual into the furnace chamber, but the products of combustion, instead of passing out through a small flue, are discharged all around the sides of the furnace through porous brick walls. Back of these walls is a space, beyond which is the usual refractory wall. Suction is applied to this

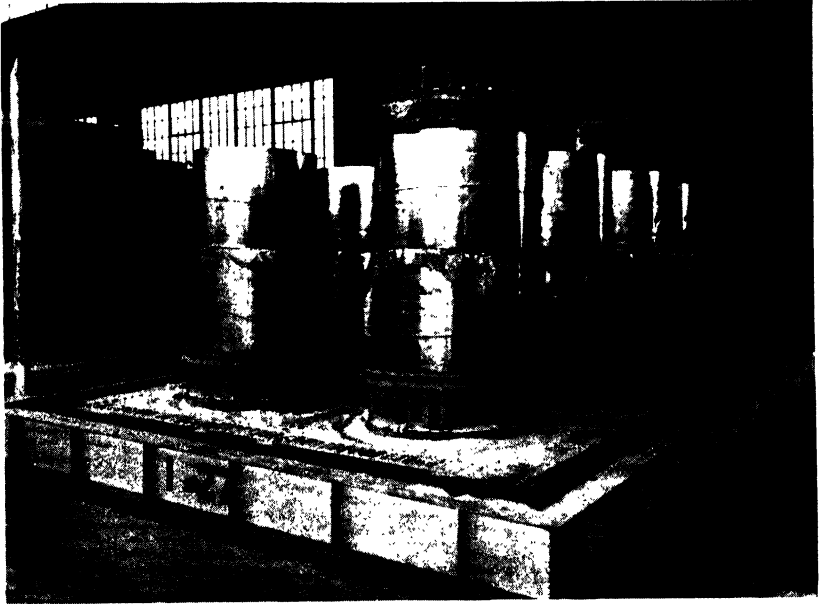

FIG. 80. Coils arranged on furnace base. Note clearance between rows to give space for the middle group of radiant tubes. Note the open bases to permit gas flow. Each base is provided with a fan, to circulate the controlled atmosphere which is used to prevent oxidation. (Courtesy Surface Combustion Co.)

space. The hot products of combustion thus heat the walls with thermal energy that would otherwise be wasted. This leads to higher thermal efficiency. A car-type furnace is sketched in Fig. 84.

The temperature limits of salt-bath furnaces have also been pushed up.¹⁵ At the higher temperatures, ceramic pots are used, as mentioned in Chapter 7, with internal electric heating. High-temperature salt baths vary greatly in size, shape, and design details, but the general principle is sketched in Fig. 85.

Insulation. The use of insulation on the outside of furnace walls to retain the heat inside for efficiency, as well as to make it more comfortable for the operator, has long been appreciated and is widely

used on furnaces for continuous operation. However, there is less advantage in insulation of batch furnaces for intermittent operation

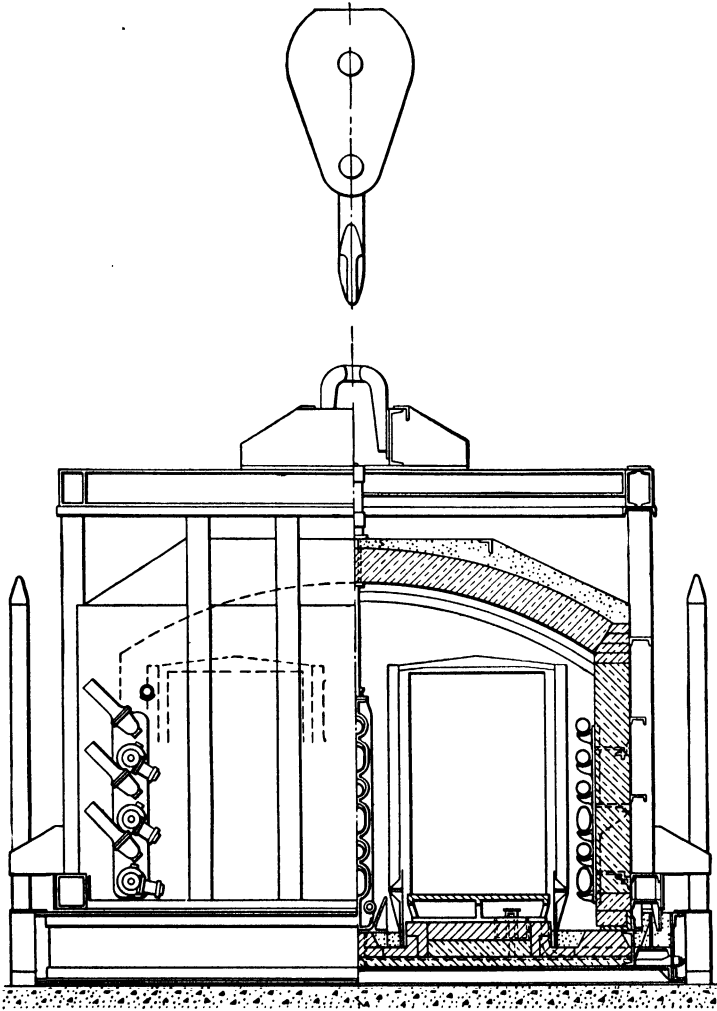

FIG. 81. Diagram of annealing covers of furnaces shown in Figs. 79 and 80. Note the central row of radiant-tube heating elements for better distribution of heat. (Courtesy Surface Combustion Co.)

since the insulation raises the temperature of the outer faces of the lining and thus causes it to store more heat. By the use of insulation it is often possible to reduce the thickness of the refractory (but poorly insulating) inner lining. Such a change in construction re-

duces the heat-storage capacity and allows rapid heating of the furnace to its operating temperature.

An improvement in furnace refractories has been the development of porous firebrick, refractory enough to stand the furnace-chamber temperature, and used without a dense refractory lining. As Brad-

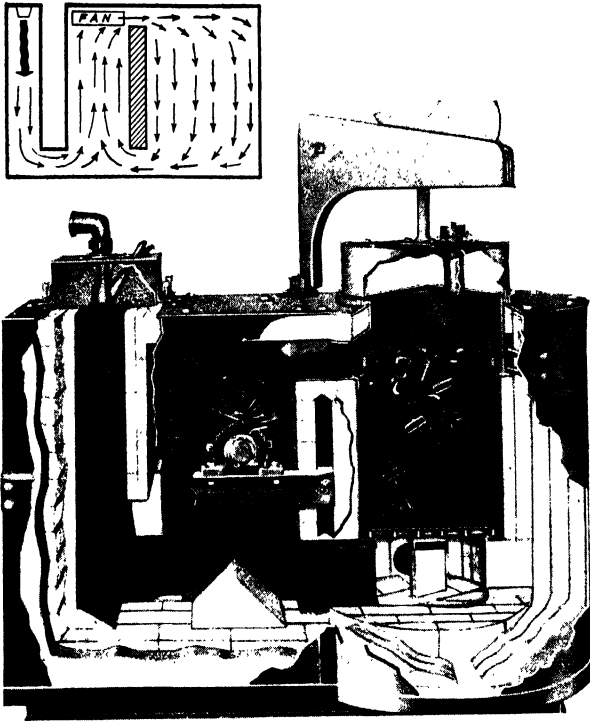

FIG. 82. Diagram of a forced-draft circulating atmosphere furnace. (Courtesy Lindberg Engineering Co.)

ley² and Trinks³ have pointed out, such bricks weigh roughly but one third as much as ordinary bricks and hence store but one third the heat. A furnace lined with them reaches operating temperature very quickly.

As an example, Keller⁴ cites, for 1600° working temperature, the reaching of that temperature in the furnace chamber, with the same fuel supply, in 24 min in a furnace with 4½-in. porous refractory brick walls, when with 4½-in. walls of dense brick it took 1 hr, 43 min. Similarly, in furnaces with 9-in. walls, the porous refractory-lined furnace came up in 35 min, that with solid brick walls in 2 hr,

37 min. Whenever the stored heat in a furnace exceeds the loss through the walls, as is generally the case with intermittently operated furnaces, the porous refractory makes a real saving in fuel and in operating time; and, of course, this holds good whatever fuel is used.

These refractories are somewhat more subject to spalling than is dense firebrick, but several makes are on the market that are satisfactorily spall-resistant.

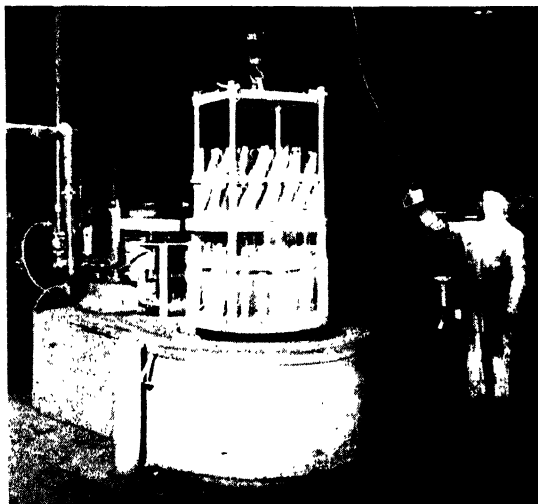

Fig. 83. The stock to be quenched is charged into an open frame so that the gas may be circulated. (Courtesy Lindberg Engineering Co.)

Heat Transfer. The principles of heat transfer and of furnace design and construction are worth studying by the heat treater, not merely from the point of view of furnace efficiency but also from that of the information they give on the effect of different methods of loading, which is discussed in Chapter 11. Both the furnace problem as such and the effect of different methods of loading are discussed in detail by Trinks⁵ and by Mawhinney,⁶ and the engineering mathematics of heat transfer is set forth by Schack.⁷ The topic may profitably be followed further in such textbooks.

Distribution of Source of Heat. By use of small properly spaced burners or resistors, properly distributed, the source of heat may be subdivided and the heat flow may come from a considerable area

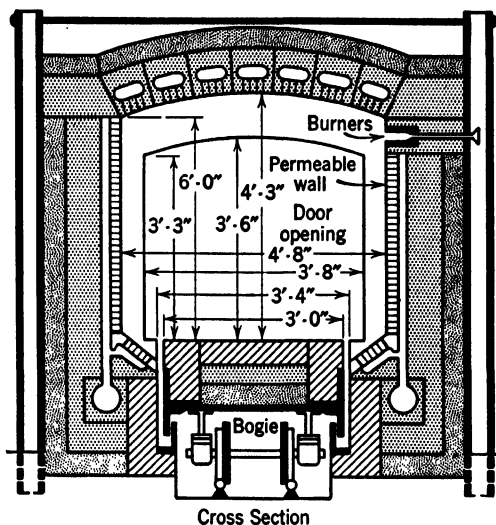

FIG. 84. Sketch of permeable-wall furnace.

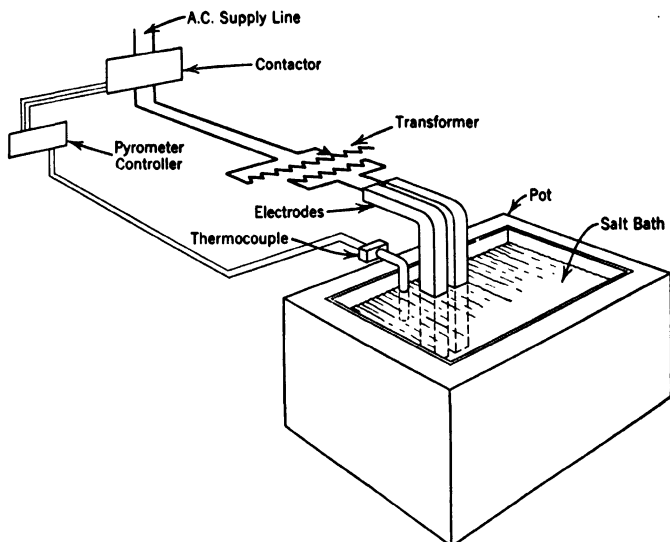

FIG. 85. Diagram of electrically heated salt-bath furnace. The electrodes dip into the fused salt. The hot salt rises, cooler salt is drawn in to take its place, and circulation is set up in such a way as to stir the whole bath and distribute the heat in it. Heating of the stock immersed in the salt is thus more uniform than in a stagnant salt bath heated from the outside. (After Hultgren¹⁵)

rather than from a localized one. A diffuse heat source tends toward greater uniformity of temperature throughout the furnace chamber. At high temperature, heating is chiefly by radiation.

Radiation. Obviously it is easier to get heat to a charge by radiation from a number of small sources than from a single larger source. The ability of the type of furnace used to subdivide its heat source is quite a factor in its suitability. The optimum condition for temperature uniformity exists when the whole furnace inside is itself at a uniform temperature, and the whole is a direct source of radiation. This is, save for openings for charging and discharging, accomplished in a muffle furnace, and helpfully approached even in the semimuffle type where the muffle walls, perforated if the temperature is such that conduction and convection play an important part, are interposed between the hot gases and the stock, to serve as a more diffuse and lower-temperature heat source. However, the fuel consumption in forcing heat through a muffle wall and the maintenance of muffles are drawbacks. (It is shown in the next chapter that getting a uniformly radiating source is only part of the battle, since the charge must also be placed so as to receive the radiation uniformly.)

One way of making practically the whole furnace enclosure a uniform and diffuse source of radiation is to use electric resistors, for example, of resistor ribbon or of coiled wire, looped over refractory supports set in the walls. Resistors can be so disposed that the walls are quite uniformly heated, and by closer spacing in the cold corners and more open spacing in the hotter zones, as well as by mounting them on the inside of the doors and beneath the hearth, the ideal of a uniformly heated enclosure can be closely approached.

The electric resistor, since it can be distributed over the furnace walls, can release the desired amount of heat per unit of time at a lower temperature than can a flame; it is a more diffuse source. Thus the resistor temperature in a hardening furnace will be of the order of 1800°; a gas or oil flame has a flame temperature approaching 3000°. Overheating by direct radiation, or by letting the flame itself strike the work, may therefore be avoided by the use of resistors.

The diffuseness of the source in, and the ease of, automatic control of resistor furnaces, coupled with the freedom from products of combustion and the ability to use a controlled atmosphere, made the electric furnace closely approach the ideal; hence, well-engineered resistor furnaces have reached a high state of development and acceptance.

Controllability of Modern Furnaces. The competition afforded by well-designed electric furnaces to inferior designs fired with gas or oil spurred dealers with those fuels to sell and manufacturers designing furnaces for those fuels to improve furnace design so that temperature uniformity could be better approached and to devise ingenious and reliable automatic controls for fuel and air so that temperature control might be as feasible in fuel-fired as in electric furnaces. In general the control devices for fuel were more difficult to design so as to be reliable and trouble-free than were the electric ones, but they have nevertheless been perfected so that either control at one temperature, or "program control" which automatically produces a given time-temperature cycle, can be had either with electricity or with fuel, though it is still probably somewhat questionable whether oil firing is quite as satisfactory from the control point of view as is gas firing. Mawhinney⁸ has discussed control devices.

In some cases control is better with gas than with electricity because, with the latter, the control is usually on and off; whereas with properly designed gas furnaces the control is from minimum to maximum. The result is that there is no difference in heating due to difference in radiation, as when the power is off the resistors. Furthermore, the atmosphere may be maintained substantially uniform with minimum and maximum control, which is a condition difficult to effect when the control is on or off. On and off control is much more objectionable with oil-fired furnaces, provided with burners blasting through uncovered openings, than with any other. It is less objectionable when *all* the air passes through the burners.

The difference in control, previously noted, may determine the choice between fuel and electricity, for certain operations in which uniform quality and surface are controlling factors. It is, however, entirely feasible to design electric furnaces and controls for minimum to maximum control. For example, this is regular practice in laboratory furnaces for creep testing.

Notwithstanding the equality of control, fuel firing still lagged behind electricity, in that, to compete with electric heat for controlled-atmosphere furnaces in the treatment of steel, the raw products of combustion had to be kept out of the furnace chamber by a full muffle.

Radiant Tubes. An important development in gas firing makes it possible to use controlled atmospheres in gas-heated furnaces without requiring muffles. This is the "radiant tube," a device in which gas, gasified oil, or even pulverized coal is burned inside a heat-resistant alloy tube, the walls of which radiate heat, while the products of

combustion pass on through the tube without entering the furnace itself. The radiant tubes, strung along the furnace walls, suspended in the roof, or lying in the hearth, behave quite the same as though they were huge electric resistors. In order to prevent products of combustion leaking out of cracks or pin holes in the alloy tube, the products of combustion are exhausted from the tube by air-induced

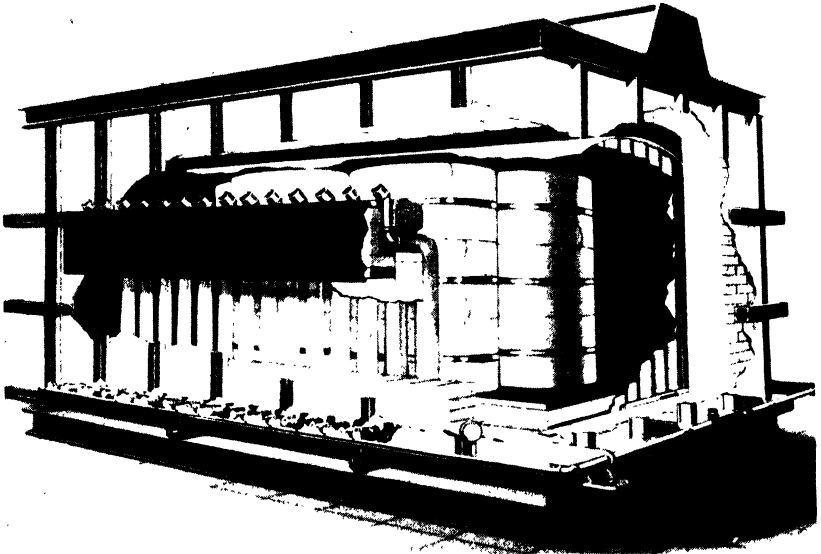

FIG. 86. Radiant-tube annealing cover, with tubes arranged vertically instead of horizontally. (Courtesy Wean Engineering Co.)

draft, by fan, or by an air aspirator, and the tube operates slightly below atmospheric pressure. This method of firing also simplifies the maintenance of an air stream around the central core of burning gas: the air stream protects the tube interior. By avoiding turbulence in the streams of gas and air, combustion may be slowed down so that the flame is very long and free from a zone of excessive temperature. At the point where the flame would otherwise terminate and the tube begin to be cold, the introduction of a "core buster," to produce turbulence, or the location of a bend in the tube, will allow extending the flame still further. Flames of 60 ft or more can thus be produced inside a tube, and with reasonably uniform temperature along the tube.⁹ The tubes are 4 in. in diameter or larger, so that they are analogous to very large resistors only; because of mechanical

requirements for support they cannot be located so close together as can resistors; and a radiant-tube furnace interior is not quite the approach to a "sheet of heat" that can be had with resistors. Because of the size of the radiant tubes it is not feasible to make small furnaces to use them; their main application is to big annealing covers for box annealing (see Figs. 79-80 and Fig. 86) and to large continuous or very large batch-type furnaces. In the annealing cover and analogous uses it is possible to hasten the cooling cycle by passing cold air through the tubes, and in this they have an advantage not possessed by resistors. The hot products of combustion from the tubes may be used recuperatively to preheat the air for combustion.¹⁰

With design and materials worked out for a thin annealing cover or bell that will remain gas-tight in service under direct firing of gas into the space between the furnace proper and the cover (and in the cooling stage of the cycle as well), the radiant tubes can be dispensed with. Some such furnaces have been designed. Fisher¹⁷ describes a commercially operable scheme.

Limitations of Radiant Tubes. In order to radiate to the charge at the same temperature that a resistor would, or at a somewhat higher temperature because they cannot be made into quite so diffuse a source, the firing face of the radiant tube must be hotter than the radiating face, so that for a given furnace temperature the maximum temperature of the metal in a radiant tube must be above that of a resistor; hence the upper temperature limit of usefulness of metallic radiant tubes for satisfactorily long life is below that of metallic resistors. However, this limit is high enough so that the heat-treating operations that require no more than 1750° furnace temperature can be carried out without fear of unduly short life. Some of the applications to annealing of high Si electric sheet raise a question whether tube life will be economical, and some of the types of radiant tube firing with vertical tubes are thought by some to be more severe on the tubes than is the case with the horizontal system. With experience the safe temperature may be improved, but some applications, like copper brazing in a reducing atmosphere at 1950-2100°, in which NiCr resistors have sometimes lasted five years or more, are not easily within the scope of the metallic radiant tube.

However, wartime experience in operation of metallic retorts for the thermal production of Mg, a service not so different from that of the radiant tube, indicates that the upper temperature can probably be somewhat raised. Silicon carbide radiant tubes are claimed to raise the feasible furnace temperature to 2500°.

Future Possibilities. The metallic resistors also have their temperature limits, with 2100° as the upper limit for regular NiCr resistors. Using crimped ribbon or tubular resistors, so as to provide the maximum radiating surface per cross section of resistor, and providing some means for circulating the furnace atmosphere, so as to carry the heat away from the surface of the resistor as rapidly as possible, tends to allow somewhat higher operating temperature. The tubular resistor elements, mounted vertically, are claimed to set up an automatic circulation by a "chimney effect."¹¹

Efforts are being made to produce alloys of higher operating temperatures, and alloys containing, besides Ni, Cr, and Fe, a small percentage of Al, with or without Co, are being commercially introduced that do have higher operating temperatures. These alloys still have drawbacks. Some of them are too brittle to stand cold forming and have to be coiled or bent hot. Some tend to become embrittled with use. Some stretch and sag at operating temperature and require a design that allows proper support. Further development is expected to remedy some of these drawbacks.

Even these alloys will have their upper temperature limit, which will probably fall a bit short of the temperature for hardening of W high-speed steel, though that for Mo high-speed may ultimately be reached.

Molybdenum resistors will stand very high temperatures but cannot be used, bare, in air since they oxidize too readily. They may be used in a hydrogen atmosphere but it is difficult to ensure that in commercial furnaces the hot resistor is never exposed to an oxidizing atmosphere. Molybdenum wires, hermetically sealed into a tightly fitting refractory sheath and provided with terminals for connection outside the furnace, are being developed that may allow commercial operation without necessity for a reducing atmosphere at temperatures even above that of high-speed steel hardening; but their behavior has still to be demonstrated in service.

Nonmetallic Resistors. For the temperature range required in forging furnaces, for the present at least, nonmetallic resistors are required. Carbon resistors have been commercially used but have limitations which have kept them from cutting much of a figure. Gould and Toole¹² have experimented with means of protecting them for use in ceramic firing, but their feasibility for heat-treating furnaces has yet to be proved. The silicon-carbide (Globar) type may be employed. These "Globar" resistors do not have a very long life at their maximum operating temperature, the life being of the order

of 1000 hr, with possibilities of pushing it up to 2000 hr, or more, and with further possibilities in the use of tubular rather than rod resistors. Globar terminals have to be well designed and properly maintained, the resistors are relatively fragile, it is more of a problem to dispose them in the furnace so as to get a diffuse heat source than it is with metallic resistors, and only relatively short Globars are available, so that as a rule they are suited only for the smaller types of furnaces. Since Globar resistors may change in resistance while they are still usable, a tapped transformer or analogous means for voltage variation is needed.

The Globar and the silicon carbide radiant tubes are among the few types of heat source commercially available at present that will serve for heating high-speed steel for hardening in a controlled atmosphere free from products of combustion. One could use a silicon-carbide muffle externally heated by fuel, or could heat direct with a carbon resistor.

Muffle Furnaces. A simple high-speed heating outfit that offers a useful approach to atmosphere control is a gas-fired furnace with two graphite crucibles serving as muffles, into which the steel is charged, with burners at each end. The waste gases from the high heat are used for preheating. On the next round the other burner is used. Charcoal or carburizing compound in the bottom of the crucible with the work properly supported above it, or a suitable gas atmosphere led into the crucible, will supply a protective atmosphere.

Heating of very large pieces for forging has to be done by fuel. Neither radiant tubes, metallic resistors, nor Globars are suitable for these high temperatures and large furnaces.

Direct-Resistance Heating. So far we have considered only the heating methods by which externally generated heat is brought, by one means or another, to the surface of the piece to be heated. There is another possibility, that is, making the piece itself carry an electric current and be heated internally by its own resistance. The method is restricted to pieces of uniform cross section and to those whose cross section is small enough so that the currents involved are not too large to handle. It is admirably adapted to tubing and rod, and materials up to 2½ in. in diameter in solid rod or the equivalent in tubing are handled. With such a method all problems of holding down the rate of heating fall away, since the whole cross section heats up at the same rate and there is no problem of heat transfer or of shielding of one piece by another. Automatic temperature control can be made very precise. The method is applied in the Snead heat-treating out-

fit (Figs. 87 and 88) and in the Berwick heater (Fig. 89) which has been chiefly applied to rivet heating and to heating for upsetting or

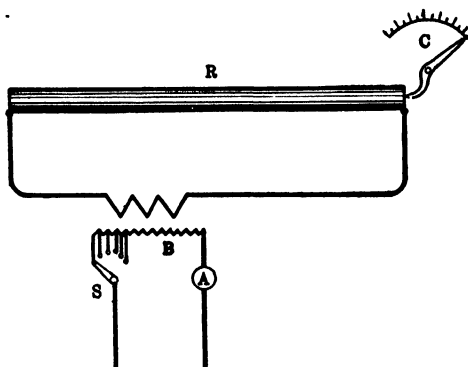

- R - Piece Being Heated
- B - Transformer
- S - Regulating Switch
- C - Temperature Indicator Actuated by Expansion of R
- Ⓐ - Ammeter

FIG. 87. Principle of the Snead process of heat treating.

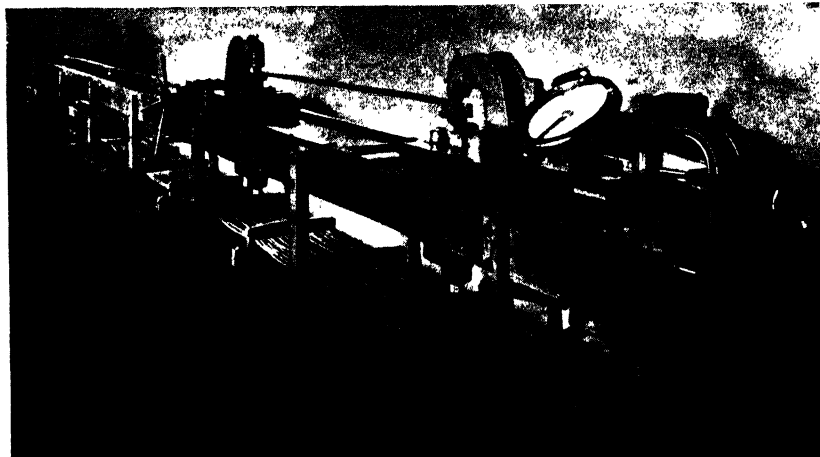

FIG. 88. The Snead electric heat-treating machine. (Courtesy Snead & Co., Jersey City, N. J.)

forging (see Figs. 74-76), though it has very interesting possibilities in heat treatment, especially of objects of uniform cross section.

These resistance methods need careful engineering to avoid cold ends at the contacts, or pitting due to arcing at poor contacts, but they

have been developed to a high degree of perfection for specific uses. By applying "electric-eye" control, the piece can be brought rapidly

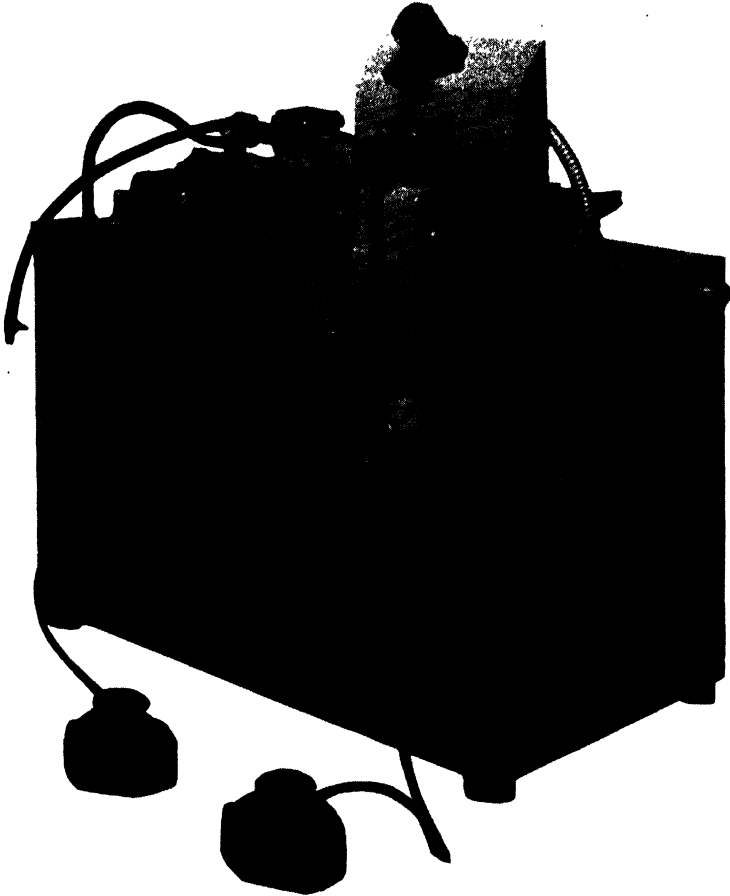

FIG. 89. Berwick heater used for hardening. The cam tip is placed between the current-carrying contacts, and electric current passed through the tip itself. This rapidly heats it to a hardening temperature. The "electric eye" notes when the proper temperature has been reached, turns off the current and turns on the quenching stream. (Courtesy American Car & Foundry Co.)

to the desired temperature without possibility of overheating or burning, the current can be cut off, and, if the piece is not removed within the proper temperature range for forging or quenching, as the case may be, the current may be automatically restored.

One interesting application of a Berwick heater is in heat-treating high-speed steel for drills. The stock is cut to twice the length of the desired drill and heated between a special heavy copper grip at one end and a mercury cup at the other to keep both shanks soft. The center is heated to the desired quenching temperature, quenched, cut, the spiral flutes are ground in, and the tips ground, to make two finished drills. The necessity for stock of uniform cross section limits direct-resistance heating to special cases.

Induction Heating. A somewhat analogous method is the heating of stock by its own resistance by means of high-frequency induction, discussed in Chapter 9, the advantages of which were abundantly proved in many wartime applications, both for forging and heat treating.

Choice Among Alternative Methods. There is a wide variety of actual and potential heating methods from which the heat treater may choose the one best suited to his particular problem. His choice should be primarily based on the suitability for exact and uniform heating of the particular part to be handled. He should not be misled into accepting a method that will not do a good job, by arguments concerning the fuel cost of one method as compared with another. As Trinks⁵ points out, fuel cost seldom amounts to 1% of the final cost of a heat-treated part. It is penny-wise and pound-foolish to use a furnace with poor temperature distribution or to load a charge so densely as to defeat the possibility of uniform heating, just to save a few cents per day in the cost of fuel. If inspection is close, rejects due to irregularity of heating will overbalance the apparent saving, and if inspection is so lax that variations are not caught, failures in service will cost the user far more in cash and the maker far more in reputation than it would have cost to do uniform heat treatment.

Heat a Means to an End. There is no definite relation between quality and uniformity of heat-treated products and any one form of fuel or electricity or furnace. Each has its limitations and field of usefulness.

Heat treatment is a process of transferring heat to and from the product to be heat-treated. It is not merely a process of generating and conserving heat and of controlling temperature. The manner of applying heat to the product is of primary importance.

Heat treating is accomplished with heat—not with fuel or electricity, which are but means to the end. It is a process similar to cooking. The underlying principles apply with equal force in the heat-treating department of the shop and in the kitchen of the ordi-

nary household. The difference is principally in the nature of the product and the "cooking" process.

Fuel and Electricity. The steel doesn't know or care what the source of heat is. It may be affected by the atmosphere that comes from the burning of the fuel and by the direct radiation from a source of too high temperature that overheats the exposed portions, but with the exception of such factors, heat is heat to the steel. It likes uniform heat and dislikes nonuniform heat, but its behavior in nonuniform heating is due to the nonuniformity: it has no likes or dislikes for oil, gas, or electricity as such.

The heat treater should be as uninfluenced by specious arguments for or against a given type of fuel as is the steel itself. He should view the problem solely on the basis of the effectiveness of the fuel and furnace in producing the desired result, and on the final, over-all cost of production, taking all factors into account. In these, first cost of fuel and equipment are seldom the true determining factors.

The long-prevalent controversy over the alleged relative merits of different forms of fuel and electricity, prompted by competitive commercial conditions, is beside the point and clouds the real issue. The relation is constantly changing with the development of improved designs of furnaces.

Combination Heating. Under some conditions, the use of more than one means of heating in a single furnace may be considered. Goss¹³ reports low heating cost and effective temperature control in a continuous-strip normalizing furnace using radiant tubes to heat to 1400° and resistors in the section of the furnace where the stock is heated from 1400° to 1700°. Kjerrman¹⁴ describes a gas-fired annealing furnace, provided with electric resistors located beneath a heat-resisting alloy hearth, for better temperature uniformity.

Comparisons frequently made with claims for advantage attributed to one or another fuel are, in effect, but a comparison of specific types of furnaces operating under specific conditions. The relation may be changed with different types of furnaces or methods of operation in the same plant at the same time.

Fuel Cost Is Only One Factor in Over-All Cost. Furnaces designed to capitalize the unique and outstanding advantages of electricity frequently make possible results in quality and cost of product and working conditions for the operators far superior to those of any other form of fuel furnace. It is ridiculous to consider elec-

tricity on the basis of energy cost alone in light of such conditions which may make any form of fuel relatively expensive regardless of price.

Development of many improved types of gas and oil furnaces that compare favorably with electric equipment of similar general design in automatic control of temperature, atmosphere, uniformity of product, and cost of installation and operation is a striking illustration of the influence of furnace design on the economics of the problem as a whole.

Industry has too long thought in terms of fuel or electricity and not enough in terms of heat application and finished product. The so-called "fuel problem" will be solved in proportion to the manner in which industry learns to think in terms of better heating and cooling, better furnaces, and their influence on the quality and cost of the finished product.

Effective Furnaces for Heat Treatment. Just as in the selection of fuel, many factors enter into the choice of a furnace. Obviously, a great many classes of objects that have to be heat-treated in quantity production differ sufficiently in their requirements from those of other classes to justify the designing and building of special furnaces to do just that job, their capacity being balanced to the production needs.

Continuous Furnaces. Continuous furnaces, with or without atmosphere control as the case requires, using a wide variety of means for moving the stock through the furnace, are generally built to special order, and, though most furnace builders have designs for the most-used sizes and capacities which make those sizes approach a standard, modifications can readily be made to suit a particular problem. With the considerable number of competent firms of furnace makers from whom special designs can be procured, there is little reason for failing to fit the furnace to the job.

But the investment for a continuous furnace must be justified by reasonable certainty of a steady call for its product. The interest on an idle piece of special equipment that costs as much as a continuous furnace does would often counterbalance the higher labor cost of batch operation unless operation is truly continuous. The quality of the product might justify the use of a continuous automatic furnace (even though it is not steadily used) over hand operation, if the types of labor and supervision available are not capable of maintaining uniform conditions. This is discussed further in Chapter 16.

A useful discussion of furnace types is given by Trinks⁵ and by Mawhinney,⁶ whose books should be consulted for a detailed treatment.

BIBLIOGRAPHY

1. A new principle in gas furnaces, *Am. Gas Assoc. Monthly*, V. 26, October 1944, pp. 405-06. See also *Eng. Digest*, V. 2, April 1945, p. 189.
2. R. S. BRADLEY, Insulating firebrick as a furnace lining, *Heat Treating Forging*, V. 23, 1937, pp. 349-52.
3. W. TRINKS, Why and how insulating refractories insulate, *Ind. Heating*, V. 4, 1937, pp. 911-14.
4. J. D. KELLER, The application of insulating material to industrial furnaces, *J. Am. Ceramic Soc.*, V. 17, 1934, pp. 77-87.
5. W. TRINKS, *Industrial Furnaces*, 3d ed., John Wiley & Sons, 2 V., 1934.
6. M. H. MAWHINNEY, *Practical Industrial Furnace Design*, John Wiley & Sons, New York; Chapman & Hall, London, 1928, 318 pp.; *The Heating of Steel*, 1945, 265 pp.
7. A. SCHACK, *Industrial Heat Transfer*, translated from the German by H. GOLDSCHMIDT and E. P. PARTRIDGE, John Wiley & Sons, 1933, 371 pp.
8. M. H. MAWHINNEY, Review of developments in combustion control equipment, *Ind. Heating*, V. 4, 1937, pp. 35-6, 97-8, 199-204, 273-6, 370-4, 443-6.
9. R. J. COWAN, A modern annealing plant for a continuous sheet mill, *Iron Steel Engr.*, V. 14, 1937, pp. 65-9.
10. W. T. ROSS, Nonferrous annealing in controlled atmospheres, *Wire & Wire Products*, V. 13, 1938, pp. 120-3.
11. Tubular heating elements, *Ind. Heating*, V. 5, 1938, pp. 265-6.
12. R. E. GOULD and M. G. TOOLE, Preliminary experiments for the development of a continuous electric ceramic kiln for high temperature burning, *Trans. Electrochem. Soc.*, V. 70, 1936, pp. 111-30.
13. N. P. GOSS, discussion, *Iron Steel Engr.*, V. 13, December 1936, p. 25.
14. B. KJERRMAN, En h ardugn f or kombinerad uppv armning med gas och elektricitet, *Jernkontorets Ann.*, V. 122, 1938, no. 4, pp. 175-77.
15. A. HULTGREN, The electrode salt bath for hardening high speed steel, *Trans. ASM*, V. 25, 1937, pp. 1166-76. See also F. P. PETERS, An internally heated salt bath furnace, *Metals & Alloys*, V. 9, August 1938, pp. 183-8.
16. C. L. NORTON, JR., Pebble heater, new heat transfer unit for industry, *Chem. Met. Eng.*, V. 53, July 1946, pp. 116-19.
17. A. J. FISHER, Recent improvements in cover annealing, *Iron-Steel Engrs.*, V. 24, April 1947, pp. 53-62.

CHAPTER 11

APPLICATION OF HEAT IN HEAT TREATING

Of far greater importance than the kind of fuel or the type of furnace, chosen from among those that can be made to serve, is the way the furnaces are handled in the application of heat to the charge.

Uniformity in Heating and Cooling. Save in the relatively rare cases of differential hardening or local softening, satisfactory heat treatment is predicated upon the piece being *uniformly* heated throughout to the proper temperature and uniformly cooled throughout at the proper rate. Absolute uniformity through the whole operation can never be achieved, for heat persists in flowing from a region of higher temperature to one of lower temperature, and the piece will remain at the same temperature inside and out only when its environment is at that same temperature. Addition or removal of heat is essential, and any change in the temperature of the environment produces heat flow to or from the piece.

Heat Flow. The addition (or removal) of heat must be done through the surface (unless the piece itself is utilized as an electric resistor in heating). The heat flow to or from the interior depends on the rate of temperature change at the surface and on the thermal conductivity and specific heat of the material. If heat will not flow to or from the interior as fast as we wish, because of the resistance of the material to heat flow, there is nothing we can do about it. This is the reason for failure to harden throughout in large sections, and for cracking on heating when heat is applied faster than it can be transmitted through the piece so that thermal expansion or volume changes due to inversions at critical points occur locally instead of simultaneously all through the piece.

The geometrical shape of the piece, as well as its size, influences heat flow. Nothing but a sphere can gain or lose heat at exactly equal rates all over its surface. Even the sphere must be uniformly exposed to the heating or cooling medium; else it will not gain or lose heat in uniform fashion.

When heat treatment is applied to a number of pieces in a furnace charge at once, the mutual influence of the positions of the pieces greatly affects the rate of absorption and loss of heat, so that the problem becomes immensely more complicated.

Arrangement of Charge. The ideal in heating is so to arrange the heat source and the charge that every surface of every piece receives heat at the same rate, and in cooling so to surround each piece with the medium for heat abstraction that all parts of each piece will lose heat at the same rate.

Thermal Gradients. Temperature head is required for heat flow; hence the furnace or heating medium must be hotter than the piece. Actually, in order to heat in a reasonable time, it must be hotter than the final temperature of the piece; else the driving force of temperature difference between inside and outside will be so small that extremely long times will be required to bring the interior to full temperature. Unless the atmosphere is controlled, much damage by scaling or decarburization may be done to the surface during the long holding period.

In practice we are dealing with pieces that have a temperature gradient, with the gradient constantly changing as heating or cooling proceeds. The aim must be so to adjust the heating and cooling conditions that the variations in temperature do not defeat the purpose.

If the heating phase is considered first, the piece acquires heat from its surroundings. To heat it uniformly means that the surroundings and the heat source must all be at the same and, of course, the proper temperature. It is easy enough, with modern control equipment, to hold a given location in a given furnace at a chosen temperature within close limits, as shown by a pyrometer at that point.

Furnace Temperature versus Charge Temperature. It is quite a different thing to ensure that all parts of the furnace are at that same temperature, and still a different one to see to it that all parts of the charge itself are at uniform temperature. The latter is what we are trying to do. The manufacture of records from a recording control pyrometer that draws a line showing no change of temperature does not by any means ensure that we are heating other parts of the furnace or all parts of the charge to that same uniform temperature.

Nor does a temperature survey of an empty furnace showing uniformity throughout ensure that a furnace charge will attain that same uniformity. Our aim is to produce uniform heating in the

charge; the pyrometer record from the control couple is only a means, not an end, and the end itself can be attained only by intelligent distribution and exposure of the charge. It is fortunate indeed that in most heat-treating operations there is some leeway in tem-

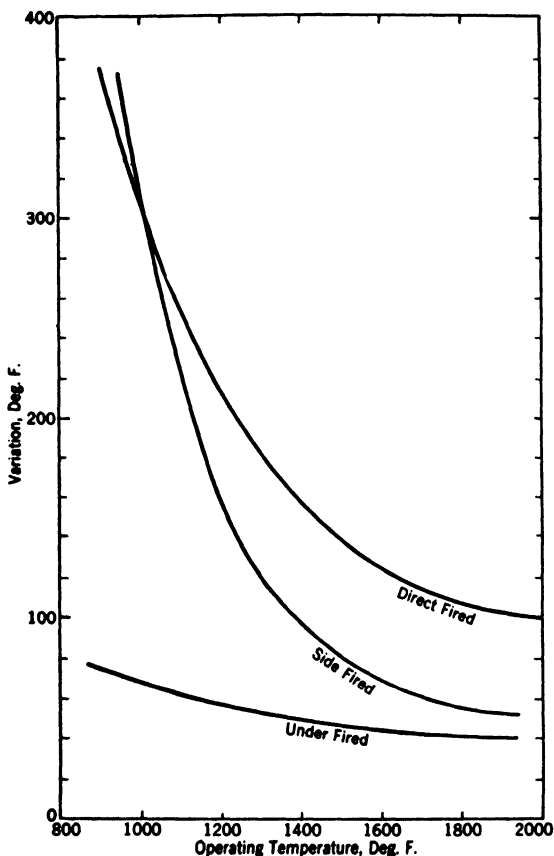

Fig. 90. Temperature variations in some commercial furnaces. (After Mawhinney¹)

perature; else acceptable results could not be obtained in many furnaces with common methods of loading. The failures that do occur are more often ascribable to deficiencies in temperature distribution in the furnace and to faulty methods of loading than to all other causes.

Temperature surveys of furnaces will often reveal shockingly poor temperature distribution. According to Mawhinney,¹ Fig. 90, taken

on commercial furnaces, shows that at normalizing temperature the three furnaces had regions with 50, 75, and 100° variations, respectively, and at process annealing temperatures these rise to 75° in one and about 200° in the others. Such variations have been by no means uncommon in older furnaces; Keeney² records cases of poorly designed fuel-fired furnaces with variations up to 250° and unsatisfactory electric furnaces with 60° difference between front and rear.

Uniformity More Difficult to Attain at Low Temperatures. Figure 90 brings out the fact that furnace uniformity is less at the lower temperatures. This is related to the mode of heat transfer.

Heat is transferred by conduction, convection, and radiation. For conduction there must be actual contact of a hotter material with the object to be heated. The hotter material may be, in heat treatment of solid steel, another solid, for example, a hot hearth, or a fluid, for example, a salt bath, or the gas of the furnace atmosphere. In fluids, convection is concerned as an accompaniment to conduction. The hot fluid is cooled by the piece it is heating, sinks, and is replaced by other hot and lighter fluid, so that there is some circulation from this cause, natural convection. Natural convection occurs in a salt bath in an externally heated pot, with the work suspended in the bath.

Forced Convection. Forced convection can be secured by stirring the bath or moving the work. In a furnace, the atmosphere surrounding the work can be made to move; in a furnace where the products of combustion reach the work, by inducing a draft through the furnace by suitable location of burners and exhaust ports. In a controlled-atmosphere furnace using a muffle, electric resistors, or radiant tubes, forced convection can be obtained by circulating the atmosphere by a suitably heat-resistant fan.

The location of the various pieces in the charge is of utmost importance when natural or forced convection is being utilized, since the flow may be easily impeded by close packing, or so facilitated by having channels of low resistance that the fluid follows those channels without bathing the rest of the charge.

This is of extreme importance when a gas is being used as a chemical reagent in gas carburizing or nitriding, since the stagnant places will become depleted of active gas and the channels will receive too rapid a flow. The analogy of rocks in a stream, with stagnant pools, slicks back of rocks, ripples and turbulent flow, and channels, all depending on the distribution of the rocks in respect to the current and

the mutual shielding effect of each rock on each other, may be recalled to advantage.

The lower the temperature, the more of the heating is accomplished by conduction and convection. Tempering furnaces are being provided with forced convection, and salt-bath furnaces are being heated electrically with electrodes so placed as to produce a pumping circulatory action. Such means for producing turbulence are highly desirable and may be classed as imperative in the lower temperature ranges.

Forced circulation is being applied in bell-type annealing furnaces where each annealing cover is provided with its own fan by which the controlled atmosphere is recirculated. By use of forced circulation in fused salt baths, similar uniformity of convection heating can be had at still higher temperatures.

The circulation of the heating medium is one of the outstanding accomplishments of recent years. It not only leads to striking results in uniformity but also to notable savings in time and fuel.

Packs and Coils. One of the most difficult problems in securing uniformity of heating and cooling is that of box-annealing packs of sheets or coils of wire. A single sheet may be uniformly heated; but, as soon as sheets are stacked, the dead air spaces between them act as effective heat insulators, more effectively the lower the temperature, so that at the relatively low temperature of process annealing heat actually flows to the center of the pack almost entirely by metallic conduction from the edges of the sheets, and very little from the faces of the pack (see Fig. 134, Vol. I). Forced circulation is of no avail unless the sheets are spaced away from each other by some sort of separator that will allow easy gas flow, and this is ordinarily out of the question because of sagging and warping. As a result, the edges of the sheets and the top of the pack are at temperature long before the center of the pack. It is impossible to maintain a pack or a tight coil of strip or wire with the same time-temperature relation in all parts. Pack annealing is, from the point of view of uniform heating, a metallurgical monstrosity, only put up with through necessity. The space required for individual heating of one sheet at a time for the periods necessary for low-temperature annealing (even though the time could be greatly reduced over that needed in pack annealing) would be prohibitive. Continuous normalizing, with its necessity for only a very brief sojourn at temperature, is being forced by the short comings of pack-annealing methods.

It has been suggested⁶ that two driven spools be provided within the bell of a controlled-atmosphere furnace and that a coil of strip be wound from one spool to the other, much as in a film camera, so

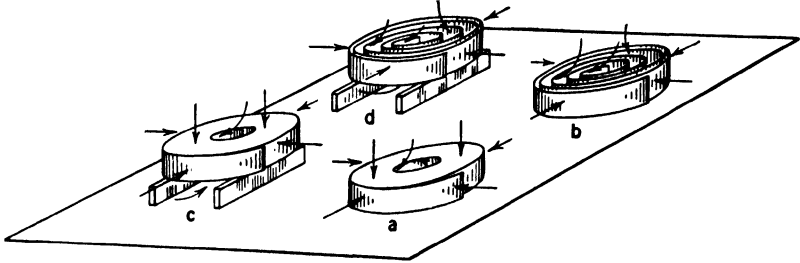

FIG. 91. Different methods of heating or cooling a coil of metal. (Courtesy W. S. Rockwell Co.)



FIG. 92. Bell annealing of coiled strip. (Courtesy Westinghouse Elec. Corp.)

as to expose the stock progressively without shielding by the rest of the coil.

The poor heat distribution in pack annealing is accentuated when very large boxes are used. Some mitigation of the difficulty is obtained by shearing the sheets to the minimum size at which they are

usable and providing resistors or radiant tubes between rows of packs in the same box so that the heat flow to the pack is somewhat more uniform. In annealing coiled wire in bell-type electric furnaces it is customary to stack the coils in a frame and put resistor elements within the "hole in the doughnut," as well as outside the bell. No one would think of quenching a coil of wire in a lead bath in a patenting process, for he would know that the interior turns would cool at too slow a rate.

A little thought about the access of heat and the opportunity for uniform heating or cooling in the close coil at *A* of Fig. 91, compared with the open coil supported as at *D*, will make these points evident. In Fig. 92, note the way the coils of strip are rested on an open spider instead of on a flat base (see also Fig. 80; see also p. 227).

When hot-rolled rod is coiled hot, the rate of cooling is very different in different parts of the coil. To secure uniformity in heat-treated wire, it must be heated and cooled as single wire.

Other Furnace Charges. Whereas the difficulties with packs and coils are obvious, analogous troubles arise with the usual furnace charges even of simple shapes, like rods to be mill-annealed or batches of steel castings to be normalized. In a car-type heating furnace with a tightly stacked load of castings, the interior of the pile may have been underheated and not refined, the exterior may be overheated, and, when the car is pulled out to cool, the exterior may be normalized to fine pearlite while the interior cools so slowly that the product is scarcely different from one that is annealed.

People may be misled by glowing advertisements into thinking that, by some magic ability of a specific furnace to overcome the laws of physics, they can heat and cool uniformly with mass methods of loading. It simply cannot be done. The improved uniformity of continuous strip and sheet annealing or normalizing as compared with coils and packs is bringing a fuller realization of this fact.

Peterson³ makes a specific criticism of mill-annealed bars of SAF 1340, stating that excessive loads are run, so that the time-temperature relations are uneven throughout the charge. He suggests that continuous furnaces should be used, with the charge in one layer, and turned over on its travel, so that each bar may receive the same treatment as its neighbor in both heating and cooling. Similar comments were long ago made by Doyle.⁴

Modes of Heat Transfer. In conduction and convection heating a tumbling of a charge of small parts or forced circulation of the heating fluid is clearly called for. Convection is principally dependent

on the temperature difference between the fluid and the charge being heated or cooled, and on the velocity of flow of the fluid past the surface. It is practically independent of the temperature level at which the operation is being carried on. Radiation, on the other hand, is dependent not only on the temperature difference, but also on the temperature level, because it varies as the difference in the fourth power of the absolute temperature. At 2200°, as Trinks⁵ points out, one degree temperature difference between the source and the receiver will cause 6½ times as much heat to flow as at 1200°. For this reason, at the higher temperatures of heating for full annealing, normalizing, or quenching, radiation becomes the dominant mode of transfer at the higher end of the heat-treating range.

Directness of Radiation. One outstanding difference between the conduction-convection and the radiation modes of heating is that in the former heat can be transmitted around a corner, while radiated heat, like light, travels only in straight lines. To be heated directly by a radiant source, the charge must "see" that source. If a piece is shaded by another, the piece in the shadow has to get its radiation, not directly from the hot source but indirectly by heat that has been radiated from the hot source to the furnace walls, and caroms around by reflection until it can come in a straight line to the waiting charge. Unlike a billiard ball, hitting a cushion, when heat is radiated to a furnace wall, part of it is absorbed. Not until the inner surface of the wall is heated to a temperature above that of the charge does the heat reflect or reradiate to the charge. For heating efficiency, a direct path from source to receiver is necessary, but this direct radiation may cause overheating of the directly heated part of the charge when the radiating source is intensely hot, as is the case with flames.

The arrangement of the charge is then very vital in respect to whether it can "see" the hot source, or the furnace walls, or whether it has to get its heat by metallic conduction through its points of contact with parts that are directly heated and through gas conduction and convection. The "umbrella action" of the charge will have far more to do with the temperature uniformity of the charge than the mere temperature distribution in the empty furnace, important as this is.

Exposure of the Charge. The relation of the temperature indicated by the pyrometer to the actual temperature of the product is illustrated by Fig. 93. The pyrometer chart is a reproduction of one of a set, practically identical in character, indicating the tempera-

ture control in five furnaces operating on the same 24-hr day in the same plant.

Although it might be assumed that a charge would be uniformly heated in any furnace recording such a chart, there would, nevertheless, be a marked variation in the uniformity with which the charge

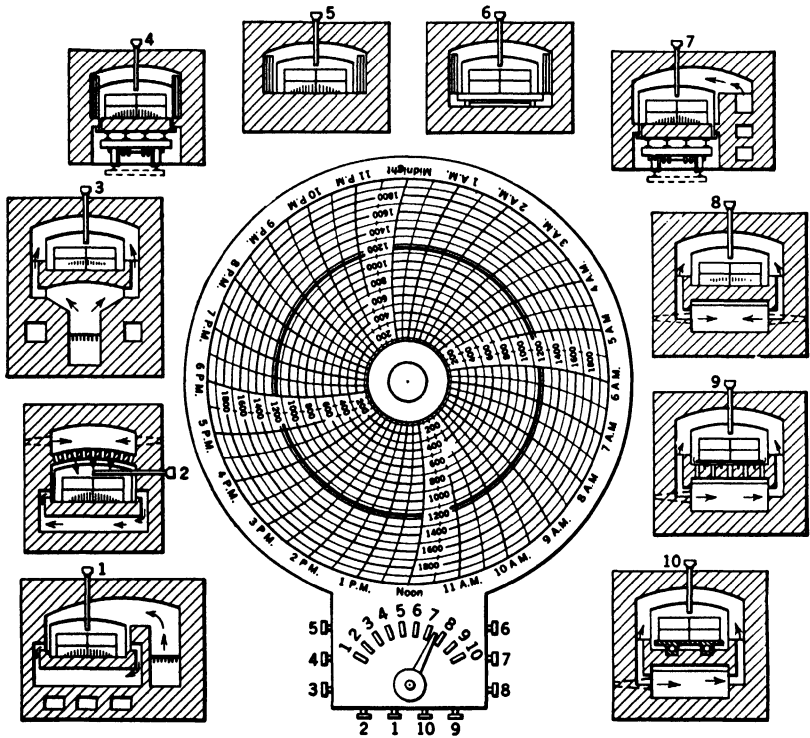

FIG. 93. The charge may not be uniformly heated even though the pyrometer shows the desired temperature. Shaded portions of the chart indicate regions slow to heat under the loading conditions used.

would be heated in some of the different types of furnaces (1 to 10), even though the indicated chamber temperature and the time of heating were the same in each case.

The approximate locations of the incompletely heated zones, reflecting a difference in furnace design or manner of loading, are shown by the shaded sections. The electric furnaces (4, 5, 6) are not exceptions to the rule, for, although they may be alike in manner of generating and controlling the input of heat, they differ, like the various fuel-fired furnaces, in the manner of applying the heat

to the surface of the individual piece making up the charge in the chamber.

The product may likewise vary in uniformity in each of these furnaces, depending on the manner of distributing or exposing the mass (*a* to *q*), as shown in Fig. 94, and with a variation of the mass and surface exposed to the heat, although there may be no variation in indicated chamber temperature or time of heating or cooling.

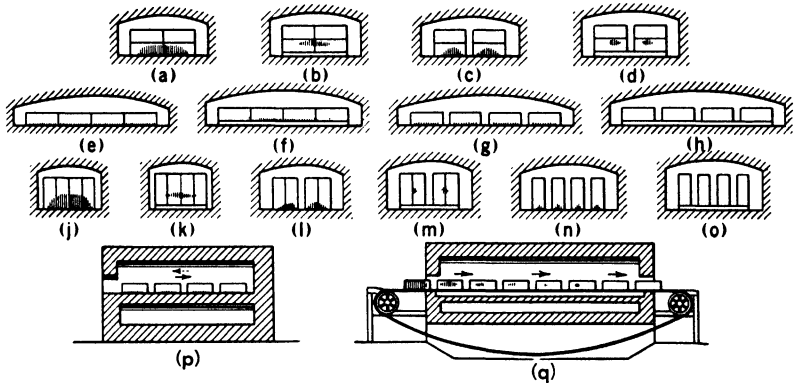

FIG. 94. Influence of furnace design and manner of loading on actual temperature of the charge. The indicated temperature of the furnace itself could be the same in all these instances, while the work may be heated nonuniformly. The shaded portions represent locations that heat less rapidly than the rest due to methods of loading which hamper heat transfer.

In considering the relation of the temperature indicated by the pyrometer to the temperature of the product, it is well to bear in mind that the pyrometer merely indicates the temperature at that part of the furnace chamber in which the couple is located; it does not indicate, necessarily, the temperature of the product. Even though the charge is exposed to the heat for a long period without any apparent change in the pyrometer indication, it is unsafe to assume that the pieces in the chamber are heated alike unless they are exposed in the same manner, for the same time, at the same rate, and in the same atmosphere.

The principle involved is similar to that governing the conduct of cooking operations. It is wise to "keep an eye on the biscuits" as well as on the thermometer indicating the temperature maintained at some point in the oven of the stove, or the chamber of the furnace. Cooking on a large scale with automatic equipment, as in the manufacture of bread or crackers, removes many of these variable factors

because the product is uniform in character and subject to heat in a manner that provides for individual exposure and control of the factors governing the time and rate of heating or cooling.

Those who are inclined to accept the pyrometer record as evidence of the temperature in the product, without sufficient thought of the variable factors previously referred to, would do well to consider the possibility of producing uniform loaves of bread or crackers on a large scale with the methods of heating, cooling, loading, and exposure so common to the metallurgical industries.

The final test of food, in the case referred to, is the quality of the finished product. The use of pyrometers and control devices is but a means to this end. The same should be true in the heat-treating plant, because heat treating, after all, is but cooking on a large scale.

Control. In some shops we find elaborate provision for indicating and controlling temperature, but little thought of controlling the many other factors affecting the uniformity with which the product is heated or cooled. In many instances, the operation is really one of manufacturing pyrometer records instead of producing uniform metal products.

The economic test of the operation is proof in the form of uniformly heat-treated products, not merely evidence in the form of pyrometer records indicating the temperature at which it may be alleged the product was heated or cooled. Either the product is uniform or it is not. If not, then the testimony of the pyrometer chart is outweighed by that of the testing machine.

Unwarranted emphasis on temperature control as the essential element in heating or cooling operations and on output, fuel consumption, etc., as the determining factors in cost, frequently leads to neglect of the influence of the time, manner of exposure, and the rate of heating or cooling upon the quality and cost of the finished product. It is the acceptance of heat by the charge, not the mere development of heat in the furnace, that is the ultimate goal.

Control of time and rate of heating or cooling is just as essential as control of temperature. Time and temperature are so inseparably linked that it would be well to associate the two as one factor—*"time-temperature."* The use of such a term may tend to discourage the usual abstract consideration of temperature without regard to the time necessary to attain a given temperature and to encourage the thought that there are a number of factors, subject to control, in addition to temperature, that affect the uniformity with which the product is heated or cooled.

The manner in which heat is applied to the surface of the product to be heated, which very largely reflects the design and method of loading and operating the furnace, is of paramount importance and necessarily involves factors, affecting the manner and time of exposure and the rate of heating and cooling, which are as important as the factors that influence control of temperature. All these factors must be considered in order to obtain a product as uniform as the pyrometer indicates it should be.

Methods of Loading. The influence, on the time and rate of heating, of the exposure resulting from a given manner of loading and

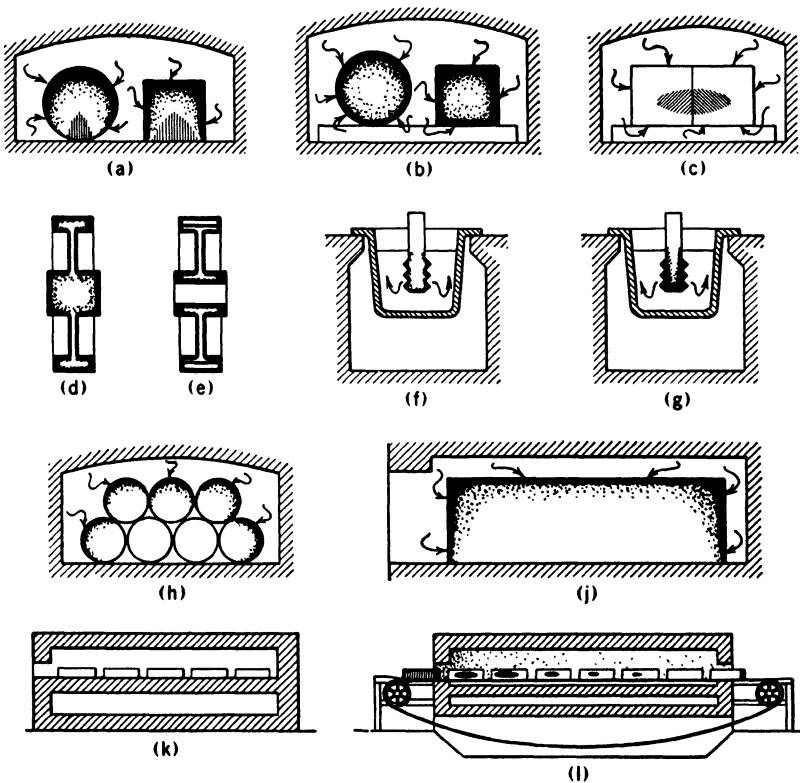

FIG. 95. Factors influencing time and rate of heating.

from variations in the surface, shape, and section are illustrated by the diagrams in Fig. 95.

A round billet of given mass and weight, placed on the hearth of a furnace (a), will heat less uniformly and at a different rate than if

placed above the floor (*b*) to permit circulation underneath and uniform application of heat to the entire surface.

Rate of Heating. A billet of the same mass and weight in rectangular form will heat at a different rate and to a different degree of uniformity if placed in either position, on account of the relatively larger surface in proportion to the mass at the corners, which are the first to heat and the first to cool. Even though the shape of the rectangular billet may permit a higher rate of absorption, it is obvious that the difference in shape may actually call for a lower rate of heat transfer to permit a slow rate of heating, in order to prevent a material difference in temperature, or time of exposure to that temperature, between the corners and center of the mass.

The same billet in the form of an irregularly shaped crankshaft or axle with variable sections will heat in a still different manner if placed in either position, because of the difference in surface and section.

A gear blank (*d*) will absorb heat at an entirely different rate from the finished gear (*e*), because of the difference in section incident to the shape of the teeth and the opening for the shaft keyway, etc.

A similar condition may result from the relation of the pieces to each other, even in a chamber that shows every indication of uniform temperature. Thus, two rectangular pieces placed above the floor, with provision for heat application to all surfaces, will heat at a different rate and to a different degree of uniformity when placed in contact with each other (*c*).

Heating in baths of molten metal, salts, etc., is generally considered to be an ideal method for operations in which uniformity of heating and temperature control are essential factors. However, the difference between heating in a molten bath and in a "bath" of gases, with the same method of exposure, in the chamber of a furnace is not so great as is generally supposed. The essential difference is in the influence of the bath on the surface of the piece, the resistance to sudden changes of temperature, and the conductivity of the bath.

The necessity for suspending the piece in a bath naturally results in an ideal condition for uniform "heat application" to the surface and eliminates many chances for error likely to result from improper methods of loading in the chamber of a furnace, particularly if it is desired to localize the heat, as in hardening the cutting section of a tool.

Inequalities of temperature may exist throughout a bath without being indicated by the pyrometer in its customary fixed position, as may be observed in heating the bath from a cold condition, in introducing a comparatively large mass of cold material, or when the input of cold material does not correspond with the withdrawal of heated material.

Effect of Time. The use of a bath does not eliminate the necessity for considering the time element with reference to the factors that influence the rate of heat transfer and uniformity of heating or cooling. A difference in relation of mass and surface, due to a difference in shape or section, naturally affects the rate of heat transfer and the time required for saturation. Thus, if a tap be suspended in a bath of molten metal (*f*), Fig. 95, the comparatively thin sections will reach the temperature of the bath before the center of the piece; and, even though the center ultimately attains the same temperature (*g*), the fact remains that the thin sections have been subjected to that temperature for a longer time, which of itself is frequently sufficient to create a difference in structure.

This illustrates the difference between uniform temperature in a furnace and uniformly heated product, and the necessity for considering the influence of the factors that affect time or rate of heating, as well as those that affect control of temperature. Uniform heating is a relative term. Absolute uniformity is rarely, if ever, attained.

The necessity for uniform time and method of exposure and rate of heating or cooling, to produce uniform product, indicates the need for a method of heating, cooling, and handling that will provide the same treatment of each piece.

Continuous Furnaces. "Batch heating" or cooling rarely results in uniform product, regardless of the indication of uniform chamber temperature, because of the lack of uniformity in method and time of exposure and rate of heating or cooling. Variation is generally disclosed by the structural difference between the pieces at the outside of the charge and those at the center or bottom.

The advantages of the continuous furnace (*l*) in providing a regular input and output of material and control of the factors affecting time and rate of heating suggest the application of the principle of individual treatment whenever the manufacturing requirements and plant conditions will permit.

Heat Application. The difference between control of temperature in a furnace and control of the application of heat to the product is not merely a function of controlling the input of heating energy,

whether it be fuel or electricity. The manner in which the heat is applied to the surface of the piece, which very largely reflects the design and method of operating the furnace, is of paramount importance and necessarily involves factors affecting the element of time and rate of heating and cooling, which are equally as important as the factors that influence control of temperature.

The ideal condition for the production of uniformly heated product comes nearest to being attained when the heating or cooling medium is uniformly applied to the entire surface of each section or piece and to each piece individually in the same manner, at the same temperature, at the same rate, *for the same time*, in the same atmosphere, in equipment properly adapted to the nature of the process, form of fuel or electricity employed, manufacturing requirements, and plant conditions.

Factors in Heating. Temperature is a more or less fixed factor, determined by the nature of the process and the physical or chemical requirements of the product to be heated or cooled. It should be considered with reference to the distinction between the temperature of the chamber or bath in which a piece is exposed and the temperature throughout the piece itself, which is naturally affected by the time of exposure and the rate of heat absorption.

Time of heating is a variable factor and is influenced by the manner of transferring heat to or from the surface of the piece; the manner of loading, or exposure; the relation of one piece to another and to the source of heat; the difference between the temperature of the piece and that of the chamber or bath in which it is exposed; the rate of circulation over the surface; the conductivity of the material of which the piece is composed; the relation of the mass of the charge to the chamber or bath; and other factors outlined in the accompanying chart.

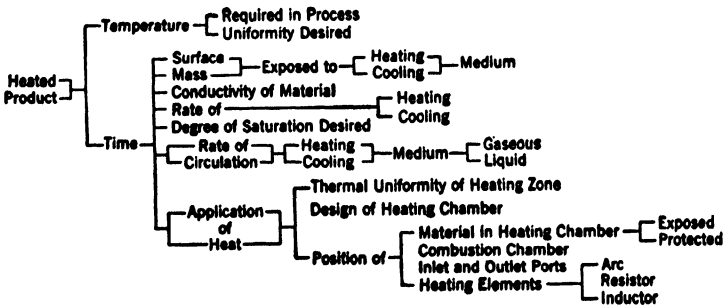

Temperature-time factors.

Rate of heating or cooling material must be determined with reference to the physical or chemical requirements of the finished product, and with reference to the mass, shape, section, exposed surface, and manner of exposure of the material, all of which affect the rate at which it *should* be heated or cooled, regardless of how fast heat *could* be transferred.

An attempt to take these factors into consideration in the annealing of closely wound coils so as to approach the condition of the loosely wound coils of Fig. 61 is described by Armstrong and Schlitt.⁷

The coils, placed one above the other within the bell, are separated by plates provided with holes and vanes. The controlled atmosphere, preheated on the heat exchanger principle, is forced, by a high-capacity heat-resistant alloy fan, up along the outside of the coils. As it reverses direction, instead of coming back solely through the center hole of the coil, it is diverted by the separating plates and directed against the edgewise direction of the coil. The stagnant cooled gas between even tightly wrapped coils is thus forced out and replaced by hot gas, and faster and more uniform heating results.

BIBLIOGRAPHY

1. M. H. MAWHINNEY, *Practical Industrial Furnace Design*, John Wiley & Sons, New York; Chapman & Hall, London, 1928, 318 pp.
2. R. M. KEENEY, Industrial heating for heat treatment, *Metals & Alloys*, V. 1, 1930, pp. 508-13.
3. O. N. PETERSON, New concepts of metallurgical control in automotive steels, *Steel*, V. 100, June 14, 1937, pp. 36-9, 72.
4. J. A. DOYLE, *Elements of Industrial Heating*, September 1922.
5. W. TRINKS, *Industrial Furnaces*, 3d ed., John Wiley & Sons, V. 2, 1934.
6. Can. Pat. 433,397.
7. H. H. ARMSTRONG and L. J. SCHLITT, A new method of coil annealing, *Iron & Steel Engr.*, V. 24, June 1947, pp. 35-43.

CHAPTER 12

CONTROL OF THE COOLING PHASE. COOLANTS

The chapters in Vol. I on normalizing and hardenability as well as comments in several other chapters, have brought out the fact that the rate of cooling is no less vital than the temperature and time of heating.

Too often the importance of the cooling rate is lost sight of, and the cooling operation is thought of merely as a means for getting the steel cool enough to handle, its metallurgical effects being forgotten.

Mass Cooling versus Individual Cooling. If, in normalizing, the heated charge is drawn from the furnace and dumped on the floor in a mass, or if a closely packed car of steel castings is drawn from the furnace without separation of the castings to allow uniform access of air, the pieces on the outside of the pile may be normalized, but those in the center will not be. In this case air may be looked on as a quenching medium, and its uniformity of temperature and of access to the work, so that the work may cool uniformly, should be guarded almost as carefully as in a liquid quench.

It has been brought out in Chapter 12, Vol. I, that the quenching power of oil and water varies with their temperatures. Holding the quenching medium at a definite temperature by cooling coils or the use of a large volume is essential to uniform results. Circulation of the quenching medium or movement of the piece being quenched in such fashion as to avoid the retention of an insulating gas film, or of gas bubbles that retard heat transfer and cause soft spots, is a prerequisite.

Dumping a charge into a quenching bath, instead of quenching the pieces individually or so scatteredly that no piece interferes with the cooling rate of its neighbors, can do even more harm than the non-uniform heating that has been warned against in the preceding chapter.

It is just as necessary to cool individually as to heat individually. The fact that quenching may be a matter of a few seconds, while heating may be a matter of many minutes, or even an hour or more,

indicates the necessity for considering the influence of "physical factors" in cooling as well as in heating. Just as in heating, all the factors of time, temperatures, mass, and surface are involved in cooling, and their proper adjustment is as necessary as in heating, in order that the finished product shall be uniformly good.

Necessity for Uniformity. Lack of uniform quenching is responsible for much more variation in uniformity in the product than is generally sensed. Unfortunately, the pyrometer record of the furnace is sometimes accepted as sufficient evidence of uniformity, but in quenching, as in heating, the temperature of the chamber, or of the bath, is not proof of uniform heating or cooling, the test of which is in the product itself. It is as necessary to learn "how to cool" as "how to heat."

Even with stationary electric or gas furnaces used for heating small parts, a quenching machine of some kind is frequently justified, even though the furnace itself is properly noncontinuous in output.

To avoid warping in quenching of an automobile axle shaft, it may be placed on rotating rollers that cause it to spin rapidly, thus exposing it uniformly to the stream of quenching liquid that impinges on it.

The Human Element. Except under conditions where continuous methods of heating and cooling are in use, this feature becomes more than ever dependent on the operator, and there is practically no form of automatic control for regulating this phase of the cooling cycle. At this point the operator can either make or break the cycle of operations and lead to success or failure.

Heat treating begins with the initial heating for forming, forging, or rolling, and ends with the final *cooling* phase of the process.

Coolants. So far, cooling has been discussed as though any coolant water was equivalent to any other water and any coolant oil equivalent to any other oil. They are not, and if the coolant temperature rises, the differences become great. When red-hot steel meets water or oil and the same water or oil stays in contact with the steel surface, the water has to boil or the oil volatilize or crack. Hence, the steel, in ordinary quenching, is moved through the coolant, in the hope of avoiding steam or vapor by making the piece continually reach fresh coolant. A more effective way is to pump or spray the coolant against the piece, with sufficient pressure to sweep away any gas bubbles that otherwise tend to cling to the steel, shielding it from effective cooling, and thus producing soft spots.

Coolants under Pressure. Figure 187, Vol. I, shows that considerable can be accomplished in this way, in relatively small pieces, since the center of a 1-in. sphere cooled in the high-pressure water spray cooled as fast as that of a $\frac{3}{4}$ -in. sphere quenched in still water, though, as was shown in Fig. 186, Vol. I, the rate of surface cooling was not much altered in the higher-temperature range. As the size of the piece increases, the center is less and less influenced by the rate of abstraction of heat from the surface, but the temperature gradient near the surface is always the steeper, the faster the surface is losing heat; so, even in a piece so large that it is still slack-quenched in the center, the depth of the successfully hardened zone will be greater when the surface has lost heat more rapidly.

Contact with Coolant. Any surface condition of the hot steel, which keeps it from good contact with the coolant, slows down the

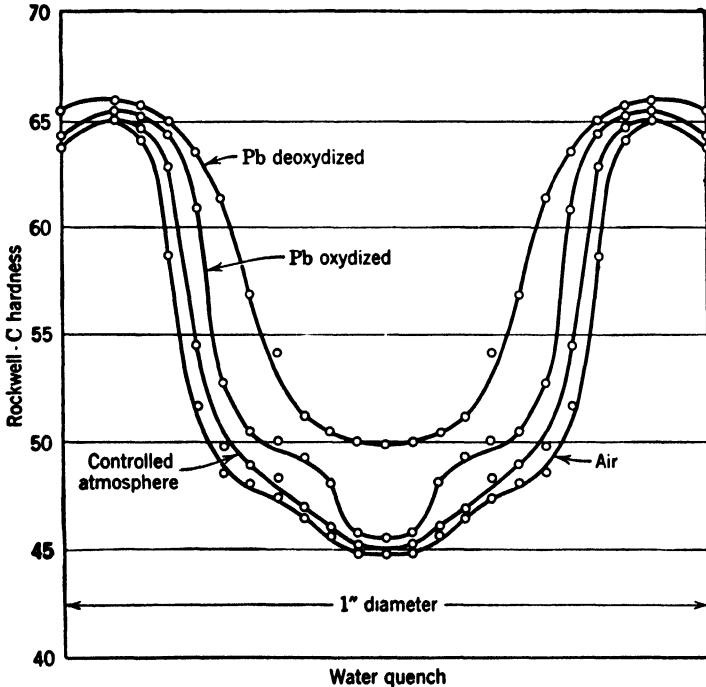

FIG. 96. Hardness distribution in 1-in. rounds of a water-quenched steel as influenced by surface scale. Other factors all substantially constant.

cooling. The surface may have a heavy scale which acts as an actual insulator, or it may merely have a matte or slightly rough surface on which gas bubbles are easily formed, and to which they

cling more readily than to a smooth metallic surface. Particularly bad is a scale or oxide film that comes off in some places and stays on in others, causing soft spots where it clings.

The effect of even a slight oxidation on quenching is shown by Figs. 96–97 from Bain.¹ The marked difference between water and oil quenching on the behavior of the specimens heated in air and having appreciable scale shows the greater ability of water to cause scale to crack off cleanly—brine¹⁸ has a still greater ability—and indicates that the surface condition of the piece being quenched must be especially carefully watched, in oil quenching.

A scale heavy enough so that it *all* cracks off instantaneously presents less of an obstacle to rapid cooling than a thinner but adherent one. Brine and caustic soda solutions make scale crack off better than plain water, as Zavarine² demonstrated. They also raise the boiling point, giving a bit more leeway before gas bubbles start to form.

A little soap in the quenching water will form a film over the steel and greatly retard cooling. Washing the hands with soap in the water of a quenching tank is not a good idea.

Coolant Temperature. The greater the leeway between the temperature of the quenching water and the boiling point, the more effective the quench as Fig. 98 shows. Hence, the volume of water in relation to the size of the piece should be kept high, and the water should be kept cool. Icing of water or brine only slightly improves cooling over having the coolant at ordinary temperatures, but small increases above ordinary temperature do have a deleterious effect, which becomes very bad as the temperature approaches the boiling point.

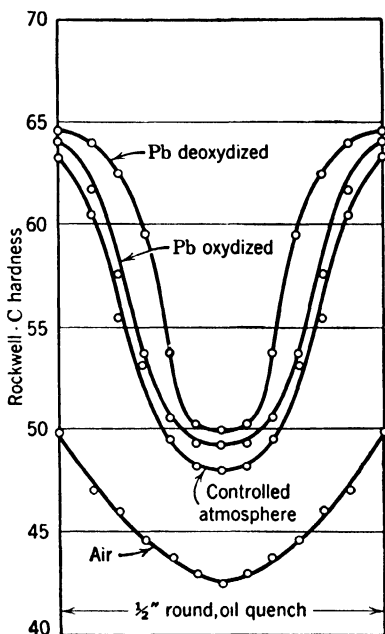

FIG. 97. Hardness distribution in $\frac{1}{2}$ -in. rounds of an oil-quenched steel as influenced by surface scale. All other factors substantially constant.

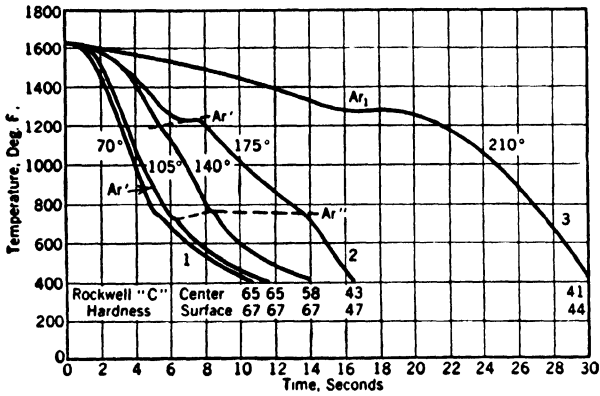

FIG. 98. Time-temperature cooling curves taken at the center of 1/2-in.-diameter cylinders of 0.95% C steel when quenched from 1605° into still water, with the water at the temperatures shown. (French 4)

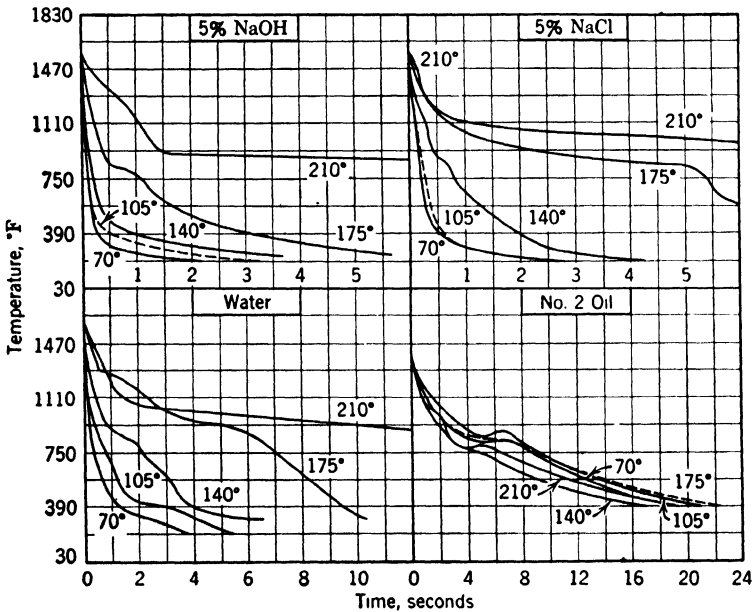

FIG. 99. Surface cooling curves of 0.96% C steel cylinders quenched from 1605°F into liquids at different temperatures. Coolant motion was 3 ft per second: Cylinders were 1/2 in. diameter by 2 in. long. Each curve is the average of two or three tests at a point meeting the direct flow of the liquid.

It has been seen from Figs. 185 and 186, Vol. I, that surface cooling in oil is not so much slower than in water at the higher temperatures as it is at lower temperatures. The reduced rate in oil in the temperature zone in which martensite is forming may be a major cause for less trouble from cracking on oil quenching.

One might expect that, when a slow quench is desired, hot water or hot brine might serve as well as oil, but Fig. 99 from French,⁴ shows how tricky the behavior of these aqueous coolants would be at their higher temperatures. French considers that the 5% NaOH at around 175° might have limited application as a coolant intermediate between water and oil.

Figure 99 shows that the commercial oil used by French did not vary much in its cooling power with changes in temperature. This is to be expected because the temperature at which the oil vaporized enough to give its "flash point" was around 700°; that is, the spread between room temperature and that at which vapor is produced is far greater with the oil than with water.

Langston³ found that 0.4% H₂O suspended in a "fast" oil greatly reduced its cooling power, doubtless because of the steam blanket produced by the moisture.

Most quenching oils are not vastly affected by small changes in temperature, but their temperature should nevertheless be kept down for the sake of stability of the oil and avoidance of fire hazard.

Oils. There is considerable discussion about quenching oils, ranging from the point of view that a fast-quenching stable oil, specially compounded, may be economical in the end, even at a high initial cost, to that of several large users who think that oil is oil, and a cheap mineral oil, uncompounded, does all that is asked of a quenching oil, and the main specification is a high enough flash point to avoid a fire hazard. This point of view is taken by Spring and coworkers,⁵ whose conclusions were not accepted by several discussers of their paper, nor by Wescott and Vollmer.⁷ French's data in Fig. 100 indicate that the oils he used did differ, but not greatly. However, Gill and coworkers⁶ cite tests in which the ability of oils and water to extract heat during the initial stages of quenching was determined, as the percentage of the total calories contained in a hot specimen, extracted in a 5-sec immersion. Under the conditions of test, water removed something over 50%, different oils from 16 to 37%. Gill appraises the "rapid" oils as of value in work with steels of border-line hardenability. This is concurred in by Locke⁸ and by Fletcher and Cohen.⁹

Figure 101, after Wescott⁷ shows that addition of fatty oil to mineral oil increases the cooling rate at temperatures of interest at the pearlite nose.

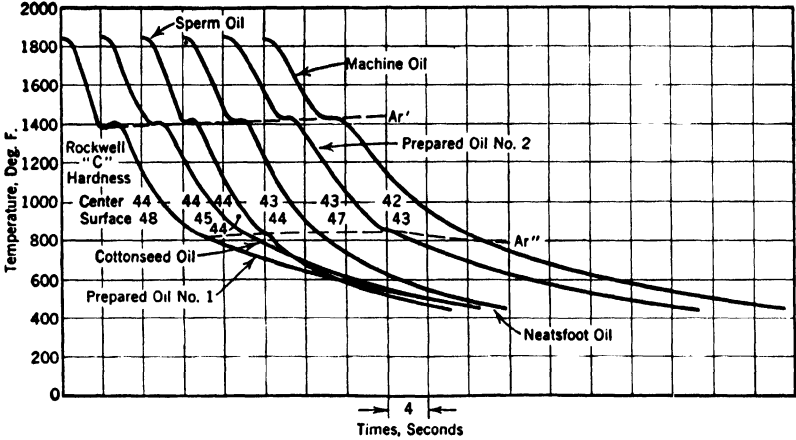

FIG. 100. Time-temperature cooling curves at center of 1/2-in.-diameter cylinders of 0.95% C steel, quenched from 1605° into various oils motionless at 70°. (French⁴)

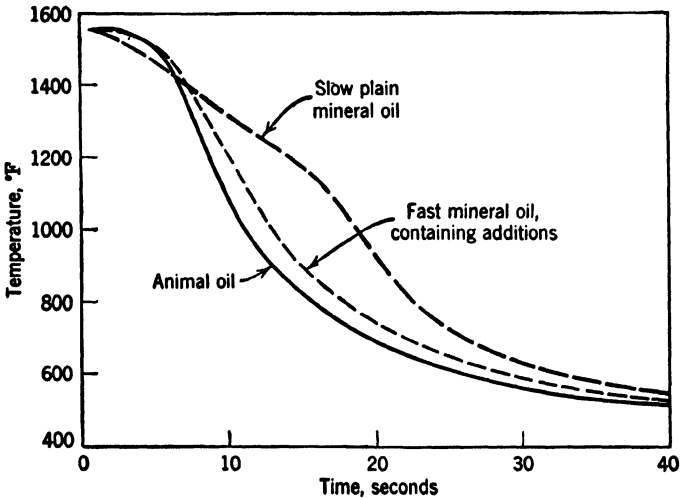

FIG. 101. Cooling curves for center of 1 3/10-in.-diameter cylinder of 18:8; no agitation.

Quenching into a layer of oil on top of water to secure the cooling rate of oil through the pearlite interval and that of water in the

bainite region is sometimes applied. However, this is just the reverse of the cooling rate best adapted to avoid cracking.

Brine and Other Solutions. Although air, oil, and water are the common coolants, other gases and liquids are coming into use for special purposes. Sodium carbonate solutions¹⁰ or sulphuric acid solutions are sometimes used instead of brine. These additions serve to raise the boiling points above that of water and thus delay the formation of steam. The behavior as to making scale snap off promptly is a more individual trait of each solution, and, in this, brine of about 8% NaCl seems to excel, though 3% NaOH serves.

Glycerine solutions, water-glass solutions, and emulsions of oil and water have been suggested for cooling rates intermediate between water and oil. Although very specific cases may dictate a trial of some of these expedients, very little actual use is made of them. Rose¹¹ says such solutions and emulsions have a detrimental effect owing to too great cooling rates at low temperatures. Gill⁶ sums it all up by saying, "Many water-base equivalents of quenching oils have been attempted, but these will never succeed."

Yet Reiss¹² reports that, in quenching after flame hardening, distortion was less with water containing 1 to 1½% soluble oil than with plain water. See Fig. 240, Vol. I, for effects of soluble oil.

Gas Quenching. Other gases have higher heat capacity than air, and they can be chosen so as to be nonscaling and nondecarburizing. If such a cold gas is blown against hot steel fast enough, it can abstract heat fast enough to produce fine rather than coarse pearlite at the surface, or even throughout a sufficiently thin section. Lehrer¹³ has described such a "gas-quenching" process for 4130 or 8630 aircraft tubing, in which tubes with 0.05-in. walls are cooled from 1650° to black heat in 30 sec, which is considerably faster than they will cool in still air. By proper choice of gas they can be kept bright.

As Figs. 179–189, Vol. I, have shown, in ordinary quenching it is desired first of all to retain all austenite past the "nose" of the S curve at about 1300° and just below, where the urge to transform is greatest. Next, it is generally desired to get past the leftward swing of the bainite curve so as to avoid slack quenching, and, for this, sufficiently rapid cooling clear down to the start of the martensite transformation is required. However, the bainite curves for some highly alloyed steels do not swing very far leftward at temperatures above, say, 500°; the curves have a deep bay, so that, with them, a coolant that cools rapidly at 1300–900° is all that is required to re-

tain austenite. Hence, molten-lead or fused-salt baths have possibilities as quenching baths, not the least of which is that of giving time for the center to cool down to the temperature of the surface before the final quench, a behavior utilized in the misnamed "mar-tempering process."

They also allow arresting the cooling above the temperature at which martensite forms, and then holding at that temperature long enough for the production of bainite at this selected temperature level, which is the "austempering" process, described by Legge. Similar principles, under less simple control, have long been in use as "interrupted quenches" (see Chapters 18 and 19, Vol. I).

Salt Quenching. Although quantitative data strictly comparable to those mentioned before from French are lacking for salt, Shepherd¹⁴

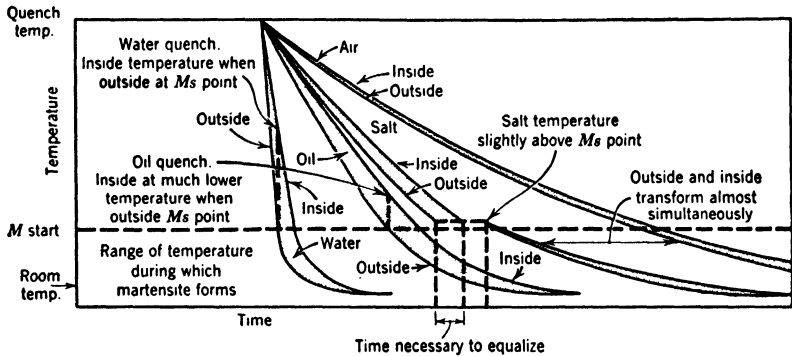

FIG. 102. Cooling rate of outside and center of similar steel samples quenched in water, oil, salt bath, and air.

compares the quenches on the end and center hardness of cylinders of various dimensions of N.E. 8744 steel (Fig. 240, Vol. I).

Schematically, these center- and surface-cooling rates (of relatively small sections in salt) are shown in Fig. 102.¹⁴ The hot salt cools somewhat more slowly than oil. So salt quenching to avoid pearlite at Ar_{3-2-1} requires a rather highly alloyed sluggish steel.

Lead-Bath Quenching. Lead-bath cooling curves for varying lead temperatures are given for the center of a $\frac{1}{4}$ -in.-diameter cylinder by Gensamer and coworkers¹⁵ in Fig. 103.

Cooling in the Low-Temperature Range. Although the gap between surface and center temperatures at the pearlite point is greater with water than oil, as Fig. 104 from French⁴ shows (because the surface is losing heat faster with water, when the martensite-forma-

tion temperature is approached), at the temperature range where oil cools the surface more slowly, the center tends to catch up in the case of oil cooling. However, Figs. 184-186, Vol. I, will have made clear

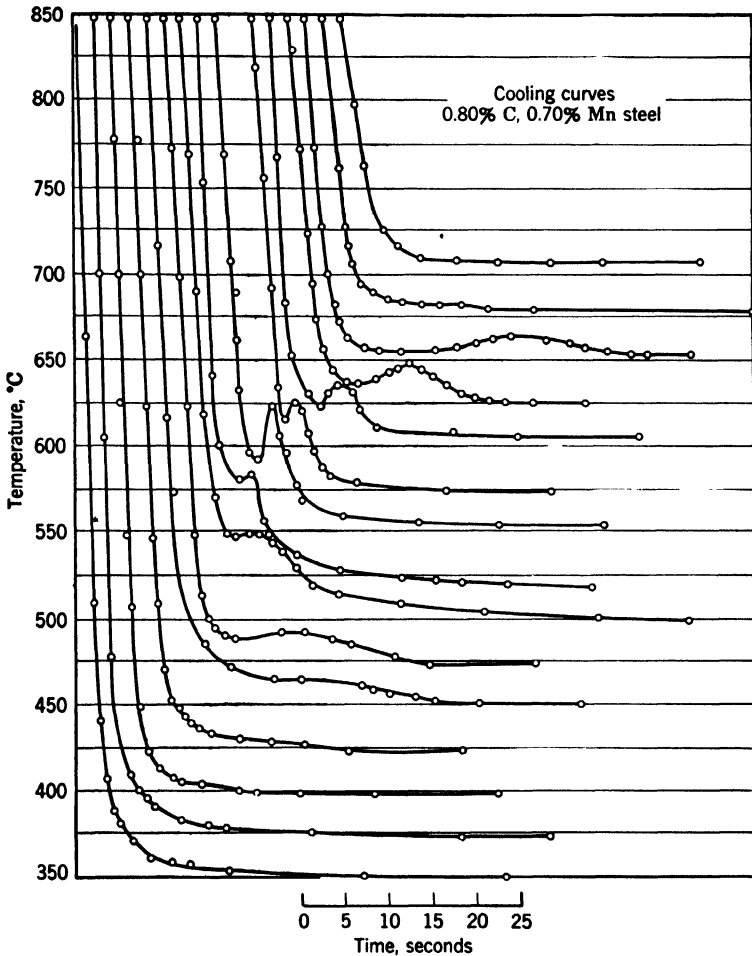

FIG. 103. Cooling curves for centers of 0.26-in.-diameter cylinders of plain C eutectoid steel quenched into lead baths at various temperatures.

that the lag between surface and center varies vastly with section size.

In many discussions of cooling rates and their effects, the cooling rate in the lower-temperature range is disregarded, and sole attention

paid to the rate of cooling at 1300°, or at the temperature halfway between the quenching temperature and that of the coolant. This

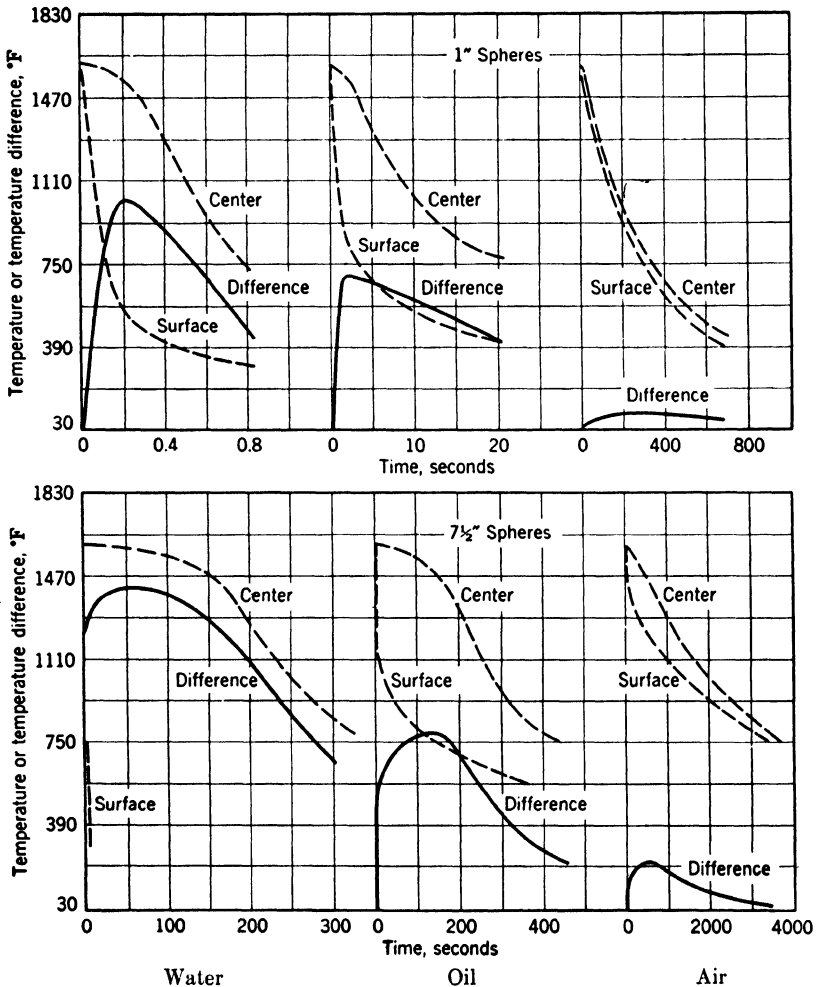

FIG. 104. Surface and center temperature of spheres 1 in. and 7½ in. in diameter when cooled from 1605°F in water, oil and air.

is done in order to allow various mathematical calculations, which are mostly of limited applicability.

Disregarding the low-temperature range comes close to making the erroneous assumption that oil quenching is little different from water quenching since the cooling rates diverge most markedly at the low

temperatures of the important M_s - M_f range, and is fully equivalent to the even worse assumption that, as long as the pearlite transformation is avoided, it is immaterial whether bainite or martensite is formed thereafter, whereas it is certainly material.

Die Quenching. Especially in irregular sections, the transformation to martensite in quenching tends to produce warping. If good contact can be made between the hot austenitic steel and anything else that will abstract heat rapidly, quenching may be accomplished. By pressing the austenitized piece between closely fitting dies, some of the warpage can be mechanically prevented. This quenching practice is of long standing for certain gears, and Gallistel¹⁶ describes its use for a variety of thin flat pieces. He states that a piece 0.03 in. thick will cool about twice as fast when gripped between cold dies as when quenched in oil.

The stock should not be so thin as to be quenched when laid on the lower die before the upper one can be brought into contact. The steel to be quenched must be scale-free, preferably austenitized in a controlled atmosphere. The working surfaces of the dies are Cr-plated. Under such conditions only moderate pressure need be exerted by the quenching press to secure proper contact.

The dies are relatively massive and cool the work by conduction. The dies are water-cooled in order to keep the die cool between strokes of the press, but the abstraction of heat from the piece being quenched is by the metal of the die.

Such an operation is said to give through hardening in $\frac{1}{4}$ in. thickness of heat-treatable C steel and in $\frac{1}{4}$ in. of steel of the oil-hardening type.

The process is best adapted to symmetrical objects, but, with special dies, its use has been extended to very irregular objects. Liedholm¹⁷ shows how hollow steel aircraft-propeller blades, with their tapered wall section and peculiar contour, are kept from warping by die quenching in a special fixture. In this case both the quenching effect of the die and that of auxiliary high-pressure jets of water are utilized.

Quenching of irregular objects to produce martensite produces internal stress, as discussed in Chapter 19, Vol. I, which involves danger of cracking. Irregular objects, sometimes very massive ones, are conveniently produced by casting. Large steel castings involve quenching problems of their own, deserving of a chapter. Ferrous castings other than steel are also subject to heat treatment.

BIBLIOGRAPHY

1. E. C. BAIN, *The Alloying Elements in Steel*, American Society for Metals, 1939, 312 pp.
2. I. N. ZAVARINE, Quenching in water, brine, and oil, *Metal Progress*, V. 27, April 1935, pp. 43-6.
3. H. P. LANGSTON, discussion, *Trans. ASM*, V. 33, 1944, p. 68.
4. H. J. FRENCH, *The Quenching of Steel*, American Society for Metals, 1930, 177 pp.
5. E. K. SPRING, P. T. LANSDALE, and L. W. ALEXANDER, An evaluation of quenching oils, *Trans. ASM*, V. 33, 1944, pp. 42-55.
6. J. P. GILL, *Tool Steels*, American Society for Metals, 1944, 577 pp.
7. B. B. WESCOTT and L. W. VOLLMER, Quenching oils, *Metal Progress*, V. 47, May 1945, pp. 935-6.
8. A. E. LOCKE, discussion, *Trans. ASM*, V. 33, 1944, p. 57.
9. S. G. FLETCHER and M. COHEN, The dimensional stability of steel, *Trans. ASM*, V. 32, 1944, p. 335.
10. F. W. TREMBOUR and H. SCOTT, A test method for the evaluation of aqueous quenching media for steel hardening, *Trans. ASM*, V. 28, 1940, pp. 513-31.
11. A. ROSE, Das Abkühlungsvermögen von Stahl—Abschreckmitteln, *Arch. Eisenhüttenw.*, V. 13, 1940, pp. 345-54.
12. G. R. REISS, Improved technique employed in fabricating large steel rings, *Steel*, V. 114, February 1944, pp. 56-7.
13. W. LEHRER, Bright gas quenching of 4130 and 8630 welded aircraft tubes, *Trans. ASM*, V. 33, 1944, pp. 290-319.
14. B. F. SHEPHERD, Martempering, *Iron Age*, V. 151, February 4, 1943, pp. 45-8. Advantages obtained by the martempering process, *Product Eng.*, V. 16, July 1945, pp. 438-41.
15. M. GENSAMER, E. B. PEARSALL, W. S. PELLINI, and J. R. Low, Jr., The tensile properties of pearlite, bainite, and spheroidite, *Trans. ASM*, V. 30, 1942, pp. 983-1019.
16. A. F. GALLISTEL, Cold-die quenching, *Steel*, V. 118, March 4, 1946, pp. 15^o, 172-8.
17. C. A. LIEDHOLM, Diagram of transformations during continuous cooling of steel, *Metal Progress*, V. 46, November 1944, pp. 1097-1101.
18. R. G. ROSHONG, The art of quenching, I—coolants, *Metal Progress*, V. 50, November 1946, pp. 948-51.

SECTION III. HEAT TREATMENT OF FERROUS CASTINGS

CHAPTER 13

QUENCHING STEEL CASTINGS. HEAT TREATMENT OF CAST AND MALLEABLE IRONS

Steel castings, as they come from the mold, are coarse grained and relatively brittle. It has long been recognized that some type of heat treatment must be applied to "green" steel castings.

The early treatment was a full anneal, but this drops the tensile and yield strengths to a low level, although it provides ductility.

Full annealing was then replaced by normalizing or normalizing and tempering. This gave much higher strength together with ample ductility, and was, for a long time, considered to give the best compromise in properties, along with simplicity of treatment. Full annealing became outmoded.

Steel castings are often of heavy section and of complex shapes. The liquid quenching of such objects was considered rather hopeless, in view of the lack of penetration of hardness into heavy sections and especially of the danger of cracking a complex casting through unbalanced quenching stresses. However, oil quenching was sometimes applied to simple castings of thin section. It was appreciated, from the experience with the normalizing process, that a long high-temperature austenitization was required to obliterate the dendritic cast structure and put the steel into condition for satisfactory transformation to pearlite, hence the necessity for equally good austenitization, if quenching were to be attempted, was obvious.

Meantime, the steel selected for making strong normalized steel castings tended toward a high Mn content, with an addition of V, Ti, or of an ample amount of Al, both to produce fine grain and to make the manganese sulphide inclusions rounded rather than in films at the grain boundaries. Considerable experience was had with

more highly alloyed and more complex steels, which were automatically deeper hardening on quenching.

Better understanding of gating, filleting, and balancing of sections brought about a much greater freedom from stress raisers and stress concentrations.

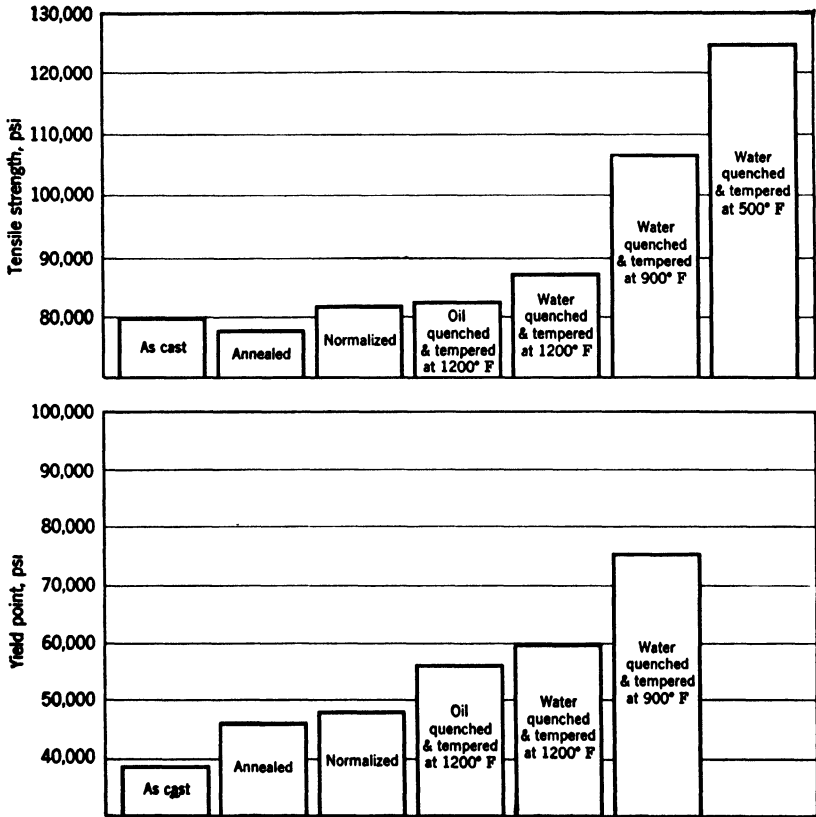

Fig. 105. Improvement in properties of steel castings by heat treatment.

Most steel foundries, therefore, had already taken steps which would mitigate the difficulties initially met in liquid quenching, and a few bold spirits began to quench and temper, even to water-quench, castings of such section and complexity that earlier observers would have predicted to be impossible to water-quench without unbearable losses through quenching cracks. Actually, little trouble was experienced and the properties were materially improved (Farrar¹⁷).

Mechanical Properties. There is practically no difference in the mechanical properties of a properly austenitized fully quenched and tempered cast steel and a fully quenched and tempered wrought steel, save that the cast steel is nearly free from directional differences which may be so notable in the wrought product.

Briggs¹ shows Figs. 105 and 106 for the relative properties of ordinary steel castings variously heat-treated. West and coworkers¹⁹ discuss more highly alloyed heat-treated cast steels.

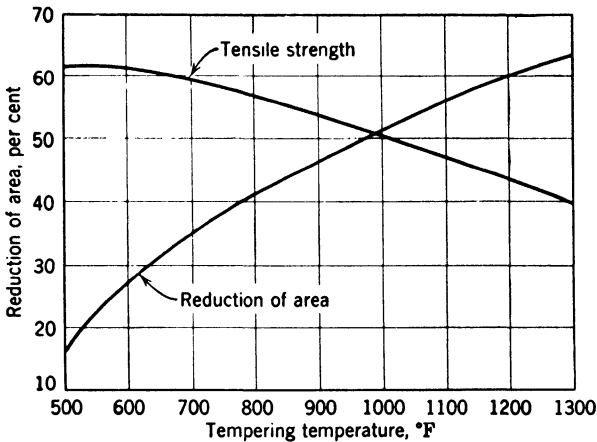

FIG. 106. Changes in strength and ductility on tempering quenched steel castings.

Difficulties. In the older annealing and normalizing treatments, it was customary to heat large batches of castings, often piled on cars, in car-type furnaces. The necessity for so arranging the castings for heating for austenitization that the outer portions of the charge did not shield the inner portion too much, so that the center would have ample time at temperature without overheating the castings on the outside, and the equal necessity for so separating and placing the casting for the air-cooling stage of normalizing were slowly appreciated. Even greater care in securing uniformity of heating before and in tempering after quenching is necessary in the case of quenching, but better furnaces and closer pyrometric control were progressively obtained. The real trick is in quenching without cracking. Castings often have re-entrant pockets which will trap steam and produce soft areas. Agitation of the bath, or moving the piece, or pressure or spray quenching has to be applied in such cases. Light sections and heavy sections together present a problem in persuading all to transform to martensite at the same time with bal-

anced stresses, instead of the light sections first, with resulting unbalanced stresses.

Time Quenching. This is often handled by a variety of the "martempering" scheme; that is, water is applied only for such a time as will nearly, but not quite, bring the light sections down to the M_s temperature. The water spray is then cut off or the casting withdrawn from the water so that the heavy sections have opportunity to feed their retained heat into the light sections, until the temperature of all the sections has been sufficiently equalized; then the water spray is turned on again, or the casting reimmersed, whereupon transformation occurs in all the sections. Ruffle^{1a} advocates removal from the quenching bath when the piece has reached 570°, the martensite transformation then occurring during air cooling.

Where this technique is insufficient, the thin sections are beefed up by bolting-on heat-resistant alloy "reinforcements," or packing fireclay about them in suitable fixtures, so as to slow the rate of cooling of the thin sections down to that of the heavy section. The casting is placed in the tempering furnace immediately after martensite formation is complete. Phillips² does not let the temperature drop below 250°.

Effects of Section. It is necessary that the hardenability of the steel be sufficient for the section; this means the use of alloy steels for very heavy sections. It is also desirable that the M_f temperature be above room temperature; Phillips specifies it to be above 250°. This calls for rather low C content. It is not very practical to apply "cold treatment" to big castings, and so retained austenite is definitely not wanted. Ample circulation of water and provision for cooling the water are essential in rapid-production quenching of heavy castings.

Gezelius³ and Cone⁴ describe a fully mechanized layout in which steel castings weighing 85,000 lb have been successfully water-quenched.

The greatest requirement is co-operation by the designer so that disparity in section thicknesses will be at a minimum and that changes in section are made by gradual transition, not sharply. The foundryman also has to co-operate by working out gating and risering, so as to make sound castings, without internal stress raisers that would favor cracking. The steel treater must be given furnaces, both for austenitizing and for tempering, provided with good pyrometric equipment, and capable of great uniformity of temperature, and must so charge the furnaces that this capability is not defeated.

With intelligence all along the line, it has become possible to water-quench huge tank turrets and the like, that it would have seemed impossible to handle. The Steel Founders Society Symposium⁵ on liquid quenching of steel castings indicates what has been successfully done for munitions and what is obviously feasible for peacetime uses. It seems probable that, just as full annealing gave way to normalizing, normalizing will in turn give way to liquid quenching and tempering in the steel-castings industry.

Heat treatment is applied to ferrous castings other than steel, and the principles of heat treatment of steel apply also to their cases.

Gray Iron. The presence of graphite is the distinguishing feature of gray cast iron. At very high-C concentrations, especially in the presence of Si at the high temperature of the melt in blast-furnace pig iron, C in excess of the eutectic composition, 4.25% C, the amount the melt can hold in solution, is thrown out, as the melt cools, in the form of "kish," flakes of graphite floating on the surface. If the C is first thrown out as iron carbide, it decomposes instantaneously to graphite.

If the Si is high, when a solid alloy of 1.75–4% C in Fe cools, it throws out most of the C as graphite, retaining some as carbide. This product is *gray* cast iron, in which an analytical determination of the C shows the "total C" to be divided into "graphitic C" and "combined C," the latter being present as iron carbide. As the Si content is decreased or the rate of cooling is increased, the tendency for separation of graphite decreases, and that for retention of carbide increases, with the familiar result that the cast iron, instead of having a gray fracture throughout (due to graphite flakes) is gray in the more slowly cooling center; mottled further out, with graphite only in spots; and still further out, at the outside and the edges, it is white "chilled iron," in which the C has all been retained as carbide. The matrix is pearlite with large amounts of excess carbide.

Heat Treatment in Relation to Graphite. Gray cast iron separates graphite as it cools down, because of the presence of large amounts of C and Si, 3% C or more and 1 to 2.75% Si, depending on the section to be cast. The matrix of the stronger irons is largely pearlite. Some irons contain free cementite, especially when slowly cooled. In higher-Si weaker iron, the pearlite may partially break down to ferrite and graphite. Whatever the matrix, it is cut up by many graphite flakes which lead to absence of ductility. The graphite, in relatively coarse flakes, is not readily reabsorbed on

heating into the austenite range; hence, no matter how gray iron is heat-treated, it remains nonductile.

Heat treatment of gray iron is therefore limited. Stress-relief annealing, usually at 800–1100°, the lower temperatures being used for irons high in Si, to avoid further graphitization, is practiced as a quicker and more certain way of avoiding distortion on machining, than the old practice of letting the castings “season” at ordinary temperature for perhaps a year.

Gray iron, too hard to machine well, may be softened, that is, have its pearlite or free carbide changed by a regulation full anneal, heating into the austenite range 1400–1600°, and slow cooling. Care is taken only to anneal just enough to develop the desired machinability, without further loss of strength. Another method is a long hold just under the critical. Centrifugally cast pipe with a thin chilled surface is annealed to soften the surface.

Quenching and Tempering. Martensitic hardness for wear resistance may be obtained by heating, followed by quenching, usually in oil, and a low temperature draw at 400–600°. Flame or induction hardening of the wearing surfaces is now more commonly used than heating the whole section when wear resistance is sought. However, alloy cast-iron dies of simple shape, oil-quenched and drawn only at 300° to give around 500 Brinell, are reported by Roth⁶ to have given useful service.

Some low-C alloyed irons can be somewhat improved in strength and given greater hardness for wear resistance, by quenching and tempering the martensite. For example, a gray iron of 44,000 psi, 230 Brinell, oil-quenched from 1550°, had to be tempered at 600° before it regained its as-cast strength, but then showed 420 Brinell; at a 900–1000° temper its strength was still about the same, but the hardness dropped to 325–300. At 1200°, the strength was reduced to 38,000 and the hardness to 260.⁷

With the graphite present in very small, rather than coarse, flakes, quenching and tempering sometimes raise the strength 50% above the as-cast level. The heat treatment which should ductilize the matrix does not make a ductile casting since the graphite flakes prevent the development of ductility in the piece as a whole. More effective heat treatment can be applied when the matrix contains the free graphite in a much more finely divided form, such as the “temper carbon” in “malleable iron.”

Malleable Iron. White iron for malleableizing could be looked at as a highly hypereutectoid steel, consisting of ferrite (actually

silicoferrite) and carbide, with the hard brittle carbide in such excess that the whole structure, as cast, is brittle and requires heat treatment to soften and toughen it before it is fit for use, except for those cases where the original structure is wanted for wear resistance.

The composition of white iron ranges from around 1.75 to around 3 C, 0.75 to 1.60 Si, 0.40 to 0.65% Mn, with up to around 0.20 P and 0.20% S in different grades. If the white iron is heated into the temperature range of austenite plus carbide, about 1400° (raised from the 1335° of straight FeC by the presence of Si) to 1600–1700°, as would be done for a “full anneal” of a high-C steel, the ferrite of the pearlite becomes austenite and dissolves some of the carbide, just as in homogenization of a high-C steel. On slow cooling, the now practically saturated austenite rejects carbide which, however, breaks down into extremely fine graphite, usually called “temper C,” in contrast to the flaky graphite of gray cast iron.

First-Stage Graphitization. Some separation of temper C may even occur when the metal is (ostensibly) held at the constant soaking temperature (actually usually fluctuating somewhat) of homogenization, since the carbide is slightly more soluble than the graphite, but lowering of the temperature to reduce the solubility is necessary. Hence, slow cooling to $A_{r_{3-2-1}}$ follows the soaking period. At $A_{r_{3-2-1}}$, of course, pearlite forms from austenite and the remaining carbide, but no excess carbide remains because the soaking and slow cooling have taken all the excess carbide into solution and then thrown it out as finely divided temper C. This is “first-stage graphitization.”

Second-Stage Graphitization. For full softening, it is necessary to destroy the pearlite, and so slow cooling, just as in spheroidization, is continued down to about 1275°. In the presence of the temper C that has been formed, the carbide in the pearlite also breaks down to temper C, so that there is finally formed a (silico-) ferrite matrix, free from carbide (second-stage graphitization) and containing all the C as temper C.

This is fully annealed malleable iron. To produce it, the composition and cooling rate in freezing were adjusted so as to avoid formation of flaky primary graphite and retain all the C as carbide, but as carbide which, because of its large amount and the presence of Si, is not so stable as it is in steel. The homogenization, full annealing, and spheroidization treatments that would, in ordinary high-C tool steel, produce ferrite and spheroidized carbide, produce (silico-) ferrite and what might be considered as spheroidized C.

Somewhat analogous to the distributed particles produced in precipitation hardening, these finely divided and uniformly distributed C particles have a strengthening effect, as does the Si in the ferrite, so that the yield strength is higher than would be expected from pure ferrite, and yet the ductility is not very low.

Ductility and Strength. The remarkable thing about fully annealed malleable iron is that the higher yield and tensile strengths are accompanied by higher ductility, instead of the inverse relation met in steels. Early specifications called for 50,000 psi tensile, 32,500 psi yield, 10% elongation, and this grade is still in wide use. However, present specifications also cover another grade, 53,000 psi tensile, 35,000 psi yield, 18% elongation. As high as 33% elongation has been recorded.

For these grades the C content is held down, in the neighborhood of 2%, and to produce metal of that C content air-furnace or electric melting is required, rather than cupola melting.

Cupola Malleable. In cupola melting, because of the contact with coke, it is difficult to hold the C below 2.75 to 3%. At such a C level, in "cupola malleable," the properties of the fully annealed product run about 40,000 psi tensile, 30,000 psi yield, and 5% elongation, as a minimum.

The cupola product is much used for pipe fittings, since it is tough enough for the purpose and threads well. Owing to the finely divided C, malleable iron is extremely machinable.

The high C of malleable gives it a low melting point; hence, it is more readily castable than low-C steel. The heat treatment converts the originally brittle castings into a fairly strong fairly tough easily machinable structure, that could be obtained in no other way. The long time required for the heat treatment is the primary drawback.

Decarburization, White Heart. Unless the annealing is done in a controlled atmosphere, there is usually some decarburization of the surface, and the fracture at the surface where there is no temper C is white; in the center it is dark from the temper C; so the product is termed "black-heart" malleable. European practice used to and still does, to some extent, rely primarily on decarburization and seeks to remove the carbon, by packing the castings in iron ore. Only small castings can be decarburized throughout in a reasonable time. This European "white-heart" malleable is almost C-free silicoferrite. It is usually of lower yield strength than black heart, and has much lower elongation, 2 to 4%. It is not made in pres-

ent American practice. The English believe that in many uses, such as parts of some agricultural implements, there is little reason for demanding much ductility.

The malleable founder, like the gray-iron founder, must balance the composition according to the cooling rate, that is, the section of the castings to be made, and there are many other tricks in the trade, the details of which have no place in our discussion of heat treatment.

Pearlitic Malleable. It is obvious that, after primary graphitization and the production of a pearlite matrix with separated temper C, the material is much like a pearlitic steel and should be amenable to heat treatment. It should also be possible to add alloys to produce results analogous to those from alloyed steel.

When the primary stage of graphitization is nearly complete, but the matrix still austenitic, the austenitic matrix will respond to variations in cooling rate; slow cooling through the pearlite domain giving laminated pearlite; faster cooling fine pearlite; still faster, bainite; and quenching, martensite which can then be tempered as usual. The presence of the primary temper C exerts a trigger action, and the decomposition of carbide is likely to go on in the pearlite domain, the new graphite joining with the old to form clumps and the freed ferrite to surround these clumps, giving a "bull's-eye" microstructure, and so more rapid cooling, that is, quenching to martensite, gives a more controllable structure.

The attractiveness of reducing the treatment time from its normal several days, by cutting down that of first-stage graphitization somewhat, and replacing that of the second stage of the production of regular malleable with much faster operations, plus the greater strength of the product, has led to considerable development of "pearlitic malleable" with tensile strengths up to 125,000 psi, though⁸ with reduced ductility, say, down to only about 2%. In the pearlitic type, the usual inverse relation of strength to ductility reappears. Sauveur and Anthony⁹ clearly discussed the possibilities; Morken¹⁰ also treats the subject clearly.

The least modification of the regular malleable annealing cycle consists in merely cutting down the time of both the primary anneal and the secondary anneal, using 15 hr at 1650°, cooling to 1250°, and holding for 20 hr to "spheroidize." The product of this cycle approximates regular malleable in properties, being somewhat stronger and less ductile.⁸ For such cycles, the Mn is usually held between 0.50 and 1%, as it favors spheroidization instead of graphi-

tization in the second stage. The product contains the primary temper C and secondary carbide globules, both in the ferrite matrix. When malleable has been arrested at such a stage that pearlite has formed, or has been short-cycle-annealed to retain pearlite, it is termed pearlitic malleable to differentiate it from regular malleable, even though it is subsequently heat-treated to destroy or convert the pearlite. Thus, the ferrite-temper-C-spheroidized-cementite structure previously mentioned is still called "pearlitic malleable," though it contains no pearlite.

Alloying. Alloying, notably with Cu which, like Si, acts as a graphitizer, but not so potently, in producing graphite as the metal freezes, also allows cutting down the time of both first- and second-stage graphitization.

Controlled Atmosphere. With the ordinary system of packing the white castings in pots to avoid warpage and prevent excessive decarburization, the rate of heating and cooling is slow, so that, when pearlitic malleable is to be produced, the castings need to be so supported and distributed that warpage will be avoided and heating and cooling can be done rapidly, the castings themselves forming most of the charge because of the omission of boxes and packing. With the castings open to the furnace atmosphere, a controlled atmosphere is needed to prevent scaling and excessive decarburization. With equipment suited for relatively rapid heating and cooling, and capable of precise temperature control, much shorter cycles can be used and a stronger though less ductile product can be made.

Quenching. Instead of going directly to the second-stage cooling just below the critical with the metal still hot from the primary anneal, it can be quenched while it is still austenitic, transforming the austenite to martensite, then reheated for spheroidization, just like a high-C tool steel. The fine structure obtained on tempering martensite spheroidizes faster than one containing pearlite.

Arrested Malleableization. A large tonnage of "pearlitic malleable" or so-called "steel produced by arrested malleableization" is produced from white iron of about 2.65 C, 1.35 Si, and 0.40% Mn, first stage annealed in controlled-atmosphere radiant-tube furnaces for 15 hr at 1750°, then rapidly cooled from 1600° (air cooling for small sections, oil quenching for heavier ones), and then tempered at 1250°. Tempering times of 4 to 8 hr give a range from 240 Brinell, 95,000 psi tensile, 75,000 psi yield, 3% elongation, to 165 Brinell,

65,000 tensile, 45,000 psi yield, 7% elongation.¹¹ This is a rather rapid rate of change with time of tempering. The aim is to "sorbitize" rather than graphitize; hence, the tempering temperature is below the 1350° used for regular second-stage annealing. Quenching greatly increases the rate of graphitization in the second stage, and, hence, allows more rapid second-stage annealing at 1350° when the aim is to secure maximum ductility.

If it is desired to retain some cementite as pearlite or bainite, a slower rate of cooling (or an austempering quench into fused salt or lead) will accomplish this end, giving high strength but relatively low ductility.

Austenitizing. Regular malleable or pearlitic malleable can be reheated to a definite temperature for a definite time in the austenitic range, to produce a regulated reabsorption of temper C into the austenite which, in regular malleable, had previously been C-free. Not much approach to homogenization is possible, since it is not desired to take all the temper C back into solution; hence, the austenite is patchy as to C content and, since it is inhomogeneous, will tend to decompose to ferrite and pearlite on moderately slow cooling. However, in small enough sections, it can be quenched to martensite, which, in turn, will be patchy in its C content, and with corresponding hardness and brittleness in patches.

Thus surface hardening, by flame or induction heating, followed by quenching of the surface, can be used to produce a wear-resistant surface over a ductile core.

By the same token, the welding of malleable or pearlitic takes temper C into solution in austenite adjacent to the weld, this quenches to martensite on cooling, and reheating would be required to temper the martensite. All the difficulties, and then some, of welding high-C steel would be present in an attempt to weld malleable or pearlitic iron, and so brazing or silver soldering below 1350° is extensively used instead.

Effect of Silicon. The instability of carbide in malleable is generally thought of as primarily induced by the Si content. Silicon decreases the solubility of liquid or solid austenite for carbide. The maximum solubility in liquid austenite is reduced from 1.75 to 1.50% and the composition of the pearlite thrown out of solid austenite, from 0.83 to 0.60%, by the presence of 2% Si. This antipathy for carbide carries through at high and low temperatures, and Si, at this level, favors the decomposition of carbide into graphite.

Ford Alloys. In the ordinary and pearlitic malleables, the C and Si are moderately reduced from their levels in gray iron, and sometimes some of the Si is replaced by Cu which is a milder graphitizer.

The Ford Motor Company went a step further, cutting the C materially and raising the Cu, while holding the Si around the usual malleable level. The base composition^{12, 13} is about 1.50 C, 1.00 Si, 0.50 Mn, 1.50–3.00% Cu. It is often termed steel and occupies a position intermediate between regular high-C steel and regular pearlitic malleable. For brake drums, the Cu is held near the high level, and 0.15 Mo added. For pistons, the Cu is held near the low level, the Mo omitted and 0.10% Cr added. The well-known cast crankshaft also has the lower Cu level, no Mo, but 0.40–0.50% Cr, the latter to produce a small amount of wear-resistant carbide. One function of the Cu is to add castability, since, in its presence, the molten metal is very fluid.

At such a level of composition, the casting is white, or white with mere traces of extremely divided primary graphite. The white iron is in an extremely unstable condition, very readily malleable. Heating to 1650°, holding for 20 min, and air cooling through the critical gives a pearlitic matrix (plus traces of undissolved iron–chromium carbide in the crankshaft alloy) with some finely divided temper C. As soon as the casting has cooled to 1200°, it is reheated to 1480°, just up in the austenitic range, held 1 hr, and then cooled in the furnace to 1000° in another hour. In this brief period, a nicely spheroidized iron carbide plus a little secondary temper carbon and a little iron–chromium carbide in a tough matrix result. The product is machinable, 255–320 Brinell. At the average hardness, 270, the tensile runs around 105,000 psi, the yield 90,000 psi, and small specimens have some 2% elongation, though specimens cut from crankshafts have practically zero elongation or notched-bar impact. However, the alloy does have some degree of toughness. Satisfactory use for a dozen years as crankshafts proves that, in this service at least, ductility need only be very small. The yield strength is somewhat higher than in lower-Cu pearlitic malleable produced in a longer heat-treatment cycle. The Ford alloys are of the type spheroidized from pearlite rather than produced by quenching to martensite on tempering or tempering and spheroidizing.

Although it is more common to spheroidize just below the critical, it is also possible to spheroidize between A_{cm} and $A_{C_{3-2-1}}$. Indeed,

the usual spheroidization process is facilitated by varying the temperature up and down through the critical.

Another Ford steel and treatment is 1 C, $1\frac{1}{4}$ Si, and $\frac{3}{4}\%$ Mn, air-quenched, then reheated to about 1425° for $2\frac{1}{2}$ hr, and then cooled at 25° per hour to 1300° . This produces spheroidization (without graphitization unless the temperature is too far above 1425°), most of which occurs while the steel is above the critical.¹⁴

Shot. Both the addition of Cu¹⁵ and a malleableizing heat treatment¹⁶ are utilized in making shot for peening metal. In the latter, by arresting first-stage malleableization at the desired point, quenching to $400\text{--}500^\circ$ to produce martensite, and then cooling slowly so as to temper the martensite somewhat, a useful compromise between hardness and toughness is obtained, so that the shot, although hard enough to do effective work, tends to break up less in use than does ordinary chilled iron shot, not heat-treated.

BIBLIOGRAPHY

1. C. W. BRIGGS, Water-quenched steel castings, *Steel*, V. 114, May 22, 1944, pp. 82-5.
2. W. J. PHILLIPS, Design and mass important in quenching steel castings, *Steel*, V. 114, June 5, 1944, pp. 110, 170-1.
3. R. A. GEZELIUS, Quenching large steel castings, *Steel*, V. 114, May 29, 1944, pp. 88-96.
4. E. F. CONE, Heat treating armor steel castings, *Metals & Alloys*, V. 20, December 1944, pp. 1593-7.
5. Symposium on water-quenched steel castings, *Steel*, V. 119, 1944, May 22, pp. 82-8; May 29, p. 86; June 5, pp. 104-10, 170-1.
6. E. L. ROTH, discussion, *Trans. ASM*, V. 22, 1934, p. 245.
7. *Cast Metals Handbook*, American Foundrymen's Association.
8. E. E. HOWE, Short-cycle malleablization of white cast iron, *Iron Age*, V. 155, January 18, 1945, pp. 66-8.
9. A. SAUVEUR and H. L. ANTHONY, Malleable castings, *Trans. ASM*, V. 23, 1935, pp. 409-22.
10. C. H. MORKEN, The heat treatment of cast iron, *Trans. ASM*, V. 22, 1934, pp. 227-42. See also L. CROWE, Opinions on graphitization, *Foundry*, V. 73, December 1945, pp. 102-03, 248-58.
11. C. F. JOSEPH, Arma steel, *Iron Age*, V. 143, May 25, 1939, pp. 27-31. *Foundry Trade J.*, V. 67, 1942, pp. 365, 65-9, 385-97, V. 68, 1943, pp. 11-15. See also R. W. LINDSAY and J. E. ATHERTON, JR., Heat-treatment study of pearlitic malleable cast iron, *Am. Foundrymen*, V. 8, September 1945, pp. 27-32.
12. E. F. CONE, The story of the Ford crankshaft, *Metals & Alloys*, V. 6, October 1935, pp. 259-60.
13. R. H. MCCARROLL, Ford alloys, *Metals & Alloys*, V. 7, December 1936, pp. 323-4.

14. U. S. Pats. 2,368,418, January 30, 1945; 2,370,179, February 27, 1945.
15. U. S. Pats. 2,218,107, October 15, 1940; 2,184,926, December 26, 1939.
16. O. E. HARDER and J. T. Gow, Shot for metal peening, *Trans. ASM*, V. 35, 1945, pp. 390-7.
17. C. W. FARRAR, Quenched steel castings, *Can. Metals and Metal Ind.*, V. 9, March 1946, pp. 37-8.
18. T. W. RUFFLE, The control of composition and heat treatment in 0.25 C 1.5% Mn steel castings, preprint 800 for June 1944 Institute of British Foundrymen meeting, 5 pp., *Foundry Trade J.*, V. 73, June 13, 1944, pp. 215-20.
19. W. WEST, C. C. HODGSON, and H. O. WARING, High-tensile steel for castings. *Proc. Inst. Brit. Foundrymen*, V. 39, 1944-45, pp. 375-90.

CHAPTER 14

GRAPHITE AND STEELS

GRAPHITE IN WROUGHT STEELS—POROUS “STEELS”

Next in line come the “graphitic steels,” which are industrially produced in wrought form, whereas the malleables and the Ford alloys are used as castings. Graphitic steels are compounded and heat-treated to produce a controlled separation of temper C, prior to the usual quenching and tempering of the matrix.

The primary graphite separation on the initial cooling from the melt and the primary separation of temper C need to be kept low, so that no large flakes of graphite will separate out in the slow cooling of the big ingots used in the steel mill, nor too much primary temper C in the rolling or forging while the steel is austenitic. For this, a careful balance of C and Si is needed.

The presence of Si tends to make cementite unstable, that is, to form graphite. With the combination of high C and high Si in cast iron, flaky graphite appears in the metal as cast. By reduction in the amount of C and Si, say to 2.20 C, 1% Si, the separation of graphite is avoided, and “white iron” produced, which is malleable as described in the preceding chapter.

Alloys with fine temper-C or graphite particles have extremely good machinability. The presence of these graphitic particles makes the alloys somewhat similar to cast iron in freedom from galling and for service under rubbing conditions with scanty lubrication, possibly owing to the film of graphite supplied by the particles, possibly to the tiny pockets acting as oil reservoirs when their graphite has been partly or wholly removed.

The phenomenon of graphitization is not unknown in high-C low-Si steels. When an attempt is made to run the C in tool steels up over 1.20% with even as low as 0.10–0.30% Si, graphitization may occur on annealing, even below A_1 . As the Si is increased, the tendency toward graphitization increases. Even very small amounts of Al exert a similar tendency.

At first such attention as was given to graphitization in true steels has been an attempt to avoid it. Later it was appreciated

that utilization of the graphitization phenomenon might allow the production of a strong easily machinable steel that could be forged and rolled instead of having to be used in cast forms like cast and malleable irons, especially for wear-resistant uses. Taking a leaf from their experience with malleable, Schwartz¹ and Edmunds² suggested such steels, and further development has been carried on by Bonté³ and others. The steels, according to Schwartz and

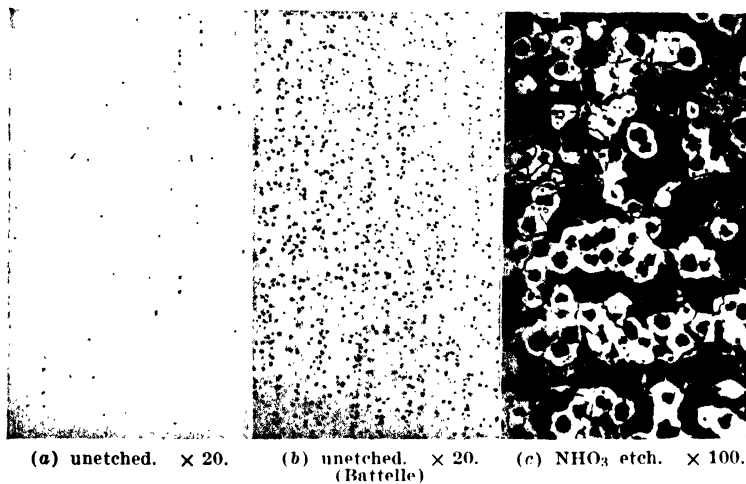
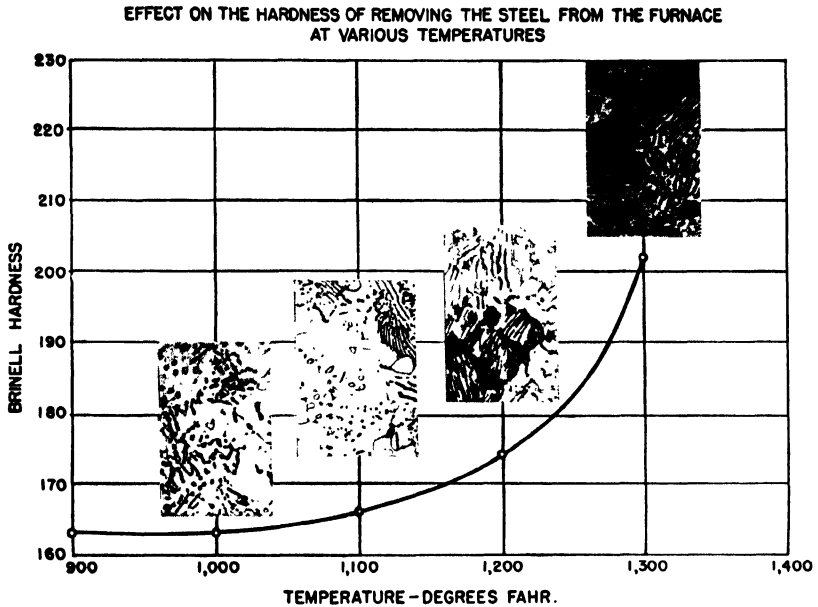

FIG. 107. Graphitic steel. C, 1.24; Mn, 0.42; Si, 1.39%. (a) is oil-quenched from 1800°. (b) and (c) are slow-cooled from 1800°. Very little graphitization has occurred in the quenched specimen. In the slow-cooled steel much of the carbide in the pearlite has graphitized, producing uniformly distributed temper C, but graphitization is not complete.

Edmunds, preferably contain such combinations as 0.35 C, 1.60 Si, 0.30% Mn, or 1.15 C, 1.25 Si, 0.85% Mn. In order to prevent separation of graphite in freezing and cooling on casting the ingot, 2% Si with 1.50% C or 4% Si with 1.30% C should not be exceeded, and useful properties are obtained with 1% each of C and Si.

The resistance to graphitization of a properly balanced steel, until graphitization is intentionally produced, is shown in Fig. 107a for a 1.24 C, 1.39 Si, 0.42% Mn steel, with only residual traces of other alloying elements, quenched in oil from 1800°. Slow cooling (Fig. 107b) produces uniform temper-C distribution. These figures are at X20 to show distribution. The etched structure at X100 of the slow-cooled specimen reveals the temper C (Fig. 107c). The effect of air cooling from different temperatures after slow cooling, that is,

interrupting the slow-cooling process, is shown in Fig. 108, which follows the break-up of the cementite in the pearlite. The amount of combined C and hence the hardness may be thus regulated. Figure 109 shows both the retained pearlite and the nodules with their surrounding ferrite. This is a larger view of the micrograph at the



**SPECIMENS HELD ONE HOUR AT 1,500°F. AND COOLED 100°F. PER HOUR TO
TEMPERATURE INDICATED**

FIG. 108. Progressive breakup of pearlite areas as slow cooling progresses. This is the same steel as in Fig. 107. Micrographs at $\times 1000$ reduced to $\times 500$ in reproduction. (Battelle)

right in Fig. 108, for material whose slow cooling is interrupted at 1300°. Structure on slow cooling of a steel of 1.15 C, 1.70% Si is shown in Fig. 110 at X100. The uniform size and distribution of the temper C is notable.

Upon reheating the graphitized steel for quenching, some of the precipitated C can be taken into solution. By adjusting temperatures and times of heating, the matrix can be given different degrees of effective C content.

Depth-hardening properties were studied by oil quenching a disk 10 in. in diameter and 1¼ in. thick from 1500°. By splitting the

disk flatwise and taking hardness readings along a radius on the cut face, the data of Fig. 111 were obtained.

Uses. Bonté reports interesting results from such steels used as drawing dies, the hole being internally quenched from 1500° by water spray and drawn at 300° to Rockwell C 62-63, the body being

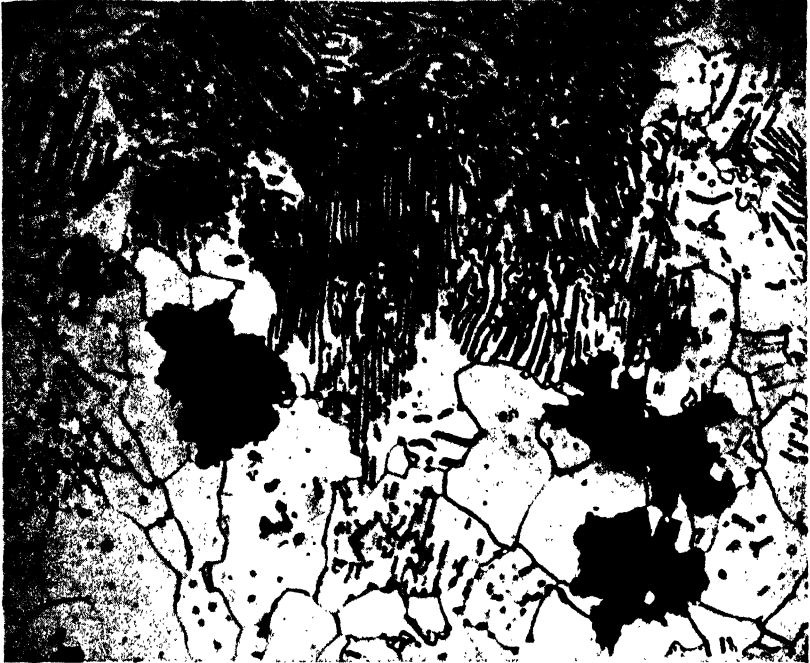

Nitric acid etch $\times 1000$. (Battelle)

FIG. 109. The same graphitic steel as in Figs. 107 and 108, slow-cooled from 1500° to 1300°, air-cooled from 1300°. Undecomposed pearlite areas and nodules of graphite with surrounding ferrite are shown.

20-22. Remarkable freedom from scuffing of the die was reported; in one case the service given was 31 times that of the die steel previously used. The addition of 0.25% Mo and the reduction of Si to 0.75% are advocated by Bonté. He reports that a steel of 1.45 C, 0.35 Mn, 0.75 Si, 0.25% Mo, oil-quenched from 1450° and tempered at 300° to Rockwell C 61-62, used as punches, outperformed an oil-hardening tool steel previously used, by 11 times. The analogy of the matrix of such a steel to an oil-hardening tool steel of 0.50 C, 0.40 Mn, 1.00 Si, 0.50% Mo is evident. The temper-C particles

may have a cushioning effect and thus add to the effective toughness in service.

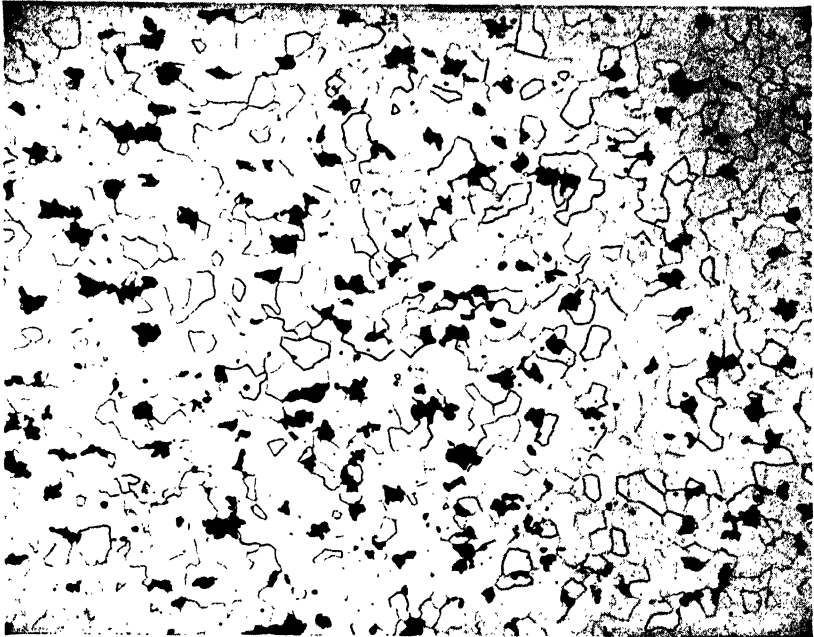

Nitric acid etch $\times 100$. (Battelle)

FIG. 110. Complete graphitization on slow cooling from 1700° at 100° per hour of steel of C, 1.15; Mn, 0.37; Si, 1.70%. This completely graphitized steel has a Brinell hardness of 131.

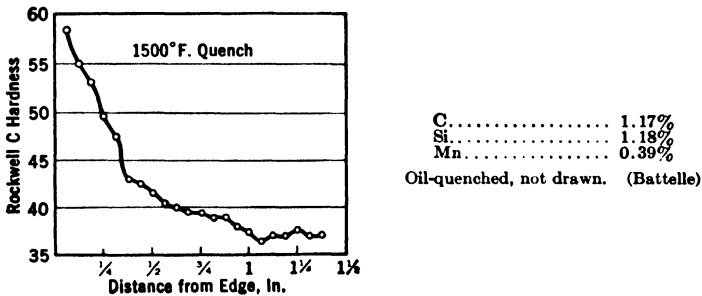

FIG. 111. Depth hardening in graphitic steel.

Bonté⁴ considers 0.20–0.50% Mo to act as a graphitizer, rather than as a carbide stabilizer. For steels to which has been added Mo, or Mo and Ni, he gives the data shown in Table 24.

TABLE 24

<i>Steel</i>	C	Si	Mn	Mo	Ni%	
C	1.45	0.90	0.40	0.25	} graphitized at 1550°, then quenched, and drawn as shown
D	1.50	0.90	0.40	0.20	1.25	
<i>Steel</i>	<i>Draw</i>	<i>Tensile</i>		<i>Yield</i>	<i>Elong.</i>	<i>Brinell</i>
C	900°	218,000		177,000	8.5	444
C	1100°	164,000		136,000	13	321
D	900°	214,000		176,000	16	415
D	1100°	163,000		134,000	27	321

As Table 25 shows, use of other alloying elements that favor graphitization, like Ni and Cu, allows a wide range of properties. The strong carbide-former Cr is avoided because of too great stabilization of cementite and prevention of graphitization, but Mo does not interfere, and adds hardenability. The wear-resistant properties, the wide range of hardness obtainable between the quenched and the fully annealed condition, and the ready machinability in the graphitized state make this family of steels highly interesting.

Tungsten additions are also used in a variety of wear-resistant graphitic die steels. Floe¹⁹ describes a graphitic steel for nitriding, with 1.25% C, of which about 0.80% separates as graphite, leaving the matrix of the normal C content for a nitriding steel, except that Cr is kept low.

Effect on Properties. The presence of temper C scarcely alters the tensile and yield strengths from those expected from similar high-C alloyed steels, treated to like hardness. Ductility is dropped somewhat, but hardly as much as would be expected from the volume of temper C appearing in the microstructure. The soft temper C has far less effect in reducing ductility than would an equal volume of hard inclusions. The graphitic steels, fully hardened and then tempered, have fair notched-bar impact toughness, since the temper C is very uniformly distributed.

Stability of Carbide. Stable as the carbide of ordinary steel with low silicon is at ordinary temperatures, it need not be perfectly stable at elevated temperatures. Graphite or temper C is obviously a more stable form of C so it would not be surprising if the C of ordinary steel could be persuaded to come out as graphite. At temperatures nearly up to the critical, C must be diffusing rapidly, else it would not be so easy to spheroidize the carbide in pearlite into globules. From the malleable case, it can be seen that spheroidization of carbide and decomposition of carbide into temper C in fer-

TABLE 25

										<i>Oil Quenched from 1500°. Drawn 1100°</i>					
										<i>Slow-Cooled at 100° per Hour from 1500°</i>					
C	Si	Mn	Ni	Cu	Mo	Tensile	Yield	Elong.	R.A.	Charpy	Tensile	Yield	Elong.	R.A.	Charpy
1.50	1.0	0.40	94,000	47,500	19.5	30	154,000	116,000	14	30	(Water quench)
1.20	1.1	0.40	106,500	70,000	27	48	10.5	186,000	112,500	13	31	7
1.40	1.1	0.40	78,250	44,000	24	37	11	175,000	107,500	11	23	4.5
1.75	1.1	0.40	75,000	38,000	25	41	12.5	163,500	105,000	12.5	29	12
1.15	1.05	0.40	0.40	0.40	112,000	77,500	23.5	40.5	10	185,500	121,000	11.5	22.5	5.5
1.15	1.1	0.40	0.75	114,500	80,000	25.5	46	10.5	198,000	125,000	12	29	6
1.15	1.1	0.40	1.50	119,000	86,500	25	46.5	8.5	180,000	142,500	10.5	16	6
1.20	1.10	0.40	0.27	111,500	70,000	25.5	48	10	195,000	146,000	9	20	6.5

Data for the first steel are from Bonté,³ for the others, from investigations at Battelle Memorial Institute.

ritic steels are phenomena that occur with greatest facility as the steel becomes more plastic and as the solubility of C in ferrite increases, that is, as the temperature approaches $A_{r_{3-2-1}}$. Breakup of pearlite and spheroidization of carbide are frequently noted on examination after creep testing of C steels held for a couple of thousand hours at elevated temperatures, but graphitization has not

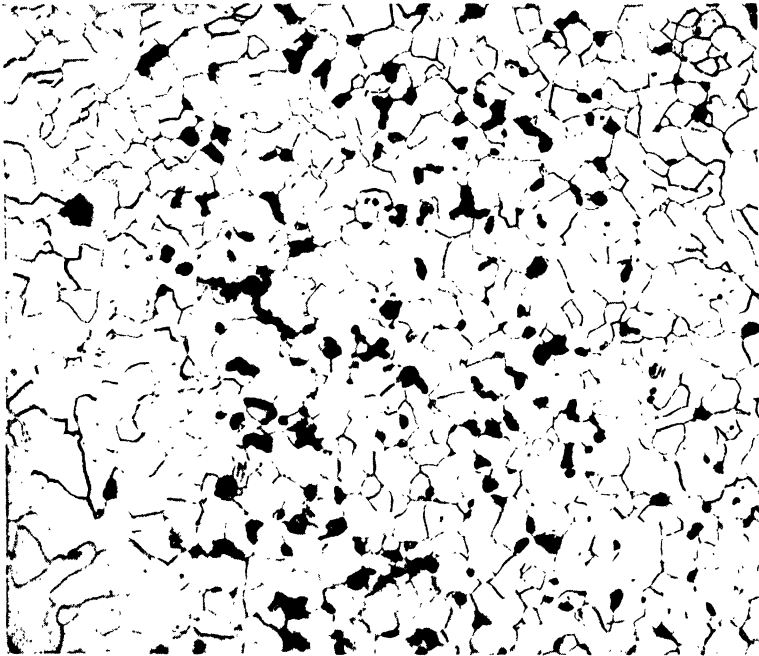

Fig. 112. High-aluminum-killed plain C steel, bead-welded and treated 7700 hr at 1025°F. Graphitization in zone just above A_{c_1} isotherm. Nital etch.

been frequently noted in the coarse-grained steels usually applied in high-temperature service.

Interest in the practical aspects of graphitization was aroused by the brittle failure in 1943 of a C-Mo steam pipe in a power plant. The pipe had operated at 935° for 5½ years, with swings up to higher temperatures. It contained 0.14 C, 0.50 Mn, 0.15 Si, and 0.47% Mo and had been made “fine grained” by Al deoxidation, but actually had a coarse grain size resulting from heating for up-setting prior to welding. The failure occurred near a weld. The steel had graphitized in a peculiar localized “eyebrow” fashion. Kinzel and Moore⁵ had reported graphitization in a steel of 0.15

C, 0.49 Mn, 0.02% Si, held just below the critical for 3 years, and Wells ⁶ produced complete graphitization in such a steel by heating 50 hr at a temperature just under the critical and slow cooling (11° per minute).

However, graphitization of the low-C Mo steel would hardly have been predicted, for Mo had ordinarily been held to be a carbide

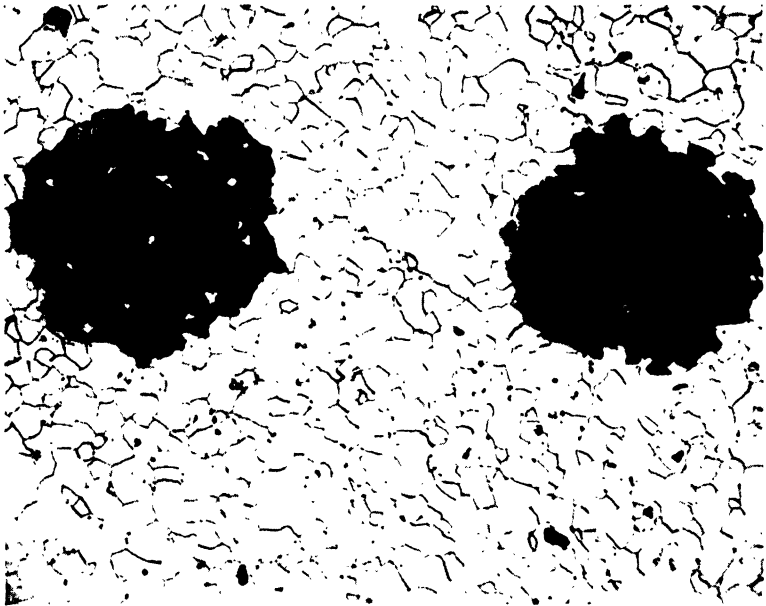

FIG. 113. High-aluminum-killed plain C steel, bead-welded and treated 7700 hr at 1025°F. Graphitization in stock unaffected by welding heat. Nital etch.

stabilizer on the basis of improved creep strength and greater resistance to spheroidization of steels containing it, but, as Bonté was quoted previously, and as Smith and Brambir ⁷ found experimentally, it has been classed as a mild graphitizer. Later work, however, again indicates it actually to be a mild stabilizer in low-C steels.

Smith, Miller, and Tarr ¹⁷ reported that C-Mo steel showed no tendency to graphitize at 1300°, but high tendency at around 1100°. At 1300°, they concluded, some of the Fe₃C is converted to a carbide of molybdenum. The stability, spheroidizability, and graphitizability of carbides, especially those more complex than Fe₃C, evidently vary considerably in the temperature range below the critical. Austin ²⁰ has enlarged upon this topic.

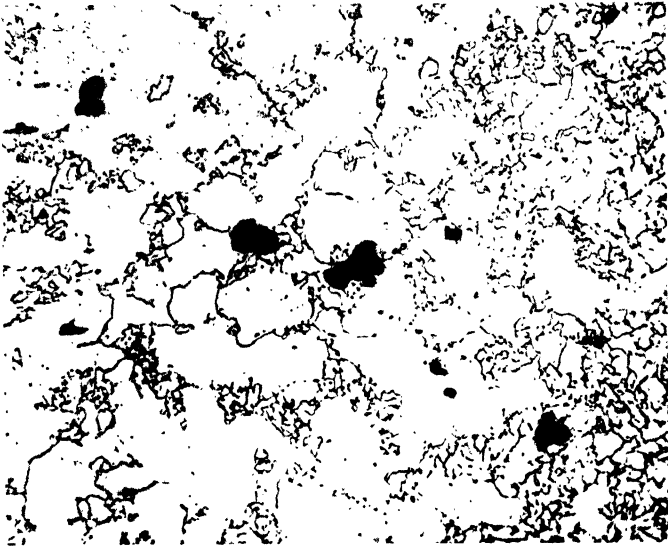

FIG. 114. High-aluminum-killed C-Mo steel, bead-welded and treated 9700 hr at 1025°F. Random graphitization. Nital etch.

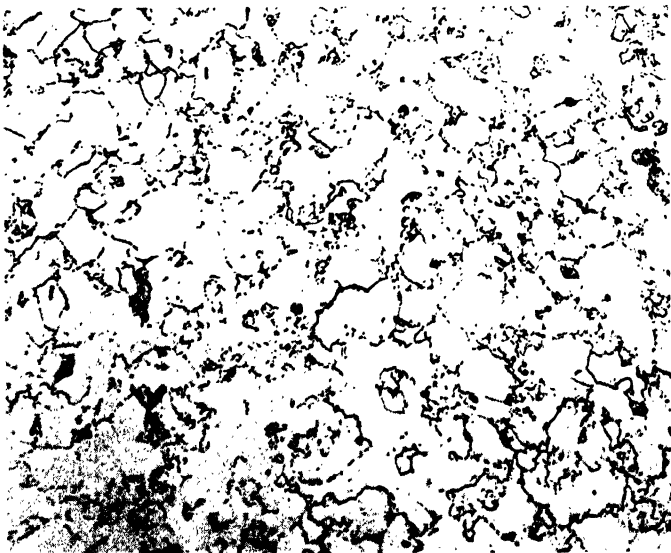

FIG. 115. Low-aluminum-killed C-Mo steel, bead-welded and treated 9700 hr at 1025°F. No graphitization. Nital etch.

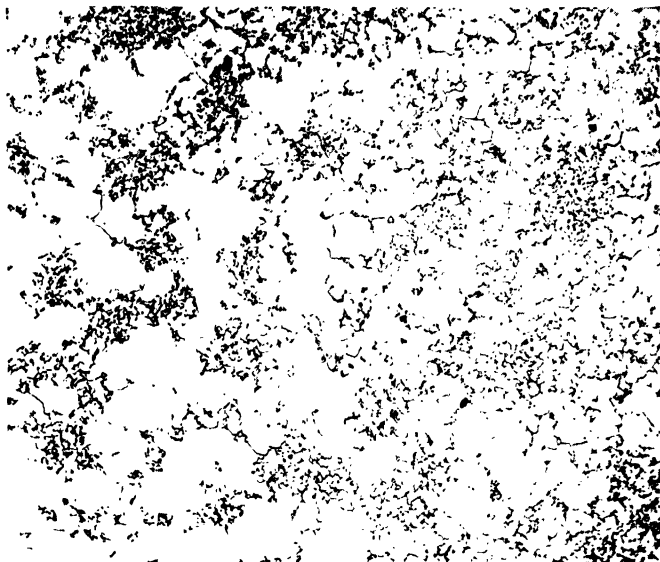

FIG. 116. High-aluminum-killed Cr-Mo steel (0.50% Cr), bead-welded and treated 5000 hr at 1025°F. No graphite. Nital etch.

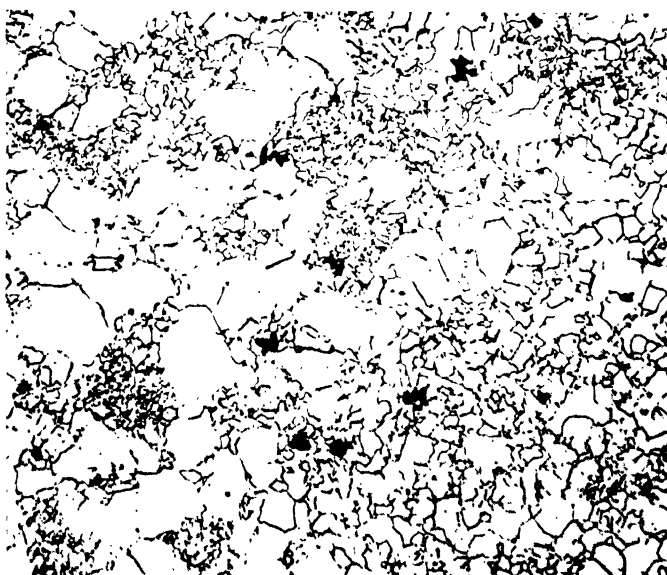

FIG. 117. High-aluminum-killed C-Mo steel (0.0% Cr control), bead-welded and treated 5000 hr at 1025°F. Graphitization tending to segregate at A_{c1} isotherm. Nital etch.

The piping failure led to careful examination of the case and to experiments aimed to elucidate it, by many laboratories. Figures 112-117, with their legends, illustrate some of the facts that were brought out.

Kerr and Eberle⁸ found a case of graphitization in a fully annealed steel containing 0.35 C, 0.55 Mn, 0.19 Si, 0.025 Al, and 0.006% Al_2O_3 , which was first heated to 1550° in 2 hr, held 1 hr, furnace-cooled to 1000°, then air-cooled, reheated to 1280° in 4 hr, held 2 hr, and furnace-cooled to 1000°. The structure was usual for the composition and treatment. A creep specimen of this steel was heated 8½ years (75,000 hr) at 7500 psi and 850°F. The initially spheroidized carbide had practically disappeared and nodules of graphite or temper C had formed. However, these authors cite a tube containing 0.19 C, 0.42 Mn, 0.19 Si, 0.002 Al, and 0.001 Al_2O_3 , which had been in service 8¾ years at 1000-1020°F and had not graphitized. Along with this was another tube of 0.21 C, 0.46 Mn, 0.14 Si, 0.019 Al, and 0.003% Al_2O_3 , which had started to graphitize.

Influence of Aluminum. This and other evidence led Kerr and Eberle to conclude that the Al content was an important variable. They also considered that steel that gave an "abnormal" case in the McQuaid-Ehn carburizing and grain-size test responds more readily to a graphitizing treatment below the critical. Austin and Fetzer⁹ found that carbides in abnormal steels were rendered unstable, more easily graphitized, under conditions allowing a slight oxygen pickup. The welding apparently had something to do with it, since, not only in the failure itself, but also in experiments designed to bring out that factor, graphitization was induced near to welds.

The negative remedy of omitting the Al treatment was obvious, but even an Al-free completely normal steel may not be wholly immune. Hence, a positive remedy, to produce definite stabilization of carbide, needed to be added.

Use of Chromium. The malleable-iron industry well knows^{10, 11} that Cr is detrimental to rapid separation of temper C, 0.07% being often set as the upper limit of Cr for malleable to be subjected to the standard malleablizing cycle. If higher Cr is present, the Si has to be increased in order that the deposition of temper C be not unduly delayed. Addition of Cr, as a known stabilizer, was therefore the first thought of every metallurgist who considered the problem.

Beside the case of regular malleable, Cr in the Ford alloys, discussed in the previous chapter, is known materially to inhibit graphitization in these more steel-like alloys, in spite of their high Si.

Hughes and Cutton¹² made direct experiments on the stabilizing effect of Cr in steel of lower C content. They found that graphite was separated in fine-grained Al-treated steels of 0.08, 0.43, and 0.67% C, all with about 0.20 Si and 0.02% metallic Al, on cold-rolling and long-process annealing at $1200 \pm 50^\circ$. The amount of first pass reduction in cold rolling affected the result, reductions of 10–30% producing most graphite. Full annealing prior to cold reduction and 1200° annealing increased graphitization. Graphite was redissolved upon complete austenitization. A steel of 0.59 C, 2.03 Si, 0.85% Mn, with 0.05% metallic Al graphitized, but addition of 0.34% Cr prevented graphitization for the period of the test. In an 0.87 C, 0.15 Si, 0.02% Al steel, even 0.09% Cr prevented graphitization. A coarse-grained 0.58 C, 0.14 Si, 0.002% Al steel did not graphitize.

The use of Cr for the inhibition of graphitization under the conditions of use required in high-temperature high-pressure steam service was proposed in a patent, which has since been assigned to the public.

The reports¹³ on the extensive studies on graphitization of steel piping not only cover the effects of composition, normality, Al content, and grain size, but also describe experiments on a variety of heat treatments designed to help avoid the deposition of graphite in service and even to repair incipient graphitization after it has started to occur. Normalizing at 1650° prior to welding and a "stress-relief" treatment at 1300° or 1400° after welding affords one suggestion for a stabilizing treatment, or for repair. The principle back of this seems to be a suspicion that a very tiny trace of graphite might exist in the steel prior to use, which should be taken into solution in austenite at 1650° . If graphite nuclei are present, any subsequently formed graphite would probably collect on them instead of having random distribution. The subsequent lower-temperature treatment should relieve cooling strains. The deposition of graphite seems to be facilitated by localized strain. The combined treatment of a graphitizable steel appears to prevent localized separation and bring about random separation, which has little or no embrittling effect. However, once localized separation and embrittlement have occurred, such restorative treatment does not restore normal shock toughness.

A primary step in the selection of steel for new installations is to pick a steel inherently resistant to graphitization; hence, such high-

temperature high-pressure steam-pipe installations are being made of coarse-grained normal C-Mo steel with an addition of 0.50–1.00% Cr, and killed with Si rather than Al, according to the ASTM specifications A280–45T and A213. The necessary Cr level is not yet certain, nor is it certain that any reasonable Cr level will completely inhibit and not merely prolong the time of starting of graphitization.

Since, without the aid of relatively large amounts of Si, Cu, or the presence of Al, graphitization requires rather long holding times in the austenitic range for primary separation, or not far below the critical for secondary separation, ordinary heat treatment of ordinary steels does not involve the phenomenon; so for usual purposes the observations still hold that cementite behaves as though it were stable, and that fine-grained steels, produced by addition of Al, are ordinarily preferable for most engineering uses.

Porous Steels. Malleable iron and graphitic steels have a steel or steel-like matrix interspersed with particles of temper C. The temper C can be looked upon as filling material for a multiplicity of tiny voids. Through “powder metallurgy” it is possible to make objects with a somewhat comparable matrix, but with unfilled voids.

Powder Metallurgy. Much has been said in recent years about small objects made by “powder-metallurgy” methods, in which metal powders are pressed in a die into an oversize compact and sintered at an elevated temperature in a suitable atmosphere. The powder particles stick together, forming a shrunken porous mass, which is then usually coined under pressure, in another die, to final dimensions. Compared with the solid metal, the porous part is weak and extremely brittle. In large production of parts whose dimensions are important but which need only mediocre mechanical properties, the process sometimes competes with automatic-screw-machine products, with machined cast iron, or with zinc-base die castings. There are marked limitations to the sizes and shapes that can be economically produced by powder metallurgy.

It is in the instances where porosity is an asset, or where a product is desired consisting of two or more metals that cannot be alloyed by fusion, that the method is chiefly applicable. The usual powder-metallurgy products are heated for sintering, but not heat-treated in the sense herein discussed.

However, by pressing finely divided low-C steel, or Fe powder and graphite into compacts and sintering at around 2000° in a neutral or carburizing atmosphere, with time for absorption and diffusion

of C, sintered "steels" with as little as 5% voids can be produced, which can be strengthened by heat treatment.

Mechanical Properties. Because of the voids, the properties both in strength and ductility compare poorly with those of solid steel subject to like heat treatment. Fatigue properties and shock resistance, of which no comprehensive tests are on record, would be expected to be decidedly poor. Because of the porosity, such objects need impregnation with oil to combat rusting.

Driving bands for artillery projectiles were used by Germany¹⁴ in World War II, usually made from a mixture of fine low-C steel chips and Fe powder, sintered, impregnated with oil, and pressed into place. These functioned nicely under the compressive and shear stresses of service, although the bands would fly into many pieces when pried off with a screw driver; that is, they were very brittle in tension.

Schwartzkopf¹⁵ has given the properties of a few "sintered steels" containing 0.3 to 0.8% C, made from Fe powder and graphite, and quenched and tempered. When heat-treated to give fair ductility the yield strength was low; when treated to give moderately high yield strengths, the ductility was very inferior. Schwartzkopf postulates that improved results might be obtained by hot repressing.

The obvious drawbacks and limitations in the production of such "steels" are so discouraging for general application that the introduction of such a product into the list of steels to be heat-treated would be likely to occur only under unusual conditions, where the service can tolerate what amounts to a very dirty notch-sensitive steel.

Filling of Voids. A variant of the porous steel produced by heating mixtures of Fe powder and graphite, in which the pores of a compact, first heated to produce an approximately eutectoid steel, are filled with a Cu alloy, has been described by Peters¹⁶ and Kopecki.¹⁸ Such material is described as having possibilities for building up large complex pieces that could not be made in one piece by powder metallurgy. By assembling smaller pieces and heating to brazing temperature in the proper atmosphere, the Cu-alloy filling acts as the brazing material.

The Cu alloy is chosen to have brazing characteristics, and also to reduce the solubility of Fe in Cu. Some Cu dissolves in the steel and permits precipitation hardening, though, as is discussed in Vol. I, this is not optimum in steel of eutectoid C content; hence, when precipitation effects are to be utilized, a lower-C steel plus Cu alloy would normally be employed.

According to Peters, the pore-filled compact can be carburized, but he also states that the Cu coating is an "automatic stop-off" against decarburization. It would be equally so against carburization, so that the Cu would have to be dissolved off the surface before carburization, as is done if it is desired to restore porosity and oil retention to the surface.

It is claimed that steel-copper structures, treated by quenching and tempering with the tempering at precipitation-hardening temperature, can be obtained with 175,000 psi tensile and 3% elongation. Other tempering temperatures produce down to 80,000 tensile, 8% elongation.

Many precautions listed by Peters must be observed in order to avoid difficulties and secure optimum results.

These products seem to have potentialities in some lines where the porous products are inapplicable, but, for equal strength, the ductility is inferior to that in conventional steel of like C content.

BIBLIOGRAPHY

1. H. A. SCHWARTZ, Ferrous alloy, U. S. Pat. 2,069,423, February 2, 1937.
2. R. A. EDMUNDS, Mixture for the production of malleable iron, U. S. Pat. 2,069,717, February 2, 1937.
3. F. R. BONTÉ, Die costs cut with graphitic steels, *Am. Machinist*, V. 81, 1937, pp. 207-08. G. A. STUMPF and F. R. BONTÉ, Graphitic steels, *Ind. Heating*, V. 4, 1937, pp. 728-833. F. R. BONTÉ and M. FLEISCHMANN, Developments in graphitic steels for tools and dies, *Metal Progress*, V. 31, April 1937, pp. 409-13.
4. F. R. BONTÉ, Ferrous alloys and methods of manufacture, U. S. Pat. 2,087,764, July 20, 1937.
5. A. B. KINZEL and R. W. MOORE, Graphite in low-carbon steel, *Metals Tech.*, V. 1, September 1934, *AIME Tech. Pub.* 565, 6 pp.
6. C. WELLS, Graphitization in high purity iron-carbon alloys, *Trans. ASM*, V. 26, 1938, pp. 289-344. See also C. R. AUSTIN and B. S. NORRIS, Temperature-gradient studies on tempering reactions of quenched high-carbon steels, *Metals Tech.*, V. 5, 1938, *AIME Tech. Pub.* 923, 23 pp.
7. G. V. SMITH and S. H. BRAMBIR, Graphitization of welded and of end quenched carbon and molybdenum steels, *Welding J.*, research supplement, V. 29, March 1945, pp. 153S-157S. See also reference 17.
8. H. J. KERR and F. EBERLE, Graphitization of low carbon and low-carbon molybdenum steels, *Welding J.*, research supplement, V. 29, February 1945, pp. 86S-122S.
9. C. R. AUSTIN and M. C. FETZER, Cementite stability, *Trans. ASM*, V. 29, 1941, pp. 339-54.
10. REBECCA HALL, High-strength and wear-resistant malleable cast iron, *Trans. AFA*, V. 41, 1933, pp. 112-26.

11. F. L. COONAN, Alloying elements in malleable iron, *Foundry*, V. 60, October 1932, pp. 43-4.
12. M. H. HUGHES and J. G. CUTTON, Graphite in cold-rolled subcritically annealed hypoeutectoid steels, preprint 13, American Society for Metals, 1945, 20 pp.
13. *Graphitization in Steam*, symposium, American Society for Metals, 1946. A. D. BAILEY, chairman, Fundamental investigation of graphitization in steam piping, progress report 5, *Edison Elec. Inst. Bull.*, V. 14, February 1946, pp. 48-50. S. L. HOYT, R. D. WILLIAMS, and A. M. HALL, Summary report on the joint EEI-AEIC investigation of graphitization in steam piping, *Welding J.*, V. 25, June 1946, pp. 332S-339S.
14. J. R. CADY, H. W. GILLET, and I. H. GRENELL, Enemy matériel from the metallurgical point of view, *Metal Progress*, V. 47, February 1945, pp. 289-320.
15. P. SCHWARTZKOPF, Engineering properties of sintered vs. cast metals, *Product Eng.*, V. 17, February 1946, pp. 122-6.
16. F. P. PETERS, Cemented steels, *Materials & Methods*, V. 23, April 1946, pp. 987-91.
17. G. V. SMITH, R. F. MILLER, and C. O. TARR, Precipitation and reversion of graphite in low-carbon low-alloy steel in the temperature range 900-1200°F, *Metals Tech.*, V. 11, June 1944, *AIME Tech. Pub.* 1695, 6 pp.
18. E. S. KOPECKI, Cemented steels, *Iron Age*, V. 157, May 2, 1946, pp. 50-4.
19. C. F. FLOE, The nitriding of steel, *Metal Progress*, V. 50, December 1946, pp. 1212-20.
20. J. B. AUSTIN, Effect of changes in carbides on the properties of steel, *Ibid.*, pp. 1191-5.

SECTION IV. OTHER APPLICATIONS OF HEAT TREATMENT

CHAPTER 15

HEAT TREATMENT IN RELATION TO WELDING AND MACHINING

There remain to be considered certain heat treatments involved in fabrication by welding and by machining, processes of major importance in the metal-working industries. Welding is a high-temperature process; hence an automatic heat treatment of the material welded inevitably occurs. This entails certain limitations upon welding, and so an important part of the welder's art consists in so controlling the welding process as to avoid involving such heat treatment as would produce undesirable structures, or else applying a corrective heat treatment thereafter.

Machining, especially at a rapid rate, cold-works the steel to some depth, and may even create enough heat at the cut surface to produce a type of automatic heat treatment of a thin surface skin. Because mechanical properties, especially fatigue behavior, are influenced by surface conditions, these matters may be of importance. However, the major connection between machining and heat treatment lies in the fact that ease of machining is vastly affected by the structure present as a result of prior heat treatment or lack of it.

Welding. Welding may be done between pieces of steel that are still solid, by heating them into the austenitic state, fluxing off the oxide skin, and pressing them together, or by mechanically breaking through any oxide layer. This is the traditional forge welding done by the blacksmith, and it is mechanically done in the welding of skelp into pipe. The pieces are generally cooled slowly enough after the weld is made to give an annealed or normalized structure, without formation of bainite or martensite, especially since the steels, so welded, are generally low in C.

Most welding, however, is done by fusion. Several modern methods, their possibilities and limitations, are described by Sparargen.¹

Molten metal is supplied by one means or another between the faces to be joined. With the pieces being joined of heavy section and not preheated, the molten metal is "chill cast," and the just-frozen metal is quenched by the rapid abstraction of heat into the surrounding cold metal. No other quenching medium is needed to produce as rapid cooling as that of a conventional quench, just as gears can be "quenched" by pressing them into contact with a cold die.

The weld metal has perfect contact with the parent metal, which acts as a coolant. That relatively slight preheating of this coolant will greatly affect the cooling rate is understandable by comparing (Figs. 98 and 101) the differences between cold and hot water or oil.

There is no great difficulty in fusing two pieces of steel together by a weld, no matter what the C content. If the parent metal can be sufficiently preheated, and the weld tempered while still above M_s , cracking can be avoided, and, even if martensite is formed, and some way is found to avoid cracking during welding, prompt tempering of the martensite will avoid or minimize later cracking. With resistance welding, the sequence of operations can be controlled so as to preheat, fuse, cool at a regulated rate, and, finally, temper, in a continuous operation. Hence, if a welding method can be found in which the proper heat treatment can be applied, there should be no such thing as an unweldable steel. The term, weldability, refers to ordinary welding methods with only weak efforts toward applying the temperature cycles that the heat treater would apply to the case.

The fusion weld has a "heat-affected" zone adjacent to it.

Subsequent passes in arc welding may temper the quench-metal deposited in earlier passes. The dimensional changes that occur when austenite quenches to martensite have been described (Vol. I, p. 438), and the propensity toward quench cracking has been noted. Notch propagation from a crack has also been discussed (p. 2).

Cracking. A weld containing a hidden crack may be an unsafe weld, especially if impact or repeated stress will be encountered in service. Precautions against weld cracking must, therefore, be taken. The mere formation of hard relatively brittle-structure lower bainite or even martensite is not necessarily fatal, because a thin layer of brittle material (brittle in mass), backed up by tough material, may not behave in brittle fashion any more than cementite layers in pearlite make pearlite brittle. Actually, they make it strong without greatly detracting from toughness. Hence, a thin hard zone adjacent to a weld may not be unacceptable; a thick one probably will be, and a crack leading into a hard zone definitely is.

As Herres² points out, arc-welding electrodes are coated with slag-forming materials, which protect the molten weld bead from oxidation and provide necessary stability to the arc. These coatings generally contain moisture or organic binders that release H₂. The presence of moisture or H₂ is likely to produce cracks akin to the flakes and shatter cracks discussed in Vol. I. When cracking from this cause is avoided, the mere presence of a thin hard layer may be of no moment. Herres reports that 0.40–0.50% C steel, fully quenched and tempered back to 100,000 tensile, has been welded with no preheat and without cracking, provided the weld-rod coating has been properly chosen. Much of the practical limitation on weldability may, therefore, be removed as coatings are improved. Elimination of the coating and supplying an anhydrous slag to the arc are already done in "submerged arc" welding, which has limitations and difficulties of its own, as well as possibilities. Methods of supplying the slag in other ways than as a coating, by which the necessity of making the coating stick to the rod is obviated, have by no means been exhausted. That it is hydrogen-embrittled martensite, rather than mere martensite, that is especially to be feared has been mentioned in Vol. I, p. 248.

Weld cracking, either in the deposit or in the parent metal, arising from the dimensional changes of the martensite transformation, can be avoided if there is no formation of martensite. However, strong welds are wanted, as is strong parent metal. So the problem is much like that of the mild-alloy steels discussed in Vol. III, where normalized strength is sought and martensitization avoided. It is much easier to avoid martensite when the C is low, and, likewise, when alloying elements that foster hardenability are low. Thus low plain-C or low-C low-alloy steels are much easier to weld without cracking than more hardenable steels, and the vast majority of welded structures are built up from low plain-C steels; moreover, many of them are of rimmed or semikilled rather than fully killed steel.

Applicability of S Curves. From the S curves and Jominy curves, it is evident that an effective way to prevent formation of martensite is to give the steel time to transform at higher temperatures, slow down the rate of cooling, and allow austenite to go over to pearlite or upper bainite, and that preheating the faces to be welded so that the rate of cooling in the heat-affected zone will be slow, or keeping the weld and the heat-affected zone up to a temperature where any martensite that has been formed will temper (postheating), will do the job, within limits.

The speed of welding, that is, the volume of bead or fused metal deposited in a given time, and the section of the parent plate, affect the cooling rates, and modify the requirements for pre- and post-heating.

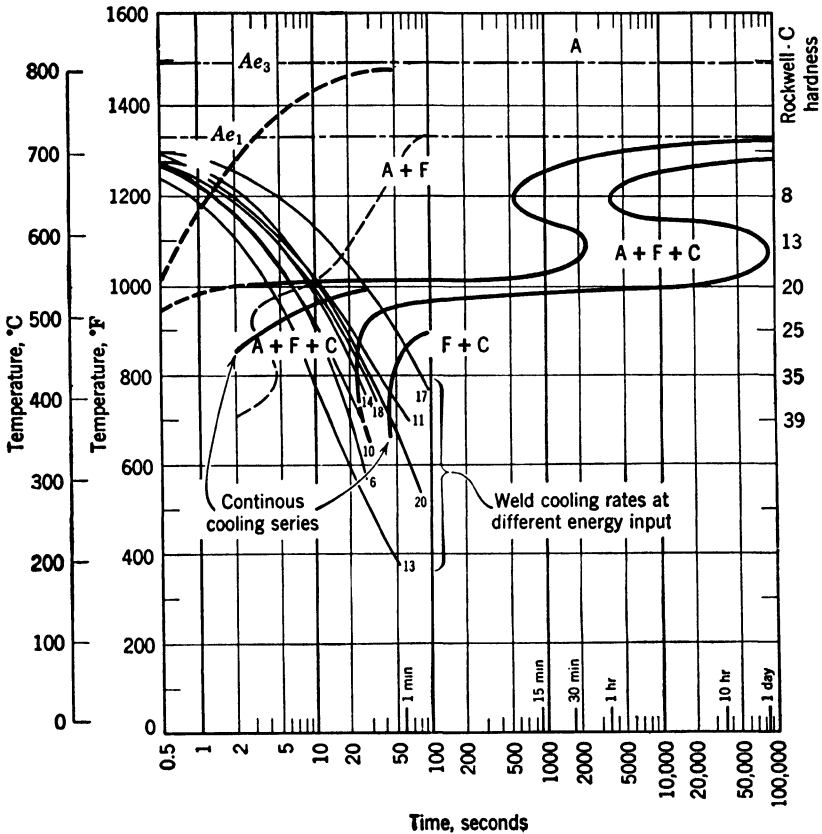

FIG. 118. S curve for steel of almost identical composition with plate-investigated. Curves indicating the beginning and end of transformation on continuous cooling have been added, and the cooling curves for most of the plates investigated have been superimposed.

Haynes, Graft, and Spencer³ found that rerolled rail steel of 0.73 C, 0.80% Mn could be arc welded without preheat and without production of martensite in the heat-affected zone, provided the heat input to the welding rod was sufficient. When the weld bead was thus made to contain enough calories to ensure sufficiently slow cooling in the parent metal, the heat-affected zone had a pearlitic struc-

ture. The ductility of the weld was low, but these authors consider it ample for many purposes. At any rate, their work is an example of modifying the welding process to fit the metallurgical requirements of a reputedly unweldable steel.

The metallurgical requirements of welding are well illustrated by a cooling S curve, as illustrated in Fig. 118 from Hess,⁴ but, as was brought out in Vol. I, the isothermal S curve is not directly applicable.

Solution of Cementite. In the very rapid heating, which the parent metal undergoes in welding, homogenization of austenite tends to be incomplete in the heat-affected zone. Obviously, the finer the initial structure and the larger the ratio of surface to volume of the carbide plates or particles, the easier it is for carbide to go into solution. If full solution and a considerable approach to homogenization occur, A_{r_3} will be considerably depressed, and completion of the transformation to ferrite and pearlite may not occur during the rapid cooling.

If the initial structure has the cementite in the spheroidized condition, especially if the spheroids are large and far apart, some of the cementite will remain undissolved on heating. On cooling, these undissolved particles exert the trigger action to induce starting and completion of A_{r_3} at higher temperature than when the initial structure is pearlite, and solution of the carbide plates, with their large ratio of surface volume, is easy.

Underbead Cracking. Hoyt, Sims, and Banta⁵ show the strong relation between the initial structure of the parent metal and the propensity toward underbead cracking. Thus, material to be welded may require heat treatment prior to welding in order to reduce its crack sensitivity.

Stress Relief. Of course, if a welded joint can be kept from cracking and can be tempered after welding, the occurrence of martensite next to the weld is of no moment. However, most welded objects are inconvenient or impossible to have bodily tempering applied, and even local tempering, in a second operation, is difficult to apply. In the weld itself, the coarse-grained cast structure of the first pass is often refined by the heat from the second pass raising it above A_c . The last pass is sometimes peened to refine its structure by mechanical working, and to help relieve internal stress. Internal stress results from shrinkage during cooling, thus tends to be present, even when no martensitic transformation is concerned. A local or a general stress-relief anneal may be applied.

The welding operation, however carried out, has to avoid other faults, such as porosity, flux inclusions, oxide inclusions, too shallow or too deep penetration, that have nothing to do with the response of the weld and adjacent metal to the thermal conditions, but which often limit one's control of thermal conditions.

Steel Composition. The most straightforward welding problem is one in which there is no possibility of getting martensitic hardening. This had much to do with the development of the high-P type of weldable mild-alloy steels, for, although even a little P strengthens, it does not confer material quench hardenability. Since low-C material is often used anyhow, and the C content, for a given strength, can be cut as the P is raised, the embrittling tendency of a combination of too high C and P is more or less automatically avoided.

The border line between weldability and nonweldability has been more discussed²¹ in connection with alloy than with plain-C steels, especially as to the C-Mn steels. With only normal Mn content, 0.35% C is often taken as the limit of weldability of plain C steel. Roughly, if the sectioned weld shows over 350 Vickers in the heat-affected zone, cracking is often considered to be likely, and a change in procedure to give a slower cooling rate is called for. (Actually, toughness, not softness, is wanted.) This is discussed in the *Welding Handbook*,⁶ by Harder and Voldrich,⁷ and by Spraragen.¹ A refractory "backing bar" to retard cooling may be used on certain types of welds.

The limitations as to maximum hardness in or near a weld apparently are being revised upward, Barnett¹⁶ sets 390 Vickers for ordinary electrodes and 500 for the low-H type of electrode in welding 2330. McDowell¹⁷ gives 465 Vickers. O'Neill¹⁸ remarks that the hardness limit (250 Brinell equivalent) heretofore set in British practice is unnecessarily low. Crook¹⁹ started with 300 Brinell equivalent and raised it to 450.

Although the welder normally seeks to avoid the heat-treating effects and would be happier if his steel were nonhardenable and free from transformations, welding with due regard for the limitations imposed by transformations allows use of stronger steel and production of stronger welded structures. Knowing what has to be avoided is as important in the metallurgy of welding as knowing what to do is in ordinary heat treatment.

Composition and Heat Treatment for Machinability. "Machinability" is a specific rather than a general term. When smooth finish,

with freedom from tearing and from burrs is paramount, the definition may be quite different from that when tool life is the criterion. Turning, broaching, milling, drilling, sawing, etc., are done with cutting tools of different shapes and with everything from C tool steels through high-speed and stellite, to carbide-tipped tools, at widely varying speeds and feeds, and with different cutting fluids.

Mechanism of Machining. Chip removal involves a penetration of the tool tip into the surface of the material cut, as a wedge, which pushes the chip away from the piece. The chip rides against the tool and tends to weld to it, then to break away. The tool form is chosen not only for its wedge action but also for curling or breaking the chips so that they can be gotten out of the way. Since the material is not really cut, but wedged apart, the surface tends to be torn and rough, on a microscale, rather than smooth. The "cut" surface is a slightly flowed surface, and the chip develops a large amount of flow. The chip may stay together as a curl, or it may fracture. It takes energy to keep the metal in the chip flowing, and so, the quicker the chip breaks off and ceases to be deformed, the better. Before the steel can fracture, it has to pass its yield strength and flow, much as in a tensile test, and in the process of flow, it becomes cold-worked. A work-hardened layer is formed on the surface, its depth depending on the way the cut is made and the steel's own propensity toward work hardening.

Cold Work. Ordinary machining produces a cold-worked layer at the surface (compare Fig. 17, Vol. I), so that it is often necessary to anneal, or at least stress-relief-anneal, or to etch away something like 0.01 in. to get an electroplated coating to stick, though it is not clear why the adhesion to the cold-worked surface is poor. Even light polishing with emery paper cold-works to a depth of some 0.001 in. Cases of even deeper effects have been cited earlier (Vol. I, p. 218).

Grinding under heavy pressure is even more prone to cold work than machining, for it may produce an 0.02-in. layer. This is in spite of the high temperature developed at the very surface in a severe grinding operation which easily results in grinding cracks on sensitive steels.

As an extreme case, Hill and Dietz⁸ report finding a depth of 0.025-in. work-hardened about a hole drilled by a dull carbide boring tool in 3312 annealed to 18 R.C. The extreme surface layer was hardened to 63 R.C. The temperature developed may be sufficient to soften the work-hardened skin, and the piece may get hot enough

ahead of the tool to alter the mechanical properties of the steel in the heat-affected zone.

The degree of tearing depends on the mechanical properties, which correspond to the structure. Low-C steels and those with heavy ferrite networks cut easily, that is, without expenditure of much energy, in that their tensile strength is low, but they flow a great deal before fracture, are "gummy," tear, and tend to weld to the tool; and the chips tend to come off in long curls rather than to break up. Embrittling such steels by work-hardening them, as by cold drawing, reduces the plastic range and leads to less tearing, better finish, and shorter chips, although the force necessary to split the piece is increased because of its increased strength.

Optimum Properties. The optimum for "easy" machining is a steel that is weak, with its tensile strength not much above its yield strength, and is rather brittle, that is, a steel that resembles cast iron or completely malleableized iron.

Large massive hard carbides in the work cut tend to wear the tool, and so hypereutectoid steels with massive cementite networks or large chunks of carbide that never dissolved in austenite are avoided. Relatively large sharp carbides and very hard ones have their place in the cutting tool itself. In the work cut, small rounded carbides, uniformly distributed and surrounded by a matrix that will keep them away from the tool, that is, a spheroidized structure, minimize the wear.⁹ Making the chip break up instead of continuing to bear on the tool also helps, and small disseminated weak brittle particles in the matrix provide stepping stones for the breakage. In general, the presence of another phase in the matrix helps.

Grain Size. The effect of grain size on toughness is discussed in Vol. I, Chapter 15. From this it is obvious that coarse grain decreases toughness and, hence, may favor machinability. In the tearing of a tough steel, a propensity toward local rather than general flow, that is, high R.A., and low elongation, rather than the reverse, will give a smoother finish.

Pearlitic Structures. In pearlite, the hard brittle carbide layers are interspersed between layers of ferrite, but fine pearlite is tougher than coarse, so that a coarse pearlite structure may afford enough ferrite cushions to protect the tool against undue abrasion and be more readily split. On the other hand, tool protection may demand the maximum dispersion of the carbide, and quenching and tempering to get fine dispersion, with a long spheroidizing draw just below

the critical to weaken the steel and to round off the carbides, may be called for.

Although carbide provides a second phase in the ferrite matrix, there may not be enough, in low-C steels, to avoid tearing roughness, so that 1020 is often more acceptably machinable than the weaker 1010. As the carbide content increases, the lamellar pearlite structure becomes too hard and strong.

Spheroidization. Up to a certain point, coarsening the pearlite is effective; beyond that it is necessary to spheroidize somewhat. As C rises further, still more complete spheroidization is called for. The dividing line will vary with the type of machining. Robbins¹⁰ discusses this. To supply more of a suitable second phase to diminish tearing roughness and to supply stepping stones for chip breakage, an increased amount of manganese sulphide, a material always automatically present at a low level in steel, may be utilized. Manganese sulphide can be reasonably well distributed; it is plastic at rolling temperatures, brittle at ordinary temperatures, but soft enough so as not to produce undue wear on the tool. Hard inclusions can have equally embrittling effects, but are scrupulously avoided because of tool wear. Graphite and temper C are ideal inclusions, but can only be readily produced in a high-Si matrix. Lead makes another suitable addition, as is discussed in Vol. III.

Free-Machining Steels. "Free-machining" steels, especially those for use in automatic-screw machines, are commonly provided with increased S, and, simultaneously, with sufficient Mn to combine with the S, since MnS is less deleterious to the mechanical properties of the steel than FeS. Going from 0.03% to 0.05% S perceptibly improves machinability in most types of cutting, an improvement that continues up to at least 0.20% S. Sometimes S is raised as high as 0.35%, but the improvement is relatively small above 0.20%. Transverse toughness is dropped rapidly as the S rises above the normal content, and so a compromise has to be made between machinability and mechanical properties.

The P content is often raised as well. Phosphorus does not form a second phase; it enters the ferrite, strengthening it, and making it work-harden and embrittle more readily. It strongly increases the yield ratio of ferrite, a feature previously mentioned as desirable. Nitrogen may also add strength. Bessemer steel is normally high in P and contains a little more N than open-hearth; hence, it is a natural base to which S may be added to produce screw stock.

The mechanical properties, especially those in other than the longitudinal direction (Vol. I, p. 118), cannot be forgotten in the urge to improve machinability. When strength is required, the C level, the other composition, the structure, and its heat treatment required to produce it must all be adhered to; let the machinability fall where it may, unless the over-all cost of so doing is higher than the introduction of a preliminary heat treatment solely for machinability and a final one for properties.

For a given type of machining, the structure, at a given C level, is the primary criterion, and chemical composition secondary, though some modification may be called for as a result of the strengthening of the ferrite by one alloying element, or the production of harder more abrasive carbide by another.

Structures for Various Types of Machining. Woldman¹¹ exhaustively studied 0.50% C oil-hardening steels for gears, including 3250, 4350, and 6150. For broaching, gear cutting, and single-point turning, laminated pearlite was the preferred structure for all, whereas in the automatics a spheroidized structure, obtained by quenching, then given a suitable long draw close to the critical, was the best. Fine grain in the matrix with the carbides spheroidized was considered better for 3250 and 4350, while a coarse-grained matrix produced by a long spheroidizing anneal seemed better for 6150.

The gears, after machining, were oil-hardened and given a low-temperature draw. In this final operation, the previously spheroidized (long-anneal) gear showed the least distortion, the quenched and spheroidized ones next, the pearlitic gears the most, a factor that may, in particular cases, compensate for the machining advantage of a structure more prone to distortion.

Variability. Very fine-haired differences in structure and in the type and distribution of inclusions, differences not apparent on casual consideration or even microexamination, are often detectable in the machine shop. Supposedly duplicate heats often show considerable individuality as to machining behavior. In free-machining steels of given S and Mn content, there is a widespread belief¹³ that the mode of introduction of S makes a difference; that is, residual S, carried through the melting process from the original charge, S added in the ladle as the element, or that derived from the ladle addition of a sulphite, which breaks down and supplies S, will each behave differently, though proof of consistent differences that would establish an advantage for a given method of introduction is sometimes pretty weak.

Equally fine-haired differences exist between different types of machining. Broaching, for example, is considered¹⁰ to require the steel to be a bit harder than drilling. Moreover, two machine shops performing exactly the same operation, but using different tools, speeds, feeds, or having some other difference in their technique, may place two lots of steel in reverse order, in the case of fine-haired differences. This is especially true of automatic-machine operations on screw stock. Testing for evaluation of machinability therefore becomes a complex matter when such cases are involved.

Major Relations. However, direct connection between behavior in any particular machining operation and gross differences in microstructure are easily discernible. Woldman and Gibbons²⁰ sum it up that alloy steels of over 0.45% C rough-machine best in the spheroidized condition, but the lamellar condition is best for light cuts, as in finishing gears, whereas under 0.40% C they behave best in all machining operations when lamellar. Wittman¹⁴ has shown the relations given in Table 26.

TABLE 26

Carbon Content	Heat Treatment	Structure	Behavior In			
			Turn- ing	Form- ing	Drill- ing	Broach- ing
Low	Normalized and annealed	Blocky ferrite	Good	Good	Good	Good
Medium	Spheroidized	Spheroids	Good	Poor	Fair	Poor
	Annealed	Lamellar pearlite	Fair	Good	Good	Good
	Quenched and tempered	Tempered martensite	Fair	Fair	Fair	Fair
High	Spheroidized	Spheroids	Good	Good	Good	Fair
	Annealed	Lamellar pearlite	Fair	Poor	Poor	Poor
	Quenched and tempered	Tempered martensite	Good	Fair	Good	Good

If a part of medium C content is first to be turned and then broached, one could either compromise and use a tempered martensite structure, with fair behavior in both, or start with a spheroidized structure, turn, then re-heat-treat for a lamellar structure for broaching.

A specific case, in line with this table, is given by Sorenson,¹⁵ for lathe turning of 4340. The original treatment was to normalize from 1600°, heat to 1525°, hold 25 hr, and furnace-cool, resulting in

a ferrite-pearlite structure of 217 Brinell. The revised treatment was: normalize from 1650°, reheat to 1385°, cool to 1210°, hold 24 hr, then air-cool, resulting in a spheroidized structure of 192 Brinell, which not only gave a shorter annealing cycle, but also materially increased tool life. If this steel were to be broached instead of turned, the original treatment would be preferred.

"Circumstances alter cases" is abundantly true in relation to machinability. Understanding of fundamental truths and brain work, in their application to particular cases, are required in this, as in all other phases of choice of heat treatment. The human element still bulks large.

BIBLIOGRAPHY

1. W. SPRARAGEN, Five years of progress in welding, *Metal Progress*, V. 48, October 1945, pp. 905-16. Arc welding alloy steels, *Trans. ASM*, V. 33, 1944, pp. 535-63.
2. S. A. HERRES, Weldability of hot rolled vs. quenched and tempered constructional steels, *Welding J.*, research supplement, V. 24, March 1945, pp. 129S-152S.
3. C. B. HAYNES, W. H. GRAFT, and R. G. SPENCER, Arc welding of rail steel, *Metal Progress*, V. 47, May 1945, pp. 912-15.
4. W. F. HESS, Effect of cooling rate on the properties of arc welded joints in carbon moly 0.5" plate, *Welding J.*, research supplement, V. 21, December 1942, pp. 6088-6198. Recent progress in the application of welding to steel, *AISI Yearbook*, 1944, pp. 115-31.
5. S. L. HOYT, C. E. SIMS, and H. M. BANTA, Improving the weldability of high-strength low-alloy steel, *Iron Age*, V. 155, 1945, May 31, pp. 38-46; June 7, pp. 70-6; June 14, pp. 74-80. Metallurgical factors of underbead cracking, *Metals Tech.*, June 1945, *AIME Tech. Pub.* 1847, 24 pp. *Welding J.*, research supplement, V. 24, September 1945, pp. 433S-445S.
6. *Welding Handbook*, American Welding Society, 1942, 1593 pp.
7. O. E. HARDER and C. B. VOLDRICH, Weldability of N.E.1330 and N.E.1335, *Welding J.*, research supplement, V. 21, 1942, pp. 450S-466S. *Metal Progress*, V. 43, March 1943, pp. 409-10.
8. J. HILL and C. W. DIETZ, Hardening by tool abrasion, *Metal Progress*, V. 48, July 1945, p. 90.
9. D. F. RODA, Relation to size of spheroids in tool steel to its machinability, *Trans. ASM*, V. 26, 1938, pp. 950-7.
10. F. T. ROBBINS, Metallurgical aspects of machinability, *Iron Age*, V. 157, 1946, March 21, pp. 42-7; March 28, pp. 47-51.
11. N. E. WOLDMAN, Relations between microstructure and machinability, *Iron Age*, V. 147, 1941, June 19, pp. 37-40; June 26, pp. 44-9.
12. O. W. BOSTON and L. V. COLWELL, The effect of hardness on the machinability of six alloy steels, *Trans. ASM*, V. 31, 1943, pp. 955-70. O. W. BOSTON and W. W. GILBERT, An analysis of machinability data from cold finished and heat treated SAE 1045 steel, *Trans. ASM*, V. 28, 1940, pp. 186-205.

13. H. M. CLARKE, Machinability of sulphurized steels, *Steel*, V. 117, December 17, 1945, pp. 116-19, 162.
14. G. P. WITTEMAN, Studies on the machinability of carbon and alloy steels, *Mech. Eng.*, V. 67, September 1945, pp. 575-83.
15. J. SORENSON, Tool life increased by improved annealing procedure, *Steel*, V. 114, May 8, 1944, p. 114.
16. O. T. BARNETT, Repair welding of steel castings, *Foundry*, V. 75, January 1947, pp. 74-7, 202-10.
17. J. K. McDOWELL, Welding of steel castings, *Ibid.*, p. 154.
18. H. O'NEILL, Metallurgical factors in welded steels, *Trans. Inst. Welding*, V. 9, February 1946, pp. 3-9.
19. W. J. CROOK, Weldable high-strength steel castings, *Metal Progress*, V. 50, November 1946, pp. 906-14.
20. N. E. WOLDMAN and R. C. GIBBONS, Machining troubles decline when the metallurgist sits in, *Am. Machinist*, V. 90, November 7, 1946, pp. 104-08.
21. J. G. LUTHER, C. E. JACKSON, and C. E. HARTBOWER, A review and summary of weldability testing carbon and low-alloy steels, *Welding J.*, V. 25, July 1946, pp. 376S-396S.

CHAPTER 16

THE HUMAN ELEMENT

Batch versus Continuous Operation. In a batch-heating process an individual operator controls the time and temperature, the placing of the charge, and the way it is cooled on withdrawal from the furnace. He may vary these factors so as to compensate for variations in the stock.

In a continuous furnace operating on quantity production, all these factors are worked out ahead; the furnace controls are set for the desired temperature, the conveyor speed is adjusted, the charge is placed on the conveyor in the same fashion each time, in a manner found by previous experiment to allow suitable uniformity of heating, and the quenching or other cooling is done in a fixed fashion. With such equipment the problem resolves itself into avoidance of mechanical failure of the equipment and vigilant pyrometer checking to see that calibration is maintained. With the equipment operating the same, the time-temperature relation is fixed, and with the same stock, in the same form and dimensions, the result should be uniform, provided the stock is uniform. To secure this last, great pains have to be taken to be sure that the composition and the grain-coarsening and allied characteristics of the stock do not vary.

Adjustment Required Even in Continuous Operation. If they do vary, so that the time-temperature factors require to be altered to compensate, great care must be taken in segregation of the lots that require different treatment. When the operator knows that lot *A* is being followed by lot *B*, which takes a different treatment, he must clear the furnace of lot *A* before changing the furnace conditions and starting lot *B* through.

The operator of a batch furnace has a similar task in miniature. Owing to the smaller lots he deals with, the variations in furnace conditions may have to be made frequently; so the responsibility is usually more directly on him than on the operator of the continuous furnace whose schedule is set by the metallurgical supervisor. The batch-furnace operator may well be charged with some inspection

duties, at least in checking specimens of his output for hardness; so he may have an immediate check on uniformity of heat treatment.

Intelligent Operators Required. The more intelligently he can handle his equipment and the more promptly he knows when any condition is changing so that he can take corrective measures, the more uniform can the product be made.

Some furnace makers say that, with the class of labor normally operating furnaces for large production, it is essential to have "only one button that the operator can push"; if anything is left to his judgment there is no certainty whether his decision will be the correct one or not. In such a case there must needs be skilled supervision close at hand, for, no matter how good or how automatic the equipment, unforeseen emergencies will occasionally arise.

It takes an entirely different class of artisan from the button pusher to operate a general heat-treating department where different steels and varying sizes and shapes of pieces require varied temperatures and skilled quenching. Here nothing will take the place of brains, of experience, of common sense, and of an understanding of the principles of heat treatment.

The metallurgist may draw up instructions for heat treatment for a steel of given composition and grain-coarsening characteristics on the basis of time and temperature in heating and cooling. The instructions may apparently be adhered to in the shop without producing material of uniform properties. The charge may be placed in a furnace which is held to the desired heating program of time and temperature, without the charge having the desired and necessary rate of heating and time of holding.

Variations That May Enter. Loading so that different parts of the charge are unequally exposed to heat and cooling in masses so that the cooling rate is unequal will produce nonuniformity of product. Variation in size and shape of the pieces being heated or cooled, and in methods of charging and discharging, may produce highly variable results from the same steel.

Hence not merely time and temperature alone, but the whole complex time-temperature-mass-surface relation must be adjusted. The adjustment has either to be made by the heat treater himself or embodied in specific instructions to him, drawn up by some one who understands that the purpose of heat treatment is not to hold a piece of steel for so long in a furnace that it is so hot and then to quench or cool it but to produce definite changes in the steel by heating and cooling.

If the geometry of the piece or of the charge as a whole calls for a different schedule from that of another piece or another charge, it must be recognized and allowed for in the "specifications for heat-treatment practice" issued to the shop. This allowance requires human intelligence, and the necessity for such allowances makes heat treatment in the shop something of an art, instead of the science that it is in the laboratory. The aim should be to bring the shop standard of practice as nearly as possible to the standard which can be reached in the modern laboratory.

Human Control of Variables. The importance of the "human element" in heat-treatment operations cannot be overestimated, even though the practice in some of the largest shops in the country indicates that it is not considered an important factor. The man at the furnace is, as a rule, the ultimate key to the situation and, at the same time, the weakest link in the chain. He is the cook or chef who puts the metallurgical finish on material prepared at great expense by others, and it is his skill and exercise of judgment that very frequently determine the nature of the result and either makes or breaks the cycle of operation.

The Manner of Heat Application. Development of electric furnaces, automatic temperature-control devices for regulating the flow of electricity and fuel, certain forms of automatic heating and cooling equipment, and improved pyrometer equipment have done much to decrease dependence on the "human element" in the process of making or generating heat. However, it is the manner of applying and utilizing heat, not the process of making or generating heat, that determines the quality of the heat-treated product.

Science and Practice. The practice of the art of heat treating in some shops is out of line with development of the science of metallurgy from the laboratory point of view. The variations in the practice of the art incident to the "human element" are responsible for many difficulties that are improperly attributed to the steel, the furnace, the metallurgist, and other factors exclusive of the "human element" itself. It is necessary to strengthen this weak link in the chain of heat-treating operations if practice of the art is to keep step with development of metallurgical science and improved designs of heating and cooling equipment.

The notion that automatic furnaces with provision for automatic control of temperature and more or less continuous movement of material will, of themselves, eliminate the "human element" is unsound except in more or less rare cases in which there is no material

variation in the size, shape, composition, rate of flow or method of heating and cooling the product to be heat-treated, and provision to prevent overloading. Such variations make it necessary to consider the influence of the manner of loading and the time and rate of heating or cooling if the product is to be heated or cooled to the desired temperature, and in a manner dictated by the physical condition of the product or by metallurgical requirements. Too often we find modern installations of automatic types of fuel or electric furnaces heating and cooling a great variety of miscellaneous pieces of different size, shape, and weight with little or no thought of the necessity for varying the time or rate of heating by adjusting the load and rate of flow to the requirements. Such conditions frequently have been found responsible for variations in the quality of the ultimate product, as disclosed by the testing machine or in service, in spite of evidence in the form of pyrometer records to the contrary.

Heat Treatment Is an Art. Heat treating should properly be considered as an art or trade that includes not only the process of making or generating heat but also of "cooking" the material to be heat-treated with proper methods of heating and cooling to improve quality, and equally proper methods of handling the product and utilizing the heat to reduce the cost.

If, as is generally conceded, men should be paid in proportion to their skill and the part this skill plays in the make-up of the finished product, then a good annealer is as important and worth as much as a roller; and a good man in charge of heat-treatment work is as important and worth as much as a high-grade machine operator or tool-maker. In one instance, the man operates a machine, and it is the machine that more or less determines the result after it is set, or, at any rate, acts as a mechanical check on the operation. In the other instance, except when the manufacturing conditions are such as will permit an automatic furnace to eliminate the "human element," there is involved the matter of skill, judgment, and experience on the part of the furnace operator. The furnace and auxiliary appliances are but tools and, while it is desirable that they be of the best, their part in the operation is frequently little more than that of tools in the hands of the operator.

Experienced Men Needed. The "human element" in forging and heat-treatment operations is a controlling factor and the weakest link in present-day practice. The best men available are none too good for such important work. It is necessary that a better type of

operator be developed and trained to understand and apply the principles governing the application of heat as well as the process of making or generating the heat. Development of electric furnaces did much to improve conditions. Similar development of fuel-fired furnaces has followed to meet conditions under which it is desirable to employ equipment heated with fuel. Development of known possibilities in heat-treating equipment is retarded by knowledge of the fact that, under present conditions, the manufacturer of such equipment virtually places himself in the hands of inexperienced operators who, all too frequently, have the power to decide whether or not the equipment is suited to the requirements. This particularly is true with fuel-fired equipment, in the operation of which the process of "burning fuel" is frequently given more consideration than the process of heating and cooling the material to be heat-treated.

As was stated in the preface to the first edition, it is "the cost of a unit of quantity of given quality" that the heat treater should be interested in, not the cost of one of poor or of variable quality. A "penny-wise and pound-foolish" policy is never good, whether it is applied to fuel or to the caliber of the workmen.

The results sought in heat-treating practice are determined by the proper combination of the man, the furnace, and the steel—not by any one or two of them. Good steel is entitled to proper treatment in good furnaces, and both are entitled to the services of good men in order to produce better results.

INDEX

- Abnormal steel, 92
- Activated cyanide baths, 53
- Air-hardening steel, 17
- Ammonia, cracked, 150
- Annealing, 117, 216
- Arrested malleableization, 250
- Austempering carburized steel, 102
- Austenite, retained, 101, 172

- Batch versus continuous operation, 285
- Bluing, 116
- Box annealing, 117
- Bright normalizing, 119
- Brine for quenching, 235
- Brittleness, 3

- Carbide-nitride cases, 45
- Carbonates in carburizing compounds, 76
- Carbon blocks for protective atmosphere, 153
- Carbonitriding, 45
- Carbon pressure, 134
- Carbon restoration, 154
- Carburized steels, heat treatment, 91
 - properties, 3
- Carburizing, by gas, 45, 60
 - by liquid, 49
 - by liquid gas, 48
 - processes, 45, 58
 - steels for, 102
- Carburizing boxes, packing, 83
- Carrier gases, 66
- Case depth, in cyanide, 52
 - in gas carburizing, 71, 73
 - in nitriding, 45
 - in solid carburizing, 73
- Cast-iron heat treatment, 245
- Cast-iron borings for protective atmosphere, 151

- CH₄:H₂ ratio, 124
- Charcoal gas, 135, 145
 - production of, 146
- Chromium as stabilizer against graphitization, 266
- Chromium steels, staining, 120
- Circulation, forced, 193, 215
- Clean hardening, 120
- CO, behavior, 63
- CO:CO₂ ratio, 60, 124
- Coating processes, 55
- Coils, annealing, 117, 216
- Combination heating, 209
- Continuous furnaces, 210, 285
- Controlled atmospheres, 109
 - control, 147
 - purification, 135, 139, 145
 - types and applications, 149
- Convection, forced, 215
 - heating, 171
- Coolants, 229
- Cooling, 228
 - rates, center versus surface, 232, 234, 238
- Copper brazing, 120, 155
- Cracked ammonia, 150
- Cracking of welds, 273
- Crack propagation, 3
- Cyaniding, 46

- Decarburization, determination, 128
 - effects, 10, 110
 - in carburizing, 79
 - in nitriding, 43
 - in salt baths, 165
- Dew point, 123
- Die quenching, 239
- Diffusion in carburizing, 79
- Dilution of gases, 125
- Dissociation of ammonia, 37
- Distortion, 9, 41, 101, 173

- Dry cyaniding, 46
 Drying controlled atmospheres, 144
- Electrical-resistance heating of steel, 185, 205
 Energizers for carburizing, 75, 81
- Fatigue, of carburized steel, 95
 of decarburized steel, 12
 Flame hardening, 15
 Forced circulation and convection, 171, 193, 215
 Ford alloys, 252
 Forging, 176
 Free-machining steels, 230
 Fuel gases, 190
 Furnaces, for annealing, 118
 forging, 182
 gas-carburizing, 86
 nitriding, 39
 normalizing, 119
 solid-carburizing, 85
 Fused baths, 163
- Gas carburizing, 60
 Gases, for carburizing, 67
 for controlled atmospheres, 149
 for fuel, 190
 Gas quenching, 235
 Gears, 3, 15, 106, 175
 Generator gases, 137
 Generators for controlled-atmosphere gases, 151
 Grain coarsening in carburizing, 94
 Graphitic steels, 255
 Graphitization, in malleable, 247
 in steel, 266
 Grinding cracks, 173
- $H_2:H_2O$ ratios, 63
 Hardening from controlled atmosphere, 120
 Heat checking, 173
 Heat flow, 212
 Heating, principles, 170
 rates, 164, 176, 224
 Heat-resistant alloys, attack by gases, 159
- Heat treatment, of carburized steels, 97
 of cast iron, 245
 of malleable iron, 247
 of steel castings, 241
 High-frequency heating, 20
 High-speed steel, controlled atmospheres for, 111, 153
 decarburization in salt, 167
 Human element, 285
 Hydrogen, dry versus wet, 126, 130
- Induction heating for hardening, 15, 19
 Insulation of furnaces, 195
 Internal fillet by local hardening, 26
 Internal heating, 191
- Lead baths, 164, 230, 236
 Lithium, claims for, 148
 Low-carbon carburized cases, 82
- Machinability, 95, 277
 Malleable iron, heat treatment, 247
 Moisture, in carburizing gas, 65
 in controlling atmospheres, 144
 Muffles, 205
- Nitride-carbide cases, 45
 Nitrided cases, properties, 42
 Nitriding, 31
 Notches, effect, 2
 Notch propagation, 2
- Overheating in forging, 179
- Pack annealing, 117, 216
 Pack carburizing, 73
 Pearlitic malleable, heat treatment, 249
 Porous refractories, 194
 Porous steels, 268
 Powder metallurgy, 268
 Purification of controlled atmospheres, 135, 139, 145
- Quenching in induction hardening, 23
 Quenching media, 229

- Quenching oil, 233
Quenching steel castings, 241
- Radiant heat, 171
Radiant tubes, 194, 201
Radiation, 200, 219
Reactions among gases, 133, 141
Recarburization, 154
Rectification of salt baths, 165
Resistors, 204
Retained austenite, 101, 172
- Salt baths, 165
 furnaces for, 199
 hazards, 169
Salt quenching, 236
Scale, removal in quenching, 23
Scaling, 115, 185
S curves in relation to welding, 274
Sealing of furnaces using gas atmospheres, 39
Single quench of carburized steel, 98
Slots versus slugs in forging, 184
Soot deposition, 67
Springs, 9, 114
Steels for carburizing, 102
 for surface hardening, 17, 29
 for welding, 277
Stress gradient, 9
- Structure of steel, for induction hardening, 29
 for machinability, 281
 for nitriding, 34
Sulphur in controlled atmospheres, 134
Surface behavior in fatigue, 1, 9, 12
Surface hardening, 15
- Temperature of furnace versus of charge, 213
Tempering carburized steel, 101
Time quenching, 244
Tool steels, controlled atmospheres for, 113
Toughness, carburized steels, 97
Transition zone in carburized steel, 96
- Uniform heating, 183, 213
Unnotched impact bars, 6
- Volume changes in hardening, 172
- Warpage, in carburizing, 9, 100
 in nitriding, 41
 in quenching, 173
Wear resistance, 8
Welding, 272
White layer in nitrided cases, 44

