

BIRLA CENTRAL LIBRARY

PIHANI (RAJASTHAN)

Call No.

624

H796SS

Accession No

31652

STEEL AND TIMBER STRUCTURES

Compiled by a Staff of Specialists

EDITORS-IN-CHIEF

GEORGE A. KOOL, S.B.

FORMERLY PROFESSOR OF STRUCTURAL ENGINEERING
THE UNIVERSITY OF WISCONSIN

and **W. S. KINNE, S.B.**

PROFESSOR OF STRUCTURAL ENGINEERING
THE UNIVERSITY OF WISCONSIN

REVISED BY

R. R. ZIPPRODT, B.S.

MEMBER AMERICAN SOCIETY OF CIVIL ENGINEERS; PRINCIPAL CIVIL ENGINEER, OFFICE OF THE QUARTERMASTER GENERAL, WASHINGTON, D.C.; FORMERLY ASSOCIATE PROFESSOR OF CIVIL ENGINEERING, COLUMBIA UNIVERSITY

and **D. M. GRIFFITH, Ph.D.**

PROFESSOR AND CHAIRMAN OF DEPARTMENT OF CIVIL ENGINEERING, BUCKNELL UNIVERSITY; ASSOCIATE MEMBER, AMERICAN SOCIETY OF CIVIL ENGINEERS

SECOND EDITION

REVISED AND ENLARGED

FIFTH IMPRESSION

McGRAW-HILL BOOK COMPANY, INC.

NEW YORK AND LONDON

1942

STEEL AND TIMBER STRUCTURES

COPYRIGHT, 1924, 1942, BY THE
MCGRAW-HILL BOOK COMPANY, INC.

PRINTED IN THE UNITED STATES OF AMERICA

*All rights reserved. This book, or
parts thereof, may not be reproduced
in any form without permission of
the publishers.*

THE MAPLE PRESS COMPANY, YORK, PA.

PREFACE TO THE SECOND EDITION

In the preparation of the Second Edition of this volume, one of the six in the Structural Engineers' Handbook Library, it has been the aim of the undersigned to continue providing both the practicing engineer and the student with a reference work which covers thoroughly the modern civil engineering structures.

It has been the objective to introduce wherever necessary revised material which embodies the most recent design or construction procedure. For instance, the plate girder highway bridge in Section 3 has been completely redesigned to be in conformance with the 1941 A.A.S.H.O. Standard Specifications for Highway Bridges. Much new material on the design of timber highway bridges has also been added. Latest A.S.T.M. Specifications pertaining to several basic products or materials have been substituted for other specifications which have long since been revised.

Credit has been given in the body of this volume for data, details, or photographs used for purposes of supplementing the technical material. Mention should be made here of the fact that the following Associate Editors participated in the preparation of the First Edition: O. A. Bailey, W. C. Buetow, C. W. Chase, Chas. D. Conklin, Jr., F. W. Dean, F. W. Dencer, Henry D. Dewell, Phil A. Franklin, T. W. Golding, James H. Herron, C. J. Kennedy, H. E. Pulver, and Hermann von Schrenk.

R. R. ZIPPRODT.

BETHESDA, MARYLAND,
July, 1942.

PREFACE TO THE FIRST EDITION

This volume is one of a series designed to provide the engineer and the student with a reference work covering thoroughly the design and construction of the principal kinds and types of modern civil engineering structures. An effort has been made to give such a complete treatment of the elementary theory that the books may also be used for home study.

The titles of the six volumes comprising this series are as follows:

Foundations, Abutments and Footings
Structural Members and Connections
Stresses in Framed Structures
Steel and Timber Structures
Reinforced Concrete and Masonry Structures
Movable and Long-span Steel Bridges

Each volume is a unit in itself, as references are not made from one volume to another by section and article numbers. This arrangement allows the use of any one of the volumes as a text in schools and colleges without the use of any of the other volumes.

Data and details have been collected from many sources and credit is given in the body of the books for all material so obtained. A few chapters, however, throughout the six volumes have been taken without special mention, and with but few changes, from Hool and Johnson's Handbook of Building Construction.

The Editors-in-chief wish to express their appreciation of the spirit of cooperation shown by the associate editors. This spirit of cooperation has made the task of the Editors-in-chief one of pleasure and satisfaction.

G. A. H.
W. S. K.

MADISON, Wis.,
December, 1923.

CONTENTS

PREFACE TO THE SECOND EDITION..... v

PREFACE TO THE FIRST EDITION..... vii

Section 1. Buildings

ART.	STEEL OFFICE BUILDINGS	PAGE	ART.	PAGE
1.	Classification of buildings.....	1	12.	Spandrels.....
2.	Legal heights.....	1	a.	Architectural requirements..
3.	Design.....	2	b.	Kinds of spandrel beams.....
4.	Minimum floor loads.....	3	13.	Lintels.....
5.	Unit stresses.....	3	a.	Architectural requirements..
6.	Foundations.....	6	b.	Kinds of lintels.....
a.	Bearing capacity of soils....	6	14.	Cornices.....
b.	Caissons.....	7	a.	Architectural requirements..
c.	Pile foundations.....	7	b.	Supports for cornices.....
d.	Floating foundations.....	7	15.	Roofs.....
e.	Footings.....	8	a.	Design of roofs.....
f.	Party piers.....	8	b.	Drainage.....
g.	Cantilever foundations.....	8	c.	Roof coverings.....
h.	Grillage beams.....	8	16.	Balcony construction.....
i.	Slabs.....	9	17.	Skylight construction.....
j.	Cast-iron bases.....	9	18.	Towers.....
7.	Retaining walls.....	9	19.	Interior steel stacks.....
a.	Different types.....	9	a.	Self-supporting stacks.....
b.	Sub-basement construction..	11	b.	Stacks supported by floors...
8.	Floors and floor construction	12	c.	Lining, breeching, etc.....
a.	Floor construction require-	12		
b.	Standard vs. wide-flange	12		STEEL MILL BUILDINGS
c.	Types of floors.....	14	20.	Mill building construction....
d.	Beam framing.....	16	a.	Special features.....
9.	Columns.....	21	b.	Steel sash.....
a.	Requirements in column de-	21	c.	Safety requirements.....
b.	Column formulas.....	21	21.	Types of buildings.....
c.	Types of columns.....	21	22.	Columns.....
d.	Comparison of different types	25	a.	Types of columns.....
e.	Column splices.....	27	b.	Column bases.....
10.	Party walls.....	28	c.	Crane girder seats.....
11.	Wind bracing.....	29	d.	Truss connections to columns
a.	Wind load requirements....	29	23.	Roof trusses.....
b.	Resistance to wind stresses..	29	a.	Form of trusses.....
c.	Types of wind-bracing girders	31	b.	Truss details.....
			24.	Crane girders.....
			25.	Crane rails, fastenings and crane
			stops.....	57
			a.	Rails.....
			b.	Rail clips.....

ART.	PAGE	ART.	PAGE
c. Fastenings for heavy crane rails.....	58	a. Wooden doors.....	82
d. Crane stops.....	58	b. Steel doors.....	84
26. Bracing.....	59	41. Windows and skylights.....	85
27. Purlins and girts.....	59	a. Glass.....	85
a. Purlins.....	59	b. Wooden sash.....	89
b. Girts.....	60	c. Steel sash.....	91
28. Stairs, platforms, railings and ladders.....	60	d. Skylights.....	91
29. Stacks.....	63	TIMBER FRAMED FLOORS AND ROOFS	
30. Corrugated steel.....	64	42. Floor construction.....	93
31. Roofing and siding of corrugated steel.....	66	a. Thickness of sheathing and spacing of joists.....	93
32. Flashing for corrugated steel.....	66	b. Bridging.....	94
33. Ridge roll.....	67	c. Arrangement of girders.....	95
34. Fastenings for corrugated steel.....	67	d. Connections to columns.....	95
a. Clinch rivets.....	67	e. Connections to walls.....	95
b. Straps.....	68	f. Typical floor bay design.....	97
c. Clips.....	68	43. Roof construction.....	102
d. Wood nailers.....	68	a. Thickness of sheathing.....	102
e. Closing rivets.....	68	b. Spacing of roof joists.....	102
f. Nails.....	69	c. Arrangement of girders or trusses.....	102
g. Finish at doors and windows.....	69	d. Bracing trusses.....	103
h. Miscellaneous fastening details.....	69	e. Saw-tooth roof framing.....	105
35. Curtain walls.....	70	44. Mill construction.....	106
36. Ventilators.....	70	SLOW-BURNING TIMBER MILL CONSTRUCTION	
a. Monitor ventilators.....	70	45. Pintles over columns are fundamental to type.....	113
b. Circular ventilators.....	74	46. Rigidity of connection is necessary.....	116
37. Gutters and down spouts.....	75	47. Special beam arrangements possible.....	117
38. Roof coverings.....	76	48. Location of beams.....	117
a. Corrugated steel roofing.....	76	49. Floor details.....	118
b. Tar and gravel roofing.....	77	50. Anchoring of steel beams.....	119
c. Cement tile.....	78	51. Roofs.....	119
d. Slate.....	78	52. Columns and walls.....	120
e. Prepared roofings.....	79	53. Basement floors.....	120
39. Floors.....	80	BUILDING TERMS	
a. Ground floors.....	80		
b. Floors above ground.....	80		
40. Doors.....	81		

Section 2. Roof Trusses

ROOF TRUSSES—GENERAL DESIGN			
1. Roof trusses in general.....	130	8. Connections between purlins and roof covering.....	140
2. Form of trusses.....	131	9. Bracing of roofs and buildings.....	140
3. Pitch of roof truss.....	133	10. Choice of sections.....	142
4. Spacing of trusses.....	134	11. Form of members for roof trusses.....	143
5. Spacing of purlins.....	135	12. Joint details for roof trusses.....	144
6. Spacing of girts.....	137	13. Loadings for roof trusses.....	145
7. Purlin and girt details and connections.....	137	14. Weight of roof trusses.....	146
		15. Wind loads.....	147

CONTENTS

xi

ART.	PAGE	ART.	PAGE
16. Snow loads.....	149	DETAILED DESIGN OF A TRUSS WITH KNEE-BRACES	
17. Combinations of loads.....	150	42. General considerations and form of trusses.....	217
DESIGN OF PURLINS FOR SLOPING ROOFS		43. General methods of stress determination.....	218
18. Purlins subjected to unsymmetrical bending.....	152	44. Conditions for the design of a knee-braced bent.....	225
19. Load carried by a purlin.....	152	45. Determination of stresses in members.....	226
20. Conditions of design.....	153	46. Design of members and columns.....	229
21. Design of purlins for a rigid roof covering.....	153	47. Design of joints.....	236
22. Design of purlins for roof with a flexible roof covering.....	155	48. Design of girts.....	237
a. Purlin free to bend in any direction.....	155	49. Design of bracing.....	239
b. Purlin supported laterally by tie rods.....	157	ARCHED ROOF TRUSSES	
DETAILED DESIGN OF A WOODEN ROOF TRUSS		50. Form of arch trusses.....	243
23. Conditions assumed for the design.....	161	51. General methods for determination of reactions and stresses.....	247
24. Design of sheathing, rafters, and purlins.....	164	a. Three-hinged arches.....	247
25. Determination of stresses in members.....	165	b. Two-hinged arches.....	253
26. Design of members.....	166	c. Hingeless arches.....	256
27. Design of joints.....	169	d. General methods for determination of stresses in braced and ribbed arches..	256
28. General drawing and estimated weight.....	190	52. Loading conditions for arch trusses.....	259
DETAILED DESIGN OF A STEEL ROOF TRUSS		53. Determination of stresses in a typical three-hinged arch truss.....	260
29. General conditions for the design.....	191	54. Design of members and joints for a typical three-hinged arch.....	266
30. Type and form of truss.....	192	55. Bracing for arch trusses.....	271
31. Loadings.....	193	ORNAMENTAL ROOF TRUSSES	
32. Design of sheathing.....	193	56. Architectural timber work.....	271
33. Design of purlins.....	195	57. Analysis of stresses in a scissors truss.....	274
34. Determination of stresses in members.....	195	58. Analysis of stresses in a hammer-beam truss.....	281
35. Design of members.....	198	59. Analysis of combined trusses... ..	283
36. Design of joints.....	201	60. Typical joint details for ornamental roof trusses.....	284
37. Minor details.....	209		
38. Estimated weight.....	210		
39. Design of top chord for bending and direct stress.....	210		
40. Design of bracing.....	215		
41. The general drawing.....	216		

Section 3. Short Span Steel Bridges

STEEL RAILWAY BRIDGES		ART.	PAGE
1. Choice of type of structure.....	286	a. Dead load.....	289
2. Economical span length.....	287	b. Live load.....	290
3. Loads.....	289	c. Impact.....	291
		d. Lateral forces.....	292

ART.	PAGE	ART.	PAGE
e. Other loads	292	b. Stresses in truss members . . .	328
4. Design of steel railway bridges . .	292	c. Design of members	331
5. I-beam bridges	292	d. Design of floor system	334
a. Design of wooden floor	292	e. Design of riveted joints	337
b. Design of I-beams	293	f. Design of lateral, portal, and sway bracing	337
c. Design of lateral bracing	294	g. Design of end shoe, chord splices, and minor details . .	339
d. Design of sole plates	294	9. Pin-connected truss bridges . . .	342
6. Deck plate girder bridges	295	a. General considerations	342
a. Floors for deck plate girders .	295	b. Design of members	342
b. Design of main girders for deck plate girder bridges . .	295	c. Design of pins	346
c. Length of cover plates	304	d. Attachment of pin plates . . .	351
d. Rivet spacing in flanges	306	e. Lateral bracing, floor system, etc.	357
e. Design of stiffeners	310		
f. Design of lateral bracing	312		
g. Design of cross frames	314		
h. Design of web splices	315		
i. Splices for flange elements . .	320		
j. End bearings	321		
7. Through plate girder bridges . .	323		
a. Floors for through girder bridges	323		
b. Design of a through plate girder span	323		
8. Riveted truss bridges	328		
a. General considerations	328		

STEEL HIGHWAY BRIDGES

10. General considerations	359
11. Loadings	359
a. Dead load	359
b. Live load and impact	359
c. Lateral forces	360
12. Design of a plate girder span . .	361
a. Design of the floor system . .	361
b. Design of the main girders . .	364
13. Riveted low truss highway bridge	368

Section 4. Timber Bridges and Trestles

1. General considerations	372	g. Deteriorating conditions at bridge site	379
2. Factors affecting design and con- struction	373	3. Design of timber bridges	382
a. Materials	376	a. Floors	382
b. Length of life desired	376	b. Trestles	384
c. Nature and extent of loads to be carried	376	c. Connectors	386
d. Skill of available labor	377	d. Truss bridges	387
e. Equipment available for erec- tion	378	4. Details of timber bridges	396
f. Method of erection likely to be followed	378	a. Floor systems	396
		b. Trestles	399
		c. Trusses	401
		d. Timber bridges	404

Section 5. Steel Tanks

VERTICAL CYLINDRICAL TANKS			
1. Tank size	406	8. Overturning due to wind	416
2. Size of plates	407	9. Anchor bolt connections	416
3. Thickness of plates and design- ing of vertical joints	407	10. Manhole	417
4. Design of horizontal joints	413	11. Pipe connections	417
5. Bottom plates	414	12. Tank erection	418
6. Caulking at bottom angle	414	13. Tank roof	419
7. Standard sized tanks	416	14. Rivets used in tank construc- tion	420
		15. Scarfing	420

ART.	PAGE	ART.	PAGE
16. Tank foundations.....	420	25. Tank to post connection.....	429
17. Tank accessories.....	422	26. Tower columns.....	429
ELEVATED TANKS AND TOWERS			
18. Capacity and height of tank...	423	27. Struts.....	430
19. General shape of tank.....	423	28. Tower rods.....	431
20. Tanks of standard size and shape.....	424	29. Elevated tank foundations.....	431
21. Tank bottom.....	424	30. Riser pipe.....	431
22. Balcony girder.....	426	31. Water heaters.....	433
23. Tank roof.....	428	32. Water legs.....	434
24. Number of plates in each shell ring.....	428	33. Tank accessories.....	434
		34. Painting.....	434
		35. Tower and tank erection.....	434
		36. Designing practice.....	434

Section 6. Chimneys

DRAFT AND SIZE OF CHIMNEY

1. General.....	443
2. Draft theory.....	443
3. Draft losses.....	444
4. Available draft.....	445
5. Rates of combustion and draft requirements for different coal fuels.....	447
6. Correction of chimney sizes for altitude.....	448
7. Formulas for height and diameter of chimneys.....	449
8. Chimneys for oil fuels.....	452
9. Chimneys for blast furnace gas.....	453

GENERAL CONSIDERATIONS

10. Forces acting on stack.....	453
11. Wind pressures.....	453
12. Effect of earthquake shocks.....	454
13. Lining.....	455
14. Breech opening.....	455
15. Baffle plates.....	456
16. Clean out doors.....	456
17. Ladder and pulley block.....	456
18. Lightning conductor.....	456
19. Corrosion.....	456
20. Allowable unit stresses.....	456
21. Rivets and rivet spacing.....	457
22. Lap joints.....	458

GUYED STEEL STACKS

23. Classification.....	460
24. General design of guyed steel stacks.....	461

25. Thickness of plates.....	461
26. Weight per foot of guyed steel stacks.....	461
27. Pull on guy wires.....	463
28. Wind moments and reactions for stacks with one set of guys.....	465
29. Wind moments and reactions for stacks with two sets of guys.....	467
30. Wind moments and reactions for stacks with three sets of guys.....	469
31. Unit stress in stack plates due to wind moments.....	470

DESIGN OF A GUYED STEEL STACK

SELF-SUPPORTING STEEL CHIMNEYS

32. Self-supporting steel chimney weights.....	475
33. Conical section at base.....	477
34. Design in general.....	477
35. Method of procedure in design.....	478
36. Design of foundation bolts.....	479
37. Design of base plate.....	482
38. Design of foundations.....	484
39. Foundation design formulas.....	485
40. Erection of self-supporting steel chimneys.....	487
41. The 400-ft. steel chimney at Jerome, Arizona.....	489

DESIGN OF A 265-FOOT SELF-SUPPORTING STEEL CHIMNEY

Section 7. Structural Steel Detailing

Arr.	Page	Arr.	Page
1. Drafting room organization and procedure.....	502	4. Shop detail drawings.....	506
2. Ordering material.....	503	5. Assembling marks.....	507
3. Layouts.....	504	6. Typical detail drawings.....	508

Section 8. Fabrication of Structural Steel

1. Organization of structural companies.....	516	10. Fitting.....	537
2. Bidding on contracts.....	517	11. Riveting.....	538
3. Preparation of shop drawings.....	518	12. Finishing.....	541
4. Shop organization.....	520	13. Assembling of trusses.....	542
5. Temple shop.....	522	14. Inspection.....	544
6. Receiving material.....	523	15. Cleaning, sand blasting, painting, and galvanizing.....	546
7. Laying out.....	525	16. Forge shop.....	547
8. Punching, reaming, and drilling.....	525	17. Machine shop.....	550
9. Shearing, coping, burning, sawing, and various operations.....	534	18. Shipping.....	557
		19. Simplified shop work.....	558

Section 9. Steel Erection

1. Organization of erecting forces.....	564	d. Chains.....	576
2. Falsework.....	565	e. Hooks.....	576
3. Erecting equipment.....	566	f. Miscellaneous.....	576
a. Travelers.....	566	5. Pinning, bolting, and riveting.....	579
b. Steel derrick cars.....	568	6. Methods of erection.....	583
c. Locomotive erecting cranes.....	568	a. Girder spans.....	583
d. Steel derricks.....	569	b. Riveted truss spans.....	584
e. Ginny winks.....	571	c. Pin truss spans.....	585
f. Gin poles.....	571	d. Floating spans into position.....	587
g. Shear legs.....	572	e. Cantilever erection.....	587
4. Erecting tools.....	572	f. Viaducts.....	589
a. Hoists.....	572	g. Office buildings.....	589
b. Blocks.....	572	h. Mill buildings.....	591
c. Rope.....	574	7. Details to facilitate erection.....	597

Section 10. Estimating Steelwork

1. Estimating in general.....	596	5. Estimating procedure.....	597
2. Estimating from plans made by architects.....	596	6. Estimating data.....	600
3. Estimating from plans made by engineers.....	596	a. Estimate sheet and forms... ..	600
4. Qualifications for successful steel estimator.....	597	b. "Taking off".....	600
		7. Cost data.....	610
		8. Selling steel.....	614

Section 11. Materials

CAST IRON			
1. Kinds of cast iron.....	616	4. White iron.....	618
2. Methods of manufacture.....	616	5. Malleable cast iron.....	618
3. Gray iron.....	616	6. Design of castings.....	618

WROUGHT IRON		Art.	Page
Art.			
7.	Wrought iron defined.....		619
8.	Method of manufacture.....		619
9.	Structure of wrought iron.....		619
10.	Physical properties.....		619
11.	Uses of wrought iron.....		619
12.	Ingot iron and copper bearing metal.....		620
STEEL			
13.	In general.....		620
14.	Methods of manufacture.....		621
15.	Carbon steel.....		622
16.	Alloy steel.....		622
17.	Steel castings.....		623
18.	Rolled shapes.....		624
19.	Forgings.....		624
20.	Uniform specifications.....		624
21.	Examination of structural steel.....		624
22.	Metal lumber or structural pressed steel.....		624
TIMBER			
23.	Names.....		626
24.	Definitions.....		627
25.	Hardwoods and soft woods.....		627
26.	Grain.....		627
27.	Non-porous woods.....		627
28.	Ring porous woods.....		628
29.	Defects.....		628
	a. Knots.....		628
	b. Holes.....		628
	c. Checks.....		629
30.	Defects of manufacture, applicable to all timber and lumber.....		631
31.	Weight of wood.....		632
32.	Hardness.....		632
33.	Cleavability.....		633
34.	Calorific value.....		633
35.	Strength.....		633
36.	Strength of treated wood.....		644
37.	Length of life of wood.....		644
38.	Decay of wood.....		645
39.	Destruction of wood by insects.....		645
40.	Destruction of wood by marine animals.....		645
41.	Seasoning of timber.....		646
42.	Preservation of timber.....		646
	a. Brush treatment.....		647
	b. Zinc-chloride treatment or burnettizing process.....		647
	c. Kyanizing or mercuric-chloride treatment.....		648
	d. Creosoting processes.....		648
	e. Card process.....		649
	f. Open-tank treatment.....		649
43.	Dating nails.....		649
44.	Protection of timber against fire.....		649
45.	Timber specifications.....		650
46.	Lumber.....		681
47.	Piling.....		682

Appendix A

GENERAL SPECIFICATIONS FOR STEEL	Floors.....	694
RAILWAY BRIDGES—AMERICAN	Bracing.....	695
RAILWAY ENGINEERING	Plate girders.....	695
ASSOCIATION—1920	Trusses.....	697
EDITION	Viaducts.....	697
Proposals and drawings.....	Materials.....	698
General features of design.....	Workmanship.....	703
Loads.....	Weighing and shipping.....	706
Unit stresses and proportioning of parts.....	Shop painting.....	706
Details of design.....	Mill and shop inspection.....	707
	Full-size tests.....	707

Appendix B

SPECIFICATIONS FOR STEEL RAILWAY BRIDGES—AMERICAN RAILWAY ENGINEERING ASSOCIATION—PARTIAL 1941 EDITION.....	709
---	-----

CONTENTS

Appendix C

	Page
STANDARD SPECIFICATIONS FOR STEEL FOR BRIDGES AND BUILDINGS—AMERICAN SOCIETY FOR TESTING MATERIALS.....	717

Appendix D

STANDARD SPECIFICATIONS FOR STRUCTURAL RIVET STEEL—AMERICAN SOCIETY FOR TESTING MATERIALS.....	723
INDEX.....	725

STEEL AND TIMBER STRUCTURES

SECTION 1, BUILDINGS

STEEL OFFICE BUILDINGS

In this chapter the design and details of steel office buildings are discussed particularly with reference to the types of construction employed in present day practice. The information given is largely descriptive, embracing the subjects of loadings, unit stresses, foundations, retaining walls, floors and floor construction, columns, party walls, wind bracing, spandrels, lintels, cornices, roofs, balcony trusses, skylight construction, towers and interior steel stacks.

1. Classification of Buildings.—A building in a broad sense may be considered as a structure covered with a roof.

For purposes of classification, all buildings may be subdivided into three groups: (1) Office buildings, (2) mill buildings, and (3) miscellaneous buildings. Office buildings have several stories and may be in combination with auditoriums, lobbies, balconies, etc. Mill buildings are in general one story structures devoted to industrial purposes, consisting of one or more aisles, with crane runways, lean-tos, etc. Miscellaneous buildings comprise all buildings not included in the other two classes.

Office buildings as treated in this chapter include apartments, fixed seat auditoriums, movable seat auditoriums, churches, dance halls, drill halls, garages, theaters, hotels, factory buildings, store houses, retail stores, warehouses, office buildings and schools. Occasionally a combination of two of these classes is included under one roof. For example, a theater and offices may be in one building.

The building codes of various cities designate all buildings by classes for purposes of restrictions as to height, size of walls, permissible loadings, fire protection, etc. These classes vary in each city and no attempt will be made to follow any one classification. It is unfortunate that a uniform code is not in vogue for all cities. A standard code would be more intelligible and a big economic advantage to architects, engineers, material men and contractors.

2. Legal Heights.—The restrictions for the heights of office buildings as given in Table 1 were taken from the building codes of a number of large cities. The figures given will serve as a means for comparison only. The designer should

refer to the codes, in any specific case, for the conditions under which the codes apply. No attempt has been made to give all the figures in the table as the heights vary for the different classes of buildings.

TABLE 1.—LEGAL HEIGHTS FOR OFFICE BUILDINGS IN VARIOUS CITIES

	Heights in feet	
	Semifireproof buildings	Fireproof buildings
Chicago (1938).....		264
Dallas (1929).....	75	No limit
Denver (1935).....	65	No restrictions
Detroit (1941).....	60	No limit
Memphis (1930).....	70	150 or 2½ times the street width
Milwaukee (1934).....	85	
New York (1941).....	100 ft. and not more than 9 stories	No limit
Philadelphia (1939).....	85	
Portland (1940).....	85	No limit
Salt Lake City (1940).....	85	No limit
San Francisco (1941).....	84	No limit
Washington (1941).....		Width of street plus 20 ft. 0 in.

3. Design.—Many problems confront the engineer. Each in turn must be solved from the standpoint of economy based on good engineering judgment. Many considerations—such as keeping the cost within the appropriation, early deliveries of materials, simplicity of fabrication, strength of the structure, conformity to the building code and easy erection of the steel—must be used as the basis of his judgment.

The architects having submitted their design, the engineer must design his steel to meet their requirements, though this may at times involve complexity of details which are not desirable as far as the steel is concerned.

The engineer must decide upon the type of foundations and be governed by existing practice and greatest durability. He wisely will design the foundation for the greatest strength and least settlement without regard to the cost, preferring to practice economy on less important details in the superstructure.

Opinions will vary among engineers regarding the use of steel or reinforced concrete for the framework of the building. For equal strength, the construction with the minimum cost will govern. For certain classes of structures, reinforced concrete will be cheapest and most satisfactory, for others, the use of steel is best. For example, structures of low heights and requiring little wind bracing may to advantage be made of reinforced concrete; whereas, tall buildings, those requiring rigidity, slenderness of columns, etc., are logically made of steel. A combination of the two materials is often advisable. For retaining walls, heavy floor construction, etc., concrete as a covering for steel gives fire protection and in a great many ways adapts itself for the purpose intended.

Concrete or reinforced concrete is probably our most useful building material, being ideal for so many varied uses, but it should not invade the field so well served by steel. As steel and reinforced concrete have been used for a number of years, weak constructions of these materials are becoming better known each year. The result is that our designs are showing greater improvement and steel and reinforced concrete are being used for the purposes for which they are best adapted.

Rigidity in a design is of next importance to the foundations. Therefore, the wind and wind-resisting stresses should be carefully computed. The overturning and resisting moments should be calculated for conditions during erection as well as for the finished building.

The columns and frame work should be designed to fully conform to the building code for loads, dead weight, wind stresses and unit stresses. No reductions whatever should be permitted below those calculated.

It is false economy to hold the thicknesses of the plates and sections to a minimum, impairing the strength of the structure. It is true economy to design liberally the sections of columns, beams, connection plates and angles, but avoid details which add to the cost of the terra cotta manufacturer, the stone cutter, steel fabricator and erector. Also the steel should be designed to secure as much duplication of individual pieces of steel as possible; where so designed it will be found that there is greater duplication of terra cotta, stone, window frames, etc. The larger duplication will enhance the delivery of materials to the building site and greatly expedite the erection of the steel, stone and terra cotta.

The delivery of steel from the rolling mills is generally very important as most buildings must be erected within a specified time because of leaseholds and outstanding capital invested in the building. To secure the quickest deliveries from the mills, the designer should avoid using small quantities of special sizes of angles and shapes—in other words, there should be as few sizes of angles and shapes as possible consistent with good design. A little weight will be added to do this but the final results of quicker deliveries, cheaper fabrication and erection will justify the extra steel. It should be remembered that the cost of steel averages about one-fifteenth of the total cost of the completed average steel building. An increase of 2 per cent to the weight of the steel amounts to less than $\frac{1}{10}$ of 1 per cent of the cost of the building.

The design drawings should be made to a scale sufficiently large to clearly and accurately show all framing plans, elevations, sections and details. The design should be complete in showing the location of all members in plan and elevation. A well drawn design saves a great deal of time in ordering the various materials, avoids errors and in general expedites the work. It is economy for all the trades to work from a good set of design plans.

4. Minimum Floor Loads.—The minimum floor loads permissible in pounds per square foot for a number of cities are given in Table 2. The various classifications will apply to all structures which are defined as office buildings in Art. 1.

5. Unit Stresses.—The unit stresses allowed on steel for a number of cities are given in Table 3. These figures are given for comparison only. The designer is referred in any specific case to the building codes for the conditions under which the unit stresses apply.

TABLE 2.—MINIMUM LIVE LOADS FOR BUILDINGS¹
(Pounds per Square Foot)

Types of buildings	Chicago	Dallas	Denver	Detroit	Memphis	Milwaukee	New York	Philadelphia	Salt Lake City	San Francisco	Washington
	(1938)	(1929)	(1935)	(1941)	(1930)	(1934)	(1941)	(1939)	(1940)	(1941)	(1941)
Apartments.....	40	40	40	40	40	40	40	40	40	40	40
"Fixed" seat auditoriums.....	75	60	50	80	100	70	75	100	50	75	70
"Movable" seat auditoriums.....	100	100	100	100	100	100	100	100	100	125	100
Churches.....	100	80	...	100	70	70	100	60	70
Dance halls.....	100	100	120	125	100	100	100	100	100	125	100
Drill halls.....	100	100	150	125	100	100	100	100	100	125	100
Factory buildings.....	100	...	150	125	150	100	120	150	125	125	100
Garages.....	100	80	100	150	70	100	75	100	100	100	80
Hotels.....	40	40	40	40	40	40	40	40	40	...	70
Office buildings.....	50	50	50	50	50	50	50	60	100
Retail stores.....	100	75	75	100	100	100	75	110	75	100	100
Schools.....	75	75	100	80	70	50	60	50	40	75	40
Storehouses.....	100	...	125	125	140	100	120	110	125	250	150
Theaters.....	100	150	100	90	100	70	100	100	100	75	70
Warehouses.....	100	...	250	150	150	100	120	200	250	250	250

¹ Where two loadings are given, the larger loading applies to the first floor and the smaller loading to all floors above the first floor.

TABLE 3.—UNIT STRESS ALLOWED ON STEEL BY VARIOUS CITIES
(Thousands of Pounds per Square Inch)

Tension (net).....	Chicago (1938)	Dallas (1929)	Denver (1935)	Detroit (1941)	Memphis (1930)	Milwaukee (1934)	New York (1941)	Philadelphia (1939)	Portland (1940)	Salt Lake City (1940)	San Francisco (1941)	Washington (1941)
Compression (gross).....	18	18	18	18	18	18	18	18	18	20	20	20
Bending on extreme fibers.....	18	18	18	15	18	18	18	18	18	20	18	20
Bending on pins.....	27	27	27	27	27	27	24	30	27	30
Bending on riveted girders, net flange.....	20	18	18	18	18	20
Bearing on shop rivets.....	32	24	24	24	24	24	24	24	24	32	24	32
Bearing on field rivets.....	16	16	16	16	16	16	24	..	16	..
Bearing on pins.....	32	24	24	24	24	24	24	24	30	32	24	32
Bearing on bolts.....	20	12	16	14	16	16	16	16	12	20	16	..
Shear on girder webs.....	12	13
Shear on gross section.....	13	12	12	12	12	12	12	12	13	12	13
Shear on shapes.....	12	12	13	13
Shear on shop rivets.....	13.5	13.5	13.5	13.5	13.5	13.5	13.5	13.5	12.5	15	13.5	15
Shear on field rivets.....	10	10	10	10	10	10	10	12.5	..	10	15
Shear on pins.....	13.5	13.5	13.5	13.5	13.5	13.5	13.5	13.5	12.5	15	13.5	15
Shear on bolts.....	10	7.5	10	8	10	10	10	10	9	10	10	10

6. Foundations.

6a. Bearing Capacity of Soils.—The allowable bearing capacity of soils in various building codes is given in Table 4.

TABLE 4.—ALLOWABLE BEARING CAPACITY OF SOILS IN VARIOUS CITIES
(Thousands of Pounds per Square Foot)

Type of soil	Chicago (1938)	Dallas (1929)	Denver (1935)	Detroit (1941)	Memphis (1930)	Milwaukee (1934)	New York (1941)	Philadelphia (1939)	Portland (1940)	Salt Lake City (1940)	San Francisco (1941)	Washington (1941)
Quicksand or alluvial soil.....	1.0	1.0	3.0	1.0	1.0
Loam, firm and dry.....	2.0	2.0	6.0
Clay, soft.....	3.5	2.0	2.0	2.0	2.0	2.0	2.0	2.0	2.0	2.0	2.0-4.0
Clay, firm and springy.....	4.5	6.0	6.0	4.0	4.0	4.0	4.0	4.0	6.0	6.0	6.0	6.0
Clay, hard.....	8.0	8.0	8.0	6.0	6.0	6.0	8.0	8.0	8.0	8.0	8.0
Sand, firm and dry.....	6.0	8.0	8.0	6.0	4.0	6.0	6.0	8.0	8.0	8.0	6.0	6.0
Sand, compact and well cemented.....	8.0	8.0	8.0	8.0	16.0	12.0	8.0	8.0
Sand and clay.....	3.0	4.0	4.0	4.0	8.0	4.0	4.0	4.0	6.0
Gravel.....	10.0	12.0	8.0	12.0	12.0	12.0	8.0
Gravel and coarse sand, well cemented..	12.0	12.0	16.0	10.0	16.0	16.0	12.0	8.0
Hard pan.....	12.0	20.0	12.0	20.0	16.0	8.0
Shale.....	12.0	16.0
Rock.....	200.0	*	40.0	80.0	96.0	32.0	*	20.0	60.0

* 20 per cent of ultimate crushing strength of the rock.

6b. Caissons.—There are different kinds of foundations used, depending upon the nature of the soil, magnitude of the loads on the columns, proximity to other foundations and the requirements of the building ordinances used in the design.

The most effective foundation is the kind whereby the column load is carried down to a concrete caisson directly to the bed rock or hard pan. The column loads are distributed to the caisson by means of a grillage, as in Fig. 1, or by a casting, as in Fig. 2. Occasionally the tops of the caissons are reinforced with

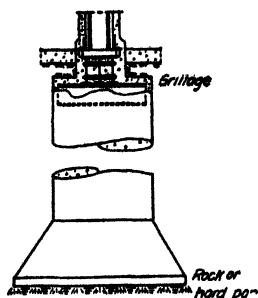

FIG. 1.—Caisson with grillage.

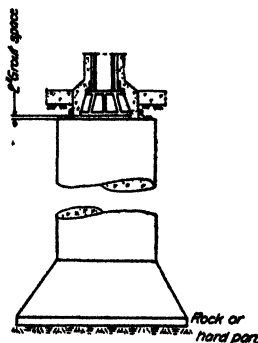

FIG. 2.—Caisson with casting.

hoops or rods. The size of the caissons will vary with the loads transmitted to them, possibly from 3 to 12 ft. in diameter. The holes for the piers are excavated by the open well process. Matched timbers with dimensions of about 3 × 6 in. and lengths of 4 or 6 ft. are placed around the well vertically and braced by circular steel bands set inside of the uprights. The timbers shore up the earth work but are removed one section at a time as the placing of the concrete progresses. The concreting is carried on continuously for the entire height and the top levelled for the grillage and castings. If it is desired to secure a larger bearing area on the rock or hard pan, it is easily done by undercutting the excavation at the base of the pier.

In constructing caissons of the Chicago Temple Building at Washington and Clark Streets, Chicago, the excavations were carried down to a level about 110 ft. below street level before rock was reached. Drillings 8 ft. deep were made in the rock before the engineers were satisfied that the rock was bed rock, capable of carrying the heavy loads of a 20-story building.

6c. Pile Foundations.—When the hard pan or bed rock is too far below the grade or if borings do not reveal any rock or hard pan, the caisson foundation cannot be used and other methods of foundation must be resorted to for the support of the column loads. Three other kinds of foundations are possible, depending upon the nature of the soil and the loads to be sustained: (1) Concrete piers supported on piles, (2) layers of timber spread to distribute the pressure, and (3) concrete piers resting directly on the soil. Figure 3 shows a concrete pier carried by piles which are designed of sufficient number and length to safely support the column load.

6d. Floating Foundations.—Floating foundations consist of layers of timbers which are spaced and spread to secure the required bearing pressure on

the soil. The bearing areas on the soil for the different columns are carefully proportioned to provide equal settlement throughout the entire structure (see Fig. 4).

6e. Footings.—A footing for carrying light loads is shown in Fig. 5. The concrete is either reinforced or plain depending upon the magnitude of the load and the size of the bearing required.

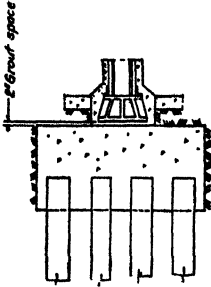

FIG. 3.—Concrete pier resting on piles.

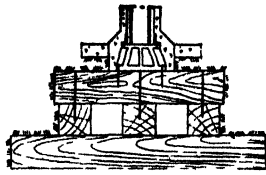

FIG. 4.—Floating foundation.

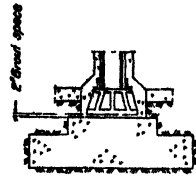

FIG. 5.—Column footing.

6f. Party Piers.—Sometimes the piers for the columns on the property lines are located with their centers on the lot line and carry the columns for the party wall of the two adjoining buildings or they may serve as piers for two walls placed side by side. In the latter case, the grillage and cast bases are independent for each structure.

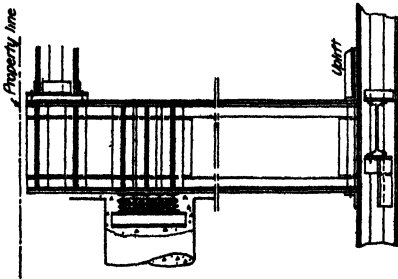

FIG. 6.—Cantilever construction.

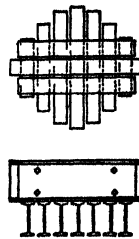

FIG. 7.—Grillage beams.

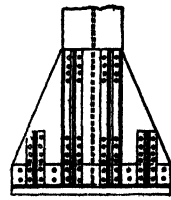

FIG. 8.—Built-up column base.

6g. Cantilever Foundations.—Frequently the piers at the property line must be placed entirely within the lot line and cantilever supports used for the columns. A cantilever girder is placed on two piers and the column to be supported rests on the end of the cantilever girder. When the column load is large, the design of the girder is quite a problem. Sufficient bearing area must be provided for the direct load and the girder carefully designed for bending and shear (see Fig. 6).

6h. Grillage Beams.—Grillage beams are used to distribute the bearing from the columns to the piers. I-beams are generally used but for very large column loads, built-up girders are necessary.

Sometimes stiffeners are fitted between the flanges of the I-beams to secure greater bearing area but due to the uncertainty of not getting a good contact between the bevelled ends and the flanges, it is preferable to use webs of greater thickness. A typical design for grillage beams is shown in Fig. 7. The illustration shows the beams cut to conform to the circular shape of the pier; they are also designed square in plan.

6i. Slabs.—The use of slabs instead of cast bases or built-up bases on columns offers a simple solution for distributing loads to the cantilever girders or grillage. A design of a slab is shown in Fig. 1, p. 7, and is more simple and

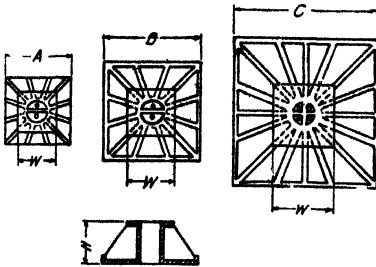

FIG. 9.—Cast-iron column bases.

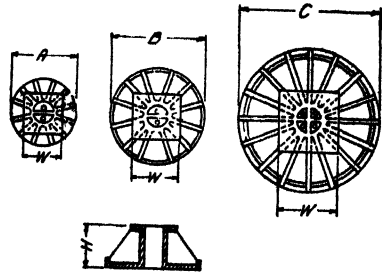

FIG. 10.—Cast-iron column bases.

economical than the built-up base illustrated in Fig. 8. The variety of slabs should be limited to facilitate rolling, fabrication and erection.

6j. Cast-iron Bases.—Cast-iron bases of standard types only should be used and with as few variations in size as possible. Generally it is not necessary to use more than three, four or five sizes on any one structure. Well-designed bases which have been extensively used are shown in Figs. 9 and 10, the former being square and the latter circular in plan.

The dimensions for these bases will vary as follows:

(All in Feet and Inches)

A	H	W	B	H	W	C	H	W
2-0	9	1-6	3-0	1-3	1-9	5-0	2-3	2-5
2-3	9	1-6	3-3	1-3	1-9	5-3	2-3	2-5
2-6	9	1-8	3-6	1-3	2-1	5-6	2-3	2-5
2-9	1-3	1-8	3-9	1-3	2-1	5-9	2-9	2-5
			4-0	1-9	2-1	6-0	2-9	2-5
			4-3	1-9	2-3			
			4-6	1-9	2-3			
			4-9	1-9	2-3*			

7. Retaining Walls.

7a. Different Types.—Retaining walls are required when the building contains area ways or one or more basements. The common method of constructing retaining walls is to set I-beams, sheet piling shapes or special sections in a vertical position and encase in concrete. The design of a retaining

wall reinforced with I-beams is shown in Fig. 11. When this kind of retaining wall is used, it is necessary to bolt or rivet the connections.

Another type of retaining wall consists of steel sheet piling in combination with I-beams. This type is used for high retaining walls. Such construction is well adapted for designs where basements and sub-basements are required. The steel construction is encased in concrete (see Fig. 12).

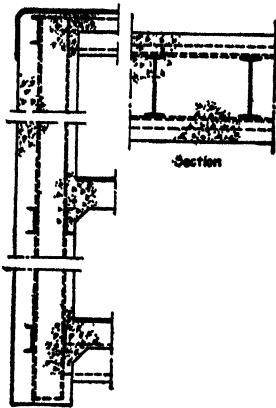

FIG. 11.—I-beam retaining wall.

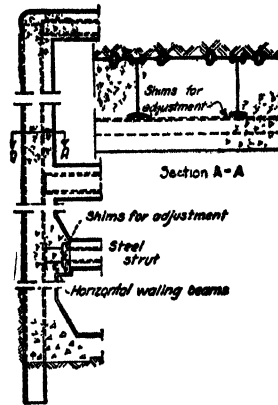

FIG. 12.—Steel sheet piling retaining wall.

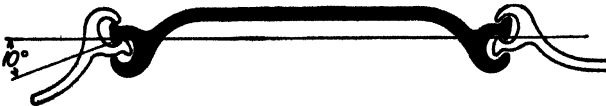

FIG. 13.—Carnegie steel sheet piling (Carnegie-Illinois Steel Corp.).

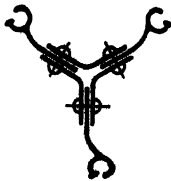

FIG. 14.—Standard fabricated Y steel sheet piling.



FIG. 15.—Standard fabricated Tee steel sheet piling.

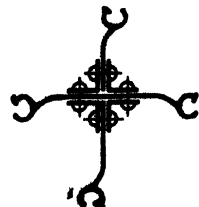

FIG. 16.—Standard fabricated Cross steel sheet piling.

Different steel shapes have been designed for retaining walls and cofferdam work. They are erected without any riveting or bolting and have the advantage that they can be driven before excavating has begun, thus preventing the caving in of the soil.

Figure 13 illustrates the Carnegie-Illinois Steel Corp. piling made up of a specially rolled shape with one ball flange to lock the shapes together. Similar piling is made by Bethlehem Steel Corp., Weirton Steel Co., and Inland Steel Co. Figures 14, 15, and 16 show a standard fabricated "Y," Tee, and Cross, steel sheet piling, respectively.

7b. Sub-basement Construction.—It is quite common in designing large buildings to provide for one, two, three or more basements. Additional space is thus provided for additional salesrooms in department stores, storage space, boiler rooms, bank vaults, restaurants, etc. The use of basements and sub-basements largely increases the floor space in the buildings as the heights of the structures are fixed by city ordinances.

High retaining walls are constructed for the basements and sub-basements. They may be built of reinforced concrete or a combination of structural shapes and concrete. The latter method is usually employed. The retaining walls are designed as vertical slabs supported at the floor levels. The pressure of the soil is carried across the floors and is balanced by the pressure from the opposite side. The stresses are carried across the building through the heavy concrete floor construction or by steel struts placed between the columns.

These struts require special details at the columns in order that the thrust may be properly transmitted and adjustment made to fit the retaining walls. The thrust is taken care of by providing sufficient bearing area on the columns and ends of the struts. Adjustment is secured by the use of shims between the milled ends of the struts and the bearing areas on the columns.

Two types of retaining walls for sub-basement construction are shown in Figs. 11 and 12. The thrust bearings at the columns are illustrated in Fig. 17.

In the construction of the wall shown in Fig. 11, the excavation for the wall is made first. The temporary lagging to retain the earth is placed as the excavating proceeds. The beams are then placed in one or more lengths and are not finally braced until the basement floors are constructed. The beams are finally encased in concrete which acts as diaphragms between the beams, the steel beams taking the entire bending.

In the construction of the wall shown in Fig. 12, the sheet piling and the connected beams are driven first. The sheet piling retains the earth and requires no temporary lagging. During the driving, the piling will move considerably from its original position so that measurements for the length of the struts must be taken after the piling is driven.

The wall illustrated in Fig. 11 is preferable in many ways as accurate alignment may be obtained without resorting to the final field measurements with its consequent delays. The wall shown in Fig. 12 will drive very irregularly and requires the liberal use of shims in order that the various members may take their proper share of the loading.

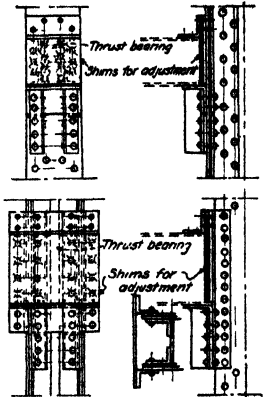

FIG. 17.—Typical connections for basement struts to columns.

In the construction of the various basements, the retaining walls are erected first. If sheet piling is used for the retaining walls, the sheet piling is driven before the basements are excavated. After the piers are poured and the lower tiers of columns set, sufficient material is excavated to erect the first floor framing. After the first floor is riveted to the columns and retaining walls, the excavating proceeds to the next lower floor. The framing for this lower floor is then erected and the retaining wall braced to this depth. This process is continued until the final basement floor is completed. The construction of the basements and sub-basements is carried on simultaneously with the erection of the upper stories of the building.

In Chicago there is a subway tunnel under the principal streets of the downtown district at an elevation about 50 ft. below street level. During the construction of many of the large buildings located on streets having the tunnel, the excavated material for the piers and basements and refuse is removed through the tunnel. An outlet to the tunnel is made in the third basement under the first floor.

8. Floors and Floor Construction.

8a. Floor Construction Requirements.—Before reaching a decision in regard to the type of floor to be used, several kinds should be investigated to secure sufficient strength, stiffness, durability, fireproofness desired, light weight, shallow depth and minimum cost. It is important in the construction of modern buildings that the dead weight and the depth of floor be reduced to a minimum consistent with good construction and cost. There are several types available to the designer and undoubtedly one of them will be best for the conditions.

The partitions of office buildings are often re-arranged to suit different tenants and the floor, therefore, should be designed to carry a partition in any position. This requirement can be taken care of by adding from 10 to 25 lb. per sq. ft. to the dead load of the floor.

The type of floor, too, is often influenced by the spacing of the columns, inasmuch as the long span lengths between columns may require special framing and arrangement of the beams. If flat ceilings are wanted, as is usually the case, the framing must be designed to avoid having any beams projecting below the ceiling level. The deeper beams are generally avoided by using double beams held together with separators.

8b. Standard vs. Wide-flange Shapes.—For framing the floor construction, standard-shaped beams and wide-flange beams are available. The sizes, weights and properties are given in handbooks published by the rolling mills; but for means of comparison, the sizes and weights of the standard and wide-flange beams are given herewith.

The standard I-beam and channel sections have the following depths and weights:

Beams.

24 in.	—120.0, 115.0, 110.0, 105.9, 100.0, 95.0, 90.0, 85.0, 79.9 lb. per ft.
20 in.	—100.0, 95.0, 90.0, 85.0, 81.4, 75.0, 70.0, 65.4 lb. per ft.
18 in.	—70.0, 65.0, 60.0, 54.7 lb. per ft.
15 in.	—75.0, 70.0, 65.0, 60.8, 55.0, 50.0, 45.0, 42.9 lb. per ft.
12 in.	—55.0, 50.0, 45.0, 40.8, 35.0, 31.8 lb. per ft.
10 in.	—40.0, 35.0, 30.0, 25.4 lb. per ft.
8 in.	—25.5, 23.0, 20.5, 18.4 lb. per ft.

- 7 in.—20.0, 17.5, 15.3 lb. per ft.
- 6 in.—17.25, 14.75, 12.5 lb. per ft.
- 5 in.—14.75, 12.25, 10.0 lb. per ft.
- 4 in.—10.5, 9.5, 8.5, 7.7 lb. per ft.
- 3 in.—7.5, 6.5, 5.7 lb. per ft.

Mill Beams.

- 15 in.—36.0, 33.0 lb. per ft.
- 14 in.—34.0, 30.0 lb. per ft.
- 12 in.—28.0, 25.0 lb. per ft.
- 10 in.—23.0, 21.0 lb. per ft.
- 8 in.—21.0, 19.0, 17.0 lb. per ft.
- 7 in.—12.0 lb. per ft.
- 6 in.—10.0 lb. per ft.

Channels.

- 18 in.—58.0, 51.9, 45.8, 42.7 lb. per ft.
- 15 in.—55.0, 50.0, 45.0, 40.0, 35.0, 33.9 lb. per ft.
- 12 in.—40.0, 35.0, 30.0, 25.0, 20.7 lb. per ft.
- 10 in.—35.0, 30.0, 25.0, 20.0, 15.3 lb. per ft.
- 9 in.—25.0, 20.0, 15.0, 13.4 lb. per ft.
- 8 in.—21.25, 18.75, 16.25, 13.75, 11.5 lb. per ft.
- 7 in.—19.75, 17.25, 14.75, 12.25, 9.8 lb. per ft.
- 6 in.—15.5, 13.0, 10.5, 8.2 lb. per ft.
- 5 in.—11.5, 9.0, 6.7 lb. per ft.
- 4 in.—7.25, 6.25, 5.4 lb. per ft.
- 3 in.—6.0, 5.0, 4.1 lb. per ft.

The wide-flange beams have the following depths and weights:

- 36 in.—300.0, 280.0, 260.0, 250.0, 240.0, 230.0, 194.0, 182.0, 170.0, 160.0, 150.0 lb. per ft.
- 33 in.—240.0, 220.0, 210.0, 200.0, 152.0, 141.0, 132.0, 125.0 lb. per ft.
- 30 in.—210.0, 200.0, 190.0, 180.0, 172.0, 132.0, 124.0, 116.0, 108.0 lb. per ft.
- 27 in.—177.0, 163.0, 154.0, 145.0, 114.0, 106.0, 98.0, 91.0 lb. per ft.
- 24.25 in.—160.0, 150.0, 140.0, 130.0 lb. per ft.
- 24 in.—120.0, 110.0, 100.0, 94.0, 87.0, 80.0, 74.0 lb. per ft.
- 21 in.—142.0, 132.0, 122.0, 112.0, 103.0, 96.0, 89.0, 82.0, 73.0, 68.0, 63.0, 59.0 lb. per ft.
- 18.16 in.—124.0, 114.0, 105.0, 96.0 lb. per ft.
- 18 in.—85.0, 77.0, 70.0, 64.0, 55.0, 50.0, 47.0 lb. per ft.
- 16.16 in.—114.0, 105.0, 96.0, 88.0 lb. per ft.
- 16 in.—78.0, 71.0, 64.0, 58.0, 50.0, 45.0, 40.0, 36.0 lb. per ft.
- 14.75 in.—426.0, 412.0, 398.0, 384.0, 370.0, 356.0, 342.0, 328.0, 314.0, 300.0, 287.0, 273.0, 264.0, 255.0, 246.0, 237.0, 228.0, 219.0, 211.0, 202.0, 193.0, 184.0, 176.0, 167.0, 158.0, 150.0, 142.0 lb. per ft.
- 14 in.—136.0, 127.0, 119.0, 111.0, 103.0, 95.0, 87.0, 82.0, 38.0, 34.0, 30.0 lb. per ft.
- 14.06 in.—84.0, 78.0 lb. per ft.
- 13.91 in.—74.0, 68.0, 61.0 lb. per ft.
- 13.68 in.—58.0, 53.0, 48.0, 43.0 lb. per ft.
- 12.12 in.—190.0, 176.0, 161.0, 147.0, 133.0, 120.0, 106.0, 99.0, 92.0, 85.0, 79.0, 72.0, 65.0 lb. per ft.
- 12.06 in.—64.0, 58.0, 53.0 lb. per ft.
- 11.94 in.—50.0, 45.0, 40.0 lb. per ft.
- 12 in.—36.0, 32.0, 28.0, 25.0 lb. per ft.
- 10 in.—136.0, 124.0, 112.0, 100.0, 89.0, 77.0, 72.0, 66.0, 60.0, 54.0, 49.0, 45.0, 41.0, 37.0, 33.0, 29.0, 26.0, 23.0, 21.0 lb. per ft.
- 8 in.—67.0, 58.0, 48.0, 40.0, 35.0, 33.0, 31.0, 21.0, 19.0, 17.0 lb. per ft.
- 7.98 in.—27.0, 24.0 lb. per ft.

Light Beams.

12 in.—	22.0,	19.0,	16.5 lb. per ft.
10 in.—	19.0,	17.0,	15.0 lb. per ft.
8 in.—	15.0,	13.0 lb. per ft.	
6 in.—	16.0,	12.0 lb. per ft.	

The choice between the standard and wide-flange shapes will depend upon a comparison of cost and deliveries for each specific structure. Often the decision will be made in favor of the one offering quicker deliveries regardless of a reasonable difference in cost.

The cost per pound of the fabricated material is governed by the cost of the raw material, freight from the rolling mill to the fabricating plant, cost of shop work, and freight from the fabricating plant to the building site. The wide-flange shapes have less weight than the standard shapes for the same strength, and they require less handling, punching and riveting than the equivalent built-up standard



FIG. 18 — Flat tile arch

shapes, but, on the other hand, these shapes require drilling through heavy webs and flanges. All of the material in the standard shapes and built-up girders is punched. The comparison given will apply also to wide-flange columns and standard built-up columns.



FIG. 19.—Segmental terra cotta arch.

8c. Types of Floors.—Common types of floors will be illustrated without any attempt to recommend any particular kind. Any one of these types may be best suited for the conditions of the design.

The flat tile arch floor is of light weight and easy to place. Terra cotta tile arch sections are cemented together between the beams. Wooden supports are suspended from the top of the beam to hold up the tile until the key arch tiles are placed and the cement has set. The steel I-beams are entirely covered to fire-proof them. On top of the tile arches, a layer of concrete is placed in which furring strips are imbedded for attaching the finished floor. The thrust of the tile arches is carried by tie rods through the webs of the beams and spaced about 6 or 7 ft. apart (see Fig. 18).

Another kind of floor construction using terra cotta as the basic material is the segmental terra cotta arch shown in Fig. 19. This type of floor construction has less weight than the flat arch type but is limited to such floors as do not require flat ceilings.

Floors of the type shown in Fig. 20 are used to considerable extent. In this type of floor the steel is entirely encased in concrete for fireproofing. Forms for pouring the concrete are required. When a flat ceiling is necessary, wire lath is suspended from the I-beams on which the ceiling plaster is applied.

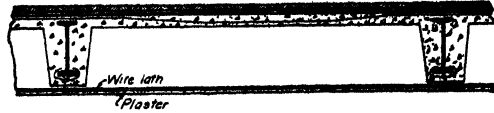

FIG. 20.—Reinforced concrete slab.

A modification of the above type of floor employs cast concrete joists between the steel joists, as shown in Fig. 21.

Various methods have been devised to construct the floors without the use of forms. Figure 22 shows one of these types in which wire mesh or expanded metal

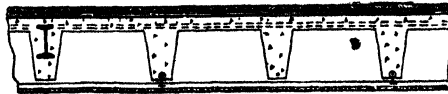

FIG. 21—Concrete joist type

takes the place of the forms and also serves as reinforcement for the concrete. Another method for self-centering which is not used to any extent at the present time is shown in Fig. 23 where corrugated steel shapes are used in the form of an arch. This type has the objections that the corrugated steel corrodes quickly and the bottom flanges of the supporting I-beams are not covered.

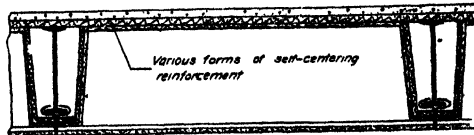

FIG. 22.—Concrete slab on self centering.

Figure 24 shows a type of floor construction with reinforced slabs cast on top of the I-beams. The top of the slabs may be cemented to receive any kind of finished floor desired. The I-beams are shown without any fireproofing. A number of the building codes consider the I-beams fireproofed if a metal lath suspended ceiling is used.

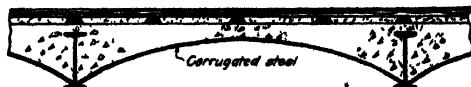

FIG. 23.—Corrugated steel arch formers.

A floor applicable for driveways into stations, hotels, etc., or for warehouse floors, is shown in Fig. 25. Steel plates, riveted to the top flanges of the I-beam supports are covered with reinforced concrete which is the supporting material of the floor. Any surfacing desired to withstand the wear of the traffic, as asphalt, cement, creosoted blocks or paving brick, is laid on top of the concrete.

For floors of slow burning construction, wooden joists supported on I-beams are often used. This kind of floor construction is sometimes used for churches, halls, apartment buildings and small warehouses (see Fig. 26). If a ceiling is

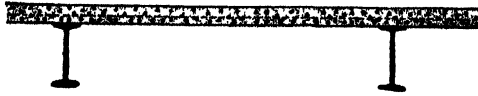

FIG. 24.—Slab floor construction

desired, wire lath is suspended to the bottom flanges of the I-beams, or wooden lath is nailed directly to the joists and the bottom flanges of the I-beams boxed in.

Floors of patented construction are on the market. Many advantages are claimed by their inventors. One of these types employs the use of specially

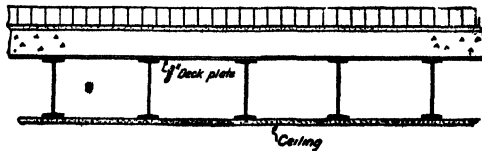

FIG. 25.—Driveway floor construction.

designed sections called "steel lumber sections." Joists of these sections are intended to take the place of timber joists or I-beams. The sections are made up of plates of uniform thickness which have been formed into channel

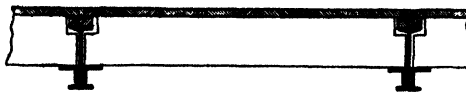

FIG. 26.—Timber joists.



FIG. 27.—Steel lumber joist.

sections. Two of these channels are fastened together to complete the "steel lumber joist" (see Fig. 27). The Jones and Laughlin Steel Corporation rolls junior beams of the following sizes and weights per foot:

Junior Beams.
12 in.—11.8 lb.
11 in.—10.3 lb.
10 in.—9.0 lb.
9 in.—7.5 lb.

Junior Beams.
8 in.—6.5 lb.
7 in.—5.5 lb.
6 in.—4.4 lb.

Other sections are made for studs, partitions, etc. Many accessories as fastenings, separators, bridging, etc., are furnished. The steel lumber joists are generally used in combination with other materials.

3d. Beam Framing.—The type of floor having been decided upon, the next consideration is the arrangement and spacing of the beams. The location of openings, spacing of columns, depth of floor, etc., are important factors in designing the floor framing. The best design is determined by a trial and estimates of different arrangements as it is not possible to make a set of rules for this

purpose. The size of the sub-panels will be fixed by the economical span of the type of floor construction used. For terra cotta arches, the usual span is 5 to 6 ft. For reinforced concrete slabs, the span will be larger, possibly up to 15 or 20 ft. For concrete joist construction, the intermediate panels of steel beams are omitted and the main panels between column centers may be as large as 25 to 30 ft.

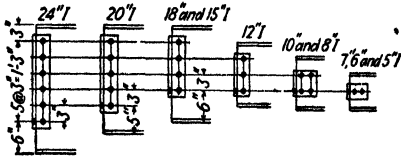

FIG. 28.—Framing of various-size beams.

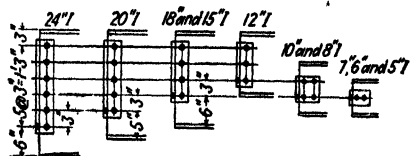

FIG. 29.—Framing of various-size beams.

For large areas of floor surface, the arrangement of beams may be influenced by the advisability of making the framing beams continuous throughout the various panels. Also, where there are beams and girders in a panel, the girder is placed in the short direction to limit its depth and the beams in the long direction spaced at the proper distances center to center to transmit the loads. Then again, it should be the aim of the designer to place the girders in the short direction of the building to secure stiffness for wind bracing. It is economy to make as many panels identical as possible in order to secure greater duplication in the fabrication of steel, forms, terra cotta and stone. Skew framing, of course, should be avoided wherever possible.

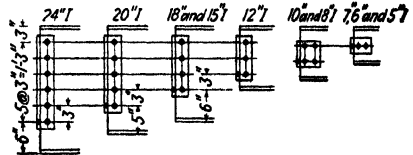

FIG. 30.—Framing of various-size beams.

Beams framing into beams are connected generally by two connection angles at each end. The one angle connection is used only when the space available will not permit two angles. When the type of floor will permit, the shallower

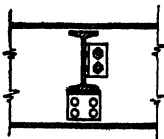

FIG. 31.—Framing into deep beams.

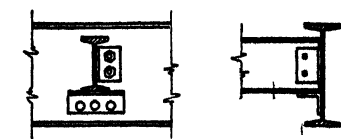
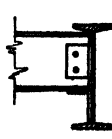

FIG. 32.—Framing into deep beams.

beams should be set down below the top of the deeper beams to avoid coping or "blocking out" of the beams. By observing simplified details in the design, the fabricating costs and erection costs are reduced, resulting in a less cost for the completed building. Figure 28 shows the framing of standard I-beams designed with the 24, 20, 18 and 15-in. beams flush on top, and the 12-in. and smaller sizes flush on the bottom. Figure 29 shows the framing designed with beams 12 in. and over flush on top, and the 10-in. and smaller sizes flush on the bottom. In Fig. 30, all the sizes of beams are designed to be flush on top. The relative elevation of the different sizes of beams is determined from the type of floor construction used.

When a shallow beam frames into a deep beam, the shallow beam should preferably rest on a seat angle and have a side connection angle. Such a connection is an advantage to the erector as the seat angle acts as an erection seat and thus facilitates erection. This is especially true when two beams frame

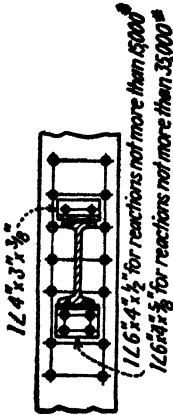

FIG. 33.—Standard connections beams to columns for 15-, 12-, 10-, 9-, 8-, 7-, and 6-in. I-beams with reactions not more than 35,000 lb.

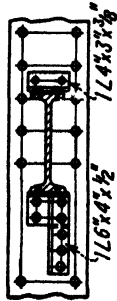

FIG. 34.—Standard connections beams to columns showing one stiffener.

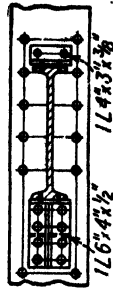

FIG. 35.—Standard connections beams to columns showing two stiffeners.

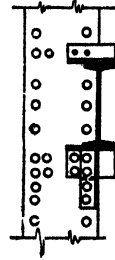

FIG. 36.—Connection to flange of column.

opposite to each other and have a common connection. Also the smaller beams become plain punched beams without riveted connection angles and therefore take a lower classification at a lower unit cost. A few connections of this kind are shown in Figs. 31 and 32.

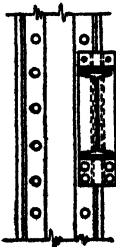

FIG. 37.—Connection to web of column.

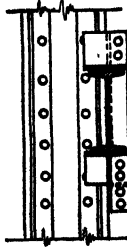

FIG. 38.—Connection to web of column.

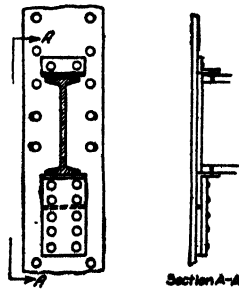
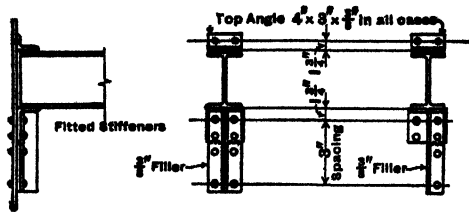

FIG. 39.—Connection with stiffening plate.

The usual types of beam connections to columns are those having top and bottom seat angles. With this kind of connection, the erection is facilitated as the beams are laid on the seat angles, the ends of the beams are ordered short to provide adjustment in the distance from column to column and there are but six field rivets to drive at each end. The standard beam connections to columns are

TABLE 5.—STIFFENED BEAM SEATS¹



Rivet diameter (in.)	Single shear one rivet	No. of rivets in one row	Size of seat angle	Stiffener angles			Capacity of rivet group in kips		Weight of connection (lb.)	
				Size outstanding leg listed first	Bearing value of two angles in kips	Gage of angle	Two stiff.	One stiff.	Two stiff.	One stiff.
1/4	6.63	3	6 x 4 x 3/8	3 1/2 x 3 x 3/16	57	1 3/4	40	..	29	
		4	6 x 4 x 3/8	3 1/2 x 3 x 3/16	51	1 3/4	53	..	35	
		4	6 x 4 x 3/8	3 1/2 x 4 x 3/16	51	2 1/2	38	..	42	
		4	6 x 4 x 3/8	3 1/2 x 5 x 3/16	51	3 1/2	31	..	48	
		5	6 x 4 x 3/8	3 1/2 x 3 x 7/16	71	1 3/4	66	..	47	
		5	6 x 4 x 3/8	3 1/2 x 4 x 7/16	51	2 1/2	51	..	49	
		5	6 x 4 x 3/8	3 1/2 x 5 x 7/16	51	3 1/2	43	..	56	
		6	6 x 4 x 3/8	3 1/2 x 3 x 1/2	81	1 3/4	80	40	59	37
		6	6 x 4 x 3/8	3 1/2 x 4 x 1/2	71	2 1/2	65	..	66	
		6	6 x 4 x 3/8	3 1/2 x 5 x 1/2	61	3 1/2	56	..	70	
		7	6 x 4 x 3/8	3 1/2 x 3 x 9/16	91	1 3/4	93	46	70	42
		7	6 x 4 x 3/8	3 1/2 x 4 x 9/16	81	2 1/2	79	39	78	48
		7	6 x 4 x 3/8	3 1/2 x 5 x 9/16	71	3 1/2	70	..	85	
		3/8	9.02	3	6 x 4 x 3/8	3 1/2 x 3 x 3/8	61	1 3/4	54	..
4	6 x 4 x 3/8			3 1/2 x 3 x 7/16	71	1 3/4	72	36	44	31
4	6 x 4 x 3/8			3 1/2 x 4 x 7/16	51	2 1/2	50	..	47	
4	6 x 4 x 3/8			3 1/2 x 5 x 7/16	51	3 1/2	42	..	53	
5	6 x 4 x 3/8			3 1/2 x 3 x 9/16	91	1 3/4	90	45	59	37
5	6 x 4 x 3/8			3 1/2 x 4 x 9/16	71	2 1/2	69	..	63	
5	6 x 4 x 3/8			3 1/2 x 5 x 9/16	61	3 1/2	59	..	67	
6	6 x 6 x 3/8			5 x 3 1/2 x 7/16	106	1 3/4	108	54	73	46
6	6 x 6 x 3/8			4 x 4 x 7/16	95	2 1/2	88	44	81	51
6	6 x 6 x 3/8			4 x 6 x 7/16	83	3 1/2	77	38	95	61
7	6 x 6 x 3/8			5 x 3 1/2 x 1/2	122	1 3/4	126	63	89	54
7	6 x 6 x 3/8			4 x 4 x 9/16	106	2 1/2	107	54	97	60
7	6 x 6 x 3/8			4 x 6 x 9/16	95	3 1/2	95	48	115	71
1	11.78			3	6 x 4 x 3/8	3 1/2 x 3 1/2 x 7/16	71	2	71	..
		3	6 x 4 x 3/8	3 1/2 x 4 x 7/16	61	2 1/2	44	..	45	
		4	6 x 4 x 3/8	3 1/2 x 3 1/2 x 9/16	91	2	94	47	58	39
		4	6 x 4 x 3/8	3 1/2 x 4 x 9/16	71	2 1/2	67	..	58	
		4	6 x 4 x 3/8	3 1/2 x 5 x 9/16	61	3 1/2	55	..	61	
		5	6 x 6 x 3/8	5 x 3 1/2 x 1/2	122	2	118	59	74	47
		5	6 x 6 x 3/8	4 x 4 x 7/16	95	2 1/2	91	45	76	50
		5	6 x 6 x 3/8	4 x 6 x 7/16	83	3 1/2	77	38	88	58
		6	6 x 6 x 3/8	5 x 3 1/2 x 9/16	137	2	141	71	91	56
		6	6 x 6 x 3/8	5 x 5 x 7/16	122	2 1/2	115	58	101	62
		6	6 x 6 x 3/8	5 x 6 x 7/16	106	3 1/2	100	50	98	62

Effective length of bearing assumed 1/4 in. less than length of outstanding leg. Capacities are based on rivets in single shear. Rivet values should be investigated for bearing when seats connect to thin material or when seats on opposite sides of a carrying member have rivets in common. Torsion on rivet groups is figured for gages 2 1/4 in. and over, and only rivets through stiffeners are counted. For capacities between stiffener gages of 2 1/4 and 3 1/2 in., interpolate. For capacities under 35 kips unstiffened seat angles should be used. Weight of connection includes top and seat angles, fillers, stiffeners and rivets, shown in sketch, and should be used for estimating purposes only. Length of top and seat angle assumed 4 in. greater than the distance between rivet lines, except for stiffeners with 6-in. leg for which the length is assumed as 12 in.

¹ "Steel Construction," 1941, by American Institute of Steel Construction.

cult and increases the number of field rivets (see Fig. 41). If a top and bottom connection is added to such a connection, additional stiffness is secured for wind bracing.

A discussion of beam framing is not complete without showing a complete framing plan. Figure 42 is a typical floor framing plan of a twelve story apartment building erected in Chicago. Flat arch tile is used for the floor construction.

Typical beam sketches showing the practice of detailing beams for shop fabrication are shown on pp. 509 and 510. The duplicate beams for various floors are detailed together to give the shop the advantage of duplication.

9. Columns.

9a. Requirements in Column Design.—The spacing of columns is fixed generally by the architectural requirements such as location and size of rooms, location of courts, stair wells, elevator shafts, etc. When the spacing is not governed by these considerations, the designer will determine the spacing based on economy for the building as a whole. The cost of the floor construction added to the cost of the columns and foundations should be the minimum. A duplication of the panels as far as possible will give greater duplication of the steel work, terra cotta, stone, windows and other materials.

Columns with very large wind bracing brackets and taking considerable wind bending should be investigated for ability to take this bending. The stress due to bending must be transmitted from one flange to the other through the web. The rivets from the angles into the web must be able to carry the increment of the bending stress.

Column cross-sections are discussed in Art. 9c. Frequently the size of column cross-section is made smaller than the economical size in order to increase the floor space or to conform to sizes determined by the architects. It is always true in building designs that the steel work must always maintain and conform to the architectural features. The requirements of different trades are such that vertical pipe spaces or air ducts are required along some of the columns which may require special details at the beam and girder connections.

Columns should be so placed that their greatest moments of inertia are in the direction of the shortest dimension of the building in order to give the greatest rigidity to the building as a whole, or to offer the greatest resistance to the wind stresses. When this is not a determining factor, the axes of the columns should be so placed as to afford the simplest and most efficient connections for the beams or girders.

The upper tiers of columns should be designed without cover plates where possible by increasing the thicknesses of the angles and webs, thus simplifying the fabrication by reducing the number of pieces to be punched and riveted.

The general practice is to design columns in two-story lengths. Three-story lengths have been used in a limited number of buildings but are objectionable to the erector on account of the longer booms required to raise the longer columns and the larger quantity of timber used for the temporary floors.

9b. Column Formulas.—A comparison of column formulas according to the codes of various cities is given in Table 6.

9c. Types of Columns.—Various types of columns are being used by engineers. The choice is based on economy of design, general requirements for making wind bracing and beam connections and the preference of the engineer.

TABLE 6.—COLUMN FORMULAS OF VARIOUS CITIES

City	Formula
Chicago (1938)	$f = \frac{18,000}{1 + \frac{L^2}{18,000r^2}}$ Max. 15,000 lb. per sq. in.
Dallas (1929)	$f = \frac{18,000}{1 + \frac{L^2}{18,000r^2}}$ Max. 15,000 lb. per sq. in.
Denver (1935)	$f = \frac{18,000}{1 + \frac{L^2}{18,000r^2}}$ Max 15,000 lb. per sq. in.
Detroit (1941)	$f = \frac{18,000}{1 + \frac{L^2}{18,000r^2}}$
Minneapolis (1930)	$f = \frac{18,000}{1 + \frac{L^2}{18,000r^2}}$ Max. 15,000 lb. per sq. in.
Milwaukee (1934)	$f = \frac{18,000}{1 + \frac{L^2}{18,000r^2}}$ Max 15,000 lb. per sq. in.
New York (1941)	$f = \frac{18,000}{1 + \frac{L^2}{18,000r^2}}$ Max 15,000 lb. per sq. in.
Philadelphia (1939)	$f = \frac{18,000}{1 + \frac{L^2}{18,000r^2}}$ Max 15,000 lb. per sq. in.
Portland (1940)	$f = \frac{18,000}{1 + \frac{L^2}{18,000r^2}}$ Max. 15,000 lb. per sq. in.
Salt Lake City (1940)	$f = \frac{18,000}{1 + \frac{L^2}{18,000r^2}} \left\{ 1.6 - \frac{L}{200r} \right\}$
San Francisco (1941)	$f = \frac{18,000}{1 + \frac{L^2}{18,000r^2}}$ Max. 15,000 lb. per sq. in.
Washington (1941)	$f = \frac{18,000}{1 + \frac{L^2}{18,000r^2}}$

The kinds more generally used will be shown and a comparison made of the various ones.

The type of column shown in Fig. 43, used more than any other kind, is known as the plate-and-angle column. One section is shown built up of four angles, two webs and three cover plates on each flange—the other, of four angles and one web. The lightest columns are made of four angles laced together. Additional strength is obtained by increasing the weight of the angles, adding web plates and cover plates. Handbooks published by steel companies give the sizes of these columns for various loads, moments of inertia and other properties.

The cross-sections of two plate-and-channel columns are shown in Fig. 44, one of a heavy section built up of two channels, two webs on each channel and three cover plates on each flange, the other of a lighter section consisting of two channels and one cover plate on each flange. The lightest columns are made of two channels of light weight laced together. Additional strength is obtained by increasing the weight of the channels, adding web plates and cover plates. Hand-



FIG. 43.—Plate-and-angle columns.

FIG. 44.—Plate-and-channel columns.

books published by the steel companies give the sizes of these columns for various loads, moments of inertia and other properties.

The sizes and weights per foot for standard channels are given below. Although all the sizes of channels are given to make the list complete, the sizes under 8 in. are too small to use for the average column construction.

Channels.

- 18 in.—58.0, 51.9, 45.8, and 42.7 lb. per ft.
- 15 in.—55.0, 50.0, 45.0, 40.0, 35.0 and 33.9 lb.
- 12 in.—40.0, 35.0, 30.0, 25.0 and 20.7 lb.
- 10 in.—35.0, 30.0, 25.0, 20.0 and 15.3 lb.
- 9 in.—25.0, 20.0, 15.0 and 13.4 lb.
- 8 in.—21.25, 18.75, 16.25, 13.75 and 11.5 lb.
- 7 in.—19.75, 17.25, 14.75, 12.25 and 9.8 lb.
- 6 in.—15.5, 13.0, 10.5 and 8.2 lb.
- 5 in.—11.5, 9.0 and 6.7 lb.
- 4 in.—7.25, 6.25 and 5.4 lb.
- 3 in.—6.0, 5.0 and 4.1 lb.

In Fig. 45 are shown cross-sections of two wide-flange columns, one with and one without cover plates. These shapes were devised to obtain a larger moment of inertia than a built-up column for the same weight. The steel manufacturers' handbooks give the sizes of these wide-flange columns for various loads, moments of inertia and other properties.



FIG. 45.—Wide-flange columns.

The sizes and weights per foot for wide-flange columns are as follows:

Wide-flange Columns.

- 14 in.—30.0, 34.0, 38.0, 42.0, 43.0, 48.0, 53.0, 58.0, 61.0, 68.0, 74.0, 78.0, 84.0, 87.0, 95.0, 103.0, 111.0, 119.0, 127.0, 136.0, 320.0,* 142.0, 150.0, 158.0, 167.0, 176.0, 184.0, 193.0, 202.0, 211.0, 219.0, 228.0, 237.0, 246.0, 255.0, 264.0, 273.0, 287.0, 300.0, 314.0, 328.0, 342.0, 356.0, 370.0, 384.0, 398.0, 412.0, and 426.0 lb. per ft.
- 12 in.—25.0, 28.0, 32.0, 36.0, 40.0, 45.0, 50.0, 53.0, 58.0, 64.0, 65.0, 72.0, 79.0, 85.0, 92.0, 99.0, 106.0, 120.0, 133.0, 147.0, 161.0, 176.0, and 190.0 lb.
- 10 in.—21.0, 23.0, 26.0, 29.0, 33.0, 37.0, 41.0, 45.0, 49.0, 54.0, 60.0, 66.0, 72.0, 77.0, 89.0, 100.0, 112.0, 124.0, and 136.0 lb.
- 8 in.—17.0, 19.0, 21.0, 24.0, 27.0, 31.0, 33.0, 35.0, 40.0, 48.0, 58.0, and 67.0 lb.

* Describes column core section.

Two sections of the three channel type are shown in Fig. 46. The heavier section is shown with three channels, two web plates riveted to one channel and three cover plates on each flange. The lighter section consists of three channels and one cover plate on each flange.

For columns carrying heavy loads, a design of column built up of three webs has been used. A column of this type is shown in Fig. 47 consisting of three webs, eight angles and two cover plates. For additional strength, the angles and plates are increased in thickness, and additional webs and cover plates used, if necessary.

The type of column shown in Fig. 48 consists of three I-beams riveted together. Its use is restricted, however, to such cases where suitable beam and girder connections can be made. The standard beam connections cannot readily

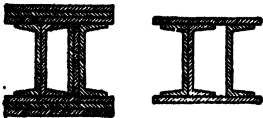

FIG. 46.—Three channel columns.



FIG. 47.—Three web column.



FIG. 48.—Three I-beam column.

be attached to this section as will be apparent by an inspection of the sketch. The column is a very rigid one and is simple to fabricate as there are but few pieces of material to handle with a small number of rivets per ton.

A modification of the three I-beam type for extremely heavy loads is the substitution of built-up sections instead of I-beams, as shown in Fig. 49. This column has the same restrictions as the column shown in Fig. 48 with the added disadvantage of a larger number of rivets per ton.

A column which has been used for reinforced concrete columns is the Gray column, patents for which have expired. The section is shown in Fig. 50 and consists of four pairs of angles connected by bent straps. Many sizes of columns and weights are possible with this design but the angles must be of such proportion to the width of the columns that the rivets through the bent straps can be



FIG. 49.—Built-up column.

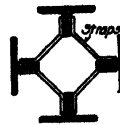

FIG. 50.—Gray column.



FIG. 51.—H-column.

driven. To determine the size and weight of this type of column, investigation for resistance to bending and shear should be made and it should also be computed as a reinforced column carrying the floor loads.

For light loads, the H section, Fig. 51, will be found very desirable. The depth and flange width is the same in each section. The column is a simple one to make in the shop and beams are easily connected to it. Four sizes of these beams are rolled as given in the following table:

H Sections.

8 in.—37.7, 34.3 and 32.6 lb. per ft.

6 in.—27.5, 25.0, 22.5, and 20.0 lb.

5 in.—18.9 lb.

4 in.—13.8 lb.

Cast-iron columns are ordinarily made with cylindrical sections. Suitable lugs are cast on the columns for connections to framing beams (see Fig. 52). As cast-iron columns are made to order, a considerable variation in design is possible. The common sizes vary from 5 to 15 in. in diameter and from ½ to 2½ in. in thickness. For special purposes, angle, U-shaped, rectangular, square and H sections have been used. Cast-iron columns have the advantages of offering greater resistance to fire than unprotected steel columns, can be quickly obtained, can be made of any desired shape to meet the requirements of the architectural features, and they take up a minimum of space in the building. There are disadvantages, however, such as uncertainty in the quality of the material, a higher cost than the structural steel columns and the fault of eccentricity in the metal due to the liability of the core not being concentric with the outside circumference of the columns. This fault is detected at the ends. At intervals along the column, it is necessary to drill test holes in order to measure the thickness of the metal. About ⅛-in. eccentricity is permissible.



FIG. 52.—
Cast-iron column.



FIG. 53.— Lally column.

A section of the patented Lally column is shown in Fig. 53. Steel shells are filled with compressed concrete. Additional strength for the columns is obtained by reinforcing with a bar or bars, or a pipe through the center of the column. The various sizes made are as follows:

LALLY COLUMNS

HEAVY WEIGHT	LIGHT WEIGHT
12¾-in. dia.—169 lb. per ft.	4 -in. dia.—17 lb. per ft.
10¾-in. dia.—123 lb.	3½-in. dia.—13 lb.
9⅝-in. dia.—100 lb.	
8⅝-in. dia.— 81 lb.	
7⅝-in. dia.— 64 lb.	
6⅝-in. dia.— 49 lb.	
5½-in. dia.— 36 lb.	
5 -in. dia.— 29 lb.	
4½-in. dia.— 24 lb.	
4 -in. dia.— 20 lb.	
3½-in. dia.— 15 lb.	

Many varieties of bases, caps, beam and girder connections are made to suit all requirements for making connections. Complete information in regard to the columns and accessories is published by the manufacturers, Lally Column Co.

9d. Comparison of Different Types of Columns.—The plate-and-angle column, Fig. 43, is a simple one from the standpoint of the designer, fabricator and erector. The beam and girder connections are easily made. Field rivets are easily driven in both the web and flanges. Errors are easily remedied and revisions made without the necessity of tearing the column apart. These advantages account in part for the extensive use of this column.

The plate-and-channel column, Fig. 44, is open to some objections not true of the plate-and-angle column. The beam connections on the cover plates are riveted before the various parts of the column are fitted up, thereby involving extra handling of material. As the section is a "closed box" type, through bolts

must be used instead of field rivets for the field holes in the web face. Errors are very difficult to remedy and revisions can only be made by tearing the column apart.

A comparison of strength between these columns, Figs. 43 and 44, will be made assuming the story heights to be 20 ft. and the columns designed according to the Chicago Building Ordinance—that is, the allowable unit stress is $\frac{18,000}{1 + \frac{L^2}{18,000r^2}}$ with a maximum of 15,000 lb. per sq. in. In order to have the

maximum allowable stress available, the least radius of gyration of the column must be about 4. This value for a plate-and-angle column can be obtained for the larger sizes only, such as a column with 16-in. cover plates, whereas in a plate-and-channel column, the value may be obtained with 12-in. covers. The following are approximate values only but are sufficiently close for a comparison:

PLATE-AND-ANGLE COLUMNS (FIG. 43)

Covers (in.)	Least radius of gyration (in.)	Allowable unit stress (lb. per sq. in.)
14	3 58	14,400
16	4 05	15,000

PLATE-AND-CHANNEL COLUMNS (FIG. 44)

Channel (in.)	Covers (in.)	Least radius of gyration (in.)	Allowable unit stress (lb. per sq. in.)
10	12	3 33	13,950
12	14	4 04	15,000
15	16	4 76	15,000
	18	5 46	15,000

It will be noted from the above, that for the same size covers, the plate-and-channel column permits a working stress about 450 lb. per sq. in. higher than the plate-and-angle column. Expressed in percentage, the plate-and-channel column is 3.1 per cent lighter than the plate-and-angle column. The comparison is based on plate-and-angle columns having cover plates. If plate-and-angle columns without covers be used in comparison, the economy in weight will be more in favor of the plate-and-channel column. Only a small number of columns for the entire building are designed without covers so the comparison made is applicable to the majority of the columns. Taking into consideration the many advantages obtained by the use of the plate-and-angle columns, the latter is preferred by most designers instead of the plate-and-channel type.

The wide-flange columns, Fig. 45, have advantages and disadvantages not possessed by the other types. A greater moment of inertia is obtained for the same weight and since the column is in one piece, the cost of riveting up various pieces (as in the plate-and-angle, or the plate-and-channel column) is saved. When cover plates are used on the wide-flange columns, some of this advantage

is lost. The holes in the webs and flanges of wide-flange columns exceeding 1 in. in thickness must be drilled, whereas for the columns made up of plates and angles, 1 in. in thickness and under, the holes can be punched full size. A full discussion of wide-flange shapes compared with standard shapes is given in Art. 8b.

The three channel type of column, Fig. 46, readily permits additional sectional area for heavy loads but is a difficult column to fabricate. The material must be handled several times in the shops for riveting on the connection angles, the columns are then only partly assembled and riveted, and finally the third channel is fitted between the cover plates and riveted. There is also the same objection to this column that there is to all box sections—that is, through bolts are required for the connections through the webs and the column is inaccessible for painting.

The same criticism made of the three channel type will apply to the type of column shown in Fig. 47.

The three I-beam type of column Fig. 48, is admirably adapted for heavy loads and for resisting large bending stresses, provided the connecting beams and girders framing into the columns are so located that good connections can be made.

The Gray column, Fig. 50, is difficult to keep square and free from twist in fabrication. Connections for beams and girders are easily made to the Gray column if the connecting members are on the center line of the column. If the connecting members are off the center line of the columns, efficient connections are impossible. For the same weight the Gray column has a larger moment of inertia than any other column except those shell shape in section but its cross-section is large in comparison with the columns ordinarily used. At the present time, the Gray column is seldom used.

The H section, Fig. 51, is ideal for light loads permitting good connections for framing beams and cheap fabrication.

9e. Column Splices.—Column splices are generally located a little above the floor level at a point where the column splices will be clear of the beam or wind bracing brackets. This will result in an economy of steel for the main members of the columns and will also permit the erector to place a temporary floor at this level before proceeding with the next tier. By placing all of the splices at the same level, greater duplication of columns is obtained. The splices should never stagger at different floor levels because, with this condition, the erector cannot erect the steel by tiers and place temporary floors for progressive erection.

The theoretical location of a splice is at the point of contraflexure of the column. Due to wind stresses, this point is at the middle of the column but due to direct load, there are two points of contraflexure considering the ends of the columns fixed. These points of contraflexure will vary from the middle of the column to points above or below the middle depending upon the amount of the wind stress. Consequently the present practice of placing the splices from 1 to 5 ft. above the floor level is close enough for practical purposes.

The best type of column splice and the one generally used consists of splice plates on the flanges and cap angles on the web. This type of splice permits easy erection of the upper column on the lower one and has the smallest number of field rivets to drive. When the column section changes in width, a cap plate is inserted between the abutting ends to distribute the bearing.

A typical drawing of a column is illustrated on p. 511 with the ordinary type of splice.

10. Party Walls.—Party walls, as the name implies, are the common walls used by two adjoining buildings. The different ordinances regulate their thicknesses, method of support, and requirements for fireproofing. Obviously, party walls are used as a matter of economy and to save floor space. For extensions to existing buildings under the same ownership, the party wall is desirable—as for example, when extensions are made to department stores or hotels. In some cases, the use of the party wall may seem to be the logical solution but the difficulties of construction may be such that the design of independent walls is best.

The simplest party wall is the dividing wall between two adjoining buildings and carries the floors of the two buildings, the foundations being designed strong enough for this purpose. Sometimes in designing a building, an extension is

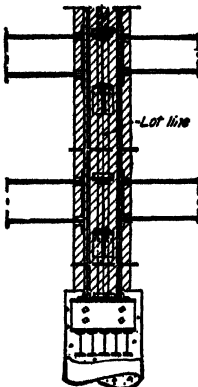

FIG. 54.—Simple party wall.

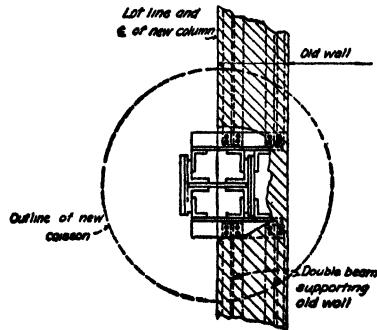

FIG. 55.—New column supporting old wall.

contemplated and the wall adjacent to the proposed addition is made heavy enough and connections are riveted to the columns for the future connections. When the extension is made, it is then a simple matter to cut holes through the masonry at the connection points of the old building and insert the new beams (see Fig. 54). As the walls of old buildings are generally out of plumb, measurements are taken in the field to get the correct lengths of the new beams which connect to the old columns. Buildings supported on piles or floating foundations have been found to lean more or less, even as much as 12 in. The settlement of buildings supported by caissons resting on bed rock has been found to be negligible.

Special problems are involved when a new building is erected alongside of an old one having self-sustaining walls and it is decided to preserve and use the old wall as a party wall. Figure 55 shows a design to meet these conditions. New foundations for the party wall are placed centrally on the lot line. Then the new columns are erected on the new foundations in recesses made in the old wall. As it is the intention to support the old wall on the new foundations, the old wall is underpinned a few feet above the piers and double beams inserted which connect to the new columns and support the weight of the old wall. The illus-

tration shows the double beams connected to the columns inside of the old wall. Beams are placed alongside the old wall at the floor levels and connected to the columns to support the new floors. As these beams are placed within the depth of the floors, there are no projections into any room space. If the old building is out of plumb and leans toward the new building, horizontal recesses are made in the old wall to receive the new beams. When the construction is completed, the foundations carry the weight of the old wall, and the floors of the new and old buildings. The columns carry the floors of the new building and the old wall, as before, carries the floors of the old building.

If the old wall is not self-sustaining but is supported by wall beams and columns and it is desired to use the old wall as a party wall, a different design from the one shown in Fig. 55 is adopted. The old foundations are enlarged, reinforced, or replaced sufficiently to support the added weight of the floors of the new building. The old wall is recessed at the column points to receive new columns which when erected are rigidly connected to the old columns. The combination columns composed of the old and new columns are designed to carry the weight of the old wall and the floors of the old and new buildings. As in the other design, new beams are placed alongside the old wall at the floor levels and connected to the columns to support the new floors.

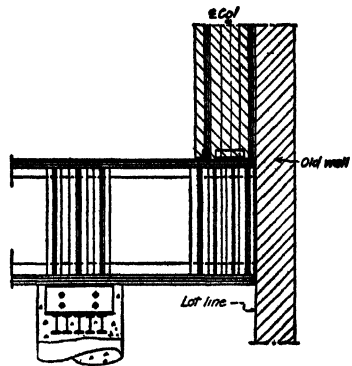

FIG. 56.—Cantilever girder.

In all structural buildings, when it is necessary to connect to old walls, special details and connections must be devised to enable the erector to drive the field rivets with sufficient clearance without interference from the existing old wall. Turned bolts as substitutes for field rivets are only permitted when the driving of field rivets is impossible.

When a new wall is carried up independently of the old wall, foundations must be designed to stay within the lot line and not interfere with the foundations of the old building. Cantilever girders are used for this purpose. The girders rest on two piers and support the wall columns which are located within the lot line and off the center of the piers. If the wall of the old building is out of plumb and leans toward the new building, vertical recesses are made in the old wall for the new columns and horizontal recesses for the spandrel beams. Figure 56 illustrates a design of an independent wall carried on cantilever girders.

11. Wind Bracing.

11a. Wind Load Requirements.—A list of the wind load requirements given in the codes of several cities is given in Table 7.

11b. Resistance to Wind Stresses.—The question of wind bracing for steel buildings is very important and at the same time difficult to solve. Probably no other phase of building design has been so freely discussed as the proper method of resisting wind stresses. Probably also the biggest diversity in designs by different engineers lies in their treatment of the wind bracing. The wind bracing for every building is solved differently, being governed by the building code, height, size of wings, width and length of the building.

TABLE 7.—WIND-LOAD REQUIREMENTS FOR VARIOUS CITIES

City	Requirements
Chicago (1938).....	25 lb. per sq. ft.—30 lb. per sq. ft. on a surface more than 275 ft. above grade—overturning moment not to exceed 75 per cent of dead load resisting moment
Dallas (1929).....	20 lb. per sq. ft. of vertical surface—overturning moment not to exceed 75 per cent of dead load resisting moment
Denver (1935).....	10 lb. per sq. ft. for those portions of the building less than 40 ft. aboveground and not less than 20 lb. per sq. ft. for those portions more than 40 ft. aboveground
Detroit (1941).....	20 lb. per sq. ft.—to be increased 2 lb. per sq. ft. for each 100 ft. or fraction thereof over 100 ft. high
Memphis (1930).....	20 lb. per sq. ft. on sides, ends and vertical projection of roof. 30 lb. per sq. ft. on frames under construction
Milwaukee (1934).....	20 lb. per sq. ft. of exposed surface—overturning moment not to exceed 75 per cent of the moment of stability of the structure due to dead load only
New York (1941).....	20 lb. per sq. ft. of exposed surface from top of structure down to the 100-ft. level for structures over 100 ft. in height. The overturning moment due to wind pressure shall not exceed 75 per cent of the moment of stability
Philadelphia (1939).....	20 lb. per sq. ft. over the entire surface. 25 lb. per sq. ft. for an isolated building exposed to the full force of the wind throughout its entire height and width
Portland (1940).....	20 lb. per sq. ft. of exposed surface—overturning shall not exceed 50 per cent of the moment of stability of the structure
Salt Lake City (1940)...	15 lb. per sq. ft. for those portions of the building less than 60 ft. aboveground and not less than 20 lb. per sq. ft. for those portions more than 60 ft. aboveground. The overturning moment shall in no case exceed 50 per cent of the dead load resisting moment
Washington (1941).....	20 lb. per sq. ft. of exposed surface measured from the ground to the top of the building, for all buildings or parts of buildings in which the height is more than two and one-half times the minimum horizontal dimension. The overturning moment shall in no case exceed 66⅔ per cent of the moment of stability due to dead load only

The ideal system for resisting wind stresses is by means of a web system of diagonals but, as web systems interfere with window openings, portal bracing must be used. Wind bracing girders are used, generally in the outer walls, extended at the ends with brackets to provide resistance to the bending moment. For buildings of narrow width, these girders extend through the interior of the building. Obviously such bracing will be designed to advantage where required—for example, for wings around courts, around lobbies, high stories, towers, etc.

Much uncertainty is involved in the resistances to wind forces. The interior partitions, floor construction and exterior walls all contribute to the rigidity of the building, but to an indeterminate extent. It is, therefore, safe designing to

neglect such assistance in the computations and rely only on the system of bracing calculated.

Under the provisions of some building ordinances, buildings may be built to certain heights without any provision for wind pressure. Others will permit a height of from one and one-half to three times the least horizontal dimension before requiring wind pressure to be considered.

The type of construction of walls is an important one in determining the amount of wind bracing necessary. For instance, a solid brick wall, in the direction of the short dimension of the building, offers a big resistance to wind stresses.

If any allowance is made for the resistance to wind pressure offered by the partitions, floors and exterior walls, this usually is taken care of by reducing the intensity of wind pressure for which the structural frame is designed.

In resisting wind pressure, the building acts as a cantilever beam and is held in position by its own weight and anchorage. There is generally no danger of the building overturning but the tendency to "rack" must be provided against by the proper design of the connections.

The structure is divided into a number of vertical bents and these bents are designed to carry the wind stresses to the foundations. These bents receive their loads from the floors, which act as horizontal beams. Usually the floor construction is amply strong for such beam action and requires no special consideration. In special cases, where the vertical bents are offset for architectural reasons, the floor construction may require special reinforcement to take care of this condition. The vertical bents thus act as portal frames or a series of portal frames.

The portal system adapts itself readily to provide clearances for openings and architectural features. This method, however, produces bending stresses in the columns and requires special treatment in design of the beam and girder connections to the columns. These connections will be discussed in detail for different types of girders and beams.

The end connections of wind bracing girders must transmit the moment caused by the portal action of the bent and in addition a direct stress of tension or compression. For small moments, rolled beams with properly developed end connections may be used for bracing, also serving as supports for the wall. For larger moments, built-up girders must be used. In many cases the depth of the girder is sufficient to provide a connection strong enough to carry the moment. For still larger moments, it is necessary to add wind bracing brackets or increase the depth of the girder connections by the use of gusset plates spliced to the webs of the girders.

The thickness of the end connection angles should be considered by the designer. This thickness depends upon the amount of load transmitted and the gage of the rivets in the legs of the angles riveted to the columns. A thin connection angle will distort and decrease the rigidity of the connection, perfect rigidity of the joints being the assumption made in the analysis for resistances to wind stresses.

11c. Types of Wind-bracing Girders.—After the calculations for the sections and end connections of the girders are made, the girder is designed to conform to the architectural requirements, such as window openings, supports for stone, terra cotta or brick. In some cases only one bracket at each end is

possible, either above or below the girder. Very frequently, too, the girder must be placed off the center of the column to support the wall properly, causing an eccentric connection to the column. Sometimes, the flange sections are designed unsymmetrical about the webs to suit the physical conditions of the wall. Briefly, the designs must be correctly computed and meet all the requirements of supporting walls, projecting materials as stone, brick or terra cotta, and also clear openings.

The simplest kind of wind-bracing girder is shown in Fig. 57. The I-beam has a web connection with top and bottom angles connected to the column for

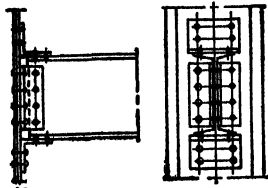

FIG. 57.—Wind-bracing girder.

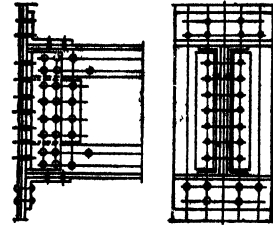

FIG. 58.—Wind-bracing girder.

rigidity. The rivets in the vertical legs of these angles should be placed as close to the root of the angles as possible, the thickness of the angles being specified big enough to develop the rivets. Note that the rivets through the web of the I-beam are field driven, to allow for adjustment in the distance between the columns.

The type shown in Fig. 58 is similar to the one shown in Fig. 57, except that a built-up girder is used instead of an I-beam to develop a greater bending moment than is possible with an I-beam. The connection in the illustration is known as a "butt" connection. As the end connection angles are shop riveted to the

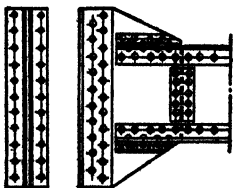

FIG. 59.—Wind-bracing girder.

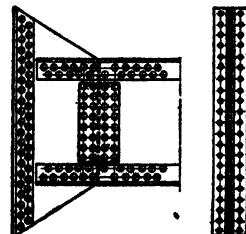

FIG. 60.—Wind-bracing girder.

girder, the length of the girder is definitely fixed without adjustment. In erection, the girder is raised to the proper floor level and set on top of the seat angles. The girder is then bolted or pinned in place and the top angle bolted or pinned ready for the riveting gang. If a line of girders with butt connections exceeds about 100 ft., provision for adjustment should be made to allow for what is known as the "growth of the steel," or to allow for inaccuracies in setting the columns at the correct distances apart. Adjustment may be made by detailing the girders $\frac{1}{8}$ in. less at each end than the actual lengths and providing shim plates varying in thickness of $\frac{1}{8}$ in. for about one-half of the number of openings. Oftentimes, some of the girders will be identical except for differences in length of less than 1 in.

In such cases, to simplify the fabrication and secure more duplication, the girders should be detailed the shortest length and fillers, not exceeding $\frac{1}{2}$ in. in thickness, added to obtain the correct lengths.

Another type of connection (Fig. 59) is used to provide a depth of connection greater than the depth of the girder. The angles riveted to the flange angles increase the cost of fabrication somewhat, due to the extra handling of the girder necessary to drive the rivets through the outstanding legs of the flange angles.

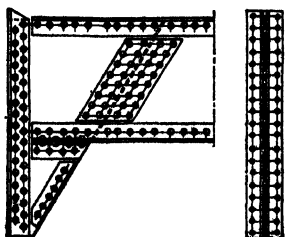

FIG. 61.—Wind-bracing girder.

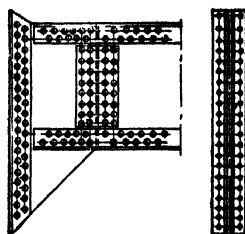

FIG. 62.—Wind-bracing girder.

The girder shown in Fig. 60 is simpler than the one in Fig. 59, the objectionable angles riveted to the flange angles being omitted.

The girder in Fig. 61 is objectionable in fabrication, the web splice being made on an angle. The one shown in Fig. 62 is much preferred. In both these types, it was necessary to extend the connection below the girder as the clearances required by the architects did not permit any steel projecting above the top flanges.

Two types of wind-bracing girders designed to transmit large moments are given in Figs. 63 and 64. The one in Fig. 63 is placed on the center line of the

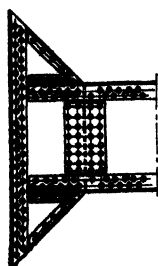

FIG. 63.—Wind-bracing girder.

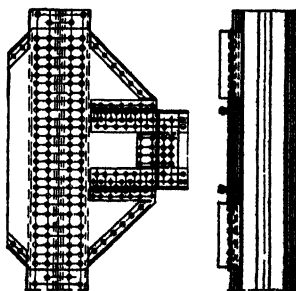

FIG. 64.—Wind-bracing girder.

columns and attaches to the web or flanges. The one in Fig. 64 is located off the center line and connects to the flange of the column.

12. Spandrels.

12a. Architectural Requirements.—A spandrel is the portion of the outside or court walls between the window openings for successive stories. Spandrel beams or girders are designed to give proper support for the various materials in the spandrels. Very often, the spandrel beams or girders are used for wind bracing as well if the architectural design will permit. As the masonry walls of a steel building are not self-supporting, the spandrel beams carry only one

story height of wall. To provide support for the stone, terra cotta and brick, a great many varieties of spandrels are required in one building. It is advisable,

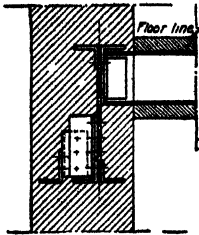

FIG. 65.—Spandrel section for solid wall.

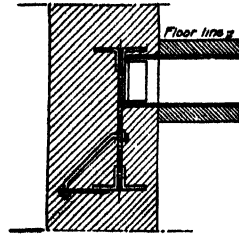

FIG. 66.—Spandrel section for solid wall.

though, to design the spandrels with as few varieties as possible. Anchors, tie rods and clips for holding the masonry are furnished by the masonry contractor.

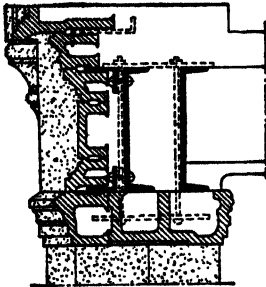

FIG. 67.—Spandrel section showing method of supporting terra cotta.

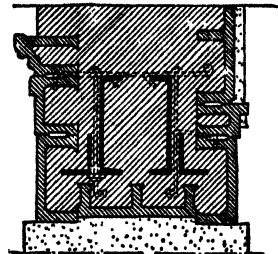

FIG. 68.—Section over entrance showing method of supporting terra cotta.

When the spandrel beams or girders do not extend outside of the column, lugs or brackets (called "brick supports") are attached to the columns at each floor level to carry one story of brick or other material for the width of the column.

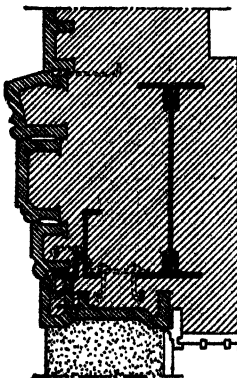

FIG. 69.—Spandrel section through wall.

12b. Kinds of Spandrel Beams.—In Figs. 65 and 66 are shown two methods of supporting a story height of solid wall. In the cases shown, the girders carry the floor loads and also act as wind-bracing girders. The material for the walls may be solid brick or brick backing faced with stone or terra cotta.

Other varieties are shown in Figs. 67 and 68, illustrating the diversity of designs required for various architectural features.

Sometimes the projecting wall requires additional support besides the girder. Such a condition is shown in Fig. 69.

13. Lintels.

13a. Architectural Requirements.—Lintels are the structural supports over windows, doors and other openings. They are composed of various shapes best adapted for the architectural design. Usually the lintels are supported on the masonry walls but sometimes they are suspended from the spandrel

beams above, and sometimes, for large openings, are carried directly to the columns. The steel mullions, where required, are connected to the lintels.

13b. Kinds of Lintels.—Various kinds of lintels are shown in Fig. 70. Such lintels are supported on the walls. Almost any section can be used which has sufficient strength in bending and gives support to the material placed upon it.

A section of a lintel and spandrel is shown in Fig. 71.

14. Cornices.

14a. Architectural Requirements.—The cornices of tall buildings may seem insignificant from the ground but are made of sufficiently large projections to appear in correct proportion to the eye from the street level. The steel must be designed to support the material used in the cornice and resist the overturning moment of the dead weight. Generally terra cotta is used for the face material. Brick, hollow tile or both are required for the backing, but open spaces are provided behind the cornices as far as possible to reduce the dead weight. Anchors, tie rods, and dowels are used to fasten



FIG. 70.—Lintels.

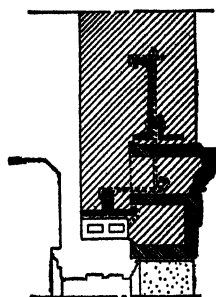

FIG. 71.—Spandrel section and lintel.

the terra cotta to the steel. The steel contractor details his steel work to provide holes and connections for all supports to the terra cotta or stone.

14b. Supports for Cornices.—The two types of cornice supports illustrated are representative of practically all designs for carrying the weight of the projecting cornices—the bracket type, Fig. 72, and the kind using outlookers, Fig. 73.

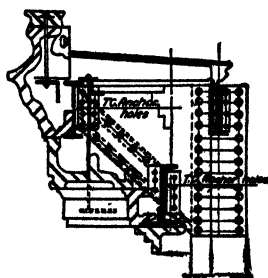

FIG. 72.—Cornice supported by brackets.

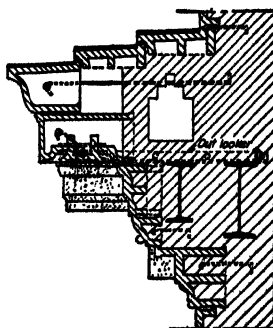

FIG. 73.—Cornice supported by outlookers.

In Fig. 72, two I-beams and a channel carry the weight of the cornice directly to brackets riveted to the columns. The location of the steel is determined from the design of the terra cotta. Auxiliary angles are bracketed to the I-beam and channel for fastening the terra cotta facing. Anchors and tie rods are used for this purpose.

In Fig. 73, outlookers spaced from 2 to 4 ft. are riveted to supporting I-beams which are attached to the columns. In this case, most of the weight of the cornice is carried by the I-beams, the projecting cornice being anchored to the outlookers.

15. Roofs.

15a. Design of Roofs.—Roofs are designed to suit different conditions. If the building is of maximum height and there is no anticipation of adding any stories in the future, the roof is designed to be permanent. In many cases, provision must be made for future stories, in which case the columns are designed heavy enough to carry the weight of the future floors and the temporary roof is designed level and as a future floor. The temporary roof covering is laid on a light concrete pitched for drainage. The ends of the columns are punched for the splices of future columns. The temporary members, such as cornice brackets and outlookers, are bolted in place for easy removal.

The permanent roofs may be flat, of mansard shape, gabled shape or a combination of any of these. Flat roofs are probably used most, the roof framing beams being pitched for drainage. The designs for mansard and gabled roofs consist of trusses, girders, rafters, or hip and valley framing as required. Such designs are frequently quite complicated and the computations for length of members, elevations, location of holes for field rivets and angles of intersection are tedious to make. For structural work of this kind, there is always a possibility of the work not fitting accurately in the field.

On hip and valley work, towers, domes, skylights, etc., when the framing is of light construction, fastenings called "Streeter clips" may be used to advantage. The clips are made of steel plates, about $\frac{1}{8}$ in. in thickness, of various shapes and sizes for connecting different structural members together without the use of rivets or bolts. I-beams, channels, angles, tees or Z-bars are connected to rafters or other supports by bending the clips around the two pieces to be connected. In many cases, the use of Streeter clips saves time in the detailing of shop plans, eliminates the punching of many holes, facilitates the erection and lessens the chances for field errors.

15b. Drainage.—In all roof construction, the designer should be familiar with the system of drainage provided by the architects and arrange the steel work properly to provide drainage of the roof in accordance with this system.

For flat roofs, the pitch of the roof is made up in the light concrete filling, the steel framing in the roof being level. This is particularly true when the roof is temporary and designed as a floor with provision made for the addition of future stories. Generally, though, for permanent roofs, the roof beams are framed to give a pitch of about $\frac{1}{2}$ in. in 12 in. for drainage. The pitched surfaces thus formed are "warped" surfaces.

For gable roofs, the steel framing must often be designed either to shape the gutters or provide supports for them.

In hip and valley work, the framing forms the valleys which lead to the gutters and downspouts. The flashing of the side walls to sloping roofs may require special treatment in the steel design.

The downspouts are usually placed alongside of the columns in vertical spaces inside of the fireproofing. For the columns containing pipe spaces, the beam con-

nections to the columns must give sufficient clearance for the downspouts and possibly other piping required for water, heat and electric wires.

15c. Roof Coverings.—The kind of roof covering to be used depends upon the shape of the roof and conformity with the grade of materials used throughout the building. Naturally, if the most durable and expensive material is used for the building, the roof material will consistently be of the most durable and best grades.

The kind of roof covering being determined, the engineer designs the roof framing to suit the roof covering both as regards strength and accommodations for support and fastening. Each class of roofing requires, usually, a different scheme of roof framing.

It is not the intention to discuss in detail the various kinds or brands of roof coverings except insofar as the roof coverings affect the design of the steel framing. For convenience, the roof coverings will be separated under two headings, "flat roof coverings" and "pitched roof coverings."

FLAT ROOF COVERINGS

Reinforced Concrete, Hollow Tile.—The steel framing is designed similar to that required for floor construction to support the reinforced concrete or hollow tile. The top surface is waterproofed with waterproof cement, asphaltum, composition, ready roofing or tar and gravel.

Cement Tile, Solid Terra Cotta Tile, Book Tile, Etc.—Many grades of tile made of cement or clay are on the market. The manufacturers publish all the data pertaining to sizes and weights. The supports for the tiles, I-beams, channels, angles or tees must be spaced to conform to the commercial sizes of the tile. The cement tiles are manufactured with a glazed top surface and require no additional coating. The terra cotta tiles are covered with roof covering.

Gypsum.—Various brands of tile are made using gypsum as the base. The steel supports are spaced to suit the commercial sizes. After the blocks are laid and the joints cemented, the gypsum is covered with waterproof materials. One of the qualities of gypsum is its heat resistance.

Tar and Gravel.—This kind of roof covering may be applied on concrete, gypsum or tile but usually is laid on matched and grooved sheathing. The steel beams to support the sheathing are spaced according to the thickness of the sheathing. The sheathing is nailed to nailing strips which are bolted to the steel supports.

Ready Roofing, Asphaltum, Tin, Sheet Steel, Copper and Canvas.—These various coverings may be laid on tile or concrete but usually matched and grooved sheathing is used.

PITCHED ROOF COVERINGS

Cement Tiles and Clay Tiles.—The tiles are generally laid directly on the purlins which are spaced at proper distances apart to suit the commercial sizes. The smaller ornamental tiles are nailed to sheathing or nailing strips. These tiles are generally glazed and of the interlocking type.

Corrugated Steel.—Sometimes the corrugated steel is fastened directly to purlins but if a better roof capable of retaining the heat is desired, the corrugated steel is laid on sheathing.

Slate, Cedar, Asbestos, Asphaltum and Composition Shingles, Metal Tile and Ready Roofing.—There are many kinds of shingles and prepared roofing. These are generally laid on sheathing.

16. Balcony Construction.—There are three ways of supporting balconies: (1) By posts under the balcony; (2) by suspending the balcony by means of tie rods hung from the floor above or from the roof; or (3) by the use of cantilever construction which does not require posts or tie rods. The latter method is customary as it is generally desired to have a large seating space without any

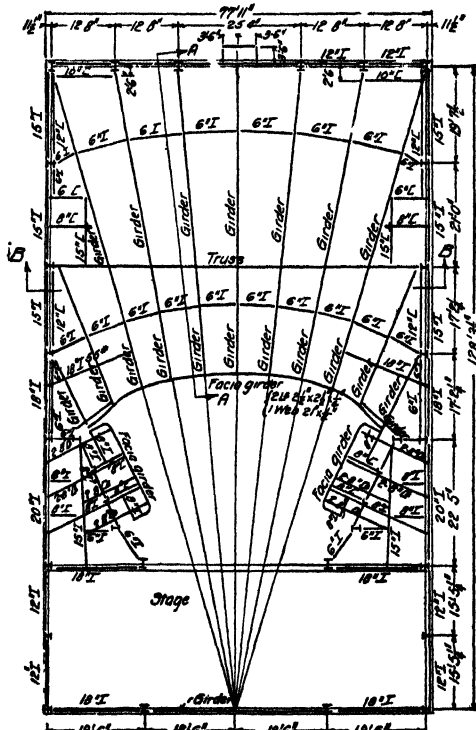

FIG. 74.—Plan of balcony construction.

obstructions to mar the line of vision. This applies particularly to churches, theaters or any structure containing assembly halls.

Every problem calling for balcony construction is treated differently as the design depends upon the distance between the walls of the auditorium, projection of the balcony and the head room under the balcony.

The design selected to illustrate balcony construction was taken from the Orpheum Theater at Seattle, Washington. The building is about 130 ft. long by 78 ft. wide, containing basement, main floor, main balcony and fly balcony. The seats in the main floor and two balconies are arranged circular in plan and in successive tiers.

A plan of the main balcony is shown in Fig. 74. A large truss near the middle of the auditorium supports the cantilever girders which are inclined to give

live load weight on the cantilever. The girder splice is designed to develop the large bending moment and shear.

17. Skylight Construction.—There are many varieties of designs for skylight construction varying with the different conditions of size and location. One type

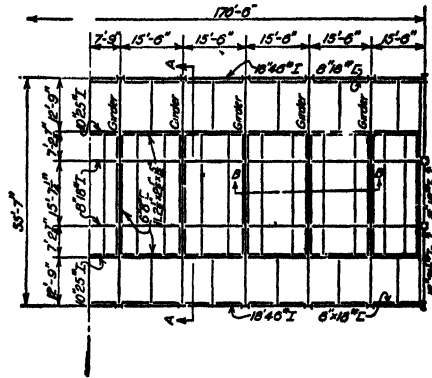

FIG. 77.—Court skylight framing.

of skylight is illustrated. The selection made was considered representative of good construction and typical of court skylights. The design was taken from the court skylight at the third floor level, Illinois Merchants' Bank Building, Chicago.

One-half of the framing plan is shown in Fig. 77. Supporting girders with spans of 55 ft. 7 in. connect to the columns on each side of the court. The glass

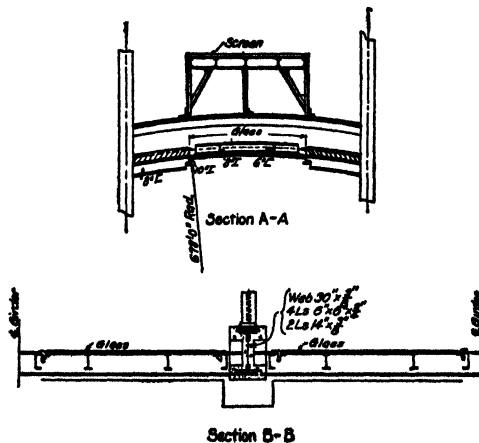

FIG. 78.—Sections through skylight framing.

portion in the center (about 30 ft. wide by 170 ft. long) is separated from the remainder of the roof by 10-in. I-beams. The part of the roof on each side of the skylight is about 12 ft. wide and constructed of light tile. A screen is placed over the skylight supported by a raised framework of steel. Section A-A in Fig. 78 shows a cross-section indicating the supporting girders, skylight construction, and framework for the screen. The skylight as viewed from below is arched for

the architectural effect. Section B-B in the same figure is a longitudinal section showing the skylight construction and supporting girders.

18. Towers.—There are many types of towers, varying in shape and height, but they are all similar as far as the computations for stresses are concerned.

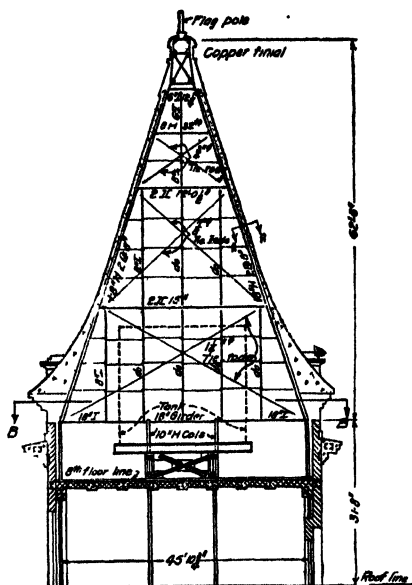

FIG. 79.—Section through tower.

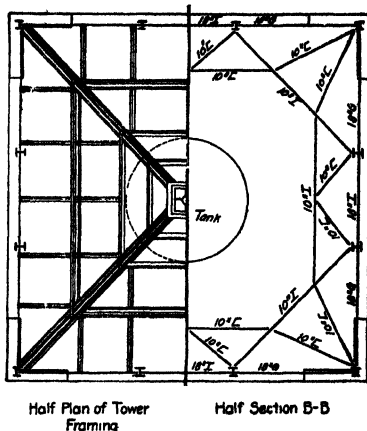
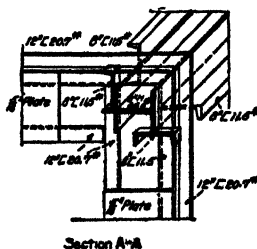

FIG. 80. - Half plan and section of tower.

Naturally the design of the bracing is the most important feature in a structural tower. The tower is figured as a cantilever above the roof line, the wind stresses being carried down the building to the foundations.

The design illustrated in Figs. 79, 80 and 81 is that of a tower on one of the Western Electric Company's buildings at Hawthorne, Illinois, a suburb of Chicago. It is somewhat unusual in tower construction, containing, as it does, a water tank, a spiral stairway and a movable flag pole.

The top of the tower, exclusive of the flag pole, is about 94 ft. above the roof line. It is square in cross-section, horizontally, has vertical sides for a height of 31 ft. 8 in. above the roof line and is then of pyramidal shape to the apex. The lower part is brick and terra cotta. The pyramidal portion is made of a cinder concrete covered with tile. The apex is crowned with a copper finial from which the flag pole rises.



Section A-A
FIG. 81.—Section of tower column.

The tower is about 48 ft. square for the lower part. At the eighth floor level inside of the tower are girders and I-beams supporting a water tank. This construction is shown in Fig. 79. Surrounding the tank is a spiral stairway which

is continued above the tank in short flights extending to a point near the apex. The flag pole is arranged so that it can be lowered into the tower for repainting.

Figure 80 is a half plan of the tower framing and a section B-B showing the bracing provided at the tops of the columns 31 ft. 8 in. above the roof level.

Figure 81 shows a section of one of the tower columns. It is composed of an 8-in. H-column and two 8-in. channels. One of the channels is riveted to the flange of the H-column and the other is connected to the H-column with lug angles. As will be apparent from the sketch, the 8-in. channels are placed in the planes of the pyramidal sides to provide framing for the walls of the tower shown in Fig. 79.

19. Interior Steel Stacks.—Outside stacks for buildings are rarely used as they require considerable expense for maintenance and architecturally can never

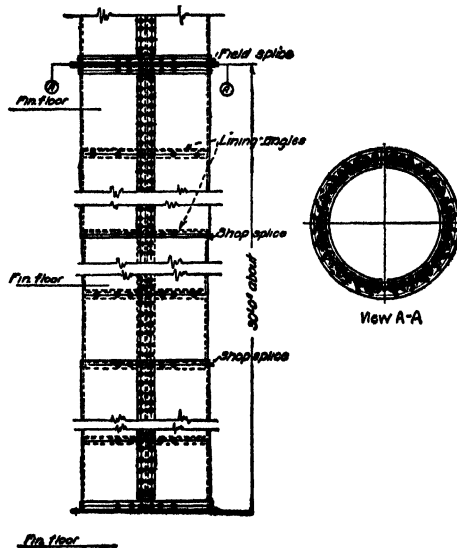

FIG. 82.—Self-supporting stack.

harmonize with the surrounding buildings. However, if one heating plant is used for two or more buildings or for any other reason, an outside stack may be advisable. The vast majority of the stacks for buildings classed as office buildings are interior stacks. This discussion will be limited to stacks of this class.

The building codes under which the interior stacks are designed are generally explicit in regard to fire insulation, size of section and amount of projection above the roof. As the stacks are fully protected from wind, they are designed for the dead load only—that is, the weight of the steel and fireproof lining.

The size of the stack in cross-section will vary according to the radiation to be provided for. The usual sizes of stacks for tall buildings are from 4 to 8 ft. in diameter. Sizes, though, as small as 2 ft. 6 in. in diameter have been used and as large as 6 ft. 8 in. by 10 ft. 8 in., oval shape.

Interior stacks are made either self-supporting or in sections supported by alternate floors.

19a. Self-supporting Stacks.—The self-supporting stacks rest and are supported generally on grillage or cast bases set in concrete. The elevation

of the base will, of course, depend upon the location of the boiler room. In some cases, the bottom of the stack has been carried as low as the third basement. There may even be conditions where the base is carried directly on the first floor.

The side movement of the stack is taken care of by bracing placed usually at alternate floors. This bracing is very simple, consisting of abutting angles connected to the adjoining floor beams but not connected to the stack so that the latter is free to expand and contract independently of the building itself.

For simple fabrication, the vertical shop splices preferably are made butt joints and the horizontal splices lap joints. The plates forming each shipping section are made as large as the shop facilities will permit to save handling of material, punching and riveting.

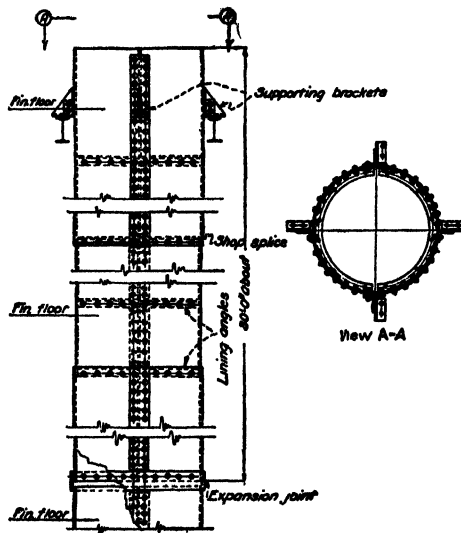

FIG. 83.—Stack supported at alternate floor levels.

The shipping sections are conveniently made in two story lengths for handling and hauling through city streets. The field splices are made of flange angles with the outstanding legs turned out so that the field rivets or bolts can be placed outside of the stack. Figure 82 is a drawing of a self-supporting stack.

19b. Stacks Supported by Floors.—Some designers prefer to use a stack supported at alternate floor levels. The supports commonly consist of brackets riveted to the stack and resting upon floor beams located conveniently for this purpose. Figure 83 shows a design of this type of stack.

An expansion joint is provided at each section and is made of a horizontal splice plate which is riveted to the lower end of the section and surrounds but does not connect to the lower section—thus, the expansion at each joint is the increase in length for one section.

Compared with a self-supporting stack, the stack supported at alternate floors contains less steel as the plates and connections are only computed for the dead load of one section which is equal in length to two stories.

This kind of stack has other advantages. The erection of the stack may be started at any floor level and no field riveting or bolting is required except for the bracket connections.

19c. Lining, Breeching, Etc.—Asbestos lining is usually provided inside of the stack to prevent excessive heating of the steel. The lining is about 2 in. in thickness and extends part way up the stack or for the entire height. The lining is supported by shelf angles spaced about 3 ft. apart. Angles $2\frac{1}{2} \times 1\frac{1}{2} \times \frac{1}{4}$ in. are often used for this purpose, the $1\frac{1}{2}$ -in. legs supporting the asbestos. Holes vertically over each other are punched in these legs to receive the dowels which hold the asbestos in place. The joints between the asbestos slabs are plastered, making the lining continuous.

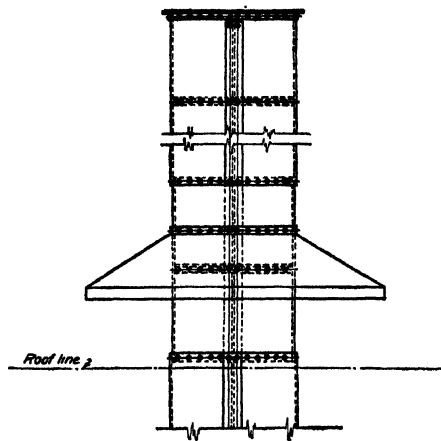

FIG. 84.—Stack hood at roof level.

The breeching is designed to meet the requirements of the heating contractor. Naturally the heating contractor determines the elevation and size of the breeching. Generally the breeching consists of a rectangular or square opening to the stack made of plates and angles riveted to the stack.

A clean-out door is placed near the base of the stack large enough to permit the entrance of a man. The door is made of a steel plate or cast-iron.

At the roof level, the stack cannot be rigidly connected to the roof on account of the expansion. A design of a hood is shown in Fig. 84 which is riveted to the stack directly above the roof and prevents the entrance of rain water.

STEEL MILL BUILDINGS

20. Mill Building Construction.

20a. Special Features.—The design of mill buildings has undergone a change in recent years, due to certain features which have been added to mill building construction—namely, steel sash, safety requirements, etc.

20b. Steel Sash.—Steel sash for windows are now extensively used in mill building design and have taken the place of wooden sash almost exclusively in high grade mill buildings, the main reason being due to the fact that they

are fireproof. The wooden sash requires a wooden frame to receive it, and this frame takes up so much space it excludes a great amount of light. The modern steel sash, requiring no other frame than the steel frame of the building, to which it is directly connected, has a great advantage over the wooden sash in the amount of light excluded. This same feature also holds true on Monitor skylight construction.

20c. Safety Requirements.—Provisions for the safety of the workman are receiving more attention at the present time than in former years from both the designer and those in charge of industrial establishments. Below will be found a few of the general rules established by the Committee of Safety of the United States Steel Corp. as given in their pamphlet "General Requirements for Safety Pertaining to Physical Condition."

New plants and mills should be planned so that there will be safe and convenient routes from plant entrances to places of work, bearing in mind future installations.

In the construction of buildings and designing and placing of machinery, the safety of the workman is equally as important as the production of the machine and economy of its operation. Leave ample clearance and provide passage ways for traffic and escape.

Standard clearances at least should be provided from railroad tracks.

Overhead walks or subways should be provided, if practicable, where tracks are usually blocked by cars, shop buggies, etc.

A walk running parallel with crane runway should be placed on all buildings wherever practical.

Lighting and ventilating buildings should be carefully considered, remembering that adverse weather conditions may require the complete enclosure of the building.

Sanitary installations should be provided at the time plans are made for new buildings.

21. Types of Buildings.—In determining the type of mill building to be used, there are a number of features which must be given careful consideration.

The amount of floor space required, the size of machinery to be installed, and the route the product is to take through the building will necessarily determine the size of building and also to a certain extent its shape—that is, these factors will determine whether the building will be one bay in width, or one bay with lean-to on one or both sides, or possibly two or three wide bays.

The weight and length of the material to be handled and the overhead clearance required for handling it will have an important bearing on the type of building to be used.

The arrangement of machines and material tracks with relation to overhead cranes must be given careful consideration to allow the material to be handled economically.

One of the most important features of a modern mill building is the arrangement of the windows and skylights to give the maximum amount of light, well distributed. For example, in a machine shop where precision measuring tools are used constantly at the machine, the light should be so distributed as to cast the minimum amount of shadows to allow these tools to be easily read by the workman. A notable example of a modern machine shop with the light well distributed is shown in Figs. 89 and 91.

The drainage of the roof of a building, especially a building with saw-tooth roof construction covering a large floor space, is often a difficult problem. If the floor

is covered with concrete or wood block, the roof should be drained to the outer walls and down spouts carried down outside of the building to prevent tearing up the floor in case the drains should become clogged.

If the roof covers too large an area to get the proper slope for draining to the outer walls it should then be drained both toward the outer walls and toward the center of the building and for that portion drained toward the center, the down

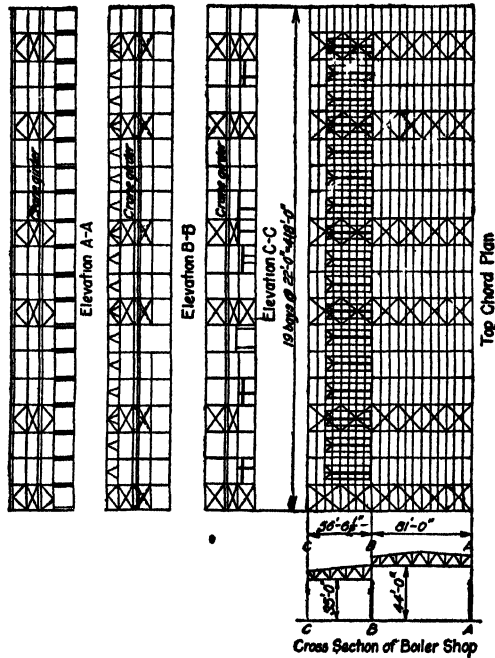

Fig. 85.—Locomotive boiler shop. Roof and column bracing.

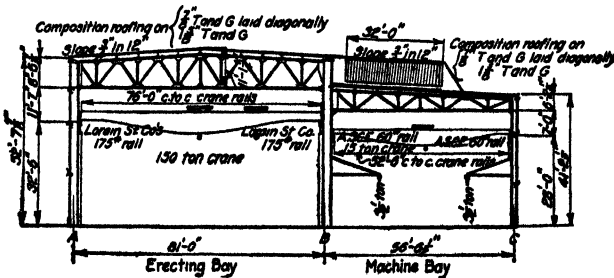

Fig. 86.—Section through locomotive boiler shop.

spout should be brought down inside the building and be carried along the roof trusses to the outside of the outer walls, then down outside of the building (see Fig. 95).

In cases where dirt floors are used it may simplify the roof construction to bring the down spouts down the columns near the center of the building and provide underground drainage to the outer walls of the building, thence to the sewer.

All of the features mentioned must be given careful consideration before the type of building to be used is finally determined.

The building shown in Figs. 85 and 86 is an assembling plant for a locomotive boiler shop. It consists of an erecting bay and a machine bay and is 418 ft. long.

The erecting bay measures 81 ft. center to center of columns and is spanned by a two-trolley crane of 150-ton capacity, which travels on 175-lb. Lorain Steel Company's heavy crane rails (see Fig. 102) for the full length of the building. The columns carrying the crane girders and roof trusses are spaced 22-ft. centers. There is a clear height under the roof trusses of 44 ft. above the floor line. The slope of the roof is $\frac{3}{4}$ in. in 12 in.

The roof is made up of 1 $\frac{5}{8}$ -in. plank laid transversely with the building, resting on channel purlins; on top of this planking is a layer of $\frac{3}{8}$ -in. tongued and grooved sheathing laid diagonally, on top of which is a composition roofing. The light for this bay is furnished through steel sash windows which extend full height of the outside wall (see Fig. 87) and through the steel sash skylight over the adjoining bay.

The machine bay is 56 ft. 6 $\frac{1}{2}$ in. center to center of columns and has a 15-ton crane running full length of the building. The

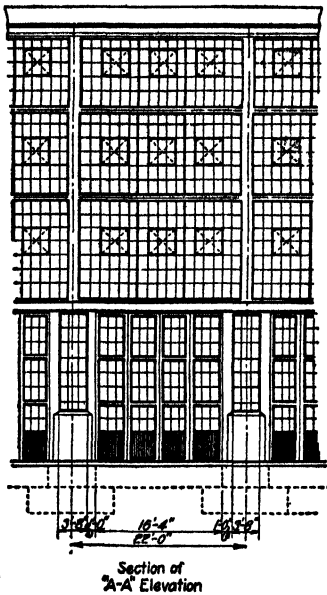

FIG. 87.—Locomotive boiler shop. Outside elevation showing windows and doors in side wall.

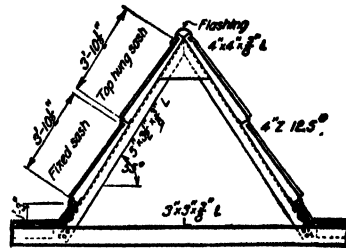

FIG. 88.—Section through skylight.

crane is carried on 60-lb. A.S.C.E. rails. There is a row of 3 $\frac{1}{2}$ -ton jib cranes down each side of this bay, connected directly to the columns. The columns carrying the crane girders and roof trusses are spaced 22 ft. centers, the same as in the erecting bay.

The clear height under the roof trusses is 35 ft. above the floor line. The roof has a slope of $\frac{3}{4}$ in. in 12 in. and the covering for that portion of the roof not covered by skylight is the same as used over the erecting bay.

There is a triangular-shaped skylight (see Fig. 88) running transversely with the building, over each panel of the machine bay except one panel at each end of the building. This skylight is 32 ft. in length, extending from the center line of columns (where it joins the roof over the erecting bay) toward the outside of the building. The frame is made up of angles having a slope of 55 deg. with the roof. This angle frame carries two lines of Z-bars and one line of angle purlins on each side of the skylight to which the steel sash is directly connected. The

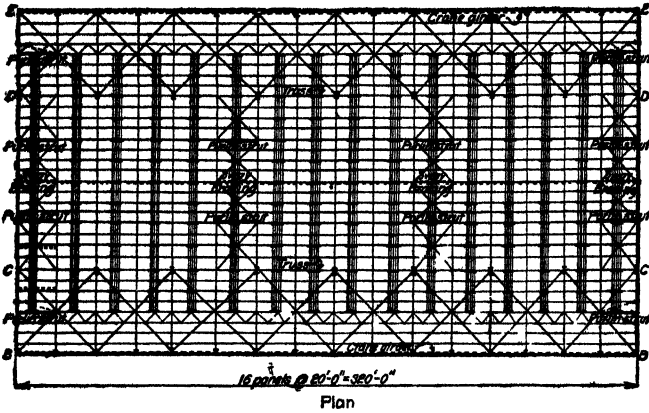

FIG. 89.—Machine shop Plan of skylights and roof bracing.

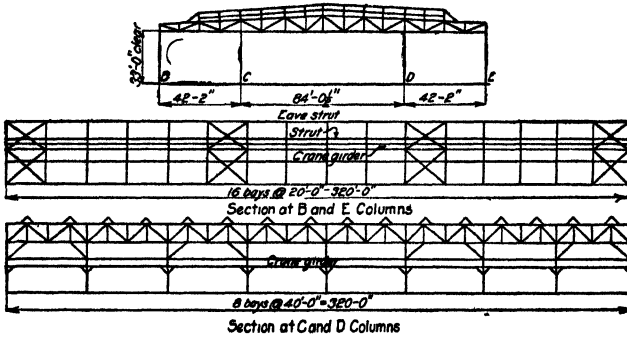

FIG. 90.—Longitudinal and transverse sections through machine shop shown in Fig. 91.

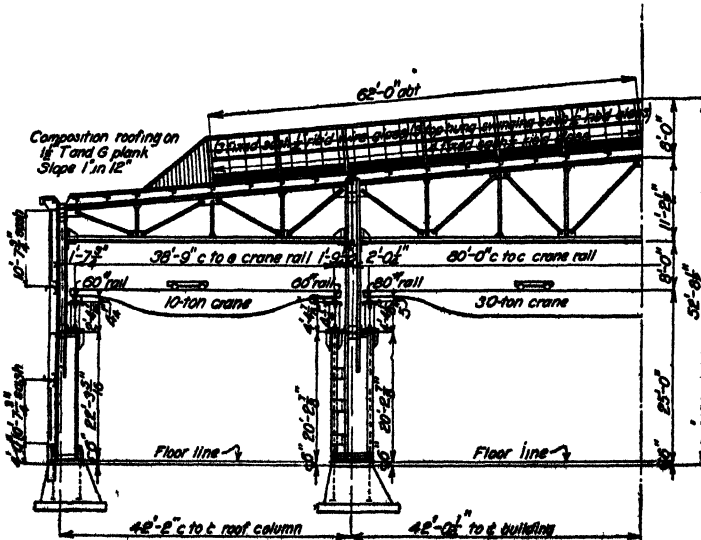

FIG. 91.—Machine shop. Cross-section showing capacity and elevation of cranes.

top row of sash on each side of the skylight is top hung sash 4 ft. in height and may be opened for ventilation. The bottom row is fixed.

Figures 89, 90 and 91 show a building which is similar in construction to the building shown in Figs. 85 and 86 except that a skylight is furnished over the wide center panel. The building shown in these three figures is a three bay machine shop 320 ft. long by 168 ft. 4½ in. center to center of outside columns, and was designed for heavy machine shop work. The largest machine in this building is an 80-in. lathe which is designed to swing a piece 60 ft. in length. The center bay is 84 ft. ½ in. center to center of columns and is spanned by a 30-ton crane which travels full length of the building on 80-lb. rails. The two outside bays are each 42 ft. 2 in. center to center of columns and are spanned by a 10-ton crane running on 60-lb. rails and traveling full length of the bay. The outside rows of columns are spaced 20 ft. center to center, while the columns on the two inside rows are spaced 40 ft. center to center to allow more clear floor space. The roof is made up of 1½-in. tongued and grooved sheathing, covered by a composition roofing, and has a slope of 1 in. in 12 in. The roof is supported by channel purlins.

The light for this building is furnished by windows in the outer walls, and skylights which are spaced 20 ft. center to center for the full length of the building. They run transversely across the building 62 ft. each way from the center line of the center bay, making the skylight 124 ft. in length. The construction of the skylights is similar to that shown in Fig. 88. There are two rows of steel sash windows in the outside walls, running completely around the buildings, each being 10 ft. 7¾ in. deep, as shown in Fig. 92, which covers a section through the two outer rows of columns.

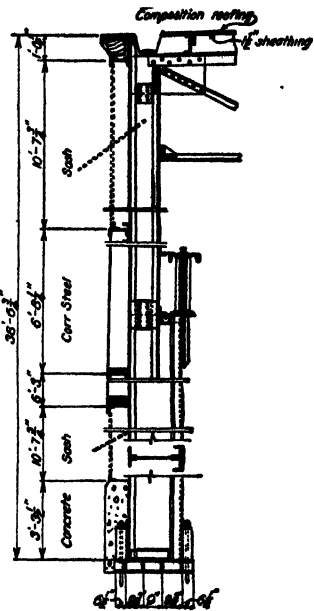

FIG. 92.—Section through outer wall of machine shop shown in Figs. 91, 92 and 93.

In Figs. 93 and 94 are shown sections through a three bay machine shop which has been designed to handle heavy work in the center bay, and light work in the lean-to bays. This building is 116 ft. center to center of outside columns in width by 612 ft. in length.

The center bay is 63 ft. 5½ in. center to center of columns and is spanned by a 50-ton crane, with the crane runway carrying 70-lb. rails, running full length of the building. There is a lean-to bay on each side of the main bay, each being 26 ft. 3¼ in. center to center of columns. There are two crane runways running full length of each lean-to on which are operated revolving cranes of 2-ton capacity. The crane runways for these 2-ton revolving cranes are shown, in detail, in Fig. 93.

Light is furnished through one row of windows in each outside wall of the lean-tos, and one row of windows in the interior wall, between top of the lean-to roof and the eave of the roof over the center bay. There is also a skylight covered with ¼-in. ribbed wire glass over the two center panels of the main roof truss, this

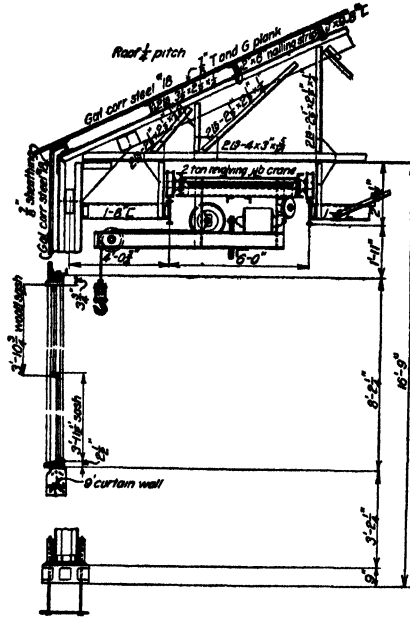

FIG. 93.—Machine shop lean-to. Showing revolving jib crane.

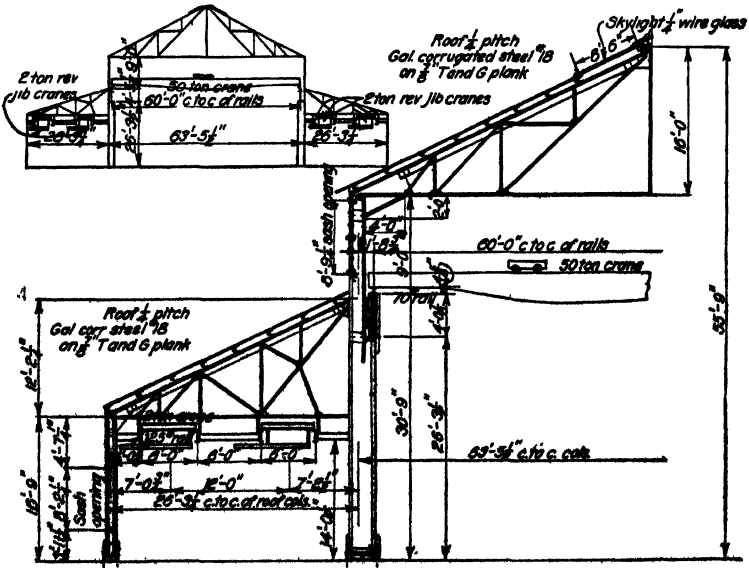

FIG. 94.—Machine shop. Cross-section.

skylight being in the same plane as the roof. The roof over both the main bay and the lean-to is $\frac{1}{4}$ pitch and is covered with No. 18 gage corrugated steel laid on $\frac{7}{8}$ -in. tongued and grooved boards, supported on channel purlins.

Figure 95 covers sections through the punching and assembling departments of one unit of a structural steel fabricating shop. (See p. 704, Vol. 65, *Eng. News-Record* for complete layout of this plant.)

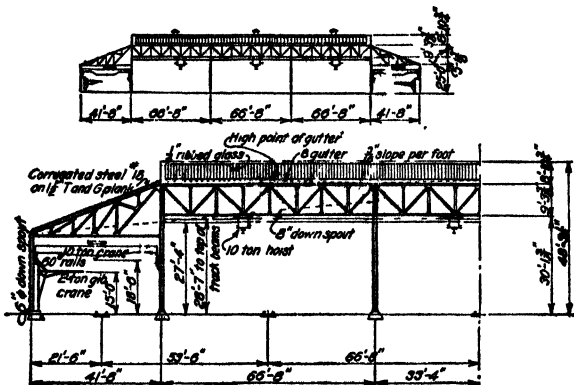

FIG. 95.—Structural steel fabricating shop. Transverse section through punching and assembling departments.

The building is 283 ft. 4 in. in width by 700 ft. in length. The three bays are each 66 ft. 8 in. center to center of columns with a 41 ft. 8 in. lean-to on each side of the main bays.

There are two lines of 10-ton hoists in each 100-ft. longitudinal panel of the main bays (see Fig. 96) running transversely across the buildings, and the supports for these hoists are arranged so they may travel full width of the three 66-ft.

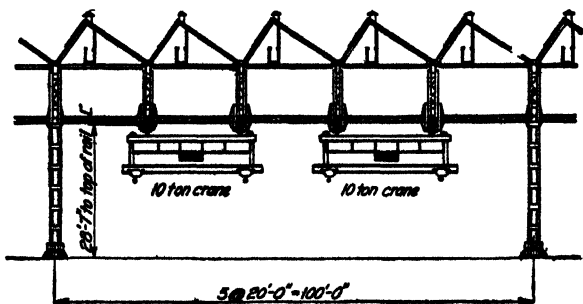

FIG. 96.—Structural steel fabricating shop. Longitudinal section through punching and assembling departments.

8-in. bays (except over the girder assembling bay where 80-ton hoists of similar design and arrangement are used).

In the lean-to there is a 10-ton crane traveling on 60-lb. rails, with 2-ton jib cranes connected to the columns in the outside walls.

All material during the course of fabrication travels from south to north and is handled longitudinally through the building on narrow gage tracks which slope 1

ft. down from south to north in the length of the building. All material in the main bays is handled transversely across the building by the hoists as there are no tracks in this direction.

This building receives light through two rows of windows in each of the outside walls of the lean-tos (see Fig. 97) and through the saw-tooth skylight roof construction (see Fig. 98) over the main bays.

The saw-tooth skylight truss has a span of 20 ft., making five skylights to each 100-ft. longitudinal bay (see Fig. 96) and the skylights run completely across the three 66-ft. 8-in. bays. There are three 30-in. tubular ventilators in each skylight, one in each of the 66-ft. 8-in. bays.

The roof of the southern slope of the saw-tooth skylight is made up of 1½-in. tongued and grooved plank, covered with No. 18 gage corrugated steel. This roof is supported on the top chord of the saw-tooth truss on which is laid a 2-in. nailing strip for fastening the roof planking. The skylight in the north slope of the saw-tooth is 6 ft. 7 in. deep and is made of ¼-in. ribbed glass supported in a wood frame. The saw-tooth trusses are spaced 10-ft. centers. There is a window cleaning walkway

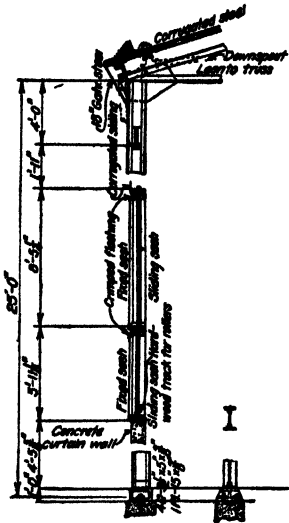

FIG. 97.—Section through lean-to wall. See Fig. 95.

full length of each skylight, being supported on the bottom chord of the saw-tooth trusses.

The roof over the lean-tos is made up of 1½-in. tongued and grooved plank on which is laid No. 18 gage corrugated steel.

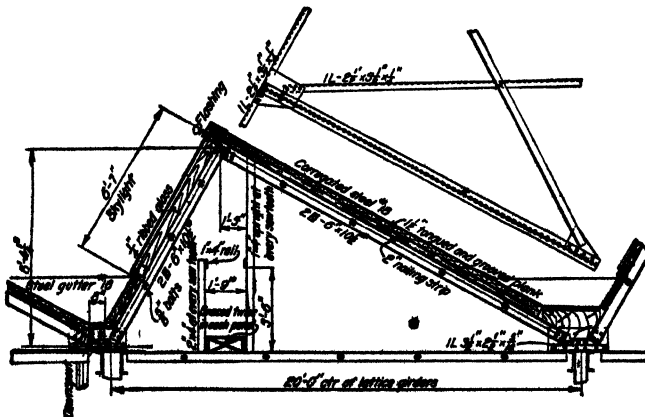

FIG. 98.—Section through saw-tooth skylight.

22. Columns.

22a. Types of Columns.—In designing a mill building column there are a number of things which must be considered before the type of column to be used is finally determined.

The length of the column and the loads it will carry are of course the main features in determining the make-up of the section of the column to be used. However, in determining this section, a type should be chosen that will allow good design to be used for the connections of the crane girders, crane girder bracing, roof trusses, window framing, wind bracing, etc. The following are a few of the sections which have been used for the main columns of mill buildings.

The plate and 4-angle column, shown in Fig. 97, is the most common type used for light mill building columns.

The T-shaped column section, shown in Fig. 99, is composed of a web plate and 4 angles for the stem of the "T" and to one flange of this is riveted another I-shaped section made of a web plate and 4 angles. If additional section is required, cover plates, or, as is sometimes done, a channel or I-beam may be riveted to flanges of these I-shaped sections. This makes an efficient column from the point of design and is simple to fabricate.

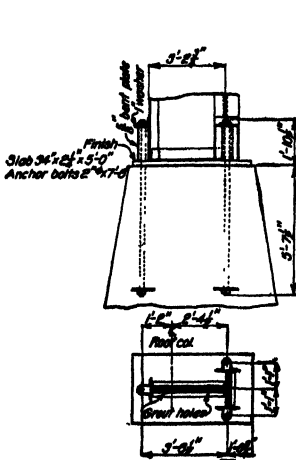

Fig. 99.—T-Shape column, base and anchorage.

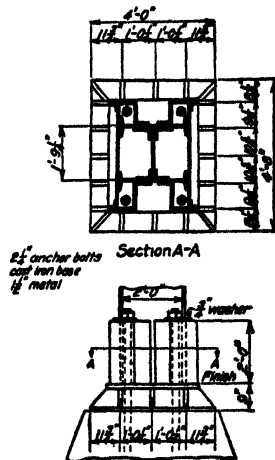

Fig. 100.—Column composed of two I-beams with diaphragm on cast-steel base.

The column shown in Fig. 100 is made up of a diaphragm, composed of a web plate and 4 angles, running full length of the column, to the flanges of which are riveted either an I-beam or a channel. This type of column was used for the 3 main bays for the building shown in Fig. 95.

22b. Column Bases.—Figures 97, 99 and 100 show designs of column bases used on buildings described in previous articles, those shown in Figs. 99 and 100 being designed to take uplift.

The base shown in Fig. 99 is very simple from a fabricating point of view. The plates through which the anchor bolts pass are bent "U" plates extending to the finished face at the bottom of the column and are finished on top before they are fitted to the column. The angle lug at top of this "U" plate, through which the anchor bolt passes, is brought to a bearing on the "U" plate before this material is riveted up in the shop. After riveting, the entire face of the column, including the bent "U" plates, is milled, thus insuring the proper bearing of the "U" plates on the slab.

The proper distribution of the column load over the masonry is provided for by placing a loose forged or cast-steel slab under the column instead of a cast pedestal. To set this slab, the masonry is brought up to within about 6 in. of the underside of the slab, then the slab is placed on narrow shims and set to the proper location and elevation, and grouted in place, large holes being provided in the slabs for pouring the grout. After the concrete is thoroughly set the erection of the columns may go forward without the usual delay due to shimming and leveling columns as experienced where the old method of grouting under the columns was used.

The column base shown in Fig. 100 is simple in design, as the number of detail pieces making up this base are very few. The uplift is carried to the anchor bolts through a horizontal plate washer bearing on top of a vertical plate bent in

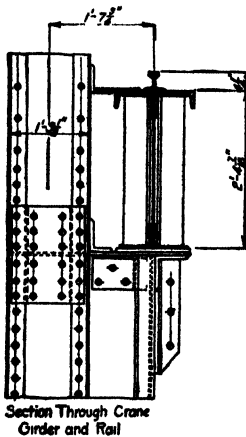

FIG. 101.—Section through crane girder and rail.

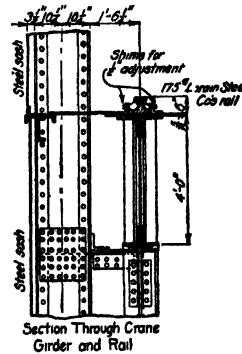

FIG. 102.—Section through crane girder and rail.

a "Z" shape, which plate is riveted to the column through the two flanges of the "Z." This detail allows the "Z" plates to be milled at the same operation as the milling of the main material of the column, thereby insuring a perfect bearing on the casting supporting the column.

22c. Crane Girder Seats.—The support for crane girders is usually taken care of by stopping one pair of flange angles of the main column section just below the bottom flange of the crane girder, as shown in Figs. 92, 101 and 102, although for light crane loads a bracket is sometimes riveted to the face of the column for supporting crane girders.

Where the crane girders rest on top of the column, the load from the crane girder is carried directly into the milled end of the column, and care should be taken to see that the end stiffeners on the crane girders are directly over either the main material on the column or stiffeners which have been added to the column for carrying this load.

If this is not possible, then a slab should be placed between the crane girder and the top of the column to distribute this load properly.

22d. Truss Connections to Columns.—Figures 103, 104 and 105 show the design of connections which are used for connecting roof trusses to columns.

The design shown in Fig. 104 should be used for light work only.

Figures 103 and 105 show the designs which are generally used for heavy work, as they give a much more rigid connection, and are capable of transmitting wind

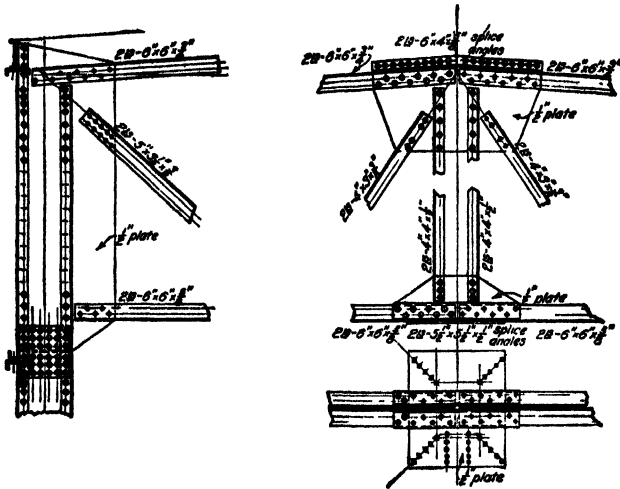

FIG. 103.—Roof truss details

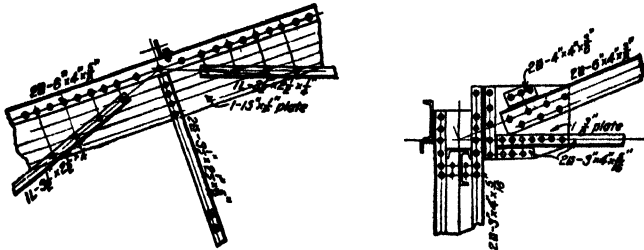

FIG. 104.—Roof truss details.

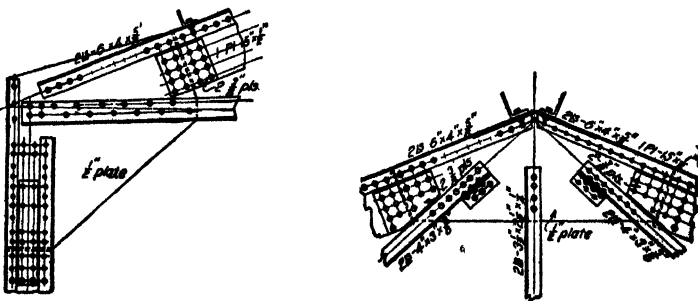

FIG. 105.—Roof truss details.

stresses better than the connection shown in Fig. 104. However, the design in Fig. 104 will give much easier erection than those shown in Figs. 103 and 105.

23. Roof Trusses.

23a. Form of Trusses.—The form of a roof truss is generally determined by the facilities furnished for lighting and by the kind of roof covering used.

For a gravel and tar roof, composition roof, or a tin roof with joints soldered, a very flat slope may be used, generally a slope about $\frac{3}{4}$ in. in 12 in. For a corrugated steel roof, the slope of the roof should preferably be $\frac{1}{4}$ pitch with a minimum of $\frac{1}{8}$ pitch. For a slate or tile roof the slope should not be greater than $\frac{1}{4}$ pitch and preferably not less than $\frac{1}{8}$. Figures 94, 95 and 98 show trusses designed for carrying corrugated steel roofs, while Figs. 86 and 91 show trusses on which a tar and gravel or a composition roof may be laid.

23b. Truss Details.—In determining the details of roof trusses, especially in cases of large duplication, care should be used to see that these details are as simple as possible. The use of an excessive number of small detail pieces should be avoided, for as a general rule the fewer number of pieces used in a connection, the more direct the stresses will be carried through this connection. The use of unnecessary lugs and cuts on plates and angles should also be avoided.

In splicing main members care should be taken to see that each component part of the member is spliced direct, and that no portion of the splice material is overstressed.

For the field connections, due consideration must be given the erector to see that the connections as designed will allow easy erection without an excessive number of field rivets.

The clips on the top chords of the roof trusses should be permanently bolted to the trusses in the shop. As the purlins are usually bolted to the clips in the field there is no reason why these clips should not be bolted to the trusses.

Figures 103, 104 and 105 show some truss details which have been used on mill building work, and which are typical of modern practice. These details are simple in design and allow for easy erection.

24. Crane Girders.—Crane girders are generally made up of either I-beams, or girders built up of a plate and 4 angles. In cases where girders are used for heavy crane loads the top edge of the web plate should be edge planed and flange angles set $\frac{1}{16}$ in. below the planed edge of the web plate to insure the crane load going directly into the web plate and not being carried through the flange rivets. This will prevent the flange rivets from becoming loose due to the constant hammer and vibration from the crane.

Lateral forces applied to the crane girder from the crane must be provided for. This can be done for light loads by either a wide cover plate or a channel riveted to the top flange of the crane girder (see Figs. 92 and 101). For heavy loads a horizontal girder will be necessary, running full length of, and connecting directly to the top flange of the crane girder, and connecting to the column at each end of the crane girder. The outside flange of this horizontal girder may also be used as a girt for carrying the side wall covering (see Fig. 102).

The crane girders should preferably be riveted to the columns and not bolted, except at the expansion points where bolts will necessarily be used. When bolts are necessary, they should be provided with castle nuts and split keys to prevent nuts from becoming loose on the bolts due to the vibration of the crane.

When the crane girder is not connected to the column by means of a horizontal girder, a connection should be provided to the column either by a horizontal connection in the plane of the top flange of the crane girder (see Fig. 101) or by a vertical connection between the end stiffeners of the crane girder and the main material of the roof column.

25. Crane Rails, Fastenings and Crane Stops.

25a. Rails.—In determining the size of crane rails for mill building crane runways, the designer should be careful to specify a size of rail that will be readily obtained from the mill. Usually the amount of tonnage involved for crane runway rails is small, and, if a section is not specified which is in common use, there will probably be a delay in securing these rails from the mill. If medium weight rails are desired, it is advisable to use either Standard A.S.C.E. or A.R.A. sections. If a heavy section is required, the Lorain Steel Company's 175-lb. rail, especially designed for heavy crane service, may be used.

To prevent creeping, the rail runs should be bolted or riveted to the crane girders at the center of each run with two or more bolts or rivets. This will leave the ends of the rail run free to move in either direction, but will prevent movement of the entire line as a unit. Standard angle splice bars should be used for splicing the rails of all crane runways.

Rails resting on girders should be fastened with either one or two bolt rail clips, and those resting on I-beams should be fastened by means of hook bolts passing through the webs of the rails and hooking over the flange of the I-beam.

25b. Rail Clips.—The functions of rail clips are: (1) To hold the rail against sidewise movement after alignment, and (2) to prevent the rail from overturning due to the action of lateral forces.

In performing these functions, the clip must allow a certain freedom of longitudinal movement of the rail to take care of temperature changes and the elongation of the rail, due to the rolling action of the crane wheels. The clips must also permit of transverse adjustment for alignment of the rails.

Due to the longitudinal movement of the rails, single bolt clips, clamped to the rail, are not satisfactory on long runways, as the clips turn on the bolts. In certain instances, under observation, the clips turned in such a way as to be practically useless until again adjusted.

The following rules should be observed when designing rail clips: One bolt connections are limited to runways for cranes up to 25 ton capacity; above 25 tons, two bolt connections should always be used.

Two bolt clips should be spaced about 3 ft. opposite. Single bolt clips should be spaced about 2 ft. 6 in. opposite.

Figure 106 shows two types of rail clips commonly used. The clip marked "A-1" is recommended for general use, as it will fulfill all requirements and has several advantages over the other type. As can be seen, this clip is also much cheaper to manufacture than the other clip.

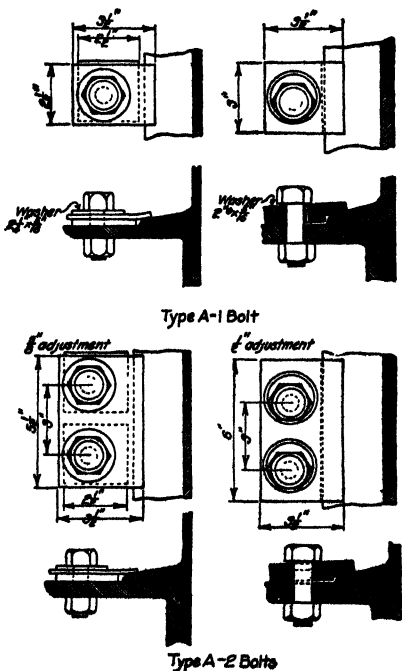

FIG. 106.—Rail clips.

25c. Fastenings for Heavy Crane Rails.—Figure 102 shows a type of rail fastening for use with the 175-lb. Lorain Steel Co.'s crane rail. This detail consists of an angle lug on each side of the rail with a cast-iron separator block between the web of the rail and the lug angles. There should be $\frac{1}{2}$ to $\frac{3}{4}$ -in. space between the separator blocks and the lug angles, and thin shim plates provided for this space to allow for sidewise adjustment of the crane rails.

The angle lugs and cast separator blocks should be long enough to take two bolts, and should be spaced 2 ft. 6 in. to 3-ft. centers.

Angles running full length of the crane girder may be used, if preferred, instead of the lug angles, and these angles used as part of the top flange section of the crane girders.

25d. Crane Stops.—Provision should be made at each end of each line of crane runway rails to stop the crane. This may be taken care of by a crane stop fastened either to the crane girder or beam or to the crane rail.

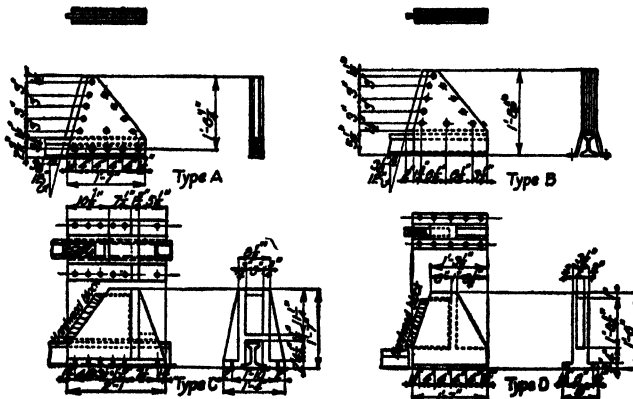

FIG. 107.—Crane stops.

At times, one end of the crane will creep ahead of the other end due to inaccuracies in the end truck wheels, causing the wheels to bind in the journal boxes. When this occurs, the crane operator is liable to square up his crane by bumping it against the crane stops. For this reason, crane stops should be made heavy and securely fastened.

It is preferable that the crane stops be fastened to the crane girder and not to the rails themselves, as the impact of the crane against the stop will cause the rails to creep if stops are fastened direct to rails. To provide for expansion, the rails must be cut a few inches in front of the stops or the crane stops designed to allow the rails to pass through them.

Figure 107 shows 4 types of crane stops in general use. Type "A" shows a stop, made of structural plates riveted together, which fastens directly to the web of the rail with bolts. This type is used mostly where the crane rails are carried on I-beams, where the top flange of the I-beam is not wide enough to allow the stop to be connected directly to it.

Type "B" shows a stop made up of structural plates similar to type "A" except the plates are bent around the rail and connected to the flange of the crane runway girder. This stop is a decided improvement over type "A" in that it

does not connect directly to the rail, thus preventing endwise movement of the rail when the crane strikes the stop.

Type "C" is the detail of a cast-steel stop with a hardwood bumping block inserted. It is connected directly to the flange of the girder and allows the rail free movement through the stop.

Type "D" shows a cast-steel stop riveted to the top flange of a crane girder on which the top flange is not wide enough to allow an opening in the stop large enough to allow the rail to pass through. In using this design the rail must be cut a few inches short of the crane stop to allow for expansion and creeping of the crane runway rail.

26. Bracing.—The bracing of a mill building should preferably be made of stiff members, avoiding the use of rods where possible as the rods are liable to work loose if there is any vibration in the building. It is also difficult to maintain the rods in proper adjustment.

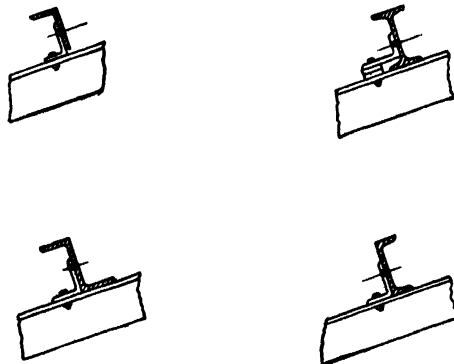

FIG. 108.—Purlins.

Stiff lateral members are generally made of single angles, or two angles riveted back to back. If the lateral is very long, it may be necessary to use either two or four angles laced to give greater depth to the members to avoid sagging.

Figures 85, 89, 90 and 98 show roof and column bracing for various types of construction.

Field connections for bracing may be bolted, except for very high buildings or for cases where the bracing receives excessive vibration, where it should be riveted.

27. Purlins and Girts.

27a. Purlins.—Purlins are usually made of channels, angles, tees or I-beams and connection to the top chord of the roof truss is made by means of an angle clip (see Fig. 108). The connection of the purlin to the angle and the angle to the roof truss should be bolted. The connection angles should be below the purlins where possible, since this provides for easy erection, as it gives the erector a shelf to rest his purlin against while he is distributing and connecting them.

In cases where the roof trusses are spaced too far apart to use channel or I-beam purlins it will be necessary to truss these members to carry the roof load.

It is sometimes necessary to provide $\frac{3}{4}$ -in. diameter rods through the web of the purlins to prevent sagging, the ridge purlin being made heavy enough to take care of this load.

27b. Girts.—Girts are generally made of a single channel or angle when the side walls are covered with corrugated steel, except where the girt may also act as a strut for the bracing. For this condition the girt may be made of a built-up section, several of which are shown in Fig. 109.

In cases where the girts support steel sash windows, the section of the girt must be made to accommodate the type of window used.



In Fig. 109 the girt is designed to carry the steel sash and also act as flange section for the horizontal girder, supporting the top flange of the adjacent crane girder.



Where wood sash windows are used with corrugated steel side walls between the windows, a channel girt laid with the web horizontal is generally used, the wood window frame being supported on the web of the channel girt (see Fig. 97).

Sag rods ($\frac{3}{4}$ -in. rounds) will be required to keep the single channel or angle girts from sagging when the panel length is greater than about 12 ft., sag rods to extend up to the eave strut which should be made heavy enough to take this extra load.

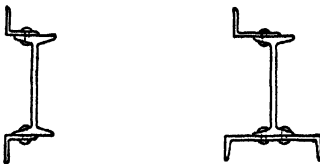

FIG. 109.—Girts.

28. Stairs, Platforms, Railings and Ladders.—Modern safety requirements for large industrial establishments are very rigid. Designers of mill buildings should

see that the workmen are properly safeguarded by the installation of the necessary stairways, platforms, railings and ladders.

These features should be taken care of in the original design of the building and not be added as an afterthought, as considerable delay and expense may be caused to the builders if the work is well advanced when these features are added.

The United States Steel Corp. is governed by the following general rules in the design of stairs, platforms, railings and ladders. In looking over these rules the designer will realize the importance this large corporation attaches to these safety features for its workmen:

Platforms and Walkways.—Platforms and walkways should be provided wherever regular duties require an employee to ascend to, or go into, places where injury could result from falls or contact with moving parts or other objects. Platforms or walkways should be reached by stairways or stationary ladders; preferably stairways.

Railings and Toe-boards. (1) *General.*—Railings should preferably be of structural steel shapes, although in the better class of buildings, such as power houses and machine shops, pipe railings may be used where not exposed to moisture or gases. Wood railings should not be used except to afford temporary protection.

(2) *Railings and Toe-boards for Platforms and Walkways.*—Railings should be 42 in. in height and provided with an intermediate rail between the top rail and the floor.

Dimensions of various types of railings should be not less than the following:

STRUCTURAL STEEL SHAPES

Top rail.....	3 × 2½ × 5⅛-in. angle.
Intermediate rail.....	2½ × 2 × 5⅛-in. angle.
Posts.....	2½ × 2½ × 3⅝-in. angle.
Toe-board.....	6 in. high—6 × 3 × 5⅛-in. angle.
Spacing of posts.....	not more than 8 ft. apart.

PIPE CONSTRUCTION

Type.....	Special fittings for railings. Preferably all members should be properly fitted and pinned, avoiding the use of threaded connections.
Size.....	All members 1½ in. inside diameter.
Toe-board.....	6 in. high—6 × 3⅝-in. flat.
Spacing of posts.....	Not more than 8 ft. apart.

WOOD CONSTRUCTION

Top rail.....	2 in. × 4 in. (dressed)
Intermediate rail.....	1 in. × 4 in. (dressed)
Posts.....	2 in. × 4 in. (dressed)
Toe-boards.....	1 in. × 6 in.
Spacing of posts.....	Not more than 8 ft. apart.

Railings and Toe-board, for Stairways (see Figs. 110 and 111).—Railings and toe-boards for stairways should be the same size as railings and toe-boards for platforms and walkways, except the height of toe-boards for intermediate landings which may be 5 in.

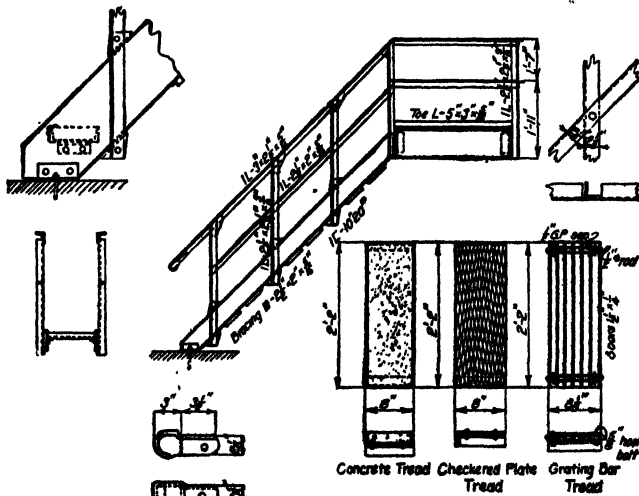

FIG. 110.—Stairs with angle hand rail.

Stairway hand-railings should have a smooth finish. Rough edges and sharp corners should be removed in the shop. Any remaining after erection should be chipped or filed.

Railings should be provided on each flight of stairs as follows:

- (a) On all open sides.
- (b) On one side of enclosed stairways 4 ft. or less in width, preferably on both sides.
- (c) On both sides of enclosed stairways over 4 ft. in width.
- (d) On both sides and in center of stairways over 8 ft. in width.

All intermediate landings should be provided with a toe-board or other inclosure in addition to hand-rail.

Stairways. (1) *General.*—Stairways should be used wherever practical, in place of ladders. The following general rules should govern their design:

(a) There should be uniformity of angle for all stairways in so far as practical.

(b) They should preferably be designed between the angle of 20 and 50 deg.

(c) For a grade of less than 20 deg. an incline, or ramp, is preferable.

(d) An angle of 50 deg. to the horizontal is considered maximum for safety for stairways. Stairways of a slope this steep should be used only for short flights. Where a continuous flight requires an angle as great as 50 deg. it should be overcome by breaking the flight and reversing the direction.

(e) Long flights should be avoided by the provision of intermediate landings.

(f) Spiral stairways should not be substituted for regular stairways where practical to install the latter.

(g) Where stairways with open risers pass over alleys, walkways, door openings to buildings, etc., a protecting plate should be placed on the under side of the stair stringers.

(2) *Dimensions of Stairs.*—Minimum width of stairways should be 27 in.

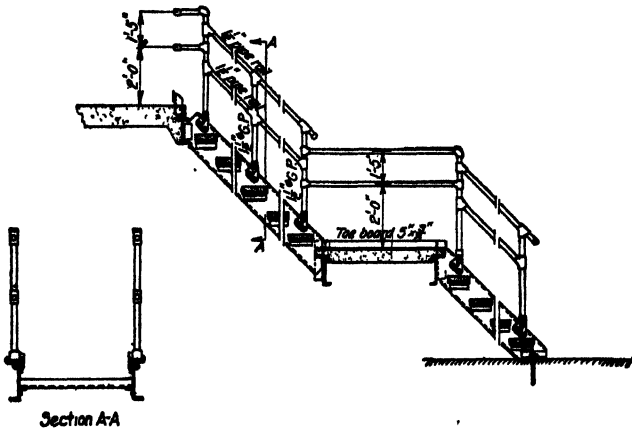

FIG. 111.—Stairs with gas pipe hand rail.

The width of intermediate landings should be proportional to a multiple of the natural pace—approximately 25 in.

(3) *Risers and Treads.*—All risers and treads in the same flight of stairs shall have uniform dimensions.

No tread shall be under-cut more than one-third its width.

When the nosing of the tread is rounded, the radius should not exceed $\frac{3}{8}$ in.

Treads should have anti-slip surfaces. (The inverted channel filled with cement and surfaced with carborundum chips is recommended.)

(4) *Doors and Gates.*—No door or gate should extend over the top riser when open full width, nor should it be nearer the top riser than the width of three treads.

(5) *Ramps.*—Anti-slip surfaces should be provided for ramps.

Dimensions for Stair Treads and Risers.—Stairways should preferably be restricted to the four slopes shown in the following table except when flatter slopes are desirable. This is sometimes the case for entrance stairs that are used by a large number of people. While an angle of 50 deg. to the horizontal is considered maximum for safety it is desirable that stairways should not be built at a greater inclination than 45 deg.

In designing a stairway the slope which best fits the condition should be used. *The preferable rise and treads are underscored.* It is seldom necessary that the horizontal run of stairs should conform to an exact figure. A slight variation will do no harm, thus allowing a standard tread to be used. All risers for a flight of stairs should be the same height and this height should be maintained wherever possible in adjacent stairways. No stairway

should be more than 24 risers in height. Intermediate landings should be introduced where height is excessive.

Slope $9\frac{3}{8}$ in. in 1 ft. 0 in. = $38^{\circ} 40'$		Slope $10\frac{1}{16}$ in. in 1 ft. 0 in. = $40^{\circ} 58'$		Slope $11\frac{1}{16}$ in. in 1 ft. 0 in. = $43^{\circ} 22'$		Slope 12 in. in 1 ft. 0 in. = 45°	
Rise (in.)	Tread (in.)	Rise (in.)	Tread (in.)	Rise (in.)	Tread (in.)	Rise (in.)	Tread (in.)
$8\frac{3}{8}$	$10\frac{1}{8}$	$8\frac{3}{8}$	$9\frac{3}{8}$	$8\frac{3}{4}$	$9\frac{1}{4}$	$8\frac{3}{4}$	$8\frac{3}{4}$
8	10	$8\frac{1}{4}$	$9\frac{1}{2}$	$8\frac{5}{8}$	$9\frac{1}{8}$	$8\frac{5}{8}$	$8\frac{5}{8}$
$7\frac{7}{8}$	$9\frac{3}{8}$	$8\frac{1}{8}$	$9\frac{5}{8}$	$8\frac{1}{2}$	9	$8\frac{1}{2}$	$8\frac{1}{2}$
$7\frac{3}{4}$	$9\frac{1}{16}$	8	$9\frac{3}{16}$	$8\frac{3}{8}$	$8\frac{7}{8}$	$8\frac{3}{8}$	$8\frac{3}{8}$
$7\frac{5}{8}$	$9\frac{1}{2}$	$7\frac{7}{8}$	$9\frac{1}{16}$	$8\frac{1}{4}$	$8\frac{3}{4}$	$8\frac{1}{4}$	$8\frac{1}{4}$

Stationary Ladders. (1) *General.*—Ladders should be avoided where the use of well-constructed stairways is practical.

Steel construction should be used. Wood construction should not be used except as a temporary installation or in places where steel may be disintegrated by gases or fumes.

The pitch of a ladder should not be such that the position of a person is necessarily below the ladder when climbing.

Back Clearance.—Back of rung to nearest permanent object back of ladder not less than 8 in.

Front Clearance.—No obstruction less than 30 in. except where safety cages are applied.

Side Clearance.—15 in. from center on either side of ladder.

Outside ladders should extend at least 45 in. above landing, preferably being goose necked, or bridged. Rungs should be omitted above landing. A platform should be provided where a person must step a greater distance than 18 in. from ladder to roof, tank, etc.

High ladders with the possible exception of fire ladders should be divided into short lengths, placing landings every 20 ft.

Safety cages should be placed on ladders that are 20 ft. or more in height.

(2) *Steel Construction.*

Size of Rails.—Not less than $\frac{3}{4}$ sq. in. cross-section ($2 \times \frac{3}{8}$ in. recommended).

Space of Side Rails.—16 to 24 in. apart, using as a standard the width most common, if between these limits.

Splice Plates.—Same size as material for side rails; should be on outside of side rails and double riveted or bolted. The rivets or bolts should be countersunk on inside and should be not less than $\frac{1}{2}$ in. or more than $\frac{5}{8}$ in. in diameter, where cross-section does not exceed that of $2 \times \frac{3}{8}$. Length of splice plates should be 4 times the width.

Rungs.—Not less than $\frac{3}{4}$ in. diameter and fastened so as to prevent turning.

Spacing of Rungs.—12 in. center to center.

Fastenings.—Metal equivalent to side rails in strength. Fastenings should be made to permanent structure by rivets, by building in, or by through bolts or expansion bolts grouted or leaded. Fastenings should not be more than 10 ft. apart.

29. Stacks.—It is often necessary, due to the arrangement of outside crane runways, railroad tracks, etc., to eliminate the use of guy lines in supporting a stack which is located in the midst of a group of mill buildings. Figure 112 shows a 90-ft. stack which has been designed with this idea in mind. This stack is supported at its base on a large circular steel casting which is securely anchored to the masonry by anchor bolts which are extended far enough into the masonry

to engage a mass heavy enough to prevent the overturning of the stack due to wind forces. The lower portion of the stack is made cone-shaped to give the proper width at the base and is fastened to the steel base casting with enough rivets to carry the complete load of the stack. The cone-shaped portion of the stack was made with the plates laid with shingle lap joints, while the cylindrical portion is shown with in and out lap joints. However, the cylindrical portion may also be made with the plates laid shingle joints if desired. A ladder should be furnished on all stacks, same to be provided with a safety cage running for the

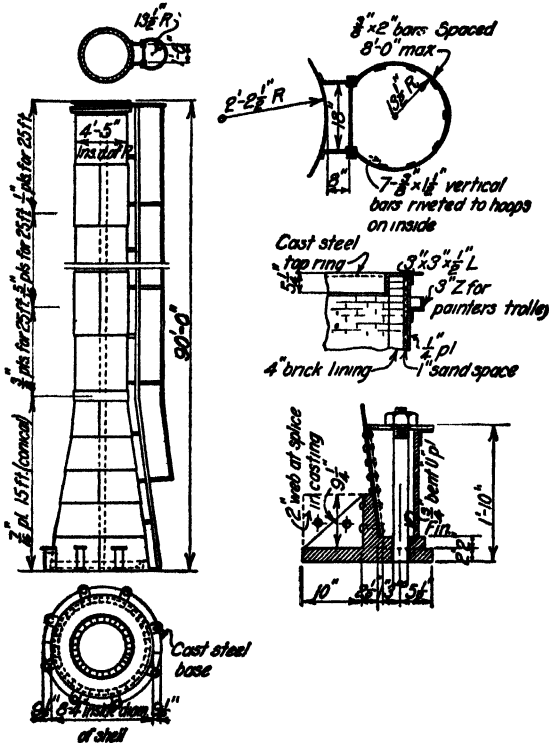

FIG. 112.—Self-supporting stack.

full height of the stack. There should be a cast-steel ring completely around the top edge of the stack. There should be a trolley runway provided completely around the stack at the top to receive the painters' trolley used in painting.

The stack shown was provided with a lining of 4 in. of brick, with a layer of sand 1 in. thick between the brick and the steel shell.

30. Corrugated Steel.—Corrugated steel sheets are used for the sides and roofs of mill and factory buildings. The sheets are laid directly upon the purlins or girts and are fastened to them by methods shown on following pages.

The sizes and weights of corrugated sheets can be obtained from the handbook of any manufacturer of sheet steel. The standard lengths of sheets are 5, 6, 7, 8, 9 and 10 ft. The maximum length is 12 ft. The standard covering width per sheet is 24 in.

The standard thicknesses and weights for black and galvanized sheet metal are given in Table 8. The maximum span between supports is also given in the same table.

TABLE 8

Gage U.S. standard	Thick-ness (in.)	Per-missible variation + or - per cent of weight	Flat sheets (lb. per sq. ft.)		2½- and 3-in. corrugations					
					26-in. sheets (lb. per sq. ft.)		27½-in. sheets (lb. per sq. ft.)		Maximum span between supports	
			Galv.	Black	Galv.	Black	Galv.	Black	Galv.	Black
12	0.107	5.0	4 53	4.38	4.88	4.71	4.94	4.77	5'9"	5'10"
14	0.077	5.0	3 28	3.13	3.53	3.37	3.58	3.41	5'9"	5'10"
16	0.061	5.0	2.66	2.50	2.86	2.69	2.90	2.73	5'9"	5'10"
18	0.049	3.5	2.16	2.00	2.32	2.15	2.35	2.18	5'9"	5'10"
20	0.037	3.5	1.66	1.50	1.78	1.62	1.81	1.64	5'9"	5'10"
21	0.034	3.5	1.53	1.38	1.65	1.48	1.67	1.50	5'9"	5'10"
22	0.031	3.5	1.41	1.25	1.51	1.35	1.53	1.36	4'9"	5'10"
23	0.028	2.5	1.28	1.13	1.38	1.21	1.40	1.23	4'9"	5'10"
24	0.025	2.5	1.16	1.00	1.25	1.08	1.26	1.09	3'9"	4'10"
25	0.021	2.5	1.03	0.88	1.11	0.94	1.13	0.96	3'9"	4'10"
26	0.018	2.5	0.91	0.75	0.98	0.81	0.99	0.82	2'9"	3'10"
28	0.015	2.5	0.78	0.63	0.84	0.67	0.85	0.68	2'9"	3'10"

Experiments have determined that corrugated sheet steel ⅝ in. deep and No. 20 gage, spanning 6 ft., will begin to give a permanent deflection with a load of 30 lb. per sq. ft. and will collapse under a load of 60 lb. per sq. ft. The distance between centers of purlins, therefore, should not exceed 6 ft. The common spacing is 4 to 5 ft. Since the corrugated steel on the sides of a building is subject only to wind load the girts may be spaced farther apart.

The uniformly distributed safe load of corrugated sheets may be obtained approximately from the formula given below:

W = total allowable uniform load, in pounds.

b = curvilinear width of sheet in inches ($b = 1.075 \times$ covering width).

l = span length, in inches.

t = thickness of sheet, in inches.

d = depth of corrugation, in inches.

f = allowable fiber stress, in pounds per square inch.

Then

$$W = \frac{8fs}{l} = \frac{8f}{l} \cdot \frac{4bd}{15} = \frac{32fbd}{15l}$$

for

$$f = 12,000 \quad W = \frac{25,600bd}{l}$$

31. Roofing and Siding of Corrugated Steel.—Roofing is made from flat sheets 30 in. wide, each having 9 corrugations $2\frac{3}{8}$ in. wide by $\frac{1}{2}$ in. deep or 8 corrugations 3 in. wide by $\frac{3}{16}$ in. deep, one edge of sheet turning up and the other turning down. The sheets after corrugating are $27\frac{1}{2}$ in. wide. They are laid with a side lap of $1\frac{1}{2}$ corrugations and cover approximately 24 in. net width.

Siding is made from flat sheets 28 in. wide, each having 9 corrugations $2\frac{3}{8}$ in. wide by $\frac{1}{2}$ in. deep or 8 corrugations 3 in. wide by $\frac{3}{16}$ in. deep, with both edges of sheet turning the same way. The sheets after corrugating are 26 in. wide. They are laid with a side lap of one corrugation and cover approximately 24 in. net width.

For export work, roofing and siding are frequently furnished with 3-in. corrugations and in 32-in. widths, covering 27 in. net when laid with 2 corrugations side lap and 30 in. net with 1 corrugation side lap.

For roofing the sheets should have an end lap of not less than 6 in. and for siding not less than 4 in. All sheets should splice with end laps over purlins or girts.

For siding it is customary to specify sheets two gages lighter than for roofing. Thus if No. 20 is specified for roofing, No. 22 is generally used for siding.

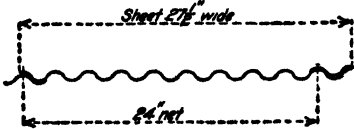

FIG. 113.—Roofing.

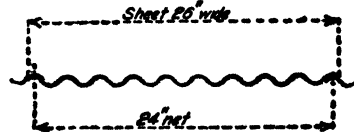

FIG. 114.—Siding.

Standard widths for corrugated sheeting should be adhered to and standard lengths as far as practicable. When sizes of sheets are affected by window and door openings, skylights, stacks, etc., requiring widths and lengths not standard, standard sheets should be ordered to be cut in the field, unless sheets of special sizes occur in large numbers, in which case sheets should be ordered exact length. When ordering sheets for gable ends, one sheet should be ordered to make two pieces, thus saving all waste and one extra cut.

In ordering corrugated sheeting net widths given above should be used and 2 per cent added.

Purlins and girts should be so arranged that sheets span two spaces. In all cases purlins and girts should be perpendicular to the run of corrugations.

32. Flashing for Corrugated Steel.—Flashing is used to cover openings in the corrugated steel around doors and windows, at eaves, at valleys, in roofs, around stacks, etc. The flashing can be obtained either flat or corrugated and is usually the same gage as the siding. Flashing can be obtained in the following extreme sizes: 16 and 18 gage, 54×168 in.; 20 and 22 gage, 48×120 in.; 24 gage, 48×108 in.; 26 and 27 gage, 42×120 in.

As a rule flashing is sent to the field bent to the proper shape required on the structure. Certain pieces with easy bends may be sent to the field flat, to be bent by the erector. However, the amount of bending done in the field will depend to a certain extent upon the conditions of the contract.

Flashing is fastened to the roofing or siding with $\frac{3}{16}$ -in. soft iron closing rivets, spaced about 6 in. apart. The flashing should lap over the corrugated steel at

least 3 in. Various flashing details are shown in Figs. 122 to 131 inclusive, and Fig. 133.

33. Ridge Roll.—The ridge roll in most common use is made from No. 26 gage although it may be the same gage as the roofing. The roll is $2\frac{1}{2}$ in. in diameter and has 6-in. aprons. The standard length is 8 ft. End laps should be 3 in. The ridge roll may be either plain or corrugated. Plain ridge caps are also used (see Fig. 115).

The ridge roll is fastened to the roofing with closing rivets spaced 6 in. apart.

34. Fastenings for Corrugated Steel.—Galvanized steel fastenings are usually more readily obtained than black fastenings. Consequently it is customary to furnish galvanized fastenings with all corrugated steel, either black or galvanized, except on very large orders, when the material in the fastenings should be the same as the sheeting. Corrugated steel is fastened to the girts and purlins by one of the following methods:

34a. Clinch Rivets.—Clinch rivets are made of No. 8 wire and have heads curved to fit the corrugations. They pass through the sheeting and clinch

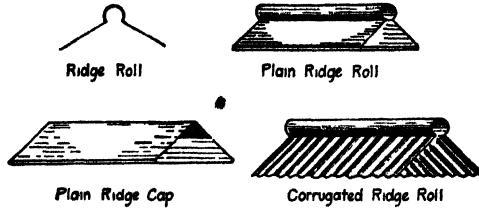

FIG. 115.—Ridge roll.

around the outstanding legs of the angles or flanges of channels. The girts and purlins should be arranged with backs up, to provide bearing for the clinch rivets. The clinch rivets should be of sufficient lengths to allow at least 1 in. of the rivets beyond the final bend.

In fastening corrugated sheeting with clinch rivets, care should be taken that the head of the rivets is driven to a bearing at the top of the corrugation and that the rivets are tightly drawn, holding the sheeting to a bearing against the girt or purlin and the rivets solidly clinched while held in this position.

Clinch rivets for angle girts are of the following lengths and weights:

(Weights are for galvanized rivets.) (Allow one clinch rivet for each 8 in. of girt and add 10 per cent for waste.)

O.S. leg of angle (in.)	2	$2\frac{1}{2}$ -3	$3\frac{1}{2}$ -4	5	6								
Length of rivet (in.)	4	5	6	7	8	9	10	11	12				
Number per pound	62	50	39	36	34	29	27	26	22				

Various details showing the use of clinch rivets are shown in Fig. 116.

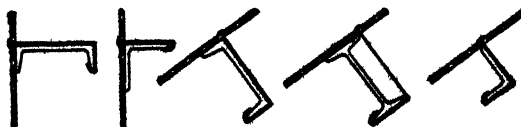

FIG. 116.—Clinch rivets.

34b. Straps.—Straps are made of No. 18 or No. 20 gage steel, $\frac{3}{4}$ in. wide, and are attached to the sheeting by closing rivets.

The following table shows lengths of straps required for various size purlins:

Size of purlin (in.).....	5	6	7	8	9	10	12
Length of strap (in.).....	15	17	19	22	24	26	31

Allow one strap and two rivets for each lineal foot of girt or purlin to which the sheeting is to be fastened and add 10 per cent to the number of straps and 20 per cent to the number of rivets. Straps should be ordered in bundles to be cut and bent in the field. One bundle weighs 50 lb. and contains 400 lin. ft.

Various details showing the use of straps are shown in Fig. 117.

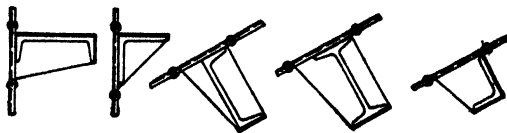

FIG. 117.—Straps.

34c. Clips.—Clips are made of No. 16 gage steel $1\frac{1}{2}$ in. wide by $2\frac{1}{2}$ in. long and are slightly crimped to fit the flanges of the girts. They are fastened to the siding or roofing with bolts made of No. 10 wire, one bolt per clip. The bolts have curved heads to fit over the corrugations and are 1 in. long except for special cases.

Clips do not make as desirable fastenings as straps or clinch rivets and should be used only where the other fastenings will not apply, such as at tops of doors, tops and bottoms of windows, shutters, etc.

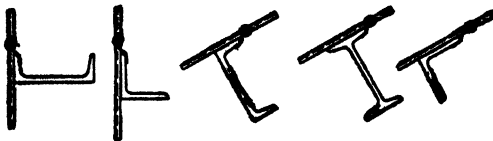

FIG. 118.—Clips.

Allow one clip and bolt for each 8 in. of girt and add 10 per cent for waste.

Various details showing the use of clips are shown in Fig. 118.

34d. Wood Nailers.—When wood nailing pieces are used, they are bolted to the purlins or girts and the sheeting is nailed to the wood with “corrugated steel nails.” The nailing pieces are 2×4 s or 2×6 s (Fig. 119).

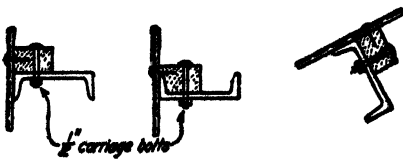

FIG. 119.—Wood nailers.

Allow one nail for each lineal foot of girt or purlin and allow 20 per cent for waste. Nails should be 3 in. long for roofing and $2\frac{1}{2}$ in. long for siding.

34e. Closing Rivets.—Closing rivets, besides being used for fastening straps, are used for fastening the side laps, flashing, ridge roll, etc. They are $\frac{3}{16}$ in. in diameter and of the following lengths (weights are for galvanized rivets):

Length (in.).....	$\frac{3}{8}$	$\frac{1}{2}$	$\frac{5}{8}$	$\frac{3}{4}$
No. per lb.....	200	166	142	125

Rivets $\frac{3}{8}$ in. long are sufficient for three thicknesses of sheeting. A few rivets $\frac{1}{2}$ in. long should be ordered for grips of more than 3 thicknesses.

For roofing, the closing rivets are spaced 16 in. apart in the side laps and 6 to 8 in. apart in the end laps. Where straps are used, each alternate rivet in the end laps is to be a strap rivet.

For siding, the closing rivets are spaced 24 in. apart in the side laps. No rivets are required in the end laps outside of the regular girt fastenings.

For ridge roll, flashing, cornice, etc., order one rivet for each 6 in. of seam.

Allow 20 per cent for waste in all cases.

34f. Nails.—"Corrugated steel nails" are of a special kind with heads curved to fit the corrugations. They are used for fastening corrugated sheeting to wooden sheathing or nailing pieces on girts or purlins.

Where sheeting is to be attached to wooden nailing pieces, allow one nail for each foot of girt or purlin. The nails should be 3 in. long for roofing and $2\frac{1}{2}$ in. long for siding.

Where sheeting is to be attached to wooden sheathing, the nails are spaced 1 ft. apart in end and side laps, and 1 ft. apart in the body of the sheets in lines 3 or 4 ft. apart, the same as if girts or purlins were used. The nails should be 2 in. long for 1-in. sheathing and $2\frac{1}{2}$ in. long for sheathing $1\frac{1}{4}$ in. thick and over.

The following table gives the weights of galvanized "corrugated steel nails":

Length (in.).....	$1\frac{1}{2}$	2	$2\frac{1}{2}$	$3\frac{1}{4}$
No. per lb.....	150	139	111	83

For nailing flashing to wood use "barbed roofing nails" $1\frac{1}{4}$ in. long. Allow one nail for each 6 in. of seam.

Sizes and weights of barbed roofing nails are given in the following table. These nails are designated by length and not by "penny":

Length (in.).....	$\frac{3}{4}$	$\frac{7}{8}$	1	$1\frac{1}{8}$	$1\frac{1}{4}$	$1\frac{3}{8}$	$1\frac{1}{2}$	$1\frac{3}{4}$
No. per lb.....	714	469	411	365	251	230	176	151

34g. Finish at Doors and Windows.—Corrugated sheeting should be attached to door and window jambs and headers with $\frac{1}{4}$ or $\frac{3}{8}$ -in. round head stove bolts spaced 12 in. center to center. A bar $1\frac{1}{2}$ to 2 in. wide by $\frac{1}{8}$ to $\frac{1}{4}$ in. thick is usually provided for the outside finish (see Fig. 132).



FIG. 120.

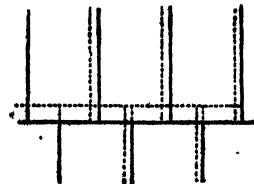

FIG. 121.

34h. Miscellaneous Fastening Details.—All rivets, clinch rivets and bolts should pass through top of corrugations, as shown in Fig. 120.

Corrugated sheets should always be laid with broken joints, as shown in Fig. 121 and interlapping corners should be riveted where side and end laps cross.

In Figs. 122, 123 and 124 are shown corrugated steel details for a machine shop for the American Bridge Co.

Figures 125 to 132 inclusive show miscellaneous fastening and flashing details. Figure 133 shows details of flashing for a steel stack.

35. Curtain Walls.—Curtain walls are low walls of concrete extending around the exterior of mill buildings with corrugated steel side walls. Their purpose is to provide a finish for the siding above the ground to prevent corrosion of the steel siding, and also to add to the warmth of the building by preventing the cold air from entering beneath the siding. In buildings with windows a few feet above the ground, the curtain walls are usually carried up to the under side of the windows.

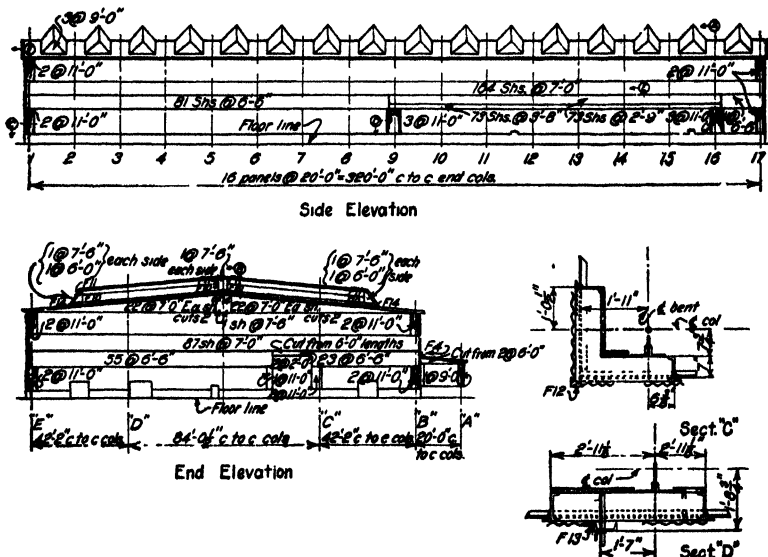

FIG. 122.—Corrugated steel plans for a machine shop (American Bridge Co.).

The piers under the side wall columns are notched to form a bond between curtain wall and pier.

Figure 134 shows common types of finish at top of curtain walls.

36. Ventilators.—Mill buildings are ventilated either by forced draft or natural ventilation, the latter usually being sufficient. This article will consider natural ventilation only.

The amount of ventilation required will depend largely upon the use to which the building is put. Open hearth buildings, and buildings that contain various kinds of furnaces will require more ventilating area than machine shops, assembling plants, etc., which produce practically no heat or smoke. High buildings will require fewer outlets for ventilation than will low ones.

36a. Monitor Ventilators.—The openings in the sides of monitors may be fitted with louvres, shutters, sliding or pivoted sash, or left entirely open. The latter practice is common in open hearth and other mill buildings generating a large amount of heat. In this type of building it is also customary to have slid-

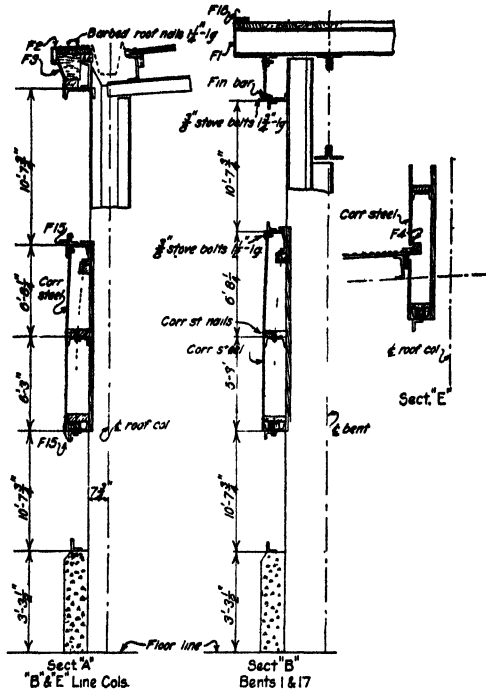

FIG. 123.—Corrugated steel details for machine shop shown in Fig. 122.

List of Flashing			
No. Pcs.	Section	Location	Ref. Mark
32	30 mesh	Cornice main blq. and leanto	F1
105	E 3" W	Eaves fin main blq. and leanto	F2
105	7 1/2" W	" " "	F3
20	12" W	Leanto roof to main blq.	F4
516	1/2" x 10" W	Finish skylight support ridge &	F5
33	15" W	Fin. skylight support ridge & leanto app. cap at end skyl. ridge	F6
10	E 4" W	L. Col. & approx. 1/2" dia.	F7
85	1 1/2" x 10" W	Cap. for hip rafters skylight supports	F8
55	E 2" x 10" W	Hip roof to main roof skylight support	F9
120	3" W	Fin. at lower skyl. joint (left) - Col. (left)	F10
120	3" W	Fin. at upper skyl. joint (left) - Col. (left)	F11
22	6" x 10" W	Cornice finish entire building	F12
3	4" x 5" W	Fin. at union of sides main blq. & leanto	F13
60	10" W	Fin. on slope of hip-rafter skyl. supports	F14
110	3" W	Finish at girt angles	F15
52	E 3" W	Cornice main building & leanto	F16

List of Corrugated Steel			
No. Pcs.	Length	Location	
392 1/8	7'-0"	Sliding end & west sides	
261	6'-6"	" " " "	
72	2'-3"	" west side of leanto	
72	3'-6"	" " " "	
25	17'-0"	" E & W side - corr. etc.	
15	6'-0"	" leanto - corr. & grade	
5	6'-0"	" " and ends	
227	7'-0"	" north & south ends	
5	7'-6"	" " " "	
168	6'-6"	" " " "	
22	11'-0"	" N & S ends - corr. etc.	
5	6'-0"	" " " " " "	
24	7'-6"	" " " " " "	
66	7'-6"	" " " " " "	
60	6'-0"	" " " " " "	
100	6'-0"	" hip roof " "	

List of Fastenings	
No.	Description
4500	Stove bolts 3/4" dia. galv. with wash
1700	" " 3/4" dia. " " "
1200	" " 3/4" dia. " " "
3500	Closing rivets 3/4" x 3/4"
3300	" " 3/4" x 3/4"
6000	Block cap. steel nails 2 1/2" - 1 1/2"
3200	Barbed roofing nails 1 1/2" - 1 1/2"
14000	" " " " 1 1/2" - 1 1/2"

FIG. 124.—Corrugated steel list for machine shop shown in Fig. 122.

ing shutters or sliding sash which during the summer months may be opened to admit a large amount of air.

Figure 135 shows details of louvre ventilators. This type of louvres is not expensive and is quite satisfactory.

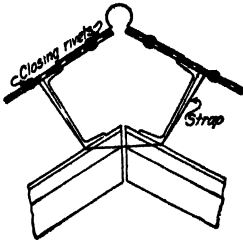

FIG. 125.—Section through ridge roll.

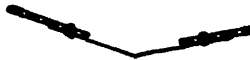

FIG. 126.—Valley flashing.

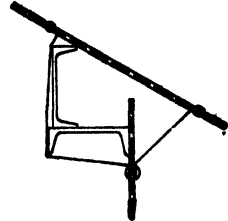

FIG. 127.—Eave finish.

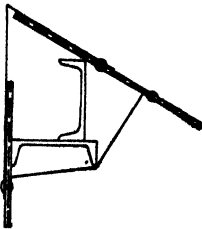

FIG. 128.—Ridge finish.

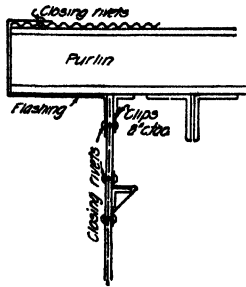

FIG. 129.—Gable finish.

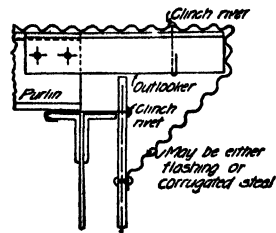

FIG. 130.—Gable finish with outlooker.

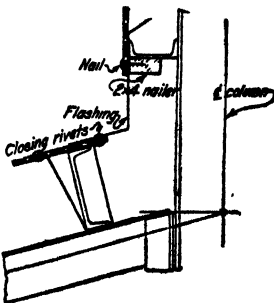
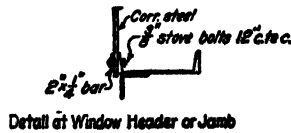

FIG. 131.—Finish of lean-to to main building.



Detail of Window Header or Jamb



Detail of Window Sill
FIG. 132.

Figure 136 shows details of a hinged shutter sometimes used in monitors. The shutter is made up of a steel frame covered with corrugated sheeting. Various types of operating devices are used for opening and closing the shutters.

Figure 137 shows details of an open side monitor used on an open hearth building. The curved sheet at the bottom of the opening is for the purpose of deflecting the air currents which pass up the roof of the building and would otherwise be carried into the monitor.

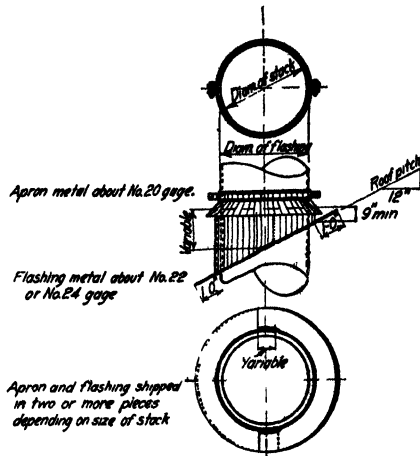

FIG. 133.—Stack flashing.

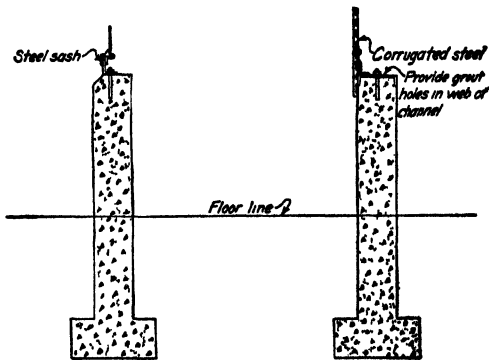

FIG. 134.—Curtain walls.

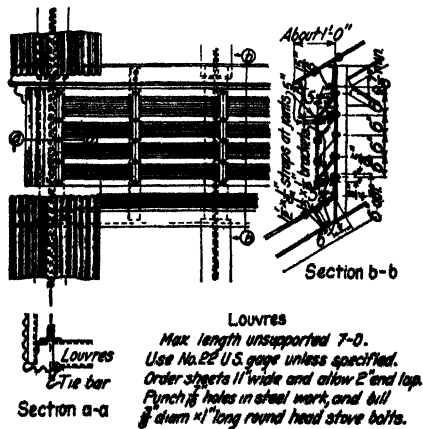

FIG. 135.—Louvre ventilators.

36b. **Circular Ventilators.**—Various types of circular ventilators are in use on buildings requiring only a small area for ventilating. They are made of galvanized steel, copper, or other sheet metal and are usually placed on the ridge line of the roof.

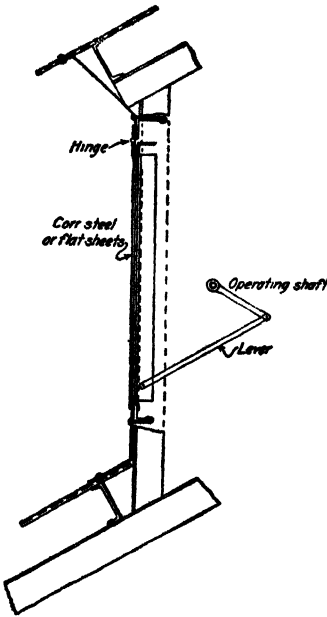

FIG. 136.—Hinged shutter.

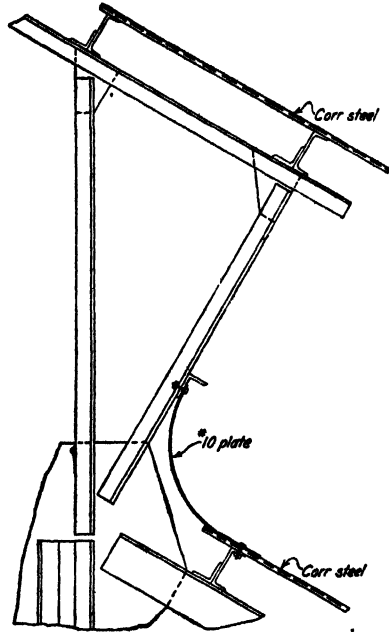

FIG. 137.—Open side monitor for open hearth building.

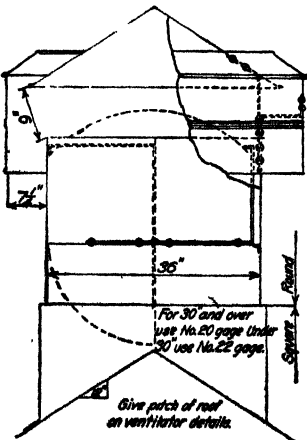

FIG. 138.—Circular ventilator.

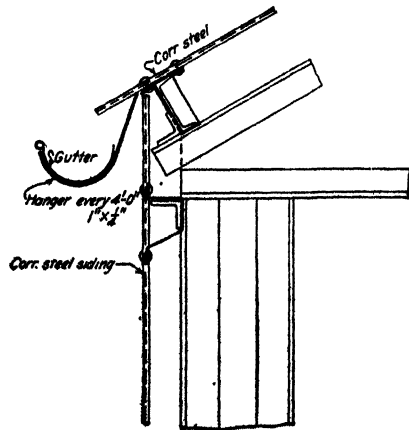
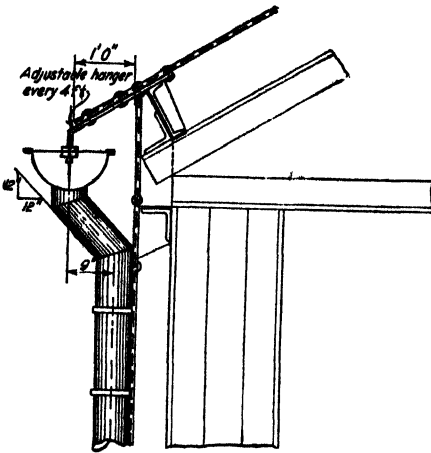

FIG. 139.—Hanging gutter.

A ventilator which can be made in any tinshop is shown in Fig. 138. Similar types of circular ventilators can be purchased on the market, among them being the Arex Ventilator made by the Arex Co. Chicago, the AEolus

Ventilator made by Paul Dickinson, Inc., Chicago, the Allen Ventilator made by Allen Corp., Detroit, Mich., the Century Ventilator made by Century Fan & Ventilating Corp., New York, the Royal Ventilator made by Royal Ventilator Co., Philadelphia, and the Burt Ventilator made by the Burt Manufacturing Co., Akron, Ohio. All of these ventilators as well as ventilators of the revolving type may be found described in the architectural and engineering catalogs.

37. Gutters and Down Spouts.—Both eave and valley gutters are usually made of No. 20 gage galvanized steel unless otherwise specified. They may be obtained in lengths up to 10 ft. varying by even feet. They should have 4-in. end laps, and should be well riveted and soldered to make them watertight.



Area drained (sq ft)	Size of gutter (in)	Down spouts (Dia in)	Spaced (ft)
0 to 1200	5	4	40
1200 to 1800	7	5	40
1800 to 2400	8	5	40

FIG. 140 —Hanging gutter

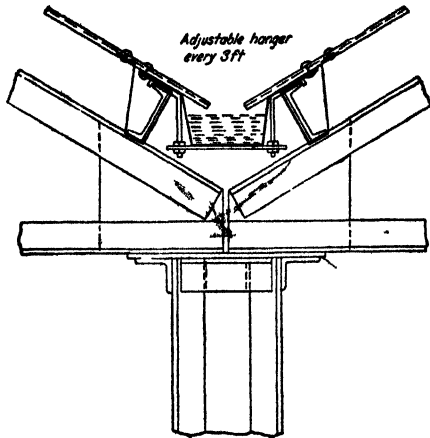

Area drained (sq ft)	Size of gutter (in)	Down spouts (Dia in)	Spaced (ft)
0 to 2400	4x8	5	40
2400 to 3600	5x8	6	40
3600 to 4800	5x10	6	40

FIG. 141.—Valley gutter.

Gutters should have a slope of at least 1 in. in 15 ft. and should be supported at intervals not to exceed 4 ft.

Common types of eave gutters are shown in Figs. 139 and 140.

Common types of valley gutters are shown in Figs. 141, 142 and 143.

In Fig. 144 is shown an interior gutter with down spout and gravel stop for use with tar and gravel roofs. A condensation gutter was also provided to take care of the condensation from the interior of the skylights. This gutter was used on the machine shop for the American Bridge Co. shown in Fig. 122.

Down spouts should be made of No. 22 gage galvanized steel unless otherwise specified. For buildings in cold climates, down spouts 6 in. in diameter and under should be corrugated; those over 6 in. in diameter should be plain. For buildings in warm climates all down spouts may be plain.

Down spouts are fastened to the sides of the building by means of hooks or straps.

38. Roof Coverings.—Mill building roofs are covered with: corrugated steel; felt, tar and gravel; cement tile; slate or asbestos shingles; or one of the many patented roofings now on the market.

It is important that the choice of covering be adapted to the slope of the roof or vice versa. The preferred slope for corrugated steel is 6 in. per ft., or $\frac{1}{4}$ pitch. The preferred slope for cement tile is 5 in. per ft., for tar and gravel roofing $\frac{1}{2}$ to 1 in. per ft., and for slate shingles 7 in. per ft.

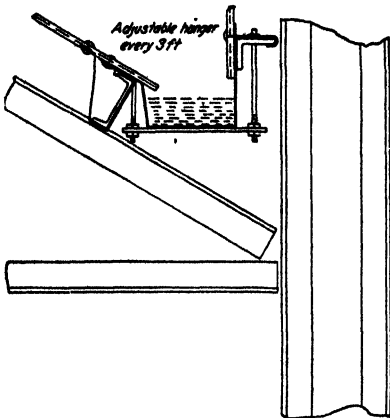

Fig. 142.—Valley gutter

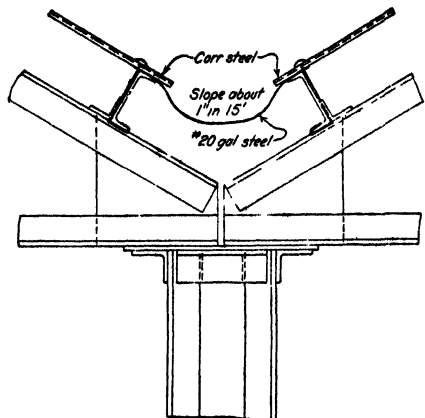

Fig. 143.—Valley gutter.

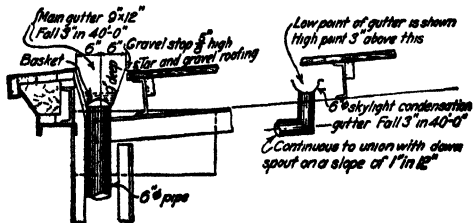

Fig. 144.—Interior gutter and down spout.



No. 19 galvanized wire netting
2" mesh, faced with No. 20 brass
wire, 14-lb. asbestos paper,
8-lb. asbestos paper, Mazonet
bit. paper (2 thicknesses),
Corrugated sheeting.

Fig. 145.—Anti-condensation lining, Berlin system.



No. 19 galvanized wire netting
2" mesh, 30-lb. asbestos paper,
Corrugated sheeting.

Fig. 146.—Anti-condensation lining, Minneapolis system.

38a. Corrugated Steel Roofing.—The subject of corrugated steel roofing and fastenings for this roofing has been covered in Art. 31. Where corrugated steel roofs are subjected to the action of corrosive gases, they should be kept well painted with a good protective paint.

On certain classes of buildings, to prevent condensation of vapor on the inside of the metal roof, the corrugated steel is laid on wooden sheathing or lined with an anti-condensation lining. This lining is put on by two systems.

Berlin System (Fig. 145).—The Berlin System of anti-condensation lining consists of a layer of wire netting, No. 19 gage and 2-in. mesh, placed on top of

purlins transversely and laced together with No. 20 brass wire. Over the netting is placed a layer of asbestos paper weighing 14 lb. to the square, and on this a layer of asbestos paper weighing 6 lb. to the square. On top of the asbestos paper are placed two thicknesses of Neponset building paper. The asbestos and building papers should lap at least 3 in. and break joints not less than 12 in.

When bays are longer than 10 ft., the purlins are trussed to take up the pull due to the stretching of the wire netting. This applies to channel purlins. Other types should be investigated. On buildings where the purlins are spaced more than 4 ft. apart, No. 9 galvanized wire is stretched across the purlins to prevent the wire netting from sagging.

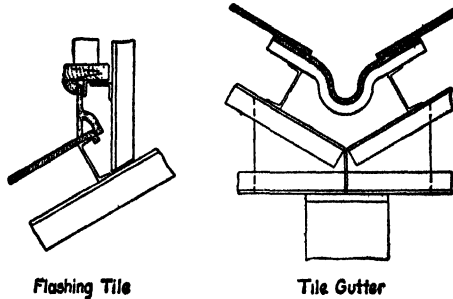
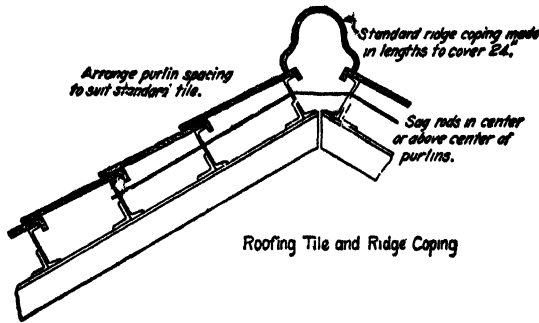

FIG. 147.—Cement tile roofing.

The lining and corrugated steel is held in place by clips and bolts or clinch rivets spaced as for ordinary corrugated steel covering. The bolts for the clips are 1½ in. long. Should a nut come in contact with the lining a tin washer should be used to prevent breaking or tearing the covering.

Minneapolis System (Fig. 146).—The Minneapolis System of anti-condensation lining consists of a layer of No. 19 gage galvanized wire netting with 2-in. mesh placed on top of purlins transversely and laced together with No. 20 brass wire. On top of the netting is placed a layer of 30-lb. asbestos paper, allowing 3 in. side lap. On top of this is laid the corrugated steel in the usual manner. Place a line of ¾-in. bolts between purlins about 2 ft. center to center with washers ¼ × 4 × ⅙ in. to prevent netting from sagging.

386. Tar and Gravel Roofing.—There are several different specifications for laying tar and gravel roofing but the general method is as follows:

On the wooden sheathing lay a single thickness of ordinary building paper, the edges lapping 2 in., and nailed to the sheathing with roofing nails about 2 ft. apart. On top of this are laid several thicknesses of roofing felt, shingle fashion, the laps being cemented together and the various layers to each other with hot tar or roofing cement. The top layer is then covered with a heavy coating of hot tar or cement and into this is rolled a layer of clean gravel which has been passed through a $\frac{5}{8}$ -in. mesh screen.

The roofing is either three, four, five, or six ply, depending upon the number of layers of the roofing felt.

The amount of tar or roofing cement used should be from 100 to 120 lb. per square. If tar is used, a small amount of pitch added to the tar will cause it to solidify and prevent flowing in hot weather.

The wooden sheathing should be tongue and groove 1 to 3 in. thick depending on the spacing of the purlins. With purlins spaced about 5 ft. 2-in. sheathing (actual thickness $1\frac{1}{2}$ in.) will usually be found economical.

Tar and gravel roofing well laid will last 15 to 20 yr. This covering is fire-proof, needs no painting, and is not affected by corrosive gases. The comparative cheapness and ease with which it can be laid make this kind of roofing very desirable for mill and factory construction.

38c. Cement Tile.—Figure 147 shows typical details of a roof covered with reinforced cement tile. This tile makes a very satisfactory roof, being practically indestructible and requiring no expense for maintenance. The tiles are laid directly on the steel purlins and are held in place by their own weight, no fastenings being required.

Cement tile roofing is manufactured by several companies, among them being the Federal-American Cement Tile Co. (Chicago).

The following data on cement tile is issued by the Federal-American Cement Tile Co.:

Covers.....	24 × 48 in.	Purlin spacing.....	4 ft.
Overall length.....	52 in.	Least allowable slope	$\frac{1}{2}$ pitch
12 $\frac{1}{2}$ tile per square		Safe carrying load..	100 lb. per sq. ft.
Wt. per sq. ft.....	16 lb.	Breaking load.....	250 lb. per sq. ft.
Thickness.....	$1\frac{1}{2}$ in.		

38d. Slate.—The best quality of slate is both hard and tough, has a bright lustre and has a clear ring when struck. If the slate is too soft, the nail holes will wear easily and the slates become loose. If too brittle, the slates will fracture during the process of holing and squaring and will break easily while being laid.

Slate makes a durable and fire-proof covering but if laid directly on the purlins in buildings where condensation would be injurious to the contents, the slate must be lined with some form of anti-condensation lining.

The sizes of slates range from 9 × 7 in. to 24 × 14 in. with a large number of intermediate sizes. The larger sizes are more suitable for mill and factory buildings as they require fewer purlins and nails, make fewer joints and require fewer small pieces at hips and valleys. The usual thickness is about $\frac{3}{16}$ in. The nail holes are bored and countersunk at the quarry, but this should be specified when ordering. Two holes are provided in each slate.

Slates should be laid with a 3-in. lap over the second course below, with joints well broken. They are fastened with two, three or four penny slater's nails, one at each upper corner. Copper, tinned, or galvanized nails should be used, as ordinary nails will soon rust and break off, allowing the slate to loosen (Fig. 148).

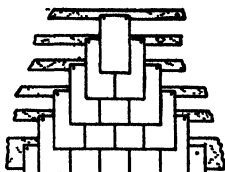

FIG. 148.—Slate on wood purlins.

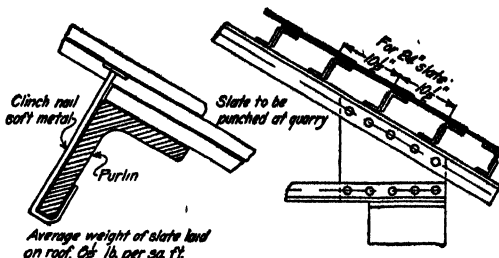

FIG. 149.—Slate on steel purlins.

The following table shows the number of slates required per square (100 sq. ft.) when laid with the standard 3-in. lap, also the length of the exposed surface and weight of nails required. Slate roofing $\frac{3}{16}$ in. thick will weigh when laid about $6\frac{1}{2}$ lb. per sq. ft., and if $\frac{1}{4}$ in. thick about $8\frac{3}{4}$ lb.

Size of slates (inches)	Exposed surface	Number per square	Weight of nails (lb. and oz.)	Size of slates (inches)	Exposed surface	Number per square	Weight of nails (lb. and oz.)
24×14	10½	98	1- 6	16×10	6½	222	2- 8
24×12	10½	115	1-10	16×9	6½	247	3- 0
22×12	9½	126	1-12	16×8	6½	277	3- 2
22×11	9½	138	1-15	14×10	5½	262	3- 0
20×11	8½	155	2- 0	14×8	5½	328	3-12
20×10	8½	170	2- 6	14×7	5½	375	4- 4
18×12	7½	160	1-13	12×8	4½	400	4- 9
18×10	7½	192	2- 3	12×7	4½	457	5- 3
18×9	7½	214	2- 7	12×6	4½	534	6- 1
16×12	6½	185	2- 2				

Figure 149 shows a method of laying slate roofing directly on steel purlins. The slates are fastened with copper or galvanized soft iron nails which are clinched around the lower leg of the angle purlins. The purlins should be spaced the same distance apart as the exposed surface of the slate which would be $10\frac{1}{2}$ in. for a 24-in. slate. The nail holes instead of being punched in the upper corners must then be punched near the middle, to be in proper location for clinching around the purlin.

38e. Prepared Roofings.—There are a large number of patented roofings which may be purchased on the market; many of these are excellent and can be easily laid. Asbestos or asphalt shingles or rolled roofing, of which there are several kinds on the market, make very satisfactory and lasting roofs.

The following are the names of a few of the roofing manufacturers and their products:

Johns-Manville Co.—Asbestos Shingles and Asbestos Rolled Roofing.

The Philip Carey Co.—Carey Built-up Roofing.

The Barrett Co.—Barrett Specification Roofs (a built-up roof covering).

The Barber Asphalt Corp.—Genasco Ready Roofings.

The Ruberoid Co.—Ruberoid Strip Shingles and Ruberoid Built-up Roof.

39. Floors.—Floors in mill buildings may be roughly divided into two classes: (1) ground floors and (2) floors above the ground. The purpose and use of the building and its contents, of course, largely determine the type of construction to be used in each individual case.

39a. Ground Floors.—Ground floors may be of well-compacted earth, cinders, concrete, brick, asphalt, plank, or wood block.

For steel mills, forge shops and foundries either earth or well-compacted cinders make the most suitable floor. In forge shops handling light work brick floors are sometimes used, but in forge shops handling heavy forgings any kind of floor except one composed of earth or cinders would have a short life.

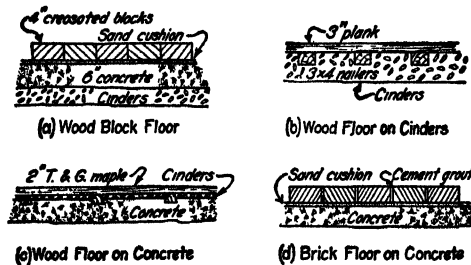

FIG. 150.—Ground floors.

For a machine shop or factory where the workmen are standing continually, the wearing surface should be wood or asphalt. A very satisfactory floor for a machine shop is one made of creosoted wood block laid in sand on a concrete foundation. The space between the blocks should be filled with pitch. Asphalt floors, while comfortable to walk upon, are not so satisfactory for machine shops, as they are softened by oil, of which more or less will usually be found on the floor of a machine shop.

For floors in round houses a number of railroads are using vitrified brick laid on sand or well packed cinders or in sand on a concrete base. Concrete would be suitable except that it will crack under the loads to which it is subjected and cannot be as easily repaired as a brick floor.

In Fig. 150 are shown several types of ground floors. It is essential that proper provision be made for draining ground floors of all types.

39b. Floors Above Ground.—In Fig. 151 are shown various types of floors above ground. In (a) is shown a simple plate floor made of checkered, indented or plain plates. This type of floor is not often used except for walkways, repair platforms, etc., which are not subjected to constant use, as in time the plates wear too smooth for safety.

In (b) is shown a brick floor supported by steel plates, a type of construction often used in open-hearth buildings for charging floors.

In (c) is shown a floor with a concrete base supported by buckle plates. The buckle plates may be turned with buckles either up or down. This type of floor is adapted to the carrying of heavy loads.

In (e) is shown a type of floor used as a mold loft floor in several of the Navy Yard repair shops.

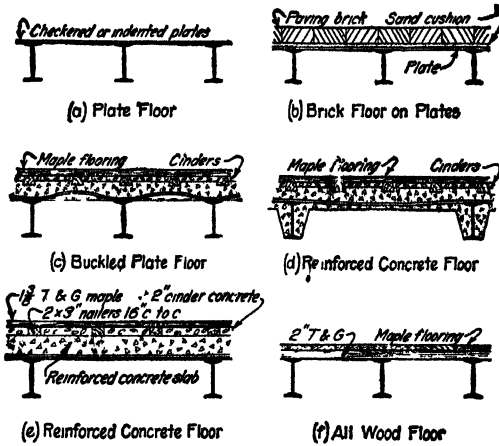

FIG. 151.—Floors above ground.

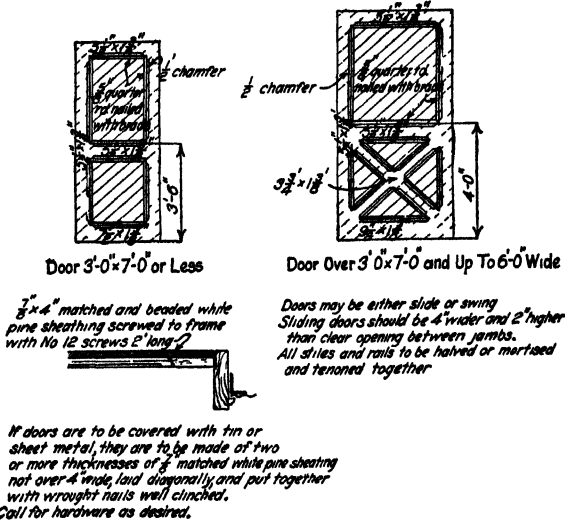

FIG. 152.—Wooden doors under 6 ft. wide.

40. Doors.—Swinging exit doors in factory and mill buildings should swing outward for safety in case of fire. Horizontal sliding or rolling doors on brick walls are usually more convenient when placed on the inside of the building. On buildings with corrugated steel sheeting they may be placed either inside or outside to suit conditions. Placed on the inside they may be interfered with by the column or other framing, but, if placed on the outside, a metal hood should be provided over the door track, flashed to the side walls.

40a. Wooden Doors.—Wooden doors are usually constructed of matched white pine sheathing nailed or screwed to a wooden frame.

Details of wooden doors under 6 ft. wide, are shown in Fig. 152; and over 6 ft. wide, in Fig. 153. These doors are used by the American Bridge Company on buildings with corrugated steel side walls, but with modifications can be used with any kind of side wall construction. The details are self-explanatory.

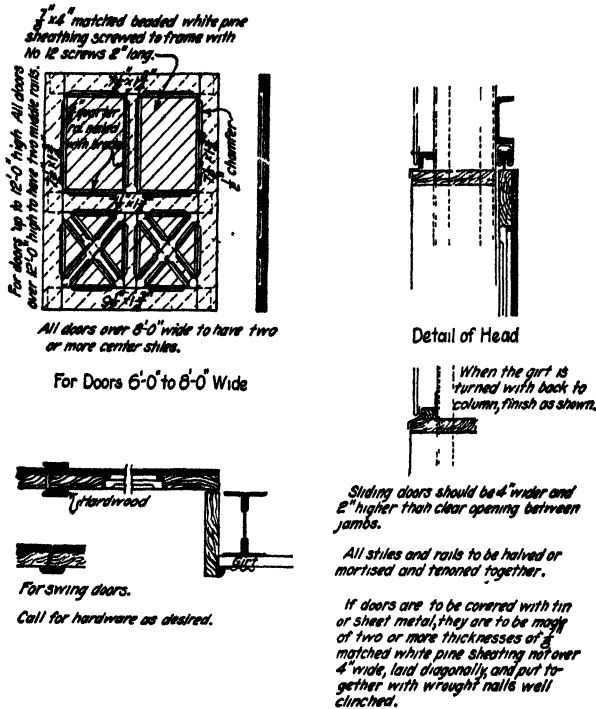

FIG. 153.—Wooden doors 6 ft. wide and over.

The following specifications apply to wooden doors of the type shown:

(1) All doors and their frames are to be built in accordance with the details and to the dimensions shown on the drawings and sketches.

(2) All lumber is to be sound, free from rot, shakes, or large, loose, black or unsound knots, or any imperfections that will impair its strength or durability. A few small or sound knots will be allowed.

(3) Frames for doors are to have the heads and sills gained to receive the jambs. All separate pieces making a frame are to be cut to exact dimensions and must be built so that an ordinary workman may nail them together at the building site. No calculating of dimensions, nor cutting or measuring to be done by the workman who puts the frames together.

(4) All frames not shipped by rail, but purchased locally and delivered at the building site, shall be nailed together complete. If shipped by rail, they are to be shipped "knocked down," and all strips and small pieces should be carefully bundled for shipment.

(5) Framed doors are to be built of seasoned white pine in accordance with detailed dimensions. The stile and rails are to be framed to form panels, mortised and tenoned or halved, chamfered and supplied with $\frac{1}{4}$ " round in the interior angles. The backing is to be of $\frac{3}{8}$ -in. white pine lumber; not over 4 in. wide, matched, beaded and surfaced two sides,

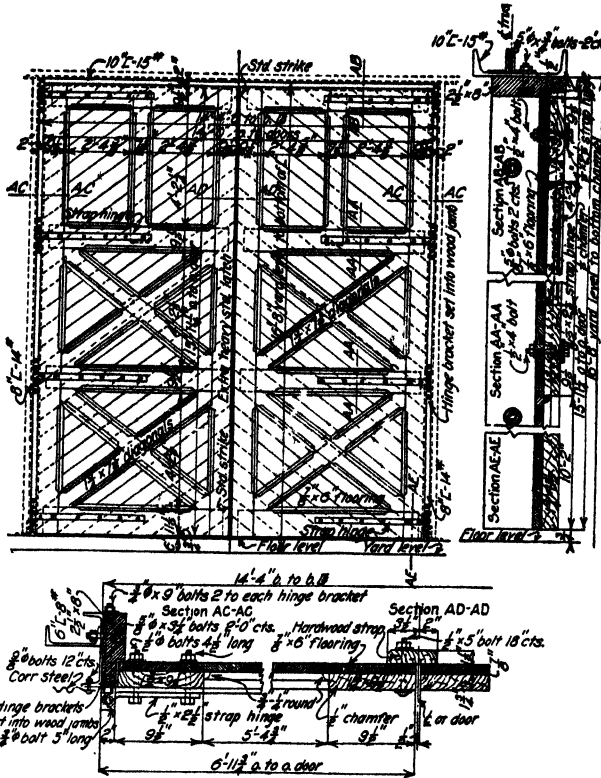

FIG. 154.—Large wooden doors.

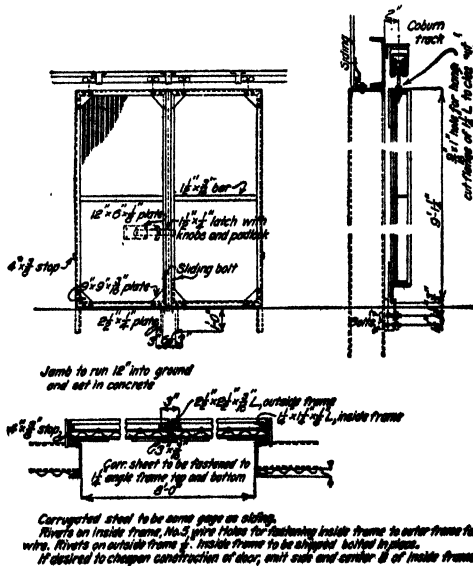

FIG. 155.—Steel sliding door.

put on the frame diagonally in one or two thicknesses as detailed, and thoroughly fastened to frames by screws. All doors are to be put together in the best manner, with white lead in all joints.

(6) Doors covered with tin or sheet metal are to be made of two or more thicknesses of $\frac{7}{8}$ -in. matched white pine courses, laid diagonally, thoroughly put together with wrought nails well clinched.

(7) When doors are in pairs, strips are to be placed on the edge where the two doors join each other; one strip to each pair of swinging doors and two strips if the doors are sliding. If the doors are hinged, rabbet strips must accompany them.

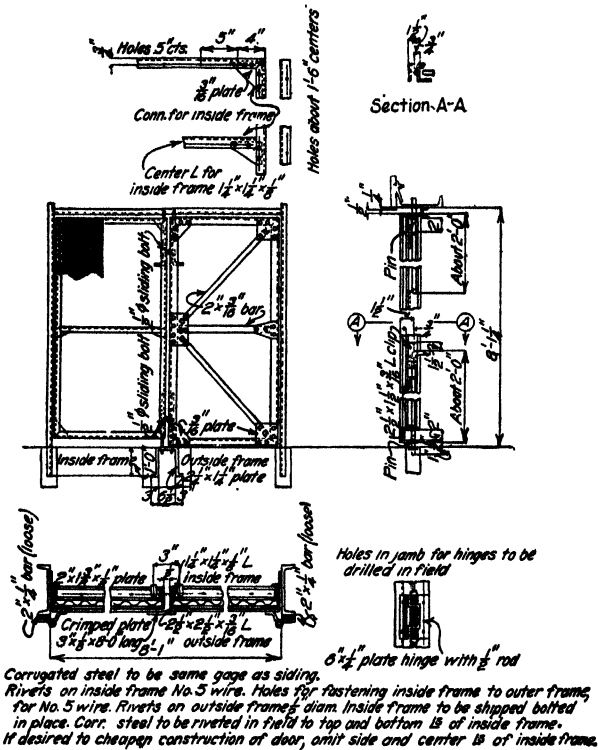

FIG. 156.—Steel swinging door.

(8) Hardware (such as hinges, latches, guides, locks, etc.) which attaches to the doors, and bolts or screws which are required to fasten the doors to the framework of the building proper, also hangers for sliding doors and the weights, pulleys and chains for lifting doors are not furnished by the door manufacturers. If included in the contract, they must be purchased separately. All hardware is to be suitable for the work for which the doors are furnished.

Details of large double leaf swing doors are shown in Fig. 154. These doors are in use on a locomotive shed for an industrial plant. Doors of this size require very substantial supports.

40b. Steel Doors.—Steel doors may be made either swing or sliding and may be covered with either flat or corrugated steel.

Details of steel sliding doors are shown in Fig. 155, and of steel swinging doors in Fig. 156. There are several patented devices on the market for hanging slid-

ing doors. The sliding doors in Fig. 155 are shown with a Coburn track and hangers.

Steel doors are now manufactured by several firms making steel sash, the best known probably being the "Fenestra" doors, manufactured by the Detroit Steel Products Co., Truscon doors manufactured by Truscon Steel Co., Youngstown, Ohio, and the Lupton doors manufactured by Michael Flynn Manufacturing Co., Philadelphia.

These doors are made with stiles of seamless rectangular steel tube welded at the corners. The lower part of the door has a steel panel. The upper part may be made either a steel panel or filled with glass. These doors are made either swinging or sliding and are in various styles and sizes suitable for factory use.

A type of door often used on large entrances is the steel rolling door. These doors are made of metal slats joined together and when opened are rolled up on an overhead drum. The Kinnear Rolling Door made by the Kinnear Mfg. Co., Columbus, Ohio is shown in Fig. 157.

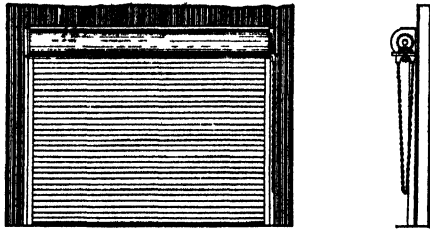

FIG. 157.—Kinnear steel rolling door.

41. Windows and Skylights.

41a. Glass.—The kinds of glass used in windows and skylights for mill buildings are ordinary sheet glass, plain or wired plate glass and sheet prisms, the latter being seldom used.

Ordinary sheet glass is divided as to thickness into "single strength" and "double strength." Single strength glass is about $\frac{1}{16}$ in. thick, and double strength about $\frac{1}{8}$ in. thick. As to quality, sheet glass is made in three grades, AA, A and B, the AA being the best and the B grade the poorest. Grade A is suitable for ordinary mill and factory buildings.

Plate glass is made in various thicknesses which will depend upon the size required and is made either plain, or reinforced with wire mesh. The surface is either polished, rough, ribbed or figured, the latter being known as maze glass. The ribbed glass is made with ribs on one surface only, the opposite side being smooth.

Rough and ribbed plate wire glass are the kinds best suited for factory and mill building construction. Wire glass is especially adapted for skylights, for if the glass is broken the wire will prevent the pieces from falling. For the same reason wire glass has high fire resistance and will hold together long after ordinary glass has failed. Light is not as well diffused through rough plate as through ribbed plate but is preferred by some on account of being easier to clean, as the ribbed glass will collect dirt and unless frequently washed will obscure more light than the rough plate. Ribbed glass should be placed with the ribs either on the inside or outside of the building according to which is the more accessible for

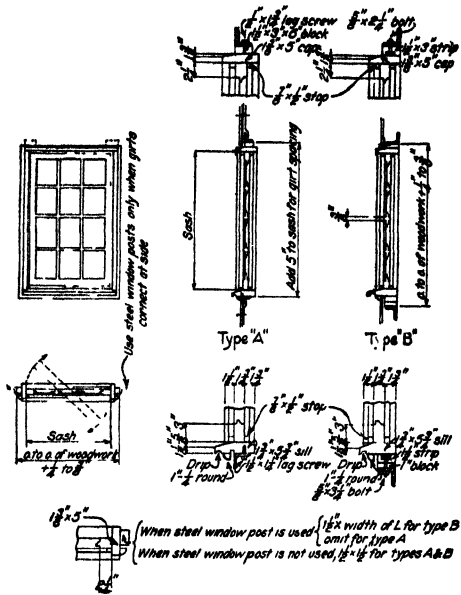

FIG. 158.—Pivoted window.

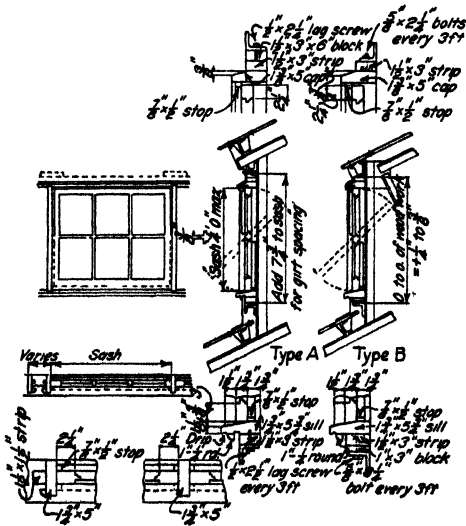

FIG. 159.—Continuous pivoted and fixed sash in monitors.

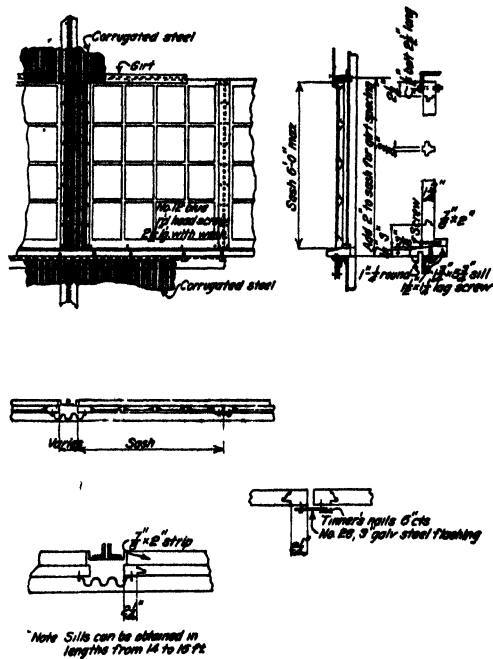

FIG. 160.—Continuous fixed sash.

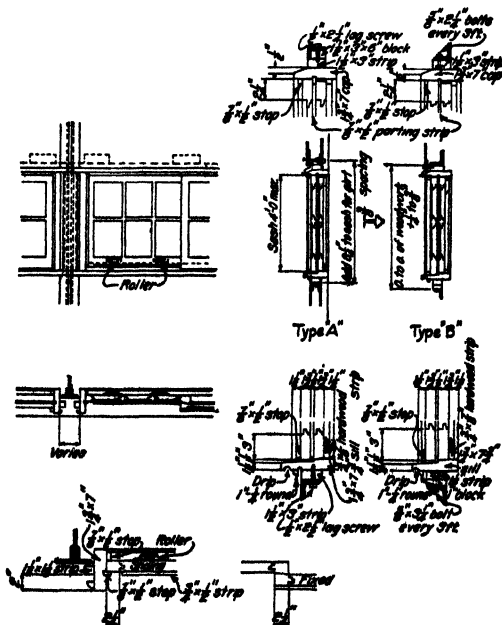

FIG. 161.—Continuous sliding sash.

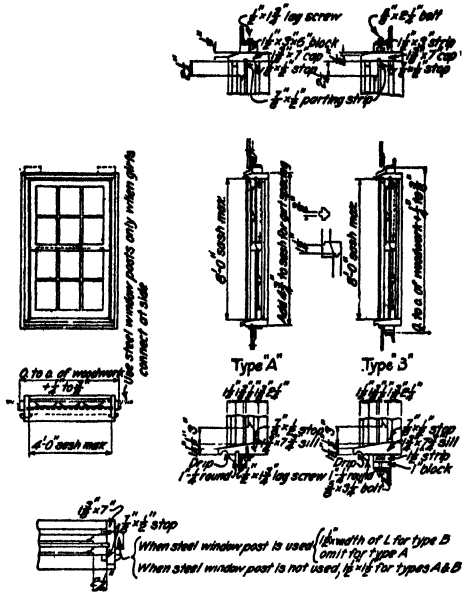

FIG. 162.—Counterbalanced window.

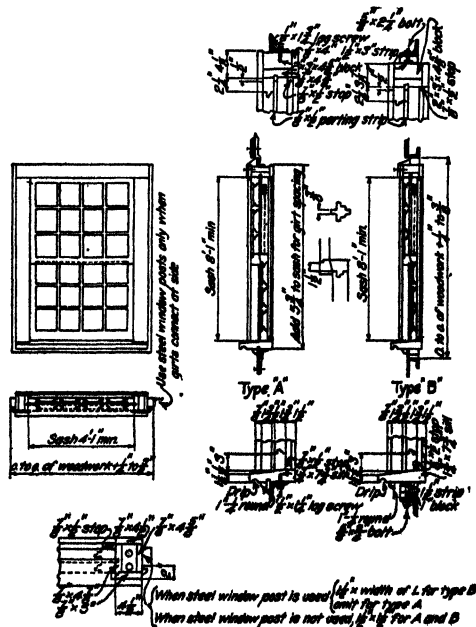

FIG. 163.—Double hung weighted window.

cleaning. The ribs should be vertical for side walls and parallel to the roof slope on skylights.

The amount of glazed surface required for a mill building will depend upon the use for which the building is constructed. The present tendency in machine shops and manufacturing establishments where close work is performed is to glaze as much of the side walls as possible. This tendency has been brought about largely by the use of steel sash, which is adapted to continuous glazing.

Size of Glass	Width		Height		Single Sash	Double Hung Sash		Width of Glass	Size of Glass	
	W	H	H ₁	H ₂		H ₁	H ₂			
10x12	2-1/2	2-5/8	3-1/8	4-1/8			5-1/8	4-7/8	2-1/4	10x12
12x12	3-5/8	2-5/8	3-5/8	4-1/8			5-3/8	4-7/8	3-5/8	12x12
10x14	2-1/2	2-5/8	3-1/8	4-1/8			7-1/8	5-3/8	2-1/4	10x14
12x14	3-5/8	2-5/8	3-5/8	4-1/8			7-3/8	5-3/8	3-5/8	12x14
10x16	2-1/2	2-5/8	3-1/8	4-1/8			8-1/8	5-1/8	2-1/4	10x16
12x16	3-5/8	2-5/8	3-5/8	4-1/8			8-3/8	5-1/8	3-5/8	12x16
14x16	3-1/2	2-5/8	3-1/2	4-1/8			9-1/8	5-1/8	3-1/2	14x16
Sliding Sash										
10x12	3-5/8	5-0	5-0	5-0			8-5/8	2-1/4	10x12	
12x12	4-3/8	5-0	5-0	5-0			8-5/8	3-5/8	12x12	
10x14	3-5/8	5-0	5-0	5-0			10-1/8	2-1/4	10x14	
12x14	4-5/8	5-0	5-0	5-0			10-1/8	3-5/8	12x14	
10x16	3-5/8	5-0	5-0	5-0			11-5/8	2-1/4	10x16	
12x16	4-5/8	5-0	5-0	5-0			11-5/8	3-5/8	12x16	
14x16	5-1/8	5-0	5-0	5-0			11-5/8	3-1/2	14x16	
Quality of Glass										
A American Single Strength					A American Double Strength					
10x12	12x12	10x14	12x14	14x16	10x16	12x16	14x16	10x18	12x18	14x18
All sash to be 1/2" thick, except sliding sash, pivoted sash and single sash or one half of double sash, excepting 4-0 high or 4-0 wide, which should be made 3/4" thick. Top rails 2", Sills 2", Bottom rail 3", Muntins 3". Pivoted sash, 4 lights high or over, to have one horizontal muntin 1/2" thick; all other sash 6 lights high or over, to have one horizontal muntin 1/2" thick. Pivoted sash, 4 lights wide or over, to have one vertical muntin 1/2" thick; all other sash 6 lights wide or over, to have one vertical muntin 1/2" thick. For pivoted sash 4 and 5 lights high or wide, add 1/4" to figures given in above tables.										

Fig. 164.—Dimensions for glazed wood sash.

For sheet glass the regular stock sizes vary by inches from 6 to 16 in. in width. Above that they vary by even inches up to 40 x 50 in. for single strength and 60 x 80 in. for double strength. Wire glass, for thicknesses of 1/4, 3/16 and 3/8 in. which are commonly used on mill buildings, can be obtained in 48-in. maximum widths and 144 in. maximum lengths.

The following table gives the approximate weight per square ft. of wire glass:

Thicknesses (inches).....	1/8	3/16	1/4	5/16	3/8	1/2	5/8	3/4	1
Wt. per sq. ft.....	2	2 1/2	3 1/2	4 1/2	5	7	8 1/2	10	12 1/2

41b. Wooden Sash.—Since the advent of steel sash, the use of wooden sash has been largely curtailed due to the greater effective area of the former for lighting. The relative cost of wooden sash against steel sash cannot be stated with any degree of accuracy as it will depend largely upon location. In

localities where lumber is plentiful wooden sash will be cheaper than steel although the opposite may be true in other localities.

The relative life of wooden sash as compared to steel is a matter of opinion. Both steel and wooden sash if kept properly cleaned and painted will last indefinitely. However, if the steel sash is not kept properly painted it will soon rust away.

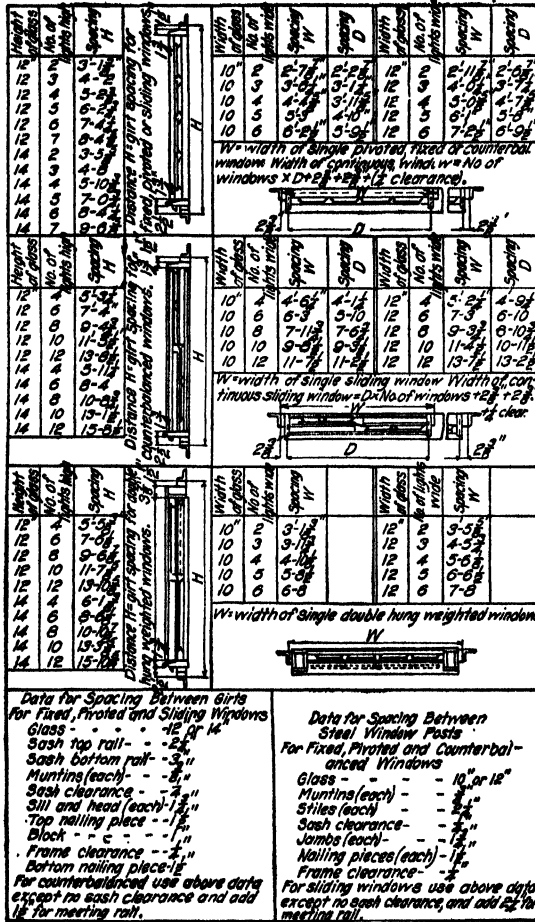

FIG. 165.—Dimensions for wood frames.

The details of wooden sash will depend upon the nature of the supporting walls. In Figs. 158 to 165, inclusive, are shown details of wooden sash for buildings with corrugated steel siding, as used by the American Bridge Co. With certain modifications they can be applied to any type of wall.

The following specifications apply to these windows:

- (1) All window frames and sash are to be built in accordance with the detail drawings and dimensions shown thereon. The number and kinds to be specified on the drawings and sketches.

(2) All lumber is to be sound and free from rot, shakes, or large, loose, black or unsound knots or any imperfections that will impair its strength and durability. A few small or sound knots will be allowed in the sash and frames, but the muntins and sash bars must be entirely free from knots. Window frames are to be of white pine, of a quality to fulfill requirements above specified, except the stiles and parting strips of double hung windows, which should be of Georgia yellow pine. Where white pine is found too high in price, cypress is sometimes admissible for inside work.

(3) All frames for windows, or continuous sash, are to have the heads and sills gained to receive the jambs. All the separate pieces making a frame are to be cut to exact dimensions, and must be built so that an ordinary workman may nail them together at the building site. No calculating of dimensions, nor cutting or measuring is to be done by the workman who puts together the frames.

(4) All exposed surfaces of frames are to be dressed and primed with pure white lead and boiled linseed oil, except in the case of double hung or counter-balanced windows, where the parting strips and pulley stiles are to be oiled.

(5) All window frames not shipped by rail, but purchased locally and delivered at the site, should be nailed together complete; if shipped by rail, they are to be shipped "knocked down," and all strips and small pieces should be carefully bundled for shipment.

(6) Window sash are to be built of white pine of the dimensions shown on the details. All sash are to have the lugs cut off the stiles and rails, and are to be jointed on the outside edges. All exposed surfaces are to be dressed and primed lead color, of pure white lead and boiled linseed oil. Sash should be made to fit the openings for which they are intended, with $\frac{1}{4}$ -in. allowance in height and width. The sash are to be glazed with single thickness American glass, of what is commonly known as "No. 2" or "A" quality. At least 8 glaziers points to a light should be used, and the glass should be well bedded, sprigged and puttied in the sash. If the lights are larger than 12 by 14 in., the glass is to be double thickness American glass, same quality as foregoing. All sash are to be primed before the glass is put in place. All sash are to be carefully crated for shipment, and all glass fractured when the sash are received at the building site is to be replaced by the manufacturer.

(7) Hardware, such as pulleys, weights, chains, trolleys, trunnions for swing sash, hinges, catches, etc., which attach to the windows or their frames and such bolts or screws as are required to fasten the windows to the framework of the building proper, are not furnished by the window manufacturer. If included in the contract, they must be purchased separately.

41c. Steel Sash.—Steel sash is now being made, suitable for all classes of buildings. The methods of fastening the sash are quite simple for either steel, brick or concrete construction. Steel sash are made on continuous runs with or without ventilators, the sections being joined together with vertical T-bar mullions. Figure 166 shows typical details of steel sash as fastened to steel framework.

Full detailed information concerning steel sash will be found in the catalogs issued by the various manufacturers, the most prominent being: the Detroit Steel Products Co., makers of "Fenestra" steel sash and doors; Michael Flynn Manufacturing Co., Philadelphia, makers of Lupton's Steel Pivoted Factory Sash; and the Truscon Steel Co., Youngstown, Ohio, makers of Truscon Steel Sash. The sash dimensions and methods of fastening side wall sash are practically the same for the sash made by each of these firms.

41d. Skylights.—Skylights are used in buildings whose width is too great to receive proper light from the sides. The proportion of roof to be covered with glass will depend upon the use of the building and will vary anywhere from 20 to 50 per cent. Some forms of skylight serve the double purpose of lighting and ventilation.

Skylights for mill buildings are generally placed in the plane of the roof, although individual box skylights are sometimes used.

Skylight glass is held in position and made watertight by two general methods: (1) by being laid in putty or cement, or (2) by the use of felt packing in the joints compressed and held in place in various ways.

Laying the glass in putty or cement has the advantage of allowing the glass to bed itself without straining and causing breaks, and the joints are easily made

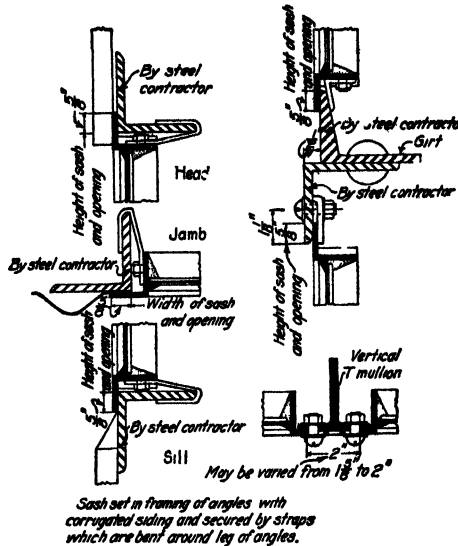

FIG. 166.—Steel sash details.

watertight. However, this method has a distinct disadvantage due to the fact that the cement or putty will adhere to the glass and allow no movement such as will take place when the framework expands or contracts, or the building vibrates under the passage of cranes, etc. and the glass will become broken.

The use of felt strips and the omission of the cement or putty overcomes this disadvantage. There are also forms of skylight construction in which neither cement, putty nor felt is used, the glass being held between metal surfaces and leakage through the joints carried off in condensation gutters which are made a part of the skylight bar.

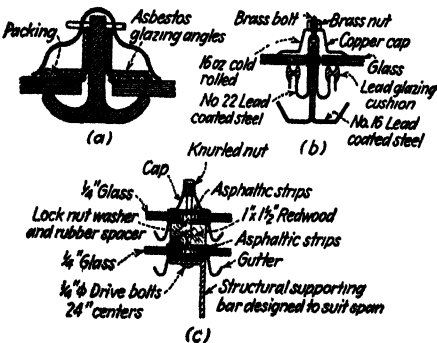

FIG. 167.—Types of skylight bars.

(a) shows the "Peerless Skylight Bar" made by John D. Busch & Sons, Detroit, Michigan. This consists of a steel tee, heavily coated with asphaltum paint, which provides a seat for the glass. The cap holding the glass is held in place by a brass cotter pin.

In Fig. 167 are shown several different types of skylight bars.

In (b) is shown the skylight bar made by the Nonpareil Skylight Company, Baltimore, Maryland. The glass rests on a lead cushion and is held in place with a metal cap. The supporting bars are made of lead-coated steel and have their lower edges bent out and up to form condensation gutters.

In (c) is shown a skylight bar of the double-glazed type made by the H. H. Robertson Company, Pittsburgh, Pennsylvania. These double-glazed skylights are designed to overcome condensation of moisture on the inside surface of skylights. They are glazed with two layers of glass, with an air space between the layers, resulting in far greater heat-insulation value.

In Fig. 168 is shown a simple skylight with a wooden frame. The glass is laid on a 1/4-in. felt strip and is held in place by a wood strip nailed to the frames. Over this is placed No. 18 galvanized steel flashing.

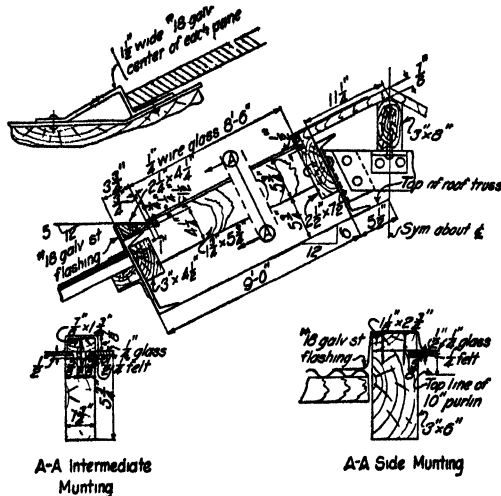

FIG. 168.—Wooden skylight frame.

TIMBER FRAMED FLOORS AND ROOFS

42. Floor Construction.

42a. Thickness of Sheathing and Spacing of Joists.—The type and intended use of the building will in a great measure determine the general arrangement of floor system, the thickness of sheathing, and the approximate spacing of joists. For timber floors carrying light loads, as dwelling houses, apartment houses, schoolhouses, and office buildings, the sheathing is usually of double thickness, consisting of an under floor of rough 1 X 6-in. boards, laid diagonally with the joists, and an upper floor of 3/8-in. tongue and grooved flooring. The joists for this class of buildings are usually 2 to 3 in. nominal thickness, spaced 16 in. on centers, and of such depth as is necessary for strength and stiffness. The spacing of 16 in. for the joists must be maintained when a ceiling of wood lath and plaster is supported from the under side of joists. Usually, the span of the joists will not exceed 20 ft. Floor joists 2 X 8 in. are the smallest size that should ordinarily be used, while the maximum depth for a 2 in. thickness should not

exceed 16 in. If a stronger joist than a 2×16 in. is required, the thickness should be increased to 3 in. with a maximum depth of 18 in., or the spacing decreased to 12 in. With a ceiling supported from the floor joists, the size of joists must be sufficient to keep the deflection of the joists when fully loaded to $\frac{1}{320}$ of the span of the joists. In making such a computation for deflection the load of ceiling, joists and bridging, flooring and any partitions is considered as the constant or "dead" load, and the modulus of elasticity used should not exceed $\frac{3}{4}$ that given for the particular kind of timber used. The deflection for live load is computed, using the full value of the modulus of elasticity. The total deflection to be expected is the sum of the two partial deflections.

In buildings where floors carry much heavier loads, as warehouses, lofts, etc., the flooring is usually $1\frac{1}{2}$ in. thick as a minimum. If such a building has no ceiling, the spacing of joists may profitably be increased over 16 in. In general, the most economical floor will occur with short spans for joists and girders, and consequently small size joists. On the other hand, many other factors enter which may warrant longer spans for both joists and girders, and the most important of these factors is the advantage of having as few posts inside of a building as possible. In the framing of the first floors of buildings where such floors are but a few feet off the ground, it will usually be found, for example, that for a live load approximating 100 lb. per sq. ft., the most economical system of framing will be 6×6 -in. posts, 6×8 , or 6×10 -in. girders, 2×8 -in. joists, the floor bays being approximately 10×10 ft. In the above statement, it is assumed that the footings rest on the soil; for pile foundations the situation would be entirely different. In the latter case economy will dictate the use of long spans to utilize the full capacity of pile.

Comparing 2-in. joists with 3-in. joists of equivalent strength, it may be pointed out that, since the actual finished thickness of a 3-in. joist when surfaced one side is $2\frac{5}{8}$ in., and the finished thickness of a 2-in. joist is $1\frac{5}{8}$ -in., the loss of strength by surfacing is 18.75 per cent in a 2-in. joist and 12.5 per cent in the 3-in. joist, or an economy of 6.25 per cent for the 3-in. joist, although the price of the 3-in. timber will be slightly higher than the 2-in. stock. Only a comparison of several schemes for an actual case will indicate the cheapest construction.

For proper spiking the thickness of joist should be somewhat greater than the thickness of single floor spiking to it. Using floor boards of 2-in. thickness, the joists should be 3 in. thick.

42b. Bridging.—Bridging consists of timbers placed between joists to support them laterally. Bridging is either solid or of the cross or herring-bone type. The latter



FIG. 169.—Detail of herring-bone bridging.

method, shown in Fig. 169, is the more effective of the two types, since it not only supports the joists laterally, but, in the event that a concentrated load comes on one joist, the bridging will effectively assist the flooring in distributing a portion of the load to the joists at either side.

For joists 2×10 in. and under, cross-bridging 1×4 in. or 1×3 in. will be sufficient. For joists 2×12 in. and larger, the cross-bridging should be at least 2×3 in., and for the larger sizes of joists, 2×4 in.

Solid bridging consists of pieces of planks of the same depth as the joists, cut and fitted between the joists. Solid bridging should never be less than 2 in. thick.

All bridging should be neatly and snugly fitted between the joists and well nailed thereto. It should be continuous throughout a line of joists having a common span. Cross-bridging should be placed at intervals not to exceed 8 ft. All joists should be solid bridged over supports.

42c. Arrangement of Girders.—With a rectangular floor bay, the economical arrangement of girders and joists is to make the girders span the short side of the rectangle, the joists taking the longer span.

For general stiffness of the building, the girders, where possible, should run parallel to the transverse axis of the building. It may be advisable, if clearances will permit, to use knee braces from girders to columns, but in any case the span of girder should always be taken as the distance between center lines of end bearing on columns or walls. Knee braces should preferably be fitted or attached to girders and columns after the full dead load of floor is in place; otherwise even the slight deflection of girder may put heavy bending stresses in the columns.

Openings for stairs, etc., make the case of non-uniform loading more likely to be encountered in the case of floor girders than in the case of joists.

If double girders are necessary, an air space should be left between them, and the two girders connected at short intervals, say 2 ft., by pairs of bolts, using cast-iron separators between the girders. This air space is necessary to prevent dry rot taking place, although for fire protection such air space is undesirable.¹

42d. Connections to Columns.—To prevent the girders in falling from pulling the columns with them, in case of fire, standard practice recommends that the attachment of girders to columns be made self-releasing. The writer believes, however, that in the event of a fire serious enough to burn through the girders, the interior posts of the building are almost certain to fall. For this reason, where it is necessary to secure lateral stiffness in a building, he believes it well to design the connections of girders to columns, and joists to columns, relatively strong, providing continuity across the columns. Details of such connections are discussed in the volume on Structural Members and Connections.

42e. Connections to Walls.—All girders and joists entering masonry walls should rest upon steel or iron bearing plates, well painted. An air space should be left around the ends of the joists and girders. In order to allow the girders or joists to fall without pulling the walls over in case of fire, the ends of the timbers are usually cut back, as in Fig. 170. For tying the girders and joists into the walls, iron or steel anchors are used, as illustrated in Fig. 170. These anchors should be approximately $\frac{1}{4} \times 1\frac{1}{2}$ -in. straps, one end forged into a lug to fit into a notch in the upper side of girder.* The portion within the wall may be bonded into the masonry. Sometimes an anchor consisting of a round rod is passed through the wall, and is fitted with an exterior ornamental cast-iron washer on the outside. The other end of the rod may be forged into a flat strap with a lug as before.

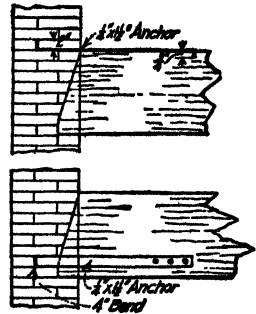

FIG. 170.—Details of connection—timber joists to brick walls.

¹ In mill construction, this air space is considered objectionable by many since it forms a concealed space, which, in the event of fire, cannot be reached by water from the sprinklers.

Every girder should be anchored into the wall. In the case of joists, at least every sixth joist should be so anchored. Building ordinances usually prescribe in detail the size and arrangement of wall anchors.

Joists, closely spaced, entering a masonry wall weaken the walls. Further, unless very careful inspection is maintained, one can never be certain that proper air spaces will be left around the timbers entering the wall. For this reason, there have been developed wall boxes, made of malleable iron, steel, and cast iron, which

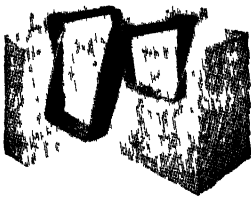

FIG. 171.—"Ideal" double steel hanger, style B.

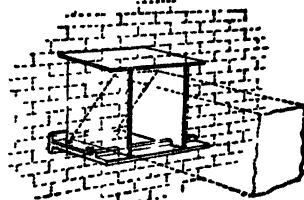

FIG. 172.—"Ideal" wall box

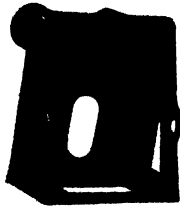

FIG. 173.—Duplex heavy duty malleable joist hanger.

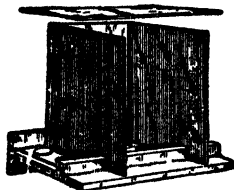

FIG. 174.—Duplex wall box.

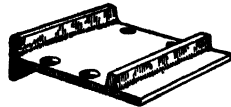

FIG. 175.—Duplex wall plate.

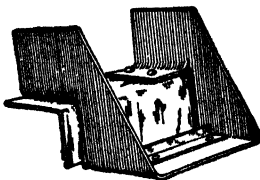

FIG. 176.—Duplex wall hanger.

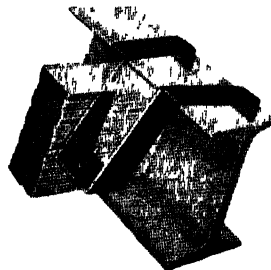

FIG. 177.—"Ideal" joist hanger.

insure an air space around the joist or girder, and at the same time allow the timber to be self-releasing in case of fire. The tie between timber and wall is secured by a lug on the base of the anchor which engages a notch on the under side of joist or girder. Typical box anchors are shown in Figs. 171 to 174 inclusive. Figure 175 shows a Duplex wall plate.

A third method for support of joists and girders is the wall hanger shown in Figs. 176 and 177. With the wall hanger, no hole is left in the wall. Since the joists and girders with this device extend only to the inner surface of the wall,

a saving in timber is made. Since lumber comes in lengths of multiples of 2 ft. only, the use of the wall hanger as compared to the box anchor may mean a saving, in many cases, of 2 ft. in the length of timber—a very considerable item.

42f. Typical Floor Bay Design.—The following example will illustrate the necessary computations for designing the joists and girders of a typical floor bay. The framing plan of the bay is shown in Fig. 178.

Data: Office floor; partitions 2 × 4 in., plastered both sides, 12 ft. high; flooring double, under floor rough 1 × 6 in., upper floor 1 × 4 in., T & G; ceiling plastered; joists 16 in. on centers; live load for joists, 60 lb. per sq. ft.; live load for girders, 48 lb. per sq. ft.; live load for stairs, 75 lb. per sq. ft.

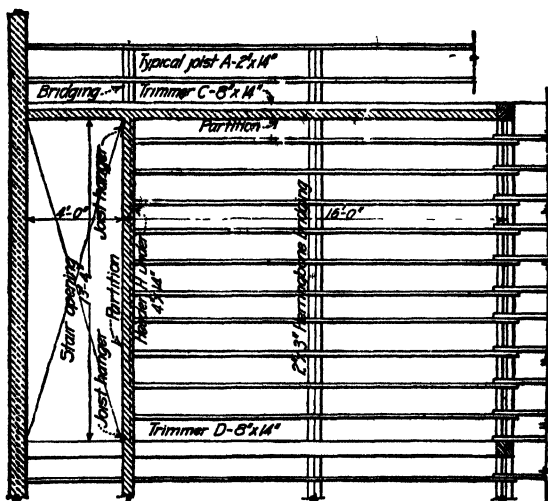

FIG. 178.—Framing plan of typical floor.

For approximate dead load, call flooring 2 in. thick at 3 lb. per board foot; assume joists 2 × 16 in.—16 in. on centers; allow 1 lb. per sq. ft. for bridging; assume plaster ceiling weight 5 lb. per sq. ft.; assume girder weight as 2 lb. per sq. ft.

Timber: Douglas fir, dense structural grade, all timbers to be taken as S1S1E,¹ working stress 1,800 lb. per sq. in. in flexure and 175 lb. in horizontal shear.

	Joists	Girders
Loadings:		
Flooring	6	6
Joists	6	6
Bridging	1	1
Ceiling	5	5
Girder	0	2
Total dead load	18	20
Live load	60	48
Total dead and live load	78 lb. per sq. ft.	68 lb. per sq. ft.

Typical Joist A.—Span 20 ft.; load = (20)(1½)(78) = 2,080 lb. It is found (see volume on “Structural Members and Connections”) that a 2 × 12-in. joist

¹ Surfaced one side and one edge.

on a 20-ft. span will carry 2,149 lb., limited by bending. The load producing a deflection of $\frac{1}{40}$ in. per foot of span is 1,236 lb., so that a deeper joist must be chosen. Since for dead load a modulus of elasticity may be used of only $\frac{3}{4}$ of that used for live load, the dead load of 18 lb. per sq. ft. will be multiplied by the factor $\frac{4}{3}$ giving 24 lb. per sq. ft., making a total loading of 84 lb. per sq. ft., and a total load of 2,240 lb. to be considered as producing deflection. Again, entering the tables it is found that the safe load for a 2×14 in., as limited by deflection, is 2,153 lb. This load, while slightly under the required loading, will be taken as satisfactory, and 2×14 -in. joists used.

Typical Joist B.—Since the ceiling must be continuous, the same size of joists will be continued for the shorter span.

Header H.—The load coming on this beam from the floor is a girder load. Consequently, the uniformly distributed floor load = $(14)(8)(68) = 7,616$ lb. The partition lumber will weigh 18 lb. per lin. ft. (see Table 9). Adding plaster

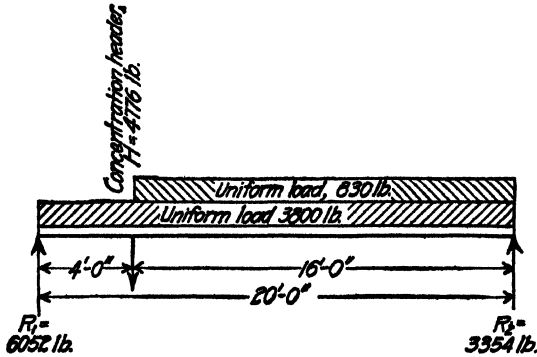

FIG. 179.—Diagram of loads on Trimmer C.

for two sides at 5 lb. per sq. ft. per side, gives a total load per linear foot of $18 + (12)(10) = 138$ lb. The partition load on the header therefore = $(14)(138) = 1,930$ lb. Total load on header = 9,546 lb. It is found that a 4×14 -in. timber on a 14-ft. span will carry 9,764 lb. in bending, and 9,415 lb. as limited for deflection. Again reducing the dead load to equivalent live load, we have,

$$\begin{aligned} (14)(8)(20)(1\frac{1}{3}) &= 2,987 \\ (1,930)(1\frac{1}{3}) &= 2,570 \\ \text{Live load} &= (14)(8)(48) = 5,370 \\ &= \underline{10,927 \text{ lb.}} \end{aligned}$$

This load is 16 per cent in excess of the limiting load for deflection for a 4×14 in. On the other hand, the safe load as limited by deflection for a 6×14 in. is 13,808 lb., which is 47 per cent too heavy, and the actual span is 13 ft. 8 in. instead of 14 ft. 0 in. A 4×14 in. will therefore be used.

Trimmer C.—Uniform partition load = $(138)(20) = 2,760$

$$\text{Uniform floor load} = \frac{(20)(1\frac{1}{3})(78)}{2} = 1,040$$

$$\text{Total uniform load} = \underline{3,800 \text{ lb.}}$$

TABLE 9.—STUD PARTITIONS¹
 Weight and strength based on actual size
 Board measure based on nominal size
 Add weight of plaster or ceiling
 Single plate top and bottom included, same size as studs
SAFE LOAD BASED ON STUDS BEING BRIDGED AT CENTER

Nominal size	Actual size	Distance on centers (in.)	Height (ft.)	Per linear foot of partition		
				Safe load (lb.)	Weight (lb.)	Board ft.
2 × 4	1½ × 3½	12	8	3,723	16.30	6.66
		12	10	3,180	19.56	8.00
		12	12	2,631	22.82	9.33
		16	8	2,793	13.04	5.33
		16	10	2,385	15.50	6.33
		16	12	1,974	18.00	7.33
2 × 6	1½ × 5½	12	8	5,767	25.30	10.00
		12	10	4,926	30.56	12.00
		12	12	4,076	35.42	14.00
		16	8	4,326	20.24	8.00
		16	10	3,699	24.03	9.50
		16	12	3,057	27.83	11.00
2½ × 6	2½ × 5½	12	8	8,568	33.20	12.50
		12	10	7,767	39.84	15.00
		12	12	6,871	46.48	17.60
		16	8	6,426	26.56	10.00
		16	10	5,825	31.56	12.00
		16	12	5,153	36.52	13.75
3 × 6	2½ × 5½	12	8	11,388	41.00	15.00
		12	10	10,516	49.20	18.00
		12	12	9,689	57.20	21.00
		16	8	8,541	32.80	12.00
		16	10	7,887	38.95	14.25
		16	12	7,267	45.10	16.50
2 × 8	1½ × 7½	12	8	7,692	33.80	13.33
		12	10	6,570	40.56	16.00
		12	12	5,436	47.32	18.66
		12	14	4,315	54.08	21.33
		16	8	5,769	27.04	10.66
		16	10	4,927	32.11	12.66
2½ × 8	2½ × 7½	12	12	4,077	37.18	14.66
		12	14	3,236	42.25	16.66
		16	8	11,429	44.30	16.66
		16	10	10,361	53.16	20.00
		16	12	9,165	62.02	23.33
		16	14	8,066	70.88	26.66
3 × 8	2½ × 7½	16	8	8,572	35.44	13.33
		16	10	7,771	42.08	15.33
		16	12	6,874	48.73	18.33
		16	14	6,049	55.37	20.33
		12	8	15,181	54.70	20.00
		12	10	14,019	65.64	24.00
3 × 8	2½ × 7½	12	12	12,916	76.58	28.00
		12	14	11,814	87.52	32.00
		16	8	11,386	43.76	16.00
		16	10	10,514	51.96	19.00
		16	12	9,687	60.17	22.00
		16	14	8,860	68.37	25.00

¹ From the Southern Pine Manual.

Since there is a concentrated load on this header, also a portion of a uniform load, in addition to the uniform floor load figured above, we will compute the maximum bending moment. Figure 179 represents the actual loadings diagrammatically.

The live load acting as a concentration (the reaction of Header *H*) is a girder load for which a 20 per cent reduction may be taken from the live load for joists.

The concentrated load at *P* is, therefore,

$$\begin{aligned} \text{Floor} &= (7)(8)(68) = 3,810 \\ \text{Partition} &= (138)(7) = \underline{966} \\ &4,776 \text{ lb.} \end{aligned}$$

The portion of uniform load on the trimmer not yet considered = $(78)(16)(\frac{3}{4}) = 830$ lb.

Bending moments and reactions:

Uniform load of 3,800 lb.

$$\begin{aligned} M &= (\frac{1}{8})(3,800)(20) = 9,500 \text{ ft.-lb.} \\ R_1 = R_2 &= 1,900 \text{ lb.} \end{aligned}$$

Concentrated load:

$$\begin{aligned} R_1 &= \frac{(4,776)(16)}{20} = 3,820 \\ R_2 &= \frac{(4,776)(4)}{20} = \underline{956} \\ &4,776 \text{ lb.} \\ M &= (3,820)(4) = 15,280 \text{ ft.-lb.} \end{aligned}$$

Small uniform load:

$$\begin{aligned} R_1 &= \frac{(830)(8)}{20} = 332 \text{ lb.} \\ R_2 &= \frac{(830)(12)}{20} = 498 \text{ lb.} \\ M &= (332)(4) = 1,328 \text{ ft.-lb. (approximately)} \end{aligned}$$

Figure 180 shows the bending moment curves plotted graphically.

The construction of the parabola of uniform moments is simple, a rectangle being erected on the span with a height of 9,500 ft.-lb. to scale. The ends and half spans are divided into the same number of equal parts (in this case 4), ordinates erected on the span length at these division points, and radiating lines drawn from the center of upper side of rectangle to the division points on the sides. The intersection of corresponding radiating lines and ordinates fixes points on the parabola. The triangle of moment for the concentrated load is indicated by the dotted line. This triangle is increased for the moment of the small uniform load (increase in moment = 1,328 ft.-lb. at a point 4 ft. from left support). The moment of the small load is also computed at a point 8 ft. from the right end of trimmer. $M = (12)(332) - (4)(415) = 2,324$ ft.-lb. The ordinate to the triangle of the moment of *P* is therefore increased by 1,328 ft.-lb., and the full line drawn to represent the increased bending moment, passing through the point 8 ft. from left support that represents the increased ordinate of 1,328 ft.-lb.

From the diagram, the maximum bending moment is 22,680 ft.-lb. Since the depth of floor construction is limited to 14 in., it is evident from the computations for the joists that a fiber stress of 1,800 lb. per sq. in. cannot be used without exceeding the allowed deflection. In the case of Joist "A" a 2 × 14-in. joist was used when for strength a 2 × 12 in. was found to be satisfactory. The ratio of the strengths of these two joists is $\frac{3,190}{2,149}$. In other words, the fiber stress in the 2 × 14-in. joist approximately = $\left(\frac{2,149}{3,190}\right) (1,800) = 1,215$ lb. per sq. in. A fiber stress of 1,200 lb. per sq. in. will therefore be used for an approximate solution. An 8 × 14-in. beam, sized to 7½ × 13½, has at 1,200 lb. per sq. in. a safe resisting moment of 22,781 ft.-lb., which is satisfactory.

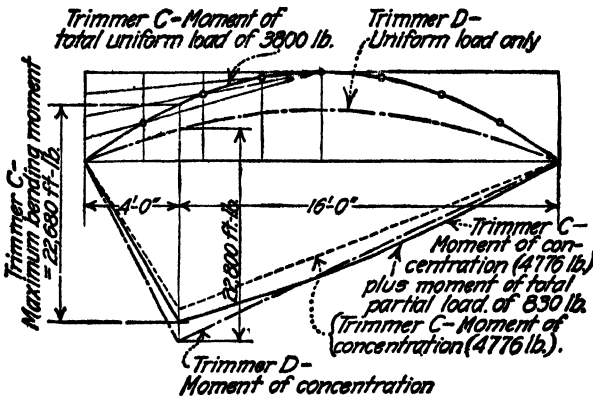

FIG. 180.—Diagram of bending moments for Trimmers C and D.

Trimmer D.—The calculations for Trimmer D are similar to those for Trimmer C. No uniform partition load occurs on the trimmer. However, there exists a stair load at the left-hand end. The dead and live load for the stairs will be assumed at 75 lb. per sq. ft. [(L. L. 75)(80 per cent) + (D. L. 15)] = 75 lb. per sq. ft. The reaction of the stairs will therefore = (7)(4)(75) = 2,100 lb., carried by two stringers. Only the reaction of one stringer, applied 4 ft. out from the left end, need be considered. This concentration, added to the concentration from Header H, gives a total concentration of 4,776 + 1,050 = 5,826 lb.

For simplicity it will be assumed that Trimmer C takes a load equal to that of Joist "A," or 2,080 lb.

$$M = \left(\frac{1}{8}\right)(2,080)(20) = 5,200 \text{ ft.-lb.} \quad R_1 = R_2 = 1,040 \text{ lb.}$$

Concentrated load:

$$R_1 = \frac{(5,826)(16)}{20} = 4,660 \text{ lb.}$$

$$R_2 = \frac{(5,826)(4)}{20} = 1,165 \text{ lb.}$$

$$M = (4,660)(4) = 18,640 \text{ ft.-lb.}$$

The diagram for bending moments is shown by the dot and dash lines in Fig. 180. The maximum bending moment is approximately 22,800 ft.-lb., so an 8 × 14-in. timber will be used.

The maximum vertical shear is 5,700 lb. The maximum intensity of horizontal shear is therefore $\frac{(5,700)(1\frac{1}{2})}{(7\frac{1}{2})(13\frac{1}{2})} = 86$ lb. per sq. in., which is well within the permissible unit stress.

43. Roof Construction.

43a. Thickness of Sheathing.—Except in mill construction, the thickness of roof sheathing is seldom over 1 in. nominal, or $1\frac{3}{16}$ in. finished. For roofs with a finish of tar or asphalt and gravel, or prepared roofing, either built up on the job or ready roofing, the sheathing should be dressed and matched and of good quality, not less than No. 2 Common. The span of sheathing of this size is usually limited by deflection, rather than strength, although the strength should always be investigated. Roofs are always walked upon at some time or another, and appreciable deflection of the sheathing will tend to break off the tongues of tongue-and-grooved lumber. Shiplap, instead of tongue-and-grooved lumber, may be used. The two sections are shown in Figs. 181 and 182.



FIG. 181.—Section of 1 × 4-in. tongue and grooved flooring.

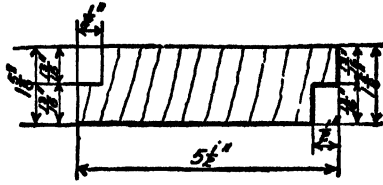

FIG. 182.—Section of 2 × 6-in. shiplap.

43b. Spacing of Roof Joists.—If the roof joists support the ceiling also, their spacing should not exceed 16 in., as this is the limiting span for wooden laths with plaster ceiling.

On the Pacific Coast, where no snow, or at most very light snow occurs, the spacing of roof joists, when no ceiling must be provided for, is commonly taken at 24 in., and in cheap construction the spacing is made 32 in.

43c. Arrangement of Girders or Trusses.—The arrangement of girders and trusses is a matter worthy of study in any building. Usually there are requirements of interior arrangement which dictate the spacing of columns.

Trusses are most economically spaced at approximately 16 to 20 ft. Three methods of framing the roof joists or rafters may be adopted: (1) supporting the joists directly on the upper chords; or (2) placing roof girders or purlins at the panel points of the trusses, and spanning the bays between purlins by light rafters; or (3) providing purlin trusses at certain panel points and spanning between the purlin trusses by means of rather heavy rafters, or roof joists. There are, naturally, advantages and disadvantages to each system. Considering vertical loads above, the particular building involved may carry with it some special reason for adopting one method in preference to the others. From the standpoint of cost alone, it will usually be found upon investigation that, if the different systems are designed correctly and consistently, there will be little difference in cost. In some localities, the relatively high price of steel compared to lumber may warrant a minimum of truss work and the employment of larger sizes of lumber. In other localities the cost of securing the larger sizes of joists may make small spans advisable. No hard and fast rule can be laid down.

43d. Bracing Trusses.—Bracing trusses are a necessity in long truss spans; in fact, the writer recommends that all roof trusses over 20-ft. span be provided with at least one bracing truss, and that, in general, bracing trusses be placed at a spacing not greater than 15 or 16 ft. The bracing trusses may be utilized as purlin trusses if properly proportioned. They should be of the full depth of the main truss, and well connected thereto. The compression chord of a main roof truss needs to be supported laterally for column action; the lower chord should also be stayed laterally for general stiffness of the building, if for no other

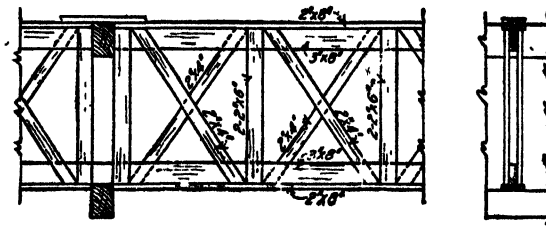

FIG. 183.—Detail of typical roof bracing truss.

reason. Such bracing trusses may be made up of dimension lumber and spiked or bolted together, and thus give a comparatively cheap and, at the same time, effective construction. A typical example of such a bracing truss is shown in Fig. 183. Attention is called to the "T" section of chords, also to the details for connection to the main trusses.

Another method for providing general stiffness in the roof framing is shown in Fig. 184. In this detail the roof joists are doubled at certain intervals; braces or struts are framed between the double joists, and the bottom of these struts fitted against and attached to the lower chords of the truss.

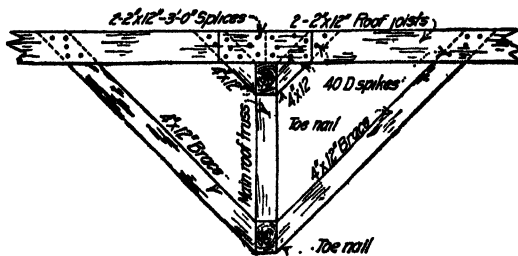

FIG. 184.—Knee brace system of truss bracing.

The actual stresses coming upon a bracing truss are usually indeterminate. With study of the roof-framing plan, however, a definite scheme of wind bracing may be provided, in which the bracing trusses will play a vital part. The whole roof, or one side of the roof, may be regarded as a horizontal beam, or truss, transferring the wind reactions delivered thereto from the side walls to the end walls, or to columns and walls. Following out this scheme, diagonal rods may be placed in the plane of the upper chords of the roof trusses.

Figure 185 shows an arrangement of roof trusses, bracing trusses and diagonal rods for an assumed small building of the mill-building type. When the length of a building is three or more times its breadth, and such building is only moderately high, the diagonal rods may very frequently be omitted in some of the outer,

side bays. It may also be possible, without endangering the rigidity of the building, to make some of the lines of bracing trusses non-continuous throughout the length of the building. For example, in Fig. 185, were the building twice as long as shown, it might be entirely consistent with safety to omit alternate bracing trusses in the first and third lines, keeping the center line of bracing continuous. It must be obvious that the exact arrangement of bracing in a roof is almost entirely a matter of judgment, but judgment based on an understanding of the fundamental principles of structural mechanics and experience in design and construction. While it is granted that the actual stresses in a roof due to wind are impossible to find, an assumption of a reasonable wind pressure and a definite and logical system of bracing consistently followed out in all details will insure a much safer structure than a "hit or-miss" or "rule-of-thumb" procedure, and will also result in a more economical building than one composed of heavier sections, poorly braced.

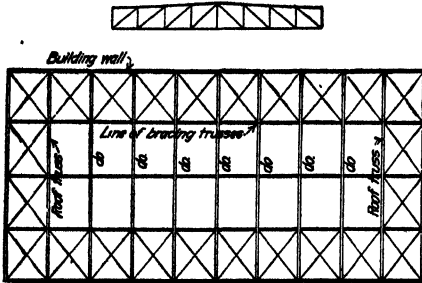

FIG. 185.—Diagrammatic plan of typical roof bracing.

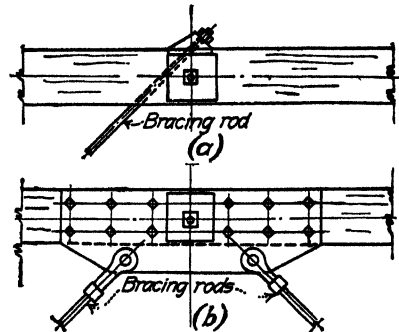

FIG. 186.—Typical details of connection of bracing rods to upper chord of roof truss.

Two typical details of connections of such diagonal rods to the roof trusses are shown in Fig. 186. In Fig. 186 (a) the rods are passed through holes bored diagonally through the chord, and fitted with special beveled cast-iron washers. In Fig. 186 (b) a steel plate is lag-screwed to the chord, and connection between plate and rods is secured by means of clevises and pins. If the roof joists are supported directly upon the upper chord, these plates will probably have to be attached to the lower side of chord. In such a case, the plates should be fastened to the chord while the truss is on the ground. It may be taken for granted that such connection, if made after the truss is erected, will be poor. It is difficult, at best, to make a carpenter screw lag-screws into place, and it is almost certain, if placed by a man on a scaffold, that the work will be poorly done.

Obviously, the system of diagonal bracing rods just described may be placed in the plane of the lower chords of the trusses, provided that bracing trusses exist to form the chords of the wind resisting truss. Provision must be made for supporting the rods to prevent them from sagging.

Diagonal rods in the plane of the roof framing, placed in the outer bays, are an excellent thing; they enable the building to be "squared up" and will do much to prevent racking of the roof due to wind, with possible consequent breaking of skylights. Re-tightening of these bracing rods will be necessary from time to time as shrinkage of the timber takes place.

43e. Saw-tooth Roof Framing.—Saw-tooth roofs are constructed with inclined or vertical faces, the former being perhaps more generally used than the latter on account of better diffusion of light. From the standpoint of maximum efficiency in diffused lighting, the saw-teeth should face north with the faces inclined at an angle of 25 to 30 deg. with the vertical.

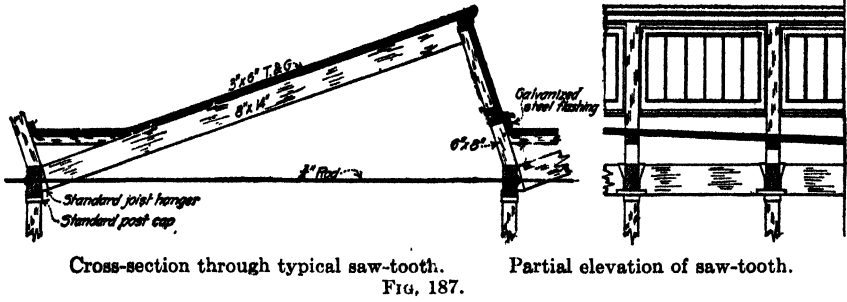

Cross-section through typical saw-tooth.
FIG. 187.

Partial elevation of saw-tooth.

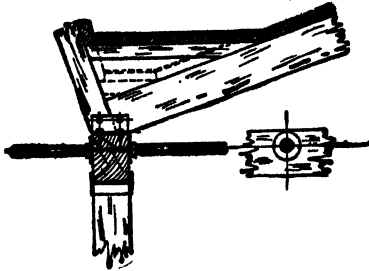

FIG. 188.—Detail of saw-tooth frame—
inclined face with pipe ties.

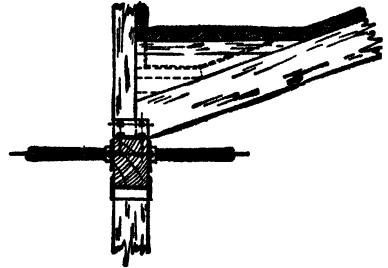

FIG. 189.—Detail of saw-tooth frame—
vertical face with pipe ties.

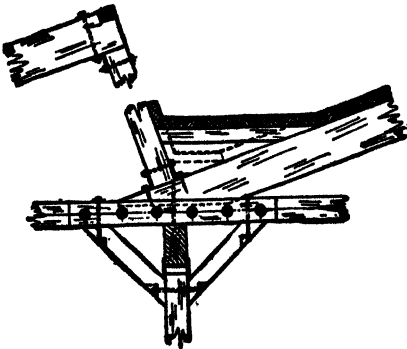

FIG. 190.—Detail of saw-tooth frame—
inclined face with timber ties.

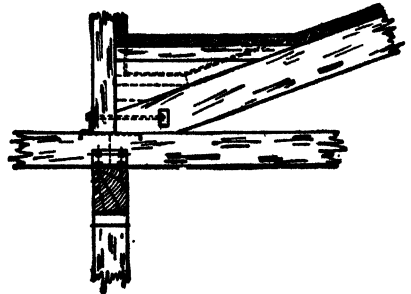

FIG. 191.—Detail of saw-tooth frame—
vertical face with timber ties.

The saw-tooth with vertical face is somewhat easier to construct and is less likely to give trouble through leakage and condensation than the inclined face construction. In the latter type, there should be no horizontal mullions in the windows, since water would stand on these and eventually leak through. Further, condensation will tend to take place on the inner side of the inclined glass and drop vertically on the contents of the building.

In both types of construction, careful attention must be given to the design of the windows, whether fixed or movable sash. The flashing should run under the window sill and form an inside condensation gutter discharging into conductors. Double glazing is sometimes employed in the more northerly latitudes on account of its non-conducting qualities.

Some typical details of saw-tooth roofs are shown in Figs. 187, 188, 189, 190 and 191.

The roof planking should be at least 3 in. in thickness, tongued-and-grooved or splined, spanning 8 to 10 ft. between the inclined roof beams. The valleys between the saw-teeth should have an inclination of not less than $\frac{1}{2}$ in. to the foot, and the conductors should be spaced not more than 50 ft. apart. The construction of the sloping valleys is easily accomplished by blocking between the structural members of the frame.

Figure 187 illustrates a typical construction with inclined faces. The roof joists are supported at their upper ends on inclined posts, and at their lower ends by joist-hangers on the roof girders. Tie rods are shown at the foot of each inclined roof beam to prevent the roof from spreading. While the construction shown in this figure may be termed standard, objection can be raised (1) to the use of joist-hangers, (2) to the use of small tie rods exposed to fire and tending to sag, (3) to the absence of any horizontal members at the top of posts to take thrust, and (4) to the absence of general stiffness of frame to horizontal forces.

In Figs. 188 and 189 the above objections are largely met by bringing the inclined roof beams to rest on the top of the girders and the substitution of pipe ties between the roof girders. These pipe ties, fitted with standard flanges and bolted through the girders, have the advantage over rods of being able to take both tension and compression and also of not requiring hangers to prevent them from sagging. These pipes, however, must be of fairly large size in order that they may be of value as compression members. The ratio of length of member to radius of gyration should not exceed 175. This construction, however, still gives metal exposed to fire.

Figures 190 and 191 illustrate an all-timber type of construction. These details, drawn for both the inclined and vertical face types of saw-tooth, furnish a simple and effective construction. A somewhat higher building is required by this construction than with that of Fig. 187 but the general stiffness gained, and the absence of exposed metal, will more than offset the cost of increased height of walls.

44. Mill Construction.¹—The preceding discussion in this chapter has related to timber framed floors and roofs in general. This article treats very briefly and in a general way of the special type of construction known as "Mill Construction," or "Slow-burning Mill Construction," so-called because it was developed for use in factory or mill buildings in the New England states. In this construction all timbers, as posts, girders, and joists, are made of large section; joists are eliminated as far as possible, by substituting a heavy thick floor sufficient in strength to span some feet. The result gives a building having large areas of flat ceilings, and heavy solid masses of timber in girders and posts. Such a structure in case of fire tends to char rather than burn, and all parts are easily

¹ See also the following chapter.

reached by the water from the automatic sprinklers. This type of building, properly sprinkled, takes a comparatively low insurance rate.

In the bulletin, "Heavy Timber Mill Construction Buildings," published by the Engineering Bureau of the National Lumber Manufacturers Association, mill construction is divided into three classes as follows (see Figs. 192 to 196 inclusive):

1. Floors of heavy plank laid flat upon large girders which are spaced from 8 to 12 ft. on centers. These girders are supported by wood posts or columns spaced from 16 to 25 ft. apart. This type is often referred to as "Standard Mill Construction."

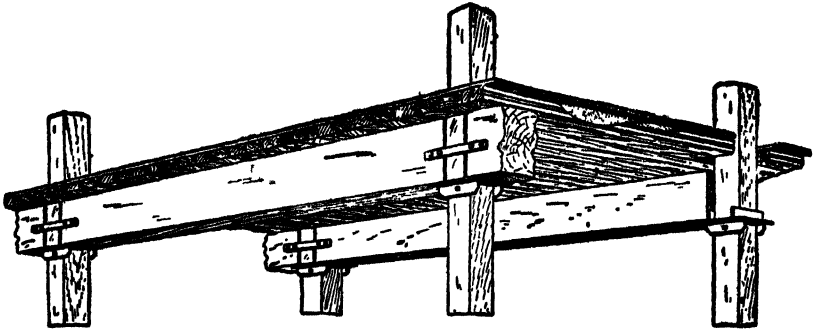

FIG. 192.--Standard mill construction.

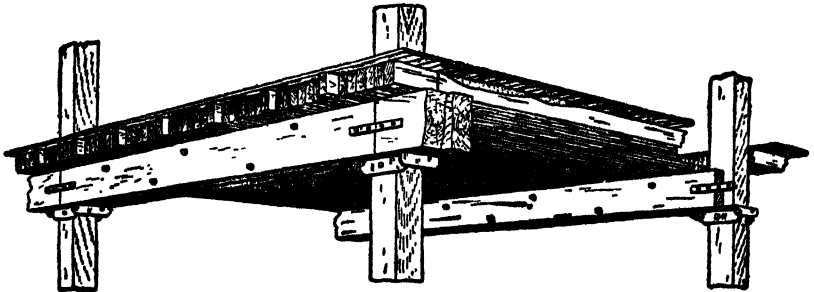

FIG. 193.—Mill construction with laminated floor.

2. Floors of heavy plank laid on edge and supported by girders which are spaced from 10 to 20 ft. on centers. These girders are supported by wood posts or columns spaced 16 ft. or over apart, depending upon the design of the structure. This type is called "Mill Construction with Laminated Floors."

3. Floors of heavy plank laid flat upon large beams which are spaced from 4 to 10 ft on centers and supported by girders spaced as far apart as the loading will allow. These girders are carried by wood posts or columns located as far apart as consistent with the general design of the building. A spacing of from 20 to 25 ft. is not uncommon for columns in this class of framing where the loading is not excessive. This type is more generally known as "Semi-mill Construction."

The following clauses from the Building Code recommended by the National Board of Fire Underwriters also define in detail the timber construction classed as mill constructions:

Definition.—"Mill" Construction (also called "Slow-burning Construction") is a term applied to buildings having masonry walls and heavy timber interior construction with no concealed spaces. Such buildings are usually occupied for factory purposes, and should always be protected by a system of automatic sprinklers.

Columns.

(a) Wooden columns shall be not less than 8 in., nominal, in any dimension. All corners shall be rounded or chamfered.

(b) Column and girder connections shall be of fire-resistive construction or protected by approved materials and methods having a fire-resistance rating of not less than 1 hr. Wooden bolsters may be used only to support roofs.

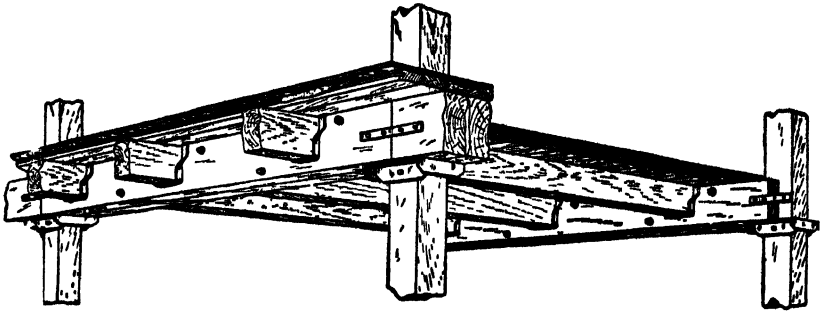

FIG. 194.—Semi-mill construction, beams in hanger

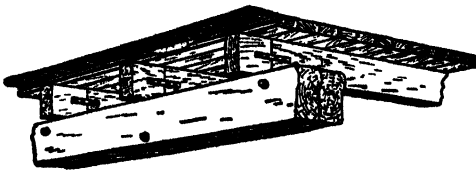

FIG. 195.—Semi-mill construction, beams on top of girders.

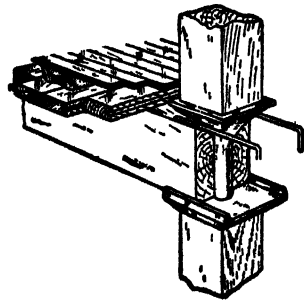

FIG. 196.—Detail of column and girder construction with cast-iron pintle.

(c) Steel and cast-iron columns may be used, if protected as follows: Iron and steel columns placed within exterior walls or along the outer lines of a building shall be protected by approved masonry not less than 4 in. thick, provided the interior faces may be protected as hereinafter specified for columns in the interior of the building. For the protection of iron or steel columns in the interior of a building, brickwork shall be not less than $3\frac{3}{4}$ in. thick; concrete shall be not less than 2 in. thick; hollow clay tile shall be not less than 2 in. thick, and, when single-shell tile is used, it shall be plastered on the exposed surfaces with gypsum-mortar or cement-mortar at least $\frac{1}{2}$ in. in thickness, or, when double-shell tile is used, it may be unplastered; poured gypsum or solid gypsum block shall be not less than 2 in. thick, and cored gypsum blocks not less than 3 in. thick. The fireproofing material shall be in contact with the member to be protected, or the

spaces between the fireproofing and the member to be protected shall be filled with concrete or mortar. No fireproofing material for the protection of iron or steel columns shall be less than 2 in. thick in any case, provided the outer edges of lugs and brackets may extend not nearer than $1\frac{1}{2}$ in. to the outer surface of the protecting material.

(d) Columns shall not rest on floor timbers; nor shall they rest on masonry foundations unless stone, cast-iron or steel bases are used to transmit their loads.

Beams and Girders.

(a) Beams and girders of wood shall be not less than 6 in. in least dimension or less than 10 in. in depth. If built up of two or more pieces, they shall be properly bolted together and precaution shall be taken to prevent decay of contact faces.

(b) Wall plates, boxes of self-releasing type or approved hangers, shall be provided where beams or girders rest on walls.

(c) Where girders meet columns, they shall be fitted around them or butted up close to them. The ends of girders shall be held in place by steel or iron straps, spiked, bolted or lag screwed on their sides unless the post caps have sides projecting upward that can be lag screwed to the girders.

(d) Where intermediate beams are found necessary for the support of a floor, they shall rest on top of the girders; or they may be supported by approved steel or iron hangers into which the ends of beams shall be closely fitted. Interstices between beams framed together shall be filled in with a preservative compound.

(e) Steel beams, girders, lintels and trusses may be used if protected as provided in this article for fireproof construction or semifireproof construction.

(f) Wooden beams and girders supported by walls shall have at least 8 in. of masonry between their ends and the outside face of the wall. Where beams enter walls from opposite sides, there shall be at least 8 in. of masonry between sides of adjacent beams.

Floors.

(a) Floors shall be constructed of splined or tongued and grooved plank not less than 3 in. in thickness, covered with 1-in. flooring laid crosswise or diagonally; but this shall not preclude the use of laminated floors, consisting of planks not less than 4 in. wide, set on edge close together and spiked at intervals of 18 in. In laminated floors the planks shall be laid with broken joints so that no continuous line will occur across the floor. Laminated floors shall not be spiked to the supporting girders. Joints of the planking shall be over supports or at the quarter points with no more than two-thirds of the joints at such quarter points. Joints between planks shall be perfectly tight.

(b) Flooring shall not extend closer than $\frac{1}{2}$ in. to walls, and the space thus left shall be covered by a molding that will not obstruct an expansive movement of the floor due to wetting, or the masonry may be corbeled under the floor planks to cover this space.

(c) Floors shall have the least possible number and amount of openings, and these shall in all cases be protected by shafts or in some other approved manner.

Roofs.

(a) Roofs shall be constructed the same as floors except that the plank shall be not less than $2\frac{1}{2}$ in. thick, and beams supporting the roof shall be not less than 6 in. in either dimension.

Power Drives.

(a) All belt or rope drives used to transmit power from one story to another shall be located in belt towers. Such towers shall be constructed as shafts. Shaft holes and belt-drive holes through walls shall be protected with self-closing doors.

Partitions.

(a) In buildings of heavy-timber construction, fire partitions, if required in a story as a horizontal exit, shall be continuous through all stories from the foundation to the roof.

(b) Such fire partitions shall be deemed continuous, even though the several parts are not directly over one another in successive stories if the intervening parts of the floors at the levels where offsets occur are unpierced and of fireproof construction or semifireproof construction and all parts not supported directly on the foundations are carried on fireproof construction.

Condition of Timber.

Wood used in heavy-timber construction shall be thoroughly seasoned and dry and shall be installed in such manner as to prevent dry rot or rapid decay. No paint or finish of any kind shall be applied until timbers are thoroughly seasoned.

The following description of laminated floors is taken from the bulletin of the National Lumber Manufacturers Association referred to above:

If heavy loads are to be carried on long spans, planks 6 or 8 in. wide are set on edge close together, firmly nailed at each end and at about 18-in. intervals with 60-D nails, alternating top and bottom, thus forming a "laminated floor." Each of these floors is covered with two or more thicknesses of waterproof paper or similar material and then by a top, or wearing floor laid at right angles to the direction of the underfloor. Material is surfaced on all sides and edges of plank beveled to serve as a finish on the ceiling below.

Where plank floors are laid flat, the boards should be two bays in length if possible and laid to break joints every 4 ft. With laminated floors, it may be difficult to obtain plank bays in length. In such a case, the planks may be laid with the ends extending between centers of girders with one plank laid across the girder at frequent intervals (every sixth or eighth piece) to act as a tie in the floor. Or, by another method, the ends of planks should join at or near the quarter point of the span between girders, taking care to break joints in such a way that no continuous line across the floor will occur.

In laying laminated floors, it is advisable to omit the last two planks at walls until after glazing and roofing have been completed. Then these spaces should be filled in close against the walls. It is often recommended that laminated floors be laid without nailing to the girders which support the floor, so that expansion in the floors due to dampness will not cause movement in the girders at the walls.

The top floor may be of softwood or hardwood as use demands. Tongued and grooved flooring is used almost entirely. Square-edged flooring is easier to replace when repairs are needed, but wears less around nails, thus making an uneven floor. Some of the best buildings have a double top floor, the lower part of softwood laid diagonally upon the plank under floor, and the hardwood upper part laid lengthwise. This latter method allows boards in alleys or passages to be easily replaced when worn, and the diagonal boards brace the floors, reduce vibration, and distribute the floor load evenly. The top floor should always be laid so that the length of the pieces is parallel to the direction of the traffic or trucking. Usually this is lengthwise of the building.

When a laminated floor is constructed of material surfaced four sides, or of material surfaced two sides, there is great danger of dry rot, unless the lumber is thoroughly air seasoned or kiln dried. On account of this feature, many engineers prefer to use only rough lumber for laminated floors, the slight unevenness of the boards or planking providing enough air spaces to prevent dry rot. It is the

TABLE 10.—MAXIMUM SPANS FOR TIMBER MILL FLOORS¹

Fiber stress 1,200, 1,300, 1,500, 1,600 and 1,800 lb. per sq. in.; modulus of elasticity, 1,600,000 lb. per sq. in.

The sum of the live load and the weight of the floor was used in calculating the spans.

In the line marked deflection is given the span that has a deflection of 1/40 in. per ft. of span.

Made of planks on edge, laid close.

Fiber stress (lb. per sq. in.)	Span in feet and inches Live load in pounds per square foot											
	50	100	125	150	175	200	225	250	275	300	350	400
(3 in. nominal thickness—2 3/4 in. actual thickness)												
1,200	13- 8	10- 1	9- 1	8- 4	7- 9	7- 3	6-10	6- 6	6- 3	6- 0	5- 7	5- 2
1,300	14- 3	10- 6	9- 6	8- 8	8- 1	7- 7	7- 2	6-10	6- 6	6- 3	5- 9	5- 5
1,500	15- 4	11- 3	10- 2	9- 4	8- 8	8- 2	7- 8	7- 4	7- 0	6- 8	6- 2	5-10
1,600	15-10	11- 8	10- 6	9- 7	8-11	8- 4	7-11	7- 7	7- 2	6-11	6- 5	6- 0
1,800	16- 9	12- 4	11- 2	10- 3	9- 6	8-11	8- 5	8- 0	7- 8	7- 4	6- 9	6- 4
Defl.	9- 0	7- 4	6-10	6- 5 1/2	6- 1 1/2	5-10 1/2	5- 8	5- 6	5- 4	5- 2	4-11	4- 8 1/2
(4 in. nominal thickness—3 3/4 in. actual thickness)												
1,200	18- 5	13- 8	12- 4	11- 5	10- 7	10- 0	9- 5	9- 0	8- 7	8- 3	7- 7	7- 2
1,300	19- 2	14- 3	12-11	11-10	11- 0	10- 4	9-10	9- 4	8-11	8- 7	7-11	7- 5
1,500	20- 7	15- 4	13-10	12- 9	11-10	11- 2	10- 6	10- 0	9- 7	9- 2	8- 6	8- 0
1,600	21- 3	15-10	14- 4	13- 2	12- 3	11- 6	10-11	10- 4	9-11	9- 6	8-10	8- 3
1,800	22- 7	16- 9	15- 2	13-11	13- 0	12- 2	11- 7	11- 0	10- 6	10- 1	9- 4	8- 9
Defl.	12- 2 1/2	10- 0	9- 4 1/2	8-10 1/2	8- 5 1/2	8- 1 1/2	7- 9 1/2	7- 6 1/2	7- 4	7- 1 1/2	6- 9 1/2	6- 6
(5 in. nominal thickness—4 3/4 in. actual thickness)												
1,200	22-10	17- 8	15- 7	14- 5	13- 5	12- 7	11-11	11- 4	10-10	10- 5	9- 8	9- 1
1,300	23-10	17-11	16- 3	14-11	13-11	13- 1	12- 5	11-10	11- 4	10-10	10- 1	9- 5
1,500	25- 7	19- 3	17- 5	16- 1	15- 0	14- 1	13- 4	12- 8	12- 2	11- 8	10-10	10- 2
1,600	26- 5	19-11	18- 0	16- 7	15- 6	14- 7	13- 9	13- 1	12- 6	12- 0	11- 2	10- 6
1,800	28- 0	21- 1	19- 1	17- 7	16- 5	15- 5	14- 7	13-11	13- 4	12- 9	11-10	11- 1
Defl.	15- 3 1/2	12- 8	11-10 1/2	11- 2 1/2	10- 8 1/2	10- 3 1/2	9-11	9- 7	9- 4	9- 1	8- 7 1/2	8- 3
(6 in. nominal thickness*—5 1/2 in. actual thickness*)												
1,200	20- 3	18- 4	16-11	15-10	15- 1	14- 1	13- 5	12-10	12- 4	11- 6	10- 9
1,300	21- 1	19- 1	17- 8	16- 5	15- 8	14- 8	14- 0	13- 4	12-10	11-11	11- 2
1,500	22- 7	20- 9	18-11	17- 8	16-10	15- 9	15- 0	14- 4	13- 9	12-10	12- 0
1,600	23- 4	21- 3	19- 7	18- 3	17- 5	16- 4	15- 8	14-10	14- 3	13- 3	12- 5
1,800	24- 9	22- 6	20- 9	19- 4	18- 5	17- 3	16- 5	15- 9	15- 1	14- 0	13- 2
Defl.	14-11	14- 0	13- 3	12- 8	12- 2	11- 9	11- 4 1/2	11- 0 1/2	10- 9	10- 2 1/2	9- 9 1/2

¹ From Southern Pine Manual.

* Use for laminated floors when made of 6 X 6 pieces.

TABLE 11.—MAXIMUM SPANS FOR TIMBER LAMINATED FLOORS¹

Fiber stress 1,200, 1,300, 1,500, 1,600 and 1,800 lb. per sq. in.; modulus of elasticity, 1,600,000 lb. per sq. in.

The sum of the live load and the weight of the floor was used in calculating the spans.

In the line marked deflection is given the span which has a deflection of $\frac{1}{80}$ in. per ft. of span.

Made of planks on edge, laid close.

Fiber stress (lb. per sq. in.)	Span in feet and inches Live load in pounds per square foot										
	100	125	150	175	200	225	250	275	300	350	400
(3 in. nominal thickness*—5 $\frac{1}{4}$ in. actual thickness*)											
1,200	20- 8	18- 9	17- 4	16- 2	15- 3	14- 5	13- 9	13- 2	12- 8	11- 9	11- 0
1,300	21- 6	19- 6	18- 0	16-10	15-10	15- 0	14- 3	13- 8	13- 1	12- 2	11- 5
1,500	23- 1	21- 0	19- 4	18- 1	17- 0	16- 1	15- 4	14- 8	14- 1	13- 1	12- 3
1,600	23-10	21- 8	20- 0	18- 8	17- 7	16- 7	15-10	15- 2	14- 7	13- 6	12- 8
1,800	25- 3	23- 0	21- 2	19-10	18- 8	17- 8	16-10	16- 1	15- 5	14- 4	13- 6
Def.	15- 3	14- 3 $\frac{1}{2}$	13- 6 $\frac{1}{2}$	12-11 $\frac{1}{4}$	12- 5 $\frac{1}{2}$	12- 0	11- 7 $\frac{1}{2}$	11- 3 $\frac{1}{2}$	11- 0	10- 5 $\frac{1}{2}$	10- 0 $\frac{1}{2}$
(8 in. nominal thickness—7 $\frac{1}{2}$ in. actual thickness)											
1,200	26-10	24- 6	22- 8	21- 2	20- 0	19- 0	18- 1	17- 4	16- 7	15- 6	14- 7
1,300	27-11	25- 6	23- 7	22- 1	20-10	19- 9	18-10	18- 0	17- 4	16- 1	15- 2
1,500	30- 0	27- 5	25- 4	23- 9	22- 4	21- 2	20- 3	19- 4	18- 7	17- 4	16- 3
1,600	31- 0	28- 3	26- 2	24- 6	23- 1	21-11	20-10	20- 0	19- 2	17-10	16- 9
1,800	32-10	30- 0	27- 9	26- 0	24- 6	23- 3	22- 2	21- 2	20- 4	19- 0	17-10
Def.	20- 0	18-10	17-10 $\frac{1}{2}$	17- 1	16- 5 $\frac{1}{4}$	15-10 $\frac{1}{4}$	15- 4 $\frac{1}{2}$	14-11	14- 6 $\frac{1}{2}$	13-10	13- 3 $\frac{1}{2}$
(10 in. nominal thickness—9 $\frac{1}{2}$ in. actual thickness)											
1,200	20-10	19- 5	18- 3
1,300	21- 9	20- 3	19- 1
1,500	23- 4	21- 9	20- 5
1,600	24- 1	22- 5	21- 2
1,800	25- 7	23-10	22- 5
Def.	18- 3 $\frac{1}{2}$	17- 5 $\frac{1}{2}$	16- 9 $\frac{1}{2}$
(12 in. nominal thickness—11 $\frac{1}{2}$ in. actual thickness)											
1,200	22- 0
1,300	22-11
1,500	24- 7
1,600	25- 4
1,800	26-11
Def.	20- 2 $\frac{1}{4}$

¹ From Southern Pine Manual.

* For 6 X 6 pieces, use table for Mill Floors (Table 10).

writer's opinion that the rough flooring, besides being cheaper, will give additional security against the decay of the timber.

Tables 10 and 11 give the maximum spans for timber mill laminated floors for thicknesses varying from 3 in. nominal to 12 in. nominal, fiber stresses from 1,200 to 1,800 lb. per sq. in., and loads from 50 to 400 lb. per sq. ft.

In both these tables, the limiting span is given for a deflection of $\frac{1}{80}$ in. per foot of span, based on a modulus of elasticity of 1,600,000. Since mill floors in general have no ceiling, the deflections taken from this table may be used directly, although, if the permanent deflection is desired, a reduced modulus of elasticity for the constant loads should be used.

SLOW-BURNING TIMBER MILL CONSTRUCTION¹

Slow-burning mill construction² is the name applied to a long-used type of fire-resisting timber building common in New England, especially in textile mills. As now designed by the best mill engineers, it consists of brick walls, with heavy transverse wood beams, on top of which, for floors, are spiked thick planks at right angles to the beams, and these planks are covered with a top floor at right angles to the planks. The planks are grooved on both edges and so-called wood splines are tightly driven into the grooves of adjoining planks so that one plank will assist in the support of the next, thus stiffening the floor for isolated loads and preventing one plank from moving vertically relatively to the next (Fig. 198). The spaces between the beams or the "bays" should not be so wide as to require beams at right angles to the main beams, or any subdivision of the bays. A maximum bay width of 10 ft., except to accomplish a special object, is advisable. Wherever any metal is used it should always be deeply buried within the wood so that fire cannot reach it at first.

From the above it will be seen that real mill construction contemplates the smallest practicable number of heavy smooth beams covered with heavy smooth plank in turn covered with a top floor. The mass of such construction, the small amount of surface and the smoothness of the surfaces make this type of construction fire-resisting, and merit the name often applied to it, of being "slow-burning." Compared with this, the floor and roof construction consisting of planks on edge for beams and a foot or two apart are kindling wood. Mill construction also contemplates the entire absence of concealed spaces and the use of such spaces as can readily be reached by the spray from the smallest number of automatic sprinklers. It will readily be seen that the spaces between the beams of mill construction can be reached by a few sprinklers, while with the older construction, many times as many sprinkler pipes and heads are required to give protection, as every part must be reached by the spray.

The beams of mill construction afford opportunity for supporting shaft hangers, and the shaft hangers and the spaces between them give room for pulleys and belts. If short countershafts are to be put up, the wide flat surfaces between the beams afford an opportunity for attaching them.

45. Pinties over Columns Are Fundamental to Type.—The method of fastening the beams to each other where they butt together, and to the walls, is of great importance in securing rigidity. This must be considered in connection with the

¹ Appeared in *Engineering News-Record*, vol. LXXIX, No. 26, Dec. 27, 1917.

² See also the preceding chapter.

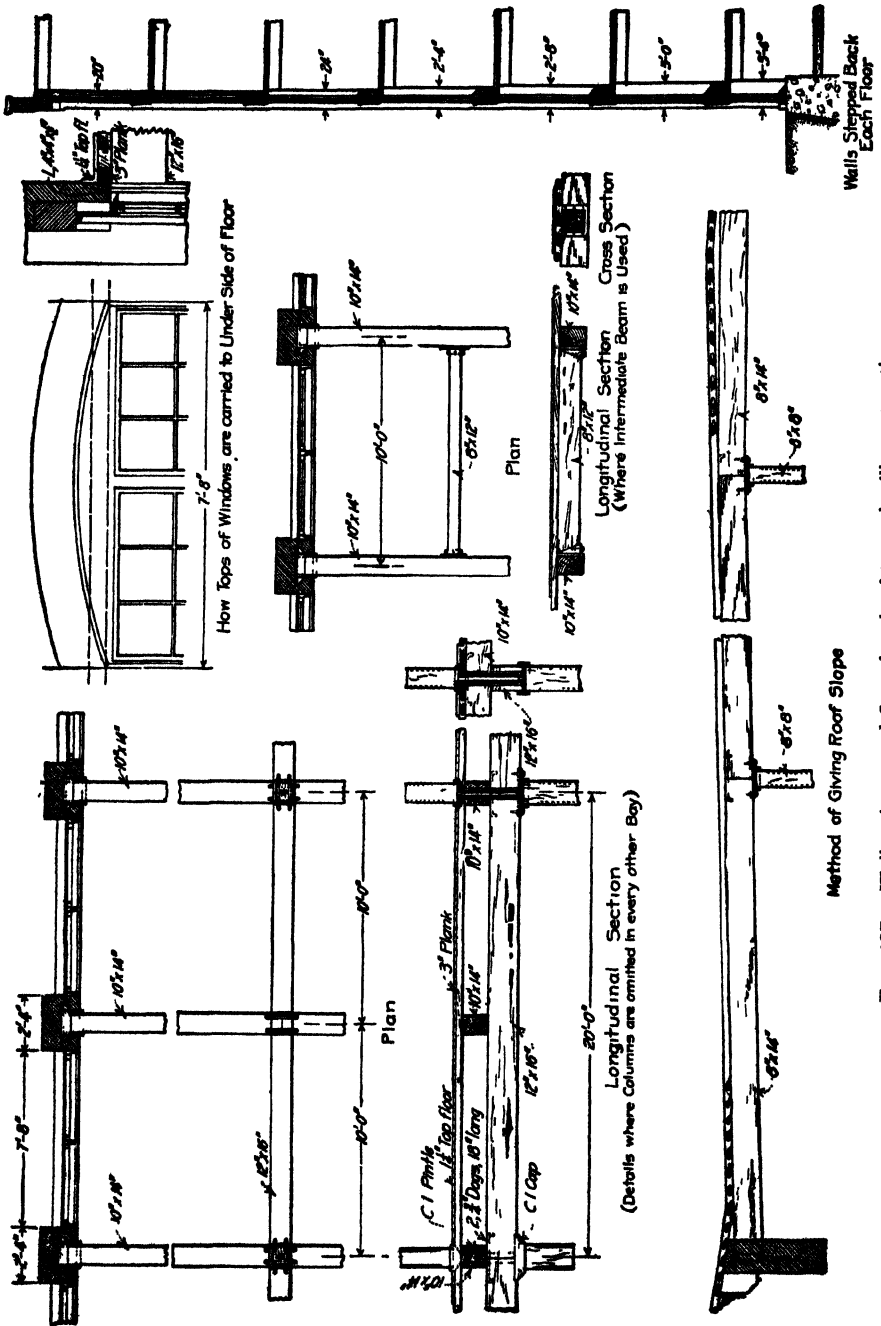

FIG. 107 — Wall column and floor details of terminal wall construction.

columns, and it is with respect to these and connecting the beams together that architects unversed in this type invariably fail. It is well understood that columns should rest end to end upon each other from top to bottom of buildings, but the columns themselves should not pass through the floors and between the ends of the beams, as is often done. Proceeding upward they should stop at the bottoms of the beams, and begin again at the tops. Between the top of one column and the bottom of the one above it there should be a short separate cast-iron column known as a "pintle" (Fig. 198). Being of cast iron, which is a

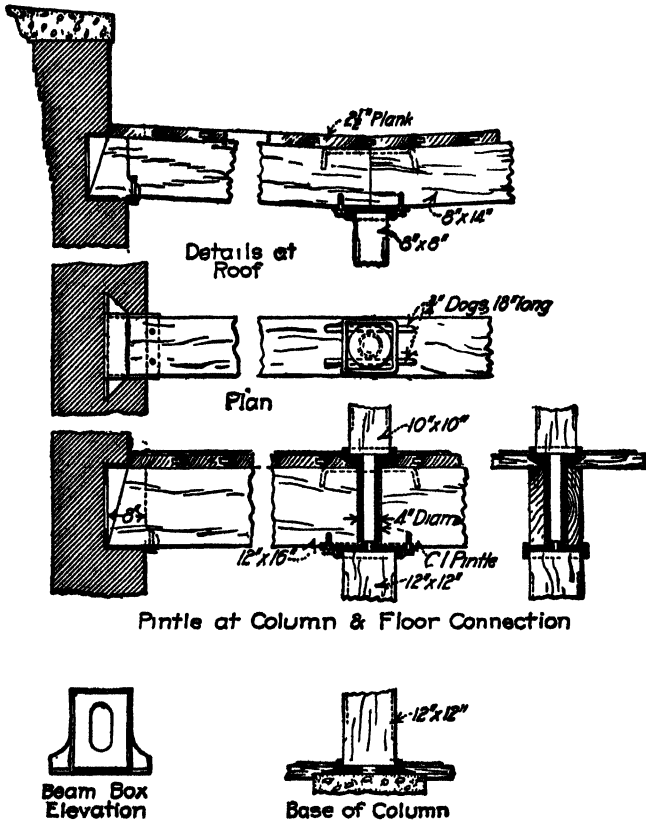

Fig. 198.—Some special details used in framing mill construction.

material of great compressive resistance, it may be very small in diameter, and requires only a small hole through the beam to accommodate it, half of the hole being in the end of one beam and half in the other. The lower end of the pintle rests on the cap of the lower column and the top of the pintle receives the lower end of the column above.

There are several advantages in this construction. In consequence of it, the beams actually butt against each other, and having only a small hole through them (not much over 4 in. in diameter), the ends of the beams are actually over the body of the column and are not supported by the overhanging ends of the

column cap. If a cap end is burnt off or breaks off the beam is held as securely as ever. It is a common thing for architects to carry the lower end of a column to the top of the one below, and sometimes both columns are of the same size. The result is that the beams are supported by the overhanging ends of the column caps. This is dangerous construction, in respect to both strength and fire resistance. The end may break if of cast iron, bend if of steel, become soft in a fire and cause the floor to fall. In this construction most of the cap, and the whole of the part which supports the beam are exposed to the fire.

The pintle construction, as before stated, permits the beams to butt against each other and thus become perfect struts to transmit pressure from one side of the building to the other, and it also gives room to put two iron dogs, or ties in the tops of the beams, one on each side of the pintle, to tie the beams together. Thus the beams become not only struts but rigid and continuous ties to keep the sides of the building in their proper relative positions. At the same time the pintles and dogs fulfill the necessary conditions before mentioned of being surrounded by heavy wood, for the pintles are within the beams and the dogs are embedded in grooves in the tops of the beams and covered by floor planks. Moreover, the dogs cannot work out because they are beneath the planks (Fig. 198).

Where the pintles enlarge at the top to take the upper column only, the top edges should be exposed to fire and can scarcely be injured. It should not be overlooked that when the beams and planks shrink the pintle tops become more exposed than at first, and allowance should be made for this. It should be observed also that the enlarged hole for the top of the pintle is in the plank and not in the beam (Fig. 198).

Still another advantage of pintle construction is that if a floor falls and a column below is knocked over by the falling floor or a heavy piece of machinery, it simply tips over on top of the pintle. A column which goes down between the beams if knocked over would pry the beams apart, punch a hole through the wall, possibly push it over, and cause the beam to drop off the column and fall. Thus the building might be wrecked on account of the absence of pintle construction.

46. Rigidity of Connection Is Necessary.—The beams must be connected to the wall in such a way that the walls will not be pushed or pulled until after this connection is made, such effort only coming from wind pressure or manufacturing strain. The beam ends should rest in cast-iron boxes with side wings firmly built into the walls (Fig. 198). The beams should then be made to butt firmly over the columns and be drawn together by driving in the dogs which for this purpose have their ends inclined where entering the wood. When this is done one or two lag screws should be screwed into the beams through holes in projecting lips of the beam boxes, which completes the connection across the building. After this is done the lips of the column caps are lag-screwed to the beams thus making the columns stable and preventing the beams from pressing against the pintles. Thus the column caps as well as the dogs hold the beams firmly together. No attempt should be made to have the pintle fit the hole, as it should be free to maintain its position as the beams are moved slightly when the dogs are driven. In fact, the hole for the pintle should be at least $\frac{1}{2}$ in. larger in diameter than the pintle (Fig. 198).

Beams usually end over columns, but if they do not, a hole is bored through for the pintle, and dogs are not required.

Floor beams when double should have no space between them as was formerly provided in order to permit air to circulate between, as these spaces hold fire tenaciously.

There is a very pernicious practice of supporting intermediate cross-beams so that their upper surfaces are level with those of the beams which they join. This is effected by the use of forged stirrups or commercial beam hangers. When a fire occurs they are easily softened, and give way if they support any material weight, which they often do. Beams should never be supported in this way if it is possible to avoid such construction, and if they are, heavy cast-iron beam-sockets should be used lag-screwed to the beams (Fig. 197). The commercial beam hanger is a great menace to the safety of buildings.

Roofs are framed, supported and planked after the manner of floors, using dogs, and the latter should be driven before the brickwork is built around the anchors in the walls (Fig. 197). When there is not a row of columns in the center of the room, the roof beams should not be carried on the slant to the center of the building and there fastened together, with the expectation that a stable roof will result. Horizontal beams should run between the two rows of columns next to the center and the roof slant given by wedge-shaped pieces spiked to the beams (Fig. 197). Roof beams are not usually secured to the walls by means of beam-boxes, but they might be advantageously employed (Fig. 198), especially if parapet walls are used. Wrought-iron anchors spiked or screwed to the beams are generally used (Fig. 197).

47. Special Beam Arrangements Possible.—Sometimes it is desired to have columns omitted in every other bay, and the beams that do not rest on columns must be supported by longitudinal stringers resting on top of the columns that are used. Many architects in this case yield to the temptation to use the beam hangers disapproved of above, but instead of this the stringers should be lower than the transverse beams by the depth of the latter, and the intermediate transverse beams should rest on top of them, and be fastened thereto (Fig. 197). Thus slow-burning construction is fully realized in this detail. The stringers are separated from the floor by the depth of the transverse beams, and the space thus provided is very convenient for the upper strands of belting. In this construction vertical shrinkage of the beams is considerable, and the pintles, which are long enough to go through both longitudinal and transverse beams, should be rather short, so that after the shrinkage the top will not appear materially above the floor.

Floor planks are usually $2\frac{1}{2}$ to 5 in. thick and in widths not exceeding 10 in. They should be at least two bays long, but there must be enough one-bay lengths to cause breaking of joints. It is not necessary to have every other plank break joints; four or five planks of the same length can be laid side by side and the next set can break joints with these. Where floor planks are interrupted by pintles they should be fitted under the pindle to some extent, so that their ends will rest on the beams. This with the splines and top floors will support them. Otherwise they should rest on a stick secured to the adjoining planks by lag screws.

48. Location of Beams.—It is inadvisable to have beams at right angles to the main transverse beams in a factory—that is, parallel to the sides of the mill. One objection to this is, that if they are not at or near the center of the building

they cut off the top light. Some architects wrongly place such beams against the sides of the building above the windows, and thereby prevent the tops of the windows from being as high as they might be, and close to the underside of the floor. These beams are hung to the transverse beams by means of the objectionable hangers already commented upon, and even intermediate transverse beams are sometimes hung to them. If the bays are not too wide intermediate beams are unnecessary, but architects often make the bays so wide that they are compelled to use intermediate beams, and this causes them to run the planks the wrong way.

The tops of the windows can be brought to the underside of the floor by building the arch in the next story above. The opening which would thus be made above the upper floor is closed by not carrying the arch clear through the wall. One course of brick carried down to the springing of the arch is sufficient to close the opening, and this is supported by an angle iron spanning the window opening (Fig. 197). If a straight arch is used this is supported by angles or other forms of structural material.

The beams are usually made of long-leaf Southern pine, which formerly came chiefly from Georgia, but the name "Georgia pine" is now chiefly a name, as such pine comes from any state south of North Carolina, and even from Cuba. Beams should be chamfered on the lower edges between bearings for the sake of appearance, and, some persons have stated, to do away with corners which readily ignite.

49. Floor Details.—Floor planks are made of spruce or pine, planed on three sides, grooved for splines, and for appearance slightly bevelled or beaded on the bottom edges. The splines are made of clear yellow pine and are always $\frac{3}{4} \times 1\frac{1}{2}$ in. and, as already stated, should fit tight enough to require driving in. The planks should end on the centers of the beams, and be nailed to each beam with two nails of such lengths that two or three inches should penetrate the beams.

On each side of a room a plank should be left out until the building is well dried, as the planks sometimes swell enough to push out the walls.

On the planks there should be one or two layers of tarred paper, or, better, a paper covered with an elastic material which will fit around the nails securing the top floor, in order to make the floor waterproof. Such a lining is intended to continue to be tight around nails after the floors shrink.

In Canada, and to some extent in this country, it is the practice to use for floors, planks on edge nailed together horizontally. It is not customary to end these planks over the beams, but anywhere. This weakens the floor seriously and should not be permitted. Sometimes, if such floors are very thick, they are not fastened to the beams.

Top floors are usually of square-edged maple of $\frac{3}{8}$ -in. nominal thickness, but sometimes thicker. The boards are commonly 5 in. wide and should not be less than 6 ft. long. They should be kiln dried, wedged together when laid, nailed with two nails 16 in. apart on diagonal lines, with two nails at the end of each board independent of the diagonal nailing. Sometimes top floors are laid diagonally, but little or nothing is gained by this and the cost is a little more. All nails should be set and the floor planed if it is not smooth enough without it.

Steel beams are used somewhat in mill construction buildings, but are not liked by the insurance companies as well as wood. They tolerate them, however,

trusting to sprinklers to keep them cool in case of fire, and consider that a fire will be confined to one story. Their advantages are that piers are not cut away by their use as in the case of wood and can therefore be narrower, thus increasing the window width, and columns can be farther apart. The beams should be laid on the walls as the work proceeds, with one brick course fitted around them in the face of the wall, and the pocket thus formed filled with cement grout. The brickwork can then proceed and the wall is not reduced in cross-section where the beam enters. If steel beams are used, pintles should not be omitted.

50. Anchoring of Steel Beams.—The anchoring of steel beams in walls is not quite so desirably accomplished as with wood. The common way is to have a couple of short pieces of steel angle riveted vertically to the web near the end of the beam to anchor it, and build the beam in as described above. The beam can be drawn up to the pindle before this is done. If the beam falls in a fire it will pry out some of the brickwork. A beam-box could be used, as in the case of wood beams, and bolted to the lower flange of the beam before the box is built

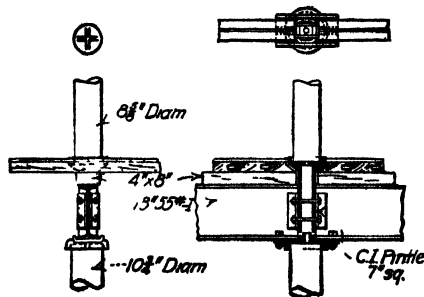

FIG. 199.—Pindle design for steel beams.

into the brickwork. The beam and box could then be slid as the beam is drawn up to the pindle.

Square or rectangular pintles look better with steel beams than round ones, as the beam ends fit against them better (Fig. 199). Sometimes the lower flange is bolted to a bracket cast on the bottom of the pindle and sometimes the web is bolted to an appropriate projection on the pindle. The best way is to rivet angles to the web, and bolt the beams together by means of bolts passing through oblong holes cast in the pindle, as in Fig. 199. Care must be taken to have the beam rest over the top of the column and avoid transverse stress in the pindle brackets.

51. Roofs.—The remarks on floors will apply to roofs, except that spruce sometimes warps and turns up its edges so that it may injure the roof paper. The standard slope of mill roofs is $\frac{1}{2}$ in. per foot.

Concerning roof coverings, there are many different makes, any of which will be furnished with a guaranty of five or ten years. Tar and gravel are very satisfactory and should be five or six plies thick. Thick roof coverings of this kind are important in some places on account of their insulating qualities which assist in preventing condensation of humid atmosphere on the underside in cold weather.

The undersides of roofs and floors are sometimes painted white, but the cracks between the planks make them look bad, although the lighting effect is good.

Likewise, brick walls can be painted, but the natural brick looks better. Brick looks best when washed down with acid and oiled.

52. Columns and Walls.—Columns are usually made of long-leaf Southern pine and should be carefully selected for straightness of grain and freedom from defects. It is very important that the ends should be square with the axis, and when the columns are round this is easily accomplished in the lathe. Wood columns are often made as small as 6 in. square, but they are very apt to spring and in hot factories this is true of columns of any size. Practically, it is better to have 8 in. the minimum size. Pipe columns filled with concrete are used, but the mutual insurance companies consider wood columns a better fire risk, and where the pipe concrete columns are used they prefer to have a reinforcement placed inside, this being strong enough to support the load (Fig. 199). The stock companies do not require this. This type of column without interior reinforcement went through the Salem fire successfully. Even with these columns, or those of cast iron, pintles should be used. Both ends of pintles should be faced off square and likewise the surfaces with which they come in contact, and pintles for square columns should have a circular face on which the column rests so that it can be faced in a lathe or boring mill (Fig. 198).

Wood columns were formerly bored and ventilating holes made at top and bottom. The benefit of this cannot be identified and the practice has been generally abandoned.

The upper and lower ends of wood columns should be treated with a preservative, especially the lower ends, as they are frequently wet from washing the floors.

In building such a factory some designers have slanted the piers between windows inward on the outside of the building. This is expensive and useless, and it should be kept in mind that the center of pressure coming from the weights should be as near the center of the foundation as possible. By stepping the walls back 4 in. or more at each floor on the inside of the building, or at every other floor, this is partly accomplished and the outside of the pier can be kept vertical (Fig. 197). If the pier is inclined or made like a stepped buttress on the outside, the result is that the foundation will be eccentrically loaded. These inclined or buttressed pieces accomplish nothing desirable.

53. Basement Floors.—If a wood floor is desired in the basement the best way is to make a tar concrete and wood floor, as follows: The earth should be filled-in layers 6 in. thick and rammed level. On top of this there is to be a layer 3 in. thick of hot tar concrete laid and rolled firmly and level, the upper $\frac{1}{2}$ in. being of fine material laid hot and well rolled to prevent moisture from coming through. On this there is to be a layer of unplanned square-edged plank $2\frac{1}{2}$ to 4 in. thick, laid close. The plank should be kyanized or treated with other preservative to prevent decay. A top floor is then laid at right angles to the plank and well nailed. The plank need not be splined, because there is no chance for vertical movement.

It is not well to use sleepers, as it is difficult to surround them properly with tar concrete and difficult to get them level, and they accomplish nothing. A floor as above described is a heavy solid mass and is bound together by the top floor. Experience shows that it is satisfactory without being fastened to anything and

is suitable for holding any machinery that does not require foundations. It is good where wet processes are carried on.

BUILDING TERMS

Apron.—A plain or molded piece of finish below the stool of a window, put on to cover the rough edge of the plaster.

Arcade.—A range of arches, supported either on columns or on piers, and detached or attached to the wall.

Arch-buttrass.—Sometimes called a flying buttrass; an arch springing from a buttrass.

Arch.—An arrangement of building materials in the form of a curve which preserves its given form when resisting pressure, and enables it, supported by piers or beams, to carry weights.

Architrave.—The lowest of the principal divisions of an entablature, resting immediately on the columns or pilasters.

Area.—A small court, usually below the general surface of the street in front of basement or first floor windows; an open space or court within a building.

Ashlar.—The facing of thin slabs of stone or terra cotta, which covers the rough brick and structural steel in the exterior walls of a building.

Astragal.—A small semi-circular molding, sometimes plain and sometimes ornamented.

Attic.—A low story above the main entablature of a building, with walls vertical to ceiling; in some building laws defined as any story, in whole or part, which is situated in the roof.

Awning.—A term sometimes used for marquee; any covering intended as a screen from the sun, or protection from the rain.

Axis.—A term used by architects for center line.

Backing of a Wall.—The rough inner face of a wall; earth deposited behind a retaining wall, etc.

Balcony.—A projection from the wall of a building, supported by columns, consoles or other cantilevers, and usually covered at its extremity by a balustrade.

Baluster.—A small pillar or column of various forms, supporting a rail, used in balustrades.

Balustrade.—A series of balusters connected by a rail.

Basement.—The lower part of a building, usually part of the basement is below the grade of the lot.

Base Molding.—The moldings immediately above the floor.

Bay.—The wall space between two columns; the whole space between column centers.

Bay Window.—Any window projecting outward from the wall of a building and commencing from the ground. If they are supported on projecting corbels, they are called oriel windows.

Beam.—A piece of timber, steel or other material, placed across an opening or from post to post, to support a load.

Bearing.—The portion of a beam, or truss, etc., that rests on the supports.

Bearing Wall.—A wall which supports the floors or roof in a building.

Bed.—The horizontal surfaces on which the stones or bricks are laid in a wall.

Belt.—A course of stones or brick projecting from the face of a brick or stone wall.

Blocking.—A course of stones or other material crowning the top of a wall.

Bond.—The connection between bricks, stones or other materials formed by lapping them upon one another in carrying up the work, so as to form a single mass of wall.

Brace.—Any inclined member introduced in a truss or frame to stiffen it.

Bracket.—A supporting piece under a cornice, or other projection; see also corbel, console, modillion, respond—all varieties of brackets.

Break.—Any projection from the general surface of wall.

Bridging.—A method of stiffening floor joists or partition studs by fitting pieces in between. In steel work, cross diaphragms are used for the same purpose.

Bucks.—The rough frame for doors or other openings in partitions, erected before partitions, and to which the jambs and trims are attached.

Butt-joint.—Where the ends of two pieces of any material butt together.

Buttress.—Masonry projecting from a wall to gain additional strength against the thrust of a roof or vault.

Buttress, Flying.—A detached buttress or pier of masonry at some distance from a wall and connected to the wall by an arch or part of an arch.

Caisson.—A sunken panel or coffer in ceilings, vaults and domes; the term is also used for concrete cylindrical foundations or tubular piers filled with concrete.

Camber.—The convexity sometimes placed in beams or trusses to prevent them becoming concave under their loads.

Canopy.—An ornamental covering over a niche; a name sometimes given to a marquise.

Cantilever.—A projecting beam or truss, sometimes called console or bracket.

Capital.—The upper part of a column, pilaster or pier, usually ornamented with moldings or foliage or these combined.

Casement.—A window, the sash of which is hinged to the vertical sides of the frame into which it is fitted.

Causeway.—A raised or paved way.

Ceiling.—The upper horizontal or curved surface of a room or hall, opposite the floor, which conceals or ornaments the construction of the floor above, or that of the roof.

Chamfer.—To bevel the edge of anything originally right-angled; to round off or bevel an edge to fit on or into a connecting piece.

Class.—Class A, class B, etc., designated by the building codes for a building, denotes the character of its construction, under certain limiting conditions of fireproofness and beauty.

Coat.—A thickness or covering of paint, plaster or other work, done at one time.

Coffer.—A sunken panel. See Caisson.

Coffer Dam.—A frame surrounding an excavation; or a frame placed in water, the water inside the frame being pumped out to build masonry piers.

Column.—Generally any body which supports another in a vertical direction. An architectural column is composed of three parts; the base, the shaft and the capital. See Post.

Concrete.—A mass composed of cement, sand and broken stone or gravel, making an artificial stone.

Conductor.—A pipe to convey the rain water to the sewer system; sometimes termed "leader" or "downspout."

Conduit.—A recess left in the concrete work of the floor system to receive piping; a metal pipe arranged for electric wiring or terra cotta blocks arranged for the same purpose.

Console.—The enriched vertical bracket under the cornice of an entablature, or under cornice of doors and windows. See Bracket and Cantilever.

Coping.—The highest and covering course of masonry in a wall.

Corbel.—A projection from a wall to form a support, generally ornamented.

Cornice.—Any molded projection which crowns or finishes a wall.

Corridor.—The passage-way which gives communication between the various parts of a building.

Countersink.—The cavity for the reception of a plate, or the head of a screw or bolt, so that it will not project beyond the face of the work.

Course.—A continued layer of bricks, stones, terra cotta, slate, shingles, etc.

Court.—An uncovered area in front, behind, or in the center of a building.

Cove.—The curved, concave portion of a cornice or ceiling as distinguished from the square parts or corners. Cove-molding, cove-ceiling, etc., refer to the concave portion of the molding, ceiling, etc.

Cradling.—A name applied to the pieces which the expanded metal or other lathing is fastened to in building large interior cornices or vaulted ceilings.

Cupola.—A small room, circular or polygonal, located on the top of a dome.

Curb.—The dividing line between the sidewalk and the street, the edge of an opening in a floor.

Curtain Wall.—A non-bearing wall built between columns.

Dome.—The projection on the top of buildings in the form of an inverted cup.

Dormer.—The projection from the inclined surface of a roof to form a room within, contains one or more windows and has a roof of its own.

Dovetailing.—The method of joining boards or other material together, the joints, tooth shaped or dovetail shape, fitting into each other.

Dowel.—A pin used in the joining of two pieces of material for the purpose of holding them in place.

Drainage.—Relates to system of pitched roofs or floors, gutters, downspouts, conduits, etc., for the purpose of shedding water from roofs or floors.

Drip.—The member projecting from a wall or cornice for throwing off water, drop by drop.

Ducts.—The flue or passage-way through which the ventilation or heating is conveyed to the different parts of a building or group of buildings.

Eaves.—The lowest edges of the inclined sides of a roof which project beyond the face of the wall.

Elevation.—The drawing of the external walls of a building; the vertical projection of any member or structure; the distance from datum to a given height.

Entablature.—The whole of the parts of an order of architecture, supported by columns, pilasters or piers. It consists of three parts: architrave, frieze, and cornice.

Escalator.—A moving stairway.

Extrados.—The exterior or convex curve of an arch or vaulting surface.

Fascia.—A flat, broad member slightly projecting from the face of an entablature or wall.

Filler Wall.—A term in some municipal building laws for a non-bearing wall between columns and supported at each floor; a partition.

Fireproofing.—Generally speaking is of two kinds, the constructive and the applied; the constructive kind being of two classes, the terra cotta or burnt clay products and the concrete; the applied being simply some form of wire lathing and plaster.

Fish-joint.—A splice where the pieces are joined end to end and connected by pieces of wood or steel placed on each side and bolted to the pieces joined.

Flashing.—Pieces of copper, tin, etc., let into the joints of a wall so as to lap over the metal of gutters or roof material; or any pieces used at the junction of different pieces to prevent leaking.

Floating.—The equal spreading of plaster or cement on a surface by means of a board, called a float.

Footings.—The projecting courses at the base of a wall or column to spread the load over a greater area.

Foundation.—The sub-structure on which a building rests, parts of which are footings or grillage.

Frame.—A term used extensively in building with a qualifying noun as window frame, steel frame; when used in specifications as a verb, it relates to the connections of various members.

Frieze.—The middle part of an entablature, the under part being the architrave, the upper the cornice.

Furring.—To bring an uneven to an even surface. Wood strips are used to which lath is applied or on which the finished floor is laid.

Gable.—The walls at the ends of a building directly under the sloping roof planes. Ordinarily the shape is triangular.

Gallery.—A long passage looking down into another part of a building; very long rooms used for purposes of state or the exhibition of pictures.

Girder.—A large timber or steel member, either single or built up, used to support floors or walls over an opening.

Grade.—The term used to denote the established street and sidewalk planes or surfaces; the natural surface of the ground or finished surface of the ground, where it is cut away or added to; the elevation above datum.

Grillage.—A combination of beams laid transversely in the several tiers, the deepest beams being used in the top tier.

Grillage Girder.—A built girder used where the heaviest rolled shape would be inadequate.

Groin.—The intersection of two vaulting surfaces.

Groin Rib.—A vaulting rib that is placed at the intersection of vaulting surfaces.

Ground Floor.—The floor of a building on a level, or nearly so, with the ground.

Grounds.—Pieces of wood placed around openings, etc., to which the trim may be nailed. They also serve as a guide to finishing the plaster.

Grout.—Mortar made so thin by adding water that the mixture will run into joints or cavities of the mason-work, and fill it up solid.

Gutter.—The channel for carrying off rain water from the roofs.

Hall.—A room or passage-way at the entrance to a building; a large room used as a place of assemblage.

Headers.—Stones or brick extending over the thickness of a wall; also the large beams into which other pieces are framed to provide openings for stairs, chimneys, etc.

Head Room.—The distance between the top of finished floor and the finished side of a fireproofed beam or girder in floor above.

Herring-bone Work.—Bricks, tile or other materials laid diagonally.

Hip.—The external angle formed by two inclined sides of a roof.

Hip Rafter.—The rafter under the hip of a roof, which receives the jack rafters or purlins.

Intrados.—The interior or concave curve of an arch, sometimes called the soffit of the arch.

Jack.—An instrument for raising heavy loads, either by a crank, screw thread or by hydraulic power.

Jack Rafter.—A short rafter in hip-roof work.

Jamb.—The side posts or lining of a doorway or opening. The jambs of a window outside of the frame are called reveals.

Key-stone.—The stone placed in the center of the top of an arch.

King-post Truss.—A truss framed with one tie member in the center.

Knee.—A member placed diagonally between a post or wall and joist or truss to relieve the weight or secure rigidity.

Lath.—Strips of wood nailed to furring strips on which the plaster is spread.

Lattice.—Any work of wood or metal made by crossing laths, rods or bars and forming a network.

Lean-to.—A small building whose rafters pitch or lean against another building, or against a wall.

Lintel.—The horizontal piece which covers the opening of door, window or other opening to carry the weight of walls above.

Lobby.—An open space surrounding a range of chambers, or seats in a theater; a small hall or waiting room.

Louvers or Loures.—The inclined slats spaced at intervals to admit a free current of air and at the same time exclude the rain, used most frequently in monitors.

Lug.—The part of a sill on which the wall rests, or the part of a lintel which rests on the wall; used by structural engineers to refer to a projection.

Mansard.—A roof formed of four contiguous planes inclined to each other. The simplest form of mansard is where the apparent roof is inclined to the vertical and one or more stories are formed in it.

Margin.—Occasionally used for the "flange" of buckled plates.

Marquee.—The hood or canopy projecting over a carriage or other entrance to a building as a protection from the weather.

Mezzanine.—From an Italian word meaning "middle," a low story between two regular floors.

Miter.—Two pieces at right angles to each other with ends cut at 45° form a miter. A miter joint is one made at an angle of 45°.

Modillion.—The ornamental bracket under the cornice of an entablature.

Monitor.—That portion of a building extending above the main roof for the purpose of ventilating or lighting the interior; the British term is "lantern."

Mullion, Munion.—The vertical post or posts which divide a window space or other openings into two or more divisions.

Muntin.—The bars which divide a sash.

Newel.—The vertical post round which the treads and risers of a circular stair wind and to which they are attached.

Newel Post.—The post placed at the lowest step of a stair to which the hand-rail abuts or from which it starts.

Nosings.—The rounded and projecting edges of the treads of a stair, or the edge of a landing.

Offsets.—When the face of a wall grows higher and thinner, the jogs are called offsets.

Oriel.—A recessed window that ordinarily projects beyond the exterior face of the wall, is in plan octagonal or hexagonal, is commonly corbelled or cantilevered out. One starting from its own foundation is usually called a bay window.

Outlookers, Outriggers.—A cantilever to build the cornice on or onto which to hang the cornice.

Panel.—The space included between four columns of a building generally rectangular in plan; commonly referring to the surface of wood or other material recessed between four pieces, such as the panels of a door or wainscoting.

Parapet.—A low wall along the edge of roof or terrace.

Partitions.—The dividing wall between rooms; in modern office building work composed of hollow tile and plastered both sides.

Party Wall.—A wall built upon the dividing line between adjoining buildings for their common use.

Pent House.—The roof houses on office buildings, covering stairways, elevator shafts, etc., irrespective of the shape of the roof.

Pier.—The part of a wall between windows and doors; any detached mass of masonry to support an arch, girder or column.

Pilaster.—A flat, square column attached to the wall and projecting from it one-sixth to one-fourth of its width.

Pile.—Timber or concrete shafts sunk into soft ground upon which foundations are built.

Pin.—A cylindrical piece of wood, steel or other material, used to hold two or more members together by passing through a hole in each of them.

Pitch of a Roof.—The proportion obtained by dividing the height by the span, as one-half, one-third pitch, etc.

Plaster.—A mixture of lime, hair and sand, to cover lath work for interior walls and ceilings.

Porch.—A covered erection forming a shelter to the entrance of a building.

Portal.—The arch over a door or gate.

Portal Bracing.—A system of indirect bracing used where the existence of doors, openings, etc., prohibit the more direct web system.

Post.—Generally any vertical piece whose function is to sustain a vertical load; in structural work, members composed of single angles, rolled shapes, or built-up sections and carrying stresses in compression, whether inclined or vertical are designated as posts or columns.

Purlins.—Steel shapes or timbers extending from truss to truss or between rafters and supporting the roof covering.

Queen-post Truss.—A truss framed with two vertical tie members.

Rafters.—The joists to which the roof boards are nailed.

Ramp.—An inclined roadway.

Random Work.—A term used for stones fitted together at random without any attempt at laying them in courses.

Range Work.—Ashlar laid in horizontal courses, same as coursed ashlar.

Respond.—A corbel or bracket from which an arch or vault springs.

Return.—The continuation of a molding, projection, etc., in an opposite direction.

Reveal.—The vertical sides of an opening, between the front of the wall and the frame; used also to designate the return of a pilaster or pier, between the face of the pilaster or pier and the main wall face.

Ridge.—The top of a roof which rises to an acute angle.

Riser.—The vertical board under the tread in stairs.

Roof.—The covering or upper part of any building.

Roofing.—The material put on a roof to make it watertight.

Rubble Work.—Masonry of rough, undressed stones.

Saddle.—The coping on the apex of a roof; sometimes used instead of "cricket."

Saddle Rod, Saddle Bar.—Bars staying the two lines of purlins next to the ridge; stay bars holding mullions in place, etc.

Sash.—The framework which holds the glass in a window.

Scarf.—The joint in timber construction to make two pieces appear as one; in steel, when two plates are lapped, one edge is thinned down to a feather edge or "scarfed" so that the two surfaces will be brought into the same plane.

Scuttle.—A framed opening, with its cover, through a roof.

Sheet Piling.—Planking or specially devised shapes driven close together to form a temporary wall about an excavation.

Shore.—A piece of timber placed in an oblique direction to support a building or wall temporarily while it is being repaired or altered.

• *Sill.*—The piece which forms the bottom of a door or window opening, or of a panel.

Skewback.—The inclined stone from which the arch springs; in structural work, the shelf angle from which the arch springs.

Skylight.—A frame supporting glass sash, placed in a roof to light passages or rooms below.

Sleeper.—Timber laid on the ground to receive joists or pieces of wood imbedded in concrete to which finished floors may be nailed.

Soffit.—The concave surface of an arch; the under horizontal face or surface of an architrave or of a lintel or cornice.

Span.—The distance between the supports of a beam, girder, arch, truss, etc.

Spandrel.—Those portions of the exterior walls, side or court walls, which lie between the piers and between the window spaces of the successive stories.

Specification.—A description of the kind, quality and quantity of materials and workmanship that are to govern the fabrication and erection of a building.

Spire.—The pyramidal apex of a tower.

Staging.—A structure of posts and boards for supporting workmen and material in building.

Stairs.—A series of steps supported by "stair-stringers" or "stair-horses." The beams to which the stair-stringers connect are called "stair-headcrs."

Stanchion or Stanchion.—A name sometimes used for a column or post.

Stile.—The upright piece in framing or paneling.

Stretcher.—A brick or block of masonry laid lengthwise of a wall.

Stucco.—Any material used as a covering for walls, put on wet and drying hard and durable. The term is usually used for out-of-door work.

Studs.—The small timbers used in partitions and outside wooden walls, to which the laths and boards are nailed.

Surface.—To make plane and smooth.

Templet.—A form to lay out work; piece of timber or stone to distribute pressures over a larger area. When applied to steel, the templets are known as "bearing plates" or "slabs" as the case may be.

Terra Cotta.—Baked clay of a fine quality.

Threshold.—The strip of wood or other material under a door.

Tie.—A timber, rod, chain, etc., binding two bodies together.

Tiles.—Flat pieces of burned clay, to cover roofs, floors, fireplaces, etc.

Tongue.—A projection of a board or other material, to be inserted in a groove.

Tower.—An elevated building, usually placed on a main building. Sometimes crowned with a spire or cupola. Towers are circular or polygonal in plan.

Transom.—The bar or horizontal construction which divides a window, commonly applied to the sash over the door.

Tread.—The horizontal part of a step of a stair.

Trimmer.—The beam or joist into which a header is framed.

Upset.—To thicken and shorten, as by hammering a heated bar of steel on the end.

Valley.—The intersection formed by the re-entrant angle of two inclined planes of a roof.

Valley Rafter.—The rafter immediately under the valley and to which the jack rafters or purlins connect.

Vault.—An arched ceiling or roof over an apartment; a place specially designed for storage.

Veneer.—An outer facing of brick, stone or other material placed on a wall for protection or decoration and not for strength.

Vent.—A conduit for carrying off foul air.

Vestibule.—An anti-hall, lobby, or porch.

Wainscot.—The wooden lining of walls, generally in panels.

Wall-bearing.—A term to denote that the floor systems are carried on masonry and not on a steel frame. The floor may be “wall-bearing” on the outside walls and the interior supported by steel columns.

Wall Plates.—Pieces of timber or steel which are placed on top of walls to form the support of the roof of a building.

Water Table.—A slight projection of the wall on the outside of a wall a few feet above the ground as a protection against rain.

Wing.—An offset of the main building.

SECTION 2

ROOF TRUSSES

ROOF TRUSSES—GENERAL DESIGN

1. Roof Trusses in General.—A roof truss is a framework designed to support the roof covering or ceiling over large rooms, thereby avoiding the use of interior columns. Figure 1 shows the relative position of the roof trusses, the walls of the building, and the roof covering.

When the nature of the supporting forces is such that the reactions are vertical under vertical loading, or the reactions due to inclined loading can be determined by the methods of simple statics, the framework is known as a "simple

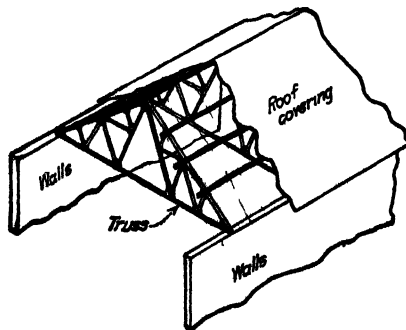
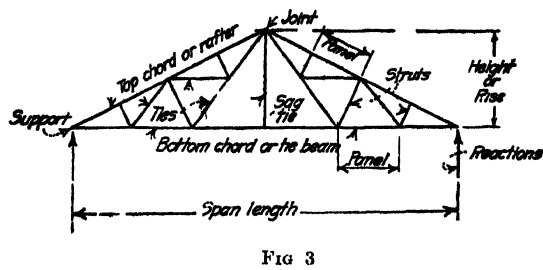
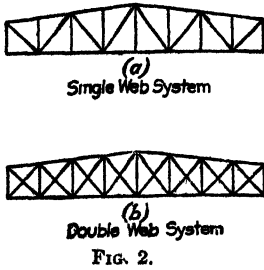

FIG. 1.

truss." Where the reactions are inclined, even under vertical loading, and where they can not be determined by simple statics, the framework is known as an "arch." The discussion of this chapter will be confined to simple trusses; arches will be considered in the chapter on "Arched Roof Trusses."

Simple roof trusses can be further divided into two classes based on the methods of supporting the trusses. In one class can be placed the trusses which are supported on rigid walls of masonry, or other material forming a wall which is able to resist lateral forces without additional bracing. In a second class can be placed the trusses which are supported on steel columns carrying a light curtain

wall in addition to the trusses. The construction of these columns is such that, unaided, they do not offer any considerable resistance to lateral forces. To secure a rigid structure, it is necessary to join the trusses and the columns by a member known as a "knee-brace," thus forming a rigid framework which is known as a "knee-braced bent." Further discussion of this type of structure is given in the chapter entitled: "Detailed Design of a Truss with Knee-braces."



In general, a roof truss should consist of a simple framework composed preferably of a system of triangles. The members of the framework are usually so arranged that they are in direct tension or compression. Trusses composed of a single web-system, as shown in Fig. 2(a), are preferable to those with a double web-system, as shown in Fig. 2(b). The stresses in the truss of Fig. 2(a) are readily determined by the principles of simple statics. In the truss of Fig. 2(b), the stresses are statically indeterminate. An exact determination of the stresses can be made, but the work of stress calculation is long and tedious. Approximate methods of stress calculation are generally used, but as the distribution of the load to the various members is uncertain, such methods are unsatisfactory.

Figure 3 shows the component parts of a truss. The names of the several parts are indicated in position. As shown on Fig. 3, the upper members are known as the top chords, or rafters, and the lower members are known as the bottom chords, or tie beams. The interior compression members are known as struts, and the interior tension members are known as ties. Points of intersection of chord members are known as joints, and the distance between adjacent joints is known as a panel, or panel length. A sag tie is a member provided to form a support for a long horizontal member which would deflect excessively under its own weight if not so supported.

2. Form of Trusses.—A great variety of trusses are used in building construction, the form depending upon the character of the roof covering and the architectural features of the structure. Figure 4 shows some of the forms of simple trusses in common use for trusses supported on rigid walls. Types of knee-braced bents and arches are shown in later chapters.

In Fig. 4 the forms shown in Figs. (a) to (m) are well adapted to construction in steel, while those of Figs. (n) to (q) are suited for construction in wood. The trusses of Figs. (a) to (m) are so arranged that the compression members, shown by the heavy lines, are the shortest members in the truss, while the tension members, shown by the light lines, are the longest members. This results in a considerable saving of material, for a compression member requires a greater sectional

area for a given stress than a tension member. Also, the greater the length of a compression member, the greater the required area.

In the trusses of Figs. (n) to (q), the top and bottom chord members and the interior diagonals are usually made of wood, while the vertical tension members are made of steel rods. Since compression joints between wooden members are easier to frame than tension joints, or splices, it follows that these types are well adapted for construction in wood.

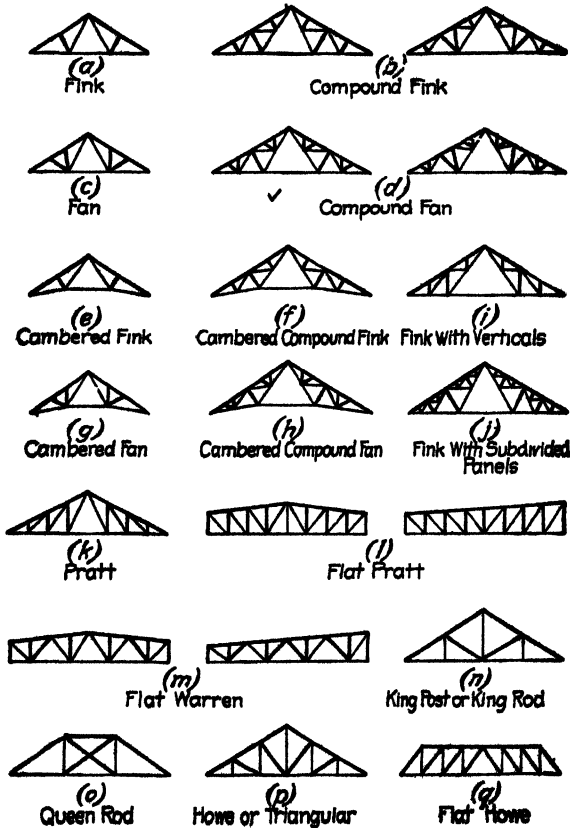

FIG. 4.

The form of truss is dependent to some extent upon the span length, for in order to avoid bending stresses in the top chord, it is desirable to have a panel point of the truss directly under each purlin. To avoid the use of excessive areas in the top chord sections, it will probably be best to limit the length of these members to about 8 ft. as a maximum. With this limitation, the advisable maximum spans for the several types shown in Fig. 4 are about as follows: Figs. (a) and (e), 30 ft.; (c) and (g), 40 ft.; (b) and (f), 50 to 60 ft.; (d) and (h), 70 to 80 ft.; and (j), 80 to 90 ft. The forms shown in Figs. (k), (l), and (m) can be used for spans of from 20 to 80 ft. by varying the number of panels. Wooden trusses of the type shown in Fig. (n) and (o) can be used for spans up to about 25 or 30 ft., while

those of Figs. (p) and (q) can be used for spans of from 20 to 80 ft. by varying the number of panels.

The type of truss to be used with a given roof covering is determined by the allowable slope of roof for the roof covering in question. Table 1 gives the minimum allowable slope of roof for some of the common types of roof coverings.

TABLE 1

Asphalt or asbestos.....	Rise $\frac{1}{12}$ of span.
Corrugated steel.....	Rise $\frac{1}{4}$ of span.
Slate	Rise $\frac{1}{8}$ to $\frac{1}{4}$ of span.
Tar and gravel.....	Flat, or sufficient slope for drainage.
Tile	Rise $\frac{1}{2}$ of span.
Tin	All slopes.
Wood shingles on sheathing	Rise $\frac{1}{4}$ of span.

The trusses shown in Figs. (l), (m), and (q) are suitable for tar and gravel, or for tin roofs. For these types of covering it is necessary to give the roof only enough slope to provide proper drainage. A slope of more than 1 in. to the foot is not desirable for a gravel and tar roofing, due to the fact that the material will flow when laid, and that intense summer heat will also cause it to flow if the slope is greater than that mentioned. All of the other forms shown in Fig. 4 are adaptable to roofs with a rise equal to from $\frac{1}{8}$ to $\frac{1}{2}$ of the span.

Trusses with a cambered lower chord, as shown in Figs. (e) to (h) inclusive, are used for the sake of appearance. A long line of trusses with exposed horizontal chords appear to sag. This effect can be overcome by cambering the lower chord. In other cases the architectural treatment of the ceiling calls for a cambered truss. Where a moderate camber is required, one of the forms shown in Fig. 4 can be used. In churches and similar structures, the architectural treatment often calls for an ornamental truss, which is considered in the chapter on "Ornamental Roof Trusses."

In general it can be said that the selection of the type of truss is just as important as any other feature of the design. Having fixed upon the span length and the height of truss, that type of framing should be adopted in which the members are well placed with respect to the loads which are to be carried.

3. Pitch of Roof Truss.—The pitch of a roof truss is usually defined as the ratio of the height, or rise, of the truss to the span length, and is usually designated by a fraction. Thus in the truss of Fig. 3, suppose the height to be 15 ft. and the span to be 60 ft. As defined above

$$\text{pitch} = \frac{\text{height}}{\text{span}} = \frac{15}{60} = \frac{1}{4}$$

In the preceding article the effect of character of roof covering on the ratio of rise to span length has been considered. As the pitch of roof, as defined above, is the same as the rise divided by the span, the values given in Table 1 will indicate the minimum desirable pitch of a roof truss for a given roof covering.

"The pitch of the truss should also be determined with reference to the loads to be carried. As shown by the tables of wind and snow load given in Arts. 11 and 13, a roof with a $\frac{1}{4}$ pitch has a smaller snow load but a greater wind load per sq. ft. of roof than one with a $\frac{1}{8}$ or $\frac{1}{2}$ pitch. Also the stresses in the trusses of $\frac{1}{4}$

pitch are less than those of $\frac{1}{4}$ or $\frac{1}{2}$ pitch. However, in trusses of $\frac{1}{4}$ pitch, the interior compression members are somewhat shorter than those in trusses of $\frac{1}{2}$ pitch, which results in a considerable saving in material, in spite of the greater stress. Trusses of $\frac{1}{2}$ pitch have greatly increased stresses, which call for added material in spite of the reduced length of the compression members. Considering all factors, it seems that the truss of $\frac{1}{4}$ pitch is the most economical.

4. Spacing of Trusses.—The theoretical spacing of trusses for least total cost of trusses, purlins, and roof covering depends upon the relative cost of the component parts. As the spacing increases, the cost of the trusses per unit of covered area will decrease, as small changes in spacing have little effect on the weight of a truss; the cost therefore varies inversely as the spacing. The size of purlin is determined by the moment to be carried; this varies as the square of the span. Therefore the cost of the purlins can be considered to vary as the square of the spacing. The roof covering cost varies directly as the spacing. To determine the theoretically most economical spacing, all of these factors must be given proper consideration.

The relation between the quantities given above for minimum cost can be expressed approximately in the following manner:

As stated above, the cost of the trusses can be assumed to vary inversely as the spacing of the trusses, which relation can be written, $t = \frac{k}{s}$, where t = cost of trusses per sq. ft. of roof, k = a constant, and s = spacing of trusses. Again, the cost of the purlins varies directly as the square of the spacing of trusses, or $p = ns^2$, where p = cost of purlins per sq. ft. of roof, n = a constant, and s = spacing of trusses. Also, the cost of roof covering varies directly as the spacing of trusses, or $c = ms$, where c = cost of roofing per sq. ft. of roof, m = a constant, and s = spacing of trusses. If X be the total cost of the roof, per sq. ft., we have

$$X = t + p + c = \frac{k}{s} + ns^2 + ms$$

By the methods of the Differential Calculus it can be shown that the relation existing between the terms of the above expression at the time the cost of the roof is a minimum is

$$t = 2p + c$$

That is, for least cost, the spacing of trusses must be such that the cost of the trusses per sq. ft. of roof is equal to twice the cost of the purlins per sq. ft. of roof plus the cost of roof covering per sq. ft. of roof.

The relation given above can not be used directly for the determination of the truss spacing for the spacing does not appear in the equation. However, by means of the above expression, a given design can be tested out to see if it answers the theoretical conditions. A study of the formula will aid in forming conclusions regarding the proper truss spacing.

The cost of materials and labor is such that the cost of the trusses per sq. ft. of roof is usually several times greater than that of the purlins. Roof covering costs vary with the nature of the covering, but will probably not exceed that of the purlins. These facts point toward a rather wide spacing of trusses, in order to secure maximum economy. If it were possible to obtain rolled sections which

would provide exactly the required areas for all truss members, it would be possible to use rather a small truss spacing. But as can be seen from the design given in the chapters on the design of steel and wooden roof trusses, the sizes of many members are determined by the specifications, or by the requirements of standard practice. These requirements add considerably to the weight of the structure. From this discussion it can be seen that the cost of the trusses controls the economy of the design, and the spacing of the trusses should be determined accordingly.

Comparative estimates of cost, made by comparing the total cost of roof trusses of the same span length but with varying spacing indicate that for spans up to 50 ft. the most economical spacing is about 15 ft. for light loads (about 30 lb. per sq. ft.), or about $\frac{1}{4}$ of the span. For spans of from 50 to 100 ft., the spacing should be about $\frac{1}{4}$ of the span for the shorter spans and about $\frac{1}{5}$ of the span for the longer spans, or from 15 to 20 ft. In many cases local conditions govern and determine the spacing of the trusses regardless of the economical conditions.

5. Spacing of Purlins.—The spacing of the purlins is governed to a large extent by the roof covering, and to some extent by the type of roof truss. In the first place, the strength of the roof covering, considered as a beam spanning the distance between purlins, determines the allowable span of the roofing, and in the second place, the position of the joints of the truss determines the possible points of support for purlins, and in this way determines the possible span of the roof covering. This assumes that the top chord of the truss acts only as a compression member. In some cases where the type of the truss is such that the distance between top chord joints is greater than the allowable span of the roof covering, purlins are placed at points between the chord joints. This arrangement has the disadvantage of subjecting the chord section to bending as well as direct stress, for the chord section must act as a beam as well as a chord member. But this is probably offset by the saving in weight of purlins made possible by the use of, smaller closely-spaced sections.

Roof coverings are often laid on sheathing, which is in turn supported by rafters laid parallel to the top chord of the truss and resting on purlins. By using suitable rafters, the purlin spacing can be made as desired. This construction is apt to result in a heavy roof. To avoid this, the sheathing is sometimes laid directly on the purlins, thus limiting the spacing of purlins to the safe span of the sheathing. This safe span is to be determined with reference to the bending stress in the sheathing, and also with respect to the allowable deflection of the sheathing, for in some cases the roof covering, as tile or slate, is likely to crack if the sheathing is subjected to excessive deflection. The allowable deflection is about $\frac{1}{400}$ part of the clear span.

Figure 5 shows an inclined beam subjected to a vertical uniform load of w lb. per ft. of beam. Assuming that the sheathing is continuous over several purlins, the maximum moment is $M = \frac{1}{10} w l^2 \cos \theta$, and the fiber stress is given by the formula $f = \frac{M c}{I}$. Placing the value of M in the formula for fiber stress and solving for l , the limiting span length, we have, for a rectangular section of width b and depth d ,

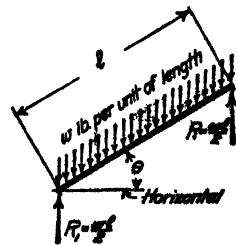

FIG. 5.

$$l = \left(\frac{5}{3} \frac{bd^2f}{w} \sec. \theta \right)^{1/2}$$

In terms of the fiber stress, the deflection of a rectangular beam under a uniform load is given by the formula $\Delta = \frac{5}{24} \frac{fl^2}{Ed}$ where E is the modulus of elasticity of the material, and the other terms have the same values as before. Substituting in this expression the value of f , and solving for l , the limiting span, we find for an allowable deflection of $\frac{1}{80}$ of the span, that

$$l = \left(\frac{1}{45} \frac{bd^2E}{w} \sec \theta \right)^{1/3}$$

The smaller of the values given by the above equations is the allowable span for the sheathing under consideration. Table 2 gives the limiting spans for sheathing in common use for several load capacities and varying slope of roof, as determined by the above equations.

TABLE 2.—LIMITING SPANS FOR 1-IN. SHEATHING FOR VARIOUS LOAD CAPACITIES AND SLOPES

$f = 1,000$ lb. per sq. in.; $E = 1,000,000$ lb. per sq. in.; $d = 1$ in.
(Limiting spans given in feet)

Capacity in pounds per square foot	Slope of roof in inches per foot						
	0	2	4	6	8	10	12
20	9 13	9 20	9 35	9 66	10.02	10 43	10.85
	4 53	4 56	4.60	4.71	4 81	4.95	5 08
25	8 17	8 22	8 37	8 65	8 97	9 35	9 72
	4 19	4.22	4 25	4.35	4.45	4.58	4 70
30	7.45	7.51	7.64	7.89	8 17	8 52	8 86
	3 95	3 97	4 00	4.11	4.20	4 32	4.43
40	6 46	6 51	6.62	6.84	7 20	7.39	7.69
	3.59	3.61	3.64	3 73	3.82	3.92	4.03
50	5.77	5.82	5.92	6.00	6.34	6.60	6.86
	3.34	3.36	3.40	3.47	3.55	3.65	3.75
60	5.27	5.32	5.41	5.58	5.78	6.03	6.27
	3.13	3.15	3.17	3.25	3.33	3.42	3.52

NOTE.—Upper values = limiting span in feet due to bending. Lower values = limiting span in feet due to deflection.

For limiting spans due to fiber stresses other than 1,000 lb. per sq. in., multiply upper values in table by the ratio $\sqrt{\frac{f}{1,000}}$.

For limiting spans due to deflection for values of E other than 1,000,000 lb. per sq. in., multiply lower values in table by the ratio $\sqrt[3]{\frac{E}{1,000,000}}$.

For limiting spans for sheathing of other than 1 in. thickness, multiply values given in the table directly by the thickness of the sheathing in inches.

The limiting span for corrugated steel roofing, considered as a horizontal beam, is given by the Rankine formula as

$$l = \left(0.178 \frac{Shbt}{w}\right)^{\frac{1}{2}}$$

where S = working stress in lb. per sq. in., h = depth of corrugations in inches, b = width of sheet in inches, t = thickness of sheet in inches, w = safe load in lb. per ft., uniform load, and l = allowable span in feet. Table 3 gives the allowable spans of corrugated steel for several load capacities per sq. ft. of roof. The values are computed from the above formula.

TABLE 3.—LIMITING SPANS FOR CORRUGATED STEEL

$$\text{FROM FORMULA } l = \left(0.178 \frac{Shbt}{w}\right)^{\frac{1}{2}}$$

$S = 12,000$ lb. per sq. in.; $b = 12$ in.; $h = \frac{5}{8}$ in.

Gage	t (in.)	Values of l in feet					
		$w = 20$	$w = 25$	$w = 30$	$w = 40$	$w = 50$	$w = 60$
16	$\frac{1}{16}$	7 08	6 32	5 77	5 00	4 47	4 08
18	$\frac{1}{20}$	6 32	5 65	5 16	4 47	4 00	3 65
20	$\frac{3}{60}$	5 50	4 91	4 48	3 88	3 47	3 17
22	$\frac{1}{32}$	5 00	4 47	4 08	3 54	3 16	2 88
24	$\frac{1}{40}$	4 49	4 01	3 66	3 17	2 84	2 59

6. Spacing of Girts.—Girts are members, similar to purlins, which are used to support the siding in a building in which the walls are formed by siding or corrugated steel carried on the columns which support the roof trusses. The design of girts is carried out by the same methods as given in the following chapter for purlins.

The spacing of girts is governed by the same considerations as given in the preceding article for purlins. Allowable spacing of girts can be determined by the tables of the preceding article. Design methods are given in Art. 43.

7. Purlin and Girt Details and Connections.—Wooden purlins can be made up of a single piece, or can be built up by spacing several narrow pieces side by side. When properly fastened together, either by nailing or bolting, built-up beams are equally as strong as a single piece, and are cheaper and easier to obtain. Such purlins are used either with wooden or steel roof trusses.

The connection of wooden purlins to the roof truss depends upon the type of roof construction and the kind of truss. For wooden trusses, purlin connec-

tions of the type shown in Fig. 6 are in common use. In Fig. (a) the purlin is placed on the top of the chord section. This is often done when a deep roof covering is not undesirable. The purlin is held in position and prevented from overturning by means of a block or short piece of angle nailed or bolted to the top chord, as shown in Fig. (a). Where the depth of the roof construction is

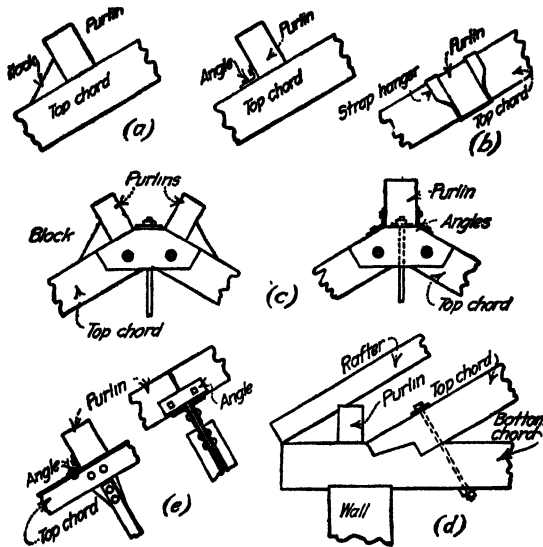

FIG. 6.

limited, the connection shown in Fig. (b) is used. The purlin is suspended by means of a strap hanger, or by means of one of the patent hangers. Figures (c) and (d) show details of connections at the apex of the truss and at the wall. For the design of such connections see Art. 27. Figure (e) shows a type of connection used for wooden purlins on steel roof trusses. A short clip angle is riveted to the top chord and the purlin is fastened to this clip angle by means of lag screws.

Purlins for steel roof trusses are generally made of rolled sections, although in some cases wooden purlins are used, as shown by the detail of Fig. 6(e). The rolled sections most used as purlins are the I-beam, the channel, and the angle. T-bars and Z-bars are sometimes used, but their use is limited, as Z-bars are hard to obtain, and the T-bar is not an ideal beam section. In selecting rolled sections from the steel handbooks, it is best to use the section of minimum weight for any given depth, as these sections are stock sizes and are easily obtained. A list of standard sections is given in Art. 10.

Figure 7 gives details of I-beam, channel, and angle purlin connections. Figure (a) shows an I-beam connection. The connection is made by rivets or field bolts. Figure (b) shows the usual type of connections for angles and channels. A clip angle is shop riveted to the truss, as shown. The length of this clip is such that at least one rivet can be placed in the end of each purlin. Figure (c) shows details of purlin connections at the apex of the truss. Figure (d) shows the arrangement at the wall for a truss on masonry walls. This arrangement is not always followed, for in many cases a purlin is not used at this point. These

sketches show two general classes of details. In one case the purlin is fastened directly to the top chord. In the other, adequate direct connection to the top chord can not be secured. To provide proper connection, the gusset plates are enlarged and the purlin is fastened to the plate by means of a standard I-beam

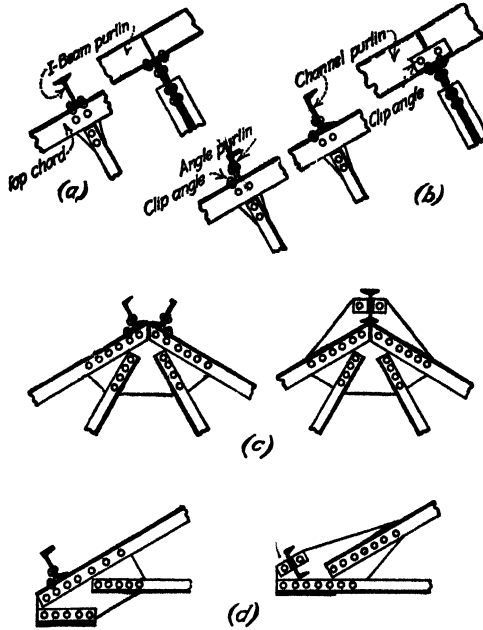

FIG. 7.

or channel connection. As a great variety of special connections are in use for details at these points, only a few of the more common types are shown.

Purlins for truss spacing greater than about 20 ft. can not be provided economically by single rolled shapes. It is necessary to use a form of plate or trussed

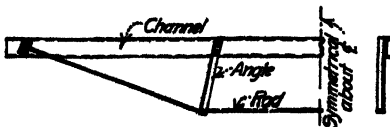

FIG. 8

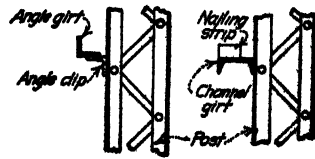

FIG. 9.

girder, or if the span is not too great, a trussed purlin, such as shown in Fig. 8, can be used. Where the girder purlin is used, it is usually placed in a vertical position. A form of roof truss must be selected which contains vertical members so located as to provide proper end connections for the purlin. Trusses of the type of Fig. 4 (i), (k), (l), or (m) provide the necessary vertical members, where a moderate span length is used. Trussed purlins are generally used where a very wide truss spacing is necessary to obtain maximum economy.

Girts are usually made of angle or channel sections. Figure 9 shows the method of connecting the section to the supporting column. For spans of 15 ft. or more, it is necessary to provide a line of tie rods which extend vertically to the eaves. This relieves the bending stresses in the girts and permits the use of smaller sections.

8. Connections between Purlins and Roof Covering.—Figure 10 shows a few of the methods used in fastening the roof covering to the purlins. Figure 10(a) shows the details of connections between rolled steel sections and plank

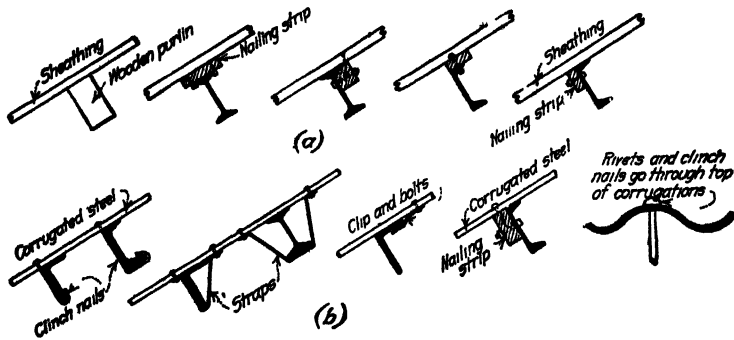

FIG 10

sheathing. As shown, a nailing strip is fastened to the section. The sheathing is then nailed to this strip. Where wooden siding is used, it is fastened to the girts in a similar manner.

Corrugated steel roofing and siding are fastened to the purlins or girts by the methods shown in Fig. 10(b). Clinch nails are used with angle purlins, and sometimes with the smaller channels. The nails are made of soft wire, and are clinched around the purlins. Strap fastenings are used with all sections. The straps are made of No. 18 gage steel about $\frac{3}{4}$ in. wide, and are fastened to the covering by a stove bolt in each end of the strap. Clip fastenings are made of No. 16 gage steel. The usual dimensions are $1\frac{1}{2} \times 2\frac{1}{2}$ in. They are fastened to the covering by two stove bolts at one end of the clip to prevent turning. A nailing strip is preferably used with an anti-condensation lining, and also for fastening siding to girts. In all cases the fastenings are spaced about a foot apart.

9. Bracing of Roofs and Buildings.—The bracing to be provided for a roof depends upon the character and use of the building. For a roof supported on masonry walls, the object of the bracing is to provide a stiff rigid structure which will not be subjected to vibration due to machinery or moving loads, such as cranes, etc. In the case of a roof supported on steel columns, the entire structure is dependent on bracing for stability against lateral forces. The trusses must be thoroughly braced and the columns must be connected by longitudinal and transverse systems of bracing. Without such bracing the structure would collapse in a high wind storm or due to stresses and vibration from moving loads, such as cranes. In general it can be said that bracing should be so located that the lateral forces will be transmitted as directly as possible to the walls and foundations of the building.

Bracing for a roof supported on rigid walls is not subject to analysis for stresses, as the forces acting on the bracing are indefinite in nature. The designer must use his judgment, based on past experience, in the determination of the form of bracing and the make-up of the sections. In the case of roofs supported on columns it is possible to determine approximately the stresses in the bracing. This problem is considered in detail in the chapter on the "Detailed Design of a Truss with Knee-braces"

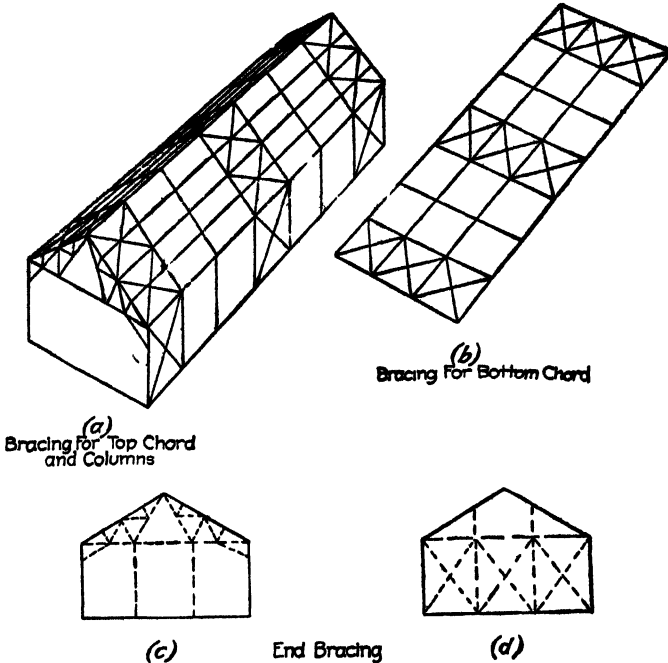

FIG 11

Roof trusses supported on columns should be provided with bracing for the trusses and also bracing for the columns. Figure 11 shows the relative position of the required bracing. Every third or fourth pair of trusses should be rigidly braced with diagonals placed in the planes of the upper and lower chords of the trusses. The unbraced trusses between the pairs of braced trusses should be connected to the others by unbroken lines of struts running the full length of the building and located at the eaves, the apex of the truss, and at several points in the plane of the lower chord of the truss, at distances apart depending upon the width of the building. These distances should be such that the diagonals of the bracing will form angles of about 45 deg. with the loads to be carried.

Column bracing should be provided for the bays in which the trusses are braced, as shown in Fig. (a). This bracing consists of rods or rolled shapes. The bracing should be so arranged that the members make angles of about 45 deg. with the horizontal.

A system of bracing is also to be provided in the plane of the ends of the building. This bracing must assist in carrying the transverse forces. Two forms of

such bracing are shown in Fig. 11. Figure (c) shows a knee-braced bent similar to the others. This truss provides the required bracing for transverse forces, and also supports a set of vertical members which carry the girts and siding. The horizontal forces brought to the lower chord of this truss by the siding are resisted by the horizontal trusses in the plane of the lower chord of the main trusses.

Figure (d) shows an arrangement of vertical beams which carry the girts and the siding. These beams transfer part of their load to the bracing in the plane of the lower chord of the main trusses. Vertical diagonal bracing is provided in the plane of the end of the building, as shown in Fig. (d).

Buildings with rigid side and end walls of masonry require bracing only in the planes of the upper and lower chords of the trusses. This bracing can be of the same general form as described above for the roof on steel columns, except that a strut is not required at the eaves. A detail design of bracing for a roof of this kind is given in the chapter on the "Detailed Design of a Steel Roof Truss."

✓10. Choice of Sections.—In selecting the rolled shapes with which the members of the truss are to be formed, the designer must be governed not only by the required area but also by the ease with which the section can be obtained from the rolling mills. If any section is in great demand, it will be rolled at frequent intervals, while a section for which there is little demand will be rolled only when the orders on hand will warrant a rolling of the section. It often happens, therefore, that the time element will determine the section to be used instead of the stress to be carried.

The sections which are the easiest to obtain, as a rule, are those of minimum weight for the shape in question. It will be found best to use as small a number of sections and sizes as possible, thereby insuring quick delivery. The various mills and large bridge companies have certain standard and permissible sections for which quick delivery is fairly certain. A short list of standard and permissible sections used by the American Bridge Co. is given in Table 4.

TABLE 4¹

STANDARD ANGLES		PERMISSIBLE ANGLES	
6 × 6 in.	6 × 4 in.	8 × 8 in.	6 × 3½ in.
4 × 4 in.	5 × 3½ in.	5 × 5 in.	4 × 3½ in.
3½ × 3½ in.	4 × 3 in.	2¼ × 2¼ in.	3½ × 2½ in.
3 × 3 in.	3½ × 3 in.	2 × 2 in.	3 × 2 in.
2½ × 2½ in.	3 × 2½ in.		
	2½ × 2 in.		
STANDARD CHANNELS		PERMISSIBLE CHANNELS	
15 in.	8 in.	9 in.	
12 in.	6 in.	7 in.	
10 in.		5 in.	
STANDARD I-BEAMS		PERMISSIBLE I-BEAMS	
20 in.	10 in.	24 in.	
18 in.	8 in.	9 in.	
15 in.	6 in.	7 in. ⁴	
12 in.		5 in.	

¹ "Steel Mill Buildings," and "Structural Engineers' Handbook," by M. S. Ketchum.

11. Form of Members for Roof Trusses.—Members for wooden roof trusses are made preferably of single pieces of timber, square or rectangular in shape. Where single pieces can not be obtained, members are built up of planks securely fastened together so that the parts of the member will act as a unit. The design of members of a wooden roof truss is considered in another chapter.

Figure 12 shows the form of members in general use for simple roof trusses of the type shown in Fig. 4. Compression chord and web members are made up as shown in Fig. (a). For members subjected to moderate stresses, two angles placed back to back, as shown in Fig. (a), will provide sufficient area. Angles with unequal legs are preferable, the longer legs to be placed together. In this way the ratio of length to radius of gyration of the combined section for axes OX

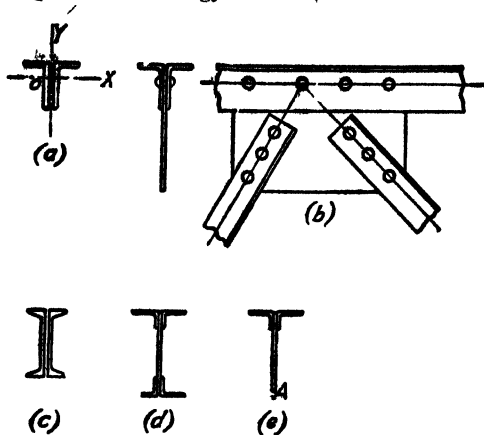

FIG. 12.

and OY of Fig. (a) can be made equal, or nearly so. The resulting column is then of equal rigidity in all directions. To make certain that the two angles act as a unit, they must be riveted together at intervals such that the ratio of unsupported length to radius of gyration for a single angle is equal to or less than that for the combined section. This detail will be considered further in Art. 37.

Connections between chord and web members are made by separating the two angles by a small space which will allow a connecting plate to be inserted, as shown in Fig. (b). This space between the angles is maintained over their entire length by means of ring fills or washers located at the connecting rivets. The size and shape of the connecting plates, which are known as gusset plates, depend upon the number of rivets to be provided in the connection.

Where very large stresses are to be carried, the form of members shown in Figs. (c), (d), and (e) are used. The form of Fig. (c) shows two rolled channels in place of angles, and Fig. (d) shows a built-up member consisting of 4 angles and 1 plate. In some cases the form of Fig. (e) is used. This form consists of 2 angles and 1 plate. The plate acts as a part of the chord member, and at the joints it acts as a gusset plate, similar to the arrangement shown in Fig. (b).

In some forms of trusses the purlin spacing is such that purlins must be placed at points between the top chord joints. The top chord section is then subjected to bending in addition to direct stress, and the section must be designed as a

combined beam and column. For members subjected to moderate stress and bending, the form of member shown in Fig. (a) can be used. Figures (c) and (d) show forms adapted for large moments and direct stresses. The form of Fig. (e), although often used for members subjected to bending, is not a desirable form of beam section. This is due to the fact that the top chord member of a roof truss is continuous from end to end, thus forming a continuous girder, and the moments at points of support are negative. Therefore the narrow edge of the plate at A, Fig. (e), is in compression. As this plate is not well supported at the joints, it is likely to buckle sidewise. The forms of Figs. (c) and (d) are not subject to this objection.

Tension members are also made of two angles placed as shown in Fig. (a) Equal legged angles can be used for tension members, as it is not necessary to

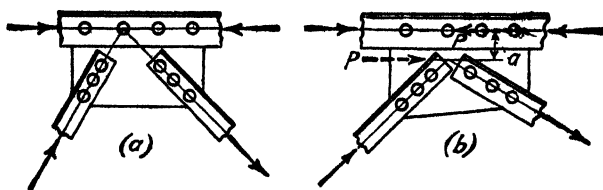

FIG. 13.

secure equal rigidity in all directions. Where tension members are subjected to bending as well as direct stress, the forms of Figs. (c) and (d) can be used.

12. Joint Details for Roof Trusses.—The design of joint details of a roof truss is a matter of the greatest importance. An investigation of the causes of roof truss failures will show that, in most cases, the failure can be traced to faulty joint details. The same care and study should be devoted to the design of joints as to the design of the main members.

In designing joints, a point of great importance is that the center lines of all members entering a joint should meet at a common point, which should be located at the intersection of the center lines of the truss members, as shown in Fig. 13 (a). If this point is overlooked, as shown in Fig. (b), where the intersection point of the diagonals is at a distance a from the line of action of the remaining members, there is set up a bending moment Pa , which tends to twist the joint out of position. This moment must be resisted by the members entering the joint. Proper provision should be made for the increased stresses, or the detail should be changed so as to eliminate the moment.

The designer, in addition to satisfying the above requirement, should carefully trace the stresses from the several members into the joint, making certain that proper connections have been made, and that all parts are proportioned to care for the stress which they may be called upon to carry.

Most specifications state that symmetrical sections shall be used for principal members. Others allow the use of single angles for members with small stress. Figure 14 shows a connection made for a member composed of a symmetrical section and another made of a single angle. In Fig. (b) is shown a symmetrical member composed of two equal angles, one on each side of the gusset plate. The stress in the member can then be considered as brought directly to the gusset

plate. In Fig. (a), where a single angle is used, the center line of the member and the plane of the truss do not coincide. The member is then subjected to a direct stress P and a bending moment $M = Pa$, where a is the distance from the center of gravity of the angle to the plane of the truss. For the conditions shown in Fig. (a), the design must be carried out by the methods given for bending and direct stress in the volume on "Structural Members and Connections." The usual methods often neglect entirely the effect of the eccentric connection, which leads to a faulty design.

In addition to the large bending stresses in the member in question, as shown in the detail of Fig. 14(a), there is also present the effect of the eccentric load on the other truss members. A load applied to the side of a plate, as shown in Fig. (a), tends to twist the top chord out of line, thereby setting up additional stresses in the chord section. It therefore seems best to specify that all members carrying calculated stress shall be composed of symmetrical sections, or sections which will allow a symmetrical connection of the form shown in Fig. (b) to be made.

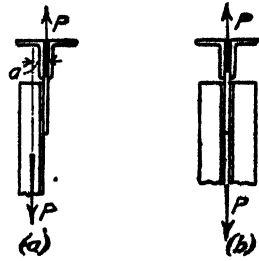

FIG. 14.

13. Loadings for Roof Trusses.—The load to be carried by a roof truss consists of the weight of the truss, the roof covering, purlins, bracing, and any other loads, such as ceilings, suspended floors, and machinery, etc., in factory buildings. In addition to these loads, the roof must be designed to carry the maximum wind and snow loads which experience shows are likely to occur in the particular locality. These loads will be considered in the following articles.

TABLE 5.—WEIGHTS OF BUILDING MATERIALS

(Pounds per square foot)

Copper roofing, sheets	1½
Corrugated iron, painted or galvanized	
No. 26, 1 lb.; No. 24, 1.3 lb.; No. 22, 1.6 lb.; No. 20, 1.9 lb.; No. 18, 2.6 lb.; No. 16, 3.3 lb.	
Felt and asphalt roofing	2
Felt and gravel roofing	8 to 10
Plastered ceiling	10
Sheathing, 1 in. thick	
White pine, hemlock, spruce	3
Yellow southern pine	4
Shingles, common	2½ to 3
Skylights, including frames	
¼-in. glass, 4½ lb.; ⅜-in., 5 lb.; ½-in., 6 lb.	
Tile, corrugated, 8-10; flat, 15-20.	
Tin, sheets or shingles	1 to 1½

When a roof truss is to be designed to carry additional loads of the nature mentioned above, the amount of these loads must be determined, together with their points of application on the truss. To assist in the calculation of these loads

there is given in Table 5 the weights of building materials in common use for roofing.

14. Weight of Roof Trusses.—The weight of a roof truss must be known before the true maximum stresses can be determined. Since the size of the members, and therefore their true weight, is dependent upon the stresses, it follows that the true weight of the truss must be known before a correct design can be made. The true weight of a truss can be determined by cut and try methods. A preliminary design can be made using an assumed weight. The weight of the structure as designed can then be determined and the assumed and calculated weights compared. If these weights do not agree within a reasonable limit, another design must be made, using an estimated weight based on the calculated weight of the preliminary design. This process, if repeated, will finally lead to the desired true weight.

In general it will be found that for trusses of moderate size, spans of 80 ft. or less, the weight of the truss is a small part of the total load to be carried. The greater part of the load, as the weight of the roofing, purlins, bracing, and the wind and snow loads, can be determined as soon as the local conditions are known. For trusses of the size mentioned, it will be found that the weight of the truss represents about 10 or 15 per cent of the total load to be carried. Therefore the preliminary estimate of truss weight need not be very accurate, as a relatively large error in the estimated weight will result in a small error in the total load. Thus, if the dead load be 15 per cent of the total load, and an error of 30 per cent be made in estimating the dead load, the resulting error is $0.3 \times 15 = 4.5$ per cent of the total load. It is therefore probable that the true weight, as determined by the process outlined above, can be found from the second trial design.

Bridge companies and designing engineers have collected the actual shipping weights of roof trusses of moderate span designed for a great variety of loading conditions. From this information empirical formulas have been derived from which it is possible to estimate the approximate weight of a given truss. Instead of using the long process indicated above, the weight of a truss is calculated from a selected formula. If the proper formula has been used, the actual and assumed weights will usually be found to agree within reasonable limits, and a revision will not be necessary.

The factors which influence the weight of a roof truss are the type of truss, pitch of roof, character of roof covering, distance between trusses, amount and distribution of loading, assumed combinations of loading, working stresses, general requirements of the specifications as to details and minimum thickness of material, and the personal equation of the designer. It can be seen, then, that a formula for roof truss weight, in order to yield reliable results, must be used for the conditions for which it was derived. In most cases this information is not given with the formula. As there are so many factors which affect the weight of a truss, it is to be expected that the formulas collected from different sources will not agree. An interesting comparison of this nature made by R. Fleming is given in the *Eng. News-Record*, vol. LXXXII, No. 12, March 20, 1919, p. 576, to which the reader is referred.

From an examination of the weight data for a large number of simple roof trusses of $\frac{1}{4}$ pitch supported on masonry walls, the weight per sq. ft. of horizontal covered area was found to range from about 2 to 2.5 lb. for spans of 30 ft. to about

5 or 6 lb. for spans of 100 ft. Within these limits the weight of bracing was found to vary from about 0.3 to 0.8 lb. Trusses of greater or less slope were found to have weights differing from 5 to 25 per cent of the values given above. The variation in weight due to different loadings was found to be equal to from 25 to 75 per cent of the change in loading. Trusses with cambered lower chords were found to weigh from 15 to 40 per cent more than corresponding trusses with flat chords.

The following formulas are a few of those proposed for the determination of the weight of roof trusses.

TABLE 6.—FORMULAS FOR WEIGHT OF ROOF TRUSSES

Formulas for Wooden Roof Trusses

$$\begin{aligned} w &= 0.04L + 0.000167L^2 && \text{N. C. Ricker} \\ w &= 0.5 + 0.075L && \text{H. S. Jacoby} \\ w &= 0.75(1 + 0.10L) && \text{M. A. Howe} \end{aligned}$$

Formulas for Steel Roof Trusses

$$\begin{aligned} w &= 0.06L + 0.6 \text{ for heavy loads} \\ w &= 0.04L + 0.4 \text{ for light loads} \\ w &= 0.20(\sqrt{L} + 0.125L) \end{aligned} \left. \begin{array}{l} \\ \\ \end{array} \right\} \begin{array}{l} \text{C. E. Fowler} \\ \text{Carnegie Handbook} \end{array}$$

For 40 lb. per sq. ft. capacity. For other loads multiply formula by ratio: Load per sq. ft. \div 40.

Formula for steel mill building trusses

$$w = \frac{P}{45} \left(1 + \frac{L}{5\sqrt{A}} \right) \quad \text{M. S. Ketchum}$$

In the above formulas, w = weight of truss in lb. per sq. ft. of horizontal covered area, L = span in feet, A = distance between centers of trusses in feet, and P = capacity of truss in lb. per sq. ft. of horizontal covered area.

In roof trusses for large structures, such as long span trusses for train sheds or auditoriums, the dead weight of the trusses forms a large part of the total load to be carried. The weight of the trusses must then be known within much narrower limits than in the case of short spans. As long span roof trusses are not as common as those of shorter spans, there is available very little weight data from which to derive weight formulas. Also, the conditions to be met differ so widely that a general formula available for all cases is entirely out of the question. The designer must then resort to the cut and try method outlined above for the determination of the weight of the trusses.

15. Wind Loads.—The maximum wind load to be carried by a roof has been determined by experiment and by observation of the results of severe wind storms. Experiments show that the pressure on a plane surface normal to the direction of the wind varies approximately with the square of the wind velocity. From experiments made at Mt. Washington in 1890, Prof. Marvin derived the formula¹

$$P = 0.004V^2$$

where V = velocity of wind in miles per hour, and P = pressure in pounds per sq. ft. Later experiments made at the Eiffel Tower and at the National Physical Laboratory of England gave results in close agreement, but with somewhat

¹ *Eng. News*, Dec. 18, 1890.

smaller values than obtained by Prof. Marvin. The observed values are expressed by the formula

$$P = 0.0032V^2$$

It was found by observation that the pressure varied greatly over a large area, due to the variable character of the wind. During the erection of the Forth Bridge, Sir Benjamin Baker found that the ratio of unit pressure upon an area of $1\frac{1}{2}$ sq. ft. to that on an area of 300 sq. ft. varied from 1.3 to 2.5, averaging 1.5. During a seven-year period the maximum observed pressure on the smaller area was 41 lb. per sq. ft.; while that on the larger area was 27 lb.¹

No measurements have been made of wind pressures during tornadoes. Damage resulting to structures during the St. Louis tornado of 1896 indicated that there must have been a pressure of 60 lb. per sq. ft. on a length of 180 ft.² A study of the effects of tornadoes made by C. Shaler Smith and others leads to the conclusion that the maximum wind pressures are exerted over a comparatively small width, and that pressures exceeding 30 lb. per sq. ft. are not likely to extend over a width exceeding 60 ft.³

A study of the above data indicates that a maximum pressure of 30 lb. per sq. ft. is ample for structures in an exposed position. For structures in a protected position, 20 to 25 lb. per sq. ft. is ample.

(The results quoted above are for surfaces perpendicular to the direction of the wind, which is assumed as horizontal.) In the case of roof trusses, the roof surface is usually inclined to the horizontal, and therefore to the direction of the wind. It is usually assumed that the resultant pressure of the wind is entirely normal to the roof surface. This assumption is reasonable, since the friction of the air on comparatively smooth surfaces is very small. The component of wind pressure parallel to the roof can then be neglected without sensible error.

The pressure on surfaces inclined to the direction of the wind has been determined by experiment. Experiments made in 1829 by Col. Duchemin, a French army officer, are the basis of the Duchemin formula, which is considered to give the most reliable results and to represent the best knowledge on the subject. The Duchemin formula is

$$P_n = P \frac{2 \sin \alpha}{1 + \sin^2 \alpha}$$

where P = unit pressure in lb. per sq. ft. on a surface perpendicular to the direction of the wind, P_n = component of pressure normal to the roof, and α = angle which the inclined surface makes with the direction of the wind. The vertical and horizontal components of P_n , shown in Fig. 15, are given by the formulas

$$P_h = P \frac{2 \sin^2 \alpha}{1 + \sin^2 \alpha} \quad \text{and} \quad P_v = P \frac{2 \sin \alpha \cos \alpha}{1 + \sin^2 \alpha}$$

where P_h and P_v are respectively the horizontal and vertical components of the unit pressure. Table 7 gives values of P_n for various angles.

¹ *Engineering*, Feb. 26, 1890.

² *Trans. Am. Soc. C. E.*, Vol. XXXVII, p. 221.

³ *Trans. Am. Soc. C. E.*, Vol. LIV, p. 37.

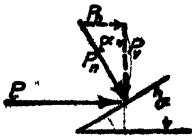

FIG. 15.

TABLE 7.—WIND LOAD IN POUNDS PER SQUARE FOOT OF ROOF SURFACE

Inclination	Normal pressure, P_n	
	$P = 30$ lb.	$P = 20$ lb.
5°	5 1	3 4
10°	10 1	6 7
15°	14 6	9.7
21° 48' 5" ($\frac{1}{8}$ pitch)	19 8	13.1
26° 33' 54" ($\frac{1}{4}$ pitch)	22 4	14.9
30°	24 0	16 0
33° 41' 24" ($\frac{3}{8}$ pitch)	25 5	17.0
45° ($\frac{1}{2}$ pitch)	28 3	18.9
60°	29 7	19 8
90°	30 0	20 0

Experiments made on small scale models of buildings indicate that the action of the wind causes a suction on the leeward side of the building in addition to the pressure on the windward side. An account of these experiments will be found in the *Proc. Inst. Civ. Engrs.*, vol. CLVI, p. 78, vol. CLXXI, p. 175; and in the *Journ. Western Soc. Engrs.*, Feb., 1911, Apr. and Dec., 1912. While this suction undoubtedly exists, as shown by the bursting effect of tornadoes, it is difficult to formulate a set of practical conditions to be used as a basis for designing. The experiments quoted above were made on small models, closed on the leeward side. Open windows on the leeward side of a shop building, or monitors at the ridge, will relieve all or a part of the pressure due to suction. This action should be recognized and provided for to the extent of making all members capable of resisting a reversal of stress, and by providing proper anchorage of trusses.

16. Snow Loads.—The snow load to be carried by a roof truss is a variable quantity, depending upon the slope of the roof, the latitude, and the humidity. Dry freshly fallen snow weighs about 8 lb. per cu. ft., and may attain a depth of 3 ft. on flat roofs. Packed or wet snow weighs about 12 lb. per cu. ft., but seldom will be found at greater depths than 18 in.

Table 8 gives snow loads for various latitudes and roof pitches.

TABLE 8.—SNOW LOADS FOR ROOF TRUSSES
(Pounds per sq. ft. of roof surface)

Location	Pitch of roof				
	$\frac{1}{2}$	$\frac{3}{8}$	$\frac{1}{4}$	$\frac{1}{8}$	Flat
	* †	* †	* †		
Southern States and Pacific Slope	0-0	0-5	0-5	5	5
Central States.	0-5	7-10	15-20	22	30
Rocky Mountain States	0-10	10-15	20-25	27	35
New England States.	0-10	10-15	20-25	35	40
Northwest States	0-12	12-18	25-30	37	45

* For slate, tile, or metal roofs. † For shingle roofs.

17. Combinations of Loads.—The proper combination of wind and snow load to be used with the dead load for the determination of the maximum stresses in the members of a truss is largely a matter of judgment on the part of the designer. It is generally assumed that the wind pressure acts normal to the windward surface of the roof, there being no pressure on the leeward surface. The unit pressure on a vertical surface is generally taken at 30 lb. per sq. ft. for exposed structures and at 20 lb. per sq. ft. for sheltered structures. Pressures on inclined surfaces are usually determined by the Duchemin formula for which values are given in Table 7 of Art. 15. The snow loads are given by Table 8 of Art. 16.

Some designers assume that the maximum stresses in a roof truss are due to the dead load and a combination of the full wind and snow loads acting at the same time. This does not seem to be a reasonable assumption, for it implies that the snow remains undisturbed under a wind velocity of 100 miles per hour. A wind storm of this intensity would blow all of the snow off a roof as fast as it falls.

Wet snow or sleet is likely to adhere to the roof surface even in a high wind, but the depth of such a deposit will seldom be greater than one-half of the probable maximum for that region. It would then seem best to provide for the maximum wind load and a snow load equal to one-half the value given in Table 8. In some cases the minimum snow is assumed to be 10 lb. per sq. ft. of roof for all slopes. To provide for the condition that a heavy snow storm may be accompanied by a light wind, it is sometimes specified that the maximum snow load shall be combined with a wind pressure of such intensity that the snow load will not be disturbed. This wind pressure is estimated at from $\frac{1}{2}$ to $\frac{1}{3}$ of the maximum wind pressure.

Other designers assume that the snow load exists only on the leeward surface of the truss in combining wind and snow loads. This assumption does not seem reasonable, as eddy currents are set up on the leeward surface of the truss due to the reduction of pressure caused by the wind blowing over the top of the roof. These currents of air tend to clear the leeward surface of all snow.

The combinations of loading which seem to be most reasonable, and to approximate actual conditions are:

- (a) Dead load and maximum snow load.
- (b) Dead load, maximum wind load, and one-half the snow load or a minimum snow load of 10 lb. per sq. ft. of roof.
- (c) Dead load, one-half or one-third wind load, and maximum snow load.

The stress to be used in the design of the member is the greatest obtained from these combinations. In a region of moderate snow fall it will be found that the stresses obtained for (b) and (c) are practically equal for trusses of the type of Fig. 4. For very large roofs of varying slopes both combinations must be tried out to determine the maximum stress. Where a heavy snow fall occurs, as in the far North, it is very likely that cases (a) or (c) will give the maximum stress.

It has been found that for simple roof trusses of the type shown in Fig. 4 resting on masonry walls, the maximum stresses due to wind and snow loading for cases (b) and (c) do not differ materially from those determined for a uniform vertical load over the entire roof surface. The great advantage of such a method, for the cases to which it will apply, is the ease with which the stresses can be determined. By means of the tables of stress coefficients given in the volume on

"Stresses in Framed Structures," the time spent in stress calculation can be reduced greatly.

Before this short cut method of stress calculation is applied to the determination of the stresses in a given truss, it is necessary to know the limitations of the method. Comparative stress calculations made by the uniform vertical load method and by the normal wind load method for trusses of the Fink, Pratt, and Howe type, as shown in Figs. 4(a) to (k) incl, and (p) show that for wind effect only, the first method of calculation gives chord stresses which are greater than those obtained by the second method, while the second method gives stresses in some of the interior members which are greater than those obtained by the first method. In no case was a reversal of stress found to occur. Since the stresses due to wind form from $\frac{1}{8}$ to $\frac{1}{2}$ of the total stress in the members, it was found that when the combined effect of the dead, snow, and wind loads was considered, the total stresses obtained by the two methods were close enough for all practical purposes.

One of the important points in a short cut method of this nature is the selection of the proper equivalent uniform load to be used. This is a matter on which the designer must use his judgment. Before deciding on the load to be used, the designer should make a study of the case in hand. By trial an equivalent load can be determined which will answer the conditions. This load will differ for trusses of different types, a point which must be checked up by the designer. Table 9 gives values of combined wind and snow loads.

TABLE 9 —COMBINED WIND AND SNOW LOADS FOR ROOF TRUSSES
(Pounds per sq. ft. of roof surface)

Location	Pitch of roof					
	60°	45°	$\frac{1}{2}$	$\frac{1}{4}$	$\frac{1}{8}$	Flat
Northwest States	30	30	25	30	37	45
New England States	30	30	25	25	35	40
Rocky Mountain States	30	30	25	25	27	35
Central States	30	30	25	25	22	30
Southern and Pacific States	30	30	25	25	22	20

A point which comes up in the determination of the areas of the sections for the members of a roof truss is the working stresses to be used for the different kinds of loadings. Most designers determine the maximum stresses by either of the methods mentioned above and apply the same working stresses for all loadings.

In deciding this point, it should be noted that the loads carried by a roof truss differ in nature. Thus the dead load is always present, and must be included in all combinations of loading. The snow load is not always present, but when present, it can be expected to exist for a considerable time. For loads of the character of the dead and snow loads, which may be considered as permanent loads, the allowable working stresses as specified, should be used. The wind

load, on the other hand, is quite variable in nature. From the values given in Art. 15, the specified wind load of 30 lb. per sq. ft. is due to a wind velocity of about 100 miles per hr. Such a wind pressure is then an extreme condition which is encountered but few times in the life of a structure, and then only for very short intervals of time. Maximum wind pressure can then be classed as an occasional loading, and the working stresses modified accordingly. This point has been discussed by R. Fleming in an excellent series of articles on "Wind Stresses."¹ He recommends that the working stresses for wind loads, when combined with dead and snow loads, be increased 50 per cent. This is done by decreasing the intensity of the unit wind pressure by $\frac{1}{2}$, and applying the same working stresses as for the dead and snow loads. Further discussion of this question will be found in the chapters on steel roof truss design.

DESIGN OF PURLINS FOR SLOPING ROOFS

18. Purlins Subjected to Unsymmetrical Bending.—A *purlin* is a member, generally a simple beam, which supports the roofing between adjacent trusses. Figure 16 shows the position of a purlin with respect to the other parts of a roof.



FIG. 16.

A complete discussion of choice of purlin sections, details of connections of purlins to trusses, and methods of fastening roof covering to purlins will be found in following chapters.

As shown in Fig. 7, p. 139, for steel roof trusses, and in Fig. 6, p. 138, for wooden roof trusses, purlins consisting of rolled shapes, or wooden beams, are usually placed with the webs, or sides, perpendicular to the top chord of the truss. Since in most cases the applied loads are vertical, or nearly so, it follows that the plane of loading and the principal axes of the section do not, in most cases, lie in the same plane. Problems in design and stress determination for such conditions can not be solved by the methods ordinarily used for simple beams, but require more general formulas which take into account the fact that the plane of bending and the principal axes of the section are not coincident. Bending of this nature is known as *unsymmetrical bending*, the formulas for which are given in the volume on "Structural Members and Connections."

19. Load Carried by a Purlin.—The amount and character of the load to be carried by a roof purlin depends to some extent upon the kind of roof covering, the slope of the roof, and the location of the structure. These points are considered in detail in Arts. 13 to 16 inclusive, where tables of values are given for the different loads.

The load which a purlin must be designed to carry is a combination of the weight of the purlin and roof covering, the snow load, and the wind load. These loadings are to be combined so as to give the maximum possible stress on the beam section. In general three combinations of loading are used. They are:

1. Dead load and snow load.
2. Dead load and wind load.
3. Dead load, wind load, and one-half snow load.

¹Eng. News, Vol. LXXIII, No. 5, p. 210, Feb. 4, 1915.

Under Case 3 only one-half of the snow load is considered. This is due to the fact that maximum wind and snow loadings are not likely to occur at the same time. If a high wind is blowing at the time snow is falling, the snow will be blown from the roof as fast as it falls. In the case of a wet snow or sleet, part of the snow will stay on the roof in spite of the wind. An allowance of one-half the maximum snow load seems to be reasonable for this condition.

The dead and snow loads are vertical forces, while the usual assumption regarding the wind load is that it acts perpendicular to the surface of the roof. For the combinations given above, (1) represents a vertical load, while (2) and (3) are inclined at an angle to the vertical.

20. Conditions of Design.—The conditions of the design are governed to some extent by the roof covering. Where the covering is very rigid, as in the case of wooden sheathing on common rafters, the loads can be resolved into components parallel and perpendicular to the roof. The component parallel to the roof is assumed as carried by the sheathing, and the component perpendicular to the roof is assumed as carried by the purlin. This is equivalent to assuming that the beam section is free to bend only in a plane perpendicular to the roof.

Where the roof covering consists of a material such as corrugated steel, which provides little or no lateral support for the purlin, the assumptions made above can not be used. It is then necessary to design the purlin as a beam which is free to bend in any direction, making use of the methods of unsymmetrical bending set forth in the volume on "Structural Members and Connections."

Purlins designed under this assumption are likely to require excessively large sections. To avoid this, the purlins are often partially supported laterally by means of tie rods. Smaller sections can then be used for the purlins.

The methods of design to be used in the cases mentioned above will be followed out for typical cases which will illustrate the methods to be used.

21. Design of Purlins for a Rigid Roof Covering.—Let it be required to design the sheathing, rafters, and purlins for a roof capable of withstanding the maximum combination of the dead load of its members and the wind and snow loads given in Art. 17. The material is to be pine with a working stress of 1,000 lb. per sq. in. Assume that the roof is covered with shingles; that the span of the rafters is 9 ft. (measured along the line of the roof surface, which makes an angle of 30 deg. with the horizontal), and that the trusses are 12 ft. apart. Figure 17(a) shows the general arrangement of members.

In making up the combinations of loads carried by the members it will be found convenient to determine the resultant load carried by a single square foot of roof. The resultants for the several combinations given above are as follows:

Case 1.—From the tables given in Art. 13, shingles weigh about 3.0 lb. per sq. ft. of roof, and 1-in. sheathing weighs about 4.0 lb. per foot board measure. The dead load is then 7.0 lb. per sq. ft. of roof, a vertical load. From Table 8, p. 149, the snow load for a roof at an angle of 30 deg. to the horizontal is 15.0 lb. per sq. ft. of roof. The total vertical load is then 22.0 lb. per sq. ft. of roof, and the component perpendicular to the roof is 19.0 lb. per sq. ft., as determined by the force diagram of Fig. 17(c).

Cases 2 and 3.—It is quite evident that the resultant for Case 3 has a greater component perpendicular to the roof than Case 2. As the direction of bending is not in question under the assumed conditions, we can pass at once to Case 3.

The dead load for Case 3 is the same as for Case 1, and the snow load is one-half as large as for Case 1. The vertical component of loading is then, $4 + 3 + 7.5 = 14.5$ lb. per sq. ft. of roof. From Table 7, p. 149, the wind pressure normal to the roof is 24.0 lb. per sq. ft. of roof. As these loads are not in the same direction, the resultant can be obtained by means of a force diagram. The component of load perpendicular to the roof can be determined by resolving forces parallel and perpendicular to the roof surface. The force diagram of Fig. 17(e) shows that the component perpendicular to the roof is 36.9 lb. per sq. ft. of roof. Similar calculations have been made for Case 2; the force diagram is shown in Fig. 17(d).

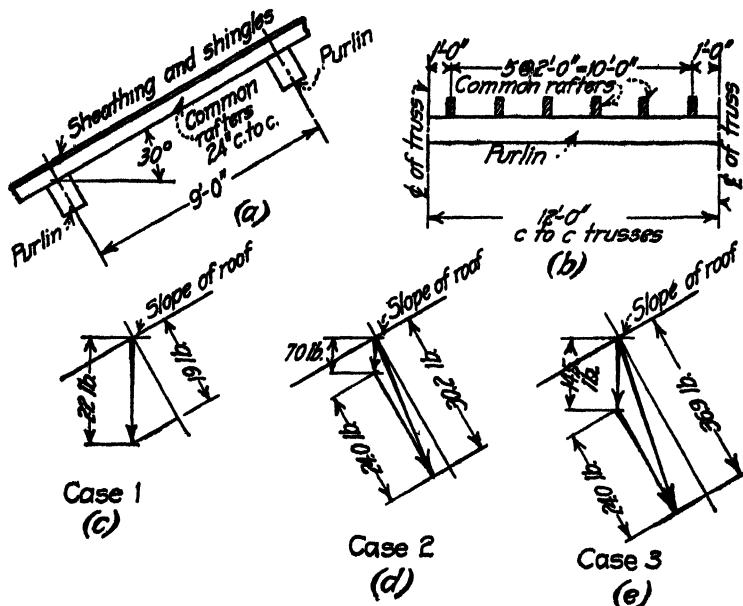

FIG 17

Design of Sheathing.—The sheathing is not usually designed, except where unusual conditions are encountered, such as heavy loads or rafter spacing greater than the normal, which is from 16 to 24 in. Under normal conditions, 1-in. sheathing will be found to provide sufficient strength.

In the case under consideration, assume that 1-in. sheathing is used and that the spacing of rafters is 24 in. The moment due to the normal component of Case 3 for a section of sheathing 1 ft. wide is, $M = \frac{1}{6}wl^2 = \frac{1}{6}(36.9)(2)^2(12) = 221.4$ in.-lb. This moment is resisted by a 1×12 -in. section of sheathing, for which the section modulus is $I/c = \frac{1}{6}bd^3 = \frac{1}{6}(12) \times (1)^3 = 2.0$ in.³ The resulting fiber stress is then $f = Mc/I = 221.4/2.0 = 110.7$ lb. per sq. in. This stress is very low, indicating that for ordinary conditions the design need not be carried out.

Design of Common Rafters.—A 2×6 -in. rafter will be assumed. At 4 lb. per ft. board measure, the dead weight per foot of rafter is $(2 \times \frac{3}{4})4 = 4$ lb. The roof area per foot is 2.0 sq. ft., and the normal load to be carried for Case 3 is $2 \times 36.9 = 73.8$ lb. per ft. of rafter. Adding the weight of the rafter, the total

load to be carried by the rafter is a uniform load of 77.8 lb. per ft. The moment is $M = \frac{1}{8}wl^2 = \frac{1}{8}(77.8)(9)^2(12) = 9,460$ in.-lb.

The section modulus of a 2×6 -in. rectangle is $\frac{1}{6}bd^3 = \frac{1}{6}(2)(6)^3 = 12$ in.³, and the fiber stress is $f = Mc/I = 9,460/12 = 788.0$ lb. per sq. in. As the allowable fiber stress is 1,000 lb. per sq. in., the assumed section is sufficient. Rafter sections come in commercial sizes, which are 2×4 , 2×6 , 2×8 , etc. It is therefore not possible to meet exactly the allowable fiber stress conditions with the available sections.

Design of Purlins.—As shown in Fig. 17(a), the purlin section is set at right angles to the rafter. It is then subjected to a normal load due to the rafters from adjacent panels. In some cases the applied loads are considered to be uniformly distributed along the purlin, and in other cases the loads are assumed as concentrated at each rafter. This latter assumption more nearly approximates the actual conditions; it will be used in this design.

As shown in Fig. 17(a), each purlin carries the ends of two rafters. Each rafter load is then due to the normal load on 9 ft. of rafter. Including the weight of the rafter, each load is $9 \times 77.8 = 700$ lb. Figure 17(b) shows the position of the loads. It will be found that the maximum moment for the position shown is slightly less than for an arrangement which places a load directly at the center of the purlin. From Fig. 17(b), the moment at the beam center is, $M = [(2,100)(6) - 700(1 + 3 + 5)]12 = 75,600$ in.-lb. Assuming a 6×10 -in. purlin, whose weight is $(6 \times \frac{10}{12})4 = 20$ lb. per ft., the moment due to its weight is $M = \frac{1}{8}wl^2 = \frac{1}{8}(20)(12)^2(12) = 4,320$ in.-lb. The total moment is then $75,600 + 4,320 = 79,920$ in.-lb.

For allowable $f = 1,000$ lb. per sq. in., $\frac{I}{c} = \frac{M}{f} = \frac{79,920}{1,000} = 79.92$ in.³. The section modulus of the assumed 6×10 -in. purlin is $\frac{I}{c} = \frac{1}{6}bd^3 = \frac{1}{6}(6)(10)^3 = 100$ in.³ which is sufficient. This is as close an agreement between assumed and adopted sections as is possible, using commercial sizes.

22. Design of Purlins for a Roof with a Flexible Roof Covering.—In the preceding article the design is given for a purlin section for a roof which is so rigid that it is possible to assume that the purlin is supported laterally so that it is necessary to provide only for bending in a plane perpendicular to the roof surface. A case will now be considered where the roof covering is not rigid enough to provide this support. The purlin will have to be designed as if it were free to bend in any direction. This is a case of unsymmetrical bending. Two cases will be considered, one in which the purlin is free to bend in any direction, the other in which the purlin is partially supported by tie rods.

22a. Purlin Free to Bend in Any Direction.—A purlin is to be designed to support a corrugated steel roof. The purlins are to be spaced 3 ft. apart, and the roof surface is inclined at an angle of 30 deg. to the horizontal; trusses are spaced 16 ft. apart.

The working loads will be taken the same as for the preceding design, and the working stress in the steel will be taken as 16,000 lb. per sq. in. Some designs are now made with a working stress of 18,000 lb. per sq. in. Combinations of loading similar to those for the wooden purlin will be made, and a purlin section determined by the methods used in the chapter on Unsymmetrical Bending in the volume on "Structural Members and Connections."

From Table 3, p. 137, 24-gage corrugated steel, weighing 1.3 lb. per sq. ft., can be used to span 3 ft. An anti-condensation lining, weighing 1.3 lb. per sq. ft. is to be used in connection with the corrugated steel. The total weight of covering is then 2.6 lb. per sq. ft. To this must be added the weight of the purlin. In the preliminary design, the purlin was assumed to weigh 4.0 lb. per sq. ft. of roof. After the purlin section was determined, its true weight was found and the calculations revised as given below.

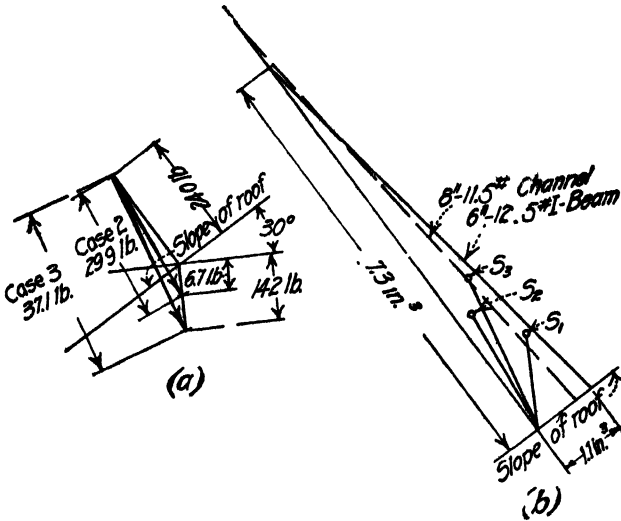

FIG. 18.

Case 1. Dead Load and Snow Load.—As given above, the weight of the roof covering is 2.6 lb. per sq. ft. of roof. The revised purlin weight is 4.1 lb. per sq. ft. of roof. As in the preceding design, the snow load is 15 lb. per sq. ft. of roof. The total vertical load is then, $2.6 + 4.1 + 15.0 = 21.7$ lb. per sq. ft. As the purlins are 3 ft. apart, the load per ft. of purlin is $3 \times 21.7 = 65.1$ lb. Considering the purlin as a simple beam of span equal to the distance between trusses, 16 ft., the moment to be carried is, $M = \frac{1}{8}wl^2 = \frac{1}{8}(65.1)(16)^2(12) = 25,100$ in.-lb. For an allowable working stress of 16,000 lb. per sq. in., the required section modulus is $S = \frac{M}{f} = \frac{25,100}{16,000} = 1.57$ in.³ This value is shown in the proper position in Fig. 18(b), and is the S value denoted by 1.

Case 2. Dead Load and Wind Load.—The dead load is the same as for Case 1, and the wind load is a normal load of 24 lb. per sq. ft. of roof, as in the preceding design. In Fig. 18(a), the resultant of the dead and wind loads as determined graphically, is 29.9 lb. per sq. ft. The load per ft. of purlin is $3 \times 29.9 = 89.7$ lb.; the moment to be carried is $M = \frac{1}{8}wl^2 = \frac{1}{8}(89.7)(16)^2(12) = 34,500$ in.-lb.; and the required $S = \frac{M}{f} = \frac{34,500}{16,000} = 2.16$ in.³ This is shown in Fig. 18(b) in the direction determined by the force diagram of Fig. 18(a).

Case 3. Dead Load, Wind Load, and One-half Snow Load.—The dead load is the same as for Case 1, and the wind load is the same as for Case 2. One-half

the snow load, as given by Case 1, is 7.5 lb. per sq. ft. of roof. The total vertical load is then 14.2 lb. per sq. ft. of roof, and the normal load is 24 lb. per sq. ft. The resultant of the loads, which is 37.1 lb. per sq. ft., is shown in amount and direction on Fig. 18(a).

The load per foot of purlin is $3 \times 37.1 = 111.3$ lb.; the moment to be carried is $M = \frac{1}{8}wl^2 = \frac{1}{8}(111.3)(16)^2(12) = 42,800$ in.-lb.; and $S = \frac{M}{f} = \frac{42,800}{16,000} = 2.67$ in.³ This is shown in position in Fig. 18(b).

Determination of Beam Section.—A purlin will be selected from I-beam and channel sections with the intention of keeping the weight as low as possible. It is usually specified that the depth of beam section shall be not less than $\frac{1}{50}$ of the span. This is done to avoid the use of sections for which the deflection would be excessive.

In Fig. 18(b), the S-polygon for a 6-in. 12.5-lb. I-beam is shown. This section is slightly larger than necessary, but it provides a closer fit than any other section of its weight. The true weight of the section is $\frac{12.5}{3} = 4.1$ lb., the value used in the revised calculations.

Figure 18(b) also shows the S-polygon for an 8-in. 11.5-lb. channel. This section does not provide sufficient strength, since S_1 projects beyond the S-line. As other channels are heavier than the adopted I-beam, there is nothing to be gained by further trials.

22b. Purlin Supported Laterally by Tie Rods.—Lateral support for purlins is generally provided by means of tie rods where the roof covering, such as corrugated steel, is not rigid enough to provide the proper support. These tie rods consist of round rods fastened to the web of the purlin section in the manner shown in Fig. 21. The ties should extend over the ridge, forming a continuous line between the eaves. This must be done to avoid an excessive side pull on the ridge purlin. If the arrangement of purlins at the ridge is such that a continuous line can not be used, then the upper ties should be run diagonally to the truss.

The number of ties required for each purlin will depend upon the length of purlin to be supported and the load to be carried. Generally a single line of ties at the center of the purlin will be found sufficient. Tie rods will not be found necessary for lateral support in the case of roofs where the slope is less than 3 in. to 1 ft. It is considered good practice to use tie rods in roofs with a rigid covering because of the lateral support provided for the purlins during the erection of the structure. The purlins are held in line without additional falsework until the roof covering is applied.

When a purlin is supported laterally by tie rods, the span of the beam, for components of load parallel to the roof surface, is equal to the distance between the tie rods, or between the tie rods and the truss. As far as these loads are concerned, the purlin is a continuous beam supported at its ends by the trusses and at intermediate points by the tie rods. For components of load perpendicular to the roof surface, the span of the purlin is equal to the distance between the trusses, as in the preceding design.

The applied loads are uniform per foot for both components of loading. They are determined by resolving the resultant forces, determined as for the preceding

design, into components parallel and perpendicular to the roof surface. Moments at critical points can be determined by the methods for simple and continuous beams.

In calculating the moments to be carried by a purlin, it will probably be best to assume that the purlins are only long enough to span the distance between adjacent trusses. The moment due to the component of loads perpendicular to the roof surface will then be given by the formula $M = \frac{1}{8}wl^2$. It will be found

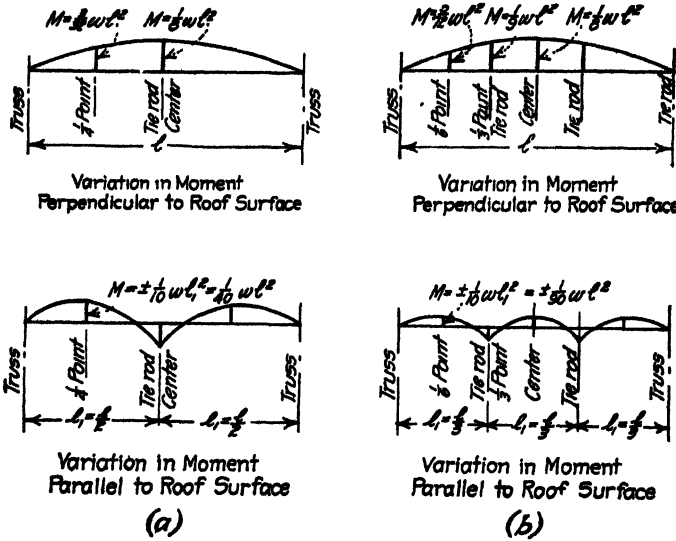

FIG. 19.

that if a purlin be assumed to span several trusses, and the moments calculated by continuous girder methods, the moment to be provided for will be only slightly less than for a simple beam.

For components of load parallel to the roof surface, the purlin can be considered as a continuous beam supported at its ends by the trusses, and at other points by the tie rods. The supports provided by the tie rods are not as rigid as those provided by the truss, so that the continuous girder coefficients should be modified somewhat. Figure 19(a) shows the values proposed for cases in which the purlin is assumed as divided into two parts by the tie rod, and Fig. 19(b) shows the values where the tie rods divide the purlin into three parts. It is assumed that the coefficient is $\frac{1}{10}$ instead of $\frac{1}{8}$, and that the span is equal to the distance from truss to tie rod.

In making use of the S-polygon methods in the design of purlins for the assumed conditions, it will be necessary to determine the resultant moment at the tie rod and also at a point half way between the tie rod and the truss. These resultant moments are equal to the vector sum of the component moments parallel and perpendicular to the roof surface. The values of the flexural modulus, S , are determined from these resultant moments, and the required and provided S compared by the methods used in the preceding design.

A purlin will now be designed supported by tie rods. The conditions will be taken the same as for the preceding design, with the further condition that the purlin is to be supported by a line of tie rods placed at the center of the purlin.

As the depth of the purlin is usually limited to $\frac{1}{30}$ of the span, a 6-in. section must be used. The 6-in. section of least weight is a 6-in. 8.2-lb. channel, which will be taken as the trial section. The weight of the assumed section per square foot of roof surface is $\frac{8.2}{3} = 2.7$ lb. Using other values as in the preceding design, the several combinations are as follows:

Case 1. *Dead Load and Snow Load.*—As before, the dead load due to corrugated steel and lining is 2.6 lb. per sq. ft. of roof, and the snow load is 15.0 lb. per sq. ft. The weight of

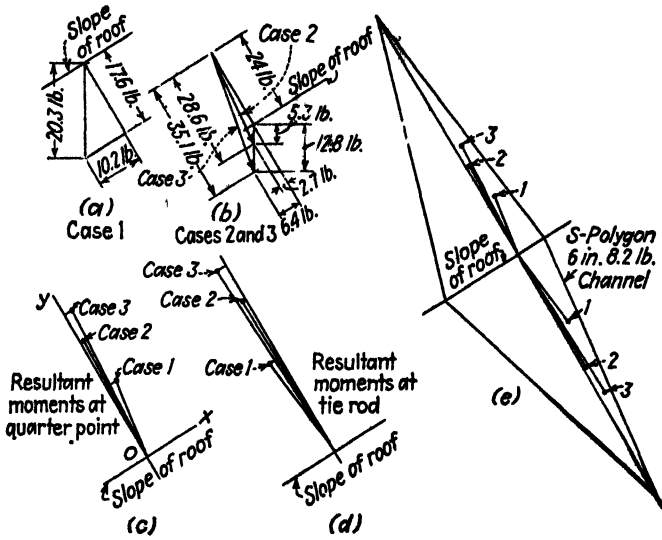

FIG. 20.

the assumed purlin section as given above is 2.7 lb. per sq. ft. of roof. The total vertical load is then 20.3 lb. per sq. ft. of roof. From the force diagram of Fig. 20 (a) the component of this load parallel to the roof surface is 10.2 lb. per sq. ft., and the component perpendicular to the roof is 17.6 lb. per sq. ft.

Using the coefficients shown on Fig. 19 (a), the component of moment parallel to the roof is $+\frac{1}{40}wl^2 = \frac{1}{40} (+10.2)(3)(12)(16)^2 = +2,350$ in.-lb. at the quarter point, and $-2,350$ in.-lb. at the tie rod. The component of moment perpendicular to the roof is $+\frac{3}{80}wl^2 = +\frac{3}{80}(17.6)(3)(12)(16)^2 = +15,200$ in.-lb. at the quarter point, and $+\frac{1}{8}wl^2 = +\frac{1}{8}(17.6)(3)(12)(16)^2 = +20,300$ in.-lb. at the tie rod.

The resultants of these moments, which are determined graphically by means of the force diagrams of Figs. 20(c) and (d), are 15,350 in.-lb. at the quarter point, and 20,450 in.-lb. at the tie rod. It is to be noted that at the tie rod the component moment parallel to the roof surface is negative. In determining the resultant moment Fig. 20(d), this component is plotted to the left of the origin. The component of moment perpendicular to the roof surface is positive, and is plotted above the OX axis, as in the preceding cases.

With allowable $f = 16,000$ lb. per sq. in., $S = \frac{M}{f} = \frac{15,350}{16,000} = 0.96$ in.³ at the quarter point, and $\frac{20,450}{16,000} = 1.28$ in.³ at the tie rod. These values of S are shown in position on the S-polygon of Fig. 20 (e). The values of S for the section at the tie rod are plotted below the OX axis, for, as shown by the complete S-polygon, the values of S for the given plane of bending are determined by the fourth quadrant S-line.

Case 2. *Dead Load and Wind Load.*—The dead load due to the roof covering and the purlin is a vertical load of 5.3 lb. per sq. ft., as determined for Case 1, and the wind load is a

normal load of 24 lb. per sq. ft., as determined for Case 2 of the preceding design. From the force diagram of Fig. 20 (b), the component perpendicular to the roof is 28.6 lb. per sq. ft., and that parallel to the roof is 2.7 lb. per sq. ft. By the methods of Case 1, it will be found that at the quarter point the component of moment perpendicular to the roof is +24,700 in.-lb., and that parallel to the roof is +625 in.-lb.; the resultant moment, as determined graphically by Fig. 20 (c), is 24,800 in.-lb.; and the required $S = \frac{24,800}{16,000} = 1.55 \text{ in.}^3$.

At the center point, the moment perpendicular to the roof is 32,900 in.-lb., and that parallel to the roof is -625 in.-lb.; the resultant moment, as determined by Fig. 20 (d), is 33,000 in.-lb.; and the required $S = \frac{33,000}{16,000} = 2.06 \text{ in.}^3$. These values are shown on Fig. 20 (e).

Case 3. Dead Load, Wind Load, and One-half Snow Load.—With the half snow load as 7.5 lb. per sq. ft., the total vertical load is 12.8 lb. per sq. ft. As in the preceding cases, the normal wind load is 24.0 lb. per sq. ft. From Fig. 20 (b), the component perpendicular to the roof is 35.1 lb. per sq. ft., and that parallel to the roof is 6.4 lb. per sq. ft. At the quarter point, the moment perpendicular to the roof is 30,300 in.-lb., and that parallel to the roof is +1,480 in.-lb. At the tie rod the corresponding values are: moment perpendicular to the roof = 40,500 in.-lb.; moment parallel to the roof = -1,480 in.-lb. From Fig. 20 (c), the resultant moment at the quarter point is 30,350 in.-lb.; the required $S = \frac{30,350}{16,000} = 1.90 \text{ in.}^3$. From Fig. 20 (d), the resultant moment at the tie rod = 40,600 in.-lb.; the required $S = \frac{40,600}{16,000} = 2.54 \text{ in.}^3$.

Determination of Purlin Section.—Figure 20 (e) shows the S-polygon of the assumed 6-in. channel section. It will be found that all of the plotted values of S lie inside of the polygon. The assumed section is therefore ample, and will be adopted.

The results of this design show that the use of tie rods makes it possible to use smaller sections for purlins than for the conditions assumed in the preceding design, where the purlins were assumed to be free to bend in any direction. Where the purlin was assumed to be free to bend in any direction, a 6-in. 12 5-lb. I-beam was required. Where tie rods were used, a 6-in. 8.2-lb. channel was found to answer. This represents a saving of 4.3 lb. per ft. of purlin.

From an inspection of the S-polygon of Fig. 20 (e), it can be seen that the values of required S lie close to the OY axis. For all cases, except where the roof slope is very steep, it will probably be correct to assume that the tie rods offer complete lateral support for the purlin. The design can then be carried out by the methods used in the design of the purlins for rigid roof covering, as given in the first part of this article.

Design of Tie Rods.—Tie rods usually consist of round rods threaded at the ends to provide a means of fastening the tie to the purlin section. Figure 21 (a) shows the type of connection generally used.

As the tie rods form a continuous line from the eaves to the ridge, the stress in the rods increases to a maximum at the ridge. The area of the tie rod at the root of thread must be sufficient to carry a load caused by the component of loads parallel to the roof acting over the area tributary to the tie rod of maximum stress.

To illustrate the methods of design, assume that the slant height of the roof considered in the preceding design is 36 ft. As the trusses are 16 ft. apart, and there is a single line of tie rods at the center of the purlin, the area tributary to the tie rod of maximum stress is $36 \times 8 = 288 \text{ sq. ft.}$ From the force diagrams of Fig. 20, it will be found that the greatest component of load parallel to the roof is caused by the loading of Case 1, and that this component is 10.2 lb. per sq. ft. of roof. The load to be carried by the tie rod is then $288 \times 10.2 = 2,940 \text{ lb.}$ With an allowable working stress of 16,000 lb. per sq. in., the area at the root of thread is $\frac{2,940}{16,000} = 0.184 \text{ sq. in.}$ From table of screw threads given in the steel hand-books, it will be found that a $\frac{5}{8}$ -in. round rod will answer. If the load to be carried is too large for a single line of $\frac{5}{8}$ to $\frac{3}{4}$ -in. tie rods, the load can be reduced by adding another line of ties.

The method of attachment of tie rods at the ridge requires some consideration. Two methods of making the ridge connection are shown in Fig. 21. In Fig. 21 (a), two purlins

are provided at the ridge. The line of tie rods on either side of the ridge is joined by means of a short connecting tie. Figure 21 (b) shows the force diagram for the determination of the stresses in the rods and the load to be carried by the purlin due to the tie rods. It is probable that a larger section will have to be provided at the ridge in order to carry the

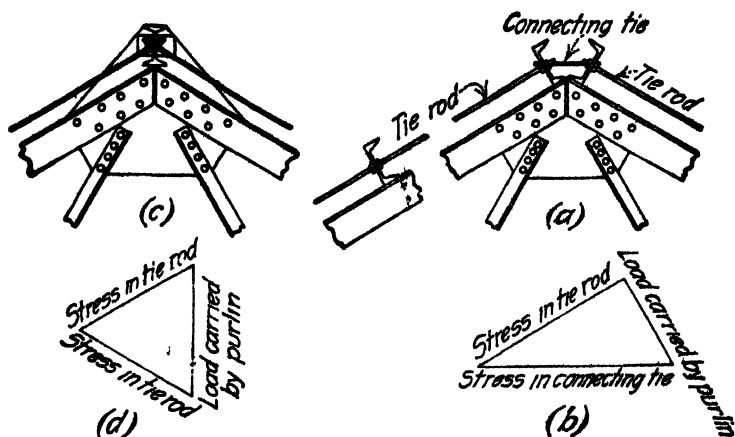

FIG. 21

heavy concentration brought to this point by the tie rod. Figure 21 (c) shows an arrangement in which a single I-beam forms the ridge support. The diagram of forces is shown in Fig. 21 (d).

DETAILED DESIGN OF A WOODEN ROOF TRUSS

23. Conditions Assumed for the Design.—To illustrate the principles governing the design of a wooden roof truss, a complete design will be made of a truss of the type shown in Fig. 4 (p), p. 132. It will be assumed that the truss is supported on masonry walls which are 50 ft. apart, and that the trusses are spaced 16 ft. apart. The roof covering will be shingles or sheathing carried by rafters spaced 16 in. on centers. Purlins placed at the top chord panel points carry the roof loads to the truss. Figure 22 shows the general arrangement of the roof and the trusses.

The pitch of the roof will be taken $\frac{1}{4}$, for, as stated in Art. 3, this is in general the most economical pitch. To secure members of reasonable length, the span will be divided into six panels, as shown in Fig. 23. All members will be made of wood, except the verticals, which will be steel rods. Western Hemlock will be used for all wooden truss members, and also for the purlins, rafters, and sheathing.

The loads to be carried by the truss will be taken in accordance with the principles stated in the chapter on Roof Trusses—General Design. Snow loads will be taken as 20 lb. per sq. ft. of roof surface, and the unit wind pressure will be taken as 30 lb. per sq. ft. of vertical surface. The unit wind pressure is to be reduced by the Duchemin formula in determining the components normal to the roof surface. Minimum snow load will be taken as one-half of the maximum, or 10 lb. per sq. ft. of roof, and the minimum wind load will be taken as one-third of the maximum.

The actual weight of the roof covering, rafters, and purlins is to be determined, assuming that Western hemlock weighs 3 lb. per foot board measure. In estimating the weight of the truss, the formula $w = 0.04l + 0.000167l^2$ will be used, where w = weight of trusses per sq. ft. of covered area, and l = span length in feet.

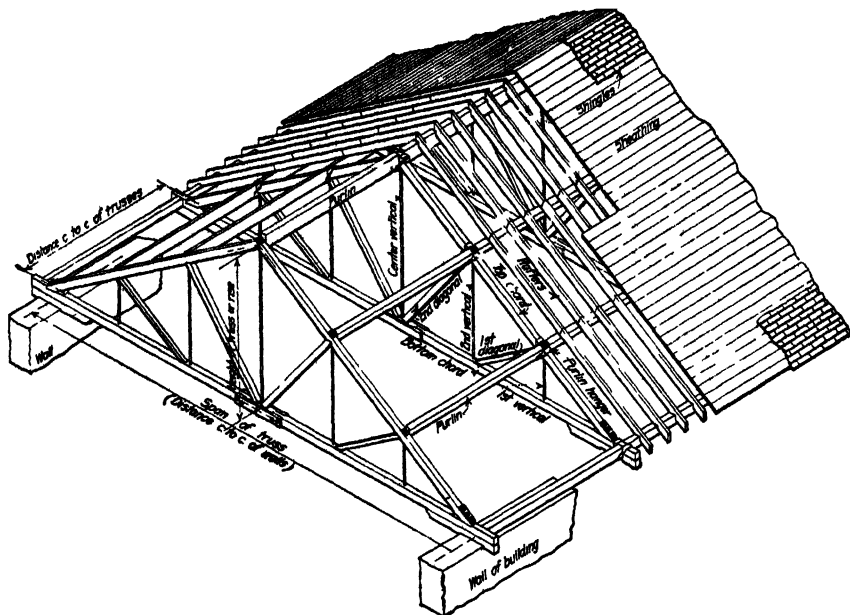

FIG. 22.—Detailed design of a wooden roof truss.

Combinations of loadings for maximum fiber stresses in rafters and purlins, and for maximum stresses in truss members will be as follows:

- (a) Dead load and snow load.
- (b) Dead load, minimum snow load, and maximum wind load.
- (c) Dead load, maximum snow load, and minimum wind load.
- (d) A minimum load of 40 lb. per sq. ft. of horizontal covered area. The object of this last loading condition is to make certain that a fairly rigid and substantial structure is obtained.

Working stresses for Western hemlock will be taken as recommended by the

American Railway Engineering Association.

For timber used in building construction, the working stresses are as follows: Extreme fiber stress in tension or cross bending, 1,650 lb. per sq. in.; shearing parallel to the grain, 240 lb. per sq. in.; shearing transverse to the grain, 150 lb. per sq. in.; compression—bearing

parallel to the fibers, 1,800 lb. per sq. in.; bearing perpendicular to the fibers, 330 lb. per sq. in.; columns under 15 diameters, 1,350 lb. per sq. in.; columns over 15 diameters in length, $1,800 \left(1 - \frac{l}{60d}\right)$ lb. per sq. in., where l = length of column

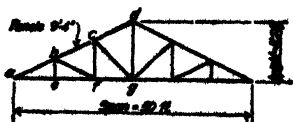

FIG. 23.

in inches and d = least side or diameter. Bearing pressures for washers which cover only a part of the area of the member can be increased 25 per cent that is, to 412.5 lb. per sq. in. for bearing perpendicular to the fibers, and 2,250 lb. per sq. in. for bearing parallel to the fibers. This increase in fiber stresses is allowable, for experiments have shown that the bearing pressures are indirectly distributed to the area immediately surrounding the washer, thus increasing its effective area. The allowable bearing pressure on masonry will be taken as 300 lb. per sq. in.

Where the compression acts at an angle to the member, the working stress is given by the empirical formula

$$r = q + (p - q) \left(\frac{\theta}{90} \right)^2$$

where r = allowable stress at an angle θ to the axis of the member, as shown in Fig. 24, and p = bearing on end fibers = 1,800 lb. per sq. in.; and q = bearing across the fibers = 330 lb. per sq. in. For these values the above formula becomes:

$$r = 330 + (1,800 - 330) \left(\frac{\theta}{90} \right)^2, \text{ or,}$$

$$r = 330 + 0.1815 \theta^2$$

Where pins or bolts bear on the end fibers of the material, as in the design of the built-up bottom chord member given in Art. 26, the allowable bearing values must be modified to fit the conditions shown in Fig. 24. The allowable bearing will be taken as two-thirds of the usual end bearing value, or as 1,200 lb. per sq. in. This working stress is considered as applied to the diametrical area of the pin or bolt.

In accordance with the discussion given in the chapter on Roof Trusses—General Design, the working stresses for wind will be increased 50 per cent over the values given above. This increase in working stresses can be accounted for by reducing the unit wind pressure so that the same working stresses can be used for all loadings. Since the working stresses for wind are $\frac{2}{3}$ of those for other loadings, if $\frac{3}{2}$ of the unit wind pressures be used, the same working stresses can be used for all loadings. The unit wind pressure on a vertical surface will then be taken as $\frac{3}{2} \times 30 = 45$ lb. per sq. ft. From the Duchemin formula, the normal pressure on a $\frac{1}{4}$ pitch roof is 14.9 lb. per sq. ft. of roof surface.

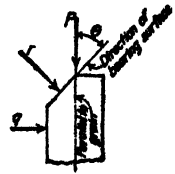

FIG. 24.

In choosing the sections of timber with which to form the members of the truss, it must be remembered that the actual size of a piece of timber should be used in the calculations. The dimensions usually given for timbers are the distances from center to center of saw cuts. These dimensions are known as the nominal dimensions of the piece; they are usually given in even inches, as for example, 2 × 4 in., 6 × 8 in., etc. Actually the timber is smaller than its nominal dimensions by the width of the saw cut, which is about $\frac{1}{4}$ -in. thick. Thus a rough-sawed piece, whose nominal dimensions are 4 × 6 in., is really only a $3\frac{3}{4} \times 5\frac{3}{4}$ -in. section. If this section is dressed, or planed on all sides, the section is about $\frac{1}{8}$ -in. scant all around from the nominal dimensions, or actually a $3\frac{1}{2} \times 5\frac{1}{4}$ -in. section is obtained instead of the 4 × 6-in. nominal section. The section obtained thus has an actual area of only about 80 per cent, and a section modulus

of only 79 per cent of the corresponding values for the nominal section. These percentages vary with the size of the timber.

The difference between the actual and the nominal sizes of timber is taken into account in the calculations by two different methods. In one method the unit stress is reduced by an amount depending upon the reduction in area or section modulus. This method, to be effective, requires the use of a sliding scale of corrections, which makes it rather undesirable. In another, and better method, the actual sizes are used and the working stresses taken as given above. This latter method will be used in the work to follow. It will be assumed that all material is dressed on four sides, and that the actual dimensions are about $\frac{1}{8}$ in. scant of the nominal dimensions. In speaking of sections, however, the nominal dimensions will be used.

The working stress for steel tension rods will be taken as 16,000 lb. per sq. in. on the net section of the rod at the root of thread. In general, round rods will be used. They will be upset at the ends if the diameter required is greater than $\frac{3}{4}$ in. Bending stresses in steel bolts will be taken as 24,000 lb. per sq. in.

24. Design of Sheathing, Rafters, and Purlins.—In the chapter on the Design of Purlins for Sloping Roofs, there is given a complete design of the sheathing, rafters, and purlins for conditions practically the same as assumed in the preceding article. Therefore, only the essential features of the design under consideration will be given. Wherever possible, reference will be made to the design mentioned above, and also to the design of the steel roof truss in the following chapter, for which similar conditions exist.

From Fig. 22 it can be seen that the span of the sheathing is 16 in., the distance center to center of rafters. As the loads are the same as for the above mentioned designs, it can readily be seen that 1-in. sheathing is satisfactory. The rafters are to be designed for the combinations of loading stated in Art. 23. As the roofing is quite rigid, it can be assumed that the load to be carried by the rafters is the component of loads perpendicular to the roof surface. It will be found that the loading of case (b) of Art. 23 gives the required maximum. The conditions are as shown in Fig. 25. (See also the design given in Art. 32.)

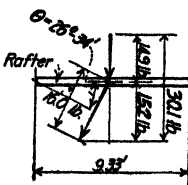

Fig. 25.

From the data given and the assumptions made in Art. 23, the minimum snow load is a vertical load of 10 lb. per sq. ft. of roof and the normal wind load is 14.9 lb. per sq. ft. of roof. Assuming that shingles weigh 3 lb. per sq. ft. of roof, and that 1-in. sheathing weighs 4 lb. per ft. board measure, it will be found from the force diagram of Fig. 25 that the total normal component is 30.1 lb. per sq. ft. of roof area.

From Fig. 22, the area carried by a rafter is $(1\frac{1}{2}) 9.33 = 12.4$ sq. ft., and the uniformly distributed load is $30.1 \times 12.4 = 373$ lb. If a 2×4 -in. rafter be assumed, whose weight at 3 lb. per ft. board measure is $3 \times 9.3 \times \frac{1}{2} = 13.7$ lb., the total uniformly distributed load is $373 + 19 = 392$ lb. Assuming that the rafters are continuous over several purlins, the moment to be carried can be calculated from the formula $M = \frac{1}{10} Wl = \frac{1}{10} \times 392 \times 9.33 \times 12 = 4,390$ in.-lb. For the working stress of 1,650 lb. per sq. in., given in Art. 23, the required section modulus is $\frac{4,390}{1,650} = 2.66$ in.³ Assuming the dimensions of a

dressed 2 × 4 to be 1½ × 3½ in., the section modulus furnished is $\frac{(bd^3)}{6} = 3.56$ in.³ The assumed section will be adopted, as it is the smallest advisable section.

As shown in Fig. 26, each purlin supports 12 rafter loads. From the calculations given above, each rafter load is 392 lb. Figure 26 shows the loads in position. The maximum moment occurs under the load next to the beam center. As the purlins usually span only the distance between trusses, simple beam conditions will be assumed, and $M = [2,352 \times 5.5 - 392(1 + 2 + 3 + 4 + 5)](16) = 112,800$ in.-lb. Assume a 6 × 10-in. purlin section. The weight of the assumed purlin is $6 \times 10 \times \frac{3}{4} = 15$ lb. per ft., and the moment due to its weight is $M = \frac{1}{2}wl^2 = \frac{1}{2} \times 15 \times 16^2 \times 12 = 5,760$ in.-lb. Total moment = $112,800 + 5,760 = 118,560$ in.-lb.

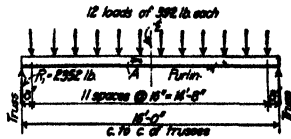

FIG. 26.

Required section modulus = $\frac{118,560}{1,650} = 71.8$ in.³

Section modulus furnished by a 6 × 10-in. purlin, dressed to 5½ × 9½ in., is 82.8 in.³ Although the assumed section is slightly over size, it will be adopted.

25. Determination of Stresses in Members.—The general methods of stress calculation are given in the volume on “Structural Members and Connections.” Stresses can be determined by means of the graphical methods given in the above mentioned section, or by means of the tables of stress coefficients given in the chapter on Roof Trusses—Stress Data in the volume on “Stresses in Framed Structures.” The latter method has been used in the design under consideration. As the general methods of procedure are given in detail in Art. 34, only the essential features are repeated here. The reader is referred to the discussion given in the following chapter, as it applies also to the design under consideration.

In Art. 23, the formula for the dead weight of the trusses is given as $w = 0.04l + 0.000167l^2$, where $l = \text{span} = 50$ ft., and $w = \text{weight of trusses in lb. per sq. ft. of horizontal covered area}$. Then $w = 0.04 \times 50 + 0.000167 \times 50^2 = 2.42$ lb. From Fig. 22, the horizontal covered area per panel is $50 \times 1\frac{1}{4} = 133$ sq. ft. The dead panel load due to the weight of the truss is then $2.42 \times 133 = 323$ lb. The dead load due to shingles is 3 lb. per sq. ft. of roof, and that due to sheathing is 4 lb., giving a total load of 7 lb. per sq. ft. of roof. From Fig. 22, the roof area per panel is $9.33 \times 16 = 149$ sq. ft. The dead panel load due to sheathing and shingles is then $149 \times 7 = 1,043$ lb. From Fig. 26, the weight of 12 rafters and one purlin is brought to each panel point. Each rafter weighs 18.7 lb., and the purlin weighs 15 lb. per ft., as given in Art. 24. The resulting panel load is $12 \times 18.7 + 16 \times 15 = 224 + 240 = 464$ lb. The total dead panel load is then $323 + 1,043 + 464 = 1,830$ lb.

As given in Art. 23, the snow load is 20 lb. per sq. ft. of roof, and the wind load is 14.9 lb. per sq. ft. of roof. Since the roof area per panel is 149 sq. ft., the snow panel is a vertical load of $149 \times 20 = 2,980$ lb., and the wind panel load is $14.9 \times 149 = 2,220$ lb., a load which acts normal to the roof surface. In Art. 23, a minimum load of 40 lb. per sq. ft. of horizontal covered area is also specified. The panel load for this loading is $40 \times 133 = 5,320$ lb., a vertical load.

The stresses due to the above panel loads are given in Table 10. Dead load stresses are given in col. 1; snow load stresses are given in col. 2; minimum, or half snow load stresses, are given in col. 3; wind stresses for wind from the left are given in col. 4, and for wind from the right, the stresses are given in col. 5; minimum, or one-third wind stresses, are given in col. 6. The wind stresses are cal-

culated on the assumption that both ends of the truss are rigidly fastened to the masonry walls, and that the reactions are parallel to the direction of the wind—that is, normal to the roof surface. The assumption of fixed ends is reasonable, for a wooden truss is not affected by temperature changes, and no provision for expansion need be made, as in the case of the steel truss.

TABLE 10.—STRESSES IN MEMBERS

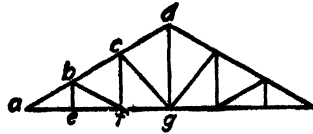

Member	Dead load 1	Snow load 2	One-half snow load 3	Wind from left 4	Wind from right 5	One-third wind 6	D. L., $\frac{1}{2}$ S. L., and wind 7	D. L., $\frac{1}{5}$ wind, and snow 8	Vertical loading 9	Maximum stress 10
ab	-10,250	-16,650	-8,325	-6,950	-4,160	-2,320	-25,525	-29,220	-29,800	-29,800
bc	-8,200	-13,320	-6,660	-5,270	-4,160	-1,760	-20,130	-23,280	-23,800	-23,800
cd	-6,150	-10,000	-5,000	-3,610	-4,160	-1,390	-15,310	-17,540	-17,820	-17,820
ae-cf	+ 9,180	+14,900	+7,450	+7,770	+2,800	+2,590	+24,400	+26,670	+26,600	+26,670
fg	+ 7,340	+11,920	+5,960	+5,280	+2,800	+1,760	+18,580	+21,020	+21,300	+21,300
bf	- 2,060	- 3,340	-1,670	-2,780	0	- 930	- 6,510	- 6,430	- 5,960	- 6,510
cg	- 2,590	- 4,200	-2,100	-3,520	0	-1,170	- 8,210	- 7,960	- 7,510	- 8,210
cf	+ 916	+ 1,490	+ 745	+1,230	0	+ 410	+ 2,990	+ 2,816	+ 2,660	+ 2,990
dg	+ 3,670	+ 5,960	+2,980	+2,480	+2,480	+ 825	+ 9,130	+10,445	+10,640	+10,640
be	0	0	0	0	0	0	0	0	0	0

+ = tension.

- = compression

The maximum stresses, as given by the combinations of cases (b), (c), and (d) of Art. 23, are given in cols. 7, 8, and 9 respectively. Stresses for col. 9 are calculated from the dead load by ratio of the panel loads for a minimum load of 40 lb. per sq. ft. of covered area, which is 5,320 lb., and the dead panel load, which is 1,830 lb. Col. 10 gives the greatest of these maximum values, which is the stress for which the members are to be designed.

26. Design of Members.—As stated in Art. 23, the top and bottom chord members and the diagonal web members will be made of timber, and the vertical members will be made of steel rods. The working stresses for the wooden compression members whose length exceeds 15 times the least width is given in Art. 23 as $1,800 \left(1 - \frac{l}{60d}\right)$, where l = length in inches, and d = least dimension in inches. Compression members whose length is less than 15 times the least width are to be designed for a working stress of 1,350 lb. per sq. in. The working stress for wooden tension members is given as 1,650 lb. per sq. in. For steel members the working stress is 16,000 lb. per sq. in. All data for the design are given in Table 11.

Sections for wooden compression members should be square, if possible, in order to secure a member of equal rigidity in planes perpendicular to the sides of the members. Single pieces are preferable to members built up of planks placed

side by side and nailed or bolted together to form a single member. The excessive cost of, or difficulty in obtaining single pieces, may decide in favor of the built-up member.

Wooden tension members must contain considerable excess area in order to provide for notching at the joints. Single pieces are preferable for use as tension members. If planks are used, placed side by side to form a built-up member, considerable care must be taken in order to make certain that the proper net area is provided at all points. Further discussion of this detail will be given in connection with the design of the lower chord member.

Design of Top Chord Member.—The design of the top chord member will be determined for the conditions existing in member $a-b$, where the stress is a maximum. From Table 10 the stress in member $a-b$ is 29,800 lb. compression. Assume a 6 × 6-in. member, of which the actual size will be taken as $5\frac{1}{2} \times 5\frac{1}{2}$ in. Since the length of member $a-b$ is 112 in., the ratio $\frac{l}{d} = \frac{112}{5.5} = 20.4$. Therefore the working stress is to be determined by the formula $1,800 \left(1 - \frac{l}{60d}\right)$. For the assumed section the working stress is $1,800 \left(1 - \frac{112}{60 \times 5.5}\right) = 1,800(1 - 0.34) = 1,190$ lb. per sq. in.; and the required area is $\frac{29,800}{1,190} = 25.0$ sq. in. The area provided by the assumed section is $5.5 \times 5.5 = 30.25$ sq. in. The assumed section is ample and it will be adopted.

In trusses of the size under consideration, it is usual to make the entire top chord of the same cross-section. For larger trusses, the section of the upper end of the top chord is sometimes reduced in size. A butt splice is made at one of the panel points. This splice can be designed by the methods given in the section on Splices and Connections—Wooden Members, in the volume on “Structural Members and Connections.”

If the top chord member is to be made of planks, a 2 × 6-in. piece, actual dimensions about $1\frac{5}{8} \times 5\frac{1}{2}$ in., would probably be used in the case under consideration. To provide the proper area, three pieces will be required. For this section, $d = 3 \times 1\frac{5}{8} = 4\frac{7}{8}$ in.; $\frac{l}{d} = 23$; and the allowable working stress is 1,120 lb. per sq. in. The area required is then $\frac{29,800}{1,120} = 26.6$ sq. in., and that provided is $3 \times 1\frac{5}{8} \times 5.5 = 26.8$ sq. in. The section is ample. To hold the several pieces together, bolts about $\frac{1}{2}$ in. in diameter should be placed through the pieces at intervals such that the value of $\frac{l}{d}$ for a single piece will be not greater than the value for the whole member. From the calculation given above, $\frac{l}{d}$ for the whole member is 23. Since d for a single plank is $1\frac{5}{8}$ in., the distance between bolts must be about $(23)(1\frac{5}{8}) = 37.4$ in. Bolts spaced 3 ft. apart will probably be satisfactory.

Design of Compression Web Members.—The compression diagonals $b-f$ and $c-g$ are designed by methods similar to those used for the top chord member. It was found that 4 × 4-in. members, actual size assumed as $3\frac{5}{8} \times 3\frac{5}{8}$ in., are sufficient as far as stress conditions are concerned. It sometimes happens that the size of member as designed must be increased to provide sufficient bearing area for

joint details. The actual sizes as designed are given in Table 11. If changes are required, they will be made in Art. 27 on the design of joints.

Design of Bottom Chord Tension Member.—From Table 10, the maximum stress in the bottom chord occurs in members *a-e-f*, where the stress is 26,670 lb. tension. The net area required for the allowable working stress of 1,650 lb. per sq. in. is $\frac{26,670}{1,650} = 16.2$ sq. in. In general, it will be found that in order to provide for notching at the joints, etc., the adopted section must provide an area about $\frac{2}{3}$ greater than the required net area, or in this case, the adopted section should provide at least $16.2 \times 1\frac{2}{3} = 27$ sq. in. A 6 × 6-in. member, actual size $5\frac{1}{2} \times 5\frac{1}{2}$ in., provides 30.25 sq. in. This section will be adopted, subject to the condition that it must provide the required net area at the joints, a point which will be definitely determined in the following article.

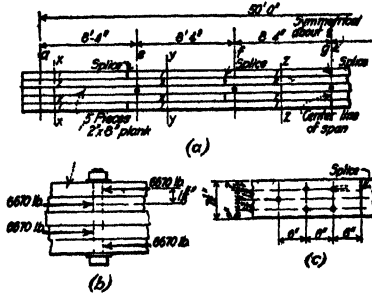

FIG. 27.

The lower chord member for the truss under consideration will now be designed as a built-up section. It will be assumed that 2 × 8-in. plank, actual size $1\frac{5}{8} \times 7\frac{1}{2}$ in., are to be used. Since the rods composing the vertical members pass through the chord section, an odd number of pieces will be provided, and the center piece, which will contain the rods, will not be assumed to carry any of the chord stress. Assume a section consisting of five pieces, placed as shown in Fig. 27.

The splices in the member will be located as shown in Fig. 27; they will be placed about a foot from the panel points. For the arrangement shown, the planks can be ordered in lengths not to exceed 20 ft. It will be noted that in each panel, only two pieces are available at the splices to carry the total tension. The net area of these pieces for the member *a-e-f* must then be $\frac{26,670}{1,650} = 16.2$ sq. in., or 8.10 sq. in. for each plank. Assuming the splices to be made with 1-in. bolts, of which there are two on the same vertical section, as shown in Fig. (c), the net area of a 2 × 8-in. plank is $1\frac{5}{8} (7.5 - 2 \times 1) = 8.95$ sq. in. The assumed section is probably sufficient, as all notching for the joint at *f* can readily be made on the three inside members.

The splices in the member will be located as shown in Fig. 27; they will be placed about a foot from the panel points. For the arrangement shown, the planks can be ordered in lengths not to exceed 20 ft. It will be noted that in each panel, only two pieces are available at the splices to carry the total tension.

The net area of these pieces for the member *a-e-f* must then be $\frac{26,670}{1,650} = 16.2$ sq. in., or 8.10 sq. in. for each plank. Assuming the splices to be made with 1-in. bolts, of which there are two on the same vertical section, as shown in Fig. (c), the net area of a 2 × 8-in. plank is $1\frac{5}{8} (7.5 - 2 \times 1) = 8.95$ sq. in. The assumed section is probably sufficient, as all notching for the joint at *f* can readily be made on the three inside members.

In determining the number, size, and position of the bolts connecting the several planks forming the bottom chord member, due attention must be paid to the transmission of stress across the spliced sections. Thus in Fig. 27(a), the total stress in member *a-e* on the section *x-x*, close to joint *a*, is carried by four planks, assuming that the center plank is inactive, as stated above. Therefore, on section *x-x* each plank has a stress of $\frac{26,670}{4} = 6,670$ lb. At the splice just to the left of joint *e*, all of the load is carried by the planks numbered 2 in Fig. (a). Therefore between the sections *x-x* and joint *e*, the stresses of 6,670 lb. in planks 1 have been transferred to planks 2, which are fully stressed at the splice, as calculated above.

The stress in planks 1 will be transferred to planks 2 by means of 1-in. bolts, as assumed above. The number of bolts required will be determined by the safe

bearing on the end fibers of the wood, and by the safe bending stresses in the bolts. At 1,200 lb. per sq. in., the safe bearing for a $1\frac{1}{2}$ -in. plank on a 1-in. bolt is $1,200 \times 1.625 \times 1 = 1,950$ lb. The number required for bearing is then $\frac{6,670}{1,950} = 3.42$, or four bolts. Assuming the loading conditions on the bolts to be as shown in Fig. (b), the total moment to be carried by the bolts is $6,670 \times 1.625 = 10,820$ in.-lb. From the tables of safe bending moments on bolts for a fiber stress of 24,000 lb. per sq. in., the allowable bending moment on a 1-in. bolt is 2,360 in.-lb. Therefore, $\frac{10,820}{2,360} = 4.6$, or five bolts are required for bending moment.

These bolts are shown in position in Fig. 27(c).

The distance from the centers of the bolts to the edge of the splice is determined by the required strength in shearing on the dotted lines shown in Fig. (c). Since five bolts are to be used, the load on each bolt is $\frac{6,670}{5} = 1,335$ lb. From Art. 23, the shearing value of hemlock parallel to the grain is 240 lb. per sq. in. The required distance from the center of the bolt to the edge of the plank is then $\frac{1,335}{2 \times 1.625 \times 240} = 1.72$ in. The arrangement shown in Fig. 27(c) is convenient, and will be adopted.

At the right of the splice at joint *e*, an arrangement of bolts similar to that described above must also be used, for the stress in planks 2 must be transferred to planks 1 because of the splice in planks 2 at joint *f*. As the calculations are similar to those given above, they will not be repeated.

In the panel *f-g*, similar calculations must also be made. As the stresses are smaller than those in the end panels, four bolts will be found sufficient. At points between the splices, the planks are to be held together by $\frac{1}{2}$ -in. bolts placed about 2-ft. centers.

Design of Vertical Tension Rods.—The vertical tension members will be made of round rods threaded at the ends and provided with square nuts. As shown in Table 11, the plain $\frac{3}{4}$ -in. diameter round rod provides some excess area for member *c-f*. Since this is about the smallest advisable size of rod for such members, it will be used. It is to be remembered that the area of the rod at the root of thread governs the design.

Although member *b-e* has no definite stress, a $\frac{3}{4}$ -in. rod will be used.

For member *d-g* an area of 0.665 sq. in. at root of thread is required. A plain rod $1\frac{1}{8}$ in. in diameter will furnish the required area. It will probably be better practice to use a rod of smaller diameter with an upset end. From the tables of upset ends for round rods, it will be found that a 1-in. rod with a $1\frac{3}{8}$ -in. upset end is required.

27. Design of Joints.—A great variety of joint details are in use for wooden roof trusses. The general principles governing the design of joints have been given in the chapter on Roof Trusses—General Design, where typical joint details are shown. In the present article, the design methods will be given for some of the details in common use, particular attention being paid to details suitable for the type of truss under consideration.

The general principles of joint design given in the chapter on the Detailed Design of a Steel Roof Truss apply also to a wooden roof truss. Center lines of

members must be made to intersect in a common point. If this cannot be done, the additional stresses in the members due to the eccentric connections must be calculated and proper provision made for them.

TABLE 11.—DESIGN OF MEMBERS

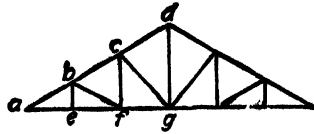

Member	Max. stress (lb.)	Length of member (in.)	Least width (in.)	L/D	Working stress (lb./in. ²)	Area required (sq. in.)	Section	Area provided (sq. in.)
ab	-29,800	112	5½	20.4	1,190	25 0	6 × 6 in.	30.25
bc	-23,800	6 × 6 in.	
cd	-17,820	6 × 6 in.	
ae-f	+26,670	1,650	16.2	6 × 6 in.	30.25
fg	+21,300	1,650	12.9	6 × 6 in.	30.25
bf	- 6,510	112	3¾	31.0	875	7.45	4 × 4 in.	13.15
cg	- 8,210	141	3¾	35.3	630	13 0	4 × 4 in.	13 15
cf	+ 2,990	16,000	0.187	¾-in. round rod	0.302
dg	+10,640	16,000	0.665	1-in. round rod up-set to 1¾ in.	1.05
be	0	0	¾-in. round rod	0.302

+ = tension.

- = compression.

In designing the joint details, the stresses transmitted from one member to another must be carefully determined and the bearing areas between the members proportioned to provide for the stresses to be carried. In general, simple details are desirable, and the joints should be made up with as few parts as possible. Indirect connections, and those in which the distribution of the stress to several parts is indeterminate, should be avoided. Where the stresses are small, one member can be notched into another to form the joint details. Where very large stresses are to be transmitted from one member to another, metal bearing plates or castings, side plates, or bolted connections are required. The general principles for the design of splices and similar connections are given in the section on Splices and Connections—Wooden Members, in the volume on "Structural Members and Connections."

Design of Joint b.—As the stress to be transmitted from member b-f to the top chord member is comparatively small, a notch detail of the form shown in Fig. 28 will be used. In order to make certain that the resultant pressures on the faces 1-2 and 2-3 intersect on the center line of the member at point 4, the notch will be made with faces at 90 deg., as shown in Fig. 28. In this way a central connection is made and eccentric moments are eliminated.

Assume a notch $1\frac{1}{4}$ in. deep on face 1-2. The dimensions and form of the resulting notch are shown in Fig. 28. These dimensions were scaled from a large scale layout of the joint. In making the layout, the actual dimensions of the members were used.

Resolving the stress in member *b-f* into its components perpendicular to the faces of the notch by means of a force diagram, the forces to be carried are as shown in Fig. 28. Since these loads act at an angle to the grain of the material, the strength of the notch depends upon the allowable bearing values on these surfaces, as determined by the formula of Art. 23, for which the conditions are shown in Fig. 24. The angles which the surfaces 1-2 and 2-3 make with the grain of the material of the chord member and of member *b-f* are as shown in Fig. 28. These angles were measured with a protractor from a large scale layout of the joint. Angles were read to the nearest half degree.

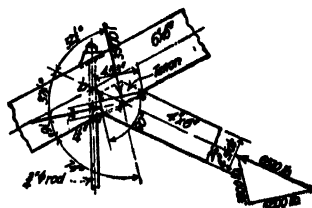

FIG. 28.

The allowable bearing values as calculated from the formula of Art. 23 are as follows:

Chord member:

$$\text{surface 1-2, } 330 + 0.1815(74)^2 = 1,330 \text{ lb. per sq. in.}$$

$$\text{surface 2-3, } 330 + 0.1815(16)^2 = 375 \text{ lb. per sq. in.}$$

Member *b-f*:

$$\text{surface 1-2, } 330 + 0.1815(52.5)^2 = 850 \text{ lb. per sq. in.}$$

$$\text{surface 2-3, } 330 + 0.1815(37.5)^2 = 585 \text{ lb. per sq. in.}$$

For these allowable bearing values, the areas required are as follows:

Chord member:

$$\text{surface 1-2, } \frac{5,200}{1,330} = 3.90 \text{ sq. in.}$$

$$\text{surface 2-3, } \frac{3,900}{375} = 10.4 \text{ sq. in.}$$

Member *b-f*:

$$\text{surface 1-2, } \frac{5,200}{850} = 6.12 \text{ sq. in.}$$

$$\text{surface 2-3, } \frac{3,900}{585} = 6.67 \text{ sq. in.}$$

These calculations show that the required areas are 6.12 sq. in. for surface 1-2, and 10.4 sq. in. for surface 2-3.

As the notch 1-2 is assumed to be $1\frac{1}{4}$ in. deep, the width required on this surface is $\frac{6.12}{1.25} = 4.90$ in. From the design given in Art. 26, a 4×4 -in.

member is sufficient for member *b-f* as far as the column design is concerned. This member, however, does not provide the required width on surface 1-2, as given by the above calculations. The required area can be provided by one of two methods; either the notch can be made deeper, or the member can be made wider. As designed in Art. 26, the chord member is 6 in. wide and member *b-f* is 4 in. wide. It is therefore possible to increase the width of member *b-f*. In this case it does not seem advisable to make the notch deeper than assumed,

because the excess area provided by the section adopted does not allow much cutting. The required area will be provided by increasing member $b-f$ to a 4×6 -in. section, actual size assumed as $3\frac{5}{8} \times 5\frac{1}{2}$ in., placed with the 4-in. side in the plane of the truss, as shown in Fig. 28. The area provided on surface 1-2 is then $5.5 \times 1.25 = 6.875$ sq. in., which is satisfactory.

In order to prevent member $b-f$ from slipping out of place due to shrinkage of the parts, it is best to provide a tenon projecting from the surface 2-3 into a slot in the chord member, as shown in Fig. 28. This tenon should be about 1 in. thick, and the slot in the chord member which receives the tenon should be about $1\frac{1}{8}$ in. wide. The net width of the surface 2-3 is then $5.5 - 1.125 = 4.375$ in. From Fig. 28, the length of the surface 2-3 is 4.53 in. The area provided is then $4.53 \times 4.375 = 19.8$ sq. in. From the calculations given above, an area of 10.4 sq. in. is required. The detail is satisfactory and will be adopted.

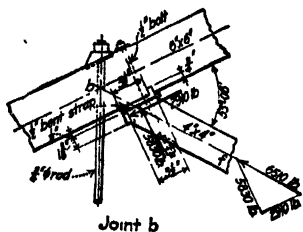

FIG. 29.

Figure 29 shows another arrangement for joint b . A S-shaped bent steel plate has one of its legs notched into the chord member, while the other leg forms a projection against which the member $b-f$ bears. The depth of the projection 1-2 is determined by the allowable bearing on this surface, which, from the formula of Art. 23, is $330 + 0.1815(36.8)^2 = 575$ lb. per sq. in. Resolving the stress in $b-f$ into components parallel and perpendicular to the chord member, the loads shown in the force diagram are obtained. Therefore, the area required on surface 1-2 = $\frac{2,910}{575} = 4.98$ sq. in. If $b-f$ be taken as a 4×4 -in. member (actual size $3\frac{5}{8}$ in. square), the required distance 1-2 = $\frac{4.98}{3.625} = 1.378 = 1\frac{3}{8}$ in.

The thickness of the plate is determined by its strength as a cantilever beam of length $1\frac{3}{8}$ in. The plate will be made the full width of the chord member, which is $5\frac{1}{2}$ in. wide. Assuming the pressure to be concentrated at the center of the surface 1-2, the moment is $\frac{1}{2} \times 2,910 \times (1\frac{3}{8} + \frac{1}{2}) = 2,730$ in.-lb., and the thickness required for a working stress of 16,000 lb. per sq. in. is $d = \left(\frac{6M}{fb}\right)^{\frac{1}{2}} = \left(\frac{6 \times 2,730}{16,000 \times 5.5}\right)^{\frac{1}{2}} = 0.431$ in. A $\frac{1}{2}$ -in. plate will be used.

From the formula of Art. 23, the allowable bearing pressure for the 4×4 -in. member on the surface 2-3 is $330 + 0.1815(53.2)^2 = 840$ lb. per sq. in. The bearing area required between the 4×4 -in. member and the under side of the plate is $\frac{5,830}{840} = 6.95$ sq. in. On the upper surface of the plate, the bearing is directly on the side of the chord member, and the allowable bearing is 330 lb. per sq. in. The bearing area required on the lower face of the chord member is $\frac{5,830}{330} = 17.7$ sq. in. From a large scale layout of the joint, the dimensions were found to be as shown in Fig. 29. The bearing area provided between the 4×4 -in. member and the plate is then $3\frac{1}{2} \times 3\frac{5}{8} = 12.7$ sq. in., and the area provided between the chord member and the plate is $5.5 \times 3.5 = 19.2$ sq. in., as the plate is assumed to cover the full width of the chord member.

The component of thrust parallel to the chord member is taken up by notching into the chord member. As the bearing is on the end fibers of the material, the allowable bearing is 1,800 lb. per sq. in., and the area required is $\frac{2,910}{1,800} = 1.62$ sq. in. The depth of the notch required is $\frac{1.62}{5.5} = 0.294$ in. A $\frac{3}{4}$ -in. notch will be used, for a shallower notch is not effective.

The bent plate is kept in contact with the chord member and with member b-f by means of lag screws, or by means of a bolt passing through the members. Figure 29 shows the adopted detail.

Figure 30 shows a detail for joint b which makes use of a cast-iron angle block. This block is notched into the top chord by means of a lug cast on the angle block. Member b-f bears directly on the end of the angle block. In order to save material, and also to reduce the weight of the angle block, it will be made up of two bearing surfaces, 1-2 and 3-4, connected by a cast web.

The design of an angle block of the form shown in Fig. 30 consists in the determination of the size of the lug which notches into the top chord, and the thickness required for the cantilever beams forming the bearing surfaces 1-2 and 3-4. The force diagram shows the components of load parallel and perpendicular to the top chord member.

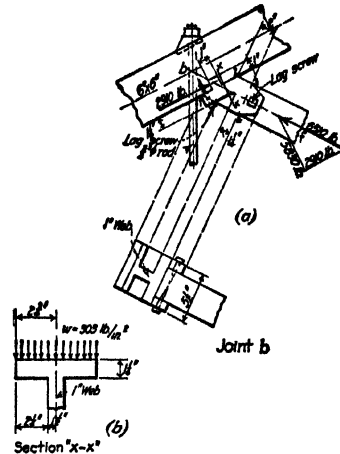

FIG. 30.

The depth of the lug must be sufficient to transfer to the end fibers of the top chord member a stress of 2,910, as shown by the force diagram. As the allowable bearing on the end fibers of the material is 1,800 lb. per sq. in., and the width of the chord member is $5\frac{1}{2}$ in., the depth of notch required is only $\frac{2,910}{1,800 \times 5.5} = 0.294$ in. As the required notch is too shallow to be effective, a 1-in. notch will be used. The width of the lug is determined by its strength as a cantilever beam under a moment of $2,910 \times 0.5 = 1,455$ in.-lb. If the working stress for cast iron is taken as 3,000 lb. per sq. in., the width required is $\left(\frac{6 M}{bf}\right)^{\frac{1}{2}} = \left(\frac{6 \times 1,455}{5.5 \times 3,000}\right)^{\frac{1}{2}} = 0.727$ in. A width of 1 in. will be adopted. The details of the lug are as shown in Fig. 30.

The area required on the surface 1-2 is determined by the bearing strength of the timber across the fibers, which is 330 lb. per sq. in. From the force diagram, the load to be transmitted to the chord member is 5,830 lb. The area required is then $\frac{5,830}{330} = 17.7$ sq. in. If it be assumed that the top surface of the lug does not carry compression due to imperfect workmanship, the area provided on surface 1-2 is $(4.5 - 1.0) 5.5 = 19.3$ sq. in., which is ample.

The thickness of the upper bearing surface is determined by the necessary thickness when considered as a cantilever beam. Figure (b) shows a vertical

section $x-x$ of Fig. (a). This beam is subjected to a pressure of $\frac{5,830}{19.3} = 303$ lb. per sq. in., acting as shown in Fig. (b). For the conditions shown, the bending moment in a strip of beam 1 in. wide is $\frac{1}{2} \times 303 \times 2.25^2 = 765$ in.-lb. at the edge of the vertical web. For an allowable bending stress of 3,000 lb. per sq. in. for cast iron, the required thickness is $\left(\frac{6M}{bf}\right)^{\frac{1}{2}} = \left(6 \times \frac{765}{3,000}\right)^{\frac{1}{2}} = 1.24$ in. The section will be made $1\frac{1}{4}$ in. thick.

By a similar process it will be found that the thickness of the bearing surface 3-4 can also be made $1\frac{1}{4}$ in. thick. The angle block will be fastened to the chord member by means of lag screws. To hold the member $b-f$ in place, side pieces will be cast on the lower bearing surface. Lag screws through the projections thus formed will hold the member rigidly in position. All details are shown in Fig. 30.

Member $b-e$, the vertical tension rod, passes through the chord member and bears on the chord by means of a cast washer. As member $b-e$ has no definite stress, a washer similar to the one designed for joint c will be used. Figure 31(c) shows the details of the washer.

Design of Joint c.—Figure 31 shows two designs for joint c . The design methods are similar

to those used for joint b . Figure (a) shows a joint made by notching, and Fig. (b) shows an angle block design. Due to the angle between member $c-g$ and the top chord member, a solid block was used in this case.

The vertical rod $c-f$ transmits to the upper chord its stress of 2,990 lb. This load is brought to the top of the chord member by a washer. In this case a cast angle washer will be used, as shown in Fig. 31(c). The design of this washer consists in providing a base area sufficient to transmit to the top fibers of the chord member, a stress of 2,680 lb., the component of stress perpendicular to the chord member, and in providing an area at the toe of the washer which will provide for a load of 1,340 lb., the component of stress parallel to the chord member.

As stated in Art. 23, the bearing under washers which bear perpendicular to the grain is 412.5 lb. per sq. in. The area required on surface 1-2 of Fig. (c) is then $\frac{2,680}{412.5} = 6.5$ sq. in. Since the rod composing member $c-f$ is $\frac{3}{4}$ in. in diameter, the hole in the washer should be about 1 in. in diameter. As the hole in the base of the washer is elliptical in form, the area will be taken as 1.5 sq. in. The required gross area of the base is then $6.5 + 1.5 = 8.0$ sq. in. A 3 × 3-in. base will be used.

To resist the component of load parallel to the chord member, the washer will be set into the chord member. As the allowable end bearing on the fibers is 1,800 lb. per sq. in., and as the washer is 3 in. wide, the indentation must be at least $\frac{1,340}{1,800 \times 3} = 0.25$ in., A $\frac{1}{2}$ -in. indentation will be used, as shown in Fig. (c).

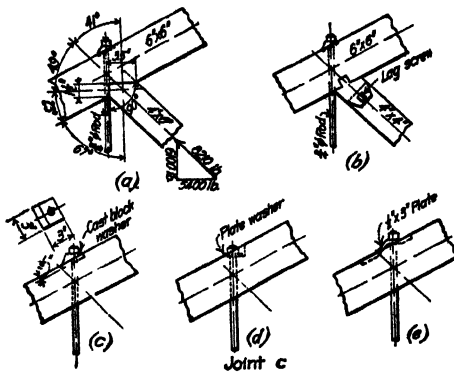

FIG. 31.

Other forms of washer details in common use for sloping chords are shown in Figs. (d) and (e). In the form shown in Fig. (d), the top chord is notched to form a horizontal surface. A round or square washer is then used whose base area is determined for the allowable bearing, as calculated from the formula of Art. 23. Figure (e) shows a bent plate washer. The design of this detail is similar to the one shown in Fig. (c).

Design of Joint d.—Joint *d*, the apex joint, is a butt joint in which the members intersect at an angle. The design of this joint consists in providing the proper area between the abutting surfaces, and the provision of proper bearing under the washer on the vertical member *d-g*. Rigid fastenings are to be provided in order to hold the members in line.

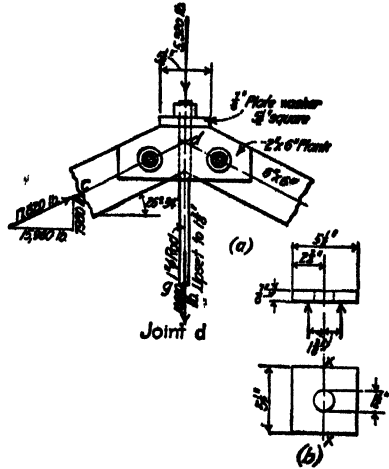

FIG. 32.

Figure 32 shows a detail of the apex joint in which the top chord members from the two sides of the truss butt against each other on a vertical line and against a plate washer on the end of member *d-g*, the vertical rod. The maximum stress in member *c-d* is 17,820 lb., as given in Table 10. This stress is due to the vertical loading of 40 lb. per sq. ft. of covered area, for which the panel load is 5,320 lb. The stresses in all members, and the panel load, are shown in position.

The details of the joint depend on the method of supporting the purlin at this point. If the purlin is set on the top of the washer, the bearing area on the under side of the washer must be determined for the vertical components of the stresses in the chord members. From the force diagram, the load to be carried is $2 \times 7,980 = 15,960$ lb. If a detail of the form shown in Fig. 43 (b) is adopted, where the purlin load is distributed equally to the two chord members, the load to be provided for on the under side of washer is $15,960 - 5,320 = 10,640$ lb., which is equal to the stress in the vertical rod. The latter detail will be adopted in this case, as shown on the general drawing, Fig. 44.

From the formula of Art. 23, the allowable bearing on the under side of the washer is $330 + 0.1815 (26.5)^2 = 460$ lb. per sq. in., and that on the vertical bearing surface is $330 + 0.1815(63.5)^2 = 1,060$ lb. per sq. in. The area required on the under side of the washer is then $\frac{10,640}{460} = 23.1$ sq. in., and on the vertical bearing surface the area required is $\frac{15,960}{1,060} = 15.1$ sq. in. Assuming the plate washer to cover the full width of the chord member, the length required is $\frac{23.1}{5.5} = 4.2$ in. To allow for the area taken out for the vertical rod, a $5\frac{1}{2}$ -in. square steel plate will be used, as shown in Fig. 32 (a). If the horizontal bearing area for each chord member is made $2\frac{3}{4}$ in., a layout of the joint will show that the vertical bearing surface is about $4\frac{3}{4}$ in. The area provided on the vertical bearing surface is then $4.75 \times 5.5 = 26.13$ sq. in., which is more than required.

The thickness of the plate washer will be determined on the assumption that it forms a double cantilever beam. Figure (b) shows the assumed distribution of loading, which is approximate but accurate enough under the conditions. The moment to be carried on section $x-x$ is $5,320 \times 1.375 = 7,315$ in.-lb. For an assumed working stress of 16,000 lb. per sq. in., the thickness required is $d = \left(\frac{6M}{bf}\right)^{1/2} = \left(\frac{6 \times 7,315}{4 \times 16,000}\right)^{1/2} = 0.83$ in. A $\frac{7}{8}$ -in. plate will be used. As shown in Fig. (b), a $1\frac{1}{2}$ -in. hole is provided in the washer for the vertical member, which leaves a net width on section $x-x$ of $b = 5.5 - 1.5 = 4.0$ in.

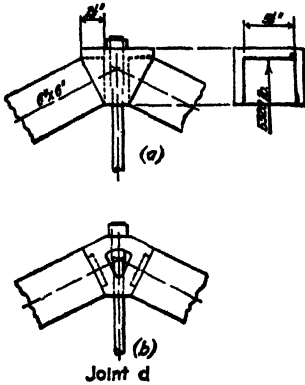

FIG. 33.

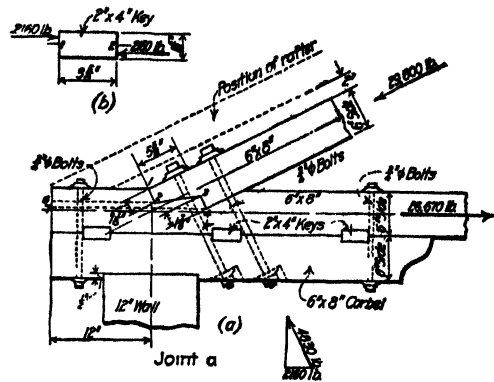

FIG. 34.

To hold the chord members in place, short pieces of 2×6 -in. plank are fastened to the faces of the chord members by means of $\frac{3}{4}$ -in. bolts. These pieces do not carry any definite stress.

Figure 33 shows two forms of cast-iron block details for the joint at point d . In the design of Fig. 33(a), the bearing surfaces required are determined by the same methods as used in the design of Fig. 32. The required thickness of metal can be determined by considering the upper surface to be a fixed ended beam supported by the side surfaces. The details shown in Fig. 33 are more expensive than the ones shown in Fig. 32. It is doubtful if the added expense is worth while, for the detail of Fig. 32 is simple, effective, and inexpensive.

Design of Joint a.—The design of the joint at a , the heel of the truss, requires careful consideration. At this point the stresses to be provided for are greater than at any other point in the truss. In general the members meet at an acute angle, which adds to the difficulties encountered in the design. Designs will be worked out in detail for a joint formed by notching one member into the other; for one formed by a bent strap with lugs; for a joint consisting of steel side plates; and for a cast-iron shoe.

Figure 34 shows an arrangement for a joint at point a formed by notching the top chord member into the lower chord member. The notch is so arranged that the surfaces 1-2 and 3-4 provide equal areas. The connection formed between the members is central and no eccentric moments are to be provided for.

It can be seen from Fig. 34 that the bearing value at the notches is governed by the allowable values for the horizontal member. From the formula of Art. 33,

the allowable bearing is $330 + 0.1815 (63.5)^2 = 1,060$ lb. per sq. in. Hence the total area to be provided on surfaces 1-2 and 3-4 is $\frac{29,800}{1,060} = 28.1$ sq. in. If the notches are made $1\frac{1}{8}$ in. deep, as shown in Fig. 34, the width of bearing required is $\frac{1}{2} \times \frac{28.1}{1.875} = 7.5$ in. From Table 11, the stress in member *a-b* calls for a 6×6 -in. piece, of which the actual width is $5\frac{1}{2}$ in. Since it is not advisable, and in fact impossible in this case to make the notches deeper because of the reduction in the available net area of the lower chord section, the members must be made wider if this form of joint is to be used. The calculations above show that a 6×8 -in. member, actual width $7\frac{1}{2}$ in., must be used for both the top and bottom chord members. This change will be made and the other details of the design will be worked out.

The net area of the lower chord member must now be checked up. As shown in Fig. 34, the weakest section is on a vertical section through point 4, where the net area provided is $7.5 \times 3 = 22.5$ sq. in. From Table 11 the net area required for member *a-e* is 16.2 sq. in. The area furnished is therefore ample, provided no further cutting is required.

The loads brought to the surfaces 1-2 and 3-4 must be resisted by the shearing resistance offered by the surfaces 2-6 and 4-7. The shearing resistance developed must be equal to the horizontal component of the stress in the top chord member, which is 26,670 lb., as shown by the force diagram. Assuming that surface 2-6 carries one half of this load, the length required on surface 2-6 is $\frac{26,670}{2 \times 240 \times 7.5} = 7.4$, when the shearing working stress is 240 lb. per sq. in., as given in Art. 23. Surface 4-7 is below surface 2-6 so that it can be counted upon to act as shear resisting area. To provide some excess area due to possible defects in the material, the bottom chord member will be extended 12 in. beyond the intersection of center lines, as shown in Fig. 34. A layout of the joint will show that the lower chord member will not project outside the roof line if the purlin is placed with its lower surface on the same level as the under side of the top chord member.

The top chord member will be held in place on the lower chord member by means of bolts passing through the members, as shown in Fig. 34. These bolts do not carry any definite stress, as they serve only to hold the parts together. Two $\frac{3}{4}$ -in. bolts will be used, located as shown in Fig. 34. In order to avoid further cutting of the lower chord member to provide seats for the washers at the lower ends of the $\frac{3}{4}$ -in. bolts, a 6×8 -in. timber, known as a corbel, will be bolted to the under side of the chord member, as shown in Fig. 34.

Although the $\frac{3}{4}$ -in. bolts do not carry any definite stress, it is usual to assume that the probable maximum stress in the bolt is equal to its full net strength in tension. Washer details and bearing areas are then determined for this load. As the area at the root of thread for a $\frac{3}{4}$ -in. bolt is 0.302 sq. in., the probable maximum bolt stress is $16,000 \times 0.302 = 4,830$ lb. For the conditions shown in Fig. 34, the allowable bearing value under the washers is governed by the conditions under the corbel. From the formula of Art. 23, the allowable bearing value is $330 + 0.1815 (26.5)^2 = 460$ lb. per sq. in. As stated in Art. 23, this may be increased for washers which cover only a part of the area of the bearing surface. The bear-

ing area required is then $\frac{4,830}{460 \times 1.25} = 8.4$ sq. in. From a table of Standard Cast Washers, it will be found that the standard washer for a $\frac{3}{4}$ -in. bolt provides a bearing area of about 7.9 sq. in. Under the conditions, a standard washer will be used, although the area provided is somewhat deficient. If the discrepancy in area is greater than for the case under consideration, it will be best to design a special steel plate washer similar to those used at joints *d*, *f*, and *g*.

Since the probable bolt stresses are inclined to the axis of the corbel, keys or wedges must be inserted between the lower chord member and the corbel to prevent any movement of the parts. If three wooden keys are provided, as shown in Fig. 34, each key must take one-third of the horizontal component of the total stress in the bolts. From a force diagram, the horizontal component of the stress in the bolts is found to be $2 \times 2,160 = 4,320$ lb. In addition to this load, the keys must also provide for the horizontal component of the reaction due to wind. From the coefficients for wind load reactions given in the chapter on Roof Trusses—Stress Data, in the volume on "Stresses in Framed Structures," the maximum horizontal force to be provided for is $2.06 \times 2,220 \times \sin 26^\circ 34' = 2,050$ lb. The total to be carried by the keys is then $4,320 + 2,050 = 6,550$ lb.

A 2×4 -in. key, actual size $1\frac{1}{8} \times 3\frac{3}{8}$ in., will be assumed. Figure (b) shows the conditions for which the key is to be designed. The area required for bearing against the side fibers of each key is $\frac{1}{3} \times \frac{6,550}{412.5} = 5.28$ sq. in., assuming

a working stress as for bearing under washers. The area provided by the assumed key is $\frac{1}{3} \times 1.625 \times 7.5 = 6.08$ sq. in., which is sufficient. The length of the key is determined by the area required to develop a shearing resistance equal to one-third of the total horizontal force to be carried, which is $\frac{1}{3} \times 6,550 = 2,183$ lb. As given in Art. 23, the allowable shearing stress transverse to the grain is 150 lb. per sq. in. The area required for each key is then $\frac{2,183}{150} = 14.5$

sq. in. As shown in Fig. (b) the area provided by a key on the surface 1-2 is $3.625 \times 7.5 = 27.2$ sq. in. The assumed key is satisfactory. To prevent the key from twisting, due to the eccentric application of the forces, a $\frac{3}{4}$ -in. bolt will be placed close to each key, as shown in Fig. (a).

The bearing area provided between the masonry wall and the corbel is determined by the allowable bearing on the masonry, which is given in Art. 23 as 300 lb. per sq. in. From Art. 25 it will be found that the reactions at the wall are as follows: dead load, 5,500 lb.; snow load, 8,940 lb.; wind load, vertical component 4,100 lb., horizontal component 2,050 lb. The resulting reactions are then: (a) dead load, minimum snow load, and maximum wind load, vertical component 14,070 lb., horizontal component 2,050 lb.; (b) dead load, maximum snow load, and minimum wind load, vertical component 14,810 lb., horizontal component 700 lb.; and (c) reaction due to a vertical load of 40 lb. per sq. ft. of covered area, 15,960 lb. Case (c) therefore determines the required bearing area, which is $\frac{15,960}{300} = 53.3$ sq. in. If a 12-in. wall is assumed, the arrangement shown

in Fig. 34 provides a bearing area of $12 \times 7.5 = 90$ sq. in., which is greater than required. To prevent horizontal movement on the wall, the corbel will be notched over the wall, as shown in Fig. 34. The area required in bearing against the wall is $\frac{2,050}{300} = 6.83$ sq. in. A 1-in. notch will provide 7.5 sq. in.

Figure 35 shows a design made up for a bent strap with a lug notched into the lower chord. It will be assumed that all of the stress in the top chord member is transferred to the lower chord member by means of the bent strap. The bolts serve only to hold the parts together.

The bearing areas on surfaces 1-2 and 2-3 must be large enough to provide for the components of forces shown in the force diagram. From the formula of Art. 23, the allowable bearing value on the surface 1-2 is 1,060 lb. per sq. in., and that on surface 2-3 is 460 lb. per sq. in. Since the fibers at the end of the top chord member are confined by the bent strap, which tends to increase the allowable bearing value, it seems reasonable to allow an increase of 25 per cent in the working value given above. The bearing areas required are: surface 1-2,

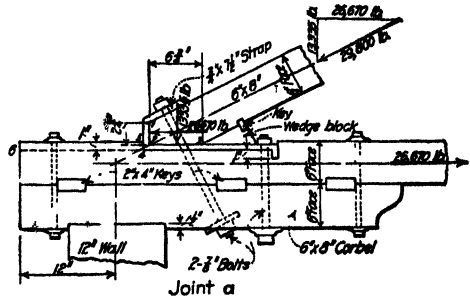

FIG. 35.

$\frac{26,700}{1,060 \times 1.25} = 20.1$ sq. in.; and surface 2-3, $\frac{13,335}{460 \times 1.25} = 23.2$ sq. in. Since the under side of the bent strap bears directly on the side fibers of the lower chord member, the allowable bearing is 330 lb. per sq. in. If this be increased 25 per cent, as assumed above, the area required is $\frac{13,335}{330} \times 1.25 = 32.4$ sq. in.

In order to secure a notch of reasonable depth on line 1-2 of Fig. 35, it will be found necessary to increase the width of the chord members to 8 in., as in the case of the design of Fig. 34. A notch $2\frac{3}{4}$ in. deep will provide an area of $2.75 \times 7.5 = 20.6$ sq. in., which slightly exceeds the required area. On surface 2-3, an area of $6.75 \times 7.5 = 50.6$ sq. in. is provided, which exceeds the area required.

The strap must be set into the chord member to a depth which will provide for the horizontal component of 26,670 lb. in bearing on the end fibers of the material. Assuming that one-half of the load is taken at the front end of the strap detail, and that the other half is taken by a lug at the rear end, the depth of notch required at each place is $\frac{26,670}{2 \times 1,800 \times 7.5} = 0.988$ in. A 1-in. notch will be used, as shown in Fig. 35.

The thickness of the strap is determined by the conditions at the lug on the rear end. Considering the lug to be a cantilever beam which carries half of the horizontal component of the stress in the top chord member, and assuming that the thickness of the strap is $\frac{3}{4}$ in., the bending moment to be carried by the strap is $\frac{1}{2} \times 13,335 (1.0 + 0.75) = 11,700$ in.-lb. This moment occurs on a vertical section at the point where the lug joins the horizontal portion of the strap. Assuming that the strap is made of steel for which the allowable working stress is 16,000 lb. per sq. in., the required thickness is $\left(\frac{6M}{bf}\right)^{\frac{1}{2}} = \left(\frac{6 \times 11,700}{7.5 \times 16,000}\right)^{\frac{1}{2}} = 0.765$ in. A $\frac{3}{4}$ -in. strap $7\frac{1}{2}$ in. wide will be used, arranged as shown in Fig. 35. It is necessary also to make certain that the net area of the strap is sufficient to act as a tension member. As the tension area required is $\frac{13,335}{16,000} = 0.835$ sq. in., the strap furnishes excess area.

To hold the strap in place on the end of the top chord member, two $\frac{3}{8}$ -in. bolts, placed about 4 in. center to center, will be used. These bolts do not carry any definite stress, but experience has shown that the joint, to be effective, must have all of its parts held securely in position. Bolts of the size adopted will be found to be ample for trusses of the size under consideration.

The strap will be held in place on the lower chord member, partly by means of a block keyed in place, and partly by means of vertical bolts placed close to the face of the lug, as shown in Fig. 35. An exact determination of the stress in these

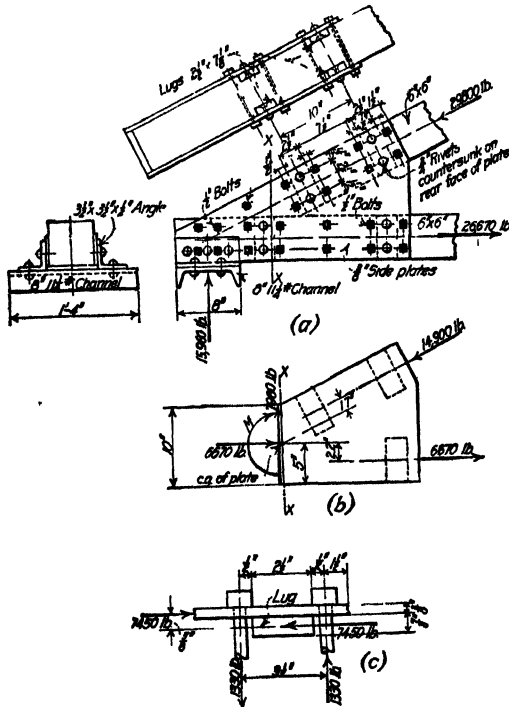

FIG. 36.

bolts can not be made. By assuming that the moment of the stress in the bolt taken about the edge of the wedge block is equal to the moment on the lug considered as a cantilever, an approximate determination of the bolt stress can be made. On this assumption the moment of the bolt stress is 11,700 in.-lb., as calculated above. By scale from Fig. 35 the lever arm of the bolt stress about the edge of the wedge block is 1 in. The stress in the bolt is then about 11,700 lb. At 16,000 lb. per sq. in., an area of $\frac{11,700}{16,000} = 0.73$ sq. in. is required. Two $\frac{3}{8}$ -in. bolts will furnish the required area.

The length required on the surface 4-6 to resist in shear the load brought to surface 4-5, and all details of the corbel and keys, are calculated by the methods given for the design of Fig. 34. All details of the adopted design are shown in Fig. 35.

Figure 36 shows a detail for joint *a* made up of structural steel plates and shapes. In this design the stresses in the top and bottom chord members are transferred to steel side plates by means of lugs riveted to the plates. The load is transferred from the side plates to the masonry walls by a shoe composed of angles riveted to a short piece of rolled channel. A detail of the form shown in Fig. 36 is especially useful for trusses in which the distance from the intersection point of the center lines of members and the end of the truss is limited, as, for example, in structures in which the walls are built up above the lower chord of the trusses. A long overhanging end detail of the form shown in Figs. 34 or 35 could not be used in such cases, for the end of the truss would project through the walls.

As shown in Fig. 36 (*a*), the stress in the top chord member is transferred to the side plates by means of four lugs. The load on each lug is then $\frac{29,800}{4} = 7,450$ lb. Since the allowable bearing pressure on the end fibers of the material is 1,800 lb. per sq. in. and since the chord member is 5.5 in. wide, the depth of notch required is $\frac{7,450}{1,800} \times 5.5 = 0.753$ in. A $\frac{3}{8}$ -in. lug will be used. As the amount of cutting to provide notches on the chord members is small, the 6 × 6-in. section designed in Table 11 can be used.

The lugs will be fastened to the side plates by rivets $\frac{3}{4}$ in. in diameter. From tables of rivet values, the value of a $\frac{3}{4}$ -in. rivet in single shear is 6,630 lb. Hence, $\frac{7,450}{6,630} = 2$ rivets are required in each lug, as shown in Fig. (*a*). In order to provide room for these rivets, the lugs will be made $2\frac{1}{2}$ in. wide.

The distance between the lugs on the top chord member is determined by the shearing area required to resist the load on the lugs. Since the load to be carried by each lug is 7,450 lb., and since the allowable shear is 240 lb. per sq. in., the area required between lugs is $\frac{7,450}{240} = 31.0$ sq. in. As the top chord member is $5\frac{1}{2}$ in. deep, the distance between the lugs must be $\frac{31.0}{5.5} = 5.64$ in. To allow for inequalities in material and uneven bearing on the lugs, the clear distance between lugs will be made $7\frac{1}{2}$ in., as shown in Fig. (*a*). As the top chord member is in compression, the shear area must be provided to the right of the lug, or toward the apex of the truss. For the lower chord member, which is in tension, the shear area must be provided to the left of the lug—that is, between the end of the truss and the lug. The arrangement of lugs shown on Fig. (*a*) for the lower chord member provides more shear area between the lugs than is required to carry the loads. The lugs are placed as shown in order to bind the plates firmly to the chord member.

The thickness of the side plates is determined either by the limiting slenderness ratio required as a compression member at the lower end of the top chord member, or by the section required to resist the bending stresses due to the applied loads. From Fig. 36 (*a*), the maximum unsupported length of plate at the top chord member is about 8 in. If $\frac{l}{r}$ is limited to 125, the minimum allowable $r = \frac{8}{125} = 0.064$ in. For a rectangle $r = 0.289d$. Therefore, $d = \frac{0.064}{0.289} = 0.22$

in. Since it will be necessary to countersink some of the rivets in the rear face of the plate, in order to secure a smooth face, a plate at least $\frac{3}{8}$ in. thick must be used, as shown by the dimensions of countersunk rivet heads.

Figure 36 (b) shows the forces acting on one of the side plates at a section where the depth of plate is 10 in. The forces shown on section $x-x$ represent the internal stresses. These forces are a shear of 7,980 lb., a thrust of 6,670 lb., and a bending moment about the center of gravity of the section of $14,900 \times 1.7 + 6,670 \times 2.2 = 50,000$ in.-lb. The extreme fiber stress, which is compressive, occurs at the upper edge of the plate. The fiber stress is to be calculated from the formula for bending and direct stress, or $f = \frac{P}{A} + \frac{Mc}{I} = \frac{6,670}{10 \times 0.375} + \frac{6 \times 50,000}{0.375 \times 10^2} = 1,780 + 8,000 = 9,780$ lb. per sq. in. The effect of shear can be neglected, as in the case of ordinary beam design. Other sections were investigated, but fiber stress at section $x-x$ was found to be a maximum. Since the fiber stress found above is well within allowable limits, the $\frac{3}{8}$ -in. plate will be adopted.

The side plates are held in place against the chord members by means of bolts placed as shown in Fig. (a). Figure (c) shows the forces acting on one of the lugs at the compression chord. These forces tend to cause a clockwise rotation of the lug. This rotation is resisted by bending in the side plates, by tension in bolt 1, and by compression on the side fibers of the timber at bolt 2. Neglecting the effect of the bending of the side plate, and assuming that the compression is concentrated at the bolt, the resisting forces are found to be $7,450 \times \frac{0.625}{3.5} = 1,330$ lb. Figure (c) shows the conditions on which this equation is based. To carry this stress, $\frac{1}{2}$ -in. bolts will be used, arranged as shown in Fig. (a). At bolt 2 the side plate presses against the chord member with a force of 1,330 lb. If the allowable bearing on the side of the chord member be assumed to be the same as for washers, the width of bearing required is $\frac{1,330}{412.5 \times 5.5} = 0.6$ in. As the

side plate extends $1\frac{1}{2}$ in. beyond the lug, proper provision has been made for the compression at this place. The lugs on the lower chord member are subjected to similar conditions. Figure (a) shows the adopted arrangement of lugs and bolts.

The details of the shoe are as shown in Fig. (a). Short pieces of $3\frac{1}{2} \times 3\frac{1}{2} \times \frac{1}{2}$ -in. angle are riveted to the side plates. As the maximum vertical reaction is 15,960 lb., and the rivets are in single shear, $\frac{15,960}{6,630} = 3$ rivets are required. In Fig. (a) six rivets are

shown in place. The sole plate is formed by an 8-in. 11.25-lb. channel. The flanges of the channel are placed downward and provide resistance against horizontal motion, taking the place of the notch used in the design of Fig. 34.

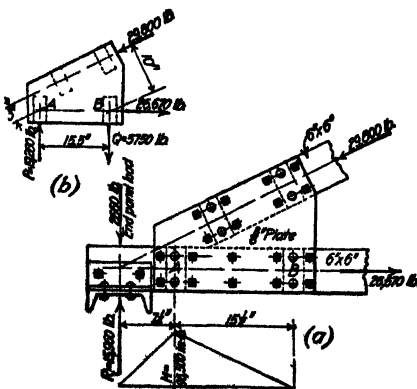

FIG. 37.

A modified form of the joint of Fig. 36 is shown in Fig. 37. In this design the side plates do not extend far enough along the lower chord member to include the shoe, which is fastened directly to the chord member. The stresses in the chord members are transferred to the side plates from which the combined loads are transferred back to the lower chord member and thence to the wall through the shoe. This arrangement causes a bending moment at the end of the lower chord member, and also causes vertical forces to be set up which must be resisted by the bolts at *A* and *B* of Fig. 37 (*a*). From Fig. (*a*), the moment in the chord members is $(15,960 - 2,660) 7.25 = 96,500$ in.-lb. Figure (*b*) shows the side plates removed with all forces in position. To hold the plate in equilibrium under the action of the stresses in the chord members, forces *P* and *Q* must act as shown. These forces can be determined subject to the conditions that moments about any point outside of the plate must be zero, and that *P-Q* is equal to the vertical component of the top chord stress. Figure (*b*) shows the resulting values.

The design of this form of joint will not be carried beyond this point. Design methods for the determination of the sizes of bolts required at *A* and *B* are given in the section on Splices and Connections—Wooden Members in the volume on "Structural Members and Connections." The fiber stresses in the chord member can be determined by the methods used for the design of wooden beams.

The arrangement of Fig. 36 is decidedly better than the one of Fig. 37; the former detail is therefore recommended, as the latter detail leads to very heavy bending and bolt stresses in the case of large structures.

Figure 38 shows a design for joint *a* in which a cast shoe is used. The horizontal component of the top chord stress, which is 26,670 lb., is transferred to the bottom chord member by means of lugs set into the lower chord. The vertical component of the top chord stress is transferred to the lower chord member in bearing on its upper fibers. It is the usual practice in the design of a shoe of the form shown in Fig. 38 to assume that the bearing on surface 2-4 is uniformly distributed over the area of contact between the shoe and the chord member. This assumption holds true only when ΣV , the vertical component of the top chord stress, is applied at the center of the bearing area on the chord member. In the case under consideration, which is shown in Fig. 38, ΣV intersects the surface 2-4 at a point 2.8 in. from its center. The maximum bearing pressure therefore occurs at point 2. At other points the bearing pressures are smaller than at 2, while at point 4 the direction of pressure is upward. This upward pressure must be resisted by a bolt, for upward pressures in such details can not be resisted directly by the surface 2-4. The principles of design are similar to those outlined for the design of the column footings given in the chapter on the Detailed Design of a Roof Truss with Knee-braces.

As shown in Fig. 38, the top chord member bears directly on a flat base 1 in. thick which is supported by two webs, one on each side of the casting. This base can be designed as a beam fixed at the ends by the side web plates. The adopted thickness of base is somewhat greater than required by the stresses. It was made $1\frac{1}{2}$ in. thick in order to secure a rigid connection at this point. The top chord member is held in place on the shoe by two side plates, and by means of a short lug set into the end of the member. In this design the 6 × 6-in. pieces called for in the design given in Table 11 can be used, as the bearing area on the

end of the chord member and the net area required for the lower chord member are furnished by the arrangement shown.

The vertical lug on the rear end of the shoe is made twice as deep as the one at the front end, as shown in Fig. 38. This is done in order to reduce the required shear resisting area in front of the shoe.

Assuming that the rear lug takes $\frac{2}{3}$ of the horizontal force and that the front lug takes the balance, the load at the front lug is $\frac{1}{3} \times 26,670 = 8,890$, and the load at the rear lug is 17,780 lb. Since the allowable bearing on the end fibers of the material is 1,800 lb. per sq. in., and the chord member is $5\frac{1}{2}$ in. wide, the depth required for the front lug is $\frac{8,890}{1,800 \times 5.5} = 0.898$ in., and for

the rear lug, a depth of $\frac{17,780}{1,800 \times 5.5} = 1.80$ in. is required. The front lug will be made 1 in. deep, and the rear lug will be made 2 in. deep, as shown in Fig. 38 (a).

The position of ΣV , the vertical component of the top chord stress, can be determined as soon as the depth of the lugs is fixed. As shown in Fig. (a), ΣH and ΣV intersect on the center line of the top chord member. To locate the line of action of ΣH , take moments about surface 2-4, from which

$$x = \frac{8,890 \times 0.5 + 17,780 \times 1}{8,890 + 17,780} = 0.833 \text{ in.}$$

Having given the line of action of ΣH , the position of ΣV can be determined by a layout of the joint, from which it will be found that ΣV lies 3.8 in. from the intersection of the center lines, as shown in Fig. (a).

The distance from the front lug to the end of the chord member is determined by the length required to develop a shearing resistance of 8,890 lb. For a working shear stress of 240 lb. per sq. in., the distance required is $\frac{8,890}{240 \times 5.5} = 6.74$ in. The length provided furnishes some excess area. Since the shearing area required for the rear lug is twice as great as that for the front lug, the adopted dimensions provide excess area. As the shear area for the rear lug is below that for the front lug, the entire distance from the rear lug to the end of the chord member can be counted on as shear area if necessary.

The thickness of the lugs is determined by their strength as simple cantilever beams. It will be found best to make the casting either of cast steel, or of malleable cast iron. For these materials the fiber stress in bending can be taken as 7,500 lb. per sq. in. If ordinary cast iron is used, for which the allowable bending stress is about 3,000 lb. per sq. in., very wide lugs would be required, resulting in a heavy, awkward casting. The stronger material will therefore be used.

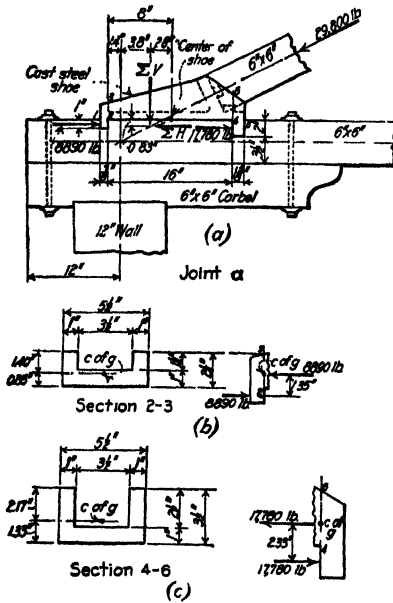

FIG. 38.

At the rear lug, the moment to be carried on the surface 4-5 is $17,780 \times 1 = 17,780$ in.-lb. The thickness required, using a working stress of 7,500 lb. per sq. in., is $\left(\frac{6M}{bf}\right)^{\frac{1}{2}} = \left(\frac{6 \times 17,780}{5.5 \times 7,500}\right)^{\frac{1}{2}} = 1.61$ in. A $1\frac{1}{2}$ -in. lug will be used. For the front lug, the moment to be carried is $8,890 \times 0.5 = 4,445$ in.-lb. and the thickness of lug required is $\left(\frac{6 \times 4,445}{5.5 \times 7,500}\right)^{\frac{1}{2}} = 0.805$ in. A $\frac{3}{8}$ -in. lug will be used.

Figures 38 (b) and (c) show sections of the body of the shoe. As shown by these sections, the body of the shoe is formed by a 1-in. bearing plate which rests directly on the lower chord member. This base plate is strengthened by side web plates. The height of these side web plates is varied to suit the stress conditions for which provision must be made.

Figure (b) shows the conditions which determine the size of the body of the shoe on section 2-3, close to the front lug. The thickness of the bed plate can be determined by assuming that it acts as a simple beam supported by the side webs. Neglecting the supporting effect of the lug, and assuming that the load to be carried is equal to the maximum allowable bearing value of the timber, which is 330 lb. per sq. in., and that the span of the bed plate is the distance between the centers of the vertical web plates, we have, for a 1-in. strip, a moment of $M = \frac{1}{8}wl^2 = \frac{1}{8} \times 330 \times 4.5^2 = 835$ in.-lb. For a fiber stress of 7,500 lb. per sq. in., as assumed above, the required thickness of base plate is $d = \left(\frac{6M}{bf}\right)^{\frac{1}{2}} = \left(\frac{6 \times 835}{1 \times 7,500}\right)^{\frac{1}{2}} = 0.818$ in. A 1-in. base plate will be used.

The depth of the side webs must be great enough to provide for the stresses due to the loading conditions shown in Fig. (b). From this sketch it can be seen that section 2-3 is subjected to a thrust of 8,890 lb., and a moment of $8,890 (0.85 + 0.5) = 12,130$ in.-lb. This force and moment act at the center of gravity of the section. As this is a case of combined stresses, the formula $f = \frac{P}{A} \pm \frac{Mc}{I}$ will be used. For the conditions shown in Fig. (b), the fiber stress at point 2 is $f_2 = \frac{P}{A} + \frac{Mc}{I} = \frac{8,890}{8} + 12,130 \times \frac{0.85}{2.99} = 4,560$ lb. per sq. in. (comp.) and at point 3 the fiber stress is $f_3 = \frac{P}{A} - \frac{Mc}{I} = \frac{8,890}{8} - 12,130 \times \frac{1.40}{2.99} = 4,690$ lb. per sq. in. (tens.). Figure (c) shows a section at 4-6, near the rear lug. For the forces and dimensions shown it will be found, by the same methods as used for section 2-3, that the fiber stress at point 4 is 6,240 lb. per sq. in. compressive, and that at point 6 it is 5,740 lb. per sq. in., tensile. As all of these fiber stresses are within the allowable value of 7,500 lb. per sq. in., the sections will be adopted.

The length of the bearing surface between the shoe and the chord member—that is, surface 2-4 of Fig. (a)—is determined by cut-and-try methods. If possible, the shoe should be located so that the vertical component of the top chord stress, shown by ΣV in Fig. (a), acts at the center of the bearing surface 2-4. When this can be done, the bearing pressure over the surface 2-4 is uniform. In the truss under consideration, the angle between the chord members is small and a shoe arranged as described above would not be as compact as desired. It

will be necessary, in order to secure a well proportioned shoe, to place the center of the bearing surface behind the line of action of ΣV . This will result in an uneven distribution of the bearing pressure between the shoe and chord member. As there will probably be upward pressures near point 4, a bolt will be provided to resist the total upward force. The distance between the top chord seat and the rear lug will be made just sufficient to allow a $\frac{3}{4}$ -in. bolt to be inserted, as shown in Fig. (a).

A length of bearing on line 2-4 of 16 in. will be assumed. The bearing stress on this area can be determined by the methods given in Art. 46. From eq. (3) of the article mentioned, with $P = \Sigma V = 13,335$ lb.; $b = 5.5$ in.; $d = 16$ in.; and $e = 2.8$ in.; we have $p_2 = \frac{P}{bd} \left(1 + \frac{6e}{d} \right) = \left(\frac{13,335}{5.5 \times 16} \right) \left(1 + 6 \times \frac{2.8}{16} \right) = 151.5 (1 + 1.05) = 310$ lb. per sq. in. Since this bearing value is less than the allowable of 330 lb. per sq. in., the assumed length is sufficient.

Since the term $\frac{6e}{d}$ in the above equation is greater than unity, it is evident that tension exists at point 4, although, as indicated by the low value of the term $\left(1 - \frac{6e}{d} \right)$, this tension is very small. From eq. (5) of the article mentioned above, the total tension in the bolt at the rear lug is $T = \frac{Pd}{24e} \left(\frac{6e}{d} - 1 \right)^2 = \left(\frac{13,335 \times 16}{24 \times 2.8} \right) \left(6 \times \frac{2.8}{16} - 1 \right)^2 = 7.95$ lb. The $\frac{3}{4}$ -in. bolt is much too large, but it will be used.

A corbel similar in form to the one shown in Fig. 34 will be used with the design under consideration. All details of the casting and the corbel are as shown in Fig. 38 (a).

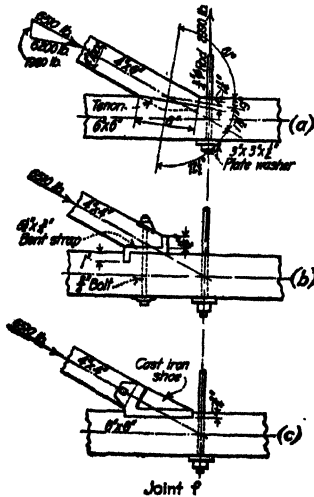
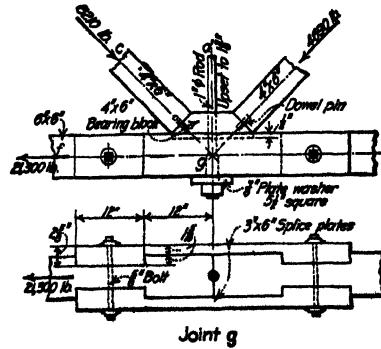

FIG. 39.



Joint g

FIG. 40.

Design of Joint f.—Joint details for joint *f* can be arranged as described for joint *b*. Figure 39 shows three forms of joint details for joint *f*. Figure (a) shows a design for notching, Fig. (b) shows a bent strap design, and Fig. (c) shows a cast-iron shoe. A plate washer is shown on the lower end of the vertical *c-f*. This washer is designed by the methods used for the washer at joint *d* and shown in Fig. 32.

Design of Joint g.—The lower chord of a wooden roof truss is usually spliced at the center point, which, in the truss under consideration, is joint *g*. Two designs will be given in detail for the tension splice required at this point. One design will be worked out for a tabled fish plate splice constructed entirely of wood, and another will be worked out using steel side plates and bolts. Design methods for these two forms of splices are given in the section on Splices and Connections—Wooden Members, in the volume on “Structural Members and Connections.”

Figure 40 shows a tabled fish plate splice of wooden construction. This splice is composed of two wooden plates with lugs which fit into recesses cut into the sides of the lower chord member. The design of the splices consists in the determination of the net area required for the splice plates and for the recessed portions of the lower chord member; the determination of the bearing area required between the splice plate and the chord member; the determination of the shearing area required on the projecting portions of the splice plate and the chord member; and the provision of bolts to hold the splice plates in position.

Since there are two splice plates, and since the total load to be carried is 21,300 lb., the net area required in the body of each splice plate is $\frac{21,300}{2 \times 1,650} = 6.45$ sq. in. Assuming the width of the splice plate to be 5.5 in., the thickness required is $\frac{6.45}{5.5} = 1.17$ in. As the load on the splice plate and the chord member act directly on the end fibers of the material, the allowable bearing value is 1,800 lb. per sq. in. The width of bearing required is then $\frac{21,300}{2 \times 5.5 \times 1,800} = 1.08$ in. A 3 × 6-in. piece, actual dimensions $2\frac{5}{8} \times 5\frac{1}{2}$ in., can be used as a splice plate. As shown in Fig. 40, the lugs will be made $1\frac{5}{16}$ in. deep, and the thickness of the splice plate at the center will also be made $1\frac{5}{16}$ in. This arrangement will provide ample net and bearing areas.

The length of the lugs required on the splice plates and on the end of the chord member is determined by the shearing area required to carry a load of $\frac{1}{2} \times 21,300 = 10,650$ lb. For a working shearing stress of 240 lb. per sq. in., the length of the lug required is $\frac{10,650}{240 \times 5.5} = 8.07$ in. To provide for possible defects in the material, the lugs will be made 12 in. long, as shown in Fig. 40.

Since the load to be carried by the splice plate is applied $1\frac{5}{16}$ in. from the axis of the plate, a moment is set up which tends to rotate the lug from its seat on the chord member. The amount of this moment is $10,650 \times 1.3125 = 14,000$ in.-lb. To hold the lug in its seat, a bolt will be placed through the splice plate and the chord member, as shown in Fig. 40. An approximate estimate of the stress in this bolt can be made by dividing the moment calculated above by the distance from the point of contact between splice plate and chord member to the bolt, which in this case is 6 in. Neglecting the effect of the resisting moment developed by the body of the splice plate, the stress in the bolt is $\frac{14,000}{6} = 2,330$ lb.

For a working stress of 16,000 lb. per sq. in., the required area at the root of thread is $\frac{2,330}{16,000} = 0.147$ sq. in., which is furnished by a $\frac{5}{16}$ -in. bolt. Standard

washers on the ends of this bolt will provide proper bearing area on the side fibers of the splice plate.

The net area of the chord members on the line of the bolt must be investigated. Since the depth of the cutting on each side of the main member is $1\frac{1}{8}$ in., as shown in Fig. 40, the net width of member is $5.5 - 2 \times 1.3125 = 2.875$ in. Assuming the hole for the bolt to be $\frac{3}{4}$ in. in diameter, the net depth of the chord member is $5.5 - 0.75 = 4.75$ in. Hence the actual net area of the chord member is $4.75 \times 2.875 = 13.65$ sq. in. The net area required, as shown in Table 11, is $\frac{21,300}{1,650} = 12.9$ sq. in. Therefore, as shown by the above calculations, the splice is sufficient in all of its details.

As shown in Fig. 40, two diagonal web members and a vertical tension rod enter joint g . The load in the tension rod is transferred to the chord member by means of a plate washer on the under side of the chord member. This washer is designed by the methods used for the washer at joint d , except that the allowable bearing pressure for the chord member at g is determined for the side fibers of the material, a value which is somewhat smaller than for joint d . However, it will be found that the two washers can be made of the same dimensions.

The two web members entering joint g are shown as seated on a wooden block set into the top of the chord member. Ample bearing area is provided by the arrangement shown in Fig. 40. Since the wind stress in one of the diagonals is 3,520 lb., and that in the other is zero, as given in Table 10, the bearing block must be notched into the chord member in order to hold the diagonals in place. A force diagram will show that the component of the wind stress parallel to the chord member is 2,380 lb. For an allowable bearing of 1,800 lb. per sq. in., the bearing area required is $\frac{2,480}{1,800} = 1.38$ sq. in. If the bearing block is made the full width of the chord member, a notch $\frac{1.38}{5.5} = 0.251$ in. deep is required. As shown in Fig. 40, a $\frac{1}{2}$ -in. notch is provided, for a shallower notch would not be effective.

Figure 41 shows a design for joint g in which steel side plates and bolts are used. The design of this joint consists in the determination of the number and size of bolts; the determination of the size of the side plates; and the spacing of bolts required to maintain safe shearing stresses in the timber.

If the thickness of the side plates be assumed as $\frac{1}{4}$ in., the loading conditions for a bolt are as shown in Fig. 41 (b). The total moment to be carried by all of the bolts is $10,650 \times 1\frac{1}{8} = 15,975$ in.-lb. From the table of safe bending moments on pins for an allowable fiber stress of 24,000 lb. per sq. in., the safe bending moment is 2,350 in.-lb. for a 1-in. bolt, and 3,350 in.-lb. for a $1\frac{1}{8}$ -in. bolt. Therefore, seven 1-in. bolts, or five $1\frac{1}{8}$ -in. bolts are required. To secure a compact joint, five $1\frac{1}{8}$ -in. bolts will be used. Before this number of bolts is finally adopted, the bearing pressure exerted by the bolts on the timber and on the steel side plates must be examined. For an allowable working bearing value of 1,200 lb. per sq. in. for bolts bearing on the timber, the area required for each bolt is $\frac{21,300}{5 \times 1,200} = 3.53$ sq. in. The bearing value provided by a $1\frac{1}{8}$ -in. bolt is $5.5 \times 1.125 = 6.19$ sq. in. For the side plates, the allowable bearing value on the steel plate is 24,000 lb. per sq. in., and the bearing area required for each bolt is

$\frac{21,300}{5 \times 24,000} = 0.178$ sq. in. The bearing area provided by two $\frac{1}{4}$ -in. side plates on each bolt is $2 \times 1.125 \times 0.25 = 0.56$ sq. in. As the assumed bolts are safe in bending and bearing, they will be adopted.

Figure 41 (a) shows the arrangement of the bolts. Net areas on sections $x-x$ and $y-y$ must be investigated before this arrangement is adopted. At section $x-x$, the net area required is $\frac{21,300}{1,650} = 12.9$ sq. in. Assuming that the bolts fit the holes exactly, the net area of the chord member at section $x-x$ is $(5.5 - 1.125) 5.5 = 24.1$ sq. in. At section $y-y$, the stress in the chord member is $\frac{1}{6} \times 21,300 = 17,050$ lb.; the net area required is $\frac{17,050}{1,650} = 10.32$ sq. in., and the net area provided is $(5.5 - 1.125 \times 2) 5.5 = 17.9$ sq. in. The net areas provided are therefore sufficient.

The distance between bolts, and the distance between the end of the chord member and a bolt is determined by the shear area required to develop a resistance equal to the load on a bolt. From Fig. 41 (a), the required distance between bolts for a shearing stress of 240 lb. per sq. in. is $\frac{21,300}{5 \times 5.5 \times 2 \times 1,800} = 1.61$ in. As shown in Fig. 41(a), the adopted bolt spacing exceeds the required spacing. The adopted spacing was used in order to avoid interference between the first set of bolts and the bearing block for the diagonal members. Six-inch spacing was adopted for the other bolts in order to secure a neat looking joint. All of the details of the bearing block for the diagonal members and washer for the vertical tension rod are the same as shown on Fig. 40.

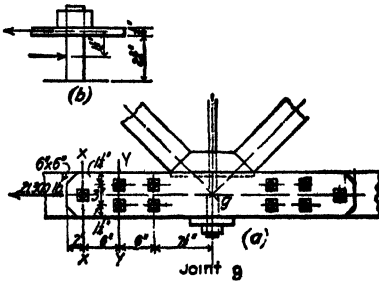

FIG. 41.

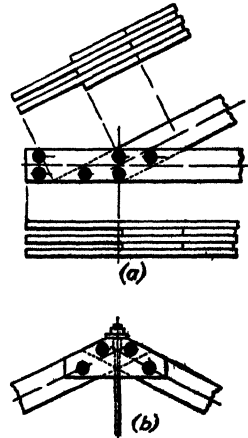

FIG. 42.

Joint Details for Trusses with Built-up Members.—In some cases truss members are made of built-up members composed of planks placed side by side and bolted together to act as a single piece, as described in Art. 26 for the top and bottom chord members of the truss under discussion in this chapter. Joint details for such members can be made up along the same lines as those given above for members composed of single sticks. In any case, it is well to provide excess bearing areas at all points in order to allow for possible defects in workmanship and in materials, due to the fact that the bearing surfaces are composed of several parts which must work together, each taking its proportion of the total load.

Figure 42 shows arrangements of built-up joint details for joints *a* and *d*. In Fig. (a) is given a detail for joint *a*. A design is given in Art. 26 for a bottom chord member composed of five 2 × 8-in. plank. A top chord section of the same size will also be used in this detail. As shown in Fig. (a), three of the top chord plank and two of the lower chord plank are cut away, and the remaining pieces are fitted together to form a joint. The parts are held together by means of bolts which can be designed by the methods given in the section on Splices and Connections—



FIG. 43.

Wooden Members, in the volume on "Structural Members and Connections." Figure (b) shows a form of joint for the apex of the truss.

Details of Purlin Connections.—In Art. 7 there is given a general description of the forms of purlin connections in general use. For the truss under consideration, a strap hanger of the form shown in Fig. 6 (b) of the above-mentioned article will be used. Standard sizes of strap hangers are given in trade catalogues, from which it will be found that a 3 × 3/8-in. strap is required for a 6 × 8-in. purlin.

It will be assumed that the purlin is to be placed with its lower edge on the same level as the lower face of the top chord member. Since the purlin as designed in Art. 24 is a 6 × 10-in. section, actual depth 9 1/2 in., and the top chord member, as designed in Table 11 of Art. 26, is a 6 × 6-in. section, actual depth 5 1/2 in., the purlin projects 4 in. beyond the top of the chord member, as shown in Fig. 43 (a). The 3 × 3/8-in. strap hanger is held in position on the chord member by lag screws. In locating the purlin at joint *b*, it is desirable that the purlin be placed with its center at the intersection of the center lines of the truss members. It may not be possible in all cases to do this, because of interference between the washer and the strap hanger. The purlin will be placed as close to the desired position as the conditions will permit.

Figure 43 (b) shows a detail for joint *d*, the apex of the truss. A single purlin of the same size as for joint *b* is used at joint *d*. The purlin at *d* is placed in a vertical position and is held in place by a strap hanger which is supported by blocks fastened to the chord member by means of lag screws.

The designs for joint *a* shown in Figs. 34 to 38 can be arranged without the use of a purlin. In place of a purlin the masonry can be built up between the trusses, and a wall plate provided on which the rafters are seated. If a purlin is desired at this point, a detail can be used of the form shown in Fig. 6 (d), p. 138.

28. General Drawing and Estimated Weight.—In Fig. 44 there is shown a general drawing of the truss designed in the preceding articles. It will be noted that the joints shown on this drawing are made by notching one member into another, and that the structure is practically an all-wood construction. These details were shown because they are of the type generally used for wooden trusses, and because they are readily designed, easily constructed, and a thoroughly practical, reliable structure is obtained, when such details are used.

An approximate estimate of weight will be made for the truss shown on Fig. 44 in order to check up on the dead weight estimated by the formula of Art. 23 and used in the calculation of stresses in Art. 26. In estimating weights, it was assumed that Western hemlock weighs 3 lb. per ft. board measure, and that

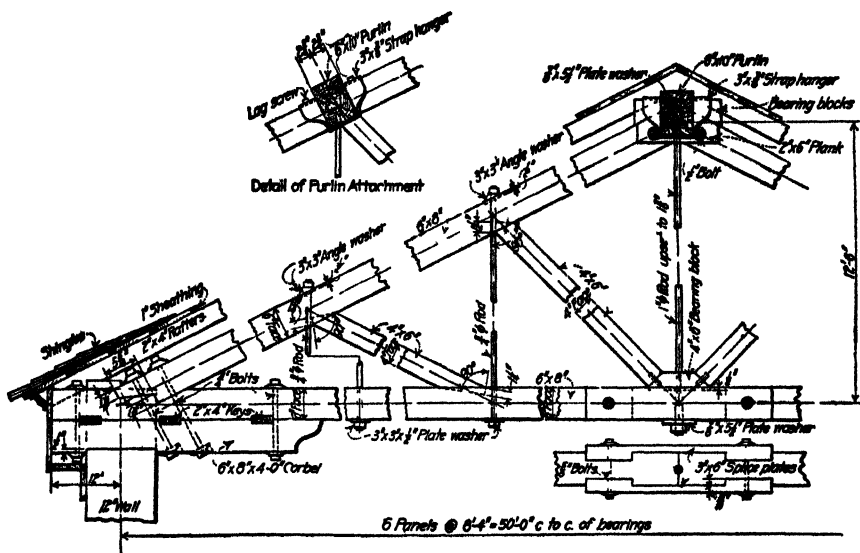

FIG. 44.

steel and cast iron weigh 490 lb. per cu. ft. Weights of steel rods were taken from the steel handbooks.

The total weight of the trusses was found to be 1,695 lb., divided as follows: Main members, 1,350 lb.; steel rods, 80 lb.; plate and cast washers, 100 lb.; bolts and dowel pins, 75 lb.; and strap hangers, 90 lb. Since the span is 50 ft., and the distance between trusses is 16 ft., the horizontal covered area per truss is $50 \times 16 = 800$ sq. ft. The actual truss weight per sq. ft. of horizontal covered area is then

$$\frac{1,695}{800} = 2.12 \text{ lb.}$$

From Art. 25 the weight as estimated by formula is 2.42 lb. per sq. ft. of covered area. The estimated weight is therefore about 14 per cent in excess of the actual weight. However, as brought out in the discussion on dead weight formulas given in the chapter on Roof Trusses—General Design, this difference between actual and estimated weight is not great enough to warrant a recalculation of the dead load stresses. The design as given in the preceding articles will therefore be considered as final.

DETAILED DESIGN OF A STEEL ROOF TRUSS

29. General Conditions for the Design.—A complete design will be made of the steel roof trusses for a building with masonry side and end walls. It will be assumed that the layout of the building, as determined by other considerations,

is as shown in Fig. 45. A roof covering consisting of wood shingles on plank sheathing will be used. The structure will be assumed as located in the Central States. It will be designed for a minimum load capacity of 40 lb. per sq. ft.

Trusses today are frequently designed with working stresses for steel of 18,000 or 20,000 lb. per sq. in. on the net section of tension members, and 17,000 — $0.485 \frac{l^2}{r^2}$ lb. per sq. in. on the gross section of compression members with values of $\frac{l}{r}$ not greater than 120, and $\frac{18,000}{1 + \frac{l^2}{18,000r^2}}$ for values of $\frac{l}{r}$ greater than 120. Corre-

spondingly higher stresses are used for rivets, both shop and field rivets having working stresses of 15,000 lb. per sq. in. for shear, 32,000 lb. per sq. in. for bearing (single shear) and 40,000 lb. per sq. in. (double shear). For the following design the working stresses for steel will be 16,000 lb. per sq. in. on the net section of tension members, and 16,000 — $70 \frac{l}{r}$ lb. per sq. in. on the gross section of compression members (l = unbraced length of member in inches, and r = least radius of gyration of section in inches). The limiting slenderness ratio for compression members will be $\frac{l}{r} = 125$ for main mem-

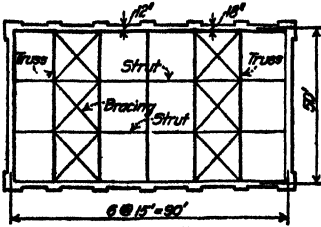

FIG. 45.

bers and $\frac{l}{r}$ is 150 for bracing. Comparative designs involving other working stresses may be made by simply substituting the proper values in place of those used here. It will be assumed that the trusses are not exposed to moisture or corrosive gases, so that the minimum thickness of material can be taken as $\frac{1}{4}$ in. All members carrying calculated stress will be made of two angles, the member and joint details to be arranged according to the discussion given in the chapter on Roof Trusses—General Design.

Rivets will be taken as $\frac{3}{4}$ in. in diameter, and rivet holes will be punched $\frac{1}{8}$ in. larger than the rivet diameter. In calculating net areas of tension members the diameter of rivet holes will be taken $\frac{1}{8}$ in. larger than the rivet, or $\frac{3}{8}$ in. Working values for shop rivets will be based on 10,000 lb. per sq. in. for shear, and 20,000 lb. per sq. in. for bearing; corresponding values for field rivets will be 7,500 and 15,000 lb., respectively.

The smallest angle leg which will hold a $\frac{3}{4}$ -in. rivet is usually taken as $2\frac{1}{2}$ in. Where an angle leg does not contain rivets, a 2-in. leg can be used. No reduction in section area will be made where angles are connected by one leg only, except the usual reduction for rivet holes.

Working stresses for wooden sheathing will be taken as 1,000 lb. per sq. in. for bending. The bearing on masonry walls will be 200 lb. per sq. in. Purlins will be made of rolled steel sections. To avoid excessive deflection, the adopted section will be limited in depth to $\frac{1}{10}$ of the span.

30. Type and Form of Truss.—The type and form of truss to be used, and the spacing of the trusses will be determined by a consideration of the principles outlined in the chapter on Roof Trusses—General Design. As a shingle roof is to be used, the minimum desirable roof pitch is $\frac{1}{4}$. This is also the pitch which will result in the most economical structure. It will therefore be adopted.

From Fig. 45, the distance between walls is 49 ft. If it be assumed that the end bearing plates are to be 12 in. long, the effective span will be 50 ft. Since the adopted pitch is $\frac{1}{4}$, the height of the truss will be $5 \times \frac{1}{4} = 12.5$ ft., as shown in Fig. 46. The length of the top chord member is $(25^2 + 12.5^2)^{1/2} = 28$ ft. If the top chord members be limited in length to about 8 ft., it will be necessary to divide the top chord into four parts, each $2 \times \frac{1}{4} = 7$ ft. long. From Fig. 4, p. 132, a convenient form of truss is offered by the compound Fink truss of Fig. (b), or by the four-panel Pratt truss of Fig. (k). Of these two forms of trusses, it will be found that for points near the center of the span the Fink truss can be made up with shorter members than those needed for the Pratt truss. As shown by the tables of stress coefficients given in the volume on "Stresses in Framed Structures," the stresses in the members of the Fink truss are a little larger than those in the Pratt truss. Everything considered, however, it seems best to use the Fink type, as shown in Fig. 46.

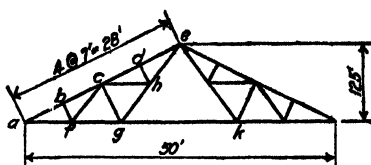

FIG. 46.

The economical spacing of trusses, as given in Art. 4, is about $\frac{1}{4}$ of the span length, or in this case, 12.5 ft. From Fig. 45, the distance of end walls is 90 ft. If the truss spacing be made 15 ft., there will be 6 bays and 5 trusses required.

Where 7 bays are used, the truss spacing will be about 13 ft. As economical conditions favor long truss spacing, the arrangement shown in Fig. 45 will be adopted.

31. Loadings.—As stated in Art. 29, the structure is supposed to be located in the Central States. The snow load for this region, as given in the table in Art. 16, is 20 lb. per sq. ft. of roof surface. For this section of the country, the unit wind pressure is generally taken as 30 lb. per sq. ft. on a vertical surface. From the table of wind pressures given in Art. 15, the intensity of normal pressure on a one-quarter pitch roof is 22.4 lb. per sq. ft. of roof surface.

The dead weight of the truss will be estimated by means of one of the weight formulas given in Art. 14. From the Carnegie Handbook formula, for 40-lb. capacity, the weight is given as

$$0.2(\sqrt{50} + 0.125 \times 50) = 2.7 \text{ lb. per sq. ft. of horizontal covered area.}$$

Assuming the weight of the bracing to be 0.8 lb. per sq. ft., the total dead weight of truss and bracing will be $2.7 + 0.8 = 3.5$ lb. per sq. ft. of horizontal covered area.

The weight of the roof covering can be estimated from the table given in Art. 13. Shingles weigh about 3 lb. per sq. ft. of roof, and the sheathing, which will be hemlock, will weigh about 3 lb. per sq. ft. of roof per in. of thickness.

32. Design of Sheathing.—The thickness of the sheathing can be determined from Table 2, p. 136. Thus for a roof of 40-lb. capacity, as assumed in Art. 29, Table 2 shows that for a slope of 6 in. per ft., which corresponds to one-quarter pitch, the limiting span of 1-in. sheathing is 6.84 ft. for a fiber stress of 1,000 lb. per sq. in. This is but slightly less than the distance between top chord panel points, as shown in Fig. 46. The value given above is the limiting span for bending, as deflection is not limited for shingle roofs. Although material 1 in. thick can be used for sheathing as far as stress conditions are concerned, it is not considered good practice to use such thin material for long spans. It is advisable to use 2-in. material, which will be adopted.

A more exact design of the sheathing can be made by considering the combinations of loads acting on the sheathing. These combinations are similar to those mentioned in Art. 17. They are: (a) dead load and snow load; (b) dead load, minimum snow load, and maximum wind load; and (c) dead load, maximum snow load, and minimum wind load. The dead load is the weight of the shingles and of the sheathing, which will be assumed to be 2 in. thick. At 3 lb. per ft. B. M., the sheathing weighs 6 lb. per sq. ft. of roof. From Art. 31, the maximum wind and snow loads are respectively 22.4 and 20 lb. per sq. ft. of roof surface, the wind load acting normal to the roof and the snow load acting vertical. Minimum snow load will be taken as one-half of the maximum, and minimum wind load will be taken a one-third of the maximum.

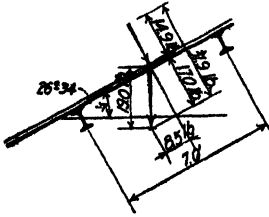

FIG 17

The allowable fiber stress for the sheathing will be taken as 1,000 lb. per sq in. As mentioned in Art 15, the wind load is an occasional loading and the working stresses can be modified accordingly. It will be assumed that the working stress for wind loading, when combined with stresses due to direct loading, is increased 50 per cent. This can be taken into account by reducing the wind load by $\frac{1}{3}$ —that is, by using a unit wind load of 20 lb. per sq ft. The normal load for a roof of $\frac{1}{4}$ pitch is then 14.9 lb. per sq. ft. This load can be combined with those for dead and snow load, and a working stress of 1,000 lb. per sq. in. applied to the resulting moment.

In designing the sheathing, it will be assumed to act as a beam supported by purlins placed at the top chord joints of the truss. As shown in Fig. 46, the purlins are spaced 7 ft. apart. Since the sheathing is continuous over the purlins, it will be assumed that the maximum moment is given by the formula $M = \frac{1}{10}wl^2$. The loads will be resolved into components perpendicular and parallel to the sheathing. It will be assumed that the moment to be carried by the sheathing is due to the normal loads; the effect of components parallel to the sheathing will be neglected.

The total vertical load for the combination of case (a) is 3 lb. for shingles, 6 lb. for sheathing, and 20 lb. for snow, a total of 29 lb. As shown in Fig. 47, the roof surface forms an angle of 26 deg. 34 min. with the horizontal. The component perpendicular to the roof is then $29 \times \cos 26 \text{ deg. } 34 \text{ min} = 29 \times 0.895 = 25.9 \text{ lb. per sq. ft. of roof.}$ For case (b), which is shown in Fig. 47, the vertical load is 3 lb. for shingles, 6 lb. for sheathing, and 10 lb. for minimum snow load; a total vertical load of 19 lb., for which the component perpendicular to the roof is $19 \times 0.895 = 17 \text{ lb.}$ The wind load normal to the roof is 14.9 lb. Hence the total normal load is $17.0 + 14.9 = 31.9 \text{ lb.}$ In the same way it will be found that the total normal load for case (c) is 30.9 lb. Case (b) therefore gives the maximum normal component.

The maximum moment to be carried by the sheathing due to the normal loads is then $M = \frac{1}{10}wl^2 = \frac{1}{10} \times 31.9 \times 7^2 \times 12 = 1,875 \text{ in.-lb.}$ For a rectangular section the fiber stress is given by the formula $f = \frac{Mc}{I} = \frac{6M}{bd^2}$. Considering a section of sheathing 1 ft. wide and 2 in. thick, we have

$$f = \frac{6 \times 1,875}{12 \times 2 \times 2} = 234 \text{ lb. per sq. in.}$$

As the allowable fiber stress is 1,000 lb. per sq. in., the sheathing is stronger than necessary. To conform to the general practice, the assumed sheathing will be used.

33. Design of Purlins.—Purlins are designed by the methods outlined in the chapter on Design of Purlins for Sloping Roofs. As the sheathing is quite rigid, it will be assumed that the purlins carry only the components of loads perpendicular to the roof surface. The combinations of loading will be the same as for the design of the sheathing. From the preceding article the maximum component of normal loads is 31.9 lb. To this must be added the weight of the purlin, which will be assumed to be 1.3 lb. per sq. ft. normal to the roof. The total normal load is then $31.9 + 1.3 = 33.2$ lb. Since the trusses are spaced 15 ft. apart, the area carried by a purlin is $7 \times 15 = 105$ sq. ft. of roof surface. The total uniformly distributed load for a purlin is then $33.2 \times 105 = 3,486$ lb., and the moment to be carried, assuming the purlin to be a simple beam between trusses, is $M = \frac{1}{2} Wl = \frac{1}{2} \times 3,486 \times 15 \times 12 = 78,500$ in.-lb. For an allowable working stress of 16,000 lb. per sq. in., the required $\frac{I}{c} = \frac{78,500}{16,000} = 4.9$ in.³. From the handbooks, this is furnished by a 7-in. 9.8-lb. channel. The true weight of this section, in lb. per sq. ft. normal to the roof surface, is $9.8 \times \frac{\cos 26^\circ 34'}{7}$
 $= 9.8 \times \frac{0.895}{7} = 1.25$. This is so close to the assumed value that the calculations will not be revised.

34. Determination of Stresses in Members.—The stresses in the truss members are to be determined for the same combinations of loads as used for the design of the sheathing and the purlins. Two general methods of calculation can be used. In the first method, the dead and snow loads are taken as vertical forces and the wind load is considered as acting normal to the roof on the windward side. In the second method of calculation, dead, wind, and snow loads are represented by a uniform vertical load acting over the entire roof surface. As stated in Art. 17, this second method of calculation can be applied to trusses of the Fink type. The stresses thus obtained are practically the same as those obtained by the first method of calculation. While the first method probably more nearly approximates the actual conditions, the second method results in a considerable saving of time spent in stress calculation. For the truss under consideration both methods of calculation will be carried out and the results compared.

The first step in the calculation of the stresses in the members is the determination of the panel loads. In the first method of calculation outlined above it will be found best to determine the panel loads due to dead, snow, and wind loads separately. The resulting stresses can then be determined and the proper combinations made up to determine the maximum stress.

As stated in Art. 32, the dead weight of the shingles and sheathing is a vertical load of 9 lb. per sq. ft. of roof surface. Since the purlins are spaced 7 ft. apart, and the trusses are 15 ft. apart, the roof area per panel is $7 \times 15 = 105$ sq. ft. The dead panel load due to the roofing is then $9 \times 105 = 945$ lb. To this must be added the weight of the purlin and the estimated weight of the truss. From Art. 33, the adopted purlin is a 7-in. 9.8-lb. channel. As the weight of one 15-ft. purlin is carried to each top chord panel point, the dead load due to the purlin is $9.8 \times 15 = 147.0$ lb. From Art. 31, the estimated weight of the truss and bracing was found to be 3.5 lb. per sq. ft. of horizontal covered area. As the span

is 50 ft., and since there are 8 roof panels, the horizontal covered area per panel is $15 \times 5\frac{1}{2} = 93.75$ sq. ft. The panel load due to the weight of the truss and bracing is then $93.75 \times 3.5 = 328.1$ lb. Adding together these partial panel loads, the total dead panel load is: $945.0 + 147.0 + 328.1 = 1420.1$ lb. A panel load of 1,420 lb. will be used in the calculation of dead load stresses.

The stresses in the truss members due to the dead panel load can be determined by the usual methods of stress calculation or by means of the tables of stress coefficients given in the volume on "Stresses in Framed Structures." Column 1 of Table 12 gives the calculated dead load stresses.

From Art. 31, the snow load is a vertical load of 20 lb. per sq. ft. of roof surface. Since the roof area per panel is 105 sq. ft., the snow panel load is $20 \times 105 = 2,100$ lb. The stresses due to this panel load can be determined by the methods outlined above for the dead load stresses. As the panel loads for dead and snow load are both vertical and are applied at the same points, the snow load stresses can be determined by ratio from the dead load stresses as given in col. 1 of Table 12. Thus if the dead load stresses be multiplied by the ratio of snow and dead panel loads, the resulting stresses will be the required snow load stresses. For the truss under consideration, the ratio of snow and dead panel loads is $\frac{2,100}{1,420} = 1.48$. This ratio can be set off on a slide rule and the stresses calculated with sufficient accuracy for all ordinary cases. The snow load stresses for the truss under consideration are given in col. 2 of Table 12. To assist in making up the combined stresses there is also given in col. 3 of Table 12 the stresses due to one-half of the maximum snow load.

The wind pressure on the roof surface of a one-quarter pitch roof due to a unit pressure of 30 lb. per sq. ft. is given in Art. 31 as 22.4 lb. per sq. ft. Where the working stress for wind is increased 50 per cent over that used for dead and snow loads, as in the case under consideration, the change can be made by a reduction in the intensity of the wind pressure corresponding to the increase in working stress. Since the working stress for wind is $\frac{3}{4}$ of that for the other loads, the intensity of the wind pressure can be taken as $\frac{3}{4}$ of the value given for a 30-lb. unit pressure. A uniform working stress of 16,000 lb. per sq. in. can then be used for all loadings.

The normal wind load per sq. ft. of roof corresponding to a working stress of 24,000 lb. per sq. in. is $\frac{3}{4} \times 22.4 = 14.9$ lb. As the area of the panel is 105 sq. ft., the wind panel load is $14.9 \times 105 = 1,565$ lb. The resulting stresses are calculated by the usual methods, or by means of the wind stress coefficients given in the volume on "Stresses in Framed Structures." In calculating the wind stresses it will be assumed that one end of the truss is fixed and that the other end is supported on a smooth plate on which it is free to slide. As it is generally assumed that the frictional resistance between smooth plates is zero, the reaction at the free end is vertical. The assumed end conditions are covered by Cases I and II of the wind stress coefficients for the Fink truss. The calculated wind stresses for wind on the left side of the truss are given in col. 4 of Table 12. In col. 5 the stresses for one-third wind load are given.

The combinations of dead, snow, and wind load stresses for maximum stresses in the truss members are the same as given in Art. 32 for the design of the sheathing. These combinations are: (a) dead load, one-half snow load, and maximum

wind load, and (b) dead load, maximum snow load, and one-third wind load. The maximum stresses for case (a) are given in col. 7 of Table 12. They are obtained by adding the values given in cols. 1, 3, and 4. Values for case (b) are given in col. 8. They are obtained by adding values given in cols. 1, 2, and 5.

Maximum stresses as determined by the second method of calculation outlined above are given in col. 9 of Table 12. The vertical uniform load which is to represent the combined effect of wind and snow can be taken from Table 9, p. 151. For a roof of one-quarter pitch located in the Central States, the load is given as 25 lb. per sq. ft. of roof surface. The equivalent load can also be estimated from the values for wind and snow given in Art. 31. To estimate this load, assume that the vertical component of the wind is combined with the snow load in the same manner as for maximum stresses in the first method of calculation. The vertical component of the wind load is $14.9 \times \cos 26^\circ 34' = 13.4$ lb. per sq. ft. of roof. If one-half of the snow load of 20 lb. per sq. ft. of roof be added to this load, there is obtained an equivalent load of 23.4 lb. For maximum snow and one-third wind the combined load is $\frac{2}{3} \times 13.4 + 20 = 24.4$ lb. These values compare very-well with the load of 25 lb. taken from the above mentioned table.

TABLE 12—STRESSES IN MEMBERS

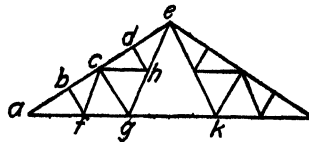

Member	Dead load	Snow load	$\frac{S.L.}{2}$	Wind from left	$\frac{W}{3}$	Wind from right	D L, S L, and max W	D. L., maximum S. L. and $\frac{W}{3}$	Uniform vertical loading
	1	2	3	4	5	6	7	8	9
ab	-11,120	-16,450	-8,225	-7,050	-2,350	-3,920	-26,895	-29,920	-31,660
bc	-10,490	-15,500	-7,750	-7,050	-2,350	-3,920	-25,290	-28,340	-29,850
cd	-9,840	-14,550	-7,275	-7,050	-2,350	-3,920	-24,165	-26,740	-28,040
de	-9,210	-13,640	-6,820	-7,050	-2,350	-3,920	-23,080	-25,200	-26,230
df	-1,270	-1,880	-940	-1,565	-522	0	-3,775	-3,672	-3,620
dh									
eg	-2,540	-3,760	-1,880	-3,130	-1,043	0	-7,550	-7,343	-7,240
af	+9,940	+14,700	+7,350	+8,750	+2,920	+688	+26,040	+27,560	+28,315
fg	+8,520	+12,600	+6,300	+7,000	+2,334	+688	+21,820	+23,454	+24,270
gh	+5,680	+8,410	+4,205	+3,500	+1,167	+688	+13,385	+15,257	+16,180
fc	+1,420	+2,100	+1,050	+1,750	+583	0	+4,220	+4,103	+4,043
ch									
eh	+2,840	+4,290	+2,100	+3,500	+1,167	0	+8,440	+8,207	+8,090
ke	+4,260	+6,300	+3,150	+5,250	+1,750	0	+12,860	+12,310	+12,135

+ = tension - = compression.

The panel load for equivalent vertical loading is determined by adding to the panel load for the above load, the dead panel load as given above. As the area of the roof panel is 105 sq. ft., the panel load for combined wind and snow is $25 \times 105 = 2,625$ lb. The dead panel load, as given above, is 1,420 lb., and the total panel load is $1,420 + 2,625 = 4,045$ lb. Column 9 of Table 12 gives the resulting stresses, which were calculated from the dead load stresses of col. 1 by means of the ratio of panel loads, $\frac{4,045}{1,420} = 2.845$, which was set off on a slide rule and the stresses read directly.

In some cases it is also specified that the roof shall be designed for a load capacity of not less than 40 lb. per sq. ft. of covered area. The specified capacity depends upon the service conditions and with the location of the structure, varying from 30 to 60 lb. For the truss under consideration, the panel load will be $40 \times 93.75 = 3,750$ lb. Since this panel load is less than the one used for the calculation of the stresses given in col. 9 of Table 12, the resulting stresses will be smaller than those given in col. 9. In some cases these stresses may exceed the others, in which case they will determine the design.

Comparing the stresses obtained by the two methods of calculation, as given by cols. 7 and 8 for the first method, and by col. 9 for the second method, it will be found that, for top and bottom chord members, the stresses given by col. 9 are a little larger than those given in either col. 7 or 8, and that the stresses in the web members are almost identical in cols. 7, 8, and 9. The second method of calculation therefore gives practically the same results as the more exact first method. The stresses given in col. 9 will be used as the maximum stresses for the design under consideration.

35. Design of Members.—The conditions for the design, as stated in Art. 29, contain the following references to working stresses: tension, 16,000 lb. per sq. in. on the net section; compression, $(16,000 - 70\frac{l}{r})$ lb. per sq. in. on the gross section, $\frac{l}{r}$ not to exceed 125. The minimum thickness of material is given as $\frac{1}{4}$ in. All members carrying calculated stress are to be made up of two angles. Design methods for tension and compression members are given in the volume on "Structural Members and Connections."

In making up truss members such as the top and bottom chord, which are continuous over several panels, it is the usual practice to design the member for the section of maximum stress, and to use the same section for the entire member. This is good practice, for it will probably be found that if the sections are changed to fit the stresses and splices made at each joint, the cost of the shop work on these splices will exceed the cost of the excess material required for continuous members.

Trusses of small size can generally be shipped in one piece. All joints can be riveted up in the shop and the truss erected as a unit in the field. The limiting dimensions of fully riveted trusses are governed by the methods of transportation. It is generally specified that a truss or girder, which is to be shipped by train, must have one dimension not exceeding from 10 to 12 ft. Trusses with a greater least dimension than that mentioned must be broken up into smaller parts. The truss under consideration in this design will have a total height, which is its least dimension, of about 13 ft. It must then be broken up into smaller parts. For trusses

of the type under consideration, it is usual to provide field splices at joints g , e , and k of the truss diagram of Fig. 46. The least width of the pieces thus formed will be the distance along member $c-g$, which is about 8 ft. Continuous members will then be used for the top chord member a to e ; the bottom chord from a to g ; and the diagonal from g to e . Member $g-k$ will be shipped as a single piece.

Design of Tension Members.—The maximum stress in the bottom chord member from a to g occurs in the section $a-f$, where the stress is 28,315 lb. For a working stress of 16,000 lb. per sq. in., the required net area is $\frac{28,315}{16,000} = 1.77$ sq. in.

An angle must now be selected whose net area—that is, the area of the section minus the area of the rivet holes—will provide the required area. As stated in Art. 29, the rivets are to be $\frac{3}{4}$ in. in diameter, and the rivet holes are to be made $\frac{1}{8}$ in. larger, or $\frac{7}{8}$ in. The area to be subtracted from the gross area of the section in determining net area is then the thickness of the material multiplied by $\frac{7}{8}$. The number of rivet holes to be subtracted from each angle in the determination of the net areas depends on the type of end connection used for the member in question. When an angle is connected by both legs, the area of two rivet holes should be deducted from each leg so connected, or the distance between the rivets in the two legs of the angle should be made such that it will be necessary to deduct but one rivet hole. Tables of limiting spacing for this condition are given in the section on Splices and Connections—Steel Members in the volume on "Structural Members and Connections."

Figure 54 shows the details of joint a as adopted for this design. The bottom chord member is shown as connected by one leg. One rivet hole will then be deducted from each angle. Assuming two $2\frac{1}{2} \times 2\frac{1}{2} \times \frac{1}{4}$ -in. angles, whose gross area as given by the handbooks is $2 \times 1.19 = 2.38$ sq. in., and deducting one rivet hole from each angle, or a total of $2 \times \frac{7}{8} \times \frac{1}{4} = 0.44$ sq. in., the net area of the two angles is $2.38 - 0.44 = 1.94$ sq. in. As given above, the required area is 1.77 sq. in. The assumed section is therefore ample, and will be adopted.

Member $f-g$ will be made the same as $a-f$. From Fig. 53, it will be noted that the member is connected by both legs. Assuming two rivet holes deducted from each angle, the net area of the section is $2.38 - 4 \times 0.22 = 1.50$ sq. in. As shown in Table 13, the required net area is $\frac{24,270}{16,000} = 1.52$ sq. in. Since the net area for two rivets deducted from each angle is practically the same as the required area, the rivets can be spaced as desired. If the proper area is not provided in any case, either larger angles must be assumed, or the distance between the rivets in the two legs of the angles must be such that only one rivet hole need be deducted from each angle in determining net areas.

Figure 55 shows another design for the joint at a . It will be noted that member $a-f$ has rivets in both legs. Deducting four rivet holes from the assumed section, the net area is found to be $2.38 - 0.88 = 1.50$ sq. in. The assumed section is too small. It will be found that a $2\frac{1}{2} \times 2\frac{1}{2} \times \frac{5}{16}$ -in. angle will provide the required area. However, this section is somewhat heavier than the lightest of the 3-in. sections. If a $3 \times 2\frac{1}{2} \times \frac{1}{4}$ -in. angle be assumed, it will be found that the net area with two holes deducted from each angle is $2 (1.31 - 2 \times 0.22) = 1.74$ sq. in., which is sufficient. This section would be adopted if the design of Fig. 55 were used.

Members $g-h$ and $h-e$ are made continuous. Table 13 shows that $2\frac{1}{2} \times 2 \times \frac{1}{4}$ -in. angles are used. These angles provide considerable excess area, but from the conditions of the design, as given in Art. 29, they are the minimum allowable angles. The remaining tension members are designed by the methods explained above. Table 13 contains all data in convenient form.

Design of Compression Members.—Compression members are designed by cut-and-try methods. That is, a section is assumed, the allowable working stress calculated from the column formula, the required area determined, and the required and provided areas compared. The assumed section is adopted if the area provided is equal to that required. It is not always possible to obtain an exact fit, but the two areas should not differ any more than is necessary. If the assumed section is insufficient, or if it provides excess area, the process must be repeated until the desired agreement is obtained. Gross or total section

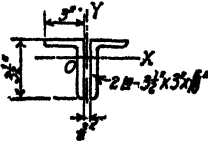

FIG. 48.

areas are used in the design of compression members; rivet holes are not deducted, as in the case of tension members.

The top chord will be made continuous from a to c . As shown in Table 13 the maximum stress, which is 31,660 lb., occurs in member $a-b$. Assume two $3\frac{1}{2} \times 3 \times \frac{5}{16}$ -in. angles, placed as shown in Fig. 48. Since the allowable working stress depends on the ratio of length to least radius of gyration, the angles should be so placed that the radii of gyration for the axes OX and OY of Fig. 48 will be as large as possible, and also, the radii for the two axes should be as nearly equal as the conditions will permit. In this way a member is secured which has the same rigidity in all directions. This condition can best be realized by the use of angles with unequal legs placed with the longer legs back to back. In Fig. 48 the angles are shown separated by a small space. This is done to make room for the gusset plates at the joints, as explained in the chapter on Roof Trusses—General Design. For trusses of the size under consideration, a $\frac{3}{8}$ -in. space is ample.

The radii of gyration for angles placed as shown in Fig. 48 can be found in tables given in the steel handbooks. From such tables it will be found that the radii are 1.10 in. for axis OX and 1.35 in. for axis OY . From Table 13 the length of member $a-b$ is 84 in. Hence the ratio of length to least radius of gyration is $\frac{l}{r} = \frac{84}{1.10} = 76.4$. Substituting this value of $\frac{l}{r}$ in the column formula of Art. 29, the allowable working stress is $16,000 - 70 \frac{l}{r} = 16,000 - 70 \times 76.4 = 10,650$ lb. per sq. in. The area required is $\frac{31,660}{10,650} = 2.97$ sq. in. From the steel handbooks, the area of the assumed angles is $2 \times 1.93 = 3.86$ sq. in. The assumed section is a little too large, but no other section of less weight per foot could be found that would bring a closer agreement between required and provided areas. It was therefore adopted.

The top chord design as given above applies to members carrying compression only. If the purlins are placed between the panel points, the top chord acts as a beam as well as a compression member. Design methods for this condition are given in Art. 39.

Table 13 gives the design data for the other compression members. The design methods used are exactly the same as those given above for member *a-b*. Sections of minimum size were adopted, consisting of two 2½- × 2- × ¼-in. angles with the longer legs separated by a ¾-in. space.

TABLE 13—DESIGN OF MEMBERS

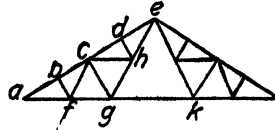

Member	Stress (lb)	l (in)	r (in)	l/r	f (lb per sq in)	Area required (sq in)	Section (in)	Area provided	
								Gross (sq in)	Net (sq in)
<i>ab</i>	-31,660	84	1 10	76 5	10,650	2 970	2 l 3½ × 3 × ¼	3 86	
<i>bc</i>	-29,850	84	1 10	76 5	10,650		2 l 3½ × 3 × ¼	3 86	
<i>cd</i>	-28 040	84	1 10	76 5	10 650		2 l 3½ × 3 × ¼	3 86	
<i>de</i>	-26 230	84	1 10	76 5	10 650		2 l 3½ × 3 × ¼	3 86	
<i>bf-dh</i>	- 3 620	42	0 78	53 9	12 230	0 296	2 l 2½ × 2 × ¼	2 12	
<i>cg</i>	- 7,240	84	0 78	107 8	8 460	0 837	2 l 2½ × 2 × ¼	2 12	
<i>af</i>	+28 315				16 000	1 77	2 l 2½ × 2½ × ¼	2 38	1 94
<i>fg</i>	+24,270				16 000	1 52	2 l 2½ × 2½ × ¼	2 38	1 50
<i>gh</i>	+16 180				16 000	1 01	2 l 2½ × 2½ × ¼	2 38	1 50
<i>fk</i>	+ 4,045				16 000	0 252	2 l 2½ × 2 × ¼	2 12	1 68
<i>gh</i>	+ 8,090				16 000	0 504	2 l 2½ × 2 × ¼	2 12	1 68
<i>he</i>	+12 135				16 000	0 759	2 l 2½ × 2 × ¼	2.12	1 68

+ = tension - = compression

36. Design of Joints.—The general principles of joint design are given in the chapter on Roof Trusses—General Design, and in the section on Splices and Connections—Steel Members, in the volume on “Structural Members and Connections.” Well-designed joints are just as important as well-designed members. To secure good joint design, a few fundamental principles of design must be observed. The center lines of all members entering a joint must intersect at a common point. If the conditions are such that this can not be done provision must be made for the additional stresses due to joint eccentricity. All stresses should be traced through the joint, and proper connections made between all parts. Typical joint details are given in the chapter on Roof Trusses—General Design.

In trusses of the size under consideration in this design, the angles are usually connected to the gusset plates by means of rivets through one leg only, as shown in Figs. 49 to 55 inclusive. Theoretically, this is not good practice, for all of the stress is transferred to the gusset plate through one angle leg, resulting in excessive local stresses. However, in small trusses the members generally contain more area than required for stress conditions, which assists in carrying the excess stresses. In larger trusses lug angles are riveted to the gusset plate and to the outstanding legs of the angles, thereby transferring the stresses from both legs of the angles into the gusset plate and avoiding excessive local stresses.

The number of rivets required in the end connection of any member depends on the working stresses for the rivets and on the method of making the connection to the gusset plate. The principles governing the design of riveted joints are given in the section on Splices and Connections—Steel Members, in the volume on "Structural Members and Connections."

As stated in Art. 29, the working stresses for shop rivets are 10,000 lb. per sq. in. for shear and 20,000 lb. per sq. in. for bearing. Corresponding values for

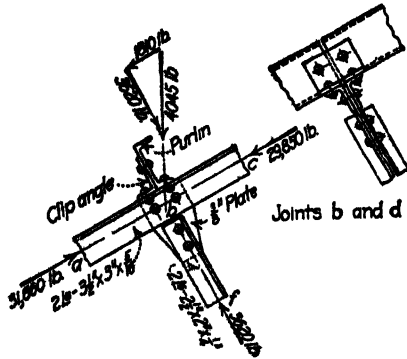

FIG. 49

field rivets are given as 7,500 and 15,000 lb. per sq. in. respectively. Tables of rivet values are given in the section on Splices and Connections—Steel Members in the volume on "Structural Members and Connections" and also in the steel handbooks. From these tables the single shear values of $\frac{3}{4}$ -in. shop and field rivets are 4,420 and 3,310 lb. respectively. The bearing value of a rivet depends on the thickness of the gusset plate. For trusses of the size under consideration, a $\frac{3}{8}$ -in. plate is usually ample. In any case the adopted thickness should be

such that large gusset plates can be avoided. For a $\frac{3}{8}$ -in. plate, the bearing of a $\frac{3}{4}$ -in. shop rivet is 5,625 lb., and the corresponding value for a field rivet is 4,220 lb. The design of the several joints will now be considered in detail.

Joint b.—Figure 49 shows the details of joint *b*. The stresses in the members and the panel load at joint *b* are shown in position. As shown by the force diagram, the stress in member *b-f* is balanced by the component of the joint load perpendicular to the top chord, and the difference between the stresses in the top chord members *a-b* and *b-c* is balanced by the component of the joint load parallel to the top chord. The complete design of the joint therefore consists in transferring the stress in member *b-f* to the gusset plate and thence to the top chord angles; and also in equalizing the difference in stress between members *a-b* and *b-f* by means of a purlin connection.

Member *b-f*, whose stress is 3,620 lb., is connected to the gusset plate by shop rivets in bearing on the $\frac{3}{8}$ -in. plate. The value of these rivets, as given above, is 5,625 lb. per rivet, and the number required to connect *b-f* to the gusset plate is $\frac{3,620}{5,625} = 1$ rivet. Since a rigid connection can not be made with a single rivet, it is the general practice to use not less than two rivets in any connection. Two rivets have therefore been used in the connection shown in Fig. 49.

The load to be transferred from the gusset plate to the top chord angles is equal to the stress in member *b-f*. Since the conditions are the same as for the connection between *b-f* and the gusset plate, two rivets will be used, as shown in Fig. 49.

Member *a-b-c*, the top chord, is continuous across joint *b*. As shown by the force diagram, the difference in stress between members *a-b* and *b-c*, which is $5,825 - 20,250 = 1,810$ lb., is balanced by the component of the joint load parallel to the top chord. To equalize the stresses in *a-b* and *b-c*, rivets capable

of transferring 1,810 lb. from the purlin to the top chord must be placed in position. These rivets will be placed in the outstanding leg of the clip angle and in the flange of the channel, as shown in Fig. 49. The value of the connecting rivets is determined either by their single shear value as shop rivets, which is 4,420 lb., or by the bearing value on the leg of the $\frac{5}{16}$ -in. clip angle, which is 4,690 lb. The single shear value governs, and only one rivet is required in the purlin connection. In order to make a rigid connection, it will be necessary to use two rivets in the clip angle and two more in the flange of the channel. Figure 49 shows the complete details. Joint *d* is similar to joint *b*; the same details will be used.

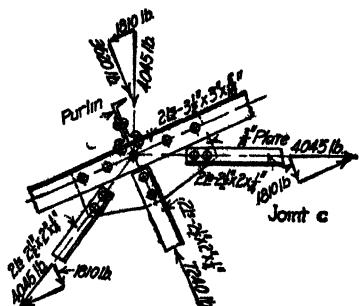

FIG. 50

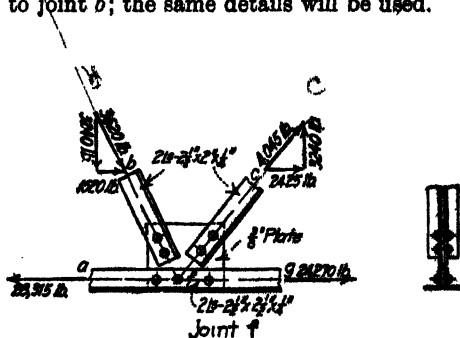

FIG. 51.

Joint c—Figure 50 shows the details of joint *c*. The design of this joint is carried out by the same methods as used for joint *b*. In this case the stresses in members *f-c*, *g-c*, and *h-c*, are transferred to the gusset plate, and the resultant of these stresses, which can be seen from Fig 50 to be $7,240 - 2 \times 1,810 = 3,620$ lb., is to be transferred to the top chord angles.

As before, the rivets connecting the angles to the gusset plate are in bearing on a $\frac{3}{8}$ -in. plate and have a value of 5,625 lb per rivet. One rivet is required for members *f-c* and *h-c*, and two rivets are required for *g-c*. Two rivets are used in each member, as shown in Fig 50. The stress of 3,620 lb., which is to be transferred from the gusset plate to the top chord, will require only one rivet, as at joint *b*. To secure a rigid connection five rivets have been used, spaced about 4 in. apart, as shown in Fig 50.

The load to be transferred by the purlin connection to the top chord angles is the same as for joint *b*, as shown by the force diagram. Details similar to those at joint *b* will be used, as shown in Fig. 50.

Joint f.—The conditions at joint *f* are shown in Fig. 51. As before, the chord members are continuous across the joint. The design of the joint consists in transferring the stresses in the members *c-f* and *b-f* to the gusset plate and thence to the chord angles, and in equalizing the stresses in members *c-f* and *f-g*. Since double angles are used for all members, and the gusset plate is $\frac{3}{8}$ in. thick, the rivet value is 5,625 lb., as before. A single rivet is sufficient to transfer the stresses from members *b-f* and *c-f* to the gusset plate. Two rivets have been used in each member, in order to make a rigid connection.

As shown by the force diagram of Fig. 51, the stresses in *b-f* and *c-f* have components perpendicular to the chord member which balance each other, and have components parallel to the chord member whose sum is equal to the force transferred.

in stresses in the chord members. The rivets connecting the gusset plate to the chord angles must then be capable of transferring a load of $28,315 - 24,270 = 4,045$ lb. A single rivet is sufficient, but the general practice is to use the detail shown in Fig. 51. One rivet is placed at the intersection of the center lines of the members, and other rivets are placed near the edges of the plate, as shown in Fig. 51. Joint *h* is similar to joint *f*. The same details will be used.

Joint e.—Figure 52 shows the conditions at joint *e*. The purlin load at this joint can be considered either as a single vertical load, as shown by the full line arrow of Fig. 52, or as two loads, shown by the dotted arrows, whose resultant is equal to the single load. The design methods are the same in the two cases.

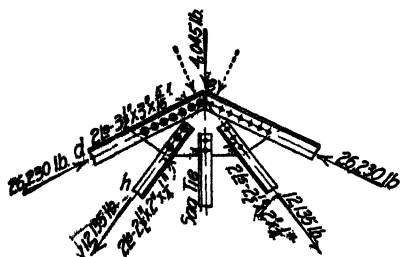

Joint *e*
FIG. 52

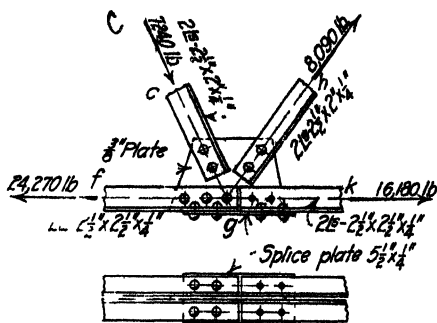

Joint *g*
FIG. 53

As noted early in this article, a field splice will be located at joint *e*. One side of the joint will be riveted up in the shop, and the rivets or bolts in the other side of the joint will be placed in position when the truss is assembled in the field. In order that a symmetrical joint may be made, the rivet values will be determined as for field rivets, and the same number will be used for both shop and field rivets. The connection will then be made with field rivets in bearing on a $\frac{3}{8}$ -in. plate. These rivets have a value of 4,220 lb., as given above.

The design of this joint consists in transferring to the gusset plate, the stresses in the several members, and in the provision of a purlin connection. Member *d-e*, whose stress is 26,230 lb., requires $\frac{26,230}{4,220} = 7$ rivets. For member

h-e, whose stress is 12,135 lb., $\frac{12,135}{4,220} = 3$ rivets are required; they are shown in position in Fig. 52. The load brought to the joint by the purlin will be provided for by means of a connection similar to that used at the other joints. If a single vertical purlin is used, a suitable bearing plate, or shelf angles attached to the gusset plate forms a satisfactory connection. Where two purlins are used at the apex of the truss, connections similar to those shown for joints *b* and *c* can be used. General details of purlin connections are shown in Art. 7.

Joint g.—Figure 53 shows the details of joint *g*. Member *g-k* is field spliced at this point; all other members entering the joint are shop riveted. The splice in the bottom chord member can be made in two ways. In one case, the stresses

in the members are transferred directly to the gusset plate by means of rivets in the vertical legs of the angles. This method is satisfactory where the stresses in the members are small. Where large stresses are to be transferred to the gusset plates, the joint is likely to be quite large if this method is used. To avoid large plates, the joint detail shown in Fig. 53 is generally used. This joint consists of a splice plate on the horizontal legs of the angles in addition to the rivets placed in the vertical legs. In this way part of the stress is carried by the splice plate, thereby reducing the stresses to be transferred by the vertical legs of the angles to the gusset plate.

The design of joint *g* consists in transferring to the gusset plate the stresses in members *g-h* and *g-c*, and in the provision of a partially continuous bottom chord member in which part of the stress is carried around the joint by a splice plate and the balance of the stress is transferred directly to the gusset plate. As shown in Fig. 53, the rivets in members *g-c* and *g-h* are shop rivets in bearing on a $\frac{3}{8}$ -in. plate. These rivets have a value of 5,625 lb per rivet. Member *c-g* requires $\frac{7,240}{5,625} = 2$ rivets, and *g-h* requires $\frac{8,090}{5,625} = 2$ rivets; they are shown in position

in Fig. 53. In determining the amount of stress to be transferred across the joint by the splice plate on the horizontal legs of the bottom chord angles, certain assumptions must be made regarding the distribution of the stresses. A common and reasonable assumption is that the stress in member *g-k* is uniformly distributed over the area of the member, and hence in this case the stresses in the two legs of the angle are equal, since the angle has equal legs. It is then assumed that the stress in the horizontal legs of the angles is transferred to the splice plate, and thence around the joint, while the stress in the vertical legs of the angles is carried directly to the gusset plate. Member *f-g* is assumed to have transferred to the splice plate a portion of its stress which is equal to the stress transferred to the splice plate by the horizontal legs of member *g-k*. The balance of the stress in member *f-g* is assumed to be transferred to the gusset plate through the vertical legs of the angles of member *f-g*. Since the stress in *f-g* is always greater than that in *g-k*, it follows that there will usually be an uneven distribution of stress to the legs of the angles of member *f-g*, unless the member is made up of unequal legged angles in which the distribution of area happens to be correct. In the present case equal legged angles are used, and unequal stress distribution results. However, in small trusses where it is permissible to connect angles by one leg, the conditions are more favorable than where the splice plate is not used.

On the assumptions made above, the stress in the vertical and horizontal legs of the angles of member *g-k* is $\frac{16,180}{2} = 8,090$ lb. Since member *g-k* is field spliced at this point, the rivets in the vertical legs are field rivets in bearing on a $\frac{3}{8}$ -in. plate; they have a value of 4,220 lb. per rivet. The number required is $\frac{8,090}{4,220} = 2$, which are shown in position in Fig. 53. The stress of 8,090 lb. in the horizontal legs of the angles is transferred to the splice plate by field rivets which are either in single shear or in bearing on the $\frac{1}{4}$ -in. material composing the angles and the splice plate. From the tables of rivet values, the field shearing value of a rivet is 3,210 lb., and the field bearing value for a $\frac{1}{4}$ -in. plate

is 2,810 lb. The latter value governs and the number required is $\frac{8,090}{2,810} = 3$ rivets. As shown in Fig. 53, four are used, two in each angle.

The stress in member *f-g* is 24,270 lb., of which 8,090 lb. is taken up by the splice plate, as assumed above. There is then left $24,270 - 8,090 = 16,180$ lb. to be transferred from the vertical legs of the angles to the gusset plate. The connecting rivets are shop rivets in bearing on a $\frac{3}{8}$ -in. plate, and have a value of 5,625 lb. per rivet. The number required is $\frac{16,180}{5,625} = 3$, which are shown in position in Fig. 53.

The splice plate on the horizontal legs of the chord angles must have sufficient net area to provide for the stress to be carried across the joint. This stress is 8,090 lb., and the required net area is $\frac{8,090}{16,000} = 0.505$ sq in. Assuming a plate $\frac{1}{4}$ in. thick and $5\frac{1}{2}$ in. wide, which is slightly in excess of the spread of the

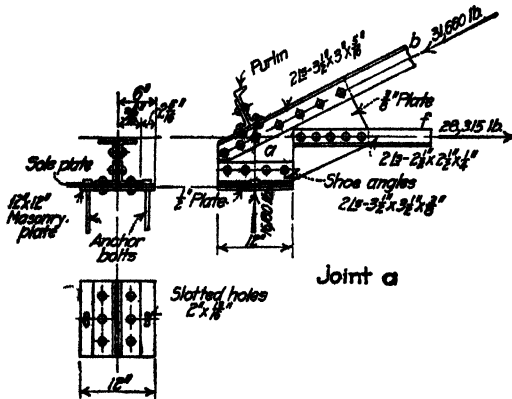

FIG. 54.

lower chord angles, the net area, deducting two rivet holes, is $(5.5 - 2 \times \frac{1}{4}) \times \frac{1}{4} = 3.75$ sq. in. The assumed plate provides a large excess area, but it is the smallest plate that can be used under the conditions for the design stated in Art. 29.

Joint a.—Two designs will be given for joint *a*, the heel of the truss. Figure 54 shows a design in which the stresses in the chord members and the shoe are brought directly to the gusset plate. In the design shown in Fig. 55, the bottom chord member is prolonged and acts as a support for the shoe. The rivets must then carry the vertical end reaction and the horizontal tension in the chord member. These designs will be carried out in detail.

In the design shown in Fig. 54, all members are connected to the gusset plate by shop rivets in bearing on a $\frac{3}{8}$ -in. plate. The rivet value is then 5,625 lb. Member *b-d* requires $\frac{31,660}{5,625} = 6$ rivets, and member *a-f* requires $\frac{26,315}{5,625} = 5$ rivets; these are shown in place in Fig. 54. The vertical end reaction is transferred to the gusset plate by means of a pair of short angles which are con-

nected to the plate by shop rivets in bearing. As the gusset plate does not bear directly on the sole plate, the rivets must carry the entire reaction to the gusset plate. From Art. 34, the panel load for the loading giving maximum stresses in the members is 4,045 lb., and the end reaction is $4 \times 4,045 = 16,180$ lb. The number of rivets required to connect the shoe angles to the gusset plate is $\frac{16,180}{5,625} = 3$. Figure 54 shows four rivets in place. The number was increased to four in order to bind the shoe angles more firmly to the gusset plate, as the angles were assumed to be 12 in. long.

The bearing area on the masonry walls is determined from the allowable bearing pressure, which is given in Art. 29 as 200 lb. per sq. in. For the end reaction given above, the required area is $\frac{16,180}{200} = 80.9$ sq. in. Since the shoe angles are 12 in long, the required width of bearing is $\frac{80.9}{12} = 6.74$ in. Two $3\frac{1}{2} \times 3\frac{1}{2} \times \frac{3}{8}$ -in. angles will be used, which will furnish a width of 7 in. It is the general practice in roof truss construction to rivet a sole plate to the under side of the shoe angles, and also to place a masonry plate on the wall. These plates are made wider than the shoe angles, in order to provide holes for the anchor bolts which are located outside the angles, as shown in Fig. 54. A plate about 12 in. wide will allow sufficient room in the case under consideration. The thickness of the sole and masonry plates must be such that they will not be overstressed due to the upward pressure on the portion of the plates which overhang the shoe angles. If this overhanging portion be considered as a cantilever beam acted on by a uniform load equal to the reaction divided by the total area of the sole plate, the required thickness is readily determined. In this case, the upward pressure is carried by a 12- \times -12-in. plate, and the unit pressure is $\frac{16,180}{144} = 112.2$ lb. per sq. in. As shown in Fig. 54, the overhang is $2\frac{5}{8}$ in. The bending moment at the edge of the angle is then $\frac{1}{2}(2\frac{5}{8} \times 112.2) 2\frac{5}{8} = 300$ in.-lb. per inch of plate. As there are two plates under the shoe angles, it will be assumed that each plate carries one-half of the moment. The required thickness for each plate can be determined from the formula $d = \left(\frac{6M}{bf}\right)^{\frac{1}{2}}$, where d = thickness of plate; M = bending moment per plate, which is 150 in.-lb.; b = width of plate under consideration, which is 1 in.; and f = allowable working stress, which is 16,000 lb. per sq. in. Then

$$d = \left(6 \times \frac{150}{16,000}\right)^{\frac{1}{2}} = 0.237 \text{ in.}$$

Each plate will be made $\frac{1}{2}$ in. thick, as this is the thickness of plate generally used in practice.

The design of the joint shown in Fig. 55 (a), differs from the one given for the arrangement shown in Fig. 54 only in the design of the bottom chord attachment. As shown in Fig. 55 (a), the stress in the bottom chord member and the end reaction are brought to the gusset plate by the same group of rivets. Since the reaction and the chord stress do not have the same line of action, the rivets must be designed to carry the resultant of these forces. This resultant is $(16,180^2 + 23,319^2)^{\frac{1}{2}} = 28,600$ lb. The rivets are in bearing on a $\frac{3}{8}$ -in. plate, and their

value is $5,625$ lb. per rivet; the number required is $\frac{32,600}{5,625} = 6$ rivets.

Figure 55 (a) shows the required number in place. It is desirable that these rivets be placed symmetrically with respect to the intersection of the center lines of the members. This is not always possible, due to insufficient room at the end of the chord member. The connection is therefore eccentric, and the rivets are subjected to additional stresses due to the induced moments. In general, the eccentricity, if unavoidable, should be kept as small as possible.

The stresses due to eccentricity are usually not calculated in practice. If desired, they can be calculated by the methods given in the volume on "Structural Members and Connections." These methods will now be applied to the arrangement shown in Fig. 55 (a). The rivets are subjected to a horizontal load due to the stress in the bottom chord member, which is considered to be equally divided among the rivets, and to a vertical load which can be divided into parts. One part is due to the vertical reaction, assumed to be uniformly distributed over the rivets, and a second part due to the eccentric moment. Figure (b) shows the assumed distribution of this latter part of the stress. It can be shown that the stress on the end rivets a and f , due to the eccentric moment, is given by the formula, $r = \frac{Mc}{\Sigma x^2}$, where r = stress on rivet, M = moment due to eccentricity, c = distance from center of gravity of rivet group to end rivet, and x = distance from center of gravity of rivet group to any rivet. From Fig. 55 it can be seen that the eccentricity of the connection is one-half of a rivet space, or $1\frac{1}{2}$ in. The eccentric moment is then, $M = 16,180 \times 1\frac{1}{2} = 18,200$ in.-lb. The rivet spacing is $2\frac{1}{4}$ in., $c = 5.625$, and

$$\Sigma x^2 = 2(1.125^2 + 3.375^2 + 5.625^2) = 88.32$$

With these values we have $r = 18,200 \times \frac{5.625}{88.32} = 1,160$ lb. This load acts upward on rivet a and downward on rivet f , as shown in Fig. (b). The vertical load on rivet a due to the reaction is also an upward load, and its amount is $\frac{16,180}{6} = 2,700$ lb., giving a total vertical load of $2,700 + 1,160 = 3,860$ lb. on rivet a . All other rivets have smaller loads, that on rivet f being the difference of the above values, or $1,540$ lb. These values are to be combined with the loads brought to the rivets by the stress in the chord member, which is $\frac{28,315}{6} = 4,720$ lb. per rivet. The resultant stress on rivet a is $(3,860^2 + 4,720^2)^{\frac{1}{2}} = 6,100$ lb., and that on rivet f is $(4,720^2 + 1,540^2)^{\frac{1}{2}} = 4,970$ lb. Values for other rivets vary between these two extreme values.

Since the allowable stress on a rivet for a $\frac{3}{8}$ -in. gusset plate is $5,625$ lb., the end rivet is overstressed. This can be relieved, either by reducing the eccentricity, which is not possible in this case, or by increasing the thickness of the gusset plate. From the tables of rivet values, it will be found that if the thickness of the gusset plate be increased to $\frac{1}{2}$ in., the bearing value of the rivet will be $7,500$ lb. The rivets are then not overstressed, and the design is satisfactory. Other features of the design are the same as for Fig. 54.

The purlin connection for the design of Fig. 54 is the same as that for joints b and c . In the design of Fig. 55, the top chord angles do not provide proper

support for the purlin. If a purlin is used at this point, a convenient method of support is provided by enlarging the gusset plate so that it will carry a standard channel connection, as shown in Fig. (a).

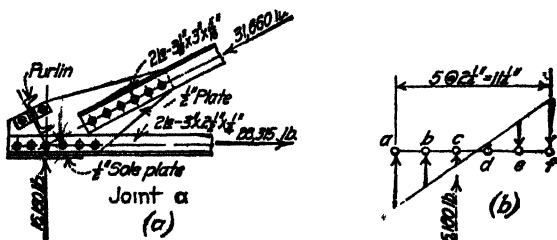

FIG 55

37. Minor Details.—In Art. 35, the compression members were designed on the assumption that the two angles forming the member act as a single piece. In order that this condition may be realized the angles must be riveted together at short intervals. The distance between the connecting rivets, which are known as stitch rivets, can be determined from the condition that for equal rigidity in all directions, the ratio of unsupported length to radius of gyration for a single angle must not exceed that for the composite member, as given in Table 13 of Art. 35. Thus, if L and R be respectively the unsupported length and the radius of gyration for the composite section, and l and r be the corresponding values for a single angle, we have

$$l = \frac{Lr}{R}$$

The value of $\frac{L}{R}$ for member $a-b$ is given in Table 13 of Art. 35, as 76.5. From the steel handbooks the value of the least r for a $3\frac{1}{2} \times 3 \times \frac{3}{16}$ -in. angle is 0.63 in. Substituting these values in the above equation, we have, $l = 76.5 \times 0.63 = 48.2$ in. Again, for member $b-f$, $\frac{L}{R} = 53.9$, $r = 0.42$, and therefore $l = 53.9 \times 0.42 = 22.6$ in. By the same method it will be found for member $c-g$ that $l = 107.8 \times 0.42 = 45.3$ in. In practice, these connecting rivets are spaced from 2 to about $2\frac{1}{2}$ ft. apart in compression members, and, although not required for tension members, they are generally provided, and are spaced from 3 to $3\frac{1}{2}$ ft. apart. The space between the angles is maintained by means of ring fills, or washers, through which the rivets pass.)

The ends of the truss are fastened to the masonry walls by means of anchor bolts. For trusses of the size under consideration in this design, anchor bolts $\frac{3}{4}$ in. in diameter and about 2 ft. long are used. Two bolts are placed at each end of the truss, as shown in Fig. 54.

To provide for the expansion of the truss due to temperature changes, it is the general practice to assume that the maximum range of temperature is 150 deg. With a coefficient of expansion for steel of 0.0000065, the change in length of a 50-ft. truss is $50 \times 150 \times 0.0000065 \times 12 = 0.585$ in., or nearly $\frac{1}{2}$ in. To allow for this movement, the anchor bolts at one end of the truss are usually set in slotted holes. Allowing $\frac{1}{2}$ -in. clearance all around the anchor bolts, the

required length of slot is $2 \times \frac{1}{16} + \frac{3}{4} + \frac{5}{8} = 1\frac{1}{2}$ -in. In practice, a $1\frac{1}{16}$ - \times 2-in. slotted hole would probably be provided.

The purlin connection for joint *c*, and for the other top chord joints, has been designed in Art. 36, and is shown in Fig. 49. As shown in Fig. 49, the clip angle consists of a short piece of $5 \times 3\frac{1}{2} \times 5\frac{1}{16}$ -in. angle shop riveted to the top chord angles. The vertical leg of the clip angle should be long enough to extend well up on the flange of a channel, thus providing a means of support which will prevent overturning.

A sag tie is sometimes provided where the length of the bottom chord member *g-k* is such that excessive deflection is likely to occur due to the weight of the member. Sag ties are generally made of a single angle of the smallest size allowable under the specifications. Where the pitch of the truss is $\frac{1}{4}$, or less, the use of a sag tie is advisable.

38. Estimated Weight.—The truss members were designed for dead load stresses determined from an assumed weight of truss which was calculated from an empirical formula. It is generally taken for granted that the assumed weight is correct, and no attempt is made to calculate the weight of the truss as designed. This procedure is allowable, for, as pointed out in Art. 14, the dead weight of trusses of the size considered in this design is a comparatively small part of the total load to be carried by the truss. A considerable error can then be made in estimating the dead load without causing any appreciable error in the maximum stresses.

In order to check the correctness of the dead weight formula used in Art. 31, an estimate has been made of the truss as designed in the preceding articles. Layout drawings were made of the several joints and the sizes of plates and lengths of members, determined from these sketches. Weights of members and plates were taken as given in the steel handbooks. The several items, as estimated, were: Main members, 1,700 lb.; gusset plates, 170 lb.; clip angles, rivet heads, and ring fills, 120 lb.; a total of 1,990 lb. for one truss. As the horizontal covered area for one truss is $15 \times 50 = 750$ sq. ft., the true weight of the truss is $\frac{1,990}{750} = 2.65$ lb. per sq. ft. of horizontal covered area. In Art. 31 the weight of the truss, as estimated by the formula, is given as 2.7 lb. per sq. ft. The assumed and calculated weights agree so closely that no revision of stresses is necessary.

39. Design of Top Chord for Bending and Direct Stress.—In certain cases the limiting span of the roof covering is such that purlins must be placed between the panel points of the top chord. The top chord member is then subjected to bending as well as direct stress, and must be designed as a combination beam and column. To illustrate the design methods for such cases, the design of the preceding articles will be modified by placing a purlin at the center point of each top chord panel in addition to those placed at the panel points. Working conditions, loadings, and allowable stresses will be taken as assumed in Art. 29.

Proceeding as in Art. 33, using the same type of roof covering, but with purlins spaced 8.5 ft. apart, it will be found that the required purlin section is a 6-in. 6.2-lb. channel, which is the minimum section allowed under the conditions of Art. 29. This change in the purlin arrangement will cause a slight increase in the dead load stresses. However, for the purposes of this design, it will be assumed

that the stresses in the members are unchanged, and that the values given in Table 12 of Art. 34 can be used in the subsequent calculations.

The chord section is to be designed for the same combinations of loading as used in Art. 32 for the design of the sheathing. Moments and simultaneous stresses are to be calculated for these combinations of loading, and a section chosen which will provide the area required by the maximum of these conditions of loading. In calculating the moments due to the applied loading, the chord sections may be considered as beams fixed at the ends, and the length may be

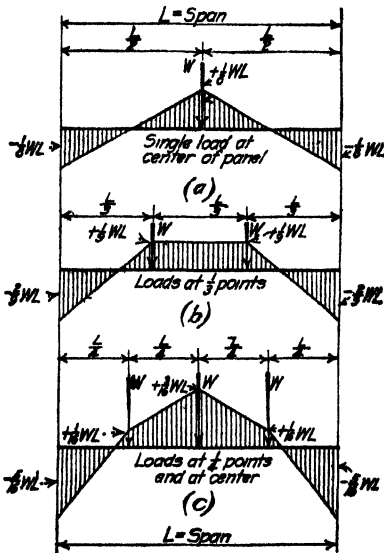

FIG. 56.

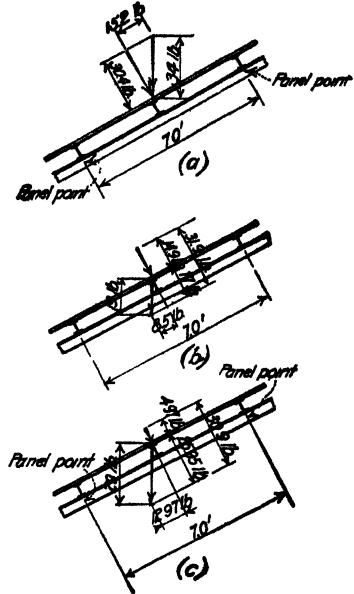

FIG. 57.

taken as one panel. Based on these assumptions, Fig. 56 gives bending moment diagrams and moment coefficients for several loading conditions.

Figure 57 shows the loading conditions for the several combinations of loading given in Art. 34. These loads can be resolved into components parallel and perpendicular to the chord members. It can readily be seen that the component perpendicular to the chord member will cause bending moments whose amounts can be determined by means of the coefficients given in Fig. 56, and that the components parallel to top chord tend to add to the compression in the member. The values given in Fig. 57 are in lb. per sq. ft. of roof surface.

Figure 57 (a) shows the conditions for combined dead, snow and wind load expressed as a uniform vertical load. From Table 9, Art. 17, the combined effect of wind and snow is 25 lb. per sq. ft., and from Art. 34, the weight of shingles and sheathing is 9 lb. per sq. ft., giving a total load of 34 lb. per sq. ft. Since the purlins are to be spaced 3.5 ft. apart, the roof area per purlin is $3.5 \times 15 = 52.5$ sq. ft. The normal load is then $52.5 \times 30.4 = 1,600$ lb., and the component parallel to the chord member is $52.5 \times 15.2 = 800$ lb. To these loads must be added the

corresponding components due to the weight of the purlin. As stated above, the adopted purlin is a 6-in. 8.2-lb. section. The end reaction at each truss, due to the weight of a purlin is $8.2 \times 15 = 123$ lb.; the normal component of the purlin load is $123 \times \cos 26^\circ 34' = 107$ lb., and the component parallel to the top chord is $123 \times \sin 26^\circ 34' = 54$ lb. This gives a total normal load of $1,600 + 107 = 1,707$ lb., and a component parallel to the top chord of $800 + 54 = 854$ lb. From col. 9 of Table 12 Art. 34, the stress in member *a-b* for combined vertical loading is 31,660 lb. Adding to this stress the component of load parallel to the chord member, the total stress in member *a-b* is $31,660 + 854 = 32,514$ lb. From Fig. 56 the moments at the ends and at the center of a beam fixed at the ends and loaded with a single load placed at the beam center are equal to $\frac{Wl}{8}$, positive moment at the beam center, and negative moment at the ends. With $W = 1,707$ lb., as calculated above, and $l = 7$ ft., the top chord panel length, the moments are, $M = 1,707 \times 7 \times \frac{12}{8} = 17,900$ in.-lb.

Figure 57 (b) shows the components for dead load, one-half snow load, and maximum wind load, and Fig. (c) shows corresponding values for dead load, maximum snow load, and one-third wind load. These combinations correspond to cases (b) and (c) of Art 32. By the same methods as used above, the moments and the simultaneous compression for the three conditions of loading shown in Fig. 57 are:

CONDITION OF LOADING	MAXIMUM MOMENT	SIMULTANEOUS COMPRESSION
Fig. (a)	17,900 in.-lb.	32,514 lb.
Fig. (b)	18,700 in.-lb.	26,895 lb.
Fig. (c)	18,120 in.-lb.	30,654 lb.

The required chord section can be determined by the methods given in the chapter on Bending and Direct Stress in the volume on "Structural Members and Connections." The method there given is applied to the case under consideration by assuming a chord section and calculating the maximum fiber stresses due to the combinations of loadings given above. If the calculated fiber stresses agree closely with the allowable working values, the assumed section is accepted. If the calculated values are too small or too large, another trial must be made, until finally an agreement is reached between actual and allowable fiber stresses.

A method which leads more directly to the desired section is obtained from the following analysis. Consider first the case of a column acted upon by an axial load P . The maximum stress on the extreme fibers of the section is given by the expression, $f = \frac{P}{A} + \frac{Pec}{I}$, where $P =$ axial load; $A =$ area of section; $e =$ eccentricity of load application due to imperfect centering of the load and to imperfections in column construction; $c =$ distance from column center to extreme fiber; and, $I =$ moment of inertia of the column section. If Ar^2 be substituted for I , where r is the radius of gyration of the section, the above equation can be written in the form $f = \frac{P}{A} \left(1 + \frac{ec}{r^2} \right)$. Solving for the required area, we have,

$$A = \frac{P \left(1 + \frac{ec}{r^2} \right)}{f} \quad (1)$$

As stated by eq. (1), the area of the column section for a given load P is found by increasing the load by a certain percentage, and dividing this increased load by the maximum allowable fiber stress. The general practice in column design is to use the column load without increase, and to allow for the term $\frac{ec}{r^2}$ of eq. (1) by reducing the allowable working stress. This reduction in working stress is made by means of a selected column formula. Equation (1) is then changed to read

$$A = \frac{P}{f_c} \tag{2}$$

where f_c is the working stress as given by the column formula.

Consider now the case of a column subjected to a moment M in addition to the axial load P . The total stress on the extreme fibers of the section will be

$$f = \frac{P}{A} + \frac{Pec}{I} + \frac{Mc}{I} = \frac{P}{A} \left(1 + \frac{ec}{r^2} \right) + \frac{Mc}{Ar^2}$$

Solving for A , the required area, we have

$$A = \frac{P \left(1 + \frac{ec}{r^2} \right)}{f + \frac{Mc}{fr^2}} \tag{1}$$

It will be noted that the first term of this expression is the same as eq. (1). Replacing this term by one of the form of eq. (2), we have

$$A = \frac{P}{f_c} + \frac{Mc}{fr^2} \tag{3}$$

That is, the area required for a column subjected to bending and direct stress is equal to the area required as a beam plus the area required as a column; the fiber stress for bending is the maximum allowable, in this case 16,000 lb. per sq. in., and the fiber stress for column action is that given by the column formula, which in this case is $16,000 - 70 \frac{l}{r}$. The value of r is to be taken for the entire section.

In applying eq. (3) to the determination of the section required for the several combinations of moment and direct stress given above, it will probably be found best to make a rough calculation of area, using moments and loads which are the average of the given values. Next assume that an angle with a certain width of leg is to be used. Approximate values of c and r can be used in this calculation. From the handbooks it will be found that for unequal angles with the longer legs placed back to back, the values of c and r are practically equal for an axis parallel to the shorter legs, and that they are approximately equal to $\frac{1}{2}$ of the length of the longer legs. On comparing the area determined by the substitution of these approximate quantities in eq. (3) with the areas given in the handbooks for angles of the assumed width, it is possible to tell whether a wider or narrower angle should be used.

For the case under consideration, a rough average of the moments and direct loads is $M = 18,600$ in.-lb., and $P = 30,000$ lb. Assume that a 4-in. angle is to be used. The approximate values of c and r will be $\frac{1}{2} \times 4 = 1.33$ in. In

applying eq. (3), substitutions must be made for points at the center and at the end of the member. This is due to the fact that column action is present at the center of the member, while at the ends of the member simple compression exists. Again, at the center of the member the moment is positive and at the ends the moment is negative. The compression fiber is then at the top of the member at its center point, and $c = \frac{1}{2}$ width of member; at the end points the compression fiber is on the side of the member, and $c = \frac{3}{2}$ width of the member. The greater of the areas thus obtained determines the area required for the member.

The length of the member under consideration is given in Table 13 of Art. 35 as 84 in. Then with $r = 1.33$, we have $f_c = 16,000 - 70 \frac{l}{r} = 16,000 - 70 \times \frac{84}{1.33} = 11,670$ lb. per sq. in. The calculated areas are as follows:

At center of member,

$$A_c = \frac{30,000}{11,670} + \frac{18,000 \times 1.33}{16,000 \times (1.33)^2} = 2.57 + 0.85 = 3.42 \text{ sq. in.}$$

At end of member,

$$A_e = \frac{30,000}{16,000} + \frac{18,000 \times 2.66}{16,000 \times (1.33)^2} = 1.87 + 1.70 = 3.57 \text{ sq. in.}$$

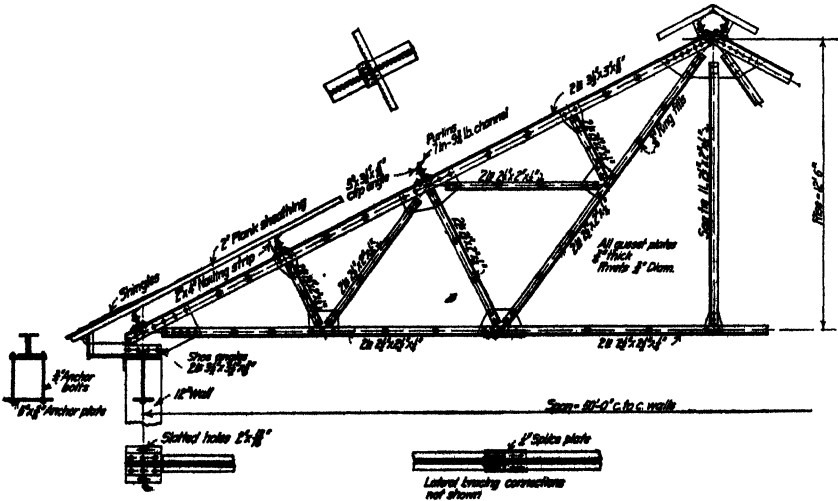

FIG. 58.—General drawing of 50-ft. steel roof truss.

From the steel handbooks, it will be found that the area of the smallest 4-in. angle is 4.18 sq. in. Similar trials made for 3- and 5-in. angles showed that the former was probably too small, and the latter too large. More exact calculations will therefore be made for the 4-in. angles.

The chord section will be assumed as made up of two $4 \times 3 \times \frac{3}{4}$ -in. angles with the 4-in. legs separated by a $\frac{1}{2}$ -in. space. Since the chord member is supported laterally at its center point by the purlins, the greatest unsupported length is in a vertical plane. From the steel handbooks, $r = 1.27$ in., and $c =$

1.26 in. at the center of the member and $c = 4.0 - 1.26 = 2.64$ in. at the end of the member. From the column formula, $f_c = 16,000 - 70 \times \frac{84}{1.27} = 11,370$ lb. per sq. in. Proceeding as above, it will be found that the values given for the conditions of Fig. (a) require the greatest area. These calculations follow.

Area required for condition of loading shown in Fig. 57 (a):

At center of member

$$A_c = \frac{32,514}{11,370} + \frac{17,900 \times 1.26}{16,000 \times 1.27^2} = 3.73 \text{ sq. in.}$$

At end of member

$$A_e = \frac{32,514}{16,000} + \frac{17,900 \times 2.74}{16,000 \times 1.27^2} = 3.93 \text{ sq. in.}$$

For the conditions of loading shown in Figs. (c) and (b), the results obtained were as follows: (c) $A_c = 3.59$ sq. in., $A_e = 3.85$ sq. in.; and (b) $A_c = 3.28$ sq. in., $A_e = 3.66$ sq. in. Since the calculated areas are all less than that furnished by the assumed angles, whose area is 4.18 sq. in., and since the agreement between required and provided areas was as close as could be obtained, using standard angles, the assumed section will be adopted.

The design of the top chord section, as given above, is based on the assumption that the chord members act as beams fixed at the ends. At panel points where the member is continuous across the joint, as at *b*, *c*, etc., this assumption is probably realized. At joint *a* the chord member is riveted to the gusset plate. In order to fix this point, an external moment must be applied which will be equal to the moment brought to the joint due to the end moment in the fixed beam. The lower chord member and the bearing of the shoe on the masonry will offer some resistance to the moment, but as the lower chord member is not as rigid as the top chord, it can not be depended upon to provide fixed end conditions at the joint.

An external moment of the desired amount can be produced at joint *a* by making the center line of the reaction eccentric with respect to the intersection of the center lines of the members. Thus, for the conditions governing the chord design, the end moment is 17,900 in.-lb., and the end reaction is 16,180 lb. The required eccentricity is then $\frac{17,900}{16,180} = 1.11$ in. Since the end moment is negative, it tends to cause a clockwise rotation of the joint. If the reaction line be moved 1.2 in. to the right of the position shown in Fig. 54, the desired eccentric moment will be produced. A similar result can be obtained for the design shown in Fig. 55.

40. Design of Bracing.—A general discussion of the bracing of roof trusses is given in Art. 9. Bracing for roof trusses of the type considered in this chapter is generally placed only in the plane of the lower chord of the truss. It is usually assumed that the sheathing and purlins, when placed in position, will provide sufficient bracing for the plane of the top chords. In some cases a ridge strut running the full length of the building is placed at the apex of the truss. This ridge strut serves also as erection bracing before the purlins are placed in position. Where the roof covering is corrugated steel, bracing is generally placed in the

plane of the top chord, as the corrugated steel is not rigid enough to provide the necessary lateral support.

Bracing of the type mentioned above is not subjected to any definite loads; a rigid analysis of stresses can not be made. The designer must rely upon his judgment and experience in determining the type and position of the bracing, and the size of the members to be used in any structure.

Figure 45 shows the arrangement of bracing which will be adopted for the truss under consideration. Pairs of trusses near the ends of the building will be provided with diagonal bracing placed in the plane of the bottom chord. The other trusses will be connected to the braced trusses by means of a continuous line of struts placed in the plane of the bottom chord. These struts are located at joints *g* and *k*. In addition to this bracing a ridge strut, located at joint *e*, will be run the full length of the building.

The diagonal members of the bracing in the plane of the lower chord will be made of single angles of minimum size. As the angles are to be connected by one leg only, a $2\frac{1}{2} \times 2 \times \frac{1}{4}$ -in. angle will be used. The struts will be considered as compression members; their size will be determined subject to the condition that $\frac{l}{r}$ must not exceed 150, which is the limiting value set for such members in Art.

29. As the trusses are 15 ft. apart, the angles must have a radius of gyration of at least $r = \frac{l}{150} = 12 \times \frac{1}{150} = 1.2$ in. From the steel handbooks it will be found that the standard angles of least weight which will answer the requirements are two $4 \times 3 \times \frac{1}{8}$ -in. angles placed with the 4-in. legs vertical and separated by at least a $\frac{1}{4}$ -in. space. These angles will therefore be used for the struts between trusses, and also for the ridge struts.

The bracing in the plane of the lower chord of the truss is attached to plates riveted to the truss, as shown in Fig. 58. At joint *g* the splice plate on the horizontal legs of the bottom chord angles is enlarged to include the connecting rivets in addition to those required for the splice. An exact determination of the number of rivets required in the ends of the bracing angles can not be made, as these members have no definite stress. Some designers assume that the connections are to be designed for the full strength of the member. On this assumption the $2\frac{1}{2} \times 2 \times \frac{1}{4}$ -in. angles would require $16,000 \frac{(1.06 - 0.22)}{2,810} = 5$ field rivets. Experience shows that for small trusses, two rivets are sufficient.

41. **The General Drawing.**—Figure 58 shows a general drawing of the truss designed in the preceding articles. On this drawing is shown the sizes of members, thickness of gusset plates, number of rivets in the members at each joint, arrangement of bracing, and all other details determined in the preceding calculations. It will be noted that only the general features of the design are shown on this drawing. This is the type of drawing turned out by the average designing office.

Before the truss can be constructed in the shop, a drawing must be made showing in greater detail the dimensions of the members and plates and the spacing of the rivets. A drawing of this nature is known as a shop drawing. The principles governing the making of shop drawings are given in the section on Structural Steel Detailing. The reader is referred to p. 513 for a complete shop drawing of a truss quite similar to the one designed in the preceding articles.

DETAILED DESIGN OF A TRUSS WITH KNEE-BRACES

42. General Considerations and Form of Trusses.—The discussion of the preceding chapter was confined to roof trusses supported on rigid masonry walls. This type of structure is shown in Fig. 59 (a). The truss is not called upon to

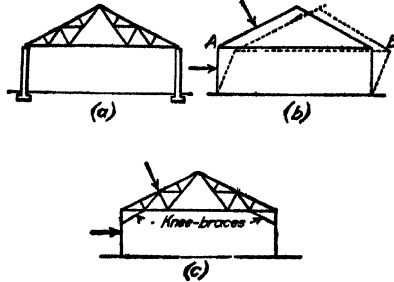

FIG. 50.

assist in carrying lateral forces. Resistance to lateral forces is provided by the walls on which the truss is simply supported.

In certain types of structures, particularly mill buildings and storage sheds, the trusses are supported on steel columns, as shown in Fig. (b). The outside walls are formed either by a curtain wall of brick, or by sheathing or corrugated steel siding which is supported by the columns. In either case these walls act merely as partitions, and do not assist in carrying lateral forces, as in the case of

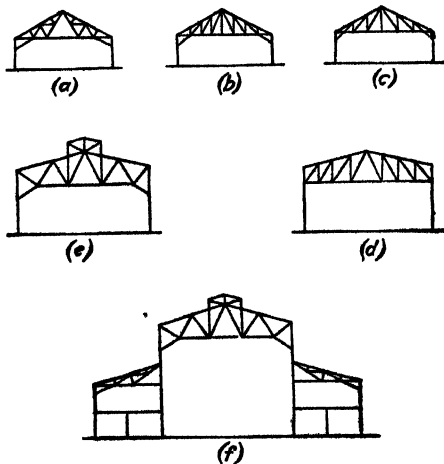

FIG. 60.

the rigid walls of Fig. (a). If the lateral forces are applied to a truss resting on columns, as shown in Fig. (b), the structure tends to collapse, as shown by the dotted lines. This distortion must be prevented by bracing capable of resisting horizontal forces.

The bracing provided to resist horizontal forces must answer two conditions. It must not obstruct the clear space between the walls and the lower chord of

the trusses, and it must provide a means of joining the trusses and the columns into a rigid framework. In small structures the required resistance to distortion is sometimes provided by means of riveted joints at *A* and *B* of Fig. (b). This method is not economical, even for trusses of moderate size. Figure 59 (c) shows a simple means of providing the required bracing. Short members known as knee-braces, are connected to the column and to a lower chord panel point. The structure thus formed answers the above requirements, and the stresses in the members are readily determined.

Figure 60 shows a few of the forms of knee-braced bents in common use. Figure 60 (a) shows a Fink truss with knee-braces, and Figs. 60 (b) and (c) show trusses of the Pratt type. Figure 60 (d) shows a flat Pratt truss with the end members prolonged to form a column. Other forms of trusses can be arranged in a similar manner. Figures 60 (e) and (f) show trusses provided with a monitor at the apex. In the form shown in Fig. (f), side trusses are also provided.

43. General Methods of Stress Determination.—Figure 61 shows a knee-braced bent acted on by wind loads W_1 perpendicular to the side walls, and loads W_2 normal to the roof surface. General methods of stress determination will be developed for the conditions shown in Fig. 61. Assume first that the truss is simply supported at points *A* and *B* by hinges, or by some method which will prevent horizontal movement under the action of the applied loads. Let *R* of Fig. (a) represent the resultant of the loads W_1 and W_2 . The reactions at *A* and *B* are to be determined for the force *R*.

For the conditions shown in Fig. 61, it will be noted that there are four unknowns to be determined; a vertical and a horizontal force at *A* and *B*. The problem is therefore indeterminate, for, as stated in the chapter on Principles of Statics in the volume on "Stresses in Framed Structures," only three unknowns can be determined in any system of non-concurrent forces. Some assumption must then be made regarding the relation between certain of these forces before a solution can be made. It will be convenient in this case to consider the relation between the horizontal components of the forces at *A* and *B*. The desired relation can be obtained from a principle brought out in the analysis of statically indeterminate structures which states that where there is more than one path over which the stresses due to a given load may pass in order to reach the abutments or points of support, the load will be divided over these paths in proportion to their relative rigidities. It is reasonable to assume in this case that the loads are transmitted from the truss to the columns and thence to the points of support. As the columns are generally made alike, and are therefore of equal rigidity, it is usually assumed that the horizontal components of the applied loads are equally divided between the two points of support. Thus, if *H* be the horizontal component of *R*, we have

$$H_1 = H_2 = \frac{H}{2} \quad (1)$$

where H_1 and H_2 represent the horizontal components of the reactions at *A* and *B*, Fig. 61 (a). The vertical components of the reactions, shown by V_1 and V_2 in Fig. (a), can be determined by moments. Thus in general terms, we have from moments about *B*

$$V_1 = \frac{Rb}{l} \quad (2)$$

and from moments about A

$$V_2 = \frac{Ra}{l} \tag{3}$$

The reactions are thus completely determined.

Before proceeding to the determination of the stresses in the truss members, it will be necessary to consider the conditions existing in the columns. As shown in Fig. 61 (a), the horizontal forces are carried to the points of support by means of a vertical member. As the loads act at right angles to the member, it is sub-

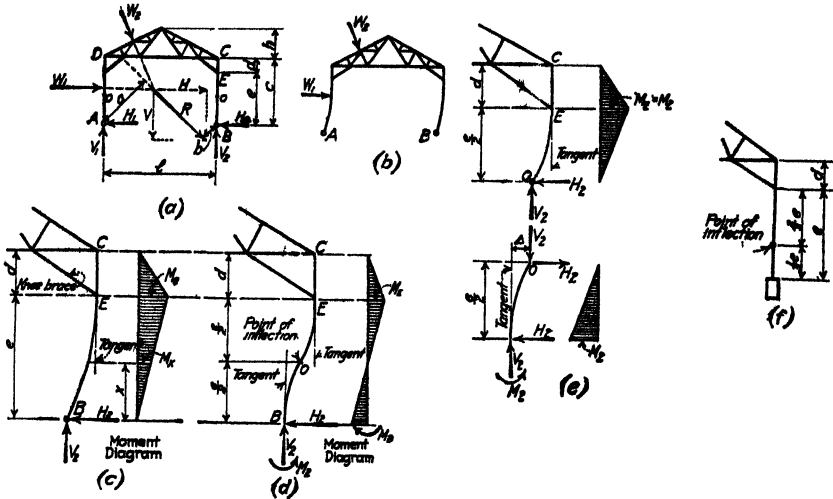

FIG. 61.

jected to bending as well as direct stress. The distortion of the structure as a whole is of the nature shown in Fig. 61 (b). In Fig. 61 (c) is shown, to an enlarged scale, one of the distorted columns. Since the column is riveted to the truss at point C , and to the knee-brace at point E , it seems reasonable to assume that $E-C$ remains vertical, and that the distortion of $E-B$ greatly magnified, is as shown in Fig. 61 (c). The column is then a three force piece, as it is subjected to bending moment, shear, and direct stress at all points. If M_x, V_x, S_x represent these quantities at any section a distance x above the base of the column, we have for member $B-E$ of Fig. 61.

$$M_x = H_2x \quad V_x = H_2 \quad S_x = V_2 \tag{4}$$

The moment, as given by the first of these expressions, is a maximum at point E , the foot of the knee-brace, varying uniformly to zero at the foot of the column, as shown by the moment diagram of Fig. (c). Values of the shear and direct stress for member $C-E$ depend on the stress in the knee-brace, which is as yet unknown.

In general the columns are rigidly fastened to the foundations by a detail of the type shown in Fig. 75. The distortion of the column is then of the nature shown in Fig. 61 (d). When the base is fixed, the tangent to the curve at point B can be assumed to be vertical. As the tangent at E is also vertical, the curva-

ture between the two points can be assumed to be a reversed curve, with the point of inflection, or change in curvature, at point *O*, half-way between *E* and *B*. Since a point of inflection is also a point of zero moment, the variation in moment for member *B-C* is as shown in Fig. 61 (*d*). The moment at *O* is zero, and the moments at points equal distances above and below *O* are equal in amount, but opposite in kind. It will be noted that the portion *O-E* of the deformed column of Fig. 61 (*d*) is similar to the portion *B-E* of Fig. 61 (*c*). Since the moment at *O* is zero, this point can be regarded as a hinged joint. In the determination of stresses the column can be separated into two parts at point *O*, as shown in Fig. 61 (*e*). The reactions, as given by eqs. (1), (2) and (3), are to be calculated for a knee-braced bent consisting of that part of the structure above points *O* of Fig. 61 (*a*). The moment at the base of the column can be determined from the conditions shown in Fig. 61 (*c*) for the lower portion of the column.

The position of the point of inflection has an important bearing on the stresses in the members. It can be seen from eqs. (1), (2), and (3) and from Fig. (*a*), that the values of the reactions depend upon the effective height of the bent. A fixed end bent, considered as hinged at *O*, midway between the knee-brace and the base, will in general have smaller stresses in its members than one with simply supported ends, considered as hinged at *A* and *B*. However, unless the connections at *E* and *C* of Fig. 61 (*d*) are absolutely rigid, and the base of the column is fixed, the point of inflection, *O*, cannot be assumed as located halfway between the base of the column and the foot of the knee-brace. Any tendency of the tangents to deviate from the vertical will cause the point of inflection to be lowered, the limit being points *A* and *B*, or a hinged connection at the base of the columns. Since the base of the column is usually rather wide in the plane of the truss, it can always be considered as partially fixed due to the action of the dead load. In most cases the column is firmly attached to the foundations by means of anchor bolts which are screwed up tight. As long as these bolts remain tight, the base of the column can be considered as fixed. But experience shows that this can not be relied upon. It seems best, therefore, to assume that the point of inflection is somewhat below the mid-point between the knee-brace and the base of the column. This assumption is on the safe side, as the stresses in the truss members are increased thereby, and the moment to be carried by the columns is also increased.

In the calculations to follow, it will be assumed that the distance from the base of the column to the point of inflection is one-third of the distance from the base of the column to the foot of the knee-brace, as shown in Fig. (*f*). There is considerable difference of opinion among designers and writers on this point. The recommendation made above seems to be reasonable and to be founded on conditions which actually exist in the structure; it will therefore be adopted.

Methods of stress calculation are best explained by means of a problem. For this purpose, a truss of the form considered in the preceding chapter will be placed on columns and provided with knee-braces. Figure 62 shows the dimensions of the knee-braced bent thus formed. The wind pressure on a vertical surface will be taken as 20 lb. per sq. ft., and that on an inclined surface will be 20 lb. reduced by the Duchemin formula, which is given in Art. 15. Since the assumed conditions are the same as for the design given in the preceding chapter, the wind panel load normal to the roof surface is 1,565 lb., as calculated in Art

34. The total horizontal load on the side of the structure above the point of inflection is $15 \times 15 \times 20 = 4,500$ lb. This load is distributed to the vertical panel points as shown in Fig. 63 (a). It will be assumed that the bases of the columns are partially fixed, and that the point of inflection is located at a point above the base of the column equal to one-third of the distance between the base and the foot of the knee-brace, as shown in Fig. 62. Figures 62 and 63 (a) show

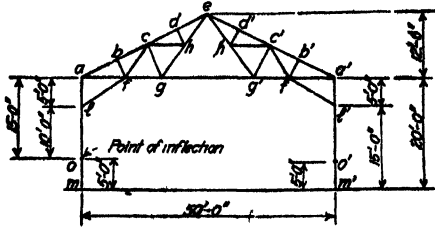

FIG. 62.

the portion of the bent above the assumed points of inflection, with the applied loads in position.

The reactions at the points of inflection, O and O' of Fig. 62, assumed to be points of support for a hinged knee-braced bent, can be calculated by the methods given in the volume on "Stresses in Framed Structures." From Fig. 63 (a), the total horizontal component of applied loads is $4,500 + 6,260 \sin 26^\circ 34' = 4,500 + 6,260 \times 0.447 = 4,500 + 2,800 = 7,300$ lb. The horizontal components of the reactions, as determined from eq. (2), are

$$H_1 = H_2 = \frac{H}{2} = \frac{7,300}{2} = 3,650 \text{ lb.}$$

The forces act as shown in Fig. 63 (a). The vertical reactions are determined from moments about the bases of the columns, using eqs. (2) and (3). Thus for R_2 , from moments about O with dimensions and loads as shown on Fig. 63 (a), we have

$$R_2 = \frac{6,260 \times 20.71 + 4,500 \times 7.5}{50} = 3,260 \text{ lb.}$$

and

$$R_1 = \frac{6,260 \times 23.99 - 4,500 \times 7.5}{50} = 2,340 \text{ lb.}$$

These forces are shown in position on Fig. 63 (a). All external forces are thus completely determined.

The next step in the calculations is the determination of the stresses in the members of the truss. In general it will be found that graphical methods of stress determination are preferable for this purpose. Algebraic methods of stress calculation are somewhat more precise than graphical methods, but in the application of algebraic methods considerable time is consumed in the calculation of lever arms of loads and members. This is avoided by the use of graphical methods, and the results obtained are accurate enough for all practical purposes.

In the application of graphical methods to a knee-braced bent a little difficulty is encountered in the case of the columns. These members are subjected to shear, moment and direct stress, thus forming three force pieces. The graph-

ical methods given in the volume on "Stresses in Framed Structures" are applicable only to one force pieces—that is, members subjected either to tension or compression. Two methods can be employed for the graphical solution of the case under consideration: (a) The columns can be removed and in their place can be substituted a system of forces whose effect on the structure as a whole will be the same as that of the columns, and (b) since a moment can be considered as a force

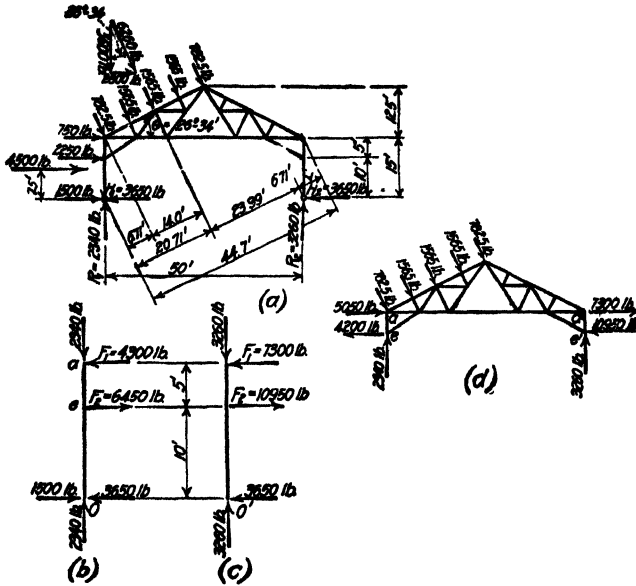

FIG. 63.

times a distance, a temporary framework can be added to the truss system, arranged so that the moment at the foot of the knee-brace will cause stress in the members of the auxiliary framework. After the stresses in all members of the truss have been determined, the temporary framework can be removed and the true stresses in the columns determined. The methods described above will now be applied to the knee-braced bent of Fig. 63 (a).

The application of the first method outlined above is shown in Figs. 63 (b), (c) and (d). Figures 63 (b) and (c) show the columns removed with all forces acting. Forces F_1 and F_2 show the action of the column on the truss. These forces are determined by the methods of statics, subject to the condition that the column is in complete equilibrium. From Fig. 63 (b), which shows the conditions for the windward column, moments about point e give

$$F_1 = (3,650 - 1,500) \frac{10}{5} = 4,300 \text{ lb.}$$

and moments about point a give

$$F_2 = (3,650 - 1,500) \frac{15}{5} = 6,450 \text{ lb.}$$

For the leeward column, shown in Fig. 63 (c)

$$F_1 = 3,650 \times \frac{10}{5} = 7,300 \text{ lb.}$$

and

$$F_2 = 3,650 \times \frac{15}{5} = 10,950 \text{ lb.}$$

All forces are shown in position in Figs. 63 (b) and (c).

Since action and reaction are equal in amount but opposite in direction, forces F_1 and F_2 are to be applied to the truss in directions opposite to those shown in Figs. 63 (b) and (c). They appear directly on the leeward side, but on the windward side they are to be combined with the loads shown at a and e of Fig. 63 (a). At a

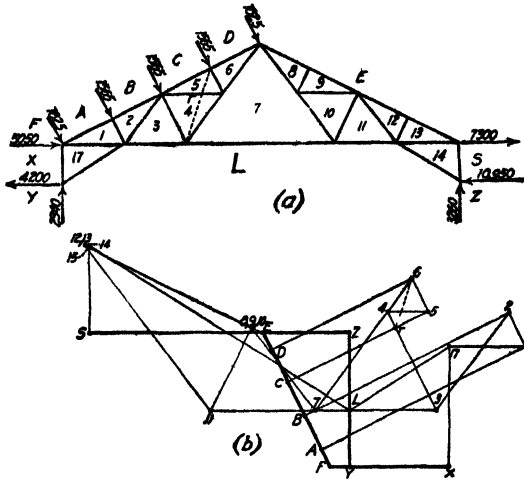

FIG. 64.—Knee-braced trusses.

the applied load is $4,300 + 750 = 5,050$ lb., and at e the load is $6,450 - 2,250 = 4,200$ lb. These forces are shown in position and direction on Fig. 63 (d). At the foot of the knee-brace, vertical forces equal to the reaction at the foot of the column are applied, as shown in Fig. (d). The resulting forces hold the structure in equilibrium.

Figure 64 (b) shows the stress diagram for the forces shown on Fig. 63 (d) and repeated on Fig. 64 (a). This stress diagram is constructed by the methods given in the volume on "Stresses in Framed Structures." The stresses in the members, as scaled from the diagram, are recorded in cols. 4 and 6 of Table 14, Art. 45. The stresses in the upper portion of the columns are given directly in the stress diagram. In the lower portions of the columns, the stress is equal to the reaction at the point in question, as given in Fig. 63 (d).

The temporary framework for the second method of stress determination outlined above is shown in Fig. 65 (a). Any convenient arrangement can be used. In this case the top chord member was prolonged to an intersection with a horizontal through the foot of the knee-brace. This point was then connected to the foot of the column by a temporary member. These members are shown by dashed lines in Fig. 65 (a). The loads applied to the windward side of the building are considered as acting at the joints of the auxiliary framework, as shown in Fig. (a). With the auxiliary framework in place, it is possible to draw the stress diagrams for all joints. Figure 65 (b) shows the complete stress diagram.

The stresses for the columns, as given by the stress diagram of Fig. (b), are not the true stresses for these members, for the addition of the auxiliary frames has affected the stresses in the columns; all other stresses are the true stresses in the members in question. To determine the true stresses in these members, the auxiliary frames must be removed and the column stresses redetermined,

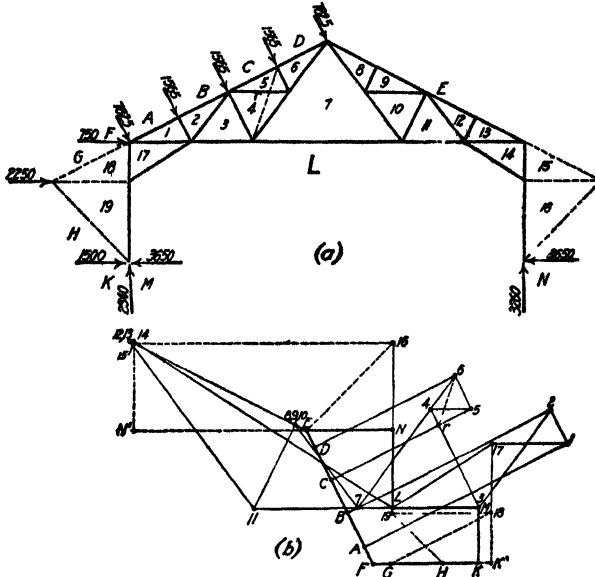

FIG. 65.—Knee-braced trusses.

subject to conditions which will be discussed later. Thus for the windward column it can be seen by inspection that as soon as the framework is removed, the stress in the lower section of the column is a compression which is directly equal to the reaction at the foot of the column, which in this case is 2,340 lb. Consider the upper portion of the column. It is quite evident that the stress in this member must be of such magnitude that it will hold in equilibrium the stress in the lower portion of the column plus the vertical component of the stress in the windward knee-brace. The desired stress can be determined from Fig. (b) by locating the forces mentioned and adding them graphically. In Fig. 65 (b), *K-M* represents the reaction at the foot of the column, and *L-17* represents the stress in the knee-brace. If these forces be projected on a vertical line drawn through point 17, we have as the sum of these forces the component *K'-17*, which represents the amount of the desired stress in the upper portion of the column; the stress as scaled from the stress diagram is 5,000 lb., and the kind of stress is compression. Similar methods are to be used for the leeward column. As before, the stress in the lower portion of the column is compression, and it is equal to the reaction at the foot of the column. Since the stress in the leeward knee-brace is compression, its vertical component acts downward. Therefore the stress in the upper portion of the column must balance the difference between the stress in the lower portion of the column and the vertical component of the stress in the knee-brace. The desired stress can be determined from Fig. 65 (b).

The force $L-N$ represents the reaction at the foot of the column, and $L-14$ represents the stress in the leeward knee-brace. If these forces be projected on a vertical line through point 14, the required difference in stress components will be represented by the force $N'-14$. The required stress scales 3,700 lb., and the kind of stress is tension.

On comparing the two methods given above, it will be found that the construction of the auxiliary frames required by the second method involves less time and is a simpler process than the calculation of the external forces required for the first method. The stress diagrams constructed for the two methods lead to exactly the same results, if the operations are correctly performed. However, it will be found that the stress diagram for the first method can be more accurately constructed than the one for the second method. This is partly due to the fact that the stress diagram of the first method contains four less joints than the one for the second method, and also to the fact that it is difficult to arrange an auxiliary framework which will provide good intersections for the lines of action of the resulting stresses. Again, the stresses in the columns are given directly by the stress diagram for the first method, but, from the discussion given above, it can be seen that the determination of the column stresses by the second method requires considerable care and study. Everything considered, the first method of calculation, as shown in Fig. 64, is preferable, and it is recommended as the best method of stress determination for problems of the nature here considered.

44. Conditions for the Design of a Knee-braced Bent.—To illustrate the principles of design for a knee-braced bent, a truss of the span length and type designed in the preceding chapter will be placed on columns and provided with knee-braces. The columns will be made 20 ft. high and the knee-brace will intersect the column at a point 5 ft. below the top of the column. Figure 62 shows the structure thus formed. The distance between the trusses will be taken as 15 ft., and the roof covering will be made the same as used in the design of the preceding chapter. In this way much of the material of the preceding design can be used for the structure under consideration. It is not probable that a shingle roof would be used in practice for a structure of this type. A corrugated steel or a slate or tile is a more practical type of roofing. However, the general principles of design are the same for all cases, and the discussion given in this chapter can readily be modified for any type of roof covering.

Loadings and working stresses will be the same as given in Arts. 29 and 31 of the preceding chapter, with the exception of the dead load of the trusses, which will be determined by the Ketchum formula given in the chapter on Roof Trusses—General Design.

$$\text{This formula is } w = \frac{P}{45} \left(1 + \frac{.L}{5\sqrt{A}} \right),$$

where P = capacity of truss, which will be taken as 40 lb. per sq. ft. of horizontal covered area; L = span in feet; A = distance between trusses, which will be 15 ft.; and w = weight of truss per sq. ft. of horizontal covered area. With the above values, $w = 3.18$ lb. To allow for that part of the bracing carried by the trusses, this weight will be increased to 4.25 lb. per sq. ft. of horizontal covered area. The

snow load will be taken 20 lb. per sq. ft. of roof surface, and the wind loads on the sides and the roof will be based on a unit pressure of 30 lb. per sq. ft. on a vertical surface. This unit pressure will provide for all possible wind stress conditions for a structure in an exposed position. If the structure is in a sheltered location, a unit pressure of 15 or 20 lb. per sq. ft. would be sufficient. The wind pressure will be assumed to act normal to the roof surface and perpendicular to the sides of the building.

Working stresses for steel in tension will be 16,000 lb. per sq. in. on the net section of the member. For compression the working stress will be given by the formula $16,000 - 70 \frac{l}{r}$ where l = greatest unsupported length of member, and

r = least radius of gyration of the section. Gross areas are used, and $\frac{l}{r}$ is limited to 125 for main members and to 50 for bracing. Corresponding working stresses for wind loadings will be based on 24,000 lb. per sq. in., as in the preceding chapter. Rivet values for shop rivets are to be based on an allowable shearing value of 10,000 lb. per sq. in., and an allowable bearing value of 20,000 lb. per sq. in.; corresponding values for field rivets are 7,500 lb. for shear and 15,000 for bearing. Rivets $\frac{3}{4}$ in. in diameter will be used. The minimum thickness of material will be $\frac{1}{4}$ in.

Members and connections subjected to a reversal of stress will be designed for each kind of stress. This assumption is reasonable, for the reversal in stress is due to a change in the direction of the wind. This can not occur suddenly, so that there will be a time interval between the two kinds of stress.

As stated in Art. 43, there is considerable uncertainty regarding the exact conditions at the bases of the columns. In many cases it is assumed that the point of inflection, shown in Figs. 62 and 63, is located half way between the base of the column and the foot of the knee-brace. This assumption requires rigid connections between the column and the knee-brace and a rigid connection between the column and the truss. Also, the base of the column must be rigidly attached to the foundations, which must be immovable. All of these conditions must be realized before the above assumption can be made. As it is practically impossible to secure all of these conditions, it does not seem advisable to assume that fixed end conditions exist. However, the end detail of the base of the column, as shown in Fig. 67, is so arranged that it is probable that the assumption of hinged ends is not justified, as the base is flat, and is fixed to some extent by the dead load. It therefore seems best to assume that the base is partially fixed, and that the point of inflection is somewhat below the mid-point of the column. In an excellent article on Wind Stresses in Steel Mill Buildings,¹ R. Fleming recommends that the point of inflection be taken at a point one-third of the distance between the foot of the column and the knee-brace. This recommendation has been followed in the solution of the problem of Art. 43, and will be adopted for the design to be made.

45. Determination of Stresses in Members.—The stresses in the members are to be determined for the same general conditions as in the design of the preceding chapter. In this case, however, it is not possible to use an equivalent uniform load to represent the effect of wind and snow combined. The stresses for these

¹ *Eng. News*, vol. 73, No. 5, p. 210, Feb. 4, 1915.

loadings must be determined separately and combined with the dead load for the following conditions: (a) dead load and snow load; (b) dead load and wind load; (c) dead load, minimum (one-half) snow load, and maximum wind load; and (d) dead load, maximum snow load, and minimum (one-third) wind load. In making up these combinations, the greater of the wind stresses given in cols. 4 or 6 of Table 14 is to be used. This will provide for all possible conditions. The maximum stress determined from these combinations is to be used in the design of the member. It will be noted that condition (b) often results in a reversal of stress in the member.

Since the adopted roof covering, the loading conditions, and the working stresses are the same as for the design of the preceding chapter, the dead panel load due to the roof covering and the purlins will be the same as given in Art. 34 of the preceding chapter. The panel load due to the roofing is then 945 lb., and that due to the purlin is 147.0 lb. As given above in Art. 44, the weight of the truss and bracing is 4.25 lb. per sq. ft. of horizontal covered area. From the preceding chapter, the horizontal covered area per panel is $15 \times \frac{5}{8} = 93.75$ sq. ft. The panel load due to the weight of the truss is then $93.75 \times 4.25 = 398.4$ lb. The total dead panel load is then $945.0 + 147.0 + 398.4 = 1490.4$ lb.; a load of 1,490 lb. will be used in the calculations to follow.

In the calculation of the stresses in the members of the knee-braced bent shown in Fig. 62, it is the usual practice to assume that the knee-braces are not stressed by the action of vertical loads. This assumption is not strictly correct, for the deflection of points f and f' is resisted by the knee-brace, which is thus subjected to a small stress. At the same time, a small bending moment is set up in the column. These stresses and moments are so small compared to the other stresses and moments that the stresses due to the deflection of points f and f' can be neglected. This is equivalent to removing the knee-braces and calculating the stresses in the remaining members. The stresses can then be determined by the methods used in Art. 34 of the preceding chapter. These stresses are given in col. 1 of Table 14.

The panel load due to snow will be the same as for the preceding design. As the area of the roof panel is $7 \times 15 = 105$ sq. ft., and the snow load is 20 lb. per sq. ft., the panel load is $20 \times 105 = 2,100$ lb. The snow load stresses are given in col. 2 of Table 14. These stresses can be calculated from the dead load stresses by multiplying by the ratio of panel loads, which in this case is $\frac{2,100}{1,490} = 1.41$. Since the conditions are the same as for the preceding design, the stresses in this case can be taken from Table 12 of Art. 34 of the preceding chapter. In col. 3 the stresses for minimum, or one-half snow load, are given.

The wind load stresses for the structure under consideration have been worked out in the problem given in Art. 43. As stated in Art. 44, the unit wind pressure is to be taken as 30 lb. per sq. ft. and the allowable working stress for wind loading is to be based on 24,000 lb. per sq. in. Since this working stress is $\frac{3}{4}$ that allowed for dead and snow loads, the wind pressure can be reduced by $\frac{1}{4}$, which gives a unit pressure of 20 lb. per sq. ft. A uniform allowable working stress of 16,000 lb. per sq. in. can then be used for all loadings. The wind pressure on the sides of the structure will be taken as 20 lb. per sq. ft., and that on the roof surface will be taken as calculated from the Duchenin formula which is given in Art. 15.

TABLE 14.—STRESSES IN MEMBERS

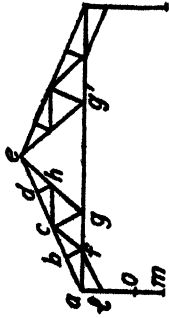

Member	Dead load (1)	Snow load (2)	Minimum snow load (½ S. L.) (3)	Wind left to right (½ W. L.) (4)	Minimum wind left (½ W. L.) (5)	Wind right to left (6)	Minimum wind right (¾ W. R.) (7)	D. L. + S. L. (8)	D. L. + wind (9)	D. L. + ¼ S. L. + wind (10)	D. L. + S. L. + ¼ wind (11)	Maximum stress (12)
ab	-11,660	-16,450	-8,225	-9,600	-3,200	+8,400	+2,800	-28,110	-21,260	-29,485	-31,810	-31,310
bc	-11,000	-15,500	-7,750	-9,600	-3,200	+8,400	+2,800	-26,500	-20,600	-28,350	-29,700	-27,700
cd	-10,330	-14,550	-7,275	-6,600	-2,200	+550	+185	-24,880	-16,920	-24,05	-27,060	-27,080
de	-9,860	-13,640	-6,820	-6,600	-2,200	+50	+185	-23,300	-16,90	-23,080	-25,500	-25,500
bf-dh	-1,335	-1,880	-940	-1,565	-525	0	0	-3,215	-2,900	-3,840	-3,730	-3,840
ef	-2,670	-3,760	-1,880	-4,580	-1,530	+3,900	+1,300	-6,480	+1,230	-9,130	-7,960	-9,130
f	0	0	0	+4,950	+1,650	-13,000	-4,340	0	+4,950	+4,950	+1,650	+4,950
af	+10,430	+14,700	+7,350	+3,220	+1,075	-220	-75	+25,130	+13,650	+21,000	+26,205	+26,205
fg	+8,940	+12,600	+6,300	+3,650	+1,220	-5,850	-1,950	+21,540	+12,590	+18,800	+22,760	+22,760
gg'	+5,940	+8,410	+4,205	-1,450	-485	-1,450	-485	+14,350	+4,480	+8,695	+13,865	+14,350
fe	+1,490	+2,100	+1,050	+5,050	+1,085	-8,750	-2,020	+3,590	+6,540	+7,590	+5,275	+7,590
ch	+1,490	+2,100	+1,050	+1,700	+570	0	0	+3,590	+2,190	+4,240	+4,160	+4,240
gh	+2,980	+4,200	+2,100	+5,120	+1,375	-4,350	-1,450	+7,180	+8,100	+10,200	+8,555	+10,200
he	+4,470	+6,300	+3,150	+6,850	+2,285	-4,350	-1,450	+10,770	+11,320	+14,470	+13,055	+14,470
eh	-5,960	-8,400	-4,200	-5,000	-1,670	+3,700	+1,235	-14,360	-10,960	-15,160	-16,030	-16,030
le	-5,960	-8,400	-4,200	-2,340	-780	-3,260	-1,090	-14,360	-8,300	-13,420	-15,450	-15,450
M _e ft.-lb.	0	0	0	21,500	7,170	36,500	12,170	0	36,500	36,500	13,170	36,500
M _m ft.-lb.	0	0	0	10,750	3,585	18,250	6,085	0	18,250	18,250	6,085	18,250

+ = tension. - = compression. All stresses given in pounds.

As the slope of the roof surface is 26 deg. 34 min. and the unit pressure is 20 lb. per sq. ft., the normal wind pressure is found to be 14.9 lb. per sq. ft. of roof surface. Since a complete solution of this problem is given in Art. 43, the work will not be repeated.

The wind stresses in the members as determined in Fig. 64 or 65 of Art. 43 are given in cols. 4 and 5 of Table 14. Minimum or one-third wind stresses are given in cols. 6 and 7. Table 14 also gives the values of the moments at the foot of the knee-braces. These moments are calculated from eq. (4) of Art. 43. For point *e* of the windward column, it can be seen from Figs. 62 and 63 (a) that the moment is $(3,650 - 1,500) \times 10 = 21,500$ ft.-lb., and for the leeward column, the moment at point *l* is $3,650 \times 10 = 36,500$ ft.-lb. Moments at the base of the column are also given. These moments are equal to the horizontal component of the reaction multiplied by the distance to the assumed point of inflection.

The combined stresses for the combinations of cases (a), (b), (c), and (d), as outlined above, are given in cols. 8, 9, 10, and 11 respectively. In col. 12 the greatest of these maximum values are tabulated.

46. Design of Members and Columns.—The general principles governing the design of the members of a knee-braced bent are the same as those used in the

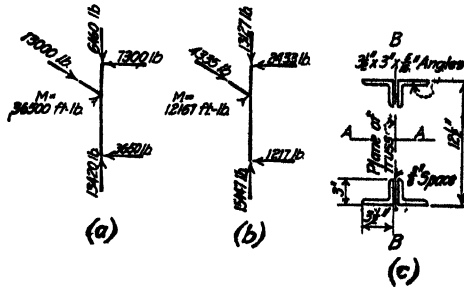

FIG. 66.

design of the preceding chapter. Table 15 gives all data required for the design. In the truss under consideration, a few of the members are subjected to a reversal of stress. Such members are to be designed to carry each of these stresses. The section will therefore be determined for the stress which requires the greater area. One member, *g-h*, is subjected to a small compression under certain conditions. The area required is determined by the tension in the member. However, since the member is likely to be called upon to carry compression, the limiting $\frac{l}{r}$ conditions must be met, which will probably determine the make-up of the section. Where a member is subjected to a large compression and a smaller tension, the compression area determines the required section. It is necessary, however, to examine the net area, in order to make certain that proper provision has been made for the tensile stress. The detailed design of a few of the members will now be taken up, and new points involved in the design will be discussed.

Member *l-f*, the knee-brace, is subjected to a tension of 4,950 lb., and to a compression of 13,000 lb.; the length of the member is 111.5 in. Try two 3½ × 3 × ¼-in. angles, placed with the 3½-in. legs separated by a ¼-in. space. The

least radius of gyration of these angles is 1.10 in.; the slenderness ratio is $\frac{l}{r} = \frac{111.5}{1.10} = 101.5$; the allowable working stress in compression is 8,900 lb. per sq. in.; and the area required is $13,000/8,900 = 1.46$ sq. in. Since the working stress in tension is 16,000 per sq. in., the net area required for the tension is $\frac{4,950}{16,000} = 0.309$ sq. in. The gross area of the assumed angles is 3.86 sq. in. and the net area, deducting one rivet hole from each angle, is 3.32 sq. in. These areas are considerably in excess of the required areas, but the value of the ratio $\frac{l}{r}$ for the assumed angles is 101.5, which is close to the maximum allowable. The section must therefore be used.

Member *g-h* is subjected to a tension of 10,200 lb., or to a compression of 1,370 lb. The area required for tension, which is $\frac{10,200}{16,000} = 0.638$ sq. in., will determine the design, but the member selected must conform to the limiting slenderness ratio conditions required for compression members. In this case it will be found that a section made up of the minimum angles will answer all requirements. Assume two $2\frac{1}{2} \times 2 \times \frac{1}{4}$ -in. angles, the minimum allowable, for which the least $r = 0.78$ in. For a length of member of 94 in., we find that $\frac{l}{r} = \frac{94}{0.78} = 120.5$, a value slightly less than the maximum allowable, but acceptable in this case. The net area of the assumed angles, deducting one rivet hole from each angle, is 1.68 sq. in. Although the area provided is somewhat in excess of that required, the section must be used in order to answer the $\frac{l}{r}$ conditions.

The design of the column and its base presents some new problems, which will be discussed in detail. As stated in Art. 44, the columns are three force pieces, which are to be designed for moment, shear, and direct stress. From Fig. 61 (a) and Table 14, it can be seen that the maximum moment conditions occur at the foot of the leeward knee-brace. Figure 66 shows the forces acting on the column for two conditions of loading. Figure 66 (a) shows the combined forces due to dead load, one-half snow load, and maximum wind load, and Fig. 66 (b) shows the conditions for dead load, snow load, and one-third wind load. Design methods similar to those developed in the preceding chapter for the design of the top chord will be used for the design of the columns. The area of the section will be determined by the moment and the direct stress, and the design of the details, such as the lacing and the riveting of the main angles, will be determined by the shear. The area of the section will be determined after which the details will be designed.

The loading conditions for which the column is to be designed are: (a) compression, 13,420 lb.; moment, 36,500 ft.-lb.; shear, 3,650 lb.; and (b) compression, 15,447 lb.; moment, 12,167 ft.-lb.; shear, 1,217 lb. In this case it will be best to assume a section, and then compare the area required as determined from eq. (3) of Art. 39 of the preceding chapter with the area furnished by the assumed section.

Assume a column section composed of four angles connected by lacing, arranged as shown in Fig. 66 (c). This section must be made quite wide in the plane of the truss, in order to resist the bending moments. It must have a

width along the axis *A-A* such that the allowable ratio $\frac{l}{r} = 125$ will not be exceeded, where *l* = one-half the total height of the column. This is founded on the assumption that the base of the column is flat and that it is rigidly fastened

TABLE 15.—DESIGN OF MEMBERS

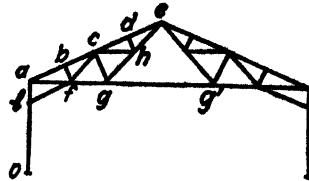

Member	Stress (lb.)	Length (in.)	Radius of gyration (in.)	<i>l</i> / <i>r</i>	Unit stress (lb. per sq. in.)	Area required (sq. in.)	Section (sq. in.)	Area provided (sq. in.)	
								Gross	Net
<i>ab</i>	- 31,310	84 0	1 10	76.5	10,650	2 94	2 in 3½ × 3 × ¾	3 86	
<i>bc</i>	- 29,700	2 in 3½ × 3 × ¾		
<i>cd</i>	- 27,080	2 in 3½ × 3 × ¾		
<i>de</i>	- 25,500	2 in 3½ × 3 × ¾		
<i>bf - dh</i>	- 3,840	42 0	0 78	53 9	12,230	0 314	2 in 2½ × 2 × ¼	2 12	
<i>cg</i>	{ - 9,130 + 1,230	84.0	0 78	107.8	{ 8,460 16,000	{ 1 08 0.078	2 in 2½ × 2 × ¼	2 12	1.68
<i>lf</i>	{ + 4,950 - 13,000	111.5	1 10	101 5	{ 16,000 8,900	{ 0 309 1.46	2 in 3½ × 3 × ¾	3 86	3 32
<i>af</i>	+ 26,205	16,000	1 64	2 in 2½ × 2½ × ¼	2 38	1.94
<i>fg</i>	+ 22,760	16,000	1.42	2 in 2½ × 2½ × ¼	2 38	1.50
<i>gg'</i>	+ 14,350	16,000	0.896	2 in 2½ × 2½ × ¼	2 38	1.50
<i>fo</i>	{ + 7,590 - 7,260	94.0	0.78	120.5	{ 16,000 7,570	{ 0.475 0.957	2 in 2½ × 2 × ¼ ✓	2 12	1.68
<i>ch</i>	+ 4,240	16,000	0.259	2 in 2½ × 2 × ¼	2 12	1.68
<i>gh</i>	{ + 10,200 - 1,370	{ 16,000 7,570	{ 0 638 0.181	2 in 2½ × 2 × ¼	2 12	1.68
<i>he</i>	+ 14,470	16,000	0.905	2 in 2½ × 2 × ¼	2 12	1.68

+ = tension. - = compression

to the foundations. It is also assumed that the top of the column is held in line by an eave strut, as shown in Fig. 75. If these conditions are not realized the full height of the column must be used. On the above assumption, the least allowable $r = \frac{1}{2} \times 20 \times \frac{1}{125} = 0.96$ in. Assume four 3½ × 3 × ¾-in. angles placed as shown in Fig. 66 (c). The radius of gyration for the axis *A-A* is found to be 5.53 in., and that for the axis *B-B* is 1.66 in. From eq. (3), Art. 39 of the preceding chapter, using the loadings given above, dimensions as given on Fig. 66 (c), and $f_c = 16,000 - 70 \frac{l}{r} = 16,000 - 70 \times 15 \times \frac{12}{5.53} = 13,720$ lb.

Case (a)

$$A = \frac{13,420}{13,720} + \frac{36,500 \times 12 \times 6.25}{16,000 \times 5.53^2} = 0.98 + 5.60 = 6.58 \text{ sq. in.}$$

Case (b)

$$A = \frac{15,447}{13,720} + \frac{12,167 \times 12 \times 6.25}{16,000 \times 5.53^2} = 1.13 + 1.87 = 3.00 \text{ sq. in.}$$

The section must also be investigated for column action in the plane of the axis A-A. Since $r = 1.66$ in., and $l = 20$ ft. = 240 in., $f_c = 16,000 - 70 \times \frac{240}{1.66} = 10,940$ lb. per sq. in., and the area required = $\frac{15,447}{10,940} = 1.42$ sq. in. The section is therefore ample, as the area provided is $4 \times 1.93 = 7.72$ sq. in. As the assumed section answers all conditions, it will be adopted.

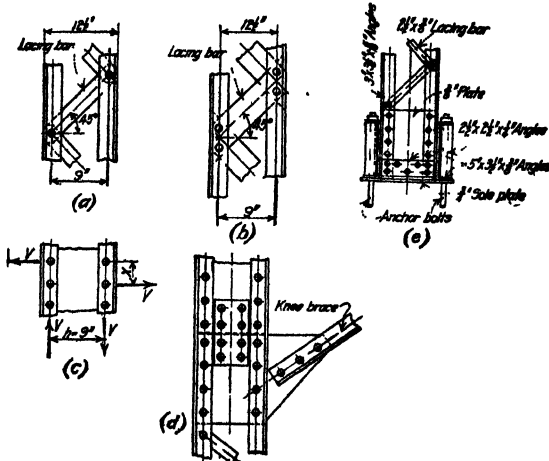

FIG. 67.

The arrangement of the lacing, or other connection, between the angles composing the column section, will depend upon the amount of shear to be carried. As shown in Fig. 66 (a), the maximum shear to be carried on the portion of the column below the knee-brace is 3,650 lb., and above the knee-brace, the shear is 7,300 lb. Assume that single lacing of the form shown in Fig. 67 (a) is to be used. Below the knee-brace, where the shear is 3,650 lb., the stress on a lacing bar is $3,650 \times \sec. 45^\circ = 5,710$ lb. The rivets will be shop rivets in bearing. In order to meet the requirements for bearing, the lacing bar must be $\frac{3}{8}$ in. thick; the rivet value will then be 5,625 lb., which is satisfactory.

The size of the lacing bar is determined by its strength as a column and as a tension member. Since the bar is held rigidly between the angles, the unsupported length, l , may be taken as half of the total length, or, as shown in Fig. 67 (a), $l = \frac{1}{2} \times 9 \times \sec. 45^\circ = 6.36$ in. Assuming the lacing bar to be a $2\frac{1}{2} \times \frac{3}{8}$ -in. section, the least radius of gyration is $r = \frac{d}{12} = 0.289$ $d = 0.108$ in., and $\frac{l}{r} = 58.8$. The allowable working stress is $16,000 - 70 \times 58.8 = 11,780$

lb. per sq. in., and the area required is $\frac{5,710}{11,780} = 0.49$ sq. in. The assumed section provides $2 \times 0.375 = 0.75$ sq. in. For a working stress of 16,000 lb. per sq. in. in tension, the area required is $\frac{5,710}{16,000} = 0.258$ sq. in. Deducting one rivet hole from the area of the section, the net area is $0.75 - 0.33 = 0.42$ sq. in. Since the assumed section is standard it will be adopted, although it is a little larger than required.

The stress in the lacing bars above the knee-brace will be $7,300 \times \sec. 45^\circ = 10,340$ lb. Two rivets will be required in the end of each lacing bar, as shown in Fig. 67 (b). In some cases a plate is used in place of the lacing bars. This is often done when more than one rivet is required in the end of each bar. Figure 67 (c) shows an arrangement of this kind. The plate is to be connected to the angles at intervals determined from the conditions shown in Fig. 67 (c), where V = shear on the section, which is 7,300 lb.; r = rivet value; and x = distance between rivets. Taking moments about a rivet, we have $rh = Vx$, from which, $x = \frac{rh}{V}$. Assuming a $\frac{3}{8}$ -in. plate, the rivets will be in bearing and will have a value of 5,625 lb. per rivet. Substituting these values in the above equation, $x = 5,625 \times \frac{9.0}{7,300} = 6.93$ in. In practice a spacing of about 4.5 in. would be used. Where the detail shown in Fig. 67 (d) is used, the web plate and the gusset plate should be connected as shown. As the web plate is assumed to carry shear only, two rows of rivets in the splice are sufficient. If the splice is to be designed for moment as well as for shear, the principles given in the section on Splices and Connections—Steel Members, in the volume on "Structural Members and Connections" must be used.

Figure 67 (e) shows a common detail for the base of a column where fixed or partially fixed end conditions are assumed. A sole plate, generally about $\frac{3}{4}$ in. thick, is riveted to angles fastened to the main angles of the column. Anchor bolts imbedded in the concrete or masonry foundations are placed between pairs of anchor angles. These bolts are tightened up against plate washers resting on top of the anchor angles. The anchor bolts are placed in the plane of the moment to be resisted. If the stresses are small, one bolt on each side of the base of the column is sufficient, but where large stresses are to be resisted, two bolts are used on each side.

The conditions for which anchor bolts are usually designed are shown in Fig. 68. Forces P and H are determined from Fig. 61 (e), which shows the portion of the column below the assumed point of inflection. The deflection Δ is so small compared to the other distances that it can be neglected. As shown in Fig. 68, the forces tend to tip the column about point A . Taking moments about A

$$M_o = Hh - \frac{Pd}{2}, \text{ where } M_o = \text{overturning moment.}$$

Anchor bolts are usually designed on the assumption that they resist all of the overturning moment. If t = distance from point A to the anchor bolt,

$$\text{Stress in anchor bolt} = \frac{M_o}{t} \quad (1)$$

In some cases t is taken as the distance between anchor bolts. No calculation of the compressive stress in the concrete or masonry under the base is made in this method. It is assumed that if the compressive stresses found by dividing the load to be carried by the area of the base is kept small, the added stresses due to overturning will not exceed allowable limits.

In Fig. 69 there is shown the conditions for an approximate analysis of the stresses in the anchor bolts and the compression on the foundations. The general principles upon which the method is based and the assumptions made are similar to those used in determining the bearing pressures on the base of a

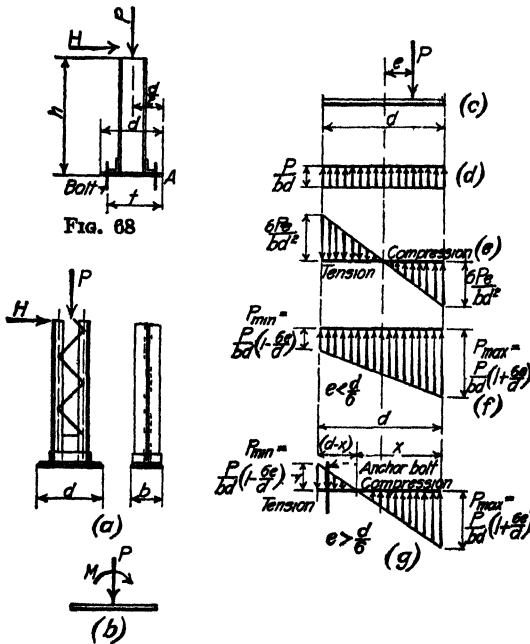

FIG. 69.

retaining wall. In the case under consideration the additional assumption is made that when the overturning moment is such as to cause tension on any part of the base, that tension is taken up by the anchor bolts.

Figure 69 (a) shows the lower portion of the column with forces in position as determined from Fig. 61 (e). The action of these forces on the base of the column can be represented by a moment M and a force P , as shown in Fig. 69 (b). These can be represented by the load P placed at a distance e from the center of the base, where

$$e = \frac{M}{P} \tag{2}$$

The stresses on the base can be divided into two parts; one part due to the effect of P , and the other due to M . These stresses are shown in Figs. 69 (d) and (e) respectively. The resultant stress on the base is the sum of these stresses, and is given by the expression

$$p = \frac{P}{bd} \left(1 \pm \frac{6e}{d} \right) \quad (3)$$

where the several terms have the values shown in Fig. 69.

It can be shown that if e , as given by eq. (2), is less than $\frac{d}{6}$, the stresses across the base are entirely compression, as shown in Fig. 69 (f), and where e is greater than $\frac{d}{6}$, tension exists on a part of the section, as shown in Fig. 69 (g). From similar triangles in Fig. 69 (g) it can be shown that the portion of the base covered by the compressive stresses is

$$X = \frac{d^2}{12e} \left(1 + \frac{6e}{d} \right) = \frac{d}{12} \left(\frac{d}{e} + 6 \right) \quad (4)$$

The unit compressive stress on the foundations is given directly by eq. (3). To determine the total tension in the anchor bolts, assume the total tension is taken by the anchor bolt. This tension, T , is represented by the volume of the tension stress diagram, which is

$$T = \frac{1}{2} P_{\max} \times (d - x)b = \frac{P}{2d} \left(6 \frac{e}{d} - 1 \right) (d - x)$$

$$T = \frac{Pd}{24e} \left(\frac{6e}{d} - 1 \right)^2 \quad (5)$$

For the case under consideration, it will be found from Table 14 and from Fig. 63 that $P = 13,420$ lb. and $M = 3,650 \times 5 = 18,250$ ft.-lb. = 219,000 in.-lb. These values occur in the leeward column.

The details of the column base are shown in Fig. 67. For a column section of the dimensions shown in Fig. 66, a sole plate 9 in. wide and 20 in. long will be required. These dimensions will be assumed for a trial section. From eq. (2),

$$e = \frac{219,000}{13,420} = 16.3 \text{ in.}; \text{ and from eq. (4), with } b = 9 \text{ in., and } d = 20 \text{ in.,}$$

$$x = \frac{20^2}{12 \times 16.3} \left(1 + \frac{6 \times 16.3}{20} \right) = 12.05 \text{ in.}$$

The maximum compressive stress on the foundation is given by eq. (3) as

$$p = \frac{P}{bd} \left(1 + \frac{6e}{d} \right) = \frac{13,420}{9 \times 20} \left(1 + \frac{6 \times 16.3}{20} \right) = 442 \text{ lb. per sq. in.}$$

Assuming a concrete foundation, this fiber stress is allowable, for the working compressive stress in concrete is usually given as 650 lb. per sq. in. The stress in the anchor bolt is given by eq. (5) as

$$T = \frac{Pd}{24e} \left(\frac{6e}{d} - 1 \right)^2 = \frac{13,420 \times 20}{24 \times 16.3} \left(\frac{6 \times 16.3}{20} - 1 \right)^2 = 10,480 \text{ lb.}$$

Since there is considerable initial tension in the anchor bolts due to the fact that they are screwed up tight when the structure is erected, and since the overturning of the column tends to add to the initial tension, it is best to specify low working stresses for anchor bolts. An allowable stress of 10,000 lb. per sq. in. will therefore be used. The required area of anchor bolt is then $\frac{10,480}{10,000} = 1.05$ sq. in. From the handbooks a 1 $\frac{1}{8}$ -in. round rod provides an area of 1.054 sq. in. at the root of thread.

Anchor bolts should be imbedded in the concrete to a depth such that the bond stress developed will equal the strength of the bolt. In this case 20 diameters of the bolt, or $27\frac{1}{2}$ in., will be required. If a plate is used connecting the ends of the bolts, as shown in Fig. 75, the imbedment need not be as great as calculated above. All details of the column base and anchorage are shown on the general drawing of Fig. 75

The method of analysis given above, while not exact, is accurate enough for all practical purposes. A more exact analysis can be made by taking into account the relative deformations of the steel anchor bolt and the masonry foundation. If the foundation is made of concrete, the method of analysis given for bending

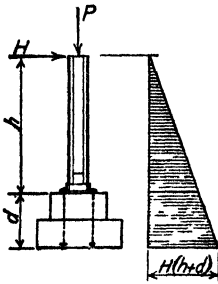

FIG. 70

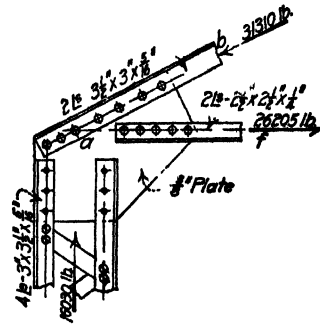

FIG. 71.

and direct stress in the volume on "Structural Members and Connections" can be used. By this method the stresses in the concrete will be found to be a little greater than those given above, and the stress in the anchor bolt will be slightly less than before.

The foundations for the columns are designed by the methods given in the section on Retaining Walls in the volume on "Reinforced Concrete and Masonry Structures." The total moment to be carried at the base of the foundation is $H(h + d)$ as shown in Fig. 70. Maximum pressures on the soil can be determined by the same principles as explained above for the case shown in Fig. 69. Equation (3) will give the desired pressures. By trial the width of base can be made of the width required to give the desired stresses.

47. Design of Joints.—The principles governing the design of the joints are the same as used in the preceding chapter. Field splices will be provided at joints g and e of Fig. 62. The columns will be field spliced to the truss at joint a , and the knee-brace will be field spliced at both ends. Field splices will also be placed at corresponding points on the right-hand side of the truss. From the shearing and bearing values given in Art. 44, the single shear value of a shop rivet is 4,420 lb., and the bearing value on a $\frac{3}{8}$ -in. plate is 5,625 lb. Corresponding values for field rivets are 3,310 and 4,420 lb., respectively. Where a member is subjected to tension and compression, the connecting rivets are to be determined for the greater stress.

All joints will be practically the same as for the truss designed in the preceding chapter, except joints f and a . At joint f the knee-brace must be connected to the gusset plate. As a field splice is to be provided and since the rivets are in

bearing on a $\frac{3}{8}$ -in. plate, the rivet value is 4,220 lb. The maximum stress in the knee-brace is 13,000-lb. compression, and $\frac{13,000}{4,420} = 3.08$ rivets are required; three will be used. To provide for these rivets the gusset plate at *f* will be enlarged, as shown on the general drawing, Fig. 75.

Figure 71 shows the conditions at joint *a*. Members *a-b* and *a-f* are connected by shop rivets, and the column is connected by field rivets. From Table 14, the maximum stress in the upper end of the column is 16,030 lb. Hence $\frac{16,030}{4,420} = 4$ rivets are required. Figure 71 shows 6 in place.

The conditions at the foot of the knee-brace, where it is connected to the column, are shown in Fig. 72. Three field rivets are required in the end of the knee-brace, the same number as calculated for this member at joint *f*. Two forms of connections to the column are shown in Fig. 72. In Fig. 72 (*a*) is shown a form used when the column is laced above and below the knee-brace. Extra rivets are used in the connection between the gusset plate and the column in order to secure a central connection for the knee-brace, thus avoiding excess stresses due to eccentric moments.

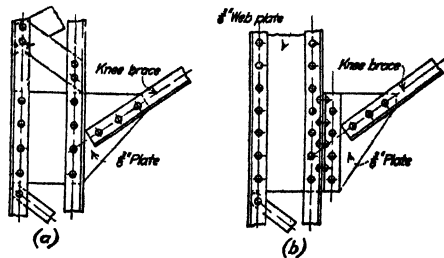

FIG. 72

Figure 72 (*b*) shows a detail in which a plate is used above the knee-brace because of heavy shears which cannot be provided for by means of lacing. In this detail the knee-brace is connected to the column by means of a pair of short angles riveted to the column angles. When the knee-brace is in tension, these rivets are subjected to a direct pull, and are in tension. From Table 14, the maximum tension in the knee-brace is 4,950 lb. As shown, 8 rivets are provided to take the component of the tension perpendicular to the column, which is $4,950 \times \frac{94}{111.5} = 4,160$ lb. The direct tension on each rivet is $\frac{4,160}{8} = 520$ lb., which can safely be carried by the rivets. Where large stresses in tension are to be carried by the rivets, turned bolts should be substituted for the rivets.

Figure 67 (*d*) shows another detail for this joint. It is a combination of the forms shown in Figs. 67 (*a*) and (*b*). As shown in Fig. 67 (*d*) the gusset plate and the web plate are connected by a small plate, by means of which the shear is transmitted across the joint. Where a web plate is used in Fig. 71 in place of lacing, a similar plate must be provided. In the case under consideration, the web plate is supposed to provide only for the shearing stresses. For large columns the web plate is often designed to carry moment as well as shear. The connection between web and gusset plate must then be designed for shear and moment.

48. Design of Girts.—It will be assumed that the sides and ends of the building are to be covered with corrugated steel backed with a suitable anti-condensation lining. The siding will be supported by girts composed of rolled sections. As

stated in Art. 44, the unit wind pressure will be taken as 20 lb. per sq. ft., and the working stress in the girts will be 16,000 lb. per sq. in.

The principles governing the design of the girts are similar to those given for the design of purlins in the chapter on Design of Purlins for Sloping Roofs. The girts are to be designed for a vertical load due to the weight of the girt and the siding and its lining, and a horizontal load due to the wind pressure. Corrugated steel of No. 24 gage will be used for the siding. From the data given in the chapter on Roof Trusses—General Design, the siding weighs 1.3 lb. per sq. ft., and the allowable safe span is 4.5 ft. It will be convenient in this case to divide the height of the building into six spaces, placing the girts $2\frac{2}{3} = 3$ ft. 4 in. apart. On the sides of the building the columns are spaced 15 ft. apart, and the wall area carried by each girt is $15 \times 3\frac{1}{3} = 50$ sq. ft. Assuming that the anti-condensation lining is composed of two layers of $\frac{1}{16}$ -in. asbestos paper and two layers of tar paper backed by poultry netting, all of which weighs about 1.3 lb. per sq. ft., the weight of siding and lining is $1.3 + 1.3 = 2.6$ lb. per sq. ft., and the total load per foot of girt is $2.6 \times 3.33 = 8.66$ lb. The wind load per foot of girt is $20 \times 3.33 = 66.7$ lb.

As shown in the chapter on Roof Trusses—General Design and in Fig. 75, girts are often made from channel sections placed with the web perpendicular to the siding, and they are attached to the columns by rivets in the flanges of the channel. When so placed, the discussion given in the chapter on Unsymmetrical Bending, in the volume on "Structural Members and Connections," shows that the channel presents its axis of least moment carrying capacity to the action of the vertical loads. To relieve the heavy bending stresses thus induced, tie rods can be used extending vertically to the eave strut, or running diagonally from the top girt to the upper ends of the columns. It is not always possible to use tie rods due to interference with openings in the walls for doors and windows. When tie rods are used it is reasonable to assume that the girt takes the horizontal load, and that the tie rods provide for the vertical loads. Two designs will be made, one with tie rods, and the other without tie rods, assuming the girt to be a beam under unsymmetrical loading.

Assuming that tie rods are used, and that the girt takes only the horizontal wind pressure, the total uniformly distributed load to be carried by a girt is $50 \times 20 = 1,000$ lb. The moment to be carried, assuming simple beam conditions, is $M = \frac{1}{8} Wl = 1,000 \times 15 \times \frac{1}{8} = 22,500$ in.-lb. For a working stress of 16,000 lb. per sq. in., the section modulus required is $\frac{I}{c} = \frac{M}{f} = \frac{22,500}{16,000} = 1.41$ in.³ If the least width of the section be limited to $\frac{1}{40}$ of the span in order to avoid excessive deflection, the minimum allowable girt section is a 5-in. 6.5-lb. channel section. The size of the tie rod can be determined by the methods given in the chapter on Design of Purlins for Sloping Roofs.

Consider now the case where tie rods are not used and the girt is subjected to unsymmetrical bending. Assume a 6-in., 8-lb. channel section as a girt. The total vertical weight of siding, lining, and girt is then $8.66 + 8.00 = 16.66$ lb. per ft. for each girt. As given above, the horizontal wind load per foot of girt is 66.7 lb. The resultant of these loads, as shown by the force diagram of Fig. 73, is 69.0 lb. Two cases will be considered, (a) moment due to resultant load of 69.0 lb. per ft. of girt, and (b) moment due to vertical loading. For case (a)

the moment to be carried is $69 \times 15 \times \frac{1}{8} = 23,280$ in.-lb., and $S_1 = \frac{M}{f} = \frac{23,250}{16,000} = 1.45$ in.³, and for case (b) $M = 16.66 \times 15^2 \times \frac{1}{8} = 5,630$ in.-lb., and $S_2 = \frac{5,630}{16,000} = 0.352$ in.³ These values of S_1 and S_2 are plotted in amount and direction to scale in Fig. 73 (b). In the same figure, the S-Polygon of a 6-in., 8-lb. channel is shown, constructed by the methods explained in the chapter on

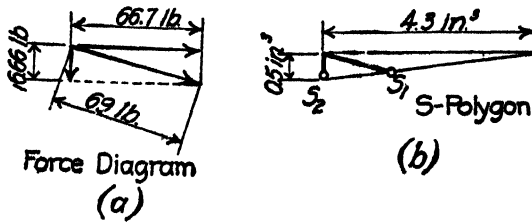

FIG. 73.

Unsymmetrical Bending in the volume on "Structural Members and Connections." Since the plotted values fall inside the S-line for the assumed channel, the section is satisfactory, and it will be adopted.

In practice, girt sections are used which are considerably smaller than the section arrived at in this design. Where theory and practice differ, as they do in the case under consideration, the designer must rely upon his experience and judgment in making a choice of the sections to be used for the girts. In this case, theory will be assumed to govern, and the adopted details will be as shown in Fig. 75.

49. Design of Bracing.—The design of the bracing will be governed by the adopted arrangement, which in turn is governed by the layout of the building. A general discussion of the form of bracing for buildings composed of knee-braced bents has been given in Art. 9.

To illustrate the general methods for the design of the bracing of a knee-braced building, it will be assumed that the structure under consideration in this chapter consists of 7 bays of 15 ft. each, as shown in Fig. 74. Two arrangements of bracing are shown in Fig. 74. In Fig. 74 (a) (b), and (c) the framing for the end of the building consists of vertical posts to which the girts are attached. Bracing in the plane of the top chord, the bottom chord, and the planes of the columns is provided for two pairs of trusses. Wind loads from the ends of the building are brought to the lateral trusses by means of rigid bracing. Unbraced bents are connected by means of a line of struts at points g and g' of Fig. 62, by struts at the eaves, and by a line of struts at the ridge.

Figures 74 (e), (f), and (g) show an arrangement wherein knee-braced bents are placed at the ends of the building. These end bents are made the same as the others, so that future extensions in the length of the building are readily made. The figures show the position of the other bracing. As the design methods for the two arrangements are similar, detailed calculations will be given only for the arrangement of Figs. 74 (a) to (d) inclusive. Both of the arrangements for end bracing shown in Fig. 74 are used in practice. The arrangement of Figs. 74 (a) to

(c) is probably cheaper than the one shown in Figs. 74 (e) to (g), for in the first arrangement all of the members are simple beams composed of rolled sections, such as I-beams or channels. Very little shop work is required on these members. In the second arrangement, the same amount of shop work is required as for the other knee-braced bents, for all are made alike. This shop work costs several times as much as that for the first arrangement. The ease with which the

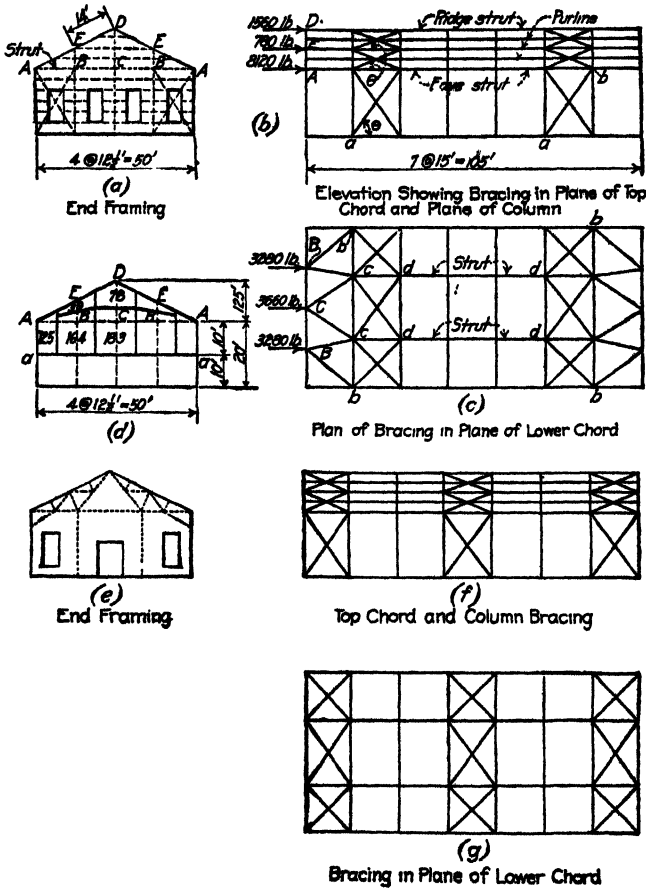

FIG. 74.

building can be extended is about the same in both cases. When the entire end of the building is to be opened at certain times, the second arrangement is preferable.

In general the design of the bracing for a structure composed of knee-braced bents consists in the determination of the wind loads applied to the sides and ends of the building, and in the provision of bracing of suitable size so located as to transmit the applied loads to the foundations of the structure. The knee-braced bents provide the proper resistance to wind on the sides and roof of the structure. Provision for these loads has already been made in the design of the preceding

articles. In the first arrangement shown in Fig. 74, diagonals placed in the plane of the ends of the structure provide for the loads not carried directly by the knee-braced bents. All wind loads applied to the ends of the building are provided for by the bracing shown in Figs. 74 (b) and (c), or in (f) and (g).

In the arrangement of end framing shown in Fig. 74 (a), the siding and girts are carried by vertical I-beams supported by the foundation at the base; by a member running across the end of the building at the height of the eaves, shown by the dashed line from A to A ; and by a rafter at the roof line. These beams are to be designed to carry the wind loads brought to them by the siding. The dead load effect, which is a vertical load, is small and can be neglected. As shown in Fig. (a), the end of the building is divided into four equal parts of 12.5 ft. each by vertical beams. Considering each vertical member as a simple beam supported by the foundation and the strut $A-A$, the effective span is 20 ft. If the reduced wind loading of 20 lb. per sq. ft. is used, the load to be carried per foot of vertical height is $20 \times 12.5 = 250$ lb., and the bending moment is $M = \frac{1}{8} wl^2 = \frac{1}{8} \times 250 \times 20^2 \times 12 = 150,000$ in.-lb. For a unit stress of 16,000 lb. per sq. in., which corresponds to the reduced wind load of 20 lb. as stated in Art. 44, the section modulus required is $\frac{I}{c} = \frac{M}{f} = \frac{150,000}{16,000} = 9.38$ in.³ From the steel handbooks, a 7-in., 15-lb. I-beam is required. The same section will be used for all members. The rafter $A-E-D$ is designed by similar methods, using the total load to be carried by the roof.

The exact distribution of the wind load brought to the end of the building between the bracing in the plane of the roof and the plane of the lower chord is indeterminate. It will be assumed that the load on the lower half of the building is carried directly to the foundations. In Fig. 74 (d), the area under consideration is that below the line $a-a$. The balance of the loads will be assumed as carried at points A , B , C , D , and E in proportion to the areas tributary to these points. Figure 74 (d) shows the assumed distribution of areas. The numbers show the areas tributary to the several points. At 20 lb. per sq. ft., the loads brought to the several points are as shown on Figs. 74 (b) and (c). The load of 1,560 lb. at the apex of the truss is assumed to be carried along the ridge strut to the two sets of bracing in the plane of the top chord. If this bracing be assumed to be composed of members capable of carrying tension only, there are four members in position to take the load. The stress in each member is then $\frac{1}{4}(1,560) \sec \theta$ where $\theta =$ angle which the member makes with the direction of the wind. In this case the panels of bracing extend over two panels of the top chord, of 14 ft., and the trusses are 15 ft. apart. Therefore, $\sec \theta = \frac{(14^2 + 15^2)^{\frac{1}{2}}}{15} = 1.37$.

The stress in the members of the upper panel of bracing is then $1,560 \times \frac{1.37}{4} = 535$ lb.

The bracing in the lower panels of the top chord bracing must carry the loads at points E and D of Fig. (a), or $1,560 + 780 + 780 = 3,120$ lb. As before, four members carry this load, and the stress in each member is $3,120 \times \frac{1.37}{4} = 1,070$ lb.

The stresses in the bracing, as calculated above, are all very small. A single $2\frac{1}{2}$ - \times -2- \times - $\frac{1}{4}$ -in. angle, the minimum allowable under the conditions of Art. 43, is sufficient for all members. The details of the bracing are shown in Fig. 75.

The loads acting on the bracing in the plane of the lower chord are shown in Fig. 74 (c). These loads are distributed to the bracing by means of struts connecting points *B*, *C* and *b*, *c*. As the loads are small, the size of the struts will be determined by $\frac{l}{r}$ conditions. The length of strut *Bb* is $(12.5^2 + 15^2)^{\frac{1}{2}} = 19.5$ ft. As the stresses are very small it is reasonable to allow a maximum value of $\frac{l}{r} = 175$. Then $r = 19.5 \times \frac{12}{175} = 1.34$ in. From the steel handbooks two 4- \times -3- \times

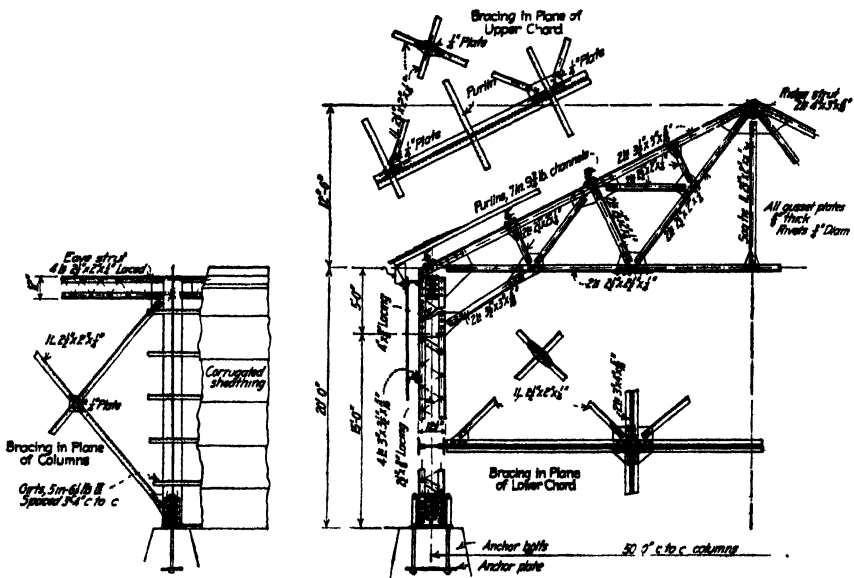

FIG. 75.—General drawing of knee-braced roof truss.

$\frac{1}{2}$ in. angles with the 4-in. legs separated by a $\frac{3}{8}$ -in. space have an *r* of 1.3 in. This section is considerably larger than the one used in practice. For the same reasons as given at the close of Art. 43, the above design will be adopted, as shown in Fig. 75.

The load at points *c* of Fig. 74 (c) is brought to this point from joints *B* and *C* by the struts *Cc* and *Bc*. From the conditions at points *C*, it can be seen that the two struts *Cc* each have a component of stress parallel to the load which is equal to one-half of the load. Similar conditions hold for struts *Bb* and *Bc* at joint *B*. Therefore the load brought to point *C* is $\frac{1}{2} (3,660 + 3,280) = 3,970$ lb. Assuming that the diagonals carry tension only, and that the loads are carried by the diagonals in both sets of bracing, the stress in members *b-d* is $\frac{1}{2} \times 3,970 \times \sec \theta = 3,180$ lb. The minimum section, which is a $2\frac{1}{2}$ - \times -2- \times - $\frac{1}{4}$ -in. angle, will furnish sufficient area. The lines of struts connecting the two panels of bracing

in the plane of the lower chord will be made of the section as used for struts Cc , etc.

Figure 74 (b) shows the bracing in the plane of the columns. All of the wind load above the line $a-a$ of Fig. (d) must be carried to points A , and thence by the eave strut to the two panels of bracing. As shown in Fig. (b), the load to be carried by each set of column bracing is 8,120 lb. Assuming that members take tension only, members $a-b$ each have a stress of $\frac{1}{2} \times 8,120 \times \sec \theta = 7,650$ lb. A $2\frac{1}{2} \times 2 \times \frac{1}{4}$ -in. angle will provide sufficient area. In some cases rods are used in place of rolled sections. When rods are used they are fastened to a gusset plate by means of a clevis. Some designers consider rods preferable to rolled shapes because the erection in the field is somewhat simpler than for riveted joints.

The eave strut, shown in Fig. 75, is composed of four angles laced to form a rigid member. As a rule these members are not designed for any definite stress, but are made up to answer $\frac{l}{r}$ conditions.

Complete details of the structure designed in the preceding articles are given on the general drawing of Fig. 75.

ARCHED ROOF TRUSSES

50. Form of Arch Trusses.—Roof trusses of the type designed in the preceding chapters do not in general provide an economical structure for spans exceeding 100 ft. A more economical type of roof truss for long span trusses is provided by the arch type. As stated in Art. 1 of the chapter on Roof Trusses—General Design, an arch is a type of framed structure in which the reactions at the supports are inclined to the vertical for all conditions of loading.

Arches used for roof trusses are usually classified according to the method of supporting the structure, and according to the type of framing. As arches are commonly supported at the abutments by means of pins, which are known as hinges, the method of supporting the arch is designated by the number of hinges used. In Fig. 76 (a) is shown a type of arch which is rigidly fastened to the abutments without the use of hinges. This is known as a hingeless arch. Figure 76 (b) shows a type in which two hinges are used, one at each abutment. This is known as a two-hinged arch. In many cases a third hinge is provided at the crown of the arch, as shown in Fig. 76 (c). This is known as a three-hinged arch.

In general, two types of framing are used for arched roof trusses. A very common type consists of a trussed framework of the form shown in Fig. 76 (d). This type is known as a braced arch. The type shown in Fig. 76 (e) is a plate girder form, which is known as a ribbed arch.

An arched roof truss is generally designated by a combination of the two classifications given above. Thus Fig. 76 (d) shows a *two-hinged braced arch*. Other classifications are in use, but the one described above is widely used, and is comparatively simple.

A great variety of arch trusses have been used in building construction. Many of these structures are described in architectural and engineering periodicals. Examples of arches of the several types given above will be shown and the relative advantages of the several types will be discussed. In general it can be said that

an arch truss requires rigid and practically unyielding abutments, since arches, with the exception of the three-hinged type, are statically indeterminate, and any yielding of the supports will result in large changes in the stresses in the members.

Hingeless arches supported directly on the abutments, as shown in Fig. 76 (e), are seldom used in building construction. This type of arch requires absolutely rigid supports, a condition which is difficult to realize in practice. In framing the roofs for some of the recent large terminal railway stations, arch trusses are used which are riveted to heavy columns. As the columns are very heavy, they form

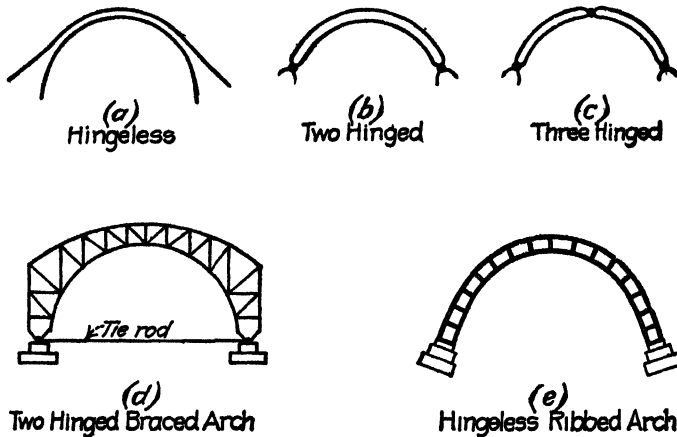

FIG. 76.

practically a rigid support for the arch, which can therefore be assumed as a hingeless arch.

The two-hinged type of arch is used to great advantage where a comparatively rigid structure is desired—as, for example, where floors are to be supported over a large drill hall or auditorium. This type of construction is used in the Armory and Gymnasium of the University of Wisconsin. Figure 77 shows a cross-section of the building and the general outline of the arch trusses.

Two-hinged arches require rigid supports, but, due to the fact that hinges are supplied at the supports, the moment at these points is zero. Hence the abutments can be designed for direct thrust only. If the foundation conditions are uncertain, or if the points of support are considerably above the ground level, as shown in Fig. 77, the horizontal components of the reactions can be taken by means of a tie rod which connects the two end hinges. In Fig. 77, this tie rod is placed just under the floor. Where tie rods are used, it is usual to anchor one end of the arch to the abutments, and to place the other end on sliding plates or on rollers. In this way the abutments can be designed to take up the vertical loads, and the tie rod can be designed to take up the horizontal forces.

Three-hinged arches are somewhat more flexible than arches of the other types and are used advantageously for structures in which only a roof load is to be carried. Arches of the three-hinged type are statically determinate—that is, all stresses can readily be determined by the methods of simple statics. In this respect they have a great advantage over the other types, as the work required in stress calculation is greatly simplified.

Many three-hinged arches of long span have been constructed in recent years for use in drill halls, auditoriums, and exposition buildings. A typical three-hinged arch construction is used in the drill hall at the University of Illinois. This structure is described in the *Eng. News* for Dec. 11, 1913, p. 1182. Figure 78 shows the form and general dimensions of the arches.

In buildings in which a large floor is surrounded by galleries, the members of the arch frame interfere with free passage along the gallery, as shown in Fig.

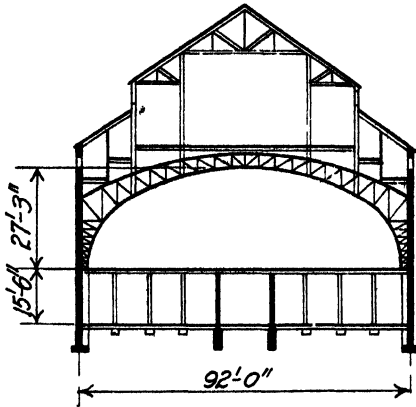

FIG. 77.—Section of gymnasium and armory, University of Wisconsin.

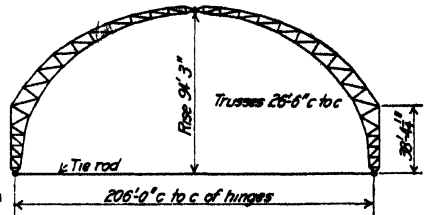

FIG. 78.—Drill hall, University of Illinois.

79. This difficulty has been avoided in certain structures by placing the arch on cantilever brackets above the gallery level. A structure arranged in this manner is described in *Eng. News*, vol. 63, no. 18.

The spacing of arch trusses to be adopted in a given structure should be rather wide. Since in general the trusses are quite heavy, and since considerable shop work is required, the cost of the trusses per square foot of covered area is large. Therefore, to obtain economical conditions a wide spacing of trusses must be used, as shown by the discussion given in the chapter on Roof Trusses—General Design. In general, a truss spacing of from 25 to 40 ft. is used. This spacing requires the use of framed trusses between the arches. These trusses act as purlins, and also form part of the bracing required for the arches. The design of the purlins and the roof covering is carried out by the methods used in the preceding chapters.

The shape of an arch truss is generally determined by the architectural features of the structure. From the standpoint of the structural designer, it is desirable that the adopted form of the arch be one that can readily be laid out. This assists greatly in the preparation of the stress diagrams and the working drawings. A form of arch whose outline is composed of circles, or a combination of circles, is desirable from this standpoint.



FIG. 79.

Suppose that in a given case it has been decided that an arch composed of circles is to be formed to pass through the points *A*, *B*, *C*, *D*, and *E* of Fig. 80. Suppose further, that *AB* is a single arc, and that *EC* is composed of two arcs

which are tangent at *D*. Formulas for the determination of the required radii will now be given. These formulas are all based on propositions given in plane geometry, to which the reader is referred for proofs.

From plane geometry, the formula for the radius of a segment of a circle, for which the chord and the rise or mid-ordinate are known, is

$$\text{Radius} = \frac{(\frac{1}{2} \text{ chord})^2 + (\text{rise})^2}{2 \times (\text{rise})}$$

As stated above, *AB* is the arc of a circle. Figure 80 shows that $\frac{1}{2}$ chord = *AK*, and rise = *BK*. These distances can be scaled from a layout of the arch, or calculated from given data. Hence

$$R = \frac{(AK)^2 + (BK)^2}{2BK}$$

In the same way, the radius of the arc *DC* is

$$R_1 = \frac{(DL)^2 + (CL)^2}{2CL}$$

Since arcs *DC* and *DE* are tangent, the center for arc *DE* lies at *G*, a point on radius *DF*. The value of *R*₂ can be calculated by methods similar to those used above.

In general, the rise of the arc *ED* is so small that it can not be scaled with sufficient accuracy. However, by measuring the vertical and horizontal projections of the arc *DE* and the angle α included between the radius *DF* and the vertical, easily measured distances are obtained. For the distances given in Fig. 80, it can be shown that

$$R_2 = \frac{1}{2} \frac{(EM)^2 + (MD)^2}{MD \cos \alpha - EM \sin \alpha}$$

Many different arrangements of web members are used in framing a braced arch. Two common methods are shown in Fig. 80. In Fig. 80 (a) the web struts are placed on the radii of the chord members. In some cases the radii of the top chord are used; in others the radii of the lower chord are used; and in a third case the radii of an arc half way between the two chords are used. Figure 80 (b) shows a case in which these members are placed in a vertical position.

In Figs. 80 (a) and (b), the other web members are placed at about 45 deg. to the struts. The panel lengths are usually arranged so that this is possible.

The adopted arrangement of truss members will depend to some extent on the type of roof framing which is to be used. If the purlins are seated on the top of the upper chord members, either arrangement can be used. In general this implies comparatively close truss spacing so that rolled shapes can be used as purlins. If deep trussed purlins are used, it is desirable that they be placed in a vertical position. Hence a framing with vertical members is best adapted to this construction.

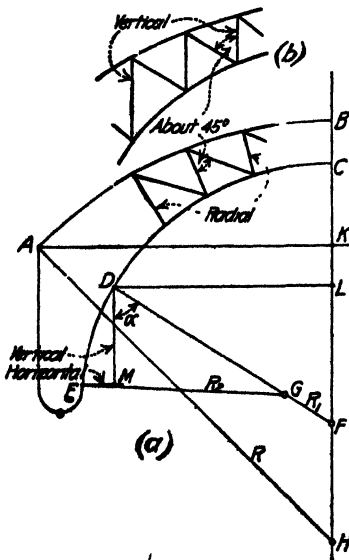

FIG. 80.

51. General Methods for Determination of Reactions and Stresses.—The several types of arch trusses will be considered in the order determined by the difficulties encountered in the determination of the reactions. This order is (a) three-hinged arches, (b) two-hinged arches, and (c) hingeless arches.

The calculation of reactions and stresses in arch structures can be made either by algebraic or by graphical methods. In general, graphical methods will be found preferable, for the calculation of the lever arms of members and forces in the algebraic method requires considerable time. However, in many cases

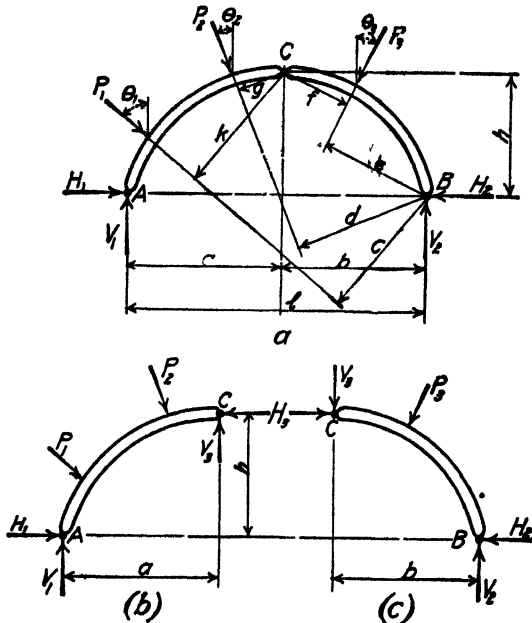

FIG. 81.

these lever arms can be scaled with sufficient accuracy from a large scale drawing of the truss. Under such conditions, the two methods require about the same amount of time. In the work to follow, algebraic and graphical methods will be given for the solution of reactions and stresses.

51a. Three-hinged Arches. Algebraic Solution for Reactions.—Let Fig. 81 represent a three-hinged arch acted upon by loads P_1 , P_2 , and P_3 . It will be assumed that the points of support, A and B , are on the same level. The reactions at A and B can be represented by two forces at each point. Let H_1 , V_1 , and H_2 , V_2 represent these forces, assumed to act as shown.

At first sight, the problem is indeterminate, for there are four unknown forces present, and as stated in the chapter on Principles of Statics in the volume on "Stresses in Framed Structures," only three unknowns can be determined in any system of non-concurrent forces. However, the introduction of a hinge at the crown, point C of Fig. 81, reduces the moment at this point to zero. This can be made the basis of an independent moment equation. This equation, together with three equations derived from the conditions of equilibrium, gives rise to

four independent equations from which the reactions can be completely determined.

In applying the four independent equilibrium conditions stated above to the determination of the reactions for the conditions shown in Fig. 81, it will be found convenient to use moment equations about A and B , considering the structure as a whole. Thus from moments about B equal zero, we have

$$V_1 l - P_1 c - P_2 d - P_3 e = 0$$

from which

$$V_1 = \frac{P_1 c + P_2 d + P_3 e}{l}$$

In general terms, this can be written

$$V_1 = \frac{\Sigma P x_B}{l} \quad (1)$$

where P = any load, x_B = distance from moment center B to this load, and l = span length. The value of V_2 is given by a similar moment equation about point A , from which

$$V_2 = \frac{\Sigma P x_A}{l} \quad (2)$$

where x_A is the distance moment center A to any force P .

On separating the structure at the crown, as shown in Figs. 81 (c) and (b), and writing a moment equation about point C for the forces on the left of the point, as shown in Fig. 81 (b), we have

$$+ V_1 a - P_1 k - P_2 g - H_1 h = 0$$

from which

$$H_1 = \frac{V_1 a - P_1 k - P_2 g}{h} \quad (3)$$

In the same way, moments about C for loads on the right side of the crown, as shown in Fig. 81 (c) gives

$$+ V_2 b - P_3 f - H_2 h$$

from which

$$H_2 = \frac{V_2 b - P_3 f}{h} \quad (4)$$

If a check on the calculated values is desired, it can be obtained by summation of vertical and horizontal forces for the structure as a whole, from which

$$V_1 + V_2 = \Sigma P \cos \theta$$

and

$$H_1 - H_2 = \Sigma P \sin \theta$$

where P is any load and θ is the angle between the line of action of this load and the vertical. Equations (1) to (4) are general, and can be applied to any loading conditions.

In calculating the stresses in the members of the arch, the forces acting on the crown hinge must also be known. These forces can readily be calculated for the conditions shown in Figs. 81 (b) and (c) as soon as the reactions at A and B are known.

Graphical Solution for Reactions.—Graphical solutions are based on the fact that zero moment at any point indicates that the resultant of the forces on either

side of the point must pass through the point in question. Since the equilibrium polygon for any set of forces represents the action line of resultants on either side of a point, and since hinges are assumed to be points of zero moment, it follows that the equilibrium polygon drawn for the loads on any three-hinged arch must be made to pass through the three hinges. The solution of this problem therefore consists in passing an equilibrium polygon through three given points. Several typical cases will now be considered in detail.

The work which follows is based on the principles of graphic statics given in the chapter on Principles of Statics in the volume on "Stresses in Framed Structures." Therefore, construction methods for the several cases will be explained, but, in general, proofs will not be given for these methods.

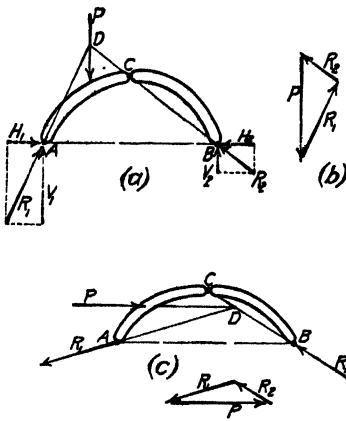

FIG. 82.

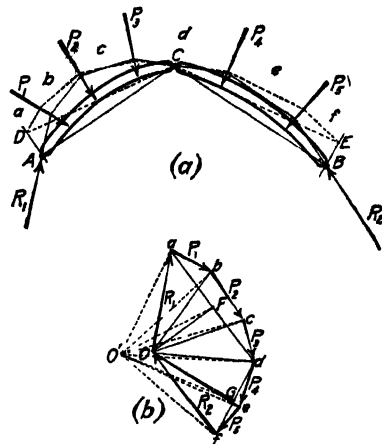

FIG. 83.

Single Load on One Arm of Arch.—Figure 82 (a) shows a single vertical load on one arm of a three-hinged arch. Since there is no load on the right-hand arm of the arch, and since, as stated above, the line of the resultant forces passes through the hinges, it is evident that the reaction R_2 acts along a line connecting hinges B and C , as shown in Fig. 82 (a). Also, since the structure under consideration is in equilibrium, the resultant of the forces on either side of load P must meet at a point on the action line of the load. Therefore, to find the direction and position of the action line of R_1 , produce CB to an intersection with P at point D , and connect A and D . The position and direction of R_1 and R_2 are then completely determined.

To determine the amount of R_1 and R_2 , construct a force diagram, as shown in Fig. 82 (b). Lay off force P in amount and direction to any scale. By the methods given in the volume on "Stresses in Framed Structures," resolve P into components parallel to the action lines of R_1 and R_2 as given in Fig. 82 (a). The resulting forces give the amount of the reactions, which are thus completely determined. If values corresponding to H_1 , H_2 , V_1 , and V_2 of the algebraic solution are required, they can be determined by resolving R_1 and R_2 of Fig. 82 (b) into their vertical and horizontal components. Figure (c) shows the construction for a single horizontal load.

Any Set of Loads.—Figure 83 (a) shows a three-hinged arch supported by hinges at A , B , and C and carrying a set of inclined loads on both arms. The complete solution for the reactions at A and B requires that an equilibrium polygon for the applied loads be passed through points A , B , and C .

Construct a force diagram for the applied loads, as shown in Fig. 83 (b). As the location of the pole for an equilibrium polygon which will pass through the three given points is not known as yet, it must be determined by cut-and-try methods. Assume any pole, as O' and construct the corresponding equilibrium polygon. All lines for this construction are shown dotted in Figs. 83 (a) and (b). In constructing this equilibrium polygon begin with the string which passes through the point C . For the case under consideration, this is a line parallel to $O'd$ of Fig. 83 (b).

Assume for the purpose of this discussion that the applied loads are divided into two groups composed of the loads on either side of point C —that is, loads P_1 , P_2 , P_3 in one group, and P_4 and P_5 in another group. Determine the direction of the resultants of these two groups. The line $a-d$ of Fig. (b) shows the direction of the resultant for P_1 , P_2 , and P_3 , and $d-f$ shows the direction of the resultant of P_4 and P_5 . In Fig. (a) draw through points A and B lines $A-D$ and $B-E$ parallel respectively to $a-d$ and $d-f$ of Fig. (b). Draw the closing lines $D-C$ and $C-E$ of Fig. (a) for the equilibrium polygons for the two groups of loads, pole at O' . In Fig. (b) draw lines $O'F$ and $O'G$ parallel respectively to $D-C$ and $C-E$ of Fig. (a). This operation is equivalent to assuming that the two groups of loads are supported at points A and C for the left-hand group and C and B for the right-hand group by forces parallel respectively to the resultants of the two groups.

From the principles of graphic statics it can be shown that while an infinite number of equilibrium polygons can be drawn through point C for the conditions shown in Fig. (a), in all of these polygons the last string for each group and its closing line will always intersect on the lines $A-D$ and $B-E$ produced. Also, points F and G of Fig. 83(b) locate the points of load divide for A and C and for C and B . The position of these points will always be the same, regardless of the assumed location of the pole O' . Hence these statements also hold true for the equilibrium polygon for points A , B , and C , in which case the intersection of last strings and closing lines is at points A and B of Fig. 83(a). Therefore $A-C$ and $C-B$ are the closing lines for the required equilibrium polygon.

To locate the pole of the required equilibrium polygon, in Fig. 83 (b) draw $F-O$ and $G-O$ parallel respectively to $A-C$ and $C-B$ of Fig. 83 (a). Point O of Fig. 83 (b), the intersection of $F-O$ and $G-O$, is the required pole, and the full line equilibrium polygon of Fig. 83 (a) passing through points A , B , and C is the required polygon. The direction of the reactions at A and B is given by the last strings of the true equilibrium polygon, produced, as shown in Fig. 83 (a), and the amount of the reactions is given to scale by the corresponding forces in Fig. 83 (b). Thus R_1 is given by $O-a$ and R_2 is given by $O-f$.

Where the applied loads consist of a set of parallel vertical forces, all of which are unequal in amount, the construction of Fig. 83 can also be used. A somewhat simpler solution for this case is shown in Fig. 84. Again assume any pole, as O' of Fig. 84 (b), with a pole distance H_1 . Construct the corresponding equilibrium polygon, which is shown by the dotted lines of Fig. 84 (a). Measure the vertical

intercept, y of Fig. 84 (a), between the string of the equilibrium polygon which passes through C and the closing line $D-E$.

From the principles of graphic statics, the moment at C due to vertical forces to the right or left of the point is $M_c = H_1y$, where $H_1 =$ pole distance, and $y =$ the intercept described above. Consider the corresponding value for the equilibrium polygon through points $A, B,$ and $C,$ as shown in Fig. 84 (a). The closing line is $A-B,$ the equilibrium polygon passes through point $C,$ and the vertical

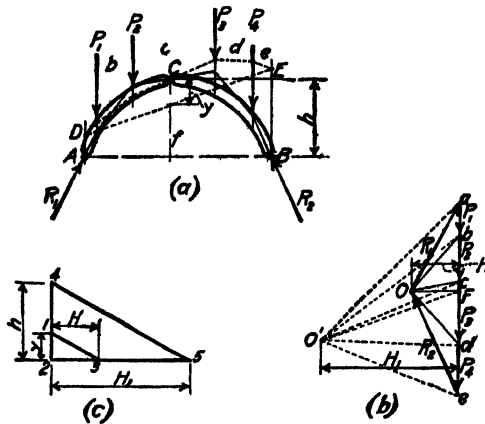

FIG. 84.

intercept is $h,$ the height of the crown hinge above hinges A and $B.$ If H be the true pole distance, $M_c = Hh.$ But the moment about C is a constant and hence the two expressions for M_c given above are equal. Therefore on equating the above expressions, the value of the true pole distance H can be determined. On equating these expressions for M_c we have, $H_1y = Hh,$ from which, $H = \frac{H_1y}{h}.$

A graphical solution of this equation is shown in Fig. 84 (c). To obtain the value of $H,$ draw a set of rectangular axes 2-4 and 2-5. On the horizontal axis lay off the value of $H_1,$ represented to scale by 2-5, and on the vertical axis lay off $y = 1-2$ and $h = 2-4.$ Connect points 4 and 5, and through 1 draw 1-3 parallel to 4-5. Then $H = 2-3$ to the same scale as $H_1.$

To locate the true pole O in Fig. 84 (b) draw through O' a line $O'-F$ parallel to $D-E,$ the closing line of the dotted equilibrium polygon of Fig. 84 (a). Then F of Fig. 84 (b) is the load divide point of the vertical forces. Since the closing lines for all poles intersect at point $F,$ and since the closing line for the true polygon is a horizontal line, draw from point F a horizontal line. Lay off on this line $F-O = H$ of Fig. 84 (c). Point O of Fig. 84 (b) is the required pole. The full line equilibrium polygon of Fig. 84 (a) shows the required polygon. Figure 84 (a) shows the direction of the reactions R_1 and $R_2.$ Their amount is shown in the force polygon of Fig. 84 (b).

A special case of vertical loading, in which equal loads are symmetrically placed with respect to the crown hinge, is shown in Fig. 85. Since the loads are

symmetrically placed with respect to the crown hinge, only half of the force diagram and the equilibrium polygon need be drawn, since it is known that the string of the equilibrium polygon passing through point C is horizontal, as shown in Fig. 85 (a). Draw the force polygon for the loads to the left of the center, as shown in Fig. 85 (b). Choose a pole O' and draw an equilibrium polygon, shown by the dotted lines of Fig. 85 (a). Since the loads are symmetrical about the center hinge, the closing line of the trial equilibrium polygon will always be horizontal. Therefore, O' is to be located on a horizontal line through point d of Fig. 85 (b).

Produce $A-E$ and $D-E$, the first and last strings of the equilibrium polygon, to an intersection at point E of Fig. 85 (a). This locates a point on the line of action of the resultant of the group of loads to the left of the crown hinge. This resultant is shown by R in Fig. 85 (a). Since the first and last strings of the equilibrium polygons drawn for any pole will meet on the line of action of R , the true pole can be located as follows: Through hinge C draw a horizontal line $C-F$ intersecting R at F . This line is the last string of the equilibrium polygon through points A , B , and C . Connect A and F . The resulting line is the first string of the required equilibrium polygon.

To locate the true pole in Fig. 85 (b), draw from point a a line $a-O$ parallel to $A-F$ of Fig. 85 (a). Then O of Fig. 85 (b) is the required pole. The true equilibrium polygon is shown by the full lines of Fig. 85 (a).

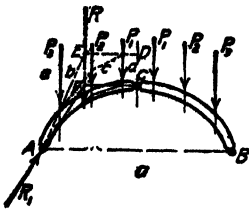

Fig. 85.

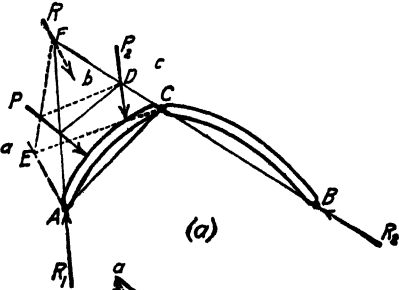
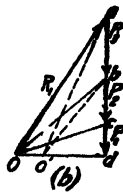

Fig. 86.

Figure 86 shows a three-hinged arch supporting loads on one arm only. Since there are no loads on the right-hand side of the arch, the direction of R_2 is given at once, as shown in Fig. 86 (a). The construction is the same as for Fig. 82. Construct the force polygon of Fig. 86 (b) and choose a pole O' . Since the last string of the equilibrium polygon must pass through C and B of Fig. 86 (a), the pole O' of Fig. 86 (b) should lie on a line $c-O'$ which is parallel to $B-C$ of Fig. 86 (a). Construct an equilibrium polygon for pole O' . This polygon is shown by the dotted lines. Begin the construction at point D , and close on a line $A-E$, which is parallel to the resultant of the applied loads. Line $a-c$ of Fig. 86 (b) shows the direction of this resultant. The closing line of the polygon is $E-C$ of Fig. 86 (a). In Fig. 86 (b) locate the load divide point G by drawing through O' a line $O'-G$ parallel to the closing line $E-C$ of Fig. 86 (a). To locate the true

pole for an equilibrium polygon through A , B , and C , draw from point G of Fig. 86 (b) a line $G-O$ parallel to $A-C$ of Fig. 86 (a). Point O of Fig. 86 (b) is the required pole. Figure 86 shows the required construction.

This problem can also be solved by assuming that the applied loads are replaced by their resultant R . Assume a pole O' as before and locate the position of R . The construction is shown by the dotted lines of Fig. 86 (a). By applying the same principle as used in Fig. 82 for a single load, the direction of R_1 can be determined at once, for the action line of R_1 meets the resultant R at F , a point on $B-C$ produced.

Temperature Stresses.—The changes in the reactions and stresses in three-hinged arches due to changes in temperature are so small compared to the stresses due to direct loading that they are usually neglected. It will be found that the effect of temperature changes on a three-hinged arch is to increase or decrease the dimensions of the structure, depending on the character of the change. If the abutments are rigid, the change in dimensions results in a rise or fall of the crown hinge. If a tie rod is used, so placed as to be protected from sudden changes of temperature, a similar effect is produced. When the tie rod is exposed to the same conditions as the truss, both crown and abutment hinges change position. However, it can be shown that assuming very severe conditions, the changes in dimensions will not exceed 0.1 per cent of the principal dimensions of the structure. Hence temperature changes can be neglected.

51b. Two-hinged Arches.—The reactions at the points of support for any two-hinged arch can be represented by four unknown forces, as shown in Fig. 87 for a braced arch. Since there are four unknowns to be determined and only three independent equilibrium equations are available, another independent condition must be at hand from which a fourth equation can be formed. In structures of the two-hinged type, the fourth condition equation is made to depend upon the elastic deformation of the arch. This elastic deformation is therefore dependent upon the form of the arch, the sizes of all members, and the conditions of the end supports. Where rigid supports are provided, an equation is formed which states that the horizontal movement of one support with respect to the other is zero. If the resistance to horizontal forces is provided by a tie rod connecting the two supports, it is usual to anchor one end of the arch truss to the foundations and to place the other end on rollers or a sliding plate. For this construction the movement of one support with respect to the other is placed equal to the extension of the tie rod. The method outlined above will be applied to two-hinged arches of the braced and ribbed type.

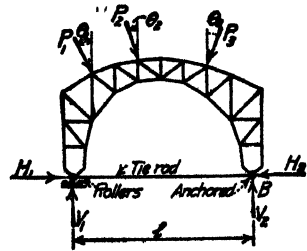

FIG. 87.

Reactions for a Two-hinged Braced Arch.—Figure 87 shows a two-hinged braced arch with a tie rod connecting the hinged points of support. It will be assumed that support B is anchored to the foundations and that support A is placed on rollers. Assume that the structure carries the loads P_1 , P_2 , and P_3 , acting as shown. Applying the three conditions of static equilibrium to the structure of Fig. 87, we have

$$\left. \begin{aligned} V_1 &= \sum \frac{Px_B}{l} \\ V_2 &= \sum \frac{Px_A}{l} \end{aligned} \right\} \quad (5)$$

and

$$H_1 - H_2 = \Sigma P \sin \theta \quad (6)$$

In these equations P = any load, x_A and x_B = perpendicular distance from any load to A and B respectively, θ = angle which any load makes with the vertical, and l = span between hinges.

The fourth independent equation is made to depend upon the elastic deformation of the arch. As stated above, the movement of point A with respect to point B is to be placed equal to the extension of the tie rod. This movement can be calculated by methods for the determination of the deflection of framed structures given in standard works on bridge stresses.¹ From these works, the deflection of any point in a framed structure is given by the formula

$$D = \sum \frac{Sl}{AE} u \quad (7)$$

where D = deflection of any point; S = stress in any member due to the applied loads; u = a ratio which is equal to the stress in any member due to a 1-lb. load applied at the point whose deflection is desired and in the direction of the desired deflection; l = length of any member; A = its area; and E = modulus of elasticity of the material of which the structure is built.

In the case under consideration, the tie rod is a tension member. Hence the movement of point A is to the left. The 1-lb. load used for the determination of values of u is to be applied horizontally at point A and acting to the left. It is assumed that the tie rod is removed when values of u are calculated.

Let H_1 = stress in the tie rod, and let A_t , l_t , and E_t = respectively, the area, length, and the modulus of elasticity of the material for the tie rod. The extension of the tie rod under a stress H_1 is then $H_1 l_t / A_t E_t$. Placing the extension of the tie rod equal to the horizontal movement of point A , as given by the general equation for deflection, we have

$$\sum \frac{Sl}{AE} u = H_1 \frac{l_t}{A_t E_t} \quad (8)$$

In this formula, S is the stress in any member of Fig. 87. This stress can not be determined until H_1 is known. However, S can be expressed in terms of H_1 and the stress in any member of the arch of Fig. 87 with the tie rod removed. This can be done in the following manner: Remove the tie rod and calculate the stresses in all members of the statically determinate arch truss thus formed. Let S' denote this stress for any member. Since H_1 and u have the same line of action, it is evident from the definition of u given above that the effect of H_1 on the stress in any member can be expressed by a term of the form $-H_1 u$. The minus sign is used because by definition the 1-lb. load acts to the left with respect to point A , while H_1 is a tension and therefore acts to the right with respect to point A . This difference in direction can be accounted for by the use of a minus sign. We then have

$$S = S' - H_1 u \quad (9)$$

¹ See JOHNSON, BRYAN and TURNBAUR, "Modern Framed Structures," Parts I and II.

Substituting this value of S in eq. (8)

$$\sum \left(\frac{S'l}{AE} u - H_1 \frac{l}{AE} u^2 \right) = \frac{H_1 l_i}{A_i E_i}$$

Solving this equation for H_1 , the stress in the tie rod is found to be

$$H_1 = \frac{\sum \frac{S'l}{AE} u}{\sum \frac{l}{AE} u^2 + \frac{l_i}{A_i E_i}} \quad (10)$$

In substituting in eq. (10), close attention must be paid to the signs of the stresses S' and u . It will be best to use plus for tension and minus for compression. When S' and u are multiplied, like signs result in plus values, and unlike signs result in minus values. If the signs have been correctly handled, the sign of the result will indicate the direction of H_1 . A plus sign indicates that the arrow in Fig. 87 acts as shown, and a minus sign indicates that H_1 acts in the opposite direction.

With eq. (10), and eqs. (5) and (6) given above, the reactions can be determined for an arch with a tie rod. If the hinges are supported by rigid abutments, the effect is equivalent to a tie rod of infinite area. For this condition, the term $\frac{l_i}{A_i E_i}$ is zero, and eq. (10) becomes

$$H_1 = \frac{\sum \frac{S'l}{AE} u}{\sum \frac{l}{AE} u^2}$$

Again, if no tie rod is provided, and if the abutments do not provide lateral support, A_i can be taken equal to zero. For this condition the denominator of eq. (10) becomes infinite and hence $H_1 = 0$, or, Fig. 87 is a simple span.

It will be noted in eq. (10) that the value of H_1 is dependent upon the form of the arch truss, as indicated by S' , u , and l , and also upon the size of the members, as indicated by A . Therefore, before H_1 can be determined for a given arch, the areas of the members must be known, or they must be assumed. If the structure to be designed is similar in size and loading conditions to an existing structure, it is possible to draw some conclusions regarding the probable size of members for the proposed structure. When this information is not available, a preliminary design can be made, using a value of H_1 determined on the assumption that all members have the same area. Stresses in all members can then be determined by methods to be presented later in this article. After the stresses have been determined, members can be designed to fit these stresses. Using the areas thus determined, another calculation for H_1 can be made, the stresses in the members recalculated, and the members redesigned, if necessary. Usually it will be found necessary to make only one complete design following the preliminary design.

Effect of Temperature Changes on a Two-hinged Braced Arch.—The reactions at the points of support of the two-hinged arch of Fig. 87 due to changes in temperature can be determined by substituting in place of the term $\sum \frac{S'l}{AE} u$ of eq. (10) an expression for the change in the distance between points of support due to the given temperature change. Assume that the structure of Fig. 87 is supported

by rigid abutments at A and B . Suppose that the temperature rises t degrees. If the coefficient of linear expansion of the material of which the arch is constructed is c per unit of length, the change in the distance from A to B is $+ctl$. If H_t denote the horizontal reaction at A , we have from eq. (10),

$$H_t = \frac{\pm c t l}{\sum \frac{l}{AE} u^2} \quad (11)$$

The plus sign is to be used for a rise in temperature, and the minus sign is to be used for a fall in temperature. For a rise in temperature H_1 and H_2 act as shown in Fig. 87; for a fall in temperature they act in opposite directions. It is to be noted that for temperature changes, $V_1 = V_2 = 0$, and that $H_1 = H_2$.

Where a tie rod is used which is protected from changes in temperature due to the fact that it is under ground in a special trough, the methods for the calculation of the reactions are the same as given above. In this case the temperature change t must be based on the known or assumed difference in temperature between truss and tie rod. The denominator of eq. (11) must include the term $\frac{l}{AE_t}$ of eq. (10).

When A and B of Fig. 87 are connected by an exposed tie rod, for which temperature changes are exactly the same as for the rest of the structure, it can readily be seen that $H_t = 0$, for a temperature reaction exists only when resistance is offered to the tendency of the framework between A and B to expand. Rigid supports, or a tie rod which does not expand as much as the framework will cause a temperature reaction, while a tie rod whose expansion is equal to that of the framework will not cause a temperature reaction.

The temperature change to be used in the calculation of H_t of eq. (11) varies with the conditions. For a building which is heated and is not subjected to sudden changes in temperature, 15 to 20 deg. above and below the normal, or a range of 30 to 40 deg. is sufficient. If severe conditions are to be expected, with sudden changes of temperature, 50 or 60 deg. above and below normal, or a range of 100 to 120 deg. should be specified.

Ribbed Arches of Two Hinges.—Ribbed arches of two hinges are seldom used in building construction. For methods of calculation for structures of this type the reader is referred to standard textbooks on the subject of arches.¹

51c. Hingeless Arches.—Hingeless braced arches of the type mentioned in Art. 50 have been used to some extent in building construction. Arches of the hingeless type are used extensively in bridge work, particularly in the form of steel or reinforced concrete ribs. Since the essential difference in the bridge and roof arch of the hingeless type lies in the applied loading, the reader is referred to standard works on the subject of steel and concrete arches.²

51d. General Methods for Determination of Stresses in Braced and Ribbed Arches.—Stresses in the members of a braced arch, or in the web and flanges of a ribbed arch, are best determined by graphical or semigraphical

¹ JOHNSON, BRYAN, and TURNBAUR. "Modern Framed Structures," Part II.

² JOHNSON, BRYAN and TURNBAUR. "Modern Framed Structures," Part II.

TURNBAUR and MAURER. Principles of Reinforced Construction.³

G. A. HOOL. "Reinforced Concrete Construction," Part III.

HOOL and JOHNSON. "Concrete Engineers' Handbook."

W. S. TAIT. "Steel Roof Trusses Designed as Elastic Arches," *Eng. News-Record*, Apr. 18, 1918.

methods. Algebraic methods can also be used, but in general such methods require considerable time for the solution of the problem. The accuracy of the results obtained by the algebraic methods is probably somewhat greater than is possible by the use of graphical methods. However, graphical methods give results which are accurate enough for all practical purposes, and since much time can be saved thereby, especial attention will be given to graphical methods in the work to follow.

In Art. 53 is given a complete solution for stresses in a three-hinged arch. A detailed discussion of the methods employed is given in connection with this solution.

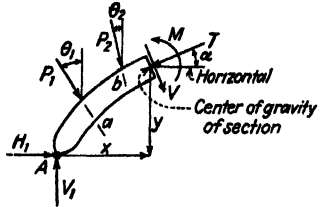

FIG. 88.

The stresses in an arch of the two- or three-hinged type can be determined as soon as the applied loads and the reactions at the supports are known. In general the principles of stress determination are similar to those given in the volume on "Stresses in Framed Structures," although the presence of inclined reactions and the curvature of the arch rib causes slight modifications in the methods of calculation. While the arch rib is essentially a curved beam, in most cases the depth of the arch rib is so small compared to its radius of curvature that the internal stresses can be determined without appreciable error by the methods given in the chapter on Bending and Direct Stress in the volume on "Structural Members and Connections."

An algebraic solution will be given for the conditions shown in Fig. 88, which represents a portion of an arch hinged, at A with all forces in position. The internal stresses are represented by a moment, M ; a thrust, T ; and a shear, V . These internal stresses can be determined by summations of moments and of vertical and horizontal forces taken about the center of gravity of the section, including all external applied loads and reactions. Thus from Fig. 88

$$M = +V_1x - H_1y - P_1a - P_2b = \Sigma M \tag{12}$$

If $\Sigma V = V_1 - P_1 \cos \theta_1 - P_2 \cos \theta_2$ and $\Sigma H = H_1 + P_1 \sin \theta_1 + P_2 \sin \theta_2$, which are respectively the summations of vertical and horizontal external forces, we have

$$T = (\Sigma V) \sin \alpha + (\Sigma H) \cos \alpha \tag{13}$$

and

$$V = (\Sigma V) \cos \alpha - (\Sigma H) \sin \alpha \tag{14}$$

where α is the angle which the tangent to the arch axis makes with the horizontal.

Having given the internal forces acting on any section, the fiber stresses can be determined from the expressions

$$\text{and } \left. \begin{aligned} f_1 &= \frac{T}{A} + M \frac{c_1}{I} \\ f_2 &= \frac{T}{A} - M \frac{c_2}{I} \end{aligned} \right\} \tag{15}$$

where T and M are as given above; f_1 and f_2 = the fiber stress on the extreme upper and lower fibers, respectively; c_1 and c_2 = the corresponding distances from the extreme fibers to the center of gravity of the section; and A and I = area and moment of inertia of the section respectively. The derivation of these equations

is explained in the chapter on Bending and Direct Stress in the volume on "Structural Members and Connections." For the conditions shown in Fig. 88, the fiber stresses given in eq. (15) are compressive. If on substituting in these equations the sign is reversed, the resulting stresses are tensile.

A graphical solution for internal stresses is shown in Fig. 89. This solution requires the construction of the force and equilibrium polygons. Figure 89 shows these polygons in part for certain assumed loads and reactions. Since the string R of the equilibrium polygon is the resultant of all forces on either side of the section, we have

$$M = Rd \tag{16}$$

where d is the perpendicular distance from R to the center of gravity of the section under consideration. This moment can also be expressed in other terms. If e of Fig. (a) represent the distance from the center of gravity of the section to the intersection of the plane of the section produced and the line of action of R , and if R_T = component

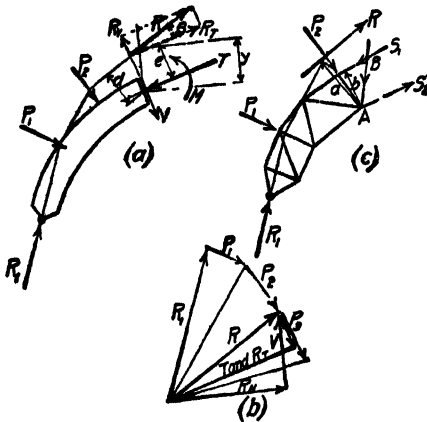

FIG. 89.

of R parallel to a tangent to the arch axis at the section in question, then

$$M = R_T e \tag{17}$$

Again, if R_H = horizontal component of R , and y = vertical distance from center of gravity of section to line of action of R , as shown in Fig. (a), then

$$M = R_H y \tag{18}$$

The values of R_T and R_H are readily determined from the force polygon of Fig. (b) by resolving R into the required components. Values of T and V are obtained from the force polygon by resolving R into components parallel and perpendicular to the tangent to the arch axis at the section in question, as shown in Fig. 89 (b).

Fiber stresses can be determined by the use of eq. (15), substituting values of M and T as determined above. These equations can be modified somewhat and the fiber stresses can be determined from the values of T and e of Fig. 89 (a). From eq. (17) and Fig. 89 (a), $R_T = T$, and hence, $M = Te$. Substituting this value of M in eq. (15) and also noting that $I = Ar^2$, where A = area of the section, r = its radius of gyration, these equations can be written in the form

$$\text{and } \left. \begin{aligned} f_1 &= \frac{T}{A} \left(1 + \frac{ec_1}{r^2} \right) \\ f_2 &= \frac{T}{A} \left(1 - \frac{ec_2}{r^2} \right) \end{aligned} \right\} \tag{19}$$

In some cases the desired results are obtained more directly by the use of eq. (19) than by the use of eq. (15).

The graphical methods of calculation given above are general and apply to all types of arches. However, the distances d , e , and y shown in Fig. 89 (a) are

often so small that they can not be determined with the desired degree of precision. Under such conditions, the moments should be calculated by algebraic methods, using eq. (12).

Methods of stress calculation similar to those outlined above can also be applied to the braced arch. Figure 89 (c) shows a section cut through any panel of a braced arch. To determine the stress S_1 in a chord member, take moments about point A , the intersection of the other members cut by the section. Since R is the resultant of all external forces to the left of the section, we have

$$S_1 = \frac{Ra}{b}$$

where a and b , respectively, are the lever arms of R and S_1 , as scaled from the drawing. The stress in S_2 can be obtained from a similar equation about B . If members S_1 and S_2 intersect within the limits of the drawing, the stress in S_2 can be determined by moments taken about the intersection point. If they do not intersect within the limits of the drawing, a resolution equation can be taken for an axis perpendicular to one of the chord members.

52. Loading Conditions for Arch Trusses.—The loads to be carried by an arch roof truss can be determined from the data given in the chapter on Roof Trusses—General Design, by methods similar to those used in the preceding chapters on the design of wooden and steel roof trusses. In most cases the slope of the roof surface is not uniform, as in the cases considered in the preceding chapters, for it is made to conform to the contour of the top chord of the arch. As the wind and snow loads depend for their value on the roof slope, the wind and snow panel loads for arch trusses will vary with the location of the panel point. An application of the methods of calculation is given in the problem of Art. 53.

Formulas for the weight of arch trusses which will apply to all types of arch structures are not available, as structures of this type vary so widely in form and in class of service that sufficient consistent and reliable information has never been collected on which to base a formula. In general, the designer must draw conclusions regarding the probable weight of the arch to be designed, either from existing structures of the same size, or from his judgment based on past experience. After a design has been made, based on an assumed dead weight, the true weight of the structure should be calculated and the assumed weight revised, if found necessary. From an examination of the weights of existing arches, it was found that the weight per square foot of covered area may be anywhere from 10 to 25 lb., depending upon the span length, spacing of trusses, and the specified loading conditions.

Maximum stresses in the members of arch trusses are to be determined for loading conditions similar to those used for simple roof trusses. In general the following loading conditions are used: (a) Dead load, (b) snow load on left side of roof, (c) snow load on right side of roof, (d) snow load on whole roof, (e) wind load on left side of roof, and (f) wind load on right side of roof.

In combining the stresses due to these loads in order to obtain maximum stresses, most designers assume that snow and wind loads do not act on the roof at the same time. Others assume conditions similar to those used in the preceding chapters. This is a matter on which the designer must use his judgment. In making up the maximum stresses in the members, the dead load stresses should be combined with the snow or wind load stress which will produce greatest

tension and greatest compression in the members. It must be remembered, in this connection, that the wind and snow load stresses may be of the same character as the dead load stresses, or they may differ in character. In the latter case, if they exceed the dead load stresses, a reversal of stress will occur. This information must be at hand before a correct design of members can be made.

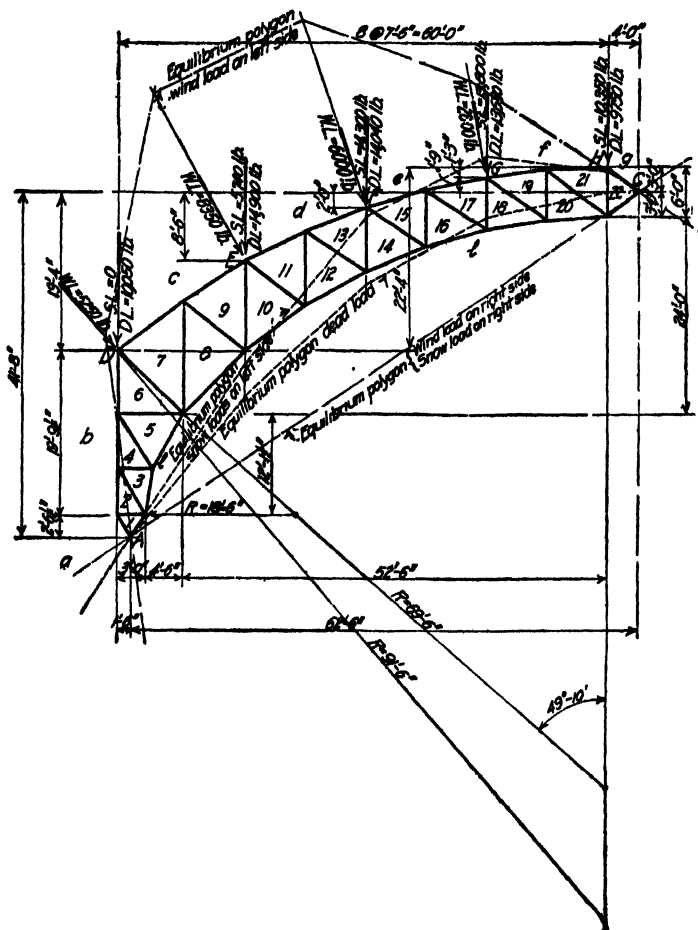

FIG. 90.—Truss diagram—typical three-hinged arch.

53. Determination of Stresses in a Typical Three-hinged Arch Truss.—The methods of stress calculation outlined in Art. 51 (d) will now be applied to a typical three-hinged arch of the dimensions shown in Fig. 90. This arch has a span of 125 ft., c. to c. of end pins, and a rise of 41½ ft. This type of framing adopted divides the truss into panels of 7.5 ft., as shown in Fig. 90. Purlins will be placed at alternate panel points. The distance between trusses will be taken as 30 ft. It will be assumed that the sides of the building consist of self-supporting masonry walls. No part of the weight of the walls will be assumed as carried by the trusses. It will be assumed, however, that the roof load at point *D* of Fig. 90 is carried by the trusses.

Dead Load Stresses.—The dead load stresses are to be determined for the weight of the roof covering and the weight of the trusses. It will be assumed that the roof covering consists of tile or slate laid on 2-in. plank, which are supported by rafters. These rafters will be assumed to be placed parallel to the trusses, and will be assumed to be supported by purlins of the type described in Art. 55. Design methods for the roofing and the rafters are given in the chapter on Roof Trusses—General Design. A roof covering of the assumed type will be found to weigh about 20 lb. per sq. ft. of roof surface. The weight of the trusses is determined by methods outlined in Art. 52. It will be assumed, as a basis for a preliminary design, that the weight of the trusses and purlins is 10 lb. per sq. ft. of horizontal covered area.

The panel loads due to the roof covering and the dead weight of the arch will be assumed to be concentrated at the point of attachment of the purlins. As the

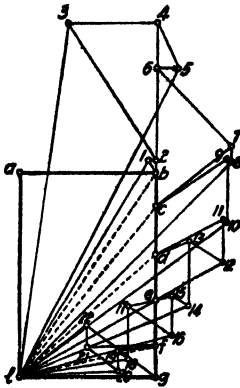

FIG. 91.—Dead load stress diagram—stresses in members of left half of arch.

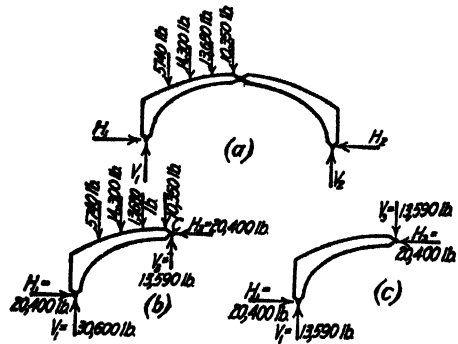

FIG. 92.—Loading diagrams—snow load stresses.

roof load is given in pounds per square foot of roof surface, and since the roof area tributary to the purlins depends upon the slope of the roof, the panel loads due to the roofing will vary. Since the dead weight is given in pounds per square foot of horizontal covered area, the part of the panel load due to the weight of the trusses will be the same at all points, for the horizontal spacing of the purlins is taken as 15 ft., as shown in Fig. 90.

To illustrate the methods used in calculating panel loads from the above data, the dead panel load for point *F* of Fig. 90 will be determined. In calculating the roof area tributary to point *F*, it will be assumed that points *E*, *F*, and *G* are joined by straight lines. For the dimensions shown on Fig. 90, $E-F = 16.3$ ft., and $F-G = 15.5$ ft. As stated above, the roofing weighs 20 lb. per sq. ft., and the trusses are spaced 30 ft. apart. The roofing panel load at *F* is then $\frac{1}{2} (16.3 + 15.5) \times 30 \times 20 = 9,540$ lb. By similar methods, the roofing panel loads at other points are as follows: *D*, 5,550 lb.; *E*, 10,400 lb.; *G*, 9,180 lb., and *H*, 6,300 lb. Assuming that the trusses and purlins weigh 10 lb. per sq. ft. of horizontal covered area, as stated above, the dead panel load due to trusses and purlins is $10 \times 15 \times 30 = 4,500$ lb. At point *H*, where the horizontal projection is 11.5 ft., the panel load is 3,450 lb. As the weight of several members is probably transferred to joint

D , it will be assumed that a full panel of truss weight is carried at this point. Adding the loads due to the roofing and the truss dead weight, the total panel loads at the several joints are as follows; D , 10,050 lb.; E , 14,900 lb.; F , 14,040 lb.; G , 13,680 lb., and H , 9,750 lb. These panel loads are shown in position on Fig. 90.

The reactions at the hinges A and C due to dead load are calculated by the methods given in Art. 51a. Since the dead panel loads are all vertical, and are symmetrically placed with respect to the center hinge, the vertical component of the reaction at A is evidently equal to the sum of the panel loads on one side of the

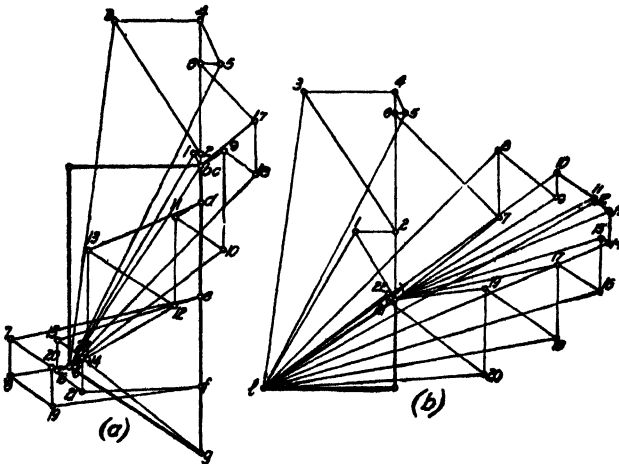

FIG. 93.—Snow load stress diagram.

center of the arch, or, $V_1 = 62,420$ lb. The horizontal component of the reaction at A is equal to the moment about C divided by the rise of the arch. For the loads and dimensions shown in Fig. 90.

$H_1 =$

$$\frac{62,420 \times 62.5 - 9,750 \times 4 - 13,680 \times 19 - 14,040 \times 34 - 14,900 \times 49 - 10,050 \times 64}{41.67}$$

$$= 42,000 \text{ lb.}$$

Since all of the loads are vertical the reaction at hinge C is horizontal and equal to H_1 .

In the case under consideration, algebraic methods are readily applied to the determination of the reactions as all of the lever arms can be obtained from Fig. 90 without further calculation, except simple addition. While graphical methods can be applied to this case, little is to be gained thereby. The algebraic method of calculation is therefore recommended.

The stresses in the members of the arch due to the applied loads shown on Fig. 90 and the reactions calculated above are readily determined by the graphical methods of stress analysis given in the volume on "Stresses in Framed Structures." Figure 91 shows the stress diagram as drawn for the left side of the arch.

In constructing stress diagrams of the kind shown in Figs. 91 to 94, great care must be used in drawing the diagrams, for, to be correct, the diagram must close.

That is, suppose that the diagram is begun at point *A* of Fig. 90, and carried forward to point *C*. If the diagram is accurately drawn, the resultant of the stresses in members *g-22* and *l-22* at joint *C* will be equal to R_c , the hinge reaction at *C*. In Fig. 91, exact closure of the stress diagram is obtained when the horizontal components of *l-22* and *g-22* are equal to *l-g*, and when point 22 is directly over point 21. The effect of cumulative errors on the closure of the diagram can be reduced by starting the diagram at point *A* and carrying it about half way across the framework. Another start can then be made at point *C*, and closure made on the part of the diagram already drawn. It will usually be found that closing errors can be reduced by this method.

Accurate construction of stress diagrams is greatly facilitated if the truss diagram, shown by Fig. 90, is drawn to a large scale. This results in long lines, from which the slope of the members can readily be obtained. If a small size truss diagram is used, the lines are so short that an accurate determination of the true slopes is impossible. The stress diagrams should be drawn to a scale which will result in lines which can be drawn with triangles not exceeding about the 12-in. size. This avoids inaccuracies resulting from lines drawn by several shifts of the triangle. Also, the stress diagram should be located as close to the truss diagram as possible, in order to avoid transferring lines for a long distance, which is certain to result in inaccurate work.

It is best to make frequent checks on the graphical work by means of stresses calculated by the algebraic method explained in Art. 51*a*. Stresses in chord members are readily calculated by the method shown in Fig. 89 (c), and form a convenient check. If the graphical and algebraic methods do not check, it is well to revise the graphical work before proceeding with the construction of the diagram.

Snow Load Stresses.—Stresses due to snow load are to be determined for three conditions of loading, as stated in Art. 52. These conditions are (a) snow load on left side of roof, (b) snow load on right side of roof, and (c) snow load on whole roof.

The panel loads due to snow are to be determined from the data given in Table 8, p. 149. Since the roof slope varies, the unit snow load will depend upon the location of the panel point. Several different assumptions can be made regarding the variation in the snow load. For the case under consideration, it will be assumed that the outside roof surface is an arc of a circle, and that the unit snow load for the area tributary to any panel point is equal to the load for a plane tangent to the roof surface at the panel point.

Thus at point *F* of Fig. 90, a plane tangent to the roof surface makes an angle of about 18 deg, 30 min. with the horizontal. It can be shown that this angle corresponds closely to a pitch of $\frac{1}{6}$, as defined in the chapter on Roof Trusses—General Design. From the table of snow loads referred to above, the snow load per sq. ft. of roof surface for a tile roof of $\frac{1}{6}$ pitch located in the Central States is

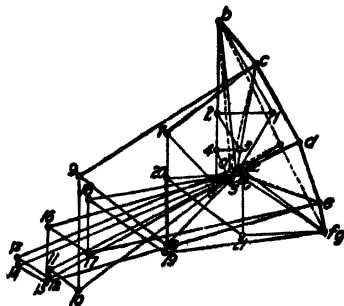

FIG 94.—Wind load stress diagram.

30 lb. By methods similar to those used above for the dead panel load due to roofing, it will be found that the snow panel load for point F is $\frac{1}{2}(16.3 + 15.5) \times 30 \times 30 = 14,300$ lb. Panel loads at other points are as follows: $D = 0$ (slope 45 deg., unit snow load = 0); $E = 5,740$ lb. (slope = 30 deg., unit snow load = 11 lb.); $G = 13,800$ lb. (slope practically flat, unit snow load = 30 lb.); $H = 10,350$ lb. (slope = flat, unit snow load = 30 lb.).

In tabulating the stresses in a symmetrical three-hinged arch, it is usual to make a table containing the members of the left half of the arch. Table 16, in which the stresses for the arch of Fig. 90 are tabulated, contains the members of the left half of the arch. All stresses required in Table 16 for the three snow loading conditions can be determined from stress diagrams drawn for all members of the arch due to snow loads on one arm of the arch, no load on the other arm, as shown in Fig. 92 (a).

The reactions at the points of support and at the crown hinge due to the loading shown on Fig. 92 (a) can be determined by the methods given in Art. 51a. These reactions are as follows, using the notation shown on Fig. 92: $V_1 = 30,600$ lb.; $H_1 = 20,400$ lb.; $V_3 = 13,590$ lb.; $H_3 = 20,400$ lb.; $V_2 = 13,590$ lb., and $H_2 = 20,400$ lb. All forces act as shown in Fig. 92. A graphical solution of the reactions can be made by the method shown in Fig. 86.

The stresses in the members of the left half of the arch for case (a), loads on the left half of the arch, are given by a stress diagram drawn for the loading conditions of Fig. 92 (b). This stress diagram is shown in Fig. 93 (a). The stresses scaled from this diagram are recorded in col. 2 of Table 16. Stresses in the members of the left half of the arch for case (b), loads on the right half of the arch, are given by the stress diagram of Fig. 93 (b), which is drawn for the loading conditions shown in Fig. 92 (c). It will be noted that the loading conditions shown in Fig. (c) are opposite hand of those for the right-hand half of the arch, loads on the left half, as shown in Fig. (a). Stresses scaled from the stress diagram of Fig. 93 (b) are recorded in col. 3 of Table 16. The stresses for members of the left half of the arch for case (c), loads on the whole arch, can be obtained by adding the stresses given in Figs. 93 (a) and (b) for the member in question. These stresses are recorded in col. 4 of Table 16.

Wind Load Stresses.—As in the case of the wooden and steel simple roof trusses designed in the preceding chapters, it will be assumed that the working stresses for wind loads are 50 per cent larger than those for dead and snow loads. Assuming, as before, that the working wind load is 30 lb. per sq. ft., and that the working stress for wind loading is 24,000 lb. per sq. in., the working wind load to be used for a 16,000 lb. unit stress is 20 lb. per sq. ft. Wind panel loads will therefore be determined for a unit wind pressure of 20 lb. per sq. ft.

In determining the normal wind pressure to be used at the several panel points, the same assumptions will be made as for snow panel loads. Thus at point F where the slope of the tangent to the roof surface corresponds to a $\frac{1}{4}$ pitch, the normal wind pressure, as given by Table 7, p. 149, is 13.9 lb. per sq. ft. of roof surface. The resulting panel load is $\frac{1}{2}(16.3 + 15.5) \times 30 \times 13.9 = 6,000$ lb., acting normal to the roof. By methods similar to those used for the snow panel loads, it will be found that the wind panel loads at the other points are as follows: $D = 5,250$ lb. (slope = 45 deg., unit wind load = 18.9 lb.); $E = 8,350$ lb. (slope = 30 deg., unit wind load = 16 lb.); $G = 2,800$ lb. (slope = about 9

deg., unit wind load = 6.1 lb.), and $H = 0$ (slope flat). These loads are shown in position on Fig. 90. Since the side walls are assumed to be self-supporting, it will be assumed that the wind loads in these walls are carried directly to the foundations without causing any stress in the members of the arch trusses. If the construction is such that the arch carries the horizontal wind load, the wind panel loads can be calculated by methods similar to those used in the chapter on the Detailed Design of a Truss with Knee-braces.

TABLE 16.—STRESSES IN A THREE-HINGED ARCH ROOF TRUSS

(Fig. 90)

Member		Dead load (1)	Snow load left side loaded (2)	Snow load right side loaded (3)	Snow load both sides loaded (4)	Wind load left side loaded (5)	Wind load right side loaded (6)	Maximum tension (7)	Maximum compression (8)
Top chord	b-1	+ 4,500	+ 2,250	+12,250	+14,500	-10,000	+ 4,930	19,000	5,500
	b-2	+ 4,000	+ 1,900	+10,500	+12,400	- 8,600	+ 4,220	16,400	4,600
	b-4	+45,900	+22,300	+32,100	+54,400	-11,900	+12,900	100,300	
	b-6	+32,000	+15,600	+28,800	+44,200	-14,900	+11,500	76,200	
	c-7	+29,600	+10,800	+20,200	+31,000	-10,300	+ 8,200	60,600	
	c-9	+26,200	+ 4,200	+29,500	+33,700	-19,200	+11,850	59,900	
	d-11	+23,500	- 4,500	+34,500	+30,000	-25,900	+13,900	53,500	
	d-13	+11,200	-18,900	+36,000	+17,100	-28,200	+14,500	47,200	2,400
	e-15	+ 5,000	-23,100	+33,100	+10,000	-26,400	+13,300	38,100	21,400
	e-17	+ 8,500	-30,100	+25,600	- 4,500	-22,100	+10,300	17,100	38,600
	f-19	+11,800	-23,100	+14,000	- 9,100	-15,000	+ 5,630	2,200	34,900
	f-21	+21,200	-18,200	- 8,000	-19,100	- 7,750	- 360	40,300
g-22	+26,000	-23,800	- 1,500	-25,300	- 9,700	- 600	51,300	
Bottom chord	l-1	- 77,000	-37,900	-28,000	-65,900	- 6,500	-11,300	142,900
	l-3	-108,900	-53,600	-46,000	-99,600	- 2,350	-18,500	208,500
	l-5	-106,000	-52,000	-47,600	-99,600	+ 900	-19,200	205,600
	l-8	- 92,500	-41,000	-51,500	-92,500	+ 9,100	-20,700	185,000
	l-10	- 79,500	-29,700	-56,200	-85,900	+18,100	-22,600	165,400
	l-12	- 71,800	-18,700	-58,800	-77,500	+19,800	-23,600	149,300
	l-14	- 56,700	- 2,900	-58,000	-60,900	+22,000	-23,400	117,600
Verticals and horizontals	l-16	- 48,800	+ 2,000	-54,300	-52,300	+18,300	-21,800	103,100
	l-18	- 34,000	+ 9,300	-46,200	-36,900	+14,100	-18,600	80,200
	l-20	- 30,300	+ 2,600	-34,300	-31,700	+ 6,650	-13,800	62,000
	l-22	- 26,000	- 2,200	-24,000	-26,200	- 600	- 9,650	52,200
	1-2	- 2,500	+ 1,100	- 6,200	- 7,300	+ 5,150	- 2,500	2,650	9,800
	3-4	-27,200	-13,300	-14,200	-27,500	+ 2,200	- 5,700	54,700
	5-6	+ 6,600	+ 3,100	+ 1,600	+ 4,700	+ 1,420	+ 850	11,300	
	7-8	+ 4,500	- 8,200	+10,300	+ 2,100	-10,300	+ 4,150	5,800	14,800
	9-10	-19,600	-15,300	+ 3,800	-11,500	-10,700	+ 1,500	34,900
	11-12	-13,000	-13,800	- 600	-13,200	- 800	- 240	26,800
	13-14	-20,000	-16,800	- 4,900	-21,700	- 700	- 1,970	41,700
	15-16	-12,000	- 4,600	- 8,200	-12,800	+ 5,180	- 3,300	24,800
17-18	-16,000	- 5,700	-11,200	-16,900	+ 5,050	- 4,500	32,900	
19-20	- 5,900	+ 5,900	-13,100	- 7,200	+ 6,850	+ 5,260	9,950	19,000	
21-22	+ 6,500	+ 5,200	+ 1,000	+ 6,200	+ 6,200	+ 400	12,700		
Diagonals	2-3	+ 50,000	+24,500	+25,800	+50,300	- 3,900	+10,400	100,300	
	4-5	-15,200	- 7,300	- 3,800	-11,100	- 3,350	- 1,530	26,300
	6-7	-33,200	-12,200	-22,500	-34,700	+ 6,500	- 9,050	67,900
	8-9	+ 1,500	+ 6,000	-11,600	- 5,600	+10,400	- 4,680	11,600	10,100
	10-11	+ 1,500	+ 9,100	+ 7,000	+ 2,100	+ 3,300	- 2,820	10,600	5,500
	12-13	+12,500	+16,000	- 2,800	-13,200	+ 3,500	+ 1,130	28,500	700
	14-15	+ 6,000	+ 5,500	+ 1,400	+ 6,900	+ 3,150	+ 570	13,100	
	16-17	+16,000	+ 8,500	+ 7,800	+16,300	+ 4,500	+ 3,140	32,300	
	18-19	+ 4,100	- 8,000	+13,500	+ 5,500	- 8,700	+ 5,430	17,600	4,600
	20-21	+11,800	- 6,000	+18,600	+12,600	- 8,950	+ 7,500	30,400	
Reactions	V ₁	+ 62,420	+30,600	+13,590	+44,190	+14,200			
	H ₁	+ 42,000	+20,400	+20,400	+40,800	- 1,850	+ 5,450		
	V ₂	0	+13,590	-13,590	0	+ 5,450	+ 8,250		
	H ₂	+ 42,000	+20,400	+20,400	+40,800	- 8,250	- 5,450		
	R ₂	42,000	24,500	24,500	40,800	9,850	9,850		

Stress Notation: + = tension - = compression
 Reaction Notation: Positive reactions act as shown in Fig. 92 (b).

The reactions due to wind loads will be determined by graphical methods, for the work required by a graphical solution will be found to be considerably less than that required by an algebraic solution. Using the method given in Fig. 86 of Art. 51a, the final equilibrium polygon is shown in position in Fig. 90. The resulting reactions are shown to scale on the force polygon of Fig. 94.

As stated in Art. 52, wind stresses are to be determined for wind load on either half of the arch. The stress diagram of Fig. 94 is drawn for stresses in the members of the left half of the arch due to loads on the left side of the crown hinge. These stresses are recorded in col. 5 of Table 16. Stresses in the members of the left half of the arch due to wind loads on the right side of the crown hinge can be determined by ratio from the snow load stresses for the corresponding condition of loading. This short cut is possible because for loads on the right side of the arch, stresses in members of the left half of the arch are due to the action of the right half against the left half. As shown in Figs 86 and 92 (a), this action can be represented by a force acting on a line connecting the crown and abutment hinges. Therefore the wind stresses required for col. 6 of Table 16 can be obtained by multiplying the stresses given in col. 3 by the ratio of the reactions at the supporting hinges for the two cases. From Fig. 93 (b), the reaction at A for snow load on the right half of the arch is 24,500 lb. The reaction at A for wind loads on the right half of the arch is the same as that given in Fig. 94 for the right-hand support, which is found to be 9,850 lb. Hence, if the stresses of col. 3 are multiplied by $\frac{9,850}{24,500} = 0.402$, the resulting stresses will be the values required for members of the left half of the arch due to wind loads on the right half. These stresses are shown in col. 6 of Table 16.

Maximum Stresses in Members.—The maximum stresses in the members of the arch under consideration will be calculated on the assumption that wind and snow loads do not act at the same time. Table 16 gives the possible combinations of the dead load stresses and the snow or wind stresses which will result in the greatest tension and compression in the several members.

54. Design of Members and Joints for a Typical Three-hinged Arch.—The principles governing the selection of the form of members for arch trusses, and the design of these members are the same as for the trusses designed in the preceding chapters. These principles are given in the chapter on Roof Trusses—General Design. The application of these principles to the design of arch trusses will be illustrated by a partial design of members and joint details for the three-hinged arch for which the stresses have been calculated in Art. 53.

The form of the members of an arch truss will depend on the amount of stress to be carried. For the truss under consideration in Art. 53, it will be found from a study of the stresses given in Table 16, that the stresses in all members, except a few of the lower chord members, can be provided for by sections composed of two angles. The bottom chord members in which large stresses exist can be made of angles and plates. Truss members for large arches, in which very heavy stresses exist, can be made of the same form as those used in bridge truss work. The trusses for the drill hall of the University of Illinois, described in *Eng. News* for Dec. 11, 1913, are composed of I- and H-beams. The *Eng. Rec.* for Oct. 7, 1916 contains a description of an arched roof truss whose members are composed of angles and plates.

By methods similar to those used in the designs of the preceding chapters, it will be found that the members listed as top chord members in Table 16 of Art. 53 can be made of two 6- × 6- × ½-in. angles, separated by a ½-in. space for gusset plates. This section furnishes excess area for some of the members, but since it meets the requirements of most members, it will be adopted throughout. The bottom chord members are subjected to

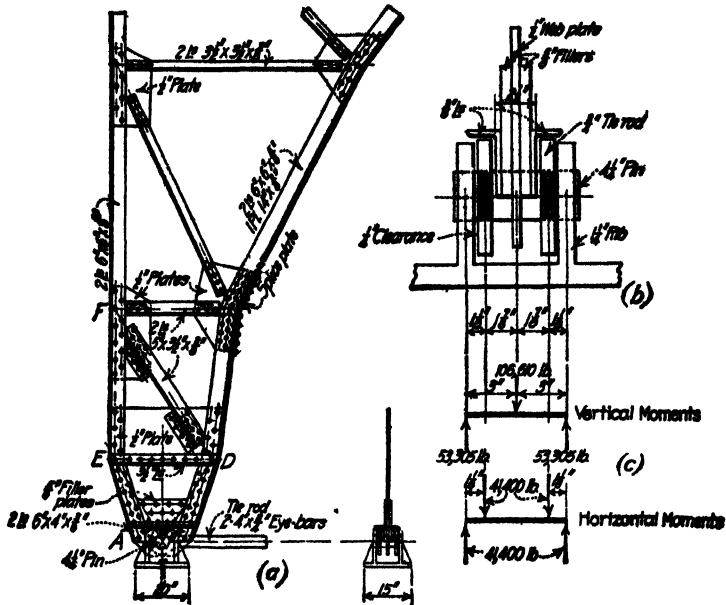

FIG. 95.

somewhat greater variations in stress than the top chord members. Adequate provision for all stresses will be provided by the following sections: members l-12 to l-14, two 6- × 6- × ½-in. angles; members l-12 to l-10, two 6- × 6- × ⅝-in. angles; and members l-8 to l-1, two 6- × 6- × ⅝-in. angles and a 14- × ⅜-in. plate. All web members, except a few near the end of the arch, can be made of two 3½- × 3- × ⅜-in. angles. For the other web members, two 5- × 3½- × ⅜-in. angles will answer. Figures 95 and 97 show the general arrangement of members.

Joint details for the three-hinged arch under consideration in this chapter are designed by the methods outlined in the chapter on Roof Trusses—General Design. With the exception of the hinged joints at A and C, the application of these principles is exactly the same as for the simple trusses designed in the preceding chapters.

Figure 95 shows the adopted details for the hinge joint at A and a portion of the lower end of the arch truss. As shown on Fig. 95, the members at the lower end of the truss are connected to a large gusset plate which includes several joints and members. This is necessary because the members are short and the stresses are large, thus requiring large joint details. A single plate greatly strengthens the end detail and makes possible a very compact joint.

It will be assumed that the rivets used in the design under consideration are $\frac{3}{8}$ in. in diameter, and that the allowable bearing and shearing values are 24,000 and 12,000 lb. per sq. in. respectively. From Fig. 95 it can be seen that the rivets connecting the members to the plates are in bearing on a $\frac{1}{2}$ -in. plate. For the allowable values given above, the rivet value is 10,500 lb. All of the end details shown in Fig. 95 provide sufficient rivets to connect the members to the gusset plates. It will be noted that lug angles are used on member *D-F*. These lugs are used in order to reduce the size of the end connection, and also to provide a connection between both legs of the angles and the gusset plate. This is advisable

where the stresses in the members are large. The design of lug angle details is considered in the section on Splices and Connections—Steel Members, in the volume on "Structural Members and Connections."

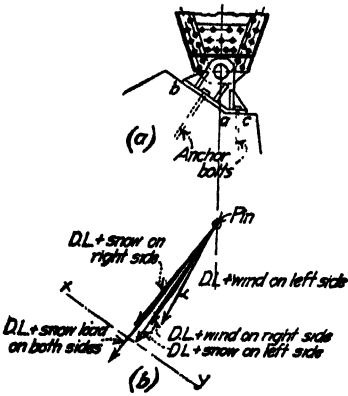

FIG. 96.

The top and bottom chord members are usually spliced at frequent intervals in trusses with curved chords. When the chord section consists of two angles, an effective splice is furnished by a detail similar to that used at joint *g* of the steel roof truss designed in the chapter on the Detailed Design of a Steel Roof Truss. By using this detail, the stress in the horizontal legs of the angles is transferred across the splice by means of the splice plate, leaving only the stress in the vertical legs of the angles to be transferred to the gusset plate, thus securing compact joint details. A similar detail can be used where the chord section consists of angles and plates. If the joints are milled so that a bearing fit is assured, only enough rivets need be provided to hold the members in contact. Figures 95 and 97 show the details adopted for the design under consideration.

The design methods to be used for the shoe and the pin at joint *A* depend upon the assumptions made regarding the action of the supporting forces at the abutments. If it be assumed that the horizontal component of the reaction is taken by a tie rod, the shoe and the supporting foundation can be designed for vertical forces only. Figure 95 shows a shoe designed on this assumption. If it be assumed that the foundations can resist vertical and horizontal forces, the shoe must be placed at an angle to the vertical, as shown in Fig. 96. Designs based on these two assumptions will be considered in detail.

Consider first the tie rod design shown in Fig. 95. In this design it is assumed that the horizontal and vertical components of the reaction are taken respectively by the tie rod and the shoe. Table 1B of Art. 53 shows that these reactions are a maximum for dead load and snow load on both arms of the arch. The horizontal component of the reaction is found to be $42,000 + 40,800 = 82,800$ lb., and the vertical component is found to be $62,420 + 44,190 = 106,610$ lb.

Assuming that the working stress in the tie rod is 16,000 lb. per sq. in., the area required is $\frac{82,800}{16,000} = 5.27$ sq. in. Two $4 \times \frac{3}{4}$ -in. eye-bars furnish 6.0 sq. in. If the allowable bearing on a concrete foundation is taken

6.0 sq. in. If the allowable bearing on a concrete foundation is taken

as 400 lb. per sq. in., the area of the base of the shoe must be $\frac{106,610}{400} = 266$ sq. in. The shoe shown in Fig. 95 provides a base area of $15 \times 20 = 300$ sq. in.

Design methods for the pin connecting the shoe, tie rod, and truss are given in the section on Splices and Connections—Steel Members in the volume on "Structural Members and Connections." The size of the pin is determined subject to the following conditions: The bearing areas between the members and the pin must be sufficient to keep the bearing pressures within the allowable limits, which will be taken as 24,000 lb. per sq. in., and, the extreme fiber stress due to bending, considering the pin as a simple beam, must be within the allowable limits, which will be taken as 25,000 lb. per sq. in.

The design of the pin is carried out by assuming the size of pin. Having given the maximum load to be carried by the pin, the bearing areas required for the several parts are determined. If the parts abutting on the pin do not furnish the required area, they must be increased by the addition of pin plates until the proper area is provided. Assuming the centers of pressure to be located at the centers of the bearing areas, the bending moments due to the applied loads are calculated and compared with the resisting moment provided by the assumed pin. If the assumed pin is found to be inadequate, the calculations must be revised.

For the case under consideration, a $4\frac{1}{4}$ -in. pin will be assumed. Figure 95 shows the adopted arrangement of the joint details. The load brought by the pin to the shoe is equal to the vertical component of the reaction, which is 106,610 lb. At 24,000 lb. per sq. in., the width of bearing required on the webs of the shoe is $\frac{106,610}{4\frac{1}{4} \times 24,000 \times 2} = 0.518$ in. for each web. Assuming that a cast-steel shoe is used, the webs will be made 1 in. thick, as the use of thinner material is not advisable.

The load brought by the arch to the pin is equal to the resultant of the horizontal and vertical components of the maximum reaction, which is due to dead load and snow load on both arms of the arch. For the components given above, this load is $(82,800^2 + 106,610^2)^{\frac{1}{2}} = 135,000$ lb. The width of bearing required at the lower end of the arch truss is $\frac{135,000}{4\frac{1}{4} \times 24,000} = 1.32$ in. Since the main gusset plate at joint A is $\frac{1}{2}$ in. thick, the width of bearing must be increased by the addition of pin plates. Figure 95 (a) shows the adopted detail. The main angles are spread somewhat, and the space between the angles is filled by means of $\frac{5}{8}$ -in. plates placed on both sides of the gusset plate. To stiffen the plates, and also to tie the main angles together, a $6 \times 4 \times \frac{3}{8}$ -in. angle is riveted on each side of the plates. The total thickness of bearing provided by this detail is $2\frac{1}{2}$ in., which is in excess of that required, but as a rigid detail is desired, it is not advisable to use a smaller number of plates.

The bending moment on the pin can be determined by calculating the moments due to the vertical and horizontal forces, and finding their resultant. Figure 95 (c) shows the components of forces and the lever arms. These lever arms are determined for the packing shown in Fig. 95 (b). A clear space of $\frac{1}{4}$ in. is provided between the several members. From Fig. 95 (c), the vertical component of moment is $53,305 \times 3.0 = 159,915$ in.-lb., and the horizontal component of

moment is $41,400 \times 1.125 = 46,600$ in.-lb. The resultant moment is then $(159,915^2 + 46,600^2)^{1/2} = 167,000$ in.-lb. From the tables of bending moments on pins, it will be found that the safe moment on a $4\frac{1}{4}$ -in. pin for an allowable fiber stress of 25,000 lb. per sq. in. is 188,410 in.-lb. The assumed pin will be adopted.

The pin plates which were added to the gusset plate at point *A*, in order to increase the width of bearing on the pin, must be fastened to the gusset plate so

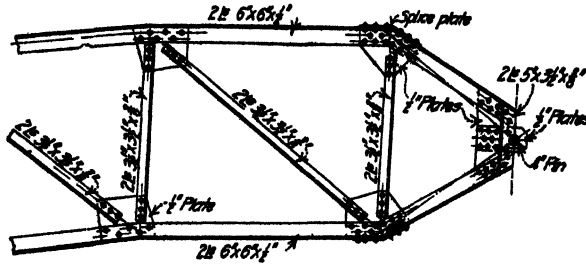

FIG. 97.

that all plates will act as a unit. Assuming that the load carried by each plate is proportional to its thickness, the load carried by each $\frac{3}{8}$ -in. angle is $135,000 \times \frac{0.375}{2.5} = 20,600$ lb., and the load carried by each $\frac{5}{8}$ -in. filler plate is $135,000 \times \frac{0.625}{2.5} = 33,800$ lb. As shown in Fig 95 (a), the rivets connecting the

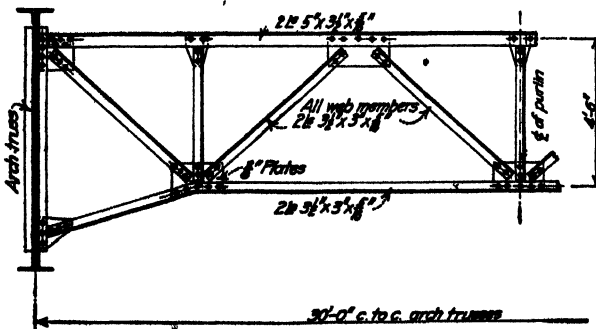

FIG. 98.

$6 \times 4 \times \frac{3}{8}$ -in. angles to the plates are in double shear, when both angles are assumed to act together. For the allowable shearing value given above, the double shear value of a rivet is 14,400 lb. Assuming that the two angles act together, the total load to be carried is $2 \times 20,600 = 41,200$ lb., and the number of rivets required is $\frac{41,200}{14,400} = 3$ rivets. The detail of Fig. 95 (a) shows three rivets close to the pin and four others at the ends of the angles. Assuming that the $\frac{5}{8}$ -in. filler plates and the angles on each side of the gusset plate act together, the total load to be carried is $2(33,800 + 20,600) = 108,800$ lb. As shown in Fig 95. (a), the connecting rivets are in bearing on the $\frac{1}{4}$ -in. gusset plate,

and hence the number of rivets required is $\frac{108,800}{10,500} = 11$ rivets. Figure 95 (a) shows 14 rivets in place in the filler plates and the angles.

Figure 96 shows the details of a shoe designed to carry the vertical and horizontal components of the reactions. The slope of the base of the shoe is determined by the condition that it should be perpendicular to the resultant of the maximum reactions. Figure 96 (b) shows the amount and direction of the resultant reactions due to all possible combinations of dead and snow or wind load reactions. These resultants were plotted from the values given in Table 16. It will be noted from Fig. 96 (b) that the reactions lie close together, and that a plane $x-y$ at a slope of 8 in. in 12 in. is normal to the average direction of these resultants.

The base area required on the line $a-b$ must be sufficient to provide for the maximum reaction of 135,000 lb. which occurs for dead load and snow load on both sides of the arch. It is usual to provide a short horizontal base area, shown by $a-c$ of Fig. 96 (a). All details are as shown on Fig. 96. The design methods are similar to those used for Fig. 95.

Figure 97 shows the details of the pin joint at the crown hinge, and a portion of the truss. The design methods for the pin and the pin plates, and for the end connections of the members, are the same as for the detail of Fig. 95.

55. Bracing for Arch Trusses.—The general plan of the bracing for an arch truss is quite similar to the one designed in the chapter on the Detailed Design of a Truss With Knee-Braces. Since the trusses are large and must be rigidly braced, lateral systems are generally placed between every other pair of trusses. In the plane of the vertical side walls, bracing is placed in every bay. A very good idea of the form and arrangement of the required bracing can be obtained from the description of the University of Illinois drill hall, which is given in the *Eng. News* for Dec. 11, 1913, and from the description of the Springfield Coliseum given in *Eng. Rec.* for Oct. 7, 1916, to which the reader is referred.

The trussed purlins which connect the trusses at alternate panel points form part of the bracing as well as acting as purlins. Figure 98 shows the details of these purlins, which are connected to the vertical truss members at the points shown in Fig. 90. The purlins are designed to carry the roof load and the maximum snow or wind loads. Figure 98 shows the adopted sections. The lower chord members of the end panels are sloped so that the lower chord member of the purlin is connected to the vertical members of the arch near the foot of these members.

ORNAMENTAL ROOF TRUSSES

56. Architectural Timber Work.—Architectural timber work is an important element of interior design, especially in churches. The roof structure is frequently of wood, using the hammer beam truss where the roof is high. In buildings with low pitched roofs the braced arch is most common. This form of construction brings some thrust upon the walls, which must be counteracted by buttresses or extra heavy masonry. The roof design concerns not only the trusses, but the purlins, rafters and sheathing as well, all of which may be decorated to a greater or less degree. Structural considerations must be modified and supple-

mented to meet architectural requirements. Members of no structural value may be introduced; stresses must be provided for without too great insistence on economy of materials. As a general rule, horizontal and vertical members are satisfactory, together with arched members. Large diagonal members are usually disappointing in perspective. The timbering is sometimes covered with "boxing" of more expensive wood, but the effect is usually poor as compared with

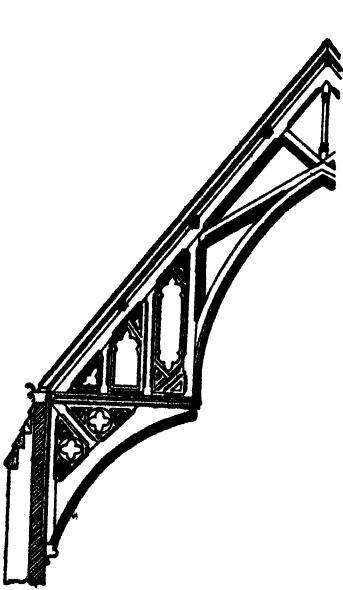

FIG. 99—Hammer beam with scissors truss above.

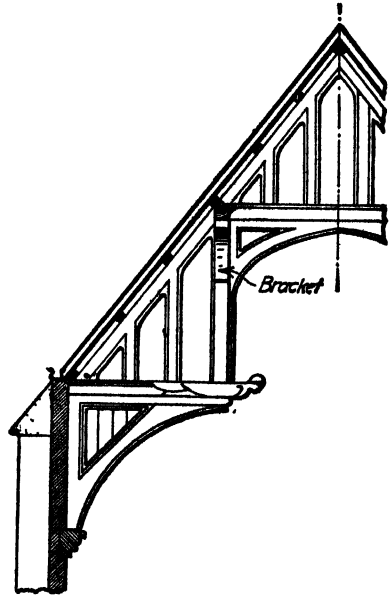

FIG. 100—Hammer beam with A-truss

actual beams. Laminated beams are frequently used. The laminations may be masked by mouldings and decorative elements. The advantage lies in the good connections and masked joinings secured. Steel rods should not be exposed. A few examples of ornamental trusses are shown.

Figures 99 and 100 show hammer beam trusses of the usual form. In the first a scissors truss is used over the hammer beam. In the second a rafter and tie beam are used. Figure 101 shows an approximation to the hammer beam truss, but depends for its strength partly on the rigidity of the members. This truss should be built of seasoned lumber and should be gone over and the bolts tightened up after being in service for about a year.

Figures 101 and 102 show high pitched roofs supported by a timber arch. The arched members add something to the rigidity of the structure and a great deal to appearance. Figure 104 shows a low pitched roof supported by a king post truss with a timber arch below. The construction of this truss will be entirely masked by the decoration. Figures 102, 103 and 104 are from buildings near Oxford, England.

Figure 105 is a modification of the low pitched truss type, formed of doubled timbers and a few false members. This truss should be supported on quite rigid

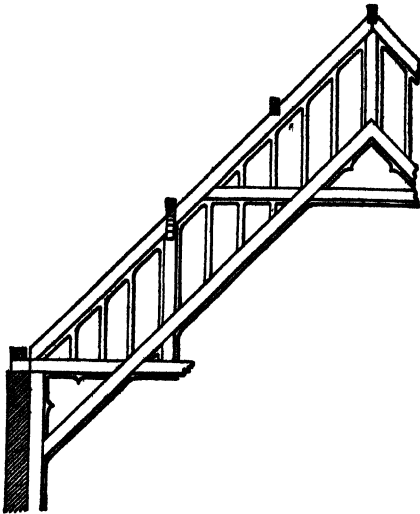

FIG 101 —Laminated truss.

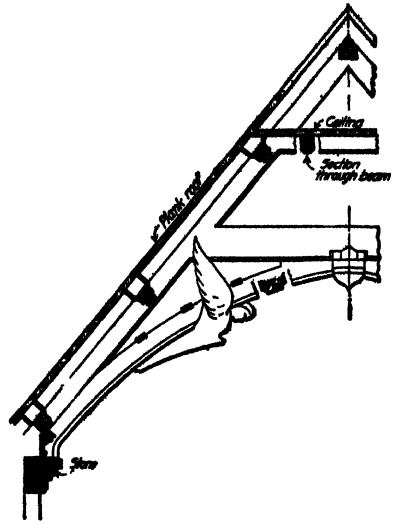

FIG 102 Braced arch (St John's College, Oxford).

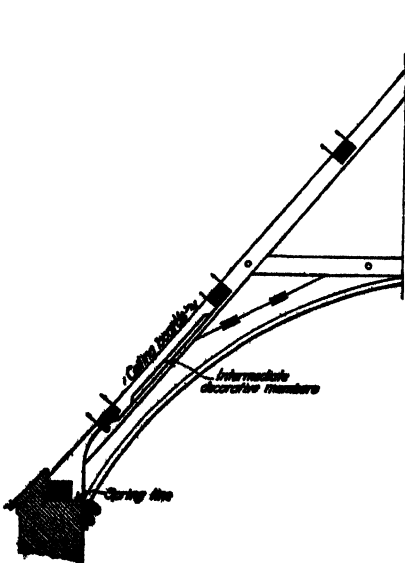

FIG. 103.—Braced arch and rafter.

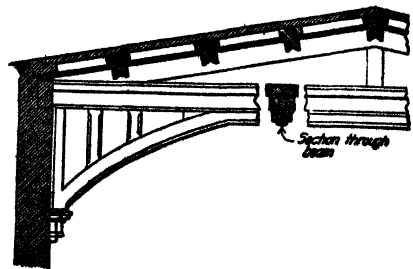

FIG 104—King post truss and bracket (Bodleian Library).

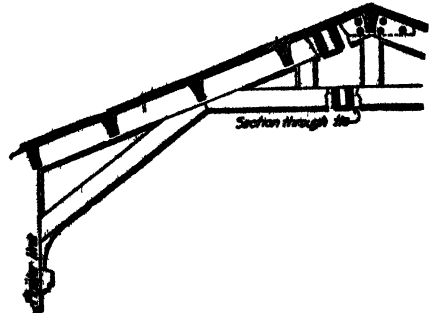

FIG. 105.—Braced rafter.

posts built into the wall. The action of the post and bracket is that of a cantilever, to which the upper chord is fastened.

Figure 106 shows a scissors truss. This form of support is less meritorious architecturally and structurally, but is much used on cheap work. Its principal merit is the arched effect of the slanting members.

The span of all the above trusses is taken, for convenience, at 28 ft. Spans of much greater width may require an attic space with concealed trusses. In this event the interior will show the ceiling only, which will be supported from above.

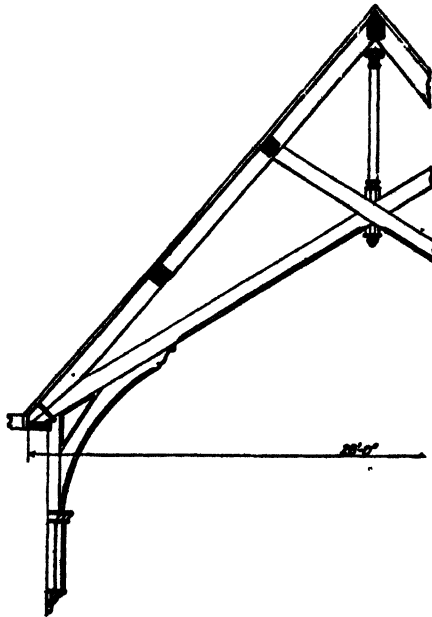

FIG. 106.—Scissors truss.

57. Analysis of Stresses in a Scissors Truss.—The stresses in a truss of the Scissors type, shown in Fig. 106 of Art. 56 are readily determined by the methods of stress analysis given in the volume on "Stresses in Framed Structures." Panel loads due to dead and wind loads are determined by the methods used in the preceding chapters on roof truss design. As the roof slope is generally quite steep, snow loads need not be considered.

To illustrate the methods of stress analysis for trusses of this type, the stresses in the truss of Fig. 107 will be determined for dead and wind loads. Panel loads for dead and wind load, determined by the usual methods, are shown in position on Fig. 107 (a). The dead load stress diagram is shown in Fig. 107 (b), and the wind load stress diagram is shown in Fig. 107 (c). Table 17 gives the resulting stresses for dead and wind loads, and also the maximum stresses due to combined dead and wind loads.

Roof trusses of the scissors type are usually constructed of wood, with the exception of the vertical member *C-E* of Fig. 107 (a), for which a steel rod is used. Experience has shown that the elastic deformation of the members of a scissors truss results in a considerable horizontal movement of the points of support. To reduce the amount of this movement, it is the general practice to use excess area in the top and bottom chord members. For the truss of Fig. 107 (a) it will probably be advisable to use 6- × 10-in. wooden pieces for all members except the

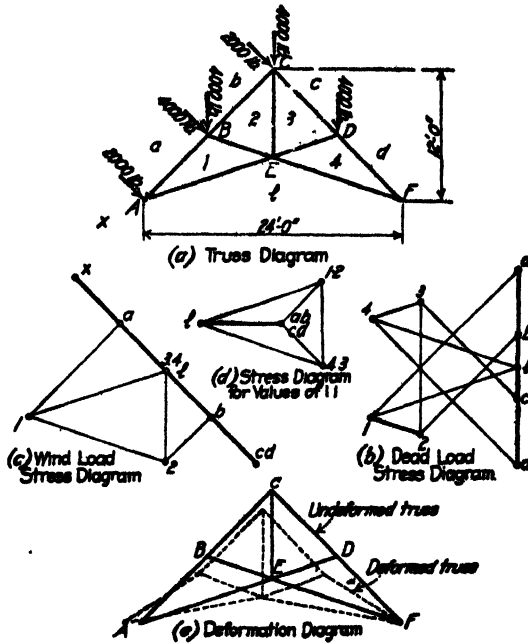

FIG. 107.

middle vertical, which will be made of a 1½-in. round steel rod. Typical joint details applicable to the truss under consideration are shown in Art. 60.

The horizontal movement of the points of support of the truss of Fig. 107 (a) can be calculated by means of the equation

$$D = \sum \frac{Sl}{AE} u \tag{1}$$

where *D* = deflection of any point; *S* = stress in any member; *A* = area of any member; *l* = length of any member; *E* = modulus of elasticity of the material composing the members; and *u* = a ratio which is equal to the stress in any member due to a 1-lb. load applied at the point whose deflection is desired and acting in the direction of the desired deflection.

TABLE 17.—STRESSES IN A SCISSORS TRUSS
(FIG. 107)

Member	Dead load	Wind right	Wind left	Max. stress
AB	-12,750	-4,000	-4,000	-16,750
BC	-8,600	-2,000	-4,000	-12,600
AE	+9,600	+4,500	0	+14,100
BE	-3,120	-4,500	0	-7,620
CE	+8,250	+2,800	+2,800	+11,050

+ = tension. - = compression.

TABLE 18.—HORIZONTAL DEFLECTION OF POINTS OF SUPPORT
CALCULATION OF THRUST ON WALLS
SCISSORS TRUSS
(FIG. 107)

Member	Stress	l	A	$\frac{l}{AE}$	$\frac{Sl}{AE}$	u	$\frac{Sl}{AE}u$	$\frac{l}{AE}u^2$	$\frac{-Hu}{H=6,510 \text{ lb.}}$	S
	1	2	3	4	5	6	7	8	9	10
AB	-16,750	102	52.2	0.000001955	-0.0328	-0.707	+0.0233	0.000000977	+4,610	-12,140
BC	-10,600	102	52.2	0.000001955	-0.0208	-0.707	+0.0148	0.000000977	+4,610	-5,990
CD	-12,600	102	52.2	0.000001955	-0.0246	-0.707	+0.0175	0.000000977	+4,610	-7,990
DF	-16,750	102	52.2	0.000001955	-0.0328	-0.707	+0.0233	0.000000977	+4,610	-12,140
AE	+14,100	152	52.2	0.000002905	+0.0410	+1.58	+0.0648	0.00000725	-10,300	+2,800
EF	+9,600	152	52.2	0.000002905	+0.0279	+1.58	+0.0441	0.00000725	-10,300	-700
BE	-7,620	76	52.2	0.00001403	-0.0111	0	0	0	0	-7,620
DE	-3,120	76	52.2	0.000001403	-0.00455	0	0	0	0	-3,120
CE	+11,050	96	1.77	0.000001810	+0.0200	+1.00	+0.0200	0.00000181	-6,510	+4,540
							+0.2078	0.00002023		

For the truss under consideration, the deflection of the left end, *A* of Fig. 107 (*a*), will be determined with respect to the right end, point *F*, which will be assumed to stand fast. This deflection will be determined for the maximum stresses in all members due to the dead and wind load stresses, as given in Table 17. These maximum stresses are recorded in Table 18. The lengths and areas of the several members are also given in Table 18. Lengths of members are given in inches, and areas are given in square inches. As assumed above, the main members are composed of a 6- × 10-in. piece. Assuming that dressed lumber is used, the area is calculated as for a 5½- × 9½-in. section to conform to the methods used in the chapter on Detailed Design of a Wooden Roof Truss. The moduli of elasticity of wood and steel are taken respectively as 1,000,000 and 30,000,000 lb. per sq. in.

Since the horizontal motion of point *A* is desired with respect to point *F*, the values of *u* as defined above, are to be calculated for a 1-lb. load applied at *A* and acting horizontally. It will be assumed that the 1-lb. load acts to the left. A positive sign for the resultant deflection will indicate that the direction of the deflection was correctly assumed. If the sign is negative, the true deflection is to

the right. Values of u were calculated by means of the stress diagram of Fig. (d), and the stresses are recorded in Table 18.

The desired deflection is determined by calculating the value of the term $\frac{Sl}{AE}u$ for each member, and adding all such terms, paying particular attention to the sign of each result. It is to be noted that for stress, plus indicates tension and minus indicates compression. In multiplying the several values, like signs result in plus signs, and unlike signs result in minus signs. The resulting values are given in Table 18 under the proper heading, and at the foot of the column is given the sum of all terms, which is the desired deflection. The result, $+0.2078$, indicates that point A moves to the left, 0.2078 in.

A study of the values of $\frac{Sl}{AE}u$ given in Table 18, col. 7, shows that about 80 per cent of the total deflection calculated above is due to the elastic distortion of members $A-B$ and $D-F$, the lower ends of the top chord member, and $A-E$ and $E-F$, the lower chord member. Since the deflection contributed by any member is inversely proportional to the area of that member, it follows, as stated above, that large members with considerable excess area should be provided for the chord members in order to reduce the horizontal movement of the supports.

By calculations similar to those given in Table 18, the vertical and horizontal components of the deflection of all points of the structure have been calculated. The dotted lines of Fig 107 (e) show the distorted position of the truss, and the full lines show the undeformed truss. In plotting the movement of the several points, a scale was used which shows these movements at about 150 times their value to the scale of the truss. Hence, as plotted, the actual movement of the joints is greatly exaggerated. This is done in order to show the relative rather than the actual movement of the joints.

The diagram of the deformed truss brings out some points which should be considered in selecting the form of the members for trusses of this type. It will be noted that members $A-B-C$ and $C-D-F$ are bent out of line due to the deformation of the structure. If these members are made continuous, which is the usual practice, heavy secondary bending moments are set up at the middle points of the members. Since the fiber stresses in the members due to these moments are proportional to the depth of the member, it follows that the depth of the member in the direction of the bending should be as small as possible, in order to avoid excessive fiber stresses. In the case of the 6- \times 10-in. members adopted for the design under consideration, the 6-in. face should be placed in the vertical direction and the 10-in. face should be placed horizontal. This would probably not fit in with the architectural features of the design. However, since considerable excess area is provided in these members, the total combined fiber stress with the 10-in. face placed vertical will probably be within the allowable limits. Everything considered, square sections are preferable for trusses of this type.

The ends of trusses of the scissors type are generally rigidly fastened to the supporting walls by means of anchor bolts or by a base plate bedded in the masonry. After the trusses have been erected, the roofing and other applied loads are added as the construction proceeds. On the removal of the erection falsework or other temporary construction supports, the full loads are applied to the trusses, which tend to deform, causing the points of support to move horizontally,

as calculated above. Since the trusses are generally rigidly fastened to the walls, as stated above, the walls are forced outward due to the resistance offered to the horizontal motion of the ends of the truss. Horizontal forces are therefore set up which cause bending moments in the walls. These moments, and the resulting fiber stresses, are a maximum at the foot of the walls. If the fiber stresses are excessive, the walls will be cracked at the base. To avoid failure of the walls due to this cause, the bending moments and fiber stresses must be estimated and a wall thickness adopted which will offer the required resistance. If one end of the truss is allowed to move freely as the loads are applied, the walls will be relieved of the

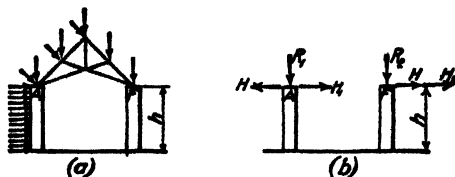

FIG. 108

greater part of the bending moment mentioned above. However, this is not the usual practice. In view of this fact, methods will be given for the determination of the horizontal forces which must be resisted by the walls.

The methods of calculation for the determination of the thrusts at the tops of the walls due to the deformation of a scissors truss are similar to those used in Art. 51*b* for the determination of the reactions for a two-hinged arch. Let Fig. 108 (a) show a scissors truss, or any other type of truss in which the elastic deformation of the members produces thrusts on the supporting walls. To make the solution general in nature, vertical and inclined applied loads are shown in position. Consider the truss removed from the walls, and represent the action of the trusses on the walls by the forces shown in Fig. 108 (b). The forces H represent the thrusts at A and F due to the deflection of the truss. Evidently these forces are equal in amount and act in opposite directions, as shown in Fig. (b). The forces H_1 , H_2 , R_1 , and R_2 represent the action of the applied vertical and inclined loads, and are calculated by the methods of statics given in the volume on "Stresses in Framed Structures," considering the truss as a free body removed from its supports.

The forces H_1 and H_2 include the effect of the wind on the vertical sidewalls. This effect is indeterminate, but it is sufficiently accurate to assume that the moment due to the horizontal wind load is equally divided between the two walls. It will therefore be assumed that the truss, acting as a strut between the two walls, transfers to the top of the right-hand wall, a load which will produce the assumed moment at the base of the wall. If w = wind load per foot of wall, and h = height of wall, the moment to be carried by each wall is $M = \frac{1}{4}wh^2$. On the assumption made above, the load at the top of each wall is $P = \frac{M}{h} = \frac{1}{4}wh$.

Assuming that the truss is rigidly fastened to the walls, it is evident that the horizontal movement of points A and F of the truss is equal to the horizontal movement of the tops of the walls, points A and F of Fig. 108 (b). For the determination of H , the thrust of the trusses on the walls, an equation of elastic

equilibrium can be established by equating the deflection of the truss, as calculated by eq. (1), to the combined deflection of the walls for the forces shown in Fig. 108 (b).

The values of S to be used in eq. (1) for the determination of the horizontal motion of points A and F of the truss are the actual stresses in the members. These stresses include the effect of the thrust H and the effect of the applied loads. As stated in Art. 51 in connection with the derivation of eqs. (8) and (10), these stresses can be expressed in the form

$$S = S' - Hu \tag{2}$$

where S = actual stress in any member; S' = stress in any member due to the applied loads for the truss considered as removed from the walls and considered as a simple truss; H = thrust on the walls; and u = a ratio defined above for eq. (1). Substituting this value of S in eq. (1), the horizontal movement of point A of the truss with respect to point F is

$$\Delta = \sum \frac{S'l}{AE} u - H \sum \frac{l}{AE} u^2 \tag{3}$$

The deflection of the walls due to the applied loading shown in Fig. 108 (b) depends on the form of the walls. If they are of uniform cross-section for the full height, they form simple cantilever beams acted upon by the horizontal forces shown in Fig. 108 (b). The effect of the vertical loads R_1 and R_2 on this horizontal deflection is so small that it will be neglected. The deflection of a simple cantilever beam due to a load P is given by the expression $\Delta = \frac{Pl^3}{3EI}$. To reduce

this value to a general expression adaptable to all forms of walls, the term $\frac{l^3}{3EI}$ will be called the deflection coefficient of the wall. In the work to follow, this coefficient will be denoted by k , using subscripts 1 and 2 respectively to indicate the left- and right-hand walls. With this notation, the total movement of points A and F of Fig. 108 (b) for the forces shown, is given by the expression

$$\Delta = (H - H_1)k_1 + (H + H_2)k_2$$

from which

$$\Delta = H(k_1 + k_2) - H_1k_1 + H_2k_2 \tag{4}$$

Equating eqs. (3) and (4) and solving for H , we have

$$H = \frac{\sum \frac{S'l}{AE} u + H_1k_1 - H_2k_2}{\sum \frac{l}{AE} u^2 + (k_1 + k_2)} \tag{5}$$

which is a general expression for the thrust on the walls due to a rigidly attached truss of the type shown in Fig. 107.

To illustrate the application of eq. (5) to a given set of conditions, certain assumptions will be made regarding the walls supporting the truss of Fig. 107 and the resulting thrust on these walls will be calculated. Suppose that the truss under consideration is rigidly attached to a masonry wall 18 in. thick and 15 ft. high, and assume that because of window openings, a section of wall 8 ft. long is available to resist the thrust of the trusses, which will be assumed to be 16 ft. apart.

For the applied dead and wind panel loads shown in position on Fig. 107 (a), it can be shown that $H_1 = H_2 = 2,800$ lb. To this load must be added the effect of wind on the side walls. As stated above, this effect will be assumed to be due to a load $\frac{wh}{4}$, where w = load per foot of wall. For a 30-lb. wind load acting on a 15-ft. wall, trusses 16 ft. apart, $\frac{wh}{4} = \frac{1}{4} \times 30 \times 16 \times 15 = 1,800$ lb. The total horizontal load is then $H_1 = H_2 = 2,800 + 1,800 = 4,600$ lb. Since the walls are alike, and are simple cantilever beams of height h , the value of the deflection constant, as defined above, is

$$k_1 = k_2 = \frac{h^3}{3EI}$$

where E = modulus of elasticity of the material composing the wall, which will be assumed to be 3,500,000 lb. per sq. in.; and I = moment of inertia of the wall section, which is given by the formula $I = \frac{1}{12} b d^3$. For the assumed conditions, $h = 15$ ft. = 180 in.; b = effective width of wall = 8 ft. = 96 in.; and d = thickness of wall = 18 in.; and

$$k = \frac{(180)^3}{(3)(3,500,000)(\frac{1}{12})(96)(18)^3} = 0.0000119$$

The term $H_1 k_1 - H_2 k_2$ of eq. (5) can readily be seen to be equal to zero for the assumed conditions. Table 18 gives directly the term $\sum \frac{S'l}{AE} u$, for the stresses S' are exactly the same as given by Table 17. The term $\sum \frac{l}{AE} u^2$ is readily calculated from the values given in Table 18. Column 8 gives the several values and the required summation. The value of $k_1 + k_2 = 2k$ can be determined from the calculations given above. Substituting these values in eq. (5), we have

$$H = \frac{0.2078}{0.00002023 + 0.00002380} = 4,710 \text{ lb.}$$

which is the thrust of the trusses on the walls for the assumed conditions.

The combined fiber stress in the walls due to the bending moments induced by the total horizontal loads at the tops of the walls must be investigated. From Fig. 108 (b), it can be seen that the maximum fiber stress will occur at the inside lower edge of the right-hand wall. This fiber stress is to be determined for bending due to horizontal forces and compression due to the weight of the wall and the truss reactions at the wall. As stated above, $H_2 = 4,600$ lb. Hence the total horizontal force is $H + H_2 = 4,710 + 4,600 = 9,310$ lb., and the bending moment at the foot of the 15-ft. wall is $9,310 \times 180 = 1,675,500$ in.-lb. Since the wall section is rectangular, the fiber stress due to bending is $f_b = \frac{6M}{bd^2}$, where b = effective width of wall = 96 in., and d = thickness of wall = 18 in. Hence

$$f_b = \frac{(6)(1,675,500)}{(96)(18)^2} = 324 \text{ lb. per sq. in.}$$

This fiber stress is tensile on the inside edge of the wall. The compression at the same point due to the weight of the wall and the truss reaction is equal to the total load divided by the effective area. Assuming that the material composing

the walls weighs 160 lb. per cu. ft., the weight of the wall is $8 \times 1.5 \times 15 \times 160 = 28,800$ lb. From Fig. 107 (a), the vertical truss reaction at point F is 10,800 lb. Hence the total vertical load is $28,800 + 10,800 = 39,600$ lb. For an effective section of wall 18×96 in., we have

$$f_c = \frac{39,600}{(18)(96)} = 23 \text{ lb. per sq. in., compression}$$

The resultant fiber stress on the fiber in question is then $f = f_b - f_c = 324 - 23 = 301$ lb. per sq. in., tension. If the material composing the wall is capable of withstanding this tensile stress, the assumed wall is satisfactory; if not, the wall section must be revised. It was found that a 36-in. wall is required if no tension is allowed on the masonry. As walls of this thickness are expensive, it is probable that some type of buttressed wall would be adopted.

The horizontal thrust on the walls is often determined on the assumption that the walls are absolutely rigid. Equation (5) can be made to cover this condition by noting that, in general, $k = \frac{h^3}{3EI}$. For an absolutely rigid wall, it is evident that I , the moment of inertia is infinite. Hence all values of k are equal to zero, and eq. (5) becomes,

$$H = \frac{\sum \frac{S'l}{AE} u}{\sum \frac{l}{AE} u^2}$$

From the values of these terms given in Table 2

$$H = \frac{0.2078}{0.00002023} = 10,250 \text{ lb.}$$

Note the effect of the elastic deformation of the walls on the value of H , as shown by comparing this value of H , calculated for a rigid wall, and the value calculated above for an elastic wall.

After the value of H has been determined for any assumed set of conditions, the true stresses in the truss members, which must include the effect of the resistance of the walls, can be determined from eq. (2). Columns 9 and 10 give all of the necessary calculations, and col. 10 gives the final stresses. The value of H should include the effect of wind on the side walls. Hence for the 18-in. wall, $H = 4,710 + 1,800 = 6,510$ lb.

58. Analysis of Stresses in a Hammer-beam Truss.—A typical framework for a hammer-beam truss is shown in Fig. 109 (a). The curved members near the center of the truss, and all other members which are used for ornamental purposes, have been removed. Figures 99 and 100 of Art. 56 show complete trusses of this type.

As shown by Fig. 109 (a), a typical hammer-beam truss can be considered to be composed of three parts. These parts consist of a truss, shown by DFK , and two parts, shown by $ABDH$ and the corresponding part on the right, which contains the hammer-beam BH . The entire framework is supported at A and L by masonry walls which are continued upward to the level of point B .

Strictly speaking, a truss of the form shown in Fig. 109 (a) is statically indeterminate, for the top chord member BDF is generally made continuous from end to end. Also, the portions of the truss containing the hammer-beams are generally rigidly fastened to the masonry walls. However, by assuming that the hammer-beam portion of the truss is supported at the masonry wall, point A of Fig. 109 (a), by a hinge-like detail, and also that the connection between the truss DFK and the hammer-beam is a hinge, the stresses become statically determinate.

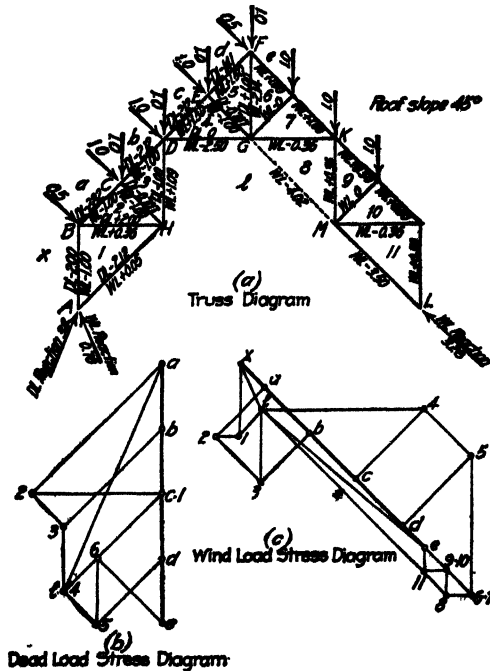

FIG. 109.

These assumptions are reasonable, for at joint D only the resisting moment offered by the chord section is opposed to any distortion of the structure. This resistance is not great, and can be neglected without sensible error. A rigid connection between the wall and the hammer-beam portion of the truss is hard to make, and it is therefore likely that the assumed conditions closely approximate the actual conditions.

Under symmetrical vertical loads, the truss shown by the full lines of Fig. 109 (a) is a stable structure. To hold the several parts of the framework in equilibrium, the reactions at A and L must be inclined to the vertical. When the structure is subjected to inclined loads, such as wind loading, the full line framework of Fig. 109 (a) is not in stable equilibrium. Additional members must be provided which will offer the resistance necessary to prevent collapse of the structure. This resistance to distortion is provided by the curved members joining points HG and GM . The end connections of these members can be so arranged that they will take compression only. In this respect these members form counters, which act only under unsymmetrical loading. It is to be noted

that the reactions at the points of support are inclined to the vertical for all conditions of loading. These reactions must be determined and the wall section proportioned accordingly. This point is important, for the truss action assumed above is based on the fact that rigid supports are available.

The stresses in all members of the truss of Fig. 109 (a) will be determined for vertical panel loads of unity placed as shown on the truss diagram. Since the truss is assumed to be supported by hinges at A and L , and since hinges are assumed at D and K , the reactions at A and L can be determined from the condition that the equilibrium polygon drawn for the applied loads must pass through the points A , D , K , and L . This construction can be carried out by the methods outlined in Art. 51.

Figure 109 (b) is a force diagram constructed for one-half of the structure. By the methods referred to above, it was found that l of Fig. 109 (b) is the pole for the equilibrium polygon passing through points A , D , K , and L of Fig. 109 (a). Hence $l-a$ of Fig. 109 (b) represents to scale, the amount and direction of the reaction at A of Fig. 109 (a). The diagram of stresses in the members is readily constructed. Figure 109 (b) shows the completed diagram. All stresses are indicated on the members, and are denoted by $D. L.$ (dead load).

The stresses in all members of the truss were also determined for unit wind loads acting normal to the left-hand side of the roof surface, as shown on Fig. 109 (a). As stated above, to maintain a stable structure, a curved member GM must be provided. Although the member provided is curved, the stress in this member can be determined as for a straight member connecting G and M . This straight member is shown by dotted lines in Fig. 109 (a). Having given the stress in this straight member, the resulting fiber stresses in the curved member can be determined by the methods given in the chapter on Bending and Direct Stress in the volume on 'Structural Members and Connections.'

Since the presence of the member GM eliminates the hinge at K , the framework can be considered as divided into two parts by the hinge at D . The reactions at A and L for the assumed structure can be determined by constructing the equilibrium polygon which passes through points A , D and L . By the methods referred to above, it will be found that point l of the force polygon of Fig. (c), constructed for the applied loads, is the true pole for the required equilibrium polygon, and that $l-x$ and $l-e$ give the amount and directions of the reactions respectively at A and L of Fig. 109 (a). Figure 109 (c) gives the complete stress diagram as constructed for the applied loads. All stresses are indicated on the members in Fig. 109 (a), and are denoted by $W. L.$ (wind load).

59. Analysis of Combined Trusses.—Roof trusses are often framed by combining two different types of trusses. In Fig. 110, a simple truss, ABC , is supported at the ends by a bracket, ADE , which, together with the walls, forms a cantilever truss ADF . The combined structure thus formed can be analyzed by separating it into its parts. Thus the truss ABC can be analyzed and the reactions and stresses determined. The reaction of truss ABC can then be applied as a load on the bracket ADE of Fig. (b); and the stresses in the members of the bracket and the bending moments at the foot of the wall can readily be determined by the methods used in the preceding chapters.

Combination trusses formed from a simple truss and an arched truss of the ribbed type are often encountered. Figures 102 and 103 of Art. 56 show examples

of this type. In many cases the arch members are used only for decorative purposes, and are not intended to carry loads except possibly their own weight. In other cases it is assumed that both systems assist in carrying the applied loads. Under such conditions, the exact distribution of the applied loads to the two systems offers a very complicated problem. While this problem can be solved by

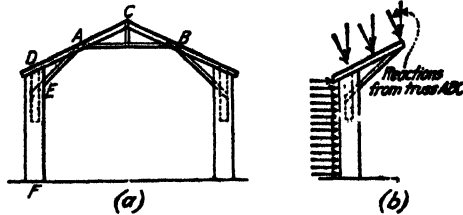

FIG. 110.

methods developed in works on stresses in statically indeterminate structures, in general it can be said that this procedure is not necessary. An experienced designer can generally estimate the probable distribution of loads between the

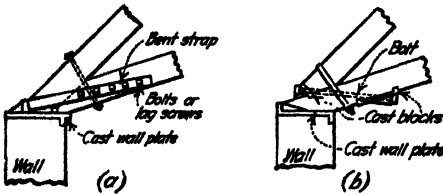

FIG. 111.

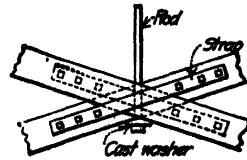

FIG. 112.

two systems. By separating the systems, and treating them as independent structures, an analysis of stresses can be made which will answer all practical purposes.

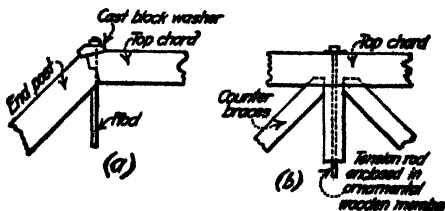

FIG. 113.

60. Typical Joint Details for Ornamental Roof Trusses.—In general, the joint details for ornamental roof trusses are similar to those used in the chapter on a Detailed Design of a Wooden Roof Truss. The framing of members in ornamental roof trusses often calls for joint details in which the members meet at acute angles, and where several members meet in a common point. A few of these special cases will be considered and typical joint details will be shown, without going into the details of the design methods.

Figures 111 (a) and (b) show details for the end joint of a scissors truss. The angle between the chord members is generally so acute that the details shown in the chapter on the Design of a Wooden Roof Truss can not be used. Figure 111 (a) shows a strap connection, and Fig. 111 (b) shows a bolt and cast-block connection.

Another joint of a form not encountered in the simple roof truss designed in a preceding chapter is the one at joint *E* of the truss of Fig. 107 (a). Where single pieces are used for the lower chord members, this detail is made by halving the members at the joint, as shown in Fig. 112. Ornamental iron straps are often added to hold the members in place. Figure 113 shows joint details in common use.

SECTION 3

SHORT SPAN STEEL BRIDGES

STEEL RAILWAY BRIDGES

The principles involved in the design of steel railway bridges are outlined in this chapter, subject to the requirements of the General Specifications for Steel Railway Bridges, 1920 Edition, as presented by the American Railway Engineering Association. The latest American Railway Engineering Association specifications are those of 1941. The 1920 Specifications are printed in full in Appendix A, and portions of the 1941 specifications are printed in Appendix B. These specifications were drafted by a committee composed of members of the engineering staffs of the leading railway and bridge companies of this country and Canada. In the opinion of most bridge engineers, these specifications represent the best practice in the design of simple short span bridge trusses.

In the discussion that follows, the reference to Specifications, preceded or followed by an article number, refers to the named article of the above-mentioned Specifications as given in Appendices A and B. Bold-face numerals in brackets, [], refer to articles in the 1920 Specifications; in braces { }, to the 1941 Specifications.

1. Choice of Type of Structure.—In choosing the type of structure to be used in a given bridge, the item of first cost is generally given first consideration. The total cost of a bridge will be a minimum when the combined cost of the substructure (the foundations) and the superstructure (the trusses or girders) is a minimum. Other items which must be considered in planning a new bridge are the cost of maintaining the structure when in operation, probable life of the structure, and safety of operation for the given traffic conditions. However, these latter items are practically the same regardless of the type of construction. Hence, in general, maximum economy will depend upon the number of spans and type of construction.

The length of span for which the several types of girder or truss bridges are used conforms in general to the recommendations of the Specifications, Art. [9], [102]. These are as follows:

For spans up to 35 ft., rolled beams.

For spans 30 to 125 ft., plate girders.

For spans over 100 ft., riveted or pin-connected trusses.

The type of framing used in truss spans over 100 ft. in length has not been very closely standardised. In general, riveted trusses of the Warren or Pratt type are used for spans from 100 to about 175 ft. In the past, pin-connected trusses have been used extensively for these span lengths. At present, the tendency is to use pin-connected trusses only for the longer spans. For spans from 150 to about 250 ft., riveted or pin-connected spans of the curved chord Pratt

type are used. For spans from 250 to about 500 ft., pin-connected or riveted trusses of the Baltimore, Pennsylvania, or K type are used. The longest simple truss span to date is the 720-ft. Pennsylvania truss used in the Metropolis bridge of the C. B. & Q. Ry. across the Ohio River. For spans over about 500 ft., the general practice has been to use structures of the arch, cantilever, or suspension type. The discussion which follows will be confined to spans of 300 ft. or less.

Rolled beams for spans up to about 35 ft. and plate girders for spans less than about 70 ft. can be built at less cost than any other type of bridge span. The shop costs for fabrication are low and they are quickly and cheaply erected. Although plate girders over 70 ft. in length probably cost somewhat more than truss spans, it is considered good practice to use plate girders for spans up to about 125 ft. Spans of greater length than about 125 ft. are difficult to transport in single pieces because of limited clearance. If long girder spans are made in several pieces and spliced in the field, the extra cost of material and labor required for these splices more than offsets any other advantages which plate girders may have over truss spans of the same length.

The Warren truss in general requires somewhat less material than a Pratt truss of the same span. At present, the general practice is to use riveted trusses for spans up to about 200 ft. In the past, pin-connected trusses were widely used. These structures served very well for the light loads then in use, but for heavy modern loading the light slender eyebar members are not of sufficient rigidity. For spans over 200 ft., the exclusive use of riveted members leads to large joints and wide members. These are objectionable because of the resulting high secondary stresses. Eyebars and pin connections are therefore better adapted for longer trusses. The eyebar members required in long spans are generally large enough to provide the required rigidity.

Deck trusses are in general somewhat cheaper than through trusses of the same span. In deck bridges, the trusses may be placed closer together than in through bridges on account of the clearance between trusses required for the passage of the live load. This reduces somewhat the length of lateral members and floor beams, resulting in a saving of material. Where there are several spans in a bridge, the masonry in deck bridges need not be carried to as great a height as in through bridges, which may easily result in a considerable saving in masonry costs. Where there is only one span, the amount of masonry required for through and deck bridges is practically the same. In general, the deciding factor between through and deck spans is the matter of clearance underneath the structure. In all cases, the lowest steel must be placed well above high water level. Where the surrounding country is low, the cost of fill or trestle approaches to a deck bridge may easily offset the difference in cost between the deck and through bridge and decide in favor of the latter structure.

2. Economical Span Length.—In some cases, the length of span is fixed by local conditions which fix the position of the piers, such as the requirements of the War Department regarding clear waterway, or by foundation conditions which limit the choice of pier locations. When the engineer is free to choose the position of the piers, it is possible to determine fairly closely the position of piers which will produce a structure whose total cost is a minimum. Two general methods for the determination of economical proportions will now be given.

In "De Pontibus," and also in "Bridge Engineering," Dr. Waddell gives the following analysis:

Assume a crossing of indefinite length in which the depth to bed rock is constant. Let S = cost per linear foot of substructure; T = cost per linear foot of trusses and laterals; F = cost per linear foot of the floor system; B = cost per linear foot of the entire bridge; and L = span length. Then

$$B = S + T + F$$

It can reasonably be assumed that slight changes in the length of span will not materially affect the sizes of the piers. Then the cost per foot of the substructure will vary inversely as the span length. Also, the cost of the trusses and laterals may be assumed to vary directly as the span length. The above equation may then be written in the form

$$B = \frac{k}{L} + nL + F$$

in which k and n are constants. Placing the first derivative of this equation, with respect to L , equal to zero, we have

$$S = T$$

This can readily be shown to be the condition which will result in a minimum cost for the structure. Hence, the total cost of a structure will be a minimum when the cost per foot of the substructure is equal to the cost per foot of the trusses and laterals. Note that the cost of the floor system does not appear in the above expression. This is due to the fact that the cost of the floor system per foot is dependent upon the panel length which does change materially for spans of different length. To apply the above analysis to a particular structure, a complete design must be made from which the cost per foot of substructure and of trusses and laterals may be determined. On comparing these quantities, the designer can readily determine the changes required in span length in order to secure the desired structure of minimum cost.

Another method of analysis is given in Part III of "Modern Framed Structures" by Johnson, Bryan and Turneaure. Assume as before that the bridge is indefinite in length and that the depth to bed rock is constant. Let A = cost of end abutments in dollars; B = cost in dollars of the floor and that part of the steel weight which remains constant; C = cost in dollars of one pier, assumed as constant; L = length of bridge in feet; n = number of spans; l = length of one span = $\frac{L}{n}$; p = price of steel in dollars per pound; Y = total cost of bridge; and al = weight of variable portion of steel weight (see discussion and formulas in Art. 3). The total cost of the bridge is given by the following expression

$$Y = A + B + (n - 1)C + (al)Lp$$

Note that the number of piers is one less than the number of spans. On placing the first derivative of this expression with respect to l equal to zero, it can be shown that for a minimum value of Y

$$l = \left(\frac{C}{ap}\right)^{\frac{1}{2}} \quad (1)$$

From eq. (1) it can be seen that the economical span length depends upon the cost of a pier, the price of steel in place, and upon a constant which appears in the formula for weight of the bridge span. The curves shown in Fig. 1 have been plotted for varying values of the several terms. These curves are plotted for four steel prices and for the values of the constant a as given in eqs. (3), (4) and (5) of Art. 3a. In any case, it is generally possible to estimate the cost of a pier

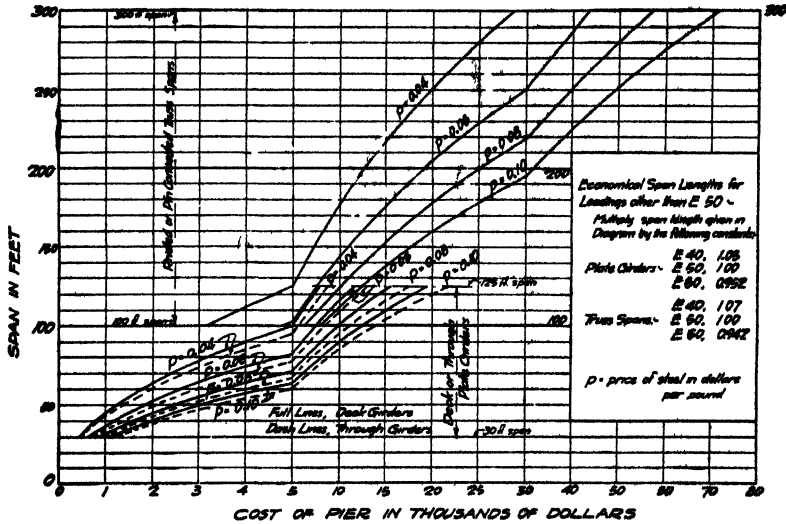

ECONOMICAL SPAN LENGTHS, E50 LOADING
Fig. 1.

by comparison with other similar structures. Knowing the type of structure and the price of steel, the economical span length may readily be determined from Fig. 1.

3. Loads.

3a. Dead Load.—Article [19] of the Specifications gives the weights of material used for track supports and the estimated weight of rails and fastenings. The estimated weight of girders or trusses for standard types of construction may be determined from formulas based on weights of actual trusses. It has been found that this estimated weight may be obtained from a formula of the type

$$w = k(al + b) \tag{2}$$

In this formula w = weight of steel per foot of bridge; l = span in feet; k = a constant depending upon the live load; and a and b are constants dependent upon the span length. It has been found that the weight of stringers and floor beams per foot of bridge is practically a constant for all spans. This weight is represented in eq. (2) by the term b . The weight of the trusses and laterals, per foot of bridge, has been found to vary directly with the span length. It is represented in eq. (2) by the term al .

For spans up to about 300 ft., designed subject to the requirements of the A. R. E. A. Specifications, the following formulas have been found to give fairly reliable results:

Deck Plate Girders

$$w = k(12.5l + 100) \quad (3)$$

Through Plate Girders

$$w = k(14l + 450) \quad (4)$$

In eqs. (3) and (4), use the following values of k :

$$\text{E-40 loading} \quad k = 0.90$$

$$\text{E-50 loading} \quad k = 1.00$$

$$\text{E-60 loading} \quad k = 1.10$$

Values for other loadings may be determined by interpolation.

Riveted and Pin-connected Trusses

$$w = k(8l + 700) \quad (5)$$

In eq. (5), k has the following values:

$$\text{E-40 loading} \quad k = 0.875$$

$$\text{E-50 loading} \quad k = 1.00$$

$$\text{E-60 loading} \quad k = 1.125$$

Values of k for other loadings may be determined by interpolation. Double track bridges weigh about 90 to 95 per cent more than a single track span of the same type.

The weight formulas of eqs. (3) (4) and (5) give values which prove very satisfactory for spans under 300 ft. In these spans the dead load stresses generally form about 15 per cent of the total stress in the shorter trusses and probably not to exceed 40 per cent of the total stress for 300-ft. spans. Hence it is not necessary that the exact dead weight be known. It will generally be found that the true weight and that given by formula are in such close agreement that no revision of dead weight is necessary.

In spans over 300 ft. in length, the proportion of dead load stress to total stress is greater than the limits given above. Spans over 300 ft. are not as common as those less than 300 ft. long. It is therefore not possible to derive reliable formulas which will cover these spans. Due to the magnitude of the dead load stresses in these spans, it is best to estimate the dead weight either from the designer's previous experience or by comparison with some existing span designed for similar loading conditions under the same specification. A design can then be made based on the assumed dead weight. After the design has been completed, the true weight can be determined and revision made in the assumed weight, if an incorrect estimate was made.

3b. Live Load.—The live load recommended by Arts. [20 to 23], [203] of the Specifications is the Cooper loading system and an alternate heavy loading consisting of two concentrated loads. This loading will be found to answer for all ordinary live load conditions.

In recent years a number of very large locomotives for heavy freight service have been constructed. The number and arrangement of drivers and the axle loadings differ widely from those of the Cooper loading system. In an article in *Trans. Am. Soc. C. E.* for May, 1922, Dr. D. B. Steinman has proposed a

set of loadings which closely approximates the loading conditions produced by the heaviest locomotives now in service. These loadings, together with Cooper's loading systems, were recommended in the specifications published in *Trans. Am. Soc. C. E.* for Jan., 1923

In the designs which follow, Cooper's loadings will be used.

3c. Impact.—To account for the dynamic effect of moving loads, which is generally known as *impact*, the stresses due to live load, considered as a static load, are increased by an arbitrary factor known as the *impact coefficient*. Articles [28], [206, 207] of the Specifications gives the impact coefficient recom-

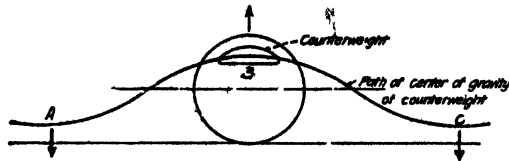

FIG 2

mended by the A. R. E. A. This impact coefficient is based on tests made by a committee of the A. R. E. A. under the direction of Dean F. E. Turneure of the University of Wisconsin. A complete record of these tests and the resulting conclusions are given in *Bull. 125* of the A. R. E. A.

In the above mentioned bulletin it has been shown that the principal cause of impact under locomotives is the effect of unbalanced rotating weights in the drivers. These weights are present in the form of counterweights used to balance the reciprocating parts of the locomotive mechanism. While the rotating and reciprocating parts of the locomotive are balanced, as far as the engine itself is concerned, it will be found that with respect to the track and its supports there are in existence unbalanced forces which may have considerable effect on a bridge when the locomotive is running at high speed.

Figure 2 shows a locomotive driver with a counterweight at B. The path of the center of gravity of this weight during the forward motion of the locomotive is shown by the curve ABC. When the weight is at A or C, the centrifugal force due to the rotation of the wheel is directed downward, as shown. When the weight is at B, its centrifugal effect is directed upward. It is therefore evident that there is exerted on the structure an alternating upward and downward force tending to set the structure into vibration. When the period of vibration of the structure and the period of rotation of the moving weight are equal, the amplitude of vibration of the structure is cumulative and may cause large additional or impact stresses.

The curve of Fig. 3 (a) shows the deflection curve of a structure due to a slowly moving load. If the period of rotation of the moving load and the period of vibration of the truss are equal, cumulative vibrations are set up and the deflection curve for the rapidly moving load becomes as shown by Fig. 3 (b). The saw-toothed curve shows the effect of the alternating upward and downward forces on the deflection of the structure. As shown in Fig. 3 (b), one-half the amplitude of the cumulative vibration represents the impact effect. Other causes of impact are also mentioned in the A. R. E. A. bulletin. These include effect of roughness of track such as rail joints and play between wheels and rails, and eccentric wheels and defective springs under cars which tend to produce a vibratory effect on the bridge. These causes of impact are not as readily measured as those due

to rotating counterweights. In general it seems probable that their effect is no greater than those due to rotating counterweights.

3d. Lateral Forces.—A bridge truss is subjected to lateral loading due to wind pressure on the exposed surface of the truss and the train loading which it supports. Also, the side swing of the locomotive and train due to play between the wheels and rails, the side sway of the rolling stock due to action of the car and engine springs, and unbalanced forces in the locomotive all tend to exert lateral forces on the structure.

To account for these lateral forces, the effect of wind pressure is taken as about 30 lb. per sq. ft. of exposed surface, or as a uniform moving load. Articles [32] and [33], {209, 210} of the Specifications give the values recommended by the

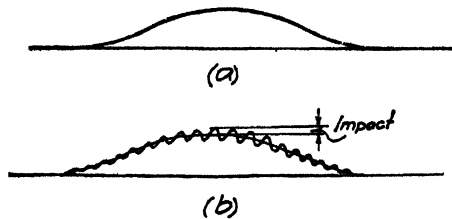

FIG 3

A. R. E. A. The lateral loads due to forces set up by the rolling stock are generally estimated as a percentage of the specified train load. The recommendations of Art. [32] of the Specifications fix this load as 700 lb. per ft.

3e. Other Loads.—In addition to the loads mentioned above, centrifugal forces, due to curved track and longitudinal forces due to sudden application of brakes, are also taken into consideration. The probable amount of these forces is given in Arts. [36], {208} and [37], {214} of the Specifications.

4. Design of Steel Railway Bridges.—To illustrate the design methods in general use, the computations will be given in detail for the design of simple, short span bridges. These designs will include I-beam spans, plate girder spans, and riveted and pin-connected truss spans. All designs will be governed by the requirements of the 1920 A. R. E. A. Specifications. However, in certain cases, where changes have been made in the Specifications, reference will be made to those articles of the 1941 Specifications which apply. The designs might also be made in accordance with the provisions of the 1941 A. R. E. A. Specifications.

5. I-Beam Bridges.—Design an I-beam bridge of 18-ft. span center to center of bearings. Assume Cooper's E-60 loading. A timber floor consisting of ties and guard rails will be used. The arrangement of I-beams shown in Fig. 4 (b) will be adopted. Four lines of beams are used, two under each rail. The beams are placed 1 ft. apart to facilitate fabrication.

5a. Design of Wooden Floor.—From the Specifications, the wooden ties are to be designed for an axle load of 75,000 lb. (Fig. 3, Art. [30], Specifications). A working stress of 2,000 lb. per sq. in. is to be used; the axle load is to be divided over three ties; and the impact allowance is to be taken as 100 per cent of the live load (Art. [34], Specifications). For the conditions shown in Fig. 4, the moment under each rail, assuming the tie to act as a simple beam between I-beams, is $\frac{34}{2}(75,000)(12)\left(\frac{34}{2}\right) = 75,000$ in.-lb. The section modulus required for each tie is then $\frac{75,000}{2,000} = 37.5$ in.³ An 8- × 8-in. tie, section modu-

$l u s = \frac{b d^2}{6} = \frac{(8)(8)^2}{6} = 85.3 \text{ in.}^2$ is larger than necessary, but it is about the smallest tie which would be used in practice. To conform to the requirements of Art. [24] of the Specifications, the ties will be placed 12 in. center to center, and to prevent bunching, a 6- X 6-in. guard rail will be notched over the ties at their ends as shown in Fig. 4.

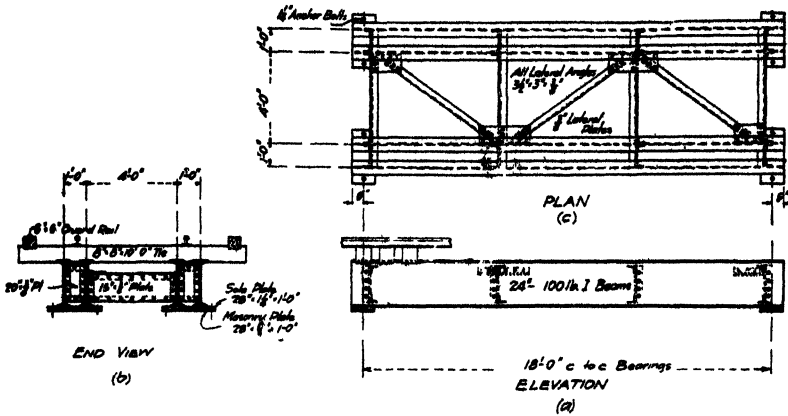

FIG. 4—General drawing 18-ft. I-beam span, Coopers' E-60 loading.

5b. Design of I-Beams.—The dead weight of the bridge floor, subject to the conditions of Art. 19 of the Specifications, is as follows:

Ties	$\frac{(8)(8)(4.5)(10)}{(12)} = 240$
Guard rail	$\frac{(2)(6)(6)(4.5)}{(12)} = 27$
Rails, etc.	$= 150$
	417 lb. per ft. of bridge.

The size of I-beams is as yet unknown. It will be assumed that each beam weighs 100 lb. per ft. The total dead load is then $\frac{1}{2}[417 + 4(100)] = 409$ lb. per ft. per rail. Maximum dead load moment = $\frac{1}{8} w l^2 = (\frac{1}{8})(409)(18)^2(12) = 198,000$ in.-lb. for each rail.

The live load moment to be used in designing the beams is the absolute maximum moment due to the loads shown in the figure of the Specifications (Art. [20], [203]). Methods for the calculation of this moment are given in the volume on "Stresses in Framed Structures." It is there shown that the absolute maximum moment occurs under wheel 3 when the loads are placed as shown in Fig. 5. The moment under wheel 3 for each rail is

$$M = \left[\frac{(90,000)(9)^2}{18} - 150,000 \right] (12) = 3,030,000 \text{ in.-lb.}$$

From Art. [28], [206, 207] of the Specifications, the impact coefficient is

$$\frac{300}{300 + \frac{(18)^2}{100}} = 0.99$$

Hence the impact moment is $(0.99)(3,030,000) = 3,030,000$ in.-lb. The total moment to be carried by the beams under each rail is then

$$198,000 + 3,030,000 + 3,030,000 = 6,258,000 \text{ in.-lb.}$$

The allowable bending stress on extreme fibers of rolled beams is 16,000 lb. per sq. in. (Art. [98], [201], Specifications). Hence the section modulus required for each of the beams under one rail is

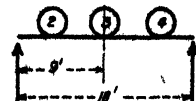

FIG. 5.

$$\frac{I}{c} = \frac{M}{f} = \frac{\left(\frac{1}{2}\right)(6,288,000)}{16,000} = 196.2 \text{ in.}^3$$

A 24-in. 100-lb. I-beam has a section modulus of 197.6 in.³ The dead weight as assumed is therefore correct and no revision is necessary.

5c. Design of Lateral Bracing.—Figure 4 (c) shows the arrangement of the lateral bracing. To avoid interference between the ties and the laterals, the top of the angles have been placed about 6 in. below the top of the I-beams.

From Art. [33], [309] of the Specifications, the lateral system is to be designed for a horizontal force of 700 lb. per ft. plus the wind effect on the exposed area of the structure. As shown in Fig. 4, the exposed area of the I-beam span is about 3 sq. ft. per lin. ft. Hence the lateral load due to wind is (1.5)(3)(30) = 135 lb. per ft. However, Art. [32] of the Specifications places a lower limit on the amount of wind pressure which may be used. Since the structure under consideration is shallow, it will be assumed that it has only a loaded chord and the wind load to be carried will be taken as 200 lb. per ft. Hence total horizontal load = 700 + 200 = 900 lb. per ft.

As shown in Fig. 4, the lateral panels are 6 ft. long. Hence wind panel load = (900)(6) = 5,400 lb. For this loading, the stress in the end lateral diagonal is $(5,400) \frac{(6^2 + 4^2)^{\frac{1}{2}}}{4} = 9,750$ lb. tension or compression. Also, stress in center lateral diagonal = $\frac{1}{3}(5,400) \frac{(6^2 + 4^2)^{\frac{1}{2}}}{4} = 3,250$ lb., tension or compression.

The smallest angle which may be used in lateral bracing is a 3½ × 3 × ⅜-*in.* angle (Art. [113], Specifications). This angle will be found to provide sufficient area for the stresses calculated above. Figure 4 shows the details of the lateral system and the diaphragms which act as separators for the main I-beams.

5d. Design of Sole Plates.—The sole plates must be designed to transfer the maximum end reaction to the masonry. It will be assumed that the abutments are of concrete for which the allowable bearing pressure is 600 lb. per sq. in. (Art. [38], Specifications).

The maximum end reaction for E-60 loading occurs when wheel 2 is placed at the end of the span. End reaction = $\frac{30,060}{18}(3 + 8 + 13 + 18) = 70,000$ lb. Impact coefficient = 0.99 per cent. Impact reaction = (0.99)(70,000) = 69,300 lb. As given above, dead load = 409 lb. per ft. Hence dead load reaction = (½)(409)(18) = 3,700 lb. Total reaction = 70,000 + 69,300 + 3,700 = 143,000 lb. Bearing area required on concrete masonry under each pair of I-beams = $\frac{143,000}{600} = 238$ sq. in.

As shown in Fig. 4, a ¾-*in.* masonry plate rests on the concrete. A 12 × 28-*in.* sole plate is fastened to the I-beams. This plate is made wide enough to provide room for the anchor bolts. Area provided in bearing = (12)(28) = 336 sq. in.

The thickness of the sole plate is determined by the bending stresses in the part of the plate overhanging the I-beams. This projection is 4¾ *in.* Assuming the reaction as uniformly distributed over this plate, the load per square inch is $\frac{143,000}{(12)(28)} = 426$ lb., and the moment per inch of plate at the edge of the I-beam is (½)(426)(4.375)² = 4,080 *in.-lb.* The thickness of plate required is given by the formula $t = \sqrt{\frac{6M}{f}}$, in which M = bending moment and f = allowable fiber stress. For f = 16,000 lb. per sq. in. (Art. [36], [301], Specifications), $t = \sqrt{\frac{(6)(4,080)}{16,000}} = 1.24$ *in.* Use a 1¼-*in.* plate, as shown in Fig. 4.

The anchor bolts are designed to take up the longitudinal force due to braking of the train. For the bridge under consideration, this force is (0.20)(120,000) = 24,000 lb. (Art. [37], [214], Specifications). As shown in Fig. 4, there are two bolts at each end of each pair of I-beams. Assuming this force to be taken by the bolts at one end of the span, the area required, using the same shearing value as for rivets (Art. [35], [301], Specifications), is $\frac{24,000}{12,000} = 2.0$ sq. in. Two 1¼-*in.* round bolts will be used at each end of the beam. All details are as shown in Fig. 4.

6. Deck Plate Girder Bridges.—The general principles of design for railway deck plate girder bridges will be illustrated by the complete design of a 60-ft. span. Figure 22 shows a general drawing of the structure as designed. It will be assumed that the center of bearings are set back one foot from the end of the span. The effective span (Art. [11], Specifications) is then 58 ft. To conform to the requirements of Arts. [12] and [115] of the Specifications, the distance center to center of girders will be taken as 6 ft. 6 in.

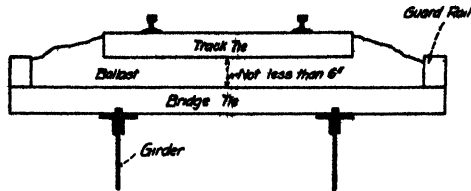

(a)

6a. Floors for Deck Plate Girders.—The floor system for a deck plate girder may be of the *solid floor*, or of the *open floor* type. Solid floors are used when ballasted tracks are laid over the bridge, and open floors are used when the track is not ballasted on the bridge.

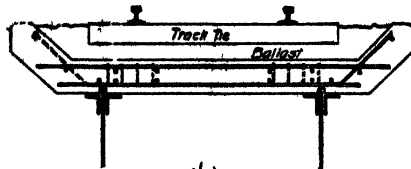

(b)

FIG. 6.

Figure 6 shows two types of solid floors. The floor of Fig. 6 (a) consists of bridge ties laid side by side to form a continuous sheet. Guard rails placed at the ends of the ties hold the ballast in place. The ties and guard rails are generally creosoted to prevent decay. Figure 6 (b) shows a reinforced concrete floor system of the standard type adopted by the C. M. & St. P. Ry.

Open floors generally consist of wooden ties spaced with openings not to exceed 4 in. (Art. [24] Specifications). Figure 7 shows the details of the open floor designed for the 60-ft. girder under consideration.

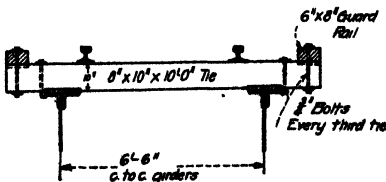

FIG. 7.

Design of Wooden Floor.—In designing wooden ties, the moment due to the weight of the tie is so small compared to the moment due to live load that the weight of the tie may be neglected.

Wooden ties are to be designed to carry a load of 75,000 lb. on each rail distributed over three ties (Arts. [34], [109] and [30], [303], Specifications). The allowable fiber stress must not exceed 2,000 lb. per sq. in.

For the conditions shown in Fig. 7, the maximum moment in the tie is $(\frac{1}{2})(75,000)(9) = 225,000$ in.-lb. Hence, section modulus required = $\frac{225,000}{2,000} = 112.5$ in.³ An 8- × 10-in. tie, placed with the 10-in. side vertical, furnishes a section modulus = $\frac{bd^2}{6} = \frac{(8)(10)^2}{6} = 133.3$ in.³ This tie will be used.

The ties will be spaced 4 in. apart (Art. [34], Specifications). To prevent bunching, guard rails consisting of 6- × 8-in. timbers will be fastened to the ends of the ties. These guard rails will be notched about 1 in. at each tie and they will be fastened to the ties by bolts placed at each third tie. The ties will be fastened to the girder by hook bolts.

6b. Design of Main Girders for Deck Plate Girder Bridges. Theoretical Considerations.—In the theory of beams it has been shown that the

variation of bending fiber stress across any section of a beam may be represented by the straight line *AOB* of Fig. 8 (b). When the flanges of a plate girder, or other built-up beam, are narrow compared to the total depth of the girder, the resisting moment of the section may be determined on the assumption that the fiber stress is uniform across the flange section. The stress variation in the flanges is then as shown by *ab* and *cd* of Fig. 8 (b) and the stress variation across the web plate is as shown by *AOB*. Let f_o = average uniform stress on flange area = fiber stress at

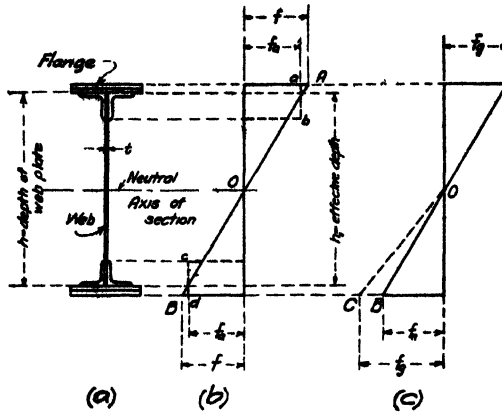

FIG. 8.

center of gravity of flange area; F_o = gross area of one flange; and h_1 = distance between centers of gravity of flanges = effective depth of girder. The resisting moment of the flange stresses is then $M_f = F_o h_1 f_o$. Assuming the fiber stress at the edges of the web plate equal to f_o , the resisting moment of a web plate of depth h and thickness t is

$$M_w = \frac{1}{6} f_o h^2 t$$

Since the total resisting moment at any section is equal to the external bending moment, we have

$$M = M_f + M_w = F_o h_1 f_o + \frac{1}{6} f_o h^2 t$$

It may be assumed without appreciable error that the depth of web plate and the effective depth are equal, for this is practically the case in most girders. We may then write

$$M = (F_o + \frac{1}{6} th) h_1 f_o$$

But th = area of web plate = A_w . Then

$$M = (F_o + \frac{1}{6} A_w) h_1 f_o \tag{1}$$

If f_o = average stress on the gross flange area,

$$f_o = \frac{M}{(F_o + \frac{1}{6} A_w) h_1} \tag{2}$$

From eq. (2), it can be seen that one-sixth of the gross web area may be considered as available flange area.

On the lower, or tension side of the girder, rivet holes must be deducted from the flange area to account for the rivets used in connecting the flange elements. Also, rivet holes must be deducted from the web plate to account for rivets in

stiffeners or web splices. If $\frac{3}{8}$ -in. rivets are used, 1-in. holes must be deducted for each rivet (Art. [78], Specifications). A row of vertical rivets spaced 4 in. apart in a web plate will then reduce the gross section by one-quarter. The effective web area in eqs. (1) and (2) is then

$$\left(\frac{3}{4}\right) \left(\frac{1}{2}A_w\right) = \frac{1}{8}A_w$$

For 3-in. spacing, this quantity becomes $\frac{1}{6}A_w$ and for 5-in. spacing, it becomes $\frac{1}{7.5}A_w$. It is usually assumed that 4-in. spacing is to be used. On the basis of this spacing, Art. [116], {426} of the Specifications recommends that $\frac{1}{8}A_w$ be included as flange area.

If F_n = net flange area, and f_n = allowable stress in tension on the net flange area, eqs. (1) and (2) become

$$M = (F_n + \frac{1}{8}A_w)h_1 f_n \quad (3)$$

and

$$f_n = \frac{M}{(F_n + \frac{1}{8}A_w)h_1} \quad (4)$$

The required net flange area is then

$$F_n = \frac{M}{f_n h_1} - \frac{1}{8}A_w \quad (5)$$

Equation (5) is generally used for the design of the tension flange. The gross area of the compression flange is made the same as that of the tension flange. This will generally satisfy the requirements of Art. [48], {301} of the Specifications and provide a section which is safe against sidewise column action.

The method of design outlined above may be applied without appreciable error to girder sections in which the effective depth is not less than about 90 per cent of the total depth of the girder. Assuming a stress variation as shown in Fig. 8 (b), it can be shown that $f = 1.11f_a$ —that is, the extreme maximum fiber stress exceeds the average fiber stress by about 11 per cent. For the girder section designed by the approximate method given in Art. 6b, the effective depth is 95.5 per cent of the total depth and the extreme fiber stress will exceed the average value by about 5 per cent. This conclusion is checked by the computations based on the moment of inertia method given on p. 303.

When the effective depth is less than about 90 per cent of the total depth, and when unusual sections are used, the moment of inertia method should be used in the design. This procedure is recommended in Art. [116] of the Specifications.

In designing a girder by the moment of inertia method, a trial section must be assumed, or it may be designed by the approximate method given above, assuming a stress variation as shown in Fig. 8 (b). The extreme fiber stress may then be determined by means of the formula $f = \frac{Mc}{I}$, in which f = extreme fiber stress; M = moment at section; c = distance from extreme fiber to neutral axis, and I = moment of inertia of the section.

The moment of inertia of the girder section should be calculated with respect to the neutral axis as determined by the gross section of the girder. If the rivet holes on the tension side of the girder are taken into consideration in determining the position of the neutral axis, it will be found that the neutral axis will change position at each rivet line. However, the net sections at rivets form only a small

portion of the total length of the girder. Since the deflection and distortion of the entire girder are properly functions of the gross area of the girder section, it is evident that the neutral axis and moment of inertia should be determined from the gross area as stated above. The fiber stress on the net flange area may then be determined from the fiber stress on the gross area by means of a correction. In making this correction, it is reasonable to assume that the fiber stresses on gross and net flange areas are inversely proportional to the available flange areas. If f_n = flange stress on net area, and f_g = flange stress on gross area, we have

$$f_n = \frac{F_g + \frac{1}{8}A_w}{F_n + \frac{1}{8}A_w} \cdot f_g \quad (6)$$

The available gross and net flange areas are given in the denominators of eqs. (2) and (4). Figure 8 (c) shows the assumed fiber stress variation across the section. The line *AOB* shows the fiber stress variation on the gross section, and *OC* shows the effect of rivet holes in increasing the fiber stress on the tension side. It is assumed that the fiber stress on the tension side also follows a straight line law.

Economical Depth.—The depth of plate girders, as designed in practice, varies from about one-eighth of the span length for short spans to about one-twelfth for long spans. In some cases local conditions, such as available headroom, may fix the depth of girder which must be used. If the designer is free to choose the depth of girder, it is possible to determine that depth of girder which will give a structure whose weight is a minimum. This depth is known as the *economical depth*.

It can be shown¹ that the formulas for least depth are as follows:

When the moment of resistance of the web is neglected

$$h = \sqrt{\frac{M}{ft}} \quad (7)$$

When one-eighth of the web area is assumed as available flange area

$$h = 1.1 \sqrt{\frac{M}{ft}} \quad (8)$$

In eqs. (7) and (8), M = total maximum moment; h = depth of girder; f = allowable fiber stress on gross flange area; and t = thickness of web plate.

It will generally be found that a considerable variation in the depth given by eqs. (7) or (8) can be made without causing any great change in the total weight. A 20 per cent reduction in the value of h will cause a change of about 2 per cent in the weight of the girder.

The depth which may be used for any girder is also subject to the requirements of Art. [120], [431] of the Specifications. This article specifies the unsupported depth of a web plate of a given thickness. On p. 300 is given the determination of the depth of a plate girder subject to the above conditions.

Maximum Moments and Shears for 60-ft. Span.—The maximum moments and shears at various points on the span are calculated by the methods given in the volume on "Stresses in Framed Structures." For convenience, values will be calculated for the points shown in Fig. 9.

¹ See JOHNSON, BRYAN and TURNBAUGH, "Modern Framed Structures," Part III, pp. 184 to 188.

Dead Load Moments and Shears.—The wooden floor designed in Art. 2a consists of 8- × 10-in. ties 10 ft. long spaced 12 in. center to center and 6- × 8-in. guard rails. From Art. [19], [202] of the Specifications the weight of timber is to be taken as 4½ lb. per ft. B.M. Also, the weight of track and fastenings is to be taken as 150 lb. per ft. of track.

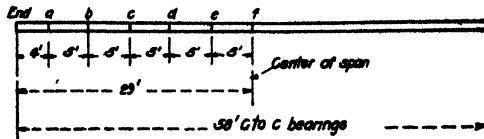

FIG. 9.

Since the ties are spaced 12 in. on centers, their weight per foot of bridge is $(8)(1\frac{1}{2})(10)(4.5) = 300$ lb. The weight of guard rails, per foot of bridge, is $(2)(\frac{3}{4})(8)(4.5) = 36$ lb. Including track, the bridge floor weighs $300 + 36 + 150 = 486$ lb. per ft. of bridge.

The assumed weight of the girder for E-60 loading, as given by eq. (3) of Art. 2a is $w = 1.1(12.5l + 100)$. Using $l =$ effective span = 58 ft., we have $w = 1.1[(12.5)(58) + 100] = 907.5$ lb. per ft. of bridge.

The total dead load for floor and girder is then $486 + 907.5 = 1,393.5$ lb. per ft. of bridge. We will use 1,400 lb. per ft. of bridge, or 700 lb. per ft. per girder. Dead load moments and shears at the several points shown in Fig. 9 due to a load of 700 lb. per ft. per girder are given in Tables 1 and 2.

Live Load Moments and Shears.—Live load moments and shears due to E-60 loading are given in Tables 1 and 2. Impact moments and shears are determined from the formula of Art. [28], [206] of the Specifications. For moment the loaded length for all points may be taken as equal to the span length center to center of bearings. For shear, the loaded length is variable, being equal to the distance from wheel 1 to the right end of span. For the end of span and for point a, the loaded length should be taken as the span length of 58 ft.

TABLE 1.—DEAD, LIVE AND IMPACT MOMENTS

Points	End	a	b	c	d	e	f
Dead load moment...	0	75.6	154.2	215.5	259.0	285.5	294.5
Live load moment...	0	512.0	1,000.0	1,389.0	1,652.0	1,800.0	1,834.0
Impact moment....	0	460.2	899.0	1,249.0	1,484.0	1,618.0	1,649.0
Total M. ft.-lb.....	0	1,047.8	2,053.2	2,853.5	3,395.0	3,703.5	3,777.5
Total M. in.-lb.	0	12,573.6	24,638.4	34,242.0	40,740.0	44,442.0	45,330.0

Moments given in thousands of foot-pounds and inch-pounds.

TABLE 2.—DEAD, LIVE AND IMPACT SHEARS

Points	End	a	b	c	d	e	f
Dead load shear.	20.3	17.50	14.00	10.50	7.00	3.50	0
Live load shear...	143.08	127.34	108.72	90.11	72.09	55.74	40.78
Impact shear....	128.62	114.48	98.07	82.63	67.19	52.67	38.94
Total shear.....	292.00	259.32	220.79	183.24	146.28	111.91	79.67

All values given in thousands of pounds.

It is often possible to detect errors made in the calculation of moments and shears by plotting moment and shear curves, as given on Fig. 13. These curves should be smooth regular curves. If any calculation errors have been made, they will generally cause sudden or unexpected breaks in the curves. When such breaks are noticed, it will generally be found on checking the calculations that an error has been made.

Absolute Maximum Moment.—The absolute maximum moment occurs under wheel 13 when that wheel is placed 0.13 ft. to the left of the span center. For E-60 loading, the absolute maximum moment in a 58-ft. beam is 1,835,040 ft.-lb. The impact moment is $(0.899)(1,835,040) = 1,650,000$ ft.-lb. It is sufficiently accurate to assume that the dead load moment at this point is the same as at the span center. Hence total absolute maximum moment = $1,835,040 + 1,650,000 + 294,500 = 3,779,500$ ft.-lb. = 45,354,000 in.-lb. Note that this moment is but slightly larger than the center moment as given in Table 1.

Design of Main Girders for a 60-ft. Span. Approximate Method.—It will be assumed that no restrictions due to local conditions are placed on the depth of the girders. The required depth will then be determined subject to the conditions stated on p. 298.

Determination of Depth of Girder.—From Art. [38], [301] of the Specifications the allowable shear on the gross web area is 10,000 lb. per sq. in. The total end shear, as given in Table 2, is 292,000 lb. Hence a web area of 29.2 sq. in. is required,

For girders of this span, $\frac{3}{8}$ - or $\frac{1}{2}$ -in. web plates are generally used. From Art. [120], [431] of the Specifications, the maximum depth for a web plate of given thickness may be determined by solving the formula there given for D and adding the depth of flange angles. Assuming 6-in. flange angles, we have

$$h = 400t^2 + 12$$

in which h = allowable depth of web plate, and t = thickness of web plate. For a $\frac{3}{8}$ -in. plate, $h = (400)(\frac{3}{8})^2 + 12 = 68.3$ in., and for a $\frac{1}{2}$ -in. plate, $h = (400)(\frac{1}{2})^2 + 12 = 88.6$ in. Therefore a $\frac{3}{8}$ -in. plate of maximum depth will furnish a gross area of $(68.3)(\frac{3}{8}) = 25.6$ sq. in. and a $\frac{1}{2}$ -in. plate will furnish $(88.6)(\frac{1}{2}) = 38.8$ sq. in. Since the $\frac{3}{8}$ -in. plate does not furnish the required area, it will be necessary to use a $\frac{1}{2}$ -in. plate.

The depth required for least weight may be determined from eq. (8) Art. 6b. In substituting in eq. (8) an assumed value of f must be used. It will generally be found that the reduction in flange section due to rivets amounts to about one-eighth of the gross area. Hence f in eq. (8) may be taken as seven-eighths of the fiber stress on net area = $(\frac{7}{8})(16,000) = 14,000$ lb. per sq. in. With $M = 45,354,000$ in.-lb., and $t = \frac{1}{2}$ in., as determined above, we have

$$h = 1.1 \sqrt{\frac{45,354,000}{(14,000)(\frac{7}{16})}} = 94.6 \text{ in.}$$

If this depth be reduced 20 per cent, as suggested on p. 298, we find that a depth of $(0.8)(94.6) = 75.8$ in. may be used.

A $76 \times \frac{1}{2}$ -in. web plate will be used and the flange angles will be placed $76\frac{1}{2}$ in. back to back (Art. [233], Specifications). The web area furnished by this section is $(\frac{1}{2})(76) = 33.25$ sq. in.

Design of Flange Section.—The requirements of the Specifications governing the design of flange sections are given in Arts. [118 to 119], [426, 427]. Figure 10 shows forms of flanges in common use. The form shown in Fig. 10 (a) is simple and readily fabricated. When 6-in. angles are used, the cover plates are made 14 in. wide; for 8-in. angles, 18-in. cover plates are used. The division of area between angles and plates is left largely to the judgment of the designer. Article [117] of the Specifications recommends that the angles form as large a part of the area as practicable. An examination of actual designs shows that in some cases as much as two-thirds of the area is furnished by the plates and one-third by the angles. Some designers provide half of the required area by means of angles and the balance by cover plates.

Additional area is sometimes provided by means of side plates, as shown in Fig. 10b. Article [117], [427] of the Specifications recommends that this arrangement be used only when the use of the form of Fig. 10 (a) would require the use of angles over 1 in. thick. An objection to the use of the form of Fig. 10 (b) is that a deep flange results, for which it is not reasonable to assume a fiber stress variation of the nature shown in Fig. 8 (b).

In some cases it is desirable to have a top flange in which the top surface has the same elevation throughout. Figures 10 (c) and (d) show forms of flanges of this type.

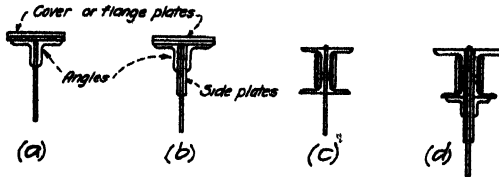

FIG. 10.

The design of girder flanges is a cut and try process, for the flange stress, which determines the area required, is not known until the true section and effective depth of the girder have been determined. In any case the true section may be determined in the following manner: Assume that the effective depth of the girder (distance between centers of gravity of upper and lower flanges) is equal to the distance back to back of flange angles. Determine the flange area required on this assumption. Make up a section which will furnish the required area. Determine the center of gravity of this section and calculate the resulting effective depth of the girder. Re-calculate the flange stress, using this effective depth, and determine the required flange area. Repeat the process until the assumed and required areas agree as closely as the choice of sections will permit.

Applying this process to the 60-ft. span under consideration, we note from p. 300 that the absolute maximum moment is 45,354,000 in.-lb., and from p. 300, the angles are placed 76.5 in. apart in the adopted section. Hence, net flange area required (Art. [38], [301], Specifications $f_n = 16,000$ lb. per sq. in.), as calculated from eq. (5) p. 297 with $A_w = (\frac{1}{8})(76) = 33.25$ (area $\frac{1}{8}$ × 76-in. web plate), is

$$F_n = \frac{45,354,000}{(76.5)(16,000)} - \left(\frac{1}{8}\right)(33.25) = 37.00 - 4.16 = 32.84 \text{ sq. in.}$$

Note that the total flange area (web, angles, and plates included) is 37.00 sq. in., and that 4.16 sq. in. of this area is furnished by the web and the balance, 32.84 sq. in., is to be furnished by angles and plates.

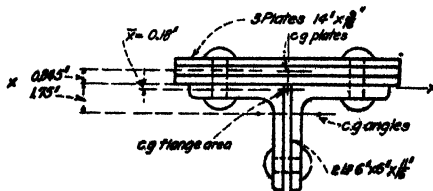

FIG. 11.

The trial section shown in Fig. 11 will be assumed. Assuming $\frac{1}{2}$ -in. rivets, the size generally used in bridge work, the diameter of rivet holes must be taken as 1 in. (Art. [73], Specifications). The gross and net areas of the section of Fig. 11 is then as given in the following table: Two rivet holes will be taken from each plate and two from each angle, as shown in Fig. 11.

TRIAL FLANGE SECTION

Item	Gross area	Rivet holes	Net area
2L 6 × 6 × 1 1/8	15.56	2.75	12.81
3 Cover plates, 14 × 3/8	23.63	3.38	20.25
	39.19	6.13	33.06
1/8 Web area = (1/8)(3/8)(76) =			4.16
Total available flange area	37.22

All values in square inches.

As shown by the above table, the net area furnished by angles and plates is 33.06 sq. in., and the total available flange area is 37.22 sq. in.

To locate the center of gravity of the flange section of Fig. 11, take moments about any axis, using the areas of plates and angles as forces and the known distances from the given axis to the center of gravity of these areas as lever arms. On dividing this moment by the total area of the section, the result will be the distance from the given axis to the center of gravity of the entire section. Let the assumed axis be taken at the backs of the angles, as shown by *x-x* of Fig. 11. Using *gross areas* and lever arms as indicated on Fig. 11, assuming that the moment of areas below the axis is positive, we have

$$\bar{x} = \frac{(15.56)(1.75) - (23.63)(0.845)}{39.19} = 0.18 \text{ in.}$$

As shown on Fig. 11, the center of gravity of the section is located 0.18 in. below the backs of the angles.

Assuming that the top and bottom flange sections are alike, which is the usual case, the true effective depth of the girder is 76.5 - (2)(0.18) = 76.14 in. Again applying eq. (5) the area required is

$$F_a = \frac{45,354,000}{(76.14)(16,000)} - \left(\frac{1}{8}\right)(33.25) = 37.23 - 4.16 = 33.07 \text{ sq. in.}$$

Since the trial section provides practically the exact area required, it will be adopted, provided it answers certain requirements of the Specifications. These requirements are as follows: Article [38], [301] states that the horizontal shear in flange angles of girders shall not exceed 4,000 lb. per sq. in. Article [48], [301] states that the stress per square inch on compression flanges of girders shall not exceed 16,000 - 150 ^l/_b, in which *l* = the length of the unsupported flange between lateral connections, and *b* = the flange width.

The unsupported flange length, which is to be taken as the lateral truss panel length, is not known at this time. From subsequent calculations given in Art. 67 it is shown on Fig. 17 that this panel length is 7.1 ft. With *l* = 7.1 ft., and *b* = 14 in., the width of cover plate shown in Fig. 11, the allowable fiber stress is found to be

$$16,000 - (150) \frac{(7.1)(12)}{(14)} = 15,100 \text{ lb. per sq. in.}$$

From eq. (2), p. 296, the fiber stress on the compression flange is

$$f_c = \frac{45,354,000}{\left[39.19 + \left(\frac{1}{8}\right)(33.25) \right] 76.14} = 18,300 \text{ lb. per sq. in.}$$

The existing fiber stress is therefore less than the allowable and the requirements of Art. [48], [301] of the Specifications are satisfied.

The horizontal shearing stress in the legs of the flange angles will now be investigated. This shearing stress may be determined from eq. (4) p. 307. From this equation it is evident that the horizontal shearing stress is a maximum where the external shear is a maximum, which is at the end of the girder. From Table 2, p. 299, this shear is 292,000 lb. Also, it can be seen that the shearing stress in the angle is a maximum at the location of the inside row of rivets (Fig. 22). The term F_v of eq. (4) may therefore be taken as the total area of the angle. For the compression flange, assuming the section at the end of the girder to consist of two angles and one cover plate, we have from eq. (4)

$$v = \frac{292,000}{(73.68)(2)\left(\frac{11}{16}\right)} \times \frac{23.43}{(23.43 + 5.54)} = 2,340 \text{ lb. per sq. in.}$$

For the tension flange, assumed as consisting of two angles,

$$v = \frac{292,000}{(73.68)(2)\left(\frac{11}{16}\right)} \times \frac{(12.31)}{(12.31 + 4.16)} = 2,180 \text{ lb. per sq. in.}$$

In these calculations, the effective depth $h = 73.68$ is determined for the flange section assumed above, and b is taken as $(2)\left(\frac{11}{16}\right)$ in., the thickness of two angles. Since the values calculated above are well within the allowable value of 4,000 lb. per sq. in., the assumed section amply provides for horizontal shear.

The girder section shown in Fig. 12 answers all requirements of the Specifications and will be adopted as final. Figure 22 shows the adopted section.

It is not always possible to obtain as close agreement between areas required and provided as that obtained in the above computations. Some designers require the agreement between provided and required areas to be such that the resisting moment of the area provided (see calculations for cover plate cut-off given in Art. 6c, p. 304) shall not exceed the maximum bending moment by more than 1 per cent. When the difference between required and provided areas is small, the desired agreement may be obtained by varying the thickness of the angles, or the thickness of all or a part of the cover plates. It is sometimes possible to secure the desired agreement by a slight change in the distance back to back of the flange angles.

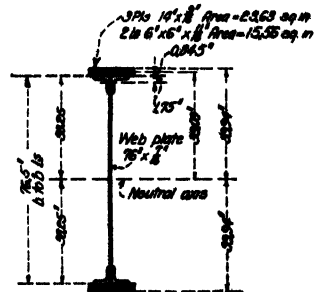

FIG. 12.

Design of Girder by the Moment of Inertia Method.—In designing a girder by the moment of inertia method, a trial section must be assumed and the extreme fiber stresses calculated from the formula $f = \frac{Mc}{I}$. The correction for rivet holes on the tension side of the section has been discussed on p. 296 of Art. 6b.

Assume first a section of the dimensions designed in Art. 6b. Figure 12 shows the assumed section. The neutral axis is taken at the center of the web plate, for reasons given on p. 297.

The calculations for moment of inertia of the section are given in the table below. In calculating the moment of inertia of the several areas, the formula $I = I_o + Ax^2$ is used, in which I = moment of inertia of any area about the neutral axis of the entire section; I_o = moment of inertia of any area about its own gravity axis; A = area of any plate or angle; and x = distance from center of gravity of any area A to the neutral axis of the entire section. Gross areas are to be used. All dimensions are shown on Fig. 12. The moment of inertia of the web plate may be taken directly from the rolling mill handbook.

MOMENT OF INERTIA OF GIRDER SECTION

Item	<i>A</i>	<i>x</i>	<i>Ax</i> ²	<i>I</i> _o	<i>I</i>
Web plate 76 × $\frac{1}{16}$ in.....	16,000
4 $\frac{1}{2}$ 6 × 6 × $1\frac{1}{16}$	31.12	36.50	41,500	104	41,604
2 (3 Plates, 14 × $\frac{1}{16}$).....	47.26	39.09	72,300	11	72,306
Total <i>I</i>	129,920

From the general equation $f = \frac{Mc}{I}$, we have

$$f_o = \frac{(45,354,000)(39.94)}{129,920} = 13,950 \text{ lb. per sq. in.}$$

To determine the extreme fiber stress on the net section, use eq. (6), p. 298. From the values given in the table on p. 302, $F_n + \frac{1}{8}A_w = 37.22$ and $F_o + \frac{1}{8}A_w = 39.19 + 5.54 = 44.73$. Then

$$f_n = \frac{(44.73)(13,950)}{(37.22)} = 16,780 \text{ lb. per sq. in.}$$

The extreme fiber stress on the tension side of the girder therefore exceeds the allowable value of 16,000 lb. per sq. in. by about 4.9 per cent.

The extreme fiber stress may be reduced by increasing the flange area. It will be found that a given area added to the cover plates will cause a greater reduction in fiber stress than will be obtained by adding the same area to the angles. A modified section consisting of two 6 × 6 × $1\frac{1}{16}$ -in. angles and three 16 × $\frac{1}{16}$ -in. cover plates was assumed. Repeating the above calculations for the modified section, it was found that the extreme fiber stress on the net section is 15,200 lb. per sq. in. This is less than the allowable and the modified section is therefore satisfactory.

6c. Length of Cover Plates.—The girder section designed in Art. 6b is required only for a short distance near the point of maximum moment. As shown in Fig. 13, the moment curve resembles a parabola. Near the ends of the girder, the moments are smaller than those near the center. It is therefore possible to use a smaller section near the ends of the girder. This reduction in girder section may be secured by cutting off the cover plates one by one, until only the web plate and angles remain at the end of the girder.

To determine where the several cover plates may be cut off, the moment of resistance of the section must be determined for the web plate and angles alone, and also for the web plate and angles in combination with one, two and three cover plates. These several moments of resistance may then be plotted on the moment diagram, using the same scale as for plotting the moment diagram. The intersection of the lines indicating the several moments of resistance and the moment curve will show where the plates may be cut off.

The moment of resistance of the web plate and angles in combination with the cover plates may be determined from eq. (3), p. 297. This equation is as follows:

$$M_R = (F_n + \frac{1}{8}A_w)h_1f_n$$

in which M_R = moment of resistance of section; F_n = net area of flanges, composed of the angles and one or more plates; A_w = gross web area; h_1 = effective depth of girder for the given flange section; and f_n = allowable fiber stress on net

section = 16,000 lb. per sq. in. The effective depth required in these calculations is determined by the method used on p. 302 for the section shown in Fig. 11.

Two Angles and Three Cover Plates.—From p. 302 the total net area (two angles, three plates and one-eighth web) is 37.22 sq. in. The effective depth of girder is 76.14 in. (p. 302). Then from eq. (3)

$$M_R = (37.22)(76.14)(16,000) = 45,355,000 \text{ in.-lb.}$$

Two Angles and Two Cover Plates.—The center of gravity of this section is located 0.58 in. inside the backs of the angles. Hence, effective depth = 76.5 - (2)(0.58) = 75.34 in. Net area of a 14- × ½-in. plate = (14 - 2)½ = 6.75 sq. in. Hence net area two angles and two cover plates (one-eighth web included) = 37.22 - 6.75 = 30.47 sq. in. From eq. (3)

$$M_R = (30.47)(75.34)(16,000) = 36,700,000 \text{ in.-lb.}$$

Two Angles and One Cover Plate.—The center of gravity of this section is located 1.07 in. inside the backs of the angles. Effective depth = 76.5 - (2)(1.07) = 74.36 in. Net area two angles and one cover plate (one-eighth web included) = 37.22 - (2)(6.75) = 23.72 sq. in. From eq. (3)

$$M_R = (23.72)(74.36)(16,000) = 28,200,000 \text{ in.-lb.}$$

Two Angles.—Net area two angles = 12.81 sq. in. Including one-eighth web area (4.16 sq. in.), the available net flange area = 16.97 sq. in. The center of gravity of the angle section is located 1.75 in. from the back of the angle. Effective depth of girder = 76.5 - (2)(1.75) = 73.0 in. From eq. (3)

$$M_R = (16.97)(73)(16,000) = 19,820,000 \text{ in.-lb.}$$

The several moments of resistance as plotted to scale in Fig. 13 are represented by the horizontal lines 1-1, 2-2, 3-3 and 4-4. At point 2, where the line

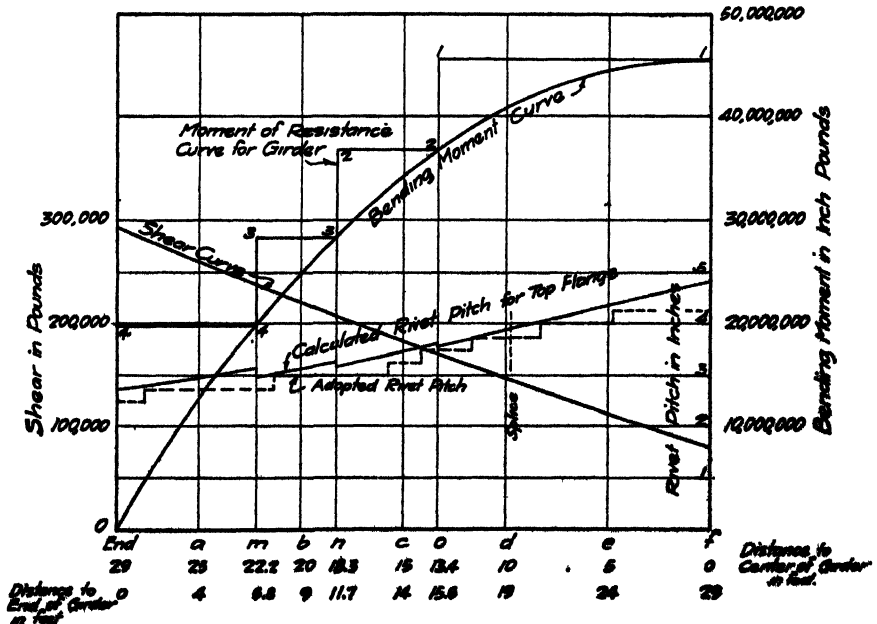

FIG. 13.

2-2 intersects the moment curve, the available flange area provided by the angles and two cover plates is sufficient to provide for the moment to the left of point 2. Hence the top cover plate may be cut off at point 2, at a distance of 13.4 ft. from

the center of the span. This distance is determined by scale from Fig. 13. In the same manner, two plates may be cut off 18.3 ft. from the girder center, and from the end of the girder to a point 22.2 ft. from the girder center, the angles alone (plus one-eighth web area) will provide for the bending moment.

The length of cover plates is sometimes determined on the assumption that the bending moment curve is a true parabola. Formulas based on this assumption and illustrative problems which explain the application of the formulas are given in the volume on "Structural Members and Connections."

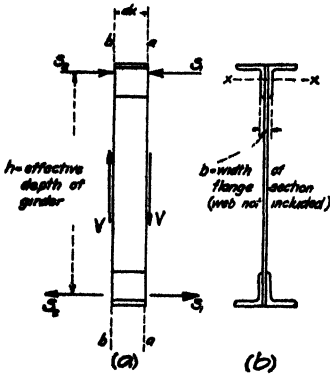

FIG. 14.

6d. Rivet Spacing in Flanges.—

The design of riveting between the flanges and the web, and between the elements of the flanges, is governed by Arts. [121] and [38], [301] of the Specifications. Article [38] states that the allowable shearing and bearing values for rivets are respectively 12,000 and 24,000 lb. per sq. in. Article [121] states that the riveting between flange and web must be designed to carry the horizontal shear at any point combined with any load applied directly to the flange. Such loads

are to be assumed as distributed over 3 ft. of flange.

The horizontal shear at any point in the flange may be determined from the common formula $v = \frac{Vm}{Ib}$. In this equation, v = intensity of horizontal shear on any plane; V = total shear on a vertical section of the girder; m = statical moment of area outside the shear plane with respect to the neutral axis of the girder section; I = moment of inertia of girder section; and b = width of shear plane.

The horizontal shear may also be determined by the following approximate method. Let $a-a$ and $b-b$ of Fig. 14 represent two sections of a girder at a distance dx apart. Let S_1 and S_2 represent the total flange stresses on these sections. The change in flange stress between the two sections is $S_1 - S_2$. If M_1 and M_2 = moments at sections $a-a$ and $b-b$ respectively, $S_1 - S_2 = \frac{M_1 - M_2}{h}$. When the sections are taken close together, $M_1 - M_2 = dM$ = increment of moment across section. If dS = increment of stress per unit of length, we have $dS = \frac{1}{h} \frac{dM}{dx}$.

But from the theory of beams, $\frac{dM}{dx} = V$ = shear on vertical section. Hence

$$dS = \frac{V}{h} \tag{1}$$

In deriving eq. (1) it is assumed that all the moment is taken by the flanges. If a portion of the web area be considered as available flange area, dS will be proportionally reduced, and we have for the compression flange

$$dS = \frac{V}{h} \frac{F_c}{F_c + \frac{1}{6} A_w} \tag{2}$$

in which F_c and A_w have the values as defined on p. 296.

The horizontal shear per unit of length on any plane $x-x$ of Fig. 14 (b) is equal to the proportional part of dS which acts above $x-x$. If $F_s =$ gross area of flange section and $F_x =$ gross area above $x-x$,

$$\text{horizontal shear on } x-x = V_h = dS \frac{F_x}{F_s} = \frac{V F_x}{h F_s} \cdot \frac{F_s}{F_s + \frac{1}{6} A_w} \tag{3}$$

The intensity of horizontal shear on $x-x$, which will be called v_s , is equal to the shear given by eq. (3) divided by the area on section $x-x$. If $b =$ width of flange

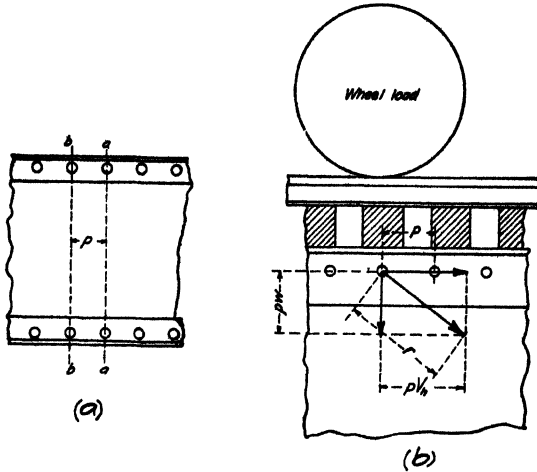

FIG. 15.

section at $x-x$ (web plate not included), the area per unit of length of girder on this section is b . Hence

$$v_s = \frac{V}{hb} \cdot \frac{F_x}{F_s} \cdot \frac{F_s}{F_s + \frac{1}{6} A_w} \tag{4}$$

These values are given for the compression flange. For the tension flange F_s and $\frac{1}{6}A_w$ should be substituted in eqs. (3) and (4) in place of F_s and $\frac{1}{6}A_w$.

Rivet Spacing between Flange Angles and Web Plate.—The rivets connecting the flange angles to the web, as shown in Fig. 15 (a), must transfer from flange to web, the total difference in flange stress between sections $a-a$ and $b-b$. Hence in eq. (3), $F_x = F_s$. If $p =$ distance between rivets in the compression flange, the total horizontal shear over the distance p must not exceed the value of a rivet. Let $r =$ value of one rivet. Then $pV_h = r$, from which

$$p = \frac{rh}{V} \frac{F_s + \frac{1}{6} A_w}{F_s} \tag{5}$$

Equation (5) gives the rivet pitch for the compression flange. For the tension flange, F_s and $\frac{1}{6}A_w$ are to be replaced by F_x and $\frac{1}{6}A_w$ respectively.

When the ties rest directly on the top flange angles, as shown in Fig. 15(b), the rivets must transfer to the web these vertical loads in addition to the horizontal shear in the flanges. Let w = load per inch on top flange due to vertical loads. If p = rivet pitch, the vertical load to be carried by a rivet is pw . As before, the horizontal load carried by a rivet is pV_h . If r = value of a rivet, the resultant of the horizontal and vertical forces on the rivet must not exceed r . Hence

$$r = [(pV_h)^2 + (pw)^2]^{1/2}$$

from which

$$p = \left[\left(\frac{V}{h} \frac{F_v}{F_v + \frac{1}{6}A_w} \right)^2 + w^2 \right]^{1/2} \quad (6)$$

Equation (6) gives the rivet pitch for the top or compression flange. For a tension flange, substitute F_t and $\frac{1}{6}A_w$ in place of F_v and $\frac{1}{6}A_w$.

When the top and bottom flange of a girder are made alike, as in the 60-ft. girder under consideration, it is usual to make the rivet spacing alike for the two flanges. In deck plate girders, it will be found that the presence of vertical loads on the top flange calls for a closer spacing of rivets in the top flange than is required for the bottom flange, where only horizontal forces exist. In through plate girders, where neither flange carries vertical loads, it will generally be found that the lower, or tension flange, requires the closer spacing. The closer spacing is generally adopted for both flanges, in order to facilitate fabrication in the bridge shop.

The rivet spacing between the flanges and web of a plate girder may be determined with sufficient accuracy for all ordinary cases by calculating the spacing required at the end, the center, and one or more intermediate points. A smooth curve drawn through the plotted values of these required spacings will give to the detailer all the necessary information.

If a very accurate rivet spacing curve is desired, the rivet spacing may be calculated at frequent intervals, say every 5 ft. The required shears may be taken from a table similar to Table 2, p. 299. Calculations should also be made at each point where the flange section changes, as for example, at the end of each cover plate. A rivet spacing curve of this nature is shown in Fig. 13. The sudden breaks in this curve are due to changes in the flange section at the ends of the cover plates. While this procedure is theoretically correct, it is hardly warranted by the actual conditions encountered in practice, for in general, changes in rivet spacing are made at intervals of a quarter of an inch as a minimum. The rivet spacing curve should be plotted with sufficient accuracy to give this information.

All data required for the calculation of rivet spacing for the 60-ft. girder under consideration are given in Table 3. Variations in flange section are as shown in Fig. 13. From Art. [119] of the Specifications, one cover plate on the top flange shall extend the full length of the girder. Therefore only the lower flange cover plate next to the angles will be cut off at point m of Fig. 13. In determining the effective depth of the girder (h in the rivet spacing formulas) this must be kept in mind. The effective depths given in Table 3 are taken from the calculations given on p. 305.

TABLE 3.—TABLE OF RIVET PITCH TOP FLANGE

Point (see Fig. 13)	Distance from support in feet	Shear in thousands of pounds	Effective depth in inches	Gross flange area, F_s	Gross flange area plus $\frac{1}{6}$ web $F_s + \frac{1}{6}A_w$	Compression flange rivet pitch
End	0.0	292.0	73.68	15.56	21.10	2.72
a	4.0	259.3	73.68	15.56	21.10	2.97
m	6.8	238.0	73.68	15.56	21.10	3.15
m	6.8	238.0	74.36	23.43	28.97	2.97
b	9.0	220.8	74.36	23.43	28.97	3.12
n	10.7	208.0	74.36	23.43	28.97	3.26
n	10.7	208.0	75.34	31.31	36.85	3.18
c	14.0	183.2	75.34	31.31	36.85	3.44
o	15.6	170.0	75.34	31.31	36.85	3.59
o	15.6	170.0	76.14	39.19	44.73	3.56
d	19.0	146.3	76.14	39.19	44.73	3.86
e	24.0	111.9	76.14	39.19	44.73	4.34
f	29.0	79.7	76.14	39.19	44.73	4.79

The required rivet spacing for the lower flange is given by eq. (5) p. 307, using net flange area and $\frac{1}{6}A_w$. In this form the necessary equation is

$$p = \frac{rh}{V} \frac{F_n + \frac{1}{8}A_w}{F_n}$$

The rivets between the web and flange are $\frac{7}{8}$ -in. rivets in bearing on a $\frac{3}{16}$ -in. plate. For the allowable bearing value given in Art. [33], [301] of the Specifications, $r = 9,190$ lb. per rivet. At the end of the girder, the other terms have the following values. The effective depth (two angles and one cover plate on top flange, two angles on lower flange, see Fig. 22) is $h = 76.5 - (1.75 + 1.07) = 73.68$ in. $V = \text{end shear} = 292,000$ lb. (see Table 2, p. 299). $F_n = 12.81$ and $F_n + \frac{1}{8}A_w = 16.96$ (see p. 302). Hence

$$p = \frac{(9,190)(73.68)}{(292,000)} \left(\frac{16.96}{12.81} \right) = 3.07 \text{ in.}$$

The rivet spacing in the top flange is given by eq. (6), p. 308, which is

$$p = \frac{r}{\left[\left(\frac{V}{h} \frac{F_s}{F_s + \frac{1}{6}A_w} \right)^2 + w^2 \right]^{1/2}}$$

In this equation V , h and r have the values given above. From p. 302, $F_s = 15.56$ and $F_s + \frac{1}{6}A_w = 15.56 + (\frac{1}{6})(\frac{7}{16})(76) = 21.10$. The term w , which is the load per inch due to vertical loads (Art. [121], Specifications) is due to a wheel load of 60,000 lb. (plus impact at 100 per cent) and the weight of the bridge floor, which is 486 lb. per ft. of girder (see Art. 6b). Hence, for each girder, $w = \frac{60,000}{86} + \frac{486}{(9)(12)} = 1,687$ lb. per in. On substituting these values in the above equation,

$$p = \frac{9.19}{\left[\left(\frac{292.0}{73.68} \cdot \frac{15.56}{21.10} \right)^2 + (1.687)^2 \right]^{1/2}} = 2.72 \text{ in.}$$

On comparing the calculated values of top and bottom chord rivet spacing, as given above, it was found that the top chord value was the smaller. This same relation will be found to be true at all points. Therefore, only the data for the top flange rivet spacing are given in Table 3 and the rivet spacing curve for the top flange only is shown in Fig. 13. The values recommended for adoption are shown beneath the curve. Note that they vary at $\frac{1}{4}$ -in. intervals. For the adopted rivet spacing, see Fig. 22.

Rivet Spacing in Cover Plates.—The spacing of the rivets in the cover plates may be determined by dividing the value of a rivet by the horizontal shear existing between adjacent plates. Equation (3), p. 307 gives the value of the horizontal shear. If r = rivet value, we have for the compression flange,

$$p = \frac{r h}{V} \frac{F_c + \frac{1}{6} A_w}{F_s} \quad (7)$$

For a tension flange,

$$p = \frac{r h}{V} \frac{F_t + \frac{1}{8} A_w}{F_s} \quad (8)$$

In these equations F_s = area of plates outside the shear plane in question. Net areas are to be used for tension flange plates and gross areas for compression flange plates. All other values are as given above.

It will be found that the minimum rivet spacing in the cover plate is required at the end of the tension flange plate which ends at point n of Fig. 13. From Table 3, we find that for the girder section to the right of n , the properties of the section are as follows: $F_h + \frac{1}{6} A_w = 30.46$ sq. in., $h = 75.34$ in., and $V = 208,000$ lb. At this point there are two cover plates, whose net area = $F_s = (2)(14 - 2)(\frac{9}{16}) = 13.5$ sq. in. The rivets connecting these plates are in single shear. Hence $r = 7,220$ lb. per rivet. From eq. (8)

$$p = \frac{(7,220)(75.34)(30.46)}{(208,000)(13.5)} = 5.90 \text{ in.}$$

This spacing is for rivets in a single line. At points m and o , the required spacing was found to be 7.92 and 5.96 in. respectively. On Fig. 22, two lines of rivets are shown in place. Hence the spacing for each line is twice the calculated value, or 11.80 in. at point n . From Art. [60], [412] of the Specifications, the maximum allowable spacing of $\frac{7}{8}$ -in. rivets is 6 in. As the spacing calculated above is in excess of the allowable, the rivets in cover plates will be spaced not to exceed 6 in. Figure 22 shows the adopted arrangement. Note that the maximum allowable spacing is used except at lateral plates, where the spacing is reduced in order to cut down the size of these plates.

To conform to the requirements of Art. [119], [427] of the Specifications, the cover plates are extended 18 in. beyond the theoretical cut-off point. This is done to equalize stresses in the flange elements before the cover plate begins to take stress. The rivets in this additional length of cover plate are generally spaced somewhat closer than at other points in order to bind the flange elements firmly together and also to assist in the equalization of stress between the flange elements.

6c. Design of Stiffeners.—The design of the end stiffener angles in a plate girder is governed by Art. [124] of the Specifications. Figure 16 shows typical arrangements of end stiffeners. The arrangements shown in Figs. 16 (a) and (b) secure a narrow member which distributes the reaction evenly to the shoe. A wider arrangement such as shown in Fig. 16 (c) requires a wider shoe or bearing plate. It is probable that the distribution of the reaction to the shoe is

not as even as in the case of Figs. 16 (a) and (b). In Fig. 16 (d) a pair of angles at the center of the shoe serves to secure a more even distribution of the load to the shoe.

In designing end stiffener angles, Art. [124] of the Specifications states that the bearing between the stiffener and the lower flange angle shall be taken by the outstanding leg of the stiffener angle, which shall be made as wide as possible. The bearing between the stiffener angle and the flange angle is to be taken at 24,000 lb. per sq. in. (Art. [38], [301], Specifications).

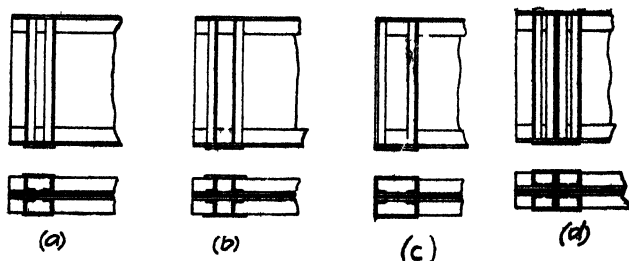

FIG. 16

For the 60-ft. girder under consideration, the flange angles are 6 in. wide and $1\frac{1}{8}$ in. thick. The stiffener angles may then be composed of $5 \times 3\frac{1}{2}$ -in. angles with the 5-in. leg outstanding. From Table 2, p. 299, the end reaction is 292,000 lb. Hence the bearing area required is $\frac{292,000}{24,000} = 12.17$ sq. in. Assuming four angles, as shown in Fig. 22, the thickness required for each angle, assuming the width of bearing to be 5 in. per angle, is $\frac{12.17}{(4)(5)} = 0.608$, or $\frac{5}{8}$ in. Hence four $5 \times 3\frac{1}{2} \times \frac{5}{8}$ -in. angles will be used as end stiffeners, arranged as shown in Fig. 22.

The rivets connecting the end stiffeners to the web must transfer the shear from the web to the angles. From Table 2, p. 299 the end reaction is 292,000 lb. The connecting rivets, which are in bearing on the $\frac{7}{16}$ -in. web, have a value of 9,190 lb. per rivet. Hence the number required is $\frac{292,000}{9,190} = 32$. Figure 22 shows the required number in place.

In order to facilitate fabrication, it is desirable that the same vertical spacing of rivets be used in end and intermediate stiffeners. Hence the spacing of rivets in vertical lines must be such that $\frac{1}{8}$, or 12½ per cent of the web area is available as flange area. For the case under consideration, it was found $4\frac{1}{2}$ -in. spacing was necessary. For this spacing, the web area available for moment is $(\frac{1}{6})(\frac{4.5 - 1}{4.5}) = 0.1295$ - say 13 per cent.

The design of intermediate stiffeners is governed by Arts. [125 to 126], [433] of the Specifications. From Art. [125], [433], it can be seen that such stiffeners will be required, for the distance between flange angles exceeds fifty times the web thickness. The width of the outstanding leg, as required by Art. [125] of the Specifications, must be not less than $\frac{76.5}{30} + 2 = 4.55$ in. This requires a 5-in. leg. Two $5 \times 3\frac{1}{2} \times \frac{5}{8}$ -in. angles will be used placed with the $3\frac{1}{2}$ -in. legs against the web plate, as shown in Fig. 22. As shown in Fig. 22, the intermediate stiffener angles are crimped around the flange angles except where the cross frames are connected to the angles. Practice differs in regard to crimping intermediate stiffeners. Some designers prefer to keep the angles straight, using fills behind the angles.

The distance between stiffeners is determined from the formula given in Art. [125], [433] of the Specifications. For a $\frac{7}{16}$ -in. web plate, this formula may be written

$$d = 0.01092 (12,000 - S)$$

Stiffener spacings calculated for the shears given in Table 2 are as follows:

Point	End	a	b	c	d	e	f
Value of S	8,770.0	7,790.0	6,640.0	5,510.0	4,400.0	3,360.0	2,310.0
(12,000- S).....	3,230.0	4,210.0	5,360.0	6,490.0	7,600.0	8,640.0	9,690.0
d	35.2	46.0	58.5	70.9	83.0	94.3	106.0

Since the spacings given in this table for points d , e , and f exceed the limits stated in (a) and (b) of Art. [125], [433] of the Specifications, the calculated spacing for these points can not be used.

Before deciding upon the spacing of stiffeners to be adopted, it will be best to arrange the framing of the lateral system. As shown in Fig. 22, the stiffeners serve as a means of connecting the cross frames to the main girders. Therefore, the adopted stiffener spacing will be determined with regard to the requirements of the lateral bracing and cross frames, as stated in the following articles.

6f. Design of Lateral Bracing.—The design of lateral bracing for deck plate girders is governed by Arts. [105 to 113], [434 to 438] of the Specifications. In general, lateral bracing for deck girder bridges is made of the single Warren type. This system of bracing has certain disadvantages due to the secondary stresses induced by the deformation of the girder flanges and the laterals. These deformations cause lateral deflection of the flanges which are in opposite directions at adjacent panel points. The resulting bending stresses cause secondary stresses in the flanges which are likely to exceed the amount allowable under Art. [47] of the Specifications. Secondary stresses of the nature mentioned above may be almost entirely eliminated by the use of a double Warren system with transverse members at each panel point.

Figure 22 shows the lateral bracing adopted for the girder under consideration. The double Warren system recommended above is used. To conform to the requirements of Art. [107] of the Specifications, a top and a bottom lateral system must be provided, since the girder is over 50 ft. long. Some specifications do not require the use of a bottom lateral system in spans up to 70 ft. in length.

The layout of the lateral system shown in Fig. 22 was adopted because this arrangement provides diagonal members whose angle with the direction of lateral forces is approximately 45 deg. This can be shown to be the proper angle for maximum economy in use of material. Also, an even number of panels permits placing cross frames at every other panel. The distance between cross frames as provided is a little over 14 ft., which is within the limiting distance recommended in Art. [113] of the Specifications.

The lateral system must be designed for the loadings given in Art. [32], [209] of the Specifications. It will be found that the required loading is $200 + 700 = 900$ lb. per ft. for the top laterals and 150 lb. per ft. for the lower laterals. From Fig. 22 the lateral system panel length is about 7.1 ft. Hence the top lateral panel load is $(7.1)(900) = 6,390$ lb.

Figure 17 shows the outline of the lateral system, which has been simplified for the purposes of stress calculation. Considering the applied loads as moving, as required by the Specifications, and adopting the conventional method of live loading, the shears and stresses in the members are as follows:

Panel	Shear	Member	Stress
ab	22,400	ab' $a'b$	$\pm 16,300$
bc	16,800	bc' $c'b$	$\pm 12,200$
cd	12,000	cd' $c'd$	$\pm 8,700$
de	6,390	de' $d'e$	$\pm 4,600$

The stresses given in this table are calculated on the assumption that both diagonals in any panel are in action at the same time, one member having a tensile stress, the other a compressive stress. This assumption is in accordance with the provisions of Art. [106] of the Specifications. The stresses in all transverse struts at the joints are equal, each having a compression equal to one-half a joint load, or 3,200 lb.

The diagonal members of the lateral system must be designed to act either as tension or compression members capable of resisting the stresses calculated above. It is not generally

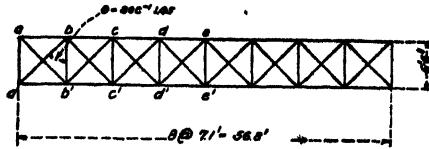

FIG. 17.

assumed, however, that the kind of stress changes during the passage of the train over the structure. The members may then be designed as simple tension or compression members which are not subject to reversal of stress of the nature covered by the provisions of Art. [44], [215] of the Specifications.

From the table of stresses given above, it will be found that the members of panel ab, Fig. 17, have the greatest stress, which is 16,300 lb. As a trial section, assume a single $3\frac{1}{2} \times 3 \times \frac{3}{8}$ -in. angle for each diagonal. This is the smallest angle which may be used according to Art [113] of the Specifications. Since the two diagonals are connected at their intersection, as shown in Fig. 22, the unsupported length of the member, considered as a column, may be taken as the distance from the intersection of the diagonals to the end rivet in the member. This distance, as scaled from Fig. 22, is about 4.25 ft. The least radius of gyration for the assumed section, as given in the rolling mill handbooks, is 0.62 in. and the area of the section is 2.30 sq. in. The allowable working stress, as given by the column formula of Art. [33], [301], is $15,000 - 50 \frac{(4.25)(12)}{0.62} = 10,900$ lb. per sq. in. Hence, area required in compression is $\frac{16,300}{10,900} = 1.49$ sq. in. The assumed section provides excess area as a compression member.

As shown in Fig. 22, the diagonals are connected to the girder by rivets through only one leg. The design of the diagonals as tension members is therefore subject to the requirements of Art. [55] of the Specifications, which provides that the net area of the connected leg and 50 per cent of the area of the unconnected leg shall be assumed as effective area. To determine this effective area for the $3\frac{1}{2} \times 3 \times \frac{3}{8}$ -in. angle under consideration, it will be assumed that the area of the $3\frac{1}{2}$ -in. or connected leg, is $(3.5)(\frac{3}{8}) = 1.31$ sq. in. Hence the area of the unconnected leg must be $(2.30 - 1.31) = 0.99$ sq. in. The effective area of the angle is then $(3.5 - 1)(\frac{3}{8}) + (0.5)(0.99) = 0.936 + 0.495 = 1.431$ sq. in. The required net area is $\frac{16,300}{16,000} = 1.02$ sq. in. Therefore the assumed section is ample for tension and compression. Since the minimum allowable angles are ample for the panel in which the stresses are greatest, it is evident that these angles may be used in all panels for the diagonals and transverse members, as shown in Fig. 22.

The design of the rivets connecting the lateral angles to the girder is governed by Art. [57] of the Specifications, which states that the connections must be designed for the full strength of the member and not for the computed stresses. Considered as a compression member, assuming the full area of the member as effective, the adopted $3\frac{1}{2} \times 3 \times \frac{3}{8}$ -in. angle has a strength of $(2.3)(10,900) = 25,000$ lb. for the allowable working stress determined above. Considered as a tension member, the strength of the member for the net area given above is $(1.431)(16,000) = 22,900$ lb. Hence the connections must be designed for a stress of 25,000 lb.

The number of rivets required at the ends of each member will depend upon the erection methods adopted. If the girders and laterals are riveted up completely in the shop and shipped in one piece, which is often done for spans under 60 ft. in length, the connecting rivets may be proportioned as shop rivets in single shear at 12,000 lb. per sq. in. The value,

of a $\frac{1}{8}$ -in. shop rivet in single shear is 7,220 lb. Hence $\frac{25,000}{7,220} = 4$ rivets are required in the end of each member. If the girders are shipped separately and the laterals riveted in place in the field, the allowable rivet values must be reduced 25 per cent (Art. [38], [301], Specifications). The value of a rivet is then $(0.75)(7,220) = 5,420$ lb. per rivet, and $\frac{25,000}{5,420} = 5$ rivets are required. It will be assumed that the former condition governs and four rivets will be used in each member, as shown in Fig. 22.

6g. Design of Cross Frames.—As stated in Art. 6f, cross frames will be placed at every other panel point of the lateral system, as shown in Fig. 22, which provides a cross frame every 14.1 ft. This meets the requirements of Art. [112] of the Specifications, which requires that cross frames be placed at intervals not to exceed 18 ft.

In designing cross frames, it is generally assumed that the end cross frames transfer to the abutments or piers the end reactions for the top lateral system, while the intermediate cross frames act merely as separators which increase the rigidity of the structure as a whole. The end cross frames must therefore be designed to carry the top chord lateral loads to the supports. The intermediate cross frames are not designed for any definite stress but generally are composed of angles of minimum allowable size.

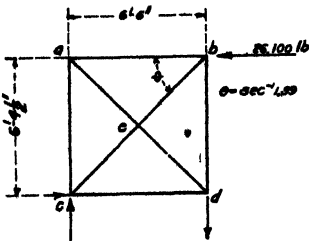

FIG. 18.

From Art. 6f, the total top chord lateral load is 900 lb. per ft. Considering the effective length of the top lateral system to be equal to the distance center to center of bearings, the reaction at each end of the top lateral system is $(\frac{1}{2})(58)(900) = 26,100$ lb. Figure 18 shows an outline sketch of an end cross frame with the lateral reaction load in position.

In determining the stresses in the cross frame of Fig. 18, it will be assumed that only the compression diagonal bc is in action, and that member ad is not in action. Any load applied at b Fig. 18 may be transferred to a support at c over two paths. One path consists of member bc and the other path contains members ba , ad , and dc . It can be shown that when a load is passing from one point to another it may be divided over two paths, the portion of the load taken by each path will be in proportion to the relative rigidity of the two paths. Since the path offered by member bc is shorter and much more rigid than the other path named above, it is evident that member bc will take the greater part of the load at b . It will be on the side of safety to assume that all of the load is taken by member bc . Hence for the assumed conditions, the stress in bc of Fig. 18 is $(26,100)(1.39) = 36,200$ lb. compression. When the lateral forces act at point a , member ad will then be stressed instead of bc .

Since the diagonal under stress is supported at its center point by the inactive diagonal, as shown in Fig. 18, it seems reasonable to assume that the unsupported length of the compression member bc may be taken as the distance from the intersection of the diagonals to the end rivets. From Fig. 22, this distance is about 4 ft. Assume the diagonals are composed of single $5 \times 3\frac{1}{2} \times \frac{3}{8}$ -in. angles placed with the 5-in. leg against the gusset plates. From the rolling mill handbooks, the least radius of gyration of the assumed angle is 0.76 in. and its area is 3.05 sq. in. The allowable stress in the member is then $15,000 - 50 \frac{(4.0)(12)}{(0.76)} = 11,840$ lb. per sq. in. and the required area is $\frac{36,200}{11,840} = 3.06$ sq. in. The assumed member provides the necessary area. Since the full strength of the angle is practically the same as the load carried by the member, the rivets required in the ends of the angle must be proportioned for a stress of 36,200 lb. The number of rivets required in each end of the member is therefore $\frac{36,200}{7,220} = 5$, the number shown in place on Fig. 22.

Complete details of the end cross frames are shown on Fig. 22. The upper and lower horizontal members have been made the same size as the diagonals. Although the stresses in these members are small, large angles have been provided in order to secure a rigid frame. Figure 22 also shows the details of the intermediate cross frames. Angles of minimum size have been used for these frames.

The spacing of stiffeners may now be definitely determined. In Art. 6e, p. 310, the limiting values of stiffener spacing have been determined. Since cross frames are to be placed at every other transverse lateral member shown in Fig. 22, it will be necessary to locate a stiffener at these points in order to provide the necessary means for the attachment of the cross frames to the girders. To conform to the required stiffener spacing given on p. 312, the two end panels of the lateral system will be divided into two parts and a stiffener will be placed at the first panel point and one at the center of each of these panels, as shown in Fig. 22. The distance from the first intermediate cross frame to the girder center will be divided into three parts, and a stiffener will be placed at each of these points, as shown in Fig. 22. The adopted stiffener spacing will be found to answer all of the requirements of Art. [125], [433] of the Specifications.

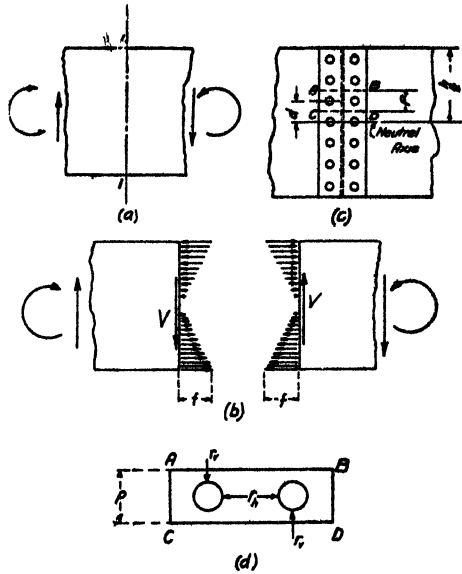

FIG. 19.

6h. Design of Web Splices.—It is generally not possible to obtain rolled plates in single pieces which are large enough to form the web plates for girder spans over about 40 to 50 ft. long. The web plates in large spans must therefore be made from several pieces spliced together. Tables given in the rolling mill handbooks furnish lists of the sizes of plates obtainable.

Theory of Web Splice Design.—Figure 19 (a) shows a portion of a web plate subjected to moment and shear. If this plate be cut at any section 1-1, the forces acting on the section will be of the nature shown in Fig. 19 (b). To splice any cut section, it is therefore necessary to transfer across the section the forces shown in Fig. 19 (b). This may be done by means of plates placed one on each side of the web plate, as shown in Fig. 19 (c). The rivets connecting the web plate and the splice plates must be capable of transferring across the section the forces shown in Fig. 19 (b).

Let $ABCD$ of Fig. 19 (d) show a strip of the splice plate of Fig. 19 (c). Assume this strip to be located at a distance d from the neutral axis of the plate and assume also that the width of the strip is p , the vertical distance between adjacent rivets.

The action of the bending stresses f of Fig. 19 (b) on the rivets shown in Fig. 19 (d) is represented by r_A . If $f =$ stress on an extreme fiber at the edge of the plate, the fiber stress at a distance d from the neutral axis is $\frac{f}{h/2} \cdot d$. Hence the total stress on a section of the web plate of width p is $r_A = 2pd\frac{f}{h}$, where $t =$ thickness

of web plate. If the value of a rivet at the top edge of the web plate is r , it is evident that its value at distance d above the neutral axis is proportional to the deformation of the web plate under the existing fiber stresses at the edge of the plate and at distance d from the neutral axis. Hence the value of a rivet in $ABCD$ of Fig. 19 (c) is $\frac{r}{h/2}d$. The proper spacing of rivets for bending considered alone may be determined by placing r_s equal to the value of a rivet, as determined above. Hence $2ptd \frac{f}{h} = \frac{2r}{h}d$, from which

$$p = \frac{r}{ft} \quad (1)$$

Since this expression does not contain d , the distance from the strip $ABCD$ to the neutral axis, it is evident that the pitch of rivets is uniform over the entire depth of the web plate.

Equation (1) is derived for the conditions existing on the compression side of the neutral axis. The value of f in eq. (1) may be determined from eq. (2), p. 296. On the tension side of the splice the pitch p must be such that the proper portion of the web plate is available as flange area. The percentage of web area available as flange area may be determined from the equation $\left(\frac{1}{6}\right)\frac{(p-c)}{p}$, in which p = rivet pitch and c = diameter of a rivet hole. In general this percentage must be not less than $12\frac{1}{2}$, or one-eighth of the web area. When $\frac{3}{8}$ -in. rivets are used ($c = 1$ in.) p must be not less than 4 in. If p from eq. (1) is less than 4 in., two or more vertical rows of rivets must be used in order to give a rivet spacing of at least 4 in.

The action of the shearing stresses of Fig. 19 (b) on the rivets shown in Fig. 19 (d) is represented by r_s . It may be assumed with sufficient accuracy that the shear V is uniformly distributed over the web. Hence for a web of depth h , the shear per inch is $\frac{V}{h}$. If the rivets are spaced at a distance p in a vertical line, the stress on a rivet of Fig. 19 (d) is $r_s = p\frac{V}{h}$. For a rivet of value r , the pitch for shear, considered as acting alone, is

$$p = \frac{rh}{V} \quad (2)$$

The rivet spacing given by eqs. (1) and (2) assumes that the splice carries either moment or shear, but not both. In most cases, the splice must be designed for the combined action of moment and shear. The stress on a rivet of Fig. 19 (d) is then the resultant due to r_s and r_s . We then have $r = (r_s^2 + r_s^2)^{\frac{1}{2}}$. On substituting in this equation the values of r_s and r_s , given above, and solving for p , the rivet pitch, we derive

$$p = \frac{r}{\left[(ft)^2 + \left(\frac{V}{h}\right)^2\right]^{\frac{1}{2}}} \quad (3)$$

In eq. (3), r = value of a rivet; f = extreme fiber stress on gross flange area, as given by eq. (2), p. 296; t = thickness of web plate in inches; V = vertical shear at splice; and h = effective depth of girder section at the splice.

It is possible, by means of splice plates, to cover only that portion of the web plate between the flange angles, as shown in Fig. 20. The rivet spacing formulas given above therefore apply for the splice plate between the flange angles. These plates do not take care of the portion of the web plate under the flange angles.

To splice the portion of the web under the flange angles, splice plates may be placed on the vertical legs of the flange angles, as shown at the top flange angles of Fig. 20 (a). The area of these plates must be equal to the area of the web plate under the angles. If the splice is located near the end of a cover plate, as shown at the lower flange of Fig. 20 (a), the excess flange area provided by the cover plate may be utilized in making the splice for the portion of the web under the flange angles. This may be done when the fiber stress on the flange section due to bending plus the excess load from the web under the flange angles does not exceed the allowable fiber stress.

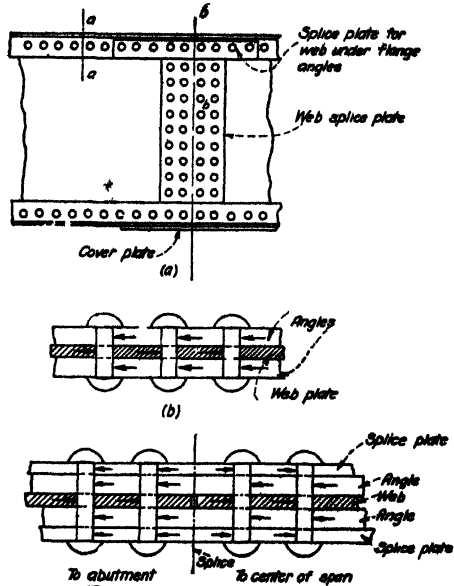

FIG. 20.

The splice plates, shown on the upper flange of Fig. 20 (a), must be connected to the vertical

legs of the flange angles by rivets capable of transferring the stress in the splice plates to the angles. At a section *a-a*, Fig. 20 (a) in the unspliced web, the loads on the rivets act as shown in Fig. 20 (b), which is a horizontal cross-section of the web and the vertical legs of the flange angles. The rivets are shown to be in bearing on the web plate. Figure 20 (c) shows a horizontal section of the web plate, flange angles, and splice plates taken near the splice. The stresses in the splice plates stress the rivets as shown by the arrows. To the left (abutment side) of the splice, the rivet loads are directed to the left. To the right (toward the girder center), the rivet loads are directed to the right. On both sides of the splice, the loads on the rivets due to stress in the flange angles have the same direction as in Fig. 20 (b). Therefore, as shown in Fig. 20 (c), the rivets to the left of the splice are subjected to extra duty due to the presence of the flange splice plate stress. These rivets are in bearing on the web, and must carry the loads due to the increments of flange stress and also the splice plate load. Extra rivets must therefore be provided on this side of the splice. On the right of the splice, the load from the stress in the splice plate tends to relieve the stress on the rivets through the web. No extra rivets are therefore required on this side of the splice.

In designing the rivets connecting the splice plates to the flange angles, the number of rivets required to the left of the splice is equal to the stress in the splice plate divided by the value of a rivet in bearing on the web plate. As stated above,

these rivets must be provided in addition to the number required to transfer the increments of flange stress to the web plate, as calculated in Art. 6d. These extra rivets may be provided by decreasing the rivet pitch as calculated in Art. 6d. Let p = calculated rivet pitch at the splice as given in Table 3, p. 309; n = number of extra rivets which must be provided to transfer the splice plate stress to the angles; q = revised pitch necessary to provide n extra rivets; and m = number of spaces of pitch p which must be shortened to q in order to provide n extra rivets. It can readily be shown that

$$m = \frac{nq}{p - q} \quad (4)$$

The application of this equation is shown in the following article.

On the right of the splice it can be seen from Fig. 20 (c) that the rivets connecting the splice plate to the flange angles are in double shear or in bearing on the legs of the flange angles. In general, the former value will govern. The rivets required by Table 3, p. 309 may serve the double purpose of splice plate rivets and connecting rivets between the flange angles and the web plate. No extra rivets are required on this side of the splice. If the splice is located at the center of the girder, extra rivets must be provided on both sides of the splice, as noted above.

The discussion given above has referred only to the conditions existing at the top flange angles. It can readily be shown that the same conditions exist also at the lower flange.

Web Splice for 60-ft. Span.—The design of web splices is governed by Art. [123] of the Specifications, which states that the splice shall be equal to the web in strength in both shear and moment. A splice designed according to these requirements may be located at any point in the girder, for the design of the splice is determined by the size of the web plate and the allowable working stresses, and not by the existing values of the external moment and shear. For the girder under consideration, splices will be located at the second stiffeners each side of the center of the girder, as shown in Fig. 22.

To obtain a splice which will develop the full bending strength of the web plate, the value of f in eq. (3), p. 316 must be determined on the basis of a fiber stress of 16,000 lb. per sq. in. on an extreme fiber of the net web section. The corresponding fiber stress on the gross web area, which may be taken as equal to the average fiber stress on the gross flange area, may be obtained by multiplying the maximum fiber stress by the ratio of net and gross flange areas. That is

$$f = f_{max} \frac{F_n + \frac{1}{8} A_w}{F_g + \frac{1}{6} A_w}$$

For the girder section under consideration, we have for the compression flange, $f = (16,000) \left(\frac{37.32}{44.73} \right) = 13,300$ lb. per sq. in. The shear value of the web must be determined for the full shearing strength of the web plate. The area of a $76 \times \frac{7}{16}$ -in. plate is 33.25 sq. in. Hence its shear carrying capacity is $(33.25)(10,000) = 332,500$ lb. Rivets in bearing on the $\frac{7}{16}$ -in. web plate have a value of 9,190 lb. per rivet. The effective depth of the girder at the center, as calculated on p. 302 is 76.14 in. Then from eq. (3), p. 316, the rivet spacing in the web splice between flange angles is

$$p = \frac{9.19}{\left\{ \left[(13.3) \left(\frac{7}{16} \right) \right]^2 + \left(\frac{332.5}{76.14} \right)^2 \right\}^{\frac{1}{2}}} = 1.26 \text{ in.}$$

The spacing of rivets in the web splice should conform to the spacing in the end stiffeners. On p. 311 it was found that $4\frac{1}{2}$ -in. spacing is required in the stiffeners.

Hence $\frac{4.5}{1.26} = 3.56$ or 4 vertical rows of rivets are required on each side of the splice. These rivets are shown in position on Fig. 21. Since no material less than $\frac{3}{8}$ in. thick may be used (Art. [58], Specifications), splice plates $\frac{3}{8}$ in. thick and wide enough to take eight vertical lines of rivets must be provided. These plates are shown in position in Fig. 21.

The portion of the web plate under the flange angles is $5\frac{3}{4}$ in. wide and $\frac{7}{16}$ in. thick, and its area is therefore $(5\frac{3}{4})(\frac{7}{16}) = 2.52$ sq. in. Since the portion of the web plate under the flange angles is rigidly connected to the angles, the deformation of this portion of the web plate, and therefore also its fiber stress, may be taken as the same as the fiber stress on the gross flange section, which is given above as 13,300 lb. per sq. in. Hence the stress in the web plate under the flange angles is $(2.52)(13,300) = 33,600$ lb.

The splice plates on the vertical legs of the flange angles must furnish an area equal to that of the web plate under the angles. Since no material less than $\frac{3}{8}$ in. thick may be used (Art. [58], Specifications) these plates will be made $\frac{3}{8}$ in. thick and as wide as the conditions will permit. From Fig. 21, it can be seen that plates 5 in. wide may be used. Hence the area provided in splice plates is $(2)(5)(\frac{3}{8}) = 3.75$ sq. in., which is in excess of the area required.

As stated on p. 317, the rivets connecting the splice plates to the flange angles are in bearing on the web plate. The value of a rivet is then 9,190 lb. Hence $\frac{33,600}{9,190} = 4$ rivets are required. Since the splice plates are separated from the web plate by the flange angles, an indirect splice is formed. From Art. [80], Specifications, two extra lines of rivets must be provided. As shown in Fig. 21, each vertical line in the splice plate contains one rivet. Hence two additional rivets, or a total of six, must be provided on each side of the splice. These rivets are in addition to those required for rivet spacing as given in Table 3, p. 309. From Fig. 22, the adopted spacing in the vicinity of the splice is $4\frac{1}{2}$ in. Assuming that the additional rivets are to be provided by shortening the adopted spacing to $2\frac{3}{4}$ in., we find from eq. (4), p. 318 that to provide $n = 6$ additional rivets

$$m = \frac{(6)(2\frac{3}{4})}{4\frac{1}{2} - 2\frac{3}{4}} = 6$$

that is, on the left side of the splice six $4\frac{1}{4}$ -in. spaces must be shortened to $2\frac{3}{4}$ in., as shown in Fig. 21. As stated on p. 317, no additional rivets are required on the right side of the splice. It will be found that the splice plates on the lower or tension flange may be made the same as those calculated above for the compression flange.

When the Specifications do not require a web splice which will develop the full bending and shearing strength of the web plate, the splice may be designed for the existing shear and moment. As an example of this method of calculation, assume that the web plate is divided into three parts by splices located at the second stiffener each side of the girder center, or about 9 ft. $8\frac{1}{4}$ in. each side of the girder center. It will be found that the maximum moment at these points is 41,015,000 in.-lb. and the simultaneous shear is 118,800 lb. The girder section at this point is the same as at the girder center.

The actual fiber stress on the gross flange section is

$$f = \frac{41,015,000}{(76.14)(44.73)} = 12,100 \text{ lb. per sq. in.}$$

Then from eq. (3), p. 316, the required rivet pitch is

$$p = \frac{9.19}{\left\{ \left[(12.1)\left(\frac{7}{16}\right) \right]^2 + \left(\frac{118.8}{76.14}\right)^2 \right\}^{\frac{1}{2}}} = 1.67 \text{ in.}$$

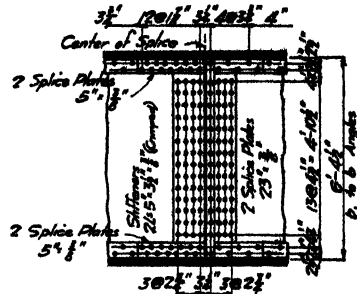

FIG. 21.

To conform to the end stiffener spacing of $4\frac{1}{2}$ in. adopted on p. 311, three vertical rows of rivets spaced at $4\frac{1}{2}$ in. must be provided. It is also necessary to investigate the conditions which exist for maximum shear and simultaneous moment. The required spacing is found to be slightly greater than calculated above.

The stress on the portion of the web plate under the flange angles is $(5\frac{3}{4})(\frac{3}{16})(12,100) = 30,400$ lb. If the available flange area is sufficient to carry the flange stress due to moment in addition to the web plate stress calculated above without exceeding the fiber stress allowed by Art. [48] of the Specifications, side plates are not required on the vertical legs of the flange angles. For the conditions stated above, the total fiber stress on the compression flange is

$$f_b = \frac{\left(\frac{41,015,000}{76.14} + 30,400\right)}{(44.73)} = 12,800 \text{ lb. per sq. in.}$$

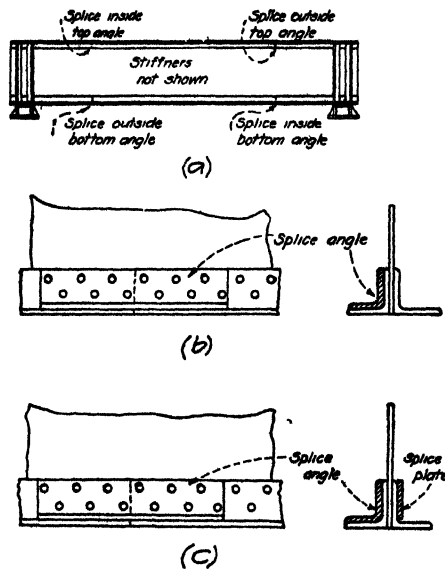

FIG. 23.

On p. 302, the fiber stress allowable under Art. [48], [301] of the Specifications is 15,100 lb. per sq. in. Hence side splice plates on the flange angles are not required. However, the stress of 30,400 lb. must be transferred across the cut section of the web by the flange section. On the side of the splice toward the abutment, additional rivets must be placed in the vertical legs of the flange angles, as in the preceding case. These rivets must be sufficient in number to transfer to the web the portion of the 30,400 lb. load which is carried by the vertical legs of the angles.

6i. Splices for Flange Elements.—It is sometimes necessary in very long girders to splice flange elements such as the flange angles and cover plates. Since the steel mills are able to roll plates and angles in lengths up to about 100 ft., it is seldom necessary to splice the flanges. Splices in these elements should be used only when absolutely necessary.

When the flange angles must be spliced, the splices should, if possible, be located as shown in Fig. 23 (a). This arrangement distributes the splices so that only one angle need be cut at any one place, and permits symmetrical details.

If the girder is to be shipped in parts, the splices should be staggered, but may be made to cover a much shorter distance than shown in Fig. 23 (a).

The angle which is to be spliced must be replaced by splice angles or plates of equivalent area. Figure 23 (b) shows a splice made by placing a splice angle on the legs of the cut angle. This arrangement may be used where the main flange angles are of medium thickness, say not in excess of about $\frac{5}{8}$ in. It is then possible to use as a splice angle an angle of greater thickness with its legs sheared down to fit inside the main angles. When this arrangement calls for material the thickness of which is greater than the rivet diameter, it will be best to make use of the detail shown in Fig. 23 (c). In this case the splice material is provided by a splice angle on the cut member and a splice plate on the vertical leg of the uncut angle. In any case, the net area of splicing material must be equal to the net area of the angle to be spliced.

The number of rivets required in a splice of this nature depends upon the arrangement of the parts. For the splice shown in Fig. 23 (b) the rivets are in single shear. Since the presence of the splice does not alter the loading conditions on the rivets, extra rivets are not required, and the rivets which transfer the flange stress to the web plate may also be used as splice rivets. When a splice of the form shown in Fig. 23 (c) is used, the stresses in the splice angle and splice plate are in proportion to their relative areas. The rivets required may be determined independently for the plate and angle, using the single shear value of a rivet. Since the splice plate is not in direct contact with the angle to be spliced, extra rivets must be supplied subject to Art. [80] of the Specifications. For the conditions shown in Fig. 23 (c) the web plate and flange angle lie between the angle to be spliced and the splice plate. Hence four extra rivets are required for the arrangement of rivets shown in Fig. 23 (c).

A splice in an outside cover plate, as at *a* Fig. 24, may be made by means of a splice plate of the same area as the plate to be spliced. This plate may be placed on the outside of the cut plate and connected to the flange by rivets in single shear sufficient in number to develop the full strength of the cut plate. When an inside plate is to be spliced, as at *b* Fig. 24, the splice should, if possible, be located at the theoretical cut-off point of one of the outside cover plates, as at *c*, Fig. 24. This cover plate can then be extended across the splice to form the splice plate. Plate *c* should be extended beyond the splice far enough to develop the full strength of the plate to be spliced. These rivets are in single shear. When the splice plate or extended cover plate are not in direct contact with the plate to be spliced, additional rivets must be supplied subject to the requirements of Art. [80] of the Specifications.

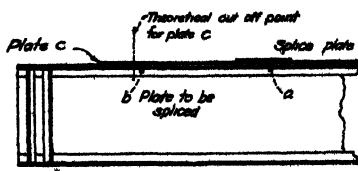

FIG. 24.

6j. End Bearings.—The end bearings for a plate girder span must be designed to transfer the maximum end reactions to the piers or abutments without exceeding the allowable bearing pressures on the masonry. At the same time, these bearings must permit longitudinal movement due to stress and temperature changes.

Figure 25 shows typical end bearings for plate girder spans. The design shown in Fig. 25 (a) may be used for short spans, say up to about 40 ft. For longer

spans, this design is not of sufficient rigidity for the heavy loads encountered. Also, the length of bearing is such that the deflection of the girder tends to concentrate the reaction at the inner edge of the bearing, causing excessive pressures on the masonry. The design shown in Fig. 25 (b) is more rigid due to the presence

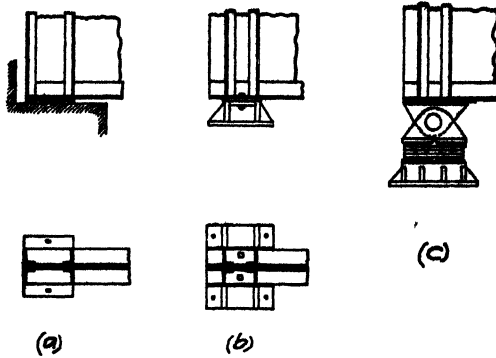

FIG. 25.

of the deep cast base. Also, the bearing between the girder and the cast base is relatively narrow, which avoids the excessive bearing pressures mentioned above.

Bearings of the type shown in Figs. 25 (a) and (b) are generally arranged with the sole plate free to slide on the masonry plate or cast base, which is rigidly fastened to the masonry. The bolts connecting the girder to the base are placed in slotted holes which will permit the necessary movement due to temperature or stress

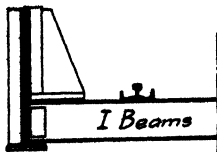

FIG. 26.

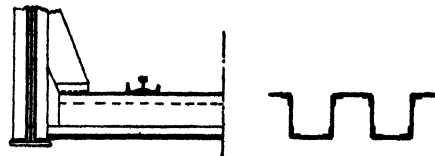

FIG. 27.

changes in the length of the girder. At the other end of the girder, all parts are rigidly connected. The length of the slotted holes must be such as to permit an expansion of 1 in. per 100 ft. in length of girder (Art. [88], Specifications). Sliding bearings of this type may be used in spans up to 70 ft. in length (Art. [89], Specifications).

For spans over 70 ft. long, the type of end bearing shown in Fig. 25 (c) is generally used. The connection between the girder and the roller bearing is made by means of a pin. This pin takes up any rotation which may be due to the deflection of the girder and secures uniform bearing pressures between the rollers and the upper and lower bearing plates. The design of rollers is governed by Arts. [38, 91, and 92], [301] of the Specifications.

For the 60-ft. girder under consideration, the end reaction is equal to the end shear of 292,000 lb. as given in Table 2, p. 299. From Art. [88] of the Specifications, the allowable bearing pressure on concrete masonry is 600 lb. per sq. in. Hence the area of base required

$$= \frac{292,000}{600} = 487 \text{ sq. in.}$$

A base 20 × 25 in. will provide the necessary area. The top of

the base should be made wide enough to include the end stiffener angles of the girder. Figure 22 shows the general dimensions of the adopted base, which may be designed by the methods given for Cast Bases in the volume on "Structural Members and Connections."

7. Through Plate Girder Bridges.—Through plate girder bridges are used when the clearance between high water and the under side of the bridge is not sufficient to permit the use of a relatively deep deck structure. Also in track elevation bridges in cities the use of through girders with shallow floors secures the necessary clearance under bridges at street crossings with a minimum amount of grading and elevation of tracks.

7a. Floors for Through Girder Bridges.—An open floor system consisting of floor beams and stringers with wooden ties is often used. This floor is similar to the one used in truss bridge spans. When a very shallow floor is desired, the track is supported on transverse closely spaced I-beams, as shown in Fig. 26. A trough floor construction of the type shown in Fig. 27 is also used. Shallow floors consisting of transverse beams are to be designed for the loadings

given in Art. [25], [204] of the Specifications. Methods of design are governed by Art. [104] of the Specifications. Figure 28 shows types of shallow ballasted floors.

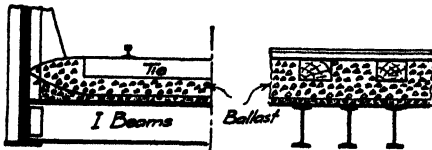
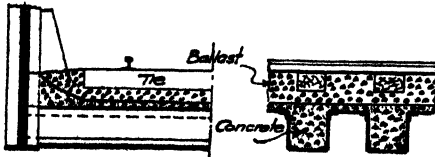

FIG. 28.

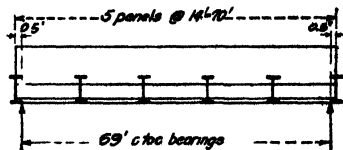

FIG. 29.

7b. Design of a Through Plate Girder Span.—As an example of through plate girder design, complete calculations will be given for the design of a 70-ft. single track span. An open floor consisting of stringers and floor beams with wooden ties will be used. The design will be governed by the A. R. E. A. Specifications for Cooper's E-60 loading. As shown in Fig. 29, the distance center to center of beams will be taken as 69 ft. The floor system will be arranged with five 14-ft. panels, as shown in Fig. 29. The stringers will be spaced 6 ft. 6 in. centers as recommended in Art. [98] of the Specifications.

It will be found that an odd number of panels is advantageous, for with this arrangement the maximum moment occurs at a point one-half a panel length from the girder center. If an even number of panels is used, the maximum moment occurs at the girder center. The maximum moment for the odd number of panels adopted will be somewhat smaller than for an even number of panels.

Maximum Moments and Shears.—The estimated dead weight of the girder will be determined from eq. (4), p. 290. With $l = 69$ ft. and $h = 1.10$, $w = 1.10[(14)(69) + 450] = 1,554$ lb. per ft. of girder. Since the spacing of stringers is the same as the spacing of girders for the deck plate girder designed in the preceding pages, the design of the ties is the same as given on p. 295, and the weight of the wooden floor and track is 486 lb. per ft. of bridge, as given on p. 299. The total weight of the girder is then $1,554 + 486 = 2,040$ lb. per ft.

A load of 2,000 lb. per ft. of bridge or 1,000 lb. per ft. per girder will be used in determining dead load moments and shears. Tables 4 and 5 give the resulting dead load moments and shears, which were calculated for panel loads of 14,000 lb. at the several joints.

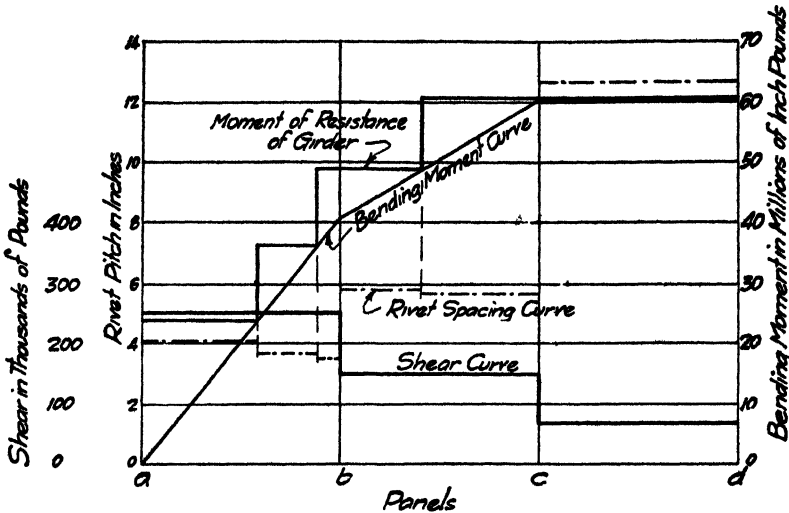

FIG. 30.

The live load moments and shears for E-60 loading are also given in Tables 4 and 5. These values were calculated by the methods given in the volume on "Stresses in Framed Structures." The impact allowance is determined by the formula of Art. [28], [206] of the Specifications. Moment and shear curves plotted from the values given in Tables 4 and 5 are shown in Fig. 30.

TABLE 4.—MAXIMUM MOMENTS

Point	a	b	c
Dead load moment	0	378,000	574,000
Live load moment	0	1,600,000	2,390,000
Impact moment	0	1,382,000	2,065,000
Total moment, ft.-lb.	0	3,360,000	5,029,000
Total moment, in.-lb.	0	40,300,000	60,350,000

TABLE 5.—MAXIMUM SHEARS

Panel	End reaction	ab	bc	cd
Dead load shear	35,000	28,000	14,000	0
Live load shear	165,800	117,000	71,800	34,900
Impact shear	143,000	103,000	68,800	33,400
Total shear	343,800	248,000	152,100	68,300

Design of Girders.—Design methods for the main girders are the same as given in Art. 66, p. 295. Since the shear in the end panel is 248,000 lb., a 68- × 3/8-in. web plate will provide sufficient shear area. To satisfy economical weight conditions, a 109 1/2- × 1/4-in. plate is required. As a compromise, an 84- × 1/4-in. plate will be used and the flange angles will be placed 84 1/2 in. back to back.

Figure 31 shows the adopted flange section. The gross area of this section, including one-sixth web area, is 53.60 sq. in. and the net area, including one-eighth web area, is 44.73 sq. in. As shown in Fig. 31, the center of gravity of the section is located outside the backs

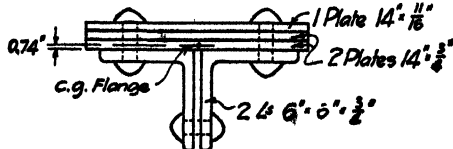

FIG. 31.

of the angles. Hence the effective depth must be taken as the distance back to back of flange angle (Art. {11}, {104} of the Specifications). The total net flange area required is then $\frac{60,350,000}{(84.5)(16,000)} = 44.60$ sq. in. For the assumed section, the fiber stress on the compression flange is $\frac{60,350,000}{(84.5)(53.60)} = 13,320$ lb. per sq. in. Since the top flange is supported at each panel, or at intervals of 14 ft., and since the cover plates are 14 in. wide, the allowable compression (Art. {48}, {301} of the Specifications) is 16,000 - $(150) \frac{(14)(12)}{(14)} = 14,200$ lb. per sq. in. Using the same methods as given on p. 303, it was found that the horizontal shear in the angle legs is 1,650 lb. per sq. in. for the compression flange and 1,520 lb. per sq. in. for the tension flange. From Art. {38}, {301} of the Specifications the allowable shear is 4,000 lb. per sq. in. The section shown in Fig. 31 answers all conditions and will be adopted as final.

Other details of the design of the main girders are shown on the general drawing of Fig. 32. The cut-off points for cover plates were determined by the method used in Art. 6c for the deck girder. Figure 30 shows the moment of resistance curves and the theoretical cut-off points for the several plates. As shown on Fig. 32 the top plate is run full length of the girder and is brought down over the end stiffeners. The end of the girder is curved to add neatness to the appearance of the bridge. Figure 30 also shows the calculated rivet pitch in the girder flanges. Since no vertical loads are carried by the flange angles, the rivet pitch may be determined from eq. (5) p. 307. It will be found that the tension flange rivet pitch is smaller than the compression flange pitch. The former values therefore govern.

The design methods used for determination of stiffener spacing, the web splice, and the lateral bracing are the same as used for the deck span. All details are as shown on Fig. 32.

The design of the end stiffeners requires special consideration. It will be assumed that the shear in the end panel is taken by the inside set of end stiffeners. From Table 5, p. 324, the shear in the end panel is 248,000 lb. Hence the bearing area required is $\frac{248,000}{24,000} = 10.3$ sq. in. Since only the outstanding legs of the stiffener angles may be counted in bearing (Art. {124}, Specifications) four 5- × 3 1/2- × 1/2-in. angles will be used, arranged as shown in Fig. 32. The bearing area provided is then 10 sq. in. As shown in Fig. 32, the end floor beam is attached to the outside pair of end stiffeners, which consist of two 6- × 4- × 3/4-in. angles. These angles were made the same thickness as the main flange angles in order to simplify the splice at the curve in the girder flange. The bearing area provided on the lower flange angles by the 6-in. legs of these stiffener angles is $(2)(5 1/4)(3/4) = 7.87$ sq. in. From p. 328, the end reaction for an end floor beam is 119,200 lb. Hence the bearing area required at the foot of the supporting end stiffener angles is $\frac{119,200}{24,000} = 4.97$ sq. in. The angles provided furnish excess area, but as shown in Fig. 32, the floor beam connection is eccentric. Excess area is therefore desirable and the detail shown will be adopted.

Design of the Floor System.—The stringers are to be designed as simple beams 14 ft. long subjected to their own weight, the weight of the bridge floor, and to the live load of

Art. [20], [203] of the Specifications. From p. 323 the bridge floor weighs 486 lb. per ft. of bridge and from eq. (3), p. 290, the stringers weigh $1.10 [(12\frac{1}{2})(14) + 100] = 30$ lb. per ft. of bridge. The dead load to be carried is then $\frac{1}{2}(486 + 303) = 395$ lb. per ft. per stringer. Hence the dead load center moment is $(\frac{1}{8})(395)(14)^2 = 9,680$ ft.-lb. and the end shear is $(7)(395) = 2,765$ lb. The maximum live load moment is found to occur under the special loading of Fig. 3 (Art. [20], Specifications) and the resulting absolute maximum moment is 177,000 ft.-lb. The maximum end live load shear occurs under the loading of Fig. 2 of the Specifications, and the value of the end shear is 57,800 lb. For moment and shear, the impact coefficient given by the formula of Art. [23], [206] of the Specifications ($L = 14$ ft.) is 99.4 per cent. The total moments and shears are found to be 4,360,000 in.-lb. and 118,200 lb. respectively.

The depth of stringer for short panels is generally taken as about one-seventh of the span. For the case under consideration the web plate will be made 24 in. deep and the flange angle will be placed $24\frac{1}{4}$ in. back to back, as allowed under Art. [233] of the Specification. Since the end shear is 118,200 lb., the web area required is 11.82 sq. in. (Art. [33], [301] Specifications). A $24 \times \frac{1}{2}$ -in. web plate supplies 12.0 sq. in.

A flange section consisting of two $6 \times 6 \times \frac{1}{8}$ -in. angles will be assumed. Effective depth = $24.25 - (2)(1.71) = 20.83$ in. The assumed angles furnish a net area (one rivet hole from each angle) of $(2)(6.43 - 0.56) = 11.74$ sq. in. Area required = $\frac{4,360,000}{(20.83)(16,000)} = 13.08$ sq. in. Assuming one-eighth of the web area as available flange area, the area required in angles is $13.08 \div (\frac{1}{8})(24)(\frac{1}{2}) = 11.58$ sq. in. The assumed angles provide the required area and they will be adopted. Since the unsupported web plate between flange angles is $12\frac{1}{4}$ in. wide, no web stiffeners are required (Art. [123], [433] Specifications).

The rivet pitch in the flange angles may be determined from eq. (6) p. 308. In this equation, the vertical load on the top flange is

$$w = \frac{60,000}{36} + \frac{486}{(2)(12)} = 1,687 \text{ lb. per in.}$$

At the end of the stringer, where the shear is 118,200 lb., the rivet spacing is found to be

$$p = \frac{10,500}{\left[\left(\frac{118,200}{20.83} \cdot \frac{12.86}{12.86 + 2} \right)^2 + (1,687)^2 \right]^{\frac{1}{2}}} = 2.04 \text{ in.}$$

To determine the rivet spacing at the quarter point and center of the stringer, approximate values of the shears at these points may be taken as equal to five-eighths and two-sevenths of the total end shear. The resulting rivet spacings are found to be 3.06 in. and 5.0 in. respectively. The adopted rivet spacing is shown on Fig. 32.

The design of the end connection angles for the stringer is governed by Art. [101], [421] of the Specifications. Figure 33 shows the adopted detail. As given above, the end shear on a stringer is 118,200 lb. The rivets connecting the connection angles to the stringer are in double shear, and the number required is $\frac{118,200}{14,400} = 9$ rivets. The end reaction must be transferred to the web plate by rivets which are in bearing on the $\frac{1}{2}$ -in. web plate, which requires $\frac{118,200}{10,500} = 12$ rivets. Figure 33 shows 8 rivets in double shear in the end connection angles between flange angles and 4 other rivets which also pass through the flange angles. These rivets are counted as flange rivets, but it is probable that they may be called upon to furnish the additional rivets required in double shear. By extending the $\frac{1}{8}$ -in. filler as shown in Fig. 33, 4 rivets in bearing on the web plate are provided, which in addition to the 8 rivets in the connection angles provide the required 12 rivets in bearing on the web plate.

In designing the connection between the stringer and the floor beam, two conditions must be considered. The connecting rivets must develop in single shear the stringer reaction, and, the connecting rivets in bearing on the floor beam web plate must develop the floor beam reaction for adjacent stringers. As stated above, the end shear is 118,200 lb. Hence the number required in single shear is $\frac{118,200}{7,200} = 16.4$. Since this is a field connection

tion, as shown in Fig. 32, the number of rivets required must be increased by $33\frac{1}{3}$ per cent (Art. [38], [301], Specifications). A total of $(16.4) (\frac{4}{3}) = 22$ must be provided. The floor beam reaction as determined later and shown in Fig. 34 is 155,000 lb. Rivets in bearing on the $\frac{1}{2}$ -in. web plate of the floor beam (see Fig. 32) have a value of 10,500 lb. Allowing for the fact that a field connection is to be made, the number of rivets required is $\frac{(155,000)(\frac{4}{3})}{10,500} = 20$. Hence the first condition mentioned above determines the number of rivets required. Figure 32 shows 22 rivets in place.

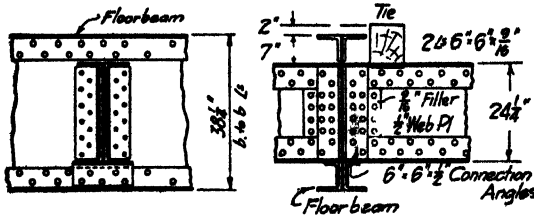

FIG. 33.

The floor beam details are as shown in Fig. 32. In order to provide proper clearance for the rolling stock (Fig. 1, Art. [13], Specifications) the main girders are spaced 17 ft. center to center, as shown in Fig. 32. Figure 34 shows the load applied to one of the intermediate floor beams. These loads are made up as follows: Floor beam live load for 14-ft. panels = 78,200 lb.; impact ($L = 28$ ft.) = 71,300 lb.; and dead load reactions for two stringers which frame into floor beam = $(2)(7)(395) = 5,500$ lb. From Fig. 34, the maximum moment due to the floor beam loads is $(155,000)(5.25)(12) = 9,780,000$ in.-lb. and the end shear is 155,000 lb. Assuming the floor beam to weigh 2,500 lb., the dead load center moment is found to be 63,800 in.-lb. and the end shear is 1,250 lb. The total moments and shears are then 9,824,000 in.-lb. and 156,300 lb. respectively.

As shown in Fig. 32, a $38 \times \frac{1}{2}$ -in. web plate is used with the flange angles placed $38\frac{1}{4}$ in. back to back. Assuming a flange section consisting of two $6 \times 6 \times \frac{3}{4}$ -in. angles, it

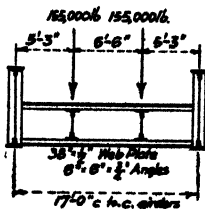

FIG. 34.

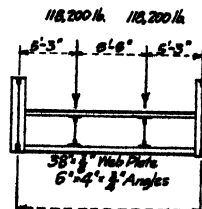

FIG. 35.

was found that the area required is 17.70 sq. in. The assumed angles (one rivet hole from each angle) plus one-eighth the web area provide a net area of 17.76 sq. in. The assumed web plate provides 19 sq. in. of area while 15.83 sq. in. is required. Since the assumed section provides the necessary area it will be adopted.

The floor beam is connected to the web of the main girder by field rivets in single shear, as shown in Fig. 32. Required number of rivets = $\frac{(156,300)}{(7,220)} (\frac{4}{3}) = 29$. The end connection angles for the floor beams consist of $6 \times 6 \times \frac{3}{4}$ -in. angles. To connect these angles to the floor beam, $\frac{156,300}{14,400} = 11$ rivets in double shear and $\frac{156,300}{10,500} = 15$ rivets in bearing on the web plate are required. The rivet spacing in the flange angles of the floor beam may be determined from eq. (5), p. 307. Note that the rivet spacing between the girder and the stringer is constant. Between the stringers, where the shear is small, the maximum allowable spacing has been used.

Figure 32 shows the details of the end floor beam and Fig. 35 shows the loads to be carried. These loads are determined from the live load end shear plus impact and the dead load reaction for one stringer. From the calculations given on p. 327, these loads are 118,200 lb. each. Assuming the end floor beam to weigh 2,000 lb. the total maximum moment is found to be 7,490,000 in.-lb. and the end shear is 119,200 lb. It will be found that the section shown in Fig. 32 provides ample area for moment and shear.

To connect the end floor beam to the main girder, two 4- X 4- X 3/8-in. connection angles are riveted to the outer pair of end stiffener angles. The floor beam is connected to these angles by field rivets in single shear, and $\left(\frac{119,200}{7,220}\right) \left(\frac{4}{3}\right) = 22$ rivets are required. The rivets connecting the end connection angles to the main girder are shop rivets in double shear, and $\frac{119,200}{14,440} = 9$ rivets are required. Figure 32 shows all details of the end floor beams.

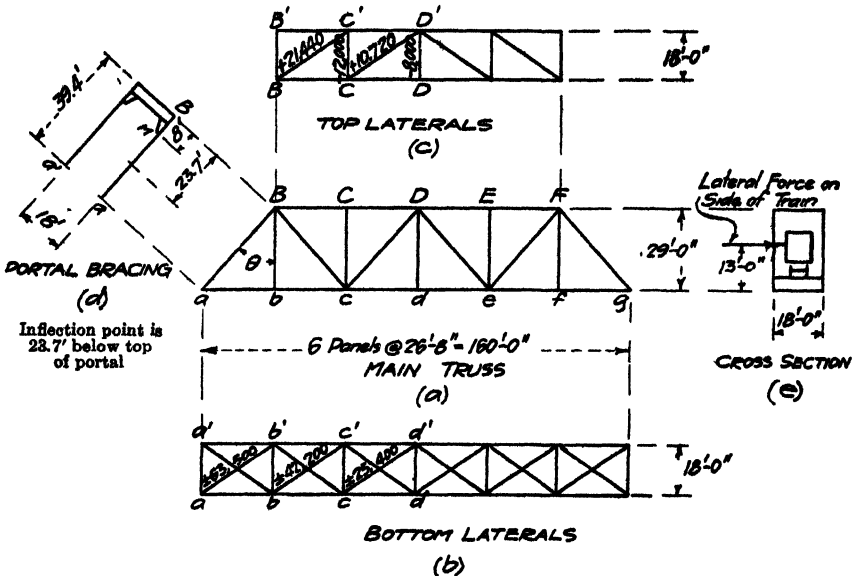

FIG. 36.

To conform to the requirements of Art. [129], [434] of the Specifications, 3/8-in. gusset plates are riveted to the top flanges of intermediate and end floor beams and to the stiffener angles. As shown in Fig. 32, 5- X 3 1/2- X 1/2-in. angles are used to connect the gusset plates to the floor beam, and a pair of angles is riveted to the edge of the plate.

8. Riveted Truss Bridges.

8a. General Considerations.—Design methods for riveted truss railway bridges will be illustrated in the following articles by the complete design of a six-panel through bridge of the general dimensions and form shown in Fig. 36. Cooper's E-60 loading will be assumed and the design will be governed by the A.R.E.A. Specifications. An open floor consisting of wooden ties on stringers and floor beams will be used.

8b. Stresses in Truss Members.—Stresses due to dead load are determined for a dead load as given by eq. (5), p. 290. With $l = 160$ ft., we have $w = \frac{9}{8}[(8)(160) + 700] = 2,230$ lb. per ft. of bridge. Assuming one-third of this load as applied at the top chord joints and two-thirds at the lower chord joints, the panel loads for each truss are as follows: Top chord joints, $(\frac{1}{3})(\frac{1}{2})(2,230)(26\frac{3}{4}) = 10,000$ lb.; lower chord joints $(\frac{2}{3})(\frac{1}{2})(2,230)(26\frac{3}{4}) = 20,000$ lb.

The stringers will be placed $6\frac{1}{2}$ -ft. centers (Art. [98], Specifications). Since the loadings and stringer spacing are the same as used in the plate girder designs, the design of the cross ties is the same as given on p. 295 and the wooden floor and track will weigh 486 lb. per ft. of bridge (p. 299). Hence the panel load per truss due to the weight of floor is $(\frac{1}{2})(486)(26\frac{2}{3}) = 6,500$ lb. This panel load may be assumed as transferred to the lower chord joints. The total panel loads are then 26,500 lb. at each lower chord joint and 10,000 lb. at each upper chord joint. Dead load stresses in the members of truss shown in Fig. 36 are given in Table 6. These stresses are determined by the methods given in the volume on "Stresses in Framed Structures."

Stresses due to E-60 live load and impact are also given in Table 6. Impact values are determined from the formula given in Art. [28], [206] of the Specifications.

TABLE 6.—STRESSES IN MEMBERS

Member	Dead load stress	Live load stress	Impact	Maximum stress
<i>BCD</i>	-134,000	-362,000	-195,000	-691,000
<i>abc</i>	+ 83,900	+235,000	+127,000	+445,900
<i>cd</i>	+151,200	+412,000	+222,500	+785,700
<i>aB</i>	-124,000	-348,000	-188,000	-660,000
<i>Bc</i>	+ 74,500	+232,000	+152,800	+459,300
<i>cD</i>	- 24,800	-136,000 + 63,000	-105,200 + 56,100	-266,000 + 94,300
<i>Bb</i> <i>Dd</i>	+ 26,500	+119,000	+108,800	+254,300
<i>Cc</i>	- 10,000	0	0	- 10,000

+ = tension. - = compression.

Stresses in the lateral bracing, which will be arranged as shown in Fig. 36, are to be determined for the loadings given in Arts. [32 and 33], [209] of the Specifications. From the general drawing of Fig. 44, the exposed area of the top chord members and the upper halves of all web members is found to be about 4 sq. ft. per ft. of truss. Hence the top lateral stresses are to be determined for a load of $(4)(1\frac{1}{2})(50) = 300$ lb. per ft. (Art. [33], Specifications). It will also be found that the exposed area of the lower chord members and the floor system is about 8 sq. ft. per ft. of truss. Hence the bottom lateral stresses are to be determined for a load of $(8)(1\frac{1}{2})(30) + 700 = 1,060$ lb. per ft. In general, these loadings can not be determined until the main trusses have been designed. At this stage in the calculations it will therefore generally be necessary to use an assumed value of the exposed area. The assumed values may be checked later and revisions made if necessary. Methods for the determination of the stresses in the members of the lateral system are given in the volume on "Stresses in Framed Structures."

The top chord lateral truss panel load is $(300)(26\frac{2}{3}) = 8,000$ lb. Since the diagonals of the top lateral system are long members, it will be assumed that they take tension only, for if these long members are to be designed to take compression, very large areas must be provided to make efficient columns. As shown in Fig. 36 (c) two diagonals are provided in

each panel, but only one of these is assumed as in action at any time. The other member acts as a counter, coming into action when the direction of lateral force is reversed. In Fig. 36 (c) the calculated stresses for top lateral members are shown. Stresses in the chord members are found to be within the allowable limits given in Art. [46] of the Specifications.

The lower chord lateral truss panel load is $(1,060)(26\frac{3}{8}) = 28,300$ lb. Since the diagonal members of the lower lateral system may be supported at the stringers, the unsupported length of these members is relatively small and they may be designed as compression members. It will therefore be assumed that both diagonals in any panel are in action at the same time, one in tension and the other in compression. The resulting stresses in the diagonal members are shown in Fig. 36 (b).

Stresses in the chord members of the lower lateral system may become so large that they are subject to the requirements of Art. [46] of the Specifications. Additional area must then be placed in the lower chord main truss members to comply with this provision of the Specifications. As stated in the volume on "Stresses in Framed Structures," the stresses in the lower chord truss members due to lateral loads are as follows: (a) stresses due to lateral truss effect; (b) stresses due to overturning effect; and (c) stresses due to portal effect. These stresses have been calculated and are tabulated in Table 7.

TABLE 7.—STRESSES IN LOWER CHORD MEMBERS DUE TO LATERAL LOADING

Member	ab	bc	cd
Lateral truss effect.....	52,500	136,200	178,200
Overturning effect.....	31,000	31,000	56,000
Portal effect.....	10,700	10,700	10,700
Total lateral stress.....	94,200	177,900	244,900
Stress due to vertical loading.....	445,900	445,900	785,700
Ratio = $\frac{\text{Lateral}}{\text{Vertical}}$	21.2 per cent	40.0 per cent	31.2 per cent

Stresses due to lateral truss effect given in Table 7 are calculated for panel loads of 28,300 lb. acting at the joints of the lateral truss system shown in Fig. 36 (b). It is assumed that both diagonals are in action at the same time. Stresses due to overturning effect are calculated for a horizontal load of 700 lb. per ft. acting on the side of the live load, as shown in Fig. 36 (e) (Art. [33], Specifications). From the general drawing of Fig. 44, the base of rail is about 5 ft. above the plane of the lower chord center line. Hence the position of the horizontal force is 13 ft. above the plane of the lower chord, as shown in Fig. 36 (e). The horizontal panel load is $(700)(26\frac{3}{8}) = 18,700$ lb., and the effect on the main truss is equivalent to panel loads of $(18,700)(1\frac{3}{18}) = 13,500$ lb., acting downward on the leeward truss and upward on the windward truss. Since the conditions are similar to those for dead load, the resulting stresses in the chord members are readily seen to be $(\frac{13.5}{26.5})$ times those given in Table 6, p. 329. The calculated values are given in Table 7.

The stress given in Table 7 for portal effect is due to the reaction at joint B, Fig. 36 (c) from lateral loads on the top lateral system. Since the portal stress is to be combined with other lateral stresses which are caused by a wind pressure of 30 lb. per sq. ft., the reaction at B must also be determined for this loading. As stated above, the exposed top chord area is 4 sq. ft. per ft. of truss. Hence the lateral load per ft. is $(1\frac{1}{2})(4)(30) = 180$ lb.; each panel load is $(180)(26\frac{3}{8}) = 4,800$ lb.; and the reaction at B due to panel loads at all top chord points is $(5\frac{1}{2})(4,800) = 12,000$ lb. From the general drawing of Fig. 44, the dimensions of the portal are as shown in Fig. 36 (d). Assuming the portal as fixed at the base, the direct stress in the posts due to a 12,000 lb. load at B is $(12,000)(\frac{23.7}{18}) = 15,800$

lb. Therefore, the portal stress = $15,800 \sin \theta$ (θ = angle between end post and vertical)
 = $(15,800) \left(\frac{26\frac{3}{4}}{39.4} \right) = 10,700$ lb.

Table 7 gives the total stresses in the several members due to lateral loads. The table also contains the stresses in these members due to loads on the vertical trusses, as given in Table 6. On comparing these values given in Table 7, it will be found that for members *bc* and *cd*, the lateral load stresses exceed 25 per cent of those due to vertical loading. Hence from Art. [46] of the Specifications, these chord members must be designed for the total stress due to dead, live, impact and lateral loadings, using a working stress of 20,000 lb. per sq. in. It will be found that these are the only members of the truss which are affected by the provisions of Art. [46] of the Specifications.

3c. Design of Members.

Form of Members.—Compression members forming the top chord and end posts of riveted truss bridges are generally made of the form shown in Fig. 37. The minimum thickness of metal which may be used in the cover and web plates is subject to the requirements

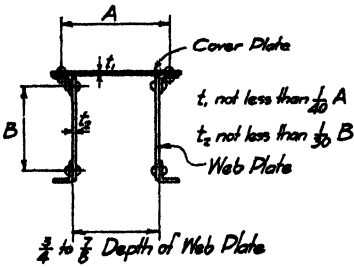

FIG. 37.

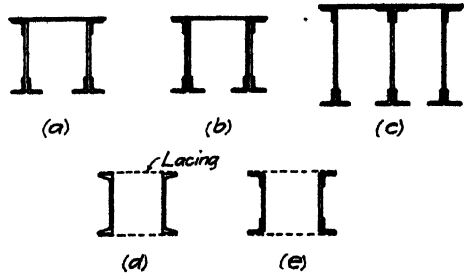

FIG. 38.

of Art. [65], [405] of the Specifications. These requirements have been shown in Fig. 37. In making up a chord section, the depth of web plates may be decided upon first. The depth of these plates may be made about one-fifteenth of the length of the panel for top chord members. It will generally be found that the distance between side plates should be from $\frac{3}{4}$ to $\frac{7}{8}$ of the depth of web plates, as shown in Fig. 37. The adopted distance will depend somewhat upon the space required for proper attachment of web members to the chords. End post members are generally made of the same depth and width as the top chord members.

In general the cover plates should be made as thin as possible and material should preferably be concentrated in the webs and angles. No statement is made regarding the thickness of angles. Since these angles connect the cover plate to the webs, they should not be thinner than the cover plate.

When the area to be provided by a chord section of the form shown in Fig. 37 requires plates thicker than about $\frac{3}{4}$ in., additional material may be provided by double angles placed on the web, as shown in Fig. 38 (a), or by double web plates, as shown in Fig. 38 (b). For very large chord sections, multiple web plates may be used, as shown in Fig. 38 (c). In all of these sections the several segments of the member should be connected by lacing placed across the open side of the section.

Compression diagonals may be made from rolled channels, as shown in Fig. 38 (d), for sections where the area required is small. For larger areas, built-up sections may be used of the form shown in Fig. 38 (e). In some cases the channels or angles are placed with the points inward instead of as shown.

Bottom chord tension members for riveted trusses may be made from rolled or built channels, as shown in Fig. 39 (a) and (b). A section composed of four angles and a plate, as shown in Fig. 39 (c) may also be used. Additional area may be provided by means of plates placed on these angles as shown in Fig. 39 (d). The forms shown in Fig. 39 may also be used for diagonal web members subjected to tension.

Design of Compression Members.—Working stresses for compression members are determined by the column formula (Art. [38], [301], Specifications) $15,000 - 50\frac{l}{r}$ where l = length of member and r = its least radius of gyration. However, the working stress must not exceed 12,500 lb. per sq. in., and $\frac{l}{r}$ for main truss members must not be greater than 100 (Art. [49], Specifications). Table 8 gives complete data for the design of compression members. The maximum stresses were taken from Table 6.

TABLE 8.—DESIGN OF COMPRESSION MEMBERS

Member	Maximum stress	Length l (in.)	Radius of gyration r (in.)	$\frac{l}{r}$	Unit stress (lb.-in. ²)	Area required (sq. in.)	Section	Area provided (sq. in.)
aB	660,000	473	7.70	61.5	11,930	55.20	1 Cov. Pl. 24 × $\frac{3}{16}$ in. 4 L $3\frac{1}{2}$ × $3\frac{1}{2}$ × $\frac{3}{16}$ in. 2 Web Pls. 20 × $\frac{1}{16}$ in.	55.48
BCD	691,000	320	7.70	41.6	12,500	55.30	1 Cov. Pl. 24 × $\frac{3}{16}$ in. 4 L $3\frac{1}{2}$ × $3\frac{1}{2}$ × $\frac{3}{16}$ in. 2 Web Pls. 20 × $\frac{1}{16}$ in.	55.48
Dc	-266,000 + 94,300 (313,300)	473	5.23	90.3	10,480	29.90	2 B 15 in. at 50 lb.	29.28

As an example of compression member design, the calculations for member BCD will be given in detail. From Table 8 the stress in the member is 691,000 lb. and the lengths of BC and CD are each 320 in. In making up a trial section, the working stress will be taken

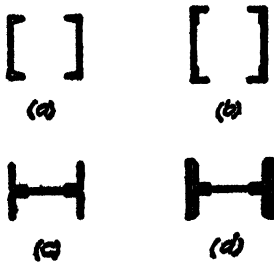

FIG. 39.

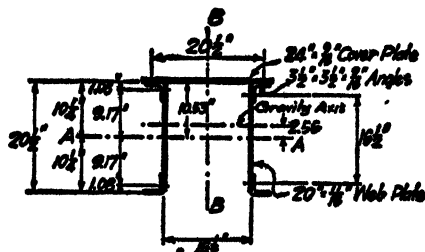

FIG. 40.

as the maximum allowable, which is 12,500 lb. per sq. in. Hence the area required is approximately $\frac{691,000}{12,500} = 55.30$ sq. in. If the depth of the member be taken as $\frac{1}{16}$ of the panel length, the web plates will be $3\frac{1}{16}$, or about 20 in. deep. The distance between side plates will be made about 0.8 their depth or about 16 in. Figure 40 shows the arrangement adopted. The thickness of the cover plate corresponds to the requirements shown in Fig. 37. Table 9 gives the area of the section as assumed.

TABLE 9.—PROPERTIES OF TOP CHORD SECTION

Part	Area	x	Ax	Ax^2	I_c	I'
Cover plate.....	13.50	10.53	+142.1	1,500	0	1,500
Top angles.....	7.24	9.17	+ 66.3	607	8	615
Web plate.....	27.50	0.0	917	917
Bottom angles.....	7.24	9.17	- 66.3	607	8	615
Totals.....	55.48	+142.1	3,647

The true working stress for the assumed member depends upon its radius of gyration, which may be determined from the formula $r = \sqrt{\frac{I}{A}}$ where I = moment of inertia of the section about its gravity axis and A = area of section. In determining the moment of inertia of the section, consider first an axis $A-A$, Fig. 40, passing through the center of the web plates. Table 9 gives the necessary information for the determination of moment of inertia. The term Ax in Table 9 is the statical moment of any area about axis $A-A$. Hence the gravity axis is located at a distance $\frac{\sum Ax}{\sum A} = \frac{142.1}{55.48} = 2.56$ in. above axis $A-A$. Values of I given in Table 9 represent the moment of inertia of the several areas about axis $A-A$. The moment of inertia about the gravity axis may be found from the formula $I = I_A - Ax^2$ where I_A = moment of inertia about axis $A-A$; A = area of section, and \bar{x} = distance from axis $A-A$ to gravity axis. Hence $I = 3,647 - (55.48)(2.56)^2 = 3,287$ in.⁴ Therefore

$$r = \sqrt{\frac{I}{A}} = \sqrt{\frac{3,287}{55.48}} = 7.70 \text{ in.}$$

From the column formula of Art. [38], [301] of the Specifications, working stress = 15,000 - (50) $\left(\frac{320}{7.70}\right)$ = 12,920 lb. per sq. in. But this is greater than the maximum allowable of 12,500 lb. per sq. in. Since this latter value was used in the preliminary calculations given above, the trial section is satisfactory. Before adopting this section, it is best to calculate the moment of inertia for axis $B-B$, Fig. 40, in order to make certain that the radius of gyration for axis $B-B$ is not smaller than the r used in the above calculations. By the same methods as used above, we find $I_B = 3,624$ in.⁴ It is therefore evident that the least radius of gyration has been used in the above calculations. Table 8 shows that the same section may also be used for the end post aB .

As shown in Table 8, the stress in diagonal Dc changes from compression to tension during the passage of the live load. The design of this member is therefore subject to the conditions stated in Art. [44] of the Specifications. Hence the member is to be designed for a compression of $266,000 + \frac{1}{2}(94,300) = 313,200$ lb., and a tension of $94,300 + \frac{1}{2}(94,300) = 141,500$ lb. It will be found that the required area is determined by the compression. The adopted section given in Table 8 provides an area which is but slightly less than the area required.

Member Cc is a compression member supporting the top chord. The stress in this member is small and the dimensions of the member will in general be made such as to provide an efficient connection between the member and the floor beam and sway bracing. Figure 44 shows the adopted section.

As shown in Fig. 44, the top chord members are placed with the center of the webplates $2\frac{3}{8}$ in. below the center lines of truss outline. In this way the stress in the chord member acts at the center of gravity of the section, which is shown in Fig. 40 at a distance 2.56 in. (practically $2\frac{3}{8}$ in.) above the center line of web plate. Uniform distribution of stress over the cross-section is thus assured.

Design of Tension Members.—Table 10 gives complete data for the design of tension members. In designing the lower chord members, an attempt was made to use web plates of the same depth as the top chord web plates. However, it was found that the use of 21-in. web plates more nearly fulfilled the area requirements. In determining net areas for bottom chord members, four rivet holes were deducted from each web plate and one from each angle. Figure 44 shows the position of these rivet holes. For the verticals *Bb* and *Dd* and the diagonal *Bc* it was assumed that the rivets in the outstanding legs of the angles staggered with those in the legs fastened to the plates, the distance between these rivets being assumed as 2 in. Then from the formula of Art. [77], {409} of the Specifications, the portion of the area of the holes in the outstanding legs which must be counted in obtaining net area of the angles is $A\left(1 - \frac{P}{4}\right) = A\left(1 - \frac{1}{2}\right) = \frac{A}{2}$. Therefore $1\frac{1}{2}$ rivet holes are to be taken from each angle and two from the plate.

TABLE 10.—DESIGN OF TENSION MEMBERS

Mem-ber	Maximum stress		Area required		Section	Area provided	
	Case A vertical loading, Table 6	Case B vertical and lateral loading, Tables 6 and 7	Case A at 16,000 lb. per sq. in.	Case B at 20,000 lb. per sq. in.		Gross	Net
<i>abc</i>	445,900	623,800	27.75	31.19	2 WebPls. 21 × $\frac{9}{16}$	23.63	19.13
					4 ∟ 3½ × 3½ × $\frac{9}{16}$	14.48	12.24
						38.11	31.37
<i>cd</i>	785,700	1,030,600	49.10	51.53	4 WebPls. 21 × $\frac{9}{16}$	47.26	38.26
					4 ∟ 3½ × 3½ × $\frac{5}{8}$	15.92	13.40
						63.18	51.66
<i>Bc</i>	459,300	28.70	...	1 Plate 13 × $\frac{9}{16}$	7.31	6.19
					4 ∟ 6 × 4 × $1\frac{1}{16}$	25.60	22.84
						32.91	29.03
<i>Bb</i> <i>Dd</i>	254,300	15.91	1 Plate 13 × $\frac{3}{16}$	5.69	4.81
					4 ∟ 6 × 4 × $\frac{3}{8}$	14.44	11.40
						20.13	16.21

8d. Design of Floor System.—The design methods for the floor system of a through truss span are exactly the same as explained in Art. 7b, p. 323, for the through plate girder span. In the present article the discussion will be condensed as much as possible. For further information regarding methods of design the reader is referred to the above mentioned article.

The stringer section will be made $50\frac{1}{4}$ in. back to back of angles, which is slightly less than $\frac{1}{2}$ the panel length. For E-60 loading the stringer end shear for a $26\frac{3}{8}$ -ft. beam is 88,300 lb., and the impact shear ($L = 26\frac{3}{8}$ ft.) is 86,200 lb. Since the loading is the same as for the girder bridges designed in the preceding pages, the same ties and rails may be used. From p. 299, the wooden floor weighs 243 lb. per ft. per stringer, and from eq. (3), p. 290, the stringers weigh ($\frac{1}{2}$) (1.1) [(12.5) ($26\frac{3}{8}$) + 100] = 238 lb. per ft. per stringer. The total dead load is then 481 lb. per ft. and the stringer dead load end shear is ($\frac{1}{2}$)(481) ($26\frac{3}{8}$) = 6,400 lb. Hence the total end shear per stringer is 180,900 lb. and the web area required for shear is $\frac{180,900}{10,000} = 18.09$ sq. in. A $50 \times \frac{1}{16}$ -in. web furnishes 21.88 sq. in.

The maximum stringer moment due to E-60 loading is 505,200 ft.-lb. and the impact moment is 494,000 ft.-lb. Since the dead load per stringer is 481 lb. per ft., the dead load moment is 42,600 ft.-lb. Hence the total stringer moment is 1,041,800 ft.-lb., or 12,500,000 in.-lb.

A stringer flange section composed of two $6 \times 6 \times \frac{1}{16}$ -in. angles placed $50\frac{1}{4}$ in. back to back will be assumed, as shown in Fig. 44. The effective depth of the stringer section is $50.25 - (2)(1.75) = 46.75$ in., and the flange area required is $\frac{(12,500,000)}{(46.75)(16,000)} = 16.72$ sq. in. From the rolling mill handbooks, the net area of the assumed angles is (2) ($7.78 - 0.89$) = 14.18 sq. in. Assuming $\frac{1}{2}$ the web area as flange area, the total available flange area is $14.18 + (\frac{1}{2})(\frac{1}{16})(50) = 16.92$ sq. in. The assumed stringer section will be adopted.

The rivet spacing in the flange angles is determined by the same methods as used on p. 326 for the through girder span. It will be found that the required spacing is as follows: End, 2.67 in.; quarter point, 3.48 in.; center 5.70 in. Figure 44 shows the adopted rivet spacing.

Since the distance between flange angles exceeds fifty times the web thickness, web stiffeners are required. The required stiffener spacing as determined from the formula of Art. [125], {433} of the Specifications is as follows: At the end of the stringer 41.0 in.; at the quarter point, 75.1 in.; at the span center, 106 in. Figure 44 shows the adopted arrangement of stiffeners.

The stringers must be provided with lateral bracing capable of resisting a horizontal lateral force of 700 lb. per ft. plus a load of 30 lb. per sq. ft. on $1\frac{1}{2}$ times the exposed stringer area. As shown in Fig. 44, the stringer is partially sheltered by the lower chord. The exposed area of stringer and floor is about 4 sq. ft. per ft. Hence the total lateral stringer load is $700 + (1\frac{1}{2})(4)(30) = 880$ lb. per ft. Figure 44 shows the arrangement of lateral bracing adopted. It will be found that $3\frac{1}{2} \times 3 \times \frac{3}{8}$ -in. angles may be used for all members. Article [102] of the Specifications requires the use of a cross frame. As shown in Fig. 44, a cross frame composed of angles of the minimum allowable size has been placed at the center of the stringer.

To connect the stringers to the floor beam, $5 \times 3\frac{1}{2} \times \frac{1}{2}$ -in. angles will be used placed as shown in Fig. 44. As given above the stringer end shear is 180,900 lb. Hence $\frac{180,900}{14,400} = 13$ rivets are required in the angles and $\frac{180,900}{9,190} = 20$ rivets are required in bearing on the stringer web plate. Figure 44 shows the arrangement adopted. The number of rivets required to connect the stringer to the floor beam will in this case be determined by the floor beam reaction, the rivets being field rivets in bearing on the floor beam web plate. As shown in Fig. 41, the floor beam reaction is 240,200. Hence the number required is $(\frac{240,200}{9,190})(\frac{4}{3}) = 35$, which are shown in position on Fig. 44.

The effective span of the floor beams is to be taken as the distance center to center of trusses (Art. [11], Specifications). From Fig. 1, Art. [13], Specifications, the horizontal clear distance required is 16 ft. Since the end posts are 24 in. wide (Table 8), the distance center to center of trusses must be 18 ft., as shown in Fig. 44.

The load carried by an intermediate floor beam is the floor beam reaction due to equal stringer panels of $26\frac{3}{8}$ ft. plus the dead load reactions for the two stringers framing into the floor beam. It will be found that the floor beam reaction for $26\frac{3}{8}$ -ft. panels due to E-60 loading is 118,900 lb. The impact allowance ($L = 53\frac{1}{2}$ ft., two panel lengths) is 106,500

lb., and the stringer dead load reaction is $(26\frac{3}{8})(481) = 12,800$ lb. Hence the total floor beam reaction is 240,200 lb., which is shown in position in Fig. 41.

For the conditions shown in Fig. 41, the maximum floor beam moment is $(240,200)(5.75)(12) = 16,580,000$ in.-lb. Assuming the weight of the floor beam to be 3,600 lb., the dead load moment is $\frac{1}{8}(3,600)(18)(12) = 97,000$ in.-lb. and the dead load end shear is 1,800 lb. Hence the total floor beam moment is 16,680,000 in.-lb., and the floor beam end shear is 242,000 lb.

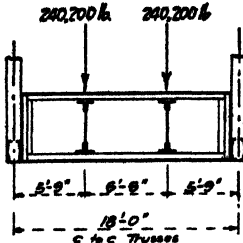

Fig. 41.

The depth of the floor beam section will be made 14 in. greater than the stringer depth in order to allow the stringer to be connected to the floor beam web without interference with the floor beam flange angles, as shown in Fig. 44. A section 64 $\frac{1}{4}$ in. deep is therefore required.

Since the floor beam end shear is 242,000 lb., the web area provided must be $\frac{242,000}{10,000} = 24.20$ sq. in. A 64- \times $\frac{3}{16}$ -in. web plate provides 28.0 sq. in.

A floor beam flange section composed of two 6- \times 6- \times $\frac{1}{16}$ -in. angles placed 64 $\frac{1}{4}$ in. back to back will be assumed. The effective depth of the beam section is $64.25 - (2)(1.75) = 60.75$ in. Flange area required = $\frac{16,680,000}{(60.75)(16,000)} = 17.15$ sq. in. Including $\frac{1}{8}$ of the web as flange area, the total available flange area is $(2)(7.78 - 0.69) + (\frac{1}{8})(64)(\frac{3}{16}) = 17.68$ sq. in. The assumed section is satisfactory and it will be adopted.

Figure 44 shows the connection between the intermediate floor beam and the vertical posts of the truss. To connect the 6- \times 4- \times $\frac{1}{2}$ -in. connection angles to the floor beam, $\frac{242,000}{14,400} = 17$ shop rivets in double shear and $\frac{242,000}{9,190} = 27$ shop rivets in bearing on the floor beam web plate are required. Figure 44 shows 17 rivets through the angles and a total of 27 rivets passing through the filler plate. To connect the floor beam to the truss, $(\frac{242,000}{7,220})(\frac{4}{3}) = 45$ field rivets in single shear are required.

The rivets connecting the floor beam flange angles to the web plate may be determined from the rivet spacing formulas of Art. 6d, or sufficient rivets may be placed between the stringer and the truss to develop the total flange stress. From eq. (5) p. 307, the required rivet pitch is found to be 2.88 in. This same spacing may be used from the truss to the stringer since the shear is practically constant for this portion of the floor beam. Between stringers the shear is practically zero and the rivet spacing may be made the maximum allowable. At the stringer the flange stress in the angles in the tension side of the beam is $\frac{(16,680,000)(14.18)}{(60.75)(17.68)} = 220,000$ lb. Hence $\frac{220,000}{9,190} = 24$ rivets are required between the truss and the stringer. Figure 44 shows the adopted intermediate floor beam details.

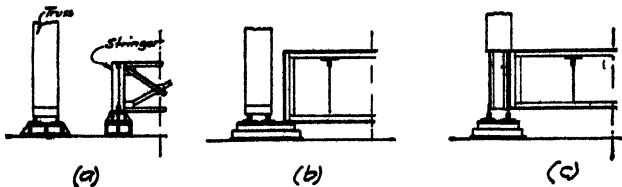

Fig. 42.

Figure 42 shows three methods used for supporting the stringers at the end of the span. In Fig. 42 (a) the stringers rest on independent shoes. In Fig. 42 (b) an end floor beam is provided which is supported on an extension of the rollers or bed plate. The detail shown in Fig. 42 (c) is similar to that used for the intermediate floor beam. In the design under consideration a floor beam of the type shown in Fig. 42 (c) will be used in order to make it possible to lift the span at the ends (Art. [143], [444], Specifications). The connection between truss and floor beam in Fig. 42 (b) can not in general be made rigid enough to per-

mit the span to be readily lifted. In lifting the ends of a span to repair the bridge seat or adjust the rollers, jacks are placed under the floor beam and the end of the span raised the necessary amount. This can not readily be done for the detail shown in Fig. 42 (a).

As shown in Fig. 44 (c), a bracket has been placed on the outside of the end floor beam in order to provide support for a tie. In calculating the loads to be carried by the end floor beam, it may be assumed that wheel 2 is placed 1 ft. beyond the center of the end floor beam, as shown in Fig. 43 (a). The floor beam load due to E-60 loading is then 93,500 lb.; the impact allowance, ($L = 26\frac{3}{8}$ ft.) is 91,200 lb.; and the dead load from the stringer is $(\frac{1}{2})(26\frac{3}{8})(481) = 6,400$ lb. Hence the total floor beam load is 191,100 lb., applied as shown in Fig. 43 (b).

Design methods for the determination of the end floor beam section are the same as used above for the intermediate beams. Assuming the end floor beam to weigh 3,000 lb., it will be found that a 64 × $\frac{1}{2}$ 8-in. web plate and flanges composed of two 6 × 4 × $\frac{1}{2}$ 8-in. angles, arranged as shown in Fig. 44 (g) will answer.

The end floor beam is connected to the gusset plate at the lower end of the end post, as shown in Figs. 44 (a) and (g). To connect the floor beam to the gusset plate,

$(\frac{192,600}{7,220})(\frac{4}{3}) = 36$ field rivets in single shear are required. As shown in Fig. 44 (g), the lower corner of the web plate and the ends of the lower flange angles have been cut away to avoid interference with the end post and the shoe. To strengthen this portion of the floor beam, the filler plates under the end connection angles will be extended in order to provide additional web area.

By placing cover plates over the ends of the lower flange angles, the rivets passing through these plates are in bearing on the total thickness of flange angles. The rivets provided between the end of the floor beam and the stringer will develop the flange stress at the stringer. Figure 44 (g) shows complete details of the end floor beam.

8e. Design of Riveted joints.—The members of a riveted truss are connected at the joints by gusset plates, as shown in Fig. 44 (a). These plates serve to hold the members in position and to equalize the stresses at the joints. In designing these joints, rivets must be provided sufficient in number to transfer the stresses from the members to the gusset plates. Also, in very large trusses it is sometimes necessary to investigate the internal stress conditions in the gusset plates in order to make certain that the combined fiber stresses on the plates are within allowable limits. For trusses of the size under consideration, the size of gusset plates will generally be determined by the space required by the connecting rivets. The gusset plate thickness should be sufficient to give equal rivet values in shear and in bearing. As shown on Fig. 44, $\frac{5}{8}$ -in. gusset plates are used at all main truss joints.

The number of rivets required to connect any member to the gusset plates is equal to the stress in the member divided by the single shear value of a rivet. Shop rivets $\frac{3}{4}$ in. in diameter have a single shear value of 7,220 lb. per rivet (Art. [38], [301], Specifications) and field rivets in single shear have a value of $(7,220)(\frac{3}{4}) = 5,420$ lb. Figure 44 (a) shows the conditions of the rivets at the several joints and the number provided. For member Dc, which is subjected to a reversal of stress, the number of rivets required is to be determined for the sum of the stresses in compression and tension (Art. [44], Specifications). Hence the connections are to be designed for a total stress of 360,360 lb.

8f. Design of Lateral, Portal and Sway Bracing.—The entire lateral bracing system of a truss bridge serves to bind all parts of the structure together, in order to form a rigid structure, as well as providing adequately for the stresses determined in Art. 8b. In general, members of the lateral bracing systems are proportioned with the consideration of rigidity in mind, making certain that adequate provision is made for existing stresses. Articles [108 to 116], [435 to 437] of the Specifications govern the design of lateral bracing.

The calculated stresses for the top lateral bracing are shown on Fig. 36 (c). To assure adequate rigidity, Art. [34] of the Specifications states that the bracing provided in the plane of the compression chord must be capable of resisting a transverse shear equal to $2\frac{1}{2}$ per cent

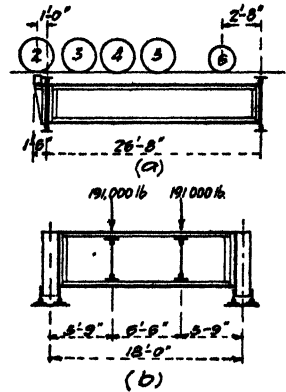

FIG. 43.

of the stress in the chord members of that panel. From Table 6 this transverse shear for the truss under consideration is $(0.025)(691,000) = 17,300$ lb. Hence the stress in a diagonal member is then $(17,300)(1.79) = 31,000$ lb. Since this stress exceeds those given in Fig. 36 (c), the design must be made for the greater stress. As shown in Fig. 44 (c), the diagonals are composed of four $3\frac{1}{2} \times 3\frac{1}{2} \times \frac{3}{8}$ -in. angles. The area furnished by these angles is in excess of that required for the calculated stress. However, the adopted section conforms to the usual practice.

Stresses in the lower chord lateral truss members are shown in Fig. 36 (b). Since the laterals are fastened to the stringers, as shown in Fig. 44 (b), the unsupported length of

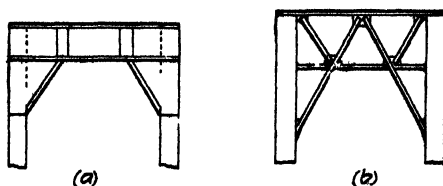

FIG. 45.

lateral diagonal may be taken as the distance from the inner edge of the lower chord member to the center of the stringer, which is about 9 ft. It will be found that two $5 \times 3\frac{1}{2} \times \frac{3}{8}$ -in. angles arranged as shown in Fig. 44 (b) will provide the necessary area in all panels.

Portal and sway bracing for spans up to about 300 ft. in length is generally made of the form shown in Figs. 45 and 46. The forms shown in Figs. 45 (a) and 46 (a) are used when the head room over the clearance diagram (see Fig. 47) is relatively small. Figures 45 (b) and 46 (b) and (c) show forms used when greater head room is available.

The available head room in any case may be determined by a layout of the cross-section of the span. Figure 1 of Art. [13] of the Specifications shows the clearance which must be provided for the passage of the live load. For the truss under consideration, Fig. 47 shows

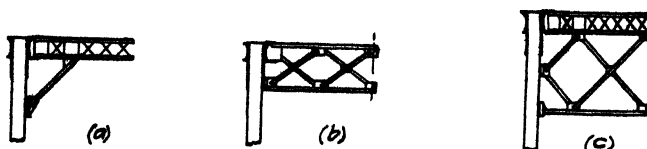

FIG. 46.

a cross-section of the span with the clearance diagram in position. Since the available head room is limited, sway bracing of the type indicated in Fig. 47 will be used. In general no attempt is made to determine the stresses in sway bracing, which is inserted to add rigidity to the structure. Angles of minimum size are generally used. For the truss under consideration the arrangement adopted for the sway bracing is shown in Fig. 44 (f).

Figure 48 shows the form and dimensions of the adopted portal. For purposes of stress calculation it may be assumed that the dimensions of the portal are as shown in Fig. 48 (b). The load at point A is due to a wind pressure of 50 lb. per sq. ft. From p. 329 each top lateral panel load is 8,000 lb. Assuming full loads at each top chord panel, including the end joints, the load at A, Fig. 48 (b) is $(8,000)(\frac{5}{2}) = 20,000$ lb. Since the truss is thoroughly riveted, the posts may be assumed as fixed at the base and the point of inflection may be taken half way between the lower end of the bracket (shown at B, Fig. 48 (b)) and the foot of the post.

In calculating stresses in the plate girder portal shown in Fig. 48 (b) it may be assumed that the bracket does not assist in carrying the stresses. It can readily be shown that the maximum stress occurs at point A. Cutting a section close to the right-hand post and taking moments about D for forces above the point of inflection, it will be found that the stress at A is

$$\frac{(10,000)(20.7) + (20,000)(3)}{3} = 89,000 \text{ lb.}$$

A flange composed of 6- × 4- × 3/8-in. angles arranged as shown in Fig. 48 (a) provides some excess area, which is desirable, as a rigid portal frame helps stiffen the entire top lateral system. The shear in the web plate is equal to the direct stress in the posts due to the load shown at A. This shear is found to be $\frac{(20,000)(23.7)}{18} = 26,400$ lb. The web plate shown in Fig. 48 (a) furnishes excess area. Figure 44 shows the complete portal details.

8g. Design of End Shoe, Chord Splices, and Minor Details.—The area of the base of the end shoe must be sufficient to transfer the maximum end reaction to the piers or abutments without exceeding the allowable bearing pressures on the material composing the substructure. For the truss under consideration, the maximum end reaction due to E-60 live load will occur when wheel 2 of the locomotive is located as shown in Fig. 43 (a). This live load reaction is found to be 332,000 lb. The impact allowance ($L = 160$ ft.) is 179,000 lb. In calculating the dead load reaction it will be assumed that the dead panel load at the end of the truss is one-half the load at the lower chord joints. Hence the dead load reaction is $(36,500)(\frac{1}{2}) + (\frac{1}{2})(26,500) = 105,500$ lb. The total end reaction is then 616,500 lb.

Assuming the substructure to be composed of concrete masonry, the allowable bearing pressure is 600 lb. per sq. in. (Art. [38], Specifications). Hence the bearing area required is $\frac{616,500}{600} = 1,030$ sq. in. As shown in Fig. 44 (a), the end shoe rests on a 38- × 46-in. base plate.

To provide for expansion due to temperature and stress changes, rollers will be placed under one end of the span. These rollers must permit a horizontal movement of $16 \frac{9}{100} = 1.6$ in., or $1 \frac{3}{8}$ in. (Art. [88], Specifications). Assuming 6-in. rollers (Art. [91], Specifica-

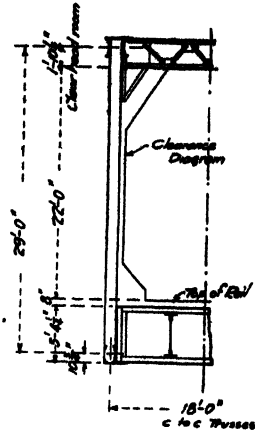

FIG. 47.

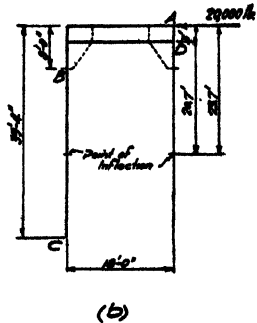
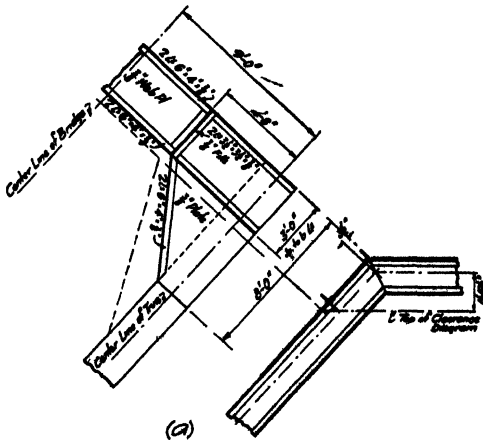

FIG. 48.

tions) the allowable bearing on these rollers is $(600)(6) = 3,600$ lb. per in. (Art. [38], [301], Specifications). For the end reaction calculated above, the length of rollers required is $\frac{616,500}{3,600} = 171$ in. The roller nest shown in Fig. 44 (a) contains seven rollers. Each roller has an effective bearing length of 28 in., giving a total bearing of 196 lin. in.

Segmental rollers of the type shown in Fig. 44 must be made of sufficient width to prevent overturning and the distance between faces of adjacent rollers must be sufficient to

prevent binding of the rollers. In Fig. 49 let B = horizontal movement of roller, and let θ = angle through which the vertical axis of a roller of diameter D turns during a forward motion of B . Then $\theta = \frac{2B}{D}$ radians. From Fig. 49 it can be seen that 2θ must not exceed the angle 123. If d = width of roller between flat surfaces, the limiting width of roller is found to be

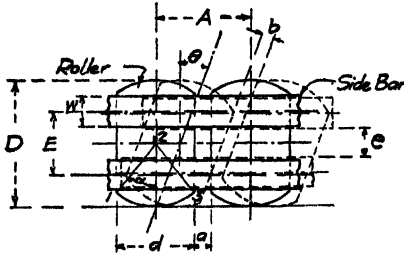

FIG. 49.

$$d = D \sin \left(114.6 \frac{B}{D} \right)$$

If b represents the minimum clear distance which must be maintained between faces of rollers in the inclined position and A = distance between centers of rollers, it can be shown for the conditions given in Fig. 49 that

$$A = (d + b) \sec \left(114.6 \frac{B}{D} \right)$$

The rollers are connected by a pair of horizontal plates of width W , as shown in Fig. 49. If it be required that these plates maintain a clear distance e between them in the revolved position of the rollers, it can be shown that the width of plates must not exceed

$$W = (E \cos \theta - e)$$

For the truss under consideration it has been found that provision must be made for a horizontal movement of $1\frac{5}{8}$ in. Assuming that one-half of this movement takes place on either side of the vertical position of the rollers, and noting that the center of the roller moves but one-half as far as the end of the span, we have

$$B = \frac{1.625}{4} = 0.41 \text{ in.}$$

If the distance between vertical faces of the roller is 4 in., we have $2\theta = 2(114.6) \frac{B}{D}$ deg. = 15 deg. 40 min. From Fig. 49, $\angle 123 = 42$ deg. Hence the roller will not overturn.

Assuming that the rollers are not to approach within $\frac{1}{4}$ in. of each other in the revolved position the limiting distance between rollers is

$$A = (4 + 0.25) \sec 7^\circ 50' = 4.3 \text{ in.}$$

The rollers will be placed $4\frac{1}{2}$ in. center to center as shown in Fig. 44. If the side plates are placed 3 in. apart and if they are not to approach closer than $\frac{1}{2}$ in. to each other, we have $W = (3 \cos 7^\circ 50' - 0.5) = 2.47$ in. These plates will be made $2\frac{3}{8}$ in. wide.

As shown in Fig. 44, a pin connection is provided between the shoe and the truss, in order to comply with Art. [92] of the Specifications. A 7-in. pin has been used. To reinforce the gusset plate for bearing on the pin, additional bearing area has been provided by means of pin plates arranged as shown in Fig. 44. The design of the pin and the attachment of these pin plates is carried out by the methods given in the discussion on Pin-connected Trusses. As shown in Fig. 44, the portion of the shoe above the rollers is composed of plates and angles. The thickness of web plates is determined by the bearing area on the pin required to develop the end reaction. For a 7-in. pin, the bearing area required at 24,000

lb. per sq. in. is $\frac{616,500}{(2)(24,000)} = 12.85$ sq. in. for each web plate, which requires web plates

$\frac{12.85}{7} = 1.83$ in. thick. Three $\frac{5}{8}$ -in. web plates on each side are provided, as shown in

Fig. 44. These web plates are attached to the $1\frac{1}{4}$ -in. base plate by means of $6 \times 6 \times \frac{3}{4}$ -in. angles. Figure 44 shows complete details of the end shoe.

Splices for top and bottom chord members of riveted trusses are generally located just outside a gusset plate. If the stresses in the members entering the joint are not equal, the splice should be placed on the member having the smaller stress. Figure 44 (a) shows the location of splices for the truss under consideration.

As shown in Fig. 44, the lower chord member is spliced near the right end of the second panel. From Table 10, p. 334, the net area provided for member bc is 31.37 sq. in. Assum-

ing that the splice must be capable of developing the full net strength of the member, the splice must be designed for a total load of $(16,000)(31.37) = 502,000$ lb.

The splice on member *abc* will be formed by plates placed on each side of the web plates and by horizontal plates on the outstanding legs of the angles. As shown in Fig. 44, 21- \times - $\frac{1}{2}$ -in. plates are placed on the outside of the web and 14 \times $\frac{1}{2}$ -in. plates are placed inside the web. A $\frac{3}{8}$ -in. filler plate is used inside the member in order to provide for the difference in web plate thickness. On the horizontal legs of the angles 12- \times - $\frac{3}{8}$ -in. plates are provided top and bottom. The net area of this splice material (filler not included) is found to be 31.50 sq. in.

The number of rivets connecting the several splice plates to the member must be determined with respect to the distribution of the load to the angles and web plates. Assuming the load to be divided in proportion to the net areas of the several parts, the total stress in the web plates is

$$(502,000) \left(\frac{19.13}{31.37} \right) = 306,000 \text{ lb.}$$

and the stress in the angles is

$$(502,000) \left(\frac{12.24}{31.37} \right) = 196,000 \text{ lb.}$$

As shown in Fig. 44, the rivets passing through the angles are in single shear. Hence the number required is

$$\left(\frac{196,000}{7,220} \right) \left(\frac{4}{3} \right) = 36 \text{ field rivets.}$$

Figure 44 shows 9 rivets in each angle, 5 in the vertical leg and 4 in the horizontal leg. From Fig. 44 it can be seen that the rivets which pass through the web plate and both splice plates are in double shear. Hence the arrangement shown provides 14 rivets in double shear and 3 in single shear, not counting the rivets in the angles. The total value of the rivets provided, based on their value as field rivets is $(2)[(14)(14,440) + (3)(7,220)] \left(\frac{3}{4} \right) = 334,000$ lb. Figure 44 (a) shows the details of the splice

A splice is also provided for the top chord member. From Art. [74] of the Specifications, the splice plates must furnish an area of not less than 50 per cent of the area of the smaller of the spliced sections. The detail shown in Fig. 44 will develop the full strength of the splice material.

The design of the lacing for compression members is governed by Arts. [69 to 73], [420] of the Specifications. To illustrate the methods of lacing design the calculations for design of lacing for the top chord will be given. From Table 6, p. 329, the stress in *BCD* is 691,000 lb. Hence the stress in a lacing bar is

$$\frac{(0.025)(691,000)}{4} (1.41) = 6,100 \text{ lb.}$$

From Fig. 40, the length of a lacing bar is found to be $(20.5)(1.41) = 28.9$ in. Assuming a $2\frac{3}{4}$ - \times - $\frac{1}{2}$ -in. lacing bar, $r = 0.289d = (0.289)(0.5) = 0.144$ and the allowable stress is

$$15,000 - \frac{(50)(28.9)}{0.144} = 5,000 \text{ lb. per sq. in.}$$

Hence the area required is

$$\frac{6,100}{5,000} = 1.22 \text{ sq. in.}$$

The assumed bar provides 1.38 sq. in. which is sufficient. From the rolling mill handbooks the radius of gyration of the $3\frac{1}{2}$ - \times - $3\frac{1}{2}$ - \times - $\frac{3}{8}$ -in. angle composing the lower flange angle of the top chord compression member is 1.05 in. Since the distance between rivets in lacing bars is 20.5 in.,

$$\frac{l}{r} = \frac{20.5}{1.05} = 19.5.$$

From Table 8, the $\frac{l}{r}$ for member *BCD* is 41.6 and two-thirds of this value is 27.7. Hence the assumed lacing satisfies the requirements of Art. [71] of the Specifications. The lacing for other members is designed by similar methods. Figure 44 shows the adopted lacing details.

Article [67] of the Specifications governs the design of stay plates. Since the rivet lines in the lower angles are 20 $\frac{1}{2}$ in. apart, the stay plates must be at least $(20.5) \left(1\frac{1}{4} \right) = 25.6$

in. long, and they must be at least $\frac{20.5}{50} = 0.41$, or $\frac{1}{4}$ in. thick. Figure 44 shows the adopted sizes of stay plates.

9. Pin-connected Truss Bridges.

9a. General Considerations.—General methods for the design of truss members, lateral systems, and the floor system of pin-connected trusses are the same as given in the preceding pages for riveted truss spans. The design methods for joint details in pin-connected trusses are much more complicated than for riveted trusses.

In the following articles a brief discussion will be given regarding the most important points involved in the design of pin-connected trusses. It will be assumed that the general dimensions and loading conditions for the truss to be designed are the same as for the riveted truss designed in the preceding articles. The structure under consideration is a 160-ft. pin-connected Pratt truss consisting of six 26-ft. 8-in. panels with a height of truss of 29 ft. center to center chords. E-60 live loading will be assumed and the recommendations of the A. R. E. A. Specifications will be followed. Figure 50 shows the general dimensions of the structure. In the discussion which follows particular attention will be given to those points in design which differ from the ones given for riveted trusses. Wherever possible, the details for the pin-connected structure will be made the same as for the riveted structure.

9b. Design of Members.—Table 11 gives the stresses in all members of the truss under consideration. The dead load stresses were calculated for panel loads of 10,000 lb. at each top chord joint and loads of 26,500 lb. at the lower joints. These panel loads were taken from the calculations given on p. 328. Live load and impact stresses were calculated for E-60 loading using the methods given in the volume on "Stresses in Framed Structures." It has been assumed in making these calculations that diagonal members carry tension only and counters have been provided to prevent reversal of stress in these members.

TABLE 11.—STRESSES IN MEMBERS

Member	Dead load stress	Live load stress	Impact	Maximum stress vertical loading	Stress due to lateral loading	Total stress due to vertical and lateral loading
<i>aB</i>	-124,000	-348,000	-188,000	-660,000		
<i>BC</i>	-134,000	-362,000	-195,000	-691,000		
<i>CD</i>	-151,200	-412,000	-222,500	-785,700		
<i>ab</i>	+ 83,900	+235,000	+127,000	+445,900	94,200	540,100
<i>bc</i>	+ 83,900	+235,000	+127,000	+445,900	177,900	623,800
<i>cd</i>	+134,000	+362,000	+195,000	+691,000	238,400	929,400
<i>Bb</i>	+ 26,500	+119,000	+110,800	+254,300		
<i>Bc</i>	+ 74,500	+232,000	+152,800	+459,300		
<i>Cd</i>	+ 24,800	+136,000	+105,200	+266,000		
<i>De</i>	- 24,800	+ 63,000	+ 56,100	+ 94,300		
<i>Ce</i>	- 28,300	-100,000	- 77,500	-205,800		
<i>Dd</i>	+ 8,300	- 46,300	- 41,300	- 79,300		

+ denotes tension. - denotes compression.

Table 11 also gives the total stress in lower chord members due to lateral loading. These values are the same as given in Table 7, p. 330, except for member *cd*, in which a slight change in stress due to overturning effect has taken place in changing from the Warren to the Pratt type of truss.

As shown in Fig. 50, the lower chord members in the panels on each side of truss center and all tension diagonals are composed of eye bars. In designing eye bars, the cross-section of the body of the bar must furnish the required area. Article [139], {440} of the Specifications gives the general requirements regarding proportions of eye bars. The sizes of stand-

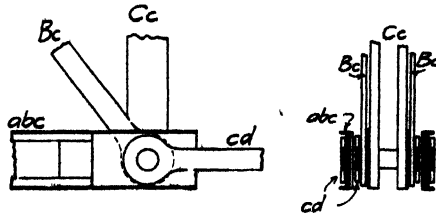

FIG. 51.

ard eye bar heads are given in the rolling mill handbooks. Since the eye bar heads must be placed inside the built-up chord sections, it is desirable that the size of head be kept as small as possible. This can be accomplished by using narrow bars, bearing in mind the limiting thickness of bars as given in Art. [139], {440} of the Specifications. However, if very thick bars are used, it will be found that large pins will be required to carry the resulting bending moments on the pins. In general, it will be found that a bar in which the thickness is about $\frac{1}{4}$ of the width will satisfy the conditions stated above.

The area required for member *cd* is determined from the combined effect of vertical and lateral loading, as in the case of the same member in the riveted truss. From Table 11 the stress in *cd* is 929,400 lb. Hence the area required is $\frac{929,400}{20,000} = 46.50$ sq. in. Four 7- \times - $1\frac{1}{16}$ -in. bars furnish 47.20 sq. in. All other eye bars are designed for working stresses of 16,000 lb. per sq. in. Figure 50 shows the adopted eye bars.

To comply with Art. [138] of the Specifications, lower chord tension member *abc* and the hip vertical *Bb* must be riveted members. The general form of these members may be

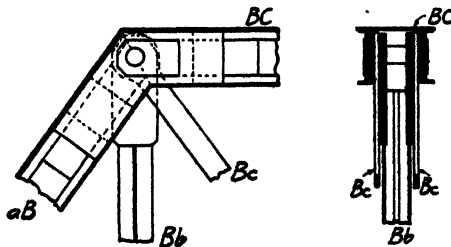

FIG. 52.

made the same as for the corresponding members of the riveted truss. In proportioning member *abc*, the depth of web plates depends upon the size of eye bar heads on the members entering joint *c*. As shown in Fig. 51 the eye bar head on member *cd* must fit inside the angles on member *abc*, and the eye bar head on *Bc* must not interfere with the lateral plate on the under side of *abc*. Since the sizes of these eye bar heads are not known until the pin sizes have been determined, the designer must estimate the probable size of these eye bar heads and arrange the parts of the member to meet the assumed conditions. When the pin sizes are known, the depth of members must be revised if the proper clearance has not been provided in the preliminary estimate. It is probable that for a truss of the size under consideration the diameter of pin used at joint *c* will not exceed about 7 or 8 in. From a table of standard eye bar heads it will be found that for pins of the assumed maximum size

a 7-in. bar requires a $17\frac{1}{2}$ -in. head and an 8-in. bar requires a 19-in. head. Where three sizes of heads are given the designer is generally safe in taking the middle size, as in the present case. The form of *abc* may then be taken the same as for the riveted truss, using $21 \times \frac{3}{16}$ -web plates and four $3\frac{1}{2} \times 3\frac{1}{2} \times \frac{3}{16}$ -in. angles. The adopted width of the vertical *Bb* depends upon the arrangement of members at joint *B*, which is shown in Fig. 62. Figure 50 shows all details of *abc* and *Bb*.

The depth of web plates for the top chord member is generally determined from the arrangement of members at joint *B*. As shown in Fig. 52, the eye bar head on member *Bc* is the determining factor. As in the case of joint *c*, the probable maximum eye bar head is 19 in. in diameter. The web plates will therefore be taken as 21 in. deep. In order to provide room for packing members *Bb* and *Bc* inside the chord section, the $\frac{3}{16}$ -in. cover

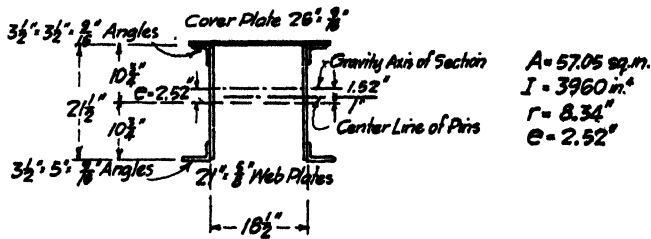

FIG. 53.

plate will be made as wide as possible subject to the requirements of Art. [65], [405] of the Specifications. Figure 53 shows the adopted section. The bottom angles in this section have been made large in order to reduce the eccentricity of the section. Figure 50 shows the adopted sizes for other compression members.

The location of the pins with respect to the gravity axis of the section depends upon the relative width of the eye bar head and the depth of the section. It is desirable to locate the pins on the gravity axis of the section in order that the stress may be uniformly distributed over the cross-section of the members. However, it is generally not practical to use sections so deep that this can be done, for the requirements of Art. [65], [405] of the Specifications regarding minimum thickness of material would require the use of a large excess of area in the member. It is therefore best to place eye bar *Bc* as close to the top cover plate as possible, as shown in Fig. 52. If the clearance between the top of the eye bar and the cover plate be taken as $\frac{1}{4}$ in., then for 19-in. eye bar head, the distance from the center of gravity of the section to the center of the eye bar head, or the center line of pin, can be seen from Fig. 53 to be 1.52 in. This distance represents the eccentricity of application of the stress in the chord member.

Since the top chord is made continuous from end to end by means of riveted joints, the whole chord acts as a continuous beam under the action of moments due to the eccentric application of the loads at the joints. If S = stress in the end segment of the top chord and e = eccentricity of application of S (considered as positive when the pin is below the center of gravity of the section), it can be shown by means of the Theorem of Three Moments that the bending moments in the top chord of a six-panel truss vary as shown in Fig. 54. For the truss under consideration, S = stress in *BC* = 691,000 lb. (see Table 11) and assuming the pin center to be located 1 in. above the center of the web plate, $e = 1.52$ in. as shown in Fig. 53. Then from the values given in Fig. 54 for the six-panel truss, the moment at *B* due to eccentric application of the stress in *BC* is $(691,000)(1.52) = 1,050,000$ in.-lb. Using the method given on p. 333 it will be found that the moment of inertia about the gravity axis of the section shown in Fig. 53 is 3,960 in.⁴ Hence the compressive fiber stress* on the lower fiber of the section at a distance 13.27 in. below the gravity axis is

$\frac{(1,050,000)(13.27)}{(3,960)} = 3,520$ lb. per sq. in. As given in Fig. 53, the area of the chord member is 57.05 sq. in. Hence the axial stress due to direct loading is $\frac{691,000}{57.05} = 12,100$ lb. per sq. in. and the combined fiber stress due to direct loading and bending is $12,100 + 3,520 = 15,620$

lb. per sq. in. Since the fiber stress due to eccentric application of the chord stress may be considered as a secondary stress, it is subject to the conditions of Art. [47], [218] of the Specifications. For the member under consideration the maximum permissible combined fiber stress is therefore $(12,500)(\frac{4}{3}) = -16,700$ lb. per sq. in. The existing fiber stress is within the allowable limits. Since the fiber stress at the point of maximum moment is within allowable limits, it is evident that all other points are also within the limits specified.

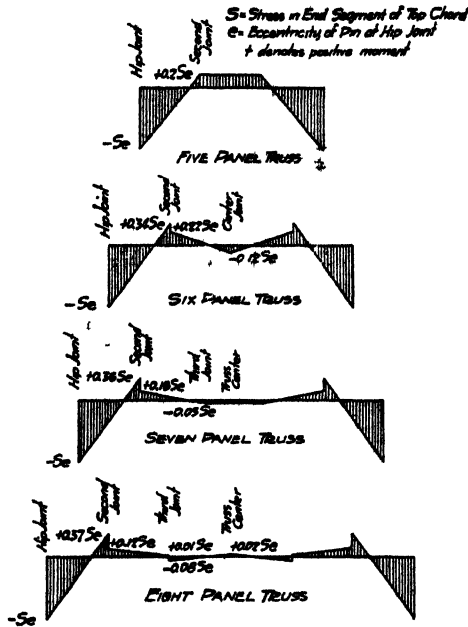

FIG. 54.—Bending moments in top chords due to pin eccentricity.

The bending moment in the end post due to eccentric application of the stress is also = $-Se$. Since the section of the end post is the same as the top chord, it will be found that the combined fiber stress is also within allowable limits.

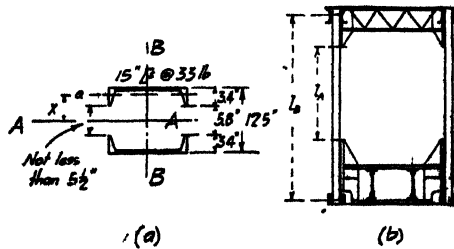

FIG. 55.

As shown in Fig. 50 the vertical posts *Cc* and *Dd* consist of 15-in. channels arranged as shown in Fig. 55. The distance back to back of these channels is generally determined by the shop requirement that a clear space between channels of at least $5\frac{1}{2}$ in. must be provided in order to permit the driving of rivets in the lacing bars connecting the channels. For the 15-in. channels shown in Fig. 50, the distance back to back of channels can not be less than $[2(3.40) + 5.3] = 12.3$ in. A $12\frac{1}{2}$ -in. spacing has been adopted. The spacing

of channels may in some cases be determined by the condition that the $\frac{I}{r}$ conditions for the member must be the same for axes $A-A$ and $B-B$ of Fig. 55 (a). From Fig. 55 (b) the unsupported length of the post for axes $A-A$ and $B-B$ are l_A and l_B respectively. If r_B = radius of gyration of section for axis $B-B$ and r_a = radius of gyration for one channel about its gravity axis $a-a$, it can readily be shown that the distance from axis $a-a$ to axis $A-A$ of Fig. 55 (a) is

$$x = \sqrt{r_B^2 \left(\frac{l_A}{l_B} \right)^2 - r_a^2}$$

For the conditions shown in Fig. 50 for member Cc , $l_B = 29$ ft., $l_A = 17$ ft., $r_B = 5.62$ in., and $r_a = 0.91$ in. Hence $x = 3.29$ in. and the distance back to back of channels is $2(3.29 + 0.79) = 8.16$ in.

9c. Design of Pins.—In a pin-connected structure, the members entering a joint are generally held in position by means of a pin which passes through the several members. These pins are designed as beams subjected to moments which are due to the loads brought to the joint by the members. The design involves also the provision of ample bearing area at the points where the members bear on the pin in order to prevent crushing of the material on the surfaces in contact.

The design of a pin is in general a cut and try process. In order that the size of pin may be determined, it is necessary to know the bending moment on the pin. But before the moment can be determined, the relative position of the loads acting on the pin must be known. Since these forces are generally assumed to act at the center of bearing on the pin for any member, the moment can not be determined until the width of bearing of the member on the pin is known. But this width can not be determined until the diameter of pin is known. Therefore the following procedure must be adopted in designing a pin. (a) Assume the size of pin required. This estimated pin size may be determined approximately by comparison with other designs, or from the previous experience of the designer. (b) Determine the width of bearing required for the several members. Standard eye bar heads are so proportioned as to give the proper bearing area without alteration. In built compression or tension members, the pins usually pass through the web plates. Since the stress from all other parts of the section must be transferred to the web plate before it can reach the pin, it is generally necessary to reinforce the web plate by the addition of extra plates in order to provide the necessary bearing area on the pin. These additional plates are known as *pin plates*. (c) Determine the moment on the pin. In determining moments on the pin it is generally assumed that the several loads on the pin are concentrated at the center of the bearing area for that member. The arrangement, or *packing*, of members on the pin will be found to have considerable effect on the value of the moment for the same set of loads. Therefore, an effort should be made to pack the members so as to produce the smallest possible moment. (d) Determine the required pin size. This may be determined by the formula given in the following discussion, or from a table of maximum moments on pins. If the assumed and required pin sizes are in agreement, the assumed pin size may be adopted. If revisions are found necessary, repeat the calculations using the pin size as determined from the above method of procedure. In general, it is advisable to use as few sizes of pins as possible. (e) Attachment of pin plates to the member. This portion of the design will be discussed in detail in Art. 9d.

As an example of the general methods involved in the design of pins, detailed calculations will be given for the design of pins at several of the joints of the truss shown in Fig. 50.

Pin at Joint B.—The arrangement of members at joint B is shown in Fig. 56 (a). Assume that a $7\frac{1}{4}$ -in. pin is required at joint B . In determining the bearing area required for the built compression members aB and BC , the maximum stresses in Table 11 must be used. From Art. [88], [301] of the Specifications the allowable bearing pressure is 24,000 lb. per sq. in. Hence the thickness or bearing plates required for each web plate of member aB is $\frac{660,000}{(2)(7\frac{1}{4})(24,000)} = 1.90$ in. and for member BC , the thickness of bearing plates must be $\frac{691,000}{(2)(7\frac{1}{4})(24,000)} = 1.99$ in.

Since aB and BC are compression members, it is not necessary that all parts of the bearing plates pass around the pin for the members will be held against the pin by the stress in

the member. The members may then be cut off as shown in Fig. 56 (b). However, it is usual to extend one pin plate from each member so that it will pass around the pin. These plates are known as *hinge plates*. As shown in Fig. 56 (b) the inside plate on *aB* and the outside plate on *BC* act as hinge plates.

The arrangement of pin plates on members *aB* and *BC* is governed by Art. [79] of the Specifications and also by the condition that to facilitate erection in the field there must be a clear space of at least $\frac{1}{8}$ in. between the inside face of the hinge plates and the face of the adjacent members. Figure 56 (c) shows a horizontal section of joint *B* cutting the several

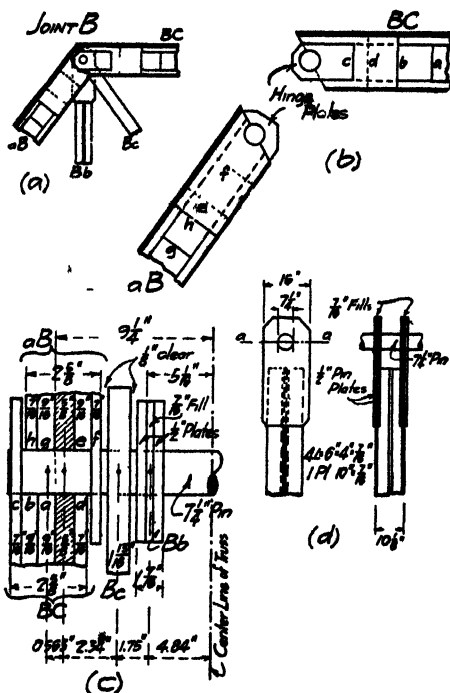

FIG. 56.

members in the plane of the pin center. In designing the chord members, the outside faces of the web plates for members *aB* and *BC* were placed $18\frac{1}{2}$ -in. apart, as shown in Fig. 53. The hatched areas in Fig. 56 (c) show these web plates, which are each $\frac{3}{8}$ in. thick. On the outside of the web plates filler plates are placed which are equal in thickness to the angles on the members. These plates are $\frac{3}{16}$ in. thick and their position on the member is shown by *a* and *g* of Fig. 56 (b). On member *BC*, a $\frac{9}{16}$ -in. and a $\frac{1}{4}$ -in. plate (shown by *c* and *b* in Fig. 56 (b)) are placed outside the angles. These plates are made as wide as possible, and the outside plate is extended around the pin to form a hinge plate. On the inside of the member a $\frac{1}{4}$ -in. plate (shown by *d* in Fig. 56 (b)) has been used. Since rivets must be countersunk in these plates, it will be found that a $\frac{3}{16}$ -in. plate is the minimum allowable plate thickness. The total width of bearing provided by this arrangement of plates is $2\frac{5}{8}$ in. This width is somewhat greater than necessary, but it is the least width obtainable for the arrangement of plates which has been used. This arrangement is desirable, for the rivets in the web plate which also pass through the inner and outer pin plates, are in bearing or in double shear instead of in single shear. These increased rivet values permit the use of shorter pin plates. On member *aB* a $\frac{9}{16}$ -in. filler and a $\frac{1}{4}$ -in. pin plate are used on the outside of the web plate. As shown in Fig. 56 (c) this provides a clearance of $\frac{1}{8}$ in. between the hinge plate on *BC* and plate *h* on member *aB*. On the inside of *BC* a $\frac{3}{16}$ -in. plate is

used against the web plate and a $\frac{1}{4}$ -in. plate (plate *f* on Fig. 56 (c)) forms a hinge plate. The clearance between the hinge plate on *aB* and plate *d* of member *BC* is also $\frac{1}{8}$ in.

The $1\frac{1}{8}$ -in. eye bar of member *Bc* is placed just inside the chord members. As shown in Fig. 56 (c), a clearance of $\frac{1}{8}$ in. has been provided on each side of the eye bar. As stated in Art. [38], [301] of the Specifications, the allowable stresses in tension in the eye bar and bearing on the pin are 16,000 and 24,000 lb. per sq. in. respectively. Hence it can readily be seen that when the diameter of pin is greater than $\frac{2}{3}$ the width of the bar, the bearing area between the pin and the bar is provided by an eye bar head of the same thickness as the body of the bar. However, Art. [139], [440] of the Specifications does not permit the use of pins whose diameter is less than $\frac{1}{8}$ the width of the bar. For the case under consideration, the minimum allowable pin is therefore $(\frac{1}{8})(8) = 7$ in. Since the assumed pin is $7\frac{1}{4}$ in. in diameter, this requirement is satisfied.

From Table 11 the stress in *Bb* is 254,300 lb. Hence the width of bearing on the pin for each segment of the member must be at least $\frac{254,300}{(2)(7\frac{1}{4})(24,000)} = 0.733$ in. However, it will be found that the width of bearing to be provided for member is governed by other considerations, which will now be discussed.

Member *Bb* is a tension member consisting of four 4- \times -6- \times - $\frac{1}{8}$ -in. angles and a 10- \times - $\frac{1}{8}$ -in. plate arranged as shown in Fig. 56 (d). To connect this section to the pin, plates are riveted to the 6-in. legs of the angles as shown in Fig. 56 (d). Above the angles, a filler is placed between these plates. The thickness of the filler is $\frac{1}{8}$ in., the same as the thickness of the angles. From Art. [76] of the Specifications, the net area on section *a-a* of Fig. 56 (d) must be 140 per cent of the area of the body of the member. For the section given above the net area is found to be 16.70 sq. in. (two rivet holes from each angle and two from the plate). Hence the net area of each segment on section *a-a*, Fig. 56 (d), must be $(\frac{1}{2})(16.70)(1.40) = 11.69$ sq. in. Assuming the total width of the connecting plates to be 16 in., the thickness of plates must be $\frac{11.69}{(16 - 7\frac{1}{4})} = 1.34$ in. Two $\frac{1}{2}$ -in. plates in addition to the $\frac{1}{8}$ -in. filler will therefore be required, giving a total width of bearing of $1\frac{1}{4}$ in. Figure 56 (c) shows the bearing plates for *Bb* in position. It will now be necessary to determine the distance from the outside of the filler plate of member *Bb* to the center of the member in order to check on the width of plate assumed for the body of member *Bb*. From the dimensions given in Fig. 56 (c), this distance is found to be $5\frac{1}{8}$ in. Hence a 10-in. plate may be used as assumed.

After the packing of the members has been arranged, as shown in Fig. 56 (c), the distance between centers of bearing for the several members must be determined. These distances are as shown in Fig. 56 (c).

The moment on the pin is to be calculated for the loading condition which produces the maximum moment. It can readily be seen that the stresses to be used for the several members must be the *simultaneous stresses* in these members for some given load position, for the pin must be in equilibrium under the applied loads. Therefore the maximum stresses for all members as given in Table 11, p. 342 cannot be used but new values must be determined. It will be found by trial that the load position causing maximum stress in *Bb* (and also in *aB*) will give the maximum pin moment.

In calculating the moment on the pin, the applied loads may be resolved into their vertical and horizontal components. The moment for forces in the horizontal and vertical planes may then be determined, and finally, the resultant of these moments will give the required moment. Table 12 gives the vertical and horizontal components of stress acting in the several members. To determine the live load stresses, the live load stress for *Bb* may be taken directly from Table 11 and the vertical component of stress in *aB*, which is $\frac{348,000}{1.36} = 256,000$ lb., may be determined from values given in Table 11. These components are shown in position in Fig. 57 (a).

The simultaneous stresses in *BC* and *Bc*, as given in Table 12 may readily be determined from Fig. 57 (a). In calculating impact stresses, the same impact coefficient must be used for all members. Since the truss is fully loaded ($L = 160$ ft.), the impact coefficient is 0.54. To determine the dead load stresses, the values given in Table 11 for members *Bb* and *Bc* will be used. Figure 57 (b) shows the simultaneous components for all members. It will be noted that the values shown for *BC* and *aB* do not agree with those given in Table 11. This is due to the fact that the dead

joint load at *B* has been omitted. However, the resulting error is small, and the results obtained will be considered as satisfactory. Having found the total vertical components of stresses as given in Table 12, the horizontal components were found by multiplying total vertical components by $\frac{26.67}{29}$ which is the tangent of the angle between the diagonal and vertical members.

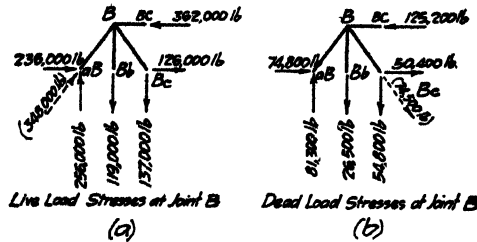

FIG. 57.

TABLE 12.—SIMULTANEOUS STRESSES IN MEMBERS AT JOINT *B*

Member	Vertical component				Horizontal component	Member
	Live load	Impact	Dead load	Total		
aB	256,000	138,000	81,300	475,300	438,000	aB
Bb	119,000	64,300	26,500	209,800	Bb
Bc	137,000	73,700	54,800	265,500	244,000	Bc
BC	682,000	BC

Figure 58 shows the components of stresses in members in position on the pin. From Fig. 58 (a) the pin moment due to vertical forces is a maximum at point 4. The value of this moment is $(237,850)(2.34 + 1.75) - (132,750)(1.75) = 739,000$ in.-lb. From Fig. 58 (b) it can be seen that for horizontal components the moment at 4 is equal to the moment

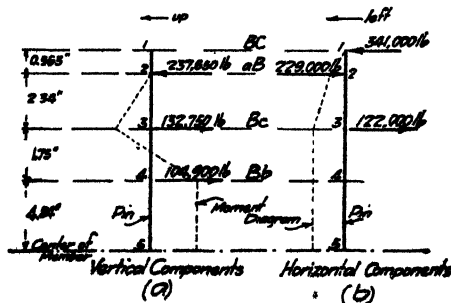

FIG. 58.

at 3, and that the moment is $(341,000)(0.563 + 2.34) - (229,000)(2.34) = 454,000$ in.-lb. The resultant of horizontal and vertical moments is $\sqrt{(739,000)^2 + (454,000)^2} = 868,000$ in.-lb.

Having given the maximum bending moment and the allowable fiber stress, the required diameter of pin may be determined from the formula $f = \frac{Mc}{I}$, which is the usual formula for

determination of fiber stress in beams. For a circular section $\frac{I}{c} = \frac{\pi d^3}{32} = 0.098d^3$, where d = diameter of pin in inches. Placing this value of $\frac{I}{c}$ in the general formula and solving for d , we have

$$d = \sqrt[3]{10.2 \frac{M}{f}} = 2.17 \sqrt[3]{\frac{M}{f}}$$

From Art. {38}, {301} of the Specifications, the allowable bending stress on the pin is 24,000 lb. per sq. in. On substituting this value of f in the above equation we have

$$d = 0.0753 \sqrt[3]{M}$$

Therefore, the pin diameter required for the moment calculated above is $d = 0.0753 \sqrt[3]{868,000} = 7.18$ in. The assumed $7\frac{1}{4}$ -in. pin is therefore satisfactory and will be adopted. The diameter of pin may also be taken from tables which give the maximum moment which may be carried by a pin of given diameter.

From a table of standard eye bar heads, it will be found that a $7\frac{1}{4}$ -in. pin hole may be placed in a 19-in. head on an 8-in. bar. Hence all preliminary assumptions made regarding pin size and size of eye bar head check with the standards. The adopted details of top

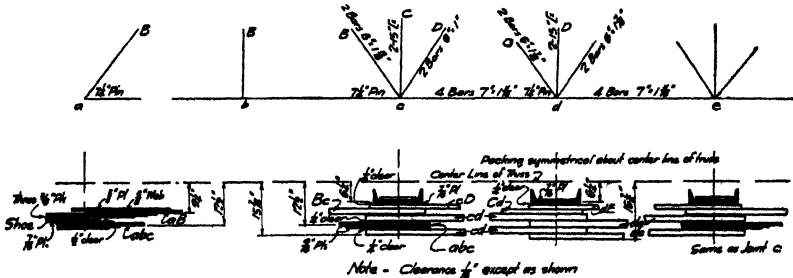

FIG. 59.—Lower chord packing.

chord members may therefore be used. If it had been found that the assumed sizes for these parts did not check with the standard sizes, it would probably have been necessary to make revisions in sections to fit the actual conditions.

Packing of Lower Chord Members.—The packing of the lower chord members on the pins must be so arranged as to cause the least possible moment in the pins. Also, the packing of any member at adjacent joints must be such that the inclination of members between joints does not exceed $\frac{1}{8}$ in. per ft. (Art. {140}, Specifications). Members should not be in direct contact. Where eye bars are placed side by side, a clear space of $\frac{1}{8}$ in. must be left between the adjacent faces. When an eye bar is placed next to a riveted member, the clear space provided should be at least $\frac{1}{8}$ in., and where two riveted members are placed side by side, the clearance should be at least $\frac{1}{4}$ in.

In packing the members of the lower chord, it will generally be found best to arrange the members at each joint in order to obtain minimum moment on the pin. After this has been done, the several joints must be studied as a unit in order to make certain that the inclination of bars between adjacent joints does not exceed the allowable limits stated in Art. {140} of the Specifications. The problem of lower chord packing is complicated and requires careful consideration.

Figure 59 shows a layout of the lower chord packing as adopted for the truss under consideration. As shown on the layout, $7\frac{1}{4}$ -in. pins have been used at all lower chord joints. In calculating moments on the pins at joints c and d , it was found that these moments were a maximum for the loading conditions giving maximum stresses in the diagonals Bc and Cd . The moment on the pin at joint a was found to be a maximum when the stress in the end post was a maximum. It will generally be found for trusses of the form under consideration that the pin at the center lower chord joint will have a moment greater than the other lower chord pins. The design of this pin should be considered first. Having decided upon the

proper pin size, it will be found best to use the same pin size at *c* and *e*. At joint *a* the pin size is generally made the same as at joint *B*. As shown on Fig. 50, $5\frac{1}{2}$ -in. pins have been used at top chord joints *C*, *D*, and *E*. This is about the minimum size of pin which can be used in 6-in. bars (Art. [139], [440], Specifications). It will be noted from Fig. 50 that two 6-in. bars have been used as counters in panel *cd* and *de*. These bars furnish considerable excess area, but if a single bar is used, it would have to be placed at the pin center. This results in very large moments. The use of two bars as counters, arranged as shown in Fig. 59, will result in smaller pin moments.

9d. Attachment of Pin Plates.—In designing the pins it was assumed that the bearing pressure between the pin and the pin plates placed on the member is uniformly distributed over the area of contact between pin and member. The design of pin plate attachment consists in providing sufficient connecting rivets between these plates and the body of the main member so that the stresses in the plates at the pin will be transferred to the body of the member without overstressing any part of the member. In the following discussion detailed calculations will be given for the design of pin plate attachment for a few of the truss members shown in Fig. 50.

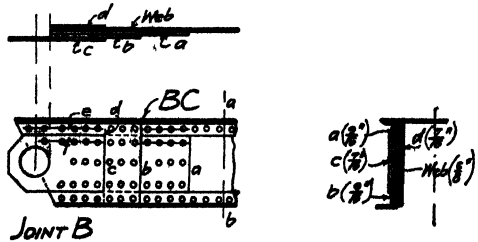

FIG. 60.

Member BC at Joint B.—The attachment of pin plates at joint *B* of member *BC* must be designed to meet the following conditions: (a) The stress in the top angle and one-half the cover plate must be transferred to the pin plates by means of rivets through the vertical leg of the top angle; (b) the stress in the lower angle must be transferred to the pin plates by means of rivets through the vertical leg of the lower angle; and (c) the difference in stress in the web plate in the body of the member and at the pin must be transferred from the web plate to the pin plates by the connecting rivets.

Figure 60 shows the arrangement of pin plates on member *BC* at joint *B*. Plate *b* on the outside of the member has been made wide enough to cover the vertical legs of the angles, for in this manner the rivets through the angles may be counted in bearing on the angle, thereby permitting the use of short pin plates. The hinge plate, shown as plate *c*, is made 14 in. wide, extending to the inner edges of the angles. This is done to allow clearance for driving the rivets in the horizontal legs of the top angles.

The stresses in the several pin plates at the pin are given in Table 13. These stresses were determined on the assumption that the total stress in *BC* is carried by the several plates in proportion to their thickness. The total stress in the member must be determined subject to the requirements of Art. [37] of the Specifications. The gross area of member *BC* as shown in Fig. 53 is 57.05 sq. in. and from Art. 33, [301] of the Specifications, the allow-

TABLE 13.—STRESSES IN PIN PLATES AT PIN HOLE AT *B* ON ONE SIDE OF MEMBER *BC*

Plate	Thickness	Stress
<i>a</i>	$\frac{3}{16}$	$(\frac{3}{16})(356,600) = 76,400$
<i>b</i>	$\frac{3}{16}$	$(\frac{3}{16})(356,600) = 76,400$
<i>c</i>	$\frac{1}{4}$	$(\frac{1}{4})(356,600) = 59,400$
<i>d</i>	$\frac{1}{4}$	$(\frac{1}{4})(356,600) = 59,400$
web	$1\frac{1}{8}$	$(1\frac{1}{8})(356,600) = 85,000$
	$4\frac{3}{16}$	356,600

able working stress is 12,500 lb. per sq. in. Hence the full working strength of *BC* is (57.05)(12,500) = 713,100 lb. This exceeds the stress given in Table 11, for member *BC*, but it must be used in order to comply with the Specifications.

On a section *a-b*, Fig. 60, taken in the body of the member, the stresses in the plates and angles forming one-half the member are as given in Table 14, assuming the stress divided among the parts in proportion to their area.

TABLE 14.—STRESSES IN PARTS OF MEMBER *BC* AT SECTION *a-b*, FIG. 60

Part	Area	Stress
½ Cover plate	7.31	$\left(\frac{7.31}{28.525}\right) (356,600) = 91,400$
Top angle	3.62	$\left(\frac{3.62}{28.525}\right) (356,600) = 45,200$
Web plate	13.125	$\left(\frac{13.125}{28.525}\right) (356,600) = 164,100$
Bottom angle	4.47	$\left(\frac{4.47}{28.525}\right) (356,600) = 55,900$
	28.525	356,600

The stresses given in Table 14 for the top angle and one-half the cover plate, a total stress of 136,600 lb., must be transferred to the pin plates by means of rivets through the vertical leg of the top angle. This stress of 136,600 lb. must be taken by all pin plates, acting as a unit. Also, each pin plate must take its share of the total stress. Assuming that each plate is stressed in proportion to its thickness, the stresses in the several plates are given in Table 15. Plate *c*, the hinge plate, has been included in Table 15. Although plate *c* does

TABLE 15.—STRESSES IN PIN PLATES AT TOP ANGLE

Plate	Thickness	Stress
<i>a</i>	$\frac{3}{16}$	$\left(\frac{3}{32}\right) (136,600) = 38,400$
<i>b</i>	$\frac{3}{16}$	$\left(\frac{3}{32}\right) (136,600) = 38,400$
<i>c</i>	$\frac{1}{16}$	$\left(\frac{1}{32}\right) (136,600) = 29,900$
<i>d</i>	$\frac{1}{16}$	$\left(\frac{1}{32}\right) (136,600) = 29,900$
	$2\frac{3}{16}$	136,600

not contain rivets which pass through the top angles, it is evident that a portion of the stress of 59,400 lb. given in Table 13 for plate *c* must come from the top angles. The stress in the top angles which is carried by plate *c* is transferred from rivet line *e* to rivet line *f* in Fig. 60 by an indirect transmission of shear through pin plate *b*. Hence, it may be assumed that plate *c* is directly connected to the rivets in line *e*.

From Table 15, plate *c* has a stress of 29,900 lb. If plate *c* be considered as acting alone, the connecting rivets are in single shear and $\frac{29,900}{7,320} = 5$ rivets are required. Figure 60 shows 5 rivets in line *f* and 6 rivets in line *e*. Plate *c* on the front face of *BC* and plate *d* on the rear face, when acting together, have a total stress which is given in Table 15 as 29,900 + 29,900 = 59,800 lb. As stated above, the rivets in line *e* may be considered as passing

through plate *b*. Hence, the rivets passing through plates *c* and *d* are in bearing on the $\frac{3}{8}$ -in. top angles, and the value of a rivet is 11,810 lb. Therefore, $\frac{59,800}{11,810} = 5$ rivets are required to carry the stress in plates *c* and *d*. Plate *d* may then be cut off as shown in Fig. 60, which shows that plates *c* and *d* are equal in length. From Table 15, plates *b*, *c* and *d* have a total stress of 38,400 + 29,900 + 29,900 = 98,200 lb. As shown in Fig. 60, there are 6 rivets in position which pass through plates *b* and *d*. These rivets have a value of (6)(11,810) = 70,860 lb. There remains 98,200 - 70,860 = 27,340 lb. to be carried by rivets in plate *b*. These rivets may also be considered in bearing on the top angles because of the indirect transmission of stress by the web plate. Hence $\frac{27,340}{11,810} = 3$ additional rivets are required in plate *b*. These are shown in position in Fig. 60. Finally, the entire group of plates must transfer the total stress of 136,600 lb. to the top angle. Figure 60 shows 9 rivets in bearing on the top angles. These rivets have a value of (9)(11,810) = 106,300 lb. The balance of the total stress, which is 136,600 - 106,300 = 30,300 lb., must be carried by rivets in line *g* of plate *a*. These rivets are in single shear, and they may be considered as transferring their stress through the web plate to line *h* of the top angles. The number required is $\frac{30,300}{7,220} = 4$, which are shown in position in Fig. 60.

Table 16 gives the stress transferred by the lower angles to the pin plates. From Table 14 the stress to be transferred is 55,900 lb. By the same methods as used above, it will be

TABLE 16.—STRESSES IN PIN PLATES AT LOWER ANGLE

Plate	Thickness	Stress
<i>a</i>	$\frac{3}{8}$ "	$(\frac{3}{8})(55,900) = 15,720$
<i>b</i>	$\frac{3}{8}$ "	$(\frac{3}{8})(55,900) = 15,720$
<i>c</i>	$\frac{3}{8}$ "	$(\frac{3}{8})(55,900) = 12,230$
<i>d</i>	$\frac{3}{8}$ "	$(\frac{3}{8})(55,900) = 12,230$
	$2\frac{3}{8}$ "	55,900

found that the arrangement of rivets shown in Fig. 60 provides excess strength. This is the least number of rivets which can be used, since the plates are cut square at the ends, as shown.

The difference in stress in the web plate and in the body of the member will be provided for by means of rivets placed along the center line of the web plate. It will be assumed that the rows of rivets just inside the points of the angles serve to bind the plates to the web and assist in the indirect transfer of stress which has been mentioned in the above discussion. From Tables 13 and 14, the difference in web plate stress between the pin hole and section *a-b* of Fig. 60 is 164,100 - 85,000 = 79,100 lb. Assuming this stress to be taken by the several plates in proportion to their thickness, the plate stresses are as given in Table 17.

Plate *c*, acting alone, has a stress of 17,300 lb. The rivets connecting this plate to the member are in single shear and $\frac{17,300}{7,220} = 3$ rivets are required. In Fig. 60 the required rivets are shown in place on the center line of the web plate. Plates *c* and *d* acting together have a total stress of 17,300 + 17,300 = 34,600 lb. The connecting rivets are in bearing on the web plate and they have a value of 13,130 lb. per rivet. Figure 60 shows 3 rivets passing through both plates. The value of these rivets is (3)(13,130) = 39,390 lb. Plates *b*, *c* and *d* acting together have a total stress of 22,250 + 17,300 + 17,300 = 56,850 lb. Figure 60 shows 3 rivets through plates *c* and *d* which are in bearing on the web plate and 3 rivets in plate *b* which are in single shear. The total value of these rivets is (3)(13,130) +

(3)(7,220) = 61,050 lb. Finally, all plates acting together have a stress of 79,100 lb. Figure 60 shows 3 rivets in bearing on the web plate and 6 rivets in single shear. These rivets have a value of (3)(13,130) + (6)(7,220) = 83,710 lb.

Before the arrangement of plates and rivets shown in Fig. 60 may be adopted as final, a check must be made in order to make certain that the rivets in the several plates will carry the stresses given in Table 13. Except for plate c, only the rivets passing through the

TABLE 17.—STRESSES IN PIN PLATES ON CENTER LINE OF WEB PLATE

Plate	Thickness	Stress
a	$\frac{9}{16}$	$(\frac{9}{16})(79,100) = 22,250$
b	$\frac{9}{16}$	$(\frac{9}{16})(79,100) = 22,250$
c	$\frac{7}{16}$	$(\frac{7}{16})(79,100) = 17,300$
d	$\frac{7}{16}$	$(\frac{7}{16})(79,100) = 17,300$
	$3\frac{3}{16}$	79,100

angles and the line of rivets at the center of the web plate will be considered, for the reasons given above. Plate c alone has a stress of 59,400 lb. (Table 13). Figure 60 shows 12 rivets in single shear in plate c. These rivets have a value of (12)(7,220) = 86,600 lb. Plates c and d together have a stress of 118,800 lb. Figure 60 shows 10 rivets in bearing on the $\frac{9}{16}$ -in. angles and 3 rivets in bearing on the $\frac{5}{8}$ -in. web plate. The total value of these rivets is 157,490 lb. Plates b, c and d taken together have a total stress of 195,200 lb. Figure 60 shows 16 rivets in bearing on the angles, 3 rivets in bearing on the web plate, and 3 rivets in single shear. These rivets have a total value of 250,010 lb. All plates, acting together, have a stress of 271,600. To carry this stress, Fig. 60 shows 16 rivets in bearing on the angles, 3 rivets in bearing on the web plate, and 14 rivets in single shear. These rivets have a value of 329,430 lb. Since the strength provided by rivets is in all cases in excess of the stresses, the arrangement shown in Fig. 60 will be adopted as final.

Member abc.—As shown in Fig. 50, $7\frac{1}{4}$ -in. pins are provided at each end of member abc. The thickness of pin plates required on member abc is determined by the requirements of Art. [76] of the Specifications. The net area of member abc is found to be 31.37 sq. in. To meet the requirements of Art. [76] of the Specifications, the net area through the pin hole must be at least $(\frac{1}{2})(31.37)(1.40) = 21.96$ sq. in. for each segment of the member. As shown in Fig. 61, a $14 \times \frac{9}{16}$ -in. filler and a $19 \times \frac{9}{16}$ -in. cover plate are used as pin plates. The net area at the pin hole is found to be 22.01 sq. in.

From Art. [76] of the Specifications, the rivets in the pin plates must develop the full strength of the net area at the pin hole. Therefore the pin plate attachment must be designed for a stress of $(22.01)(16,000) = 352,200$ lb. in each segment of member abc.

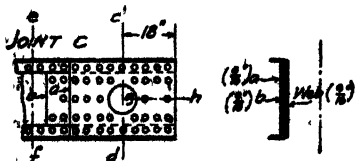

Fig. 61.

Figure 61 shows the conditions at joint c of member abc. The stress brought to the member by the pin is delivered to the pin plates in bearing at point g. These pin plate stresses must be transmitted by the plates and distributed uniformly over the net area of the section at the pin hole, shown by c-d in Fig. 61. Finally, the stresses at section c-d must be transmitted to the body of the main member at section e-f.

In carrying out the design as outlined above, it will be assumed that the stress at section e-f is the same as the stress at the pin hole section, which has been found to be 352,200 lb. Assuming that the total stress at point g is carried by the several plates in proportion to their thickness, the stresses are as given in Table 18.

TABLE 18.—BEARING STRESSES ON PLATES AT PIN HOLE

Plate	Thickness	Stresses
<i>a</i>	$\frac{3}{16}$	$\frac{3}{16}(352,200) = 117,400$
<i>b</i>	$\frac{3}{16}$	$\frac{3}{16}(352,200) = 117,400$
Web plate	$\frac{3}{16}$	$\frac{3}{16}(352,200) = 117,400$
	$2\frac{3}{16}$	352,200

At the pin hole, the stresses carried by the several plates and angles are as given in Table 19.

TABLE 19.—STRESSES ON NET AREA AT PIN HOLE

Section	Net area	Stresses
Top angle.....	3.06	$\left(\frac{3.06}{22.01}\right)(352,200) = 49,000$
Pin plate (<i>a</i>).....	5.48	$\left(\frac{5.48}{22.01}\right)(352,200) = 87,700$
Pin plate (<i>b</i>).....	3.80	$\left(\frac{3.80}{22.01}\right)(352,200) = 60,700$
Web plate.....	6.61	$\left(\frac{6.61}{22.01}\right)(352,200) = 105,800$
Bottom angle.....	3.06	$\left(\frac{3.06}{22.01}\right)(352,200) = 49,000$
	22.01	352,200

From Tables 18 and 19, it will be found on comparing the stresses given for pin plates *a* and *b* and the web plate that these plates have delivered to them in bearing at point *g* a stress which is greater than they are capable of carrying at the net section through the pin hole. It can readily be seen that this excess stress is transferred to the angles between the pin hole and the end of the member, and that it is carried across the net section by the angles. From Table 19, the stress in each angle is 49,000 lb. The connecting rivets are in bearing on the angle, having a value of 11,810 lb. per rivet. Hence $\frac{49,000}{11,810} = 5$ rivets are required in the angle between the pin hole and the end of the member. The total stress of 98,000 lb. which is delivered to the angles on the right of the pin hole comes from the pin plates and the web plate. Since the web plate and pin plate *a* are in contact with the angle, their portion of the stress is transmitted directly. Since pin plate *b* is not in direct contact with the angles, the portion of the 98,000 lb. which is delivered to the angles must be transmitted indirectly through plate *a* and the web. The stress thus transmitted is the difference in the stresses given in Tables 18 and 19 for plate *b*, which is found to be 117,400 - 60,700 = 56,700 lb. From Fig. 61, the connecting rivets can be seen to be in bearing on pin plate *b*. Hence $\frac{56,700}{11,810} = 5$ rivets are required. Figure 61 shows 10 rivets in place. This is in excess of the number required, but the arrangement shown is symmetrical and serves to bind the plates together effectively.

Table 20 gives the stresses in the several parts of the body of the member, assuming that the total stress at the pin hole is transferred to the cross-section of the member.

TABLE 20.—STRESSES ON NET SECTION OF MAIN MEMBER

Section	Net area	Stress
Top angle.....	3.06	$\left(\frac{3.06}{15.685}\right) (352,200) = 68,700$
Web plate.....	9.565	$\left(\frac{9.565}{15.685}\right) (352,200) = 214,800$
Bottom angle.....	3.06	$\left(\frac{3.06}{15.685}\right) (352,200) = 68,700$
	15.685	352,200

From Tables 19 and 20, it can be seen that a stress of 68,700 - 49,000 = 19,700 lb. must be transferred from pin plates *a* and *b* to the angles. Hence $\frac{19,700}{11,810} = 2$ rivets must be placed through the angles between sections *c-d* and *e-f* of Fig. 61. Four rivets are shown in place. At the pin hole, the stress in the web plate, as given in Table 19, is 105,800 lb., and in the body of the member at section *e-f* the stress in the web plate, as given in Table 20, is 214,800 lb. The difference between these stresses, or 109,000 lb., must be transferred to the web plate by rivets in single shear. Hence $\frac{109,000}{7,220} = 16$ rivets are required. In Fig. 61, 16 rivets are shown in plates *a* and *b*, not counting the rivets in plate *a* through the angles. Note that only two rivets are used in the last row of rivets in plate *b* in order to attain the effective net area assumed in the design of member *abc*.

The net length of the member on the line *g-h* to the right of the pin hole must meet the requirements of Art. [76] of the Specifications. Since the total thickness of plates on this section is $1\frac{1}{8}$ in. and the net area required is 15.685 sq. in., the required net length is $\frac{15.685}{1\frac{1}{8}} = 9.3$ in. The net length provided by the arrangement shown in Fig. 61 is $18 - (3\frac{3}{8} + 2) = 12\frac{3}{8}$ in.

Member Bb at Joint B.—The dimensions of the pin plates on member *Bb* at joint *B* have been determined on p. 348. Figure 62 shows the adopted arrangement of pin plates. The net area of plates at the pin hole is $(16 - 7\frac{1}{4})(1\frac{1}{8}) = 12.58$ sq. in. for each segment of the member. Hence the stress to be used in designing the pin plate attachment is $(12.58) (16,000) = 201,000$ lb.

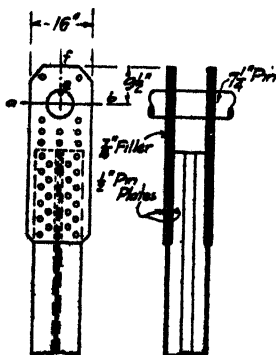

FIG. 62.

At point *e*, Fig. 62, when the pin plates bear on the pin, each plate receives a stress which is proportional to its thickness. Hence the stress in the $\frac{1}{8}$ -in. filler is $(\frac{3}{8}) (201,000) = 61,000$ lb., and the stress in each $\frac{1}{2}$ -in. pin plate is $(\frac{3}{2}) (201,000) = 70,000$ lb. At the pin hole, the net area of each plate is proportional to its thickness. Hence the stresses in the several plates are the same as given above for bearing stress. Therefore, no rivets are required above the pin hole, since the stresses in bearing at *e* and the stresses on the net section are equal. Two rivets are placed above the pin in order to bind the plates together. As shown in Fig. 62, the $\frac{1}{8}$ -in. filler extends below the pin to the tops of the angles of the main member, which are cut off at *c-d*. The stress of 61,000 lb. in the filler must be transferred to the outside plates by rivets placed above *cd* and below the pin. These rivets are in bearing on the filler and $\frac{61,000}{9,190} = 7$ rivets are required. Figure 62 shows 8 rivets in place.

The net area required on line *e-f* above the pin hole is $(\frac{1}{2})(16.70) = 8.35$ sq. in. (Art. [76], Specifications). Since the plates are $1\frac{1}{16}$ in. thick, the net length required is $\frac{8.35}{1\frac{1}{16}} = 5.75$ in. From Fig. 53, the distance from the center of the pin to the under side of the cover plate is $9\frac{3}{4}$ in. Allowing $\frac{1}{4}$ in. clear between the top of member *Bb* and the cover plate, the distance from the pin center to the top of member *Bb* may be as great as $9\frac{1}{2}$ in., as shown in Fig. 62. This arrangement provides a net length of $9\frac{1}{2} - 3\frac{3}{8} = 5\frac{7}{8}$ in. on line *e-f*.

The pin plates must be connected to the main angles by means of rivets passing through the $\frac{1}{2}$ -in. pin plates and the angles. The inside plate must be slotted around the angles. Since the connecting rivets are in bearing on the $\frac{1}{16}$ -in. angles, the number required in each pair of angles is $\frac{201,000}{9,190} = 22$ rivets. Figure 62 shows the adopted arrangement.

Pin Plate Attachment for Vertical Compression Members.—In designing the pin at lower chord joint *c* it was found that pin plates had to be provided to take care of the bearing due to the vertical component of stress in diagonal *Bc*. From Table 11, this stress is 459,300 lb. and its vertical component is $\frac{459,300}{1.36} = 337,000$ lb. For a $7\frac{1}{4}$ -in. pin, the thickness of

bearing for each segment of the post is $\frac{337,000}{(2)(7\frac{1}{4})(24,000)} = 0.97$ in.

Since the web of a 15-in. 33-lb. channel is 0.40 in. thick, pin plates totaling $0.97 - 0.40 = 0.57$ in. in thickness are required. A $\frac{1}{16}$ -in. plate was placed outside the channels and a $\frac{3}{8}$ -in. plate was placed inside, arranged as shown in Fig. 63. A $\frac{1}{16}$ -in. plate was used on the outside because some of the rivets must be countersunk in the face of the plate. Assuming the total stress to be carried by the plates in proportion to their thickness, the $\frac{1}{16}$ -in. plate carries $\frac{(168,500)(0.4375)}{1.2125} = 60,800$ lb. and the $\frac{3}{8}$ -in. plate carries 52,200 lb.

Considering each plate to act alone, the rivets being in single shear, $\frac{52,200}{7,220} = 8$ rivets are required in the $\frac{3}{8}$ -in. plate, and $\frac{60,800}{7,220} = 9$ rivets are required in the $\frac{1}{16}$ -in. plate. When both plates act together, the rivets being in bearing on the 0.4-in. web of the channel the number required is $\frac{52,200 + 60,800}{8,400} = 14$ rivets. Figure 63 shows the adopted arrangement.

9c. Lateral Bracing, Floor System, etc.—The design of the lateral bracing, portal, and sway bracing is designed by the same methods as used in Art. 3f for the riveted truss. Figure 50 shows the adopted arrangement.

The stringers for the pin-connected truss may be made the same as those designed in Art. 8d for the riveted truss. Figure 50 shows the complete details of these stringers. Since the top chord and end post have been made slightly wider than these members for the riveted truss, it will be necessary to use a wider spacing for the main trusses. From Fig. 53, it can be seen that the extreme width of chord members over the lower angles is $28\frac{1}{2}$ in. Hence the trusses will be spaced 18 ft. 6 in., as shown in Fig. 50.

The design methods for the flange and web section of the intermediate floor beam are the same as for the riveted truss as given on p. 336 of Art. 8d. However, the lower corner of the floor beam must be cut away, as shown in Fig. 64, in order to clear the lower chord member and the diagonal eye bars. From Fig. 59 the half width of the lower chord at joint *c* is 1 ft. $4\frac{3}{8}$ in. To allow room for removing the pilot nut after the pin at *c* is driven, an additional clearance of 6 in. must be provided. Hence the inside face of the corner angle on the web plate must be placed 1 ft. $10\frac{3}{8}$ in. from the center line of the truss, as shown in Fig. 64. To avoid interference with the eye bars entering joint *c*, the horizontal legs of the corner angle must be placed 1 ft. 2 in. above the center line of the lower chord. This distance is best determined by means of a layout of the joint. Figure 64 shows the portion of the web plate and lower angles which have been cut away.

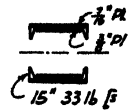
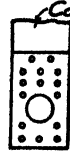

FIG. 63.

To provide room for the rivets required to connect the floor beam to the vertical posts, the connection angle has been extended above the top flange angles. It was found on p. 336 that 45 field rivets are required in this connection. These rivets are shown in place in Fig. 64. The connection angles are fastened to an irregular shaped plate which is spliced on the main web plate. As shown in Fig. 64, the splice between these plates is located 3 ft. from the center line of the truss. It was found by means of eq. (3), p. 316 that the existing shear and moment at the splice called for two rows of rivets spaced at $3\frac{1}{2}$ in. on each side of the splice. The splice plate was made of the same thickness as the flange angles in order that it might also act as a filler for the end connection angles. Also, by running these splice plates back to the end connection angles, they serve as additional web area to replace the portion of the web which has been cut away.

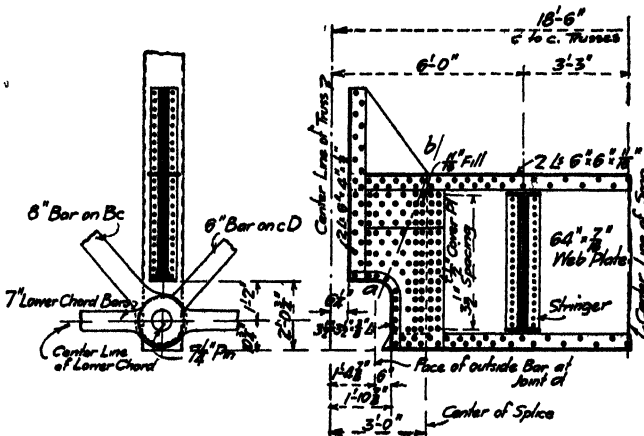

FIG. 64.

The rivets connecting the top flange angles to the web plate between the truss and the stringer must develop the flange stress at the stringer. At the stringer, the total moment is found to be 17,390,000 in.-lb. This moment is slightly greater than for the riveted truss due to the increased truss spacing. The top flange stress at the stringer is $\frac{(17,390,000)(15.56)}{(80.75)(20.23)}$

= 219,000 lb. and $\frac{219,000}{9,190} = 24$ rivets are required in bearing on the web plate. Since the end of the lower flange angles has been cut away, there is available a much shorter length in which to place the required rivets than in the case of the top flange. However, by placing a $\frac{1}{2}$ -in. cover plate over the lower portion of the web and extending the cover plate to cover the outer end of the lower angles, as shown in Fig. 64, the rivets passing through the cover plates and the lower angles are in quadruple shear and have a value of 28,880 lb. per rivet. As shown in Fig. 64, the lower angles contain 6 rivets in quadruple shear and 12 rivets in bearing on the web plate. These rivets have a total value of 283,560 lb. At the splice, the stress in the lower flange is 109,500 lb. The four rivets shown to the left of the splice are sufficient to provide for the existing flange stress.

Since the flange angles have been cut away at the lower corner, the web plate, and its reinforcing plates must carry the bending moment. To estimate the bending stresses on this portion of the web, the fiber stress on a section such as *a-b*, Fig. 64, must be investigated. It was found that the extreme fiber stress for the plates shown in Fig. 64 was about 10,800 lb. per sq. in. If in any case this fiber stress is found to be in excess of 16,000 lb. per sq. in., additional plates must be provided until the fiber stress is within allowable limits. The design of the end floor beam is carried out in a similar manner. Figure 50 shows the adopted details.

STEEL HIGHWAY BRIDGES

10. General Considerations.—Many different conditions are met in highway bridge work. The character of the stream in high water periods must be considered in determining the type of structure to be used for a given crossing. Some streams are entirely free from floating brush, logs, stumps, etc. The clear headroom between high water and the low steel in the bridge need not be great and deck spans may be used. Other streams flowing through an unsettled country may carry considerable drift. In such cases considerable clear headroom must be provided and a through span must be used.

The width of roadway generally used is not less than 22 ft. It is usually required to be not less than 4 ft. greater than approach pavement width.

Plate girders and low trusses are used extensively in highway bridge work for spans from 50 to 85 ft. For spans over 85 ft. long, high truss-spans are used. The depth of plate girder spans is generally taken as about one-twelfth of the span. For low truss spans the distance between chords is taken as about one-tenth of the span length for 16-ft. roadway and about one-ninth for 18 and 20-ft. roadways. The depth of high truss spans is made about one-fifth or one-sixth of the span length.

11. Loadings.

11a. Dead Load.—The dead load shall consist of the structure complete. Various formulas for estimating the weight of plate girders and low truss spans have been proposed. In "Modern Framed Structures" Johnson, Bryan and Turneure recommend the formula

$$w = 0.05L \sqrt{p} + 50$$

for highway bridges with 16-ft. roadways; in which p = the live load in pounds per linear foot, L = the length of span in feet, and w = the weight in pounds per foot of one truss. w includes the weight of floor beams but not that of stringers and slab. The formula can be made to apply to other widths of roadway by adding or subtracting an amount per foot equal to $0.2L$ for each 2-ft. change of width.

11b. Live Load and Impact.—Plate girders and trusses should be designed to conform to the Standard Specifications for Highway Bridges prepared by the American Association of State Highway Officials. According to these specifications live loadings on the roadway of bridges or incidental structures shall consist of standard trucks or of lane loadings that are equivalent to truck trains. Two systems of loadings are provided, the H loadings and the H-S loadings, the corresponding H-S loadings being heavier than the H loadings.

The H loadings are illustrated in Figs. 65 and 66. They consist of a four-wheel truck or the corresponding lane loading. The H loadings are designated H , followed by a number indicating the gross weight in tons of the standard truck. Each lane loading shall consist of a uniform load per linear foot of traffic lane combined with a single concentrated load so placed on the span as to produce maximum stress.

In computing stresses, each 10-ft. traffic lane loading or a single standard truck per lane shall be considered as a unit. The number and position of loaded

lanes and the type of loading—truck loading or lane loading—shall be such as to produce a maximum stress.

Loadings for sidewalks are generally specified as 85 lb. per sq. ft. Experience has shown that where freedom of movement is possible in a moving crowd of people, the load per square foot will not exceed about 40 lb. Cases of intentional crowding have been observed where loads of 150 lb. per sq. ft. have been obtained. This loading is exceptional, and probably would never be encountered in practice. It is possible that in case of accidents in the water near a bridge, crowds near the bridge railing might produce loads of 100 lb. per sq. ft. Since the portion of the crowd in the rear will be moving about in order to obtain a better view, it seems probable that an average load of 85 lb. per sq. ft. over the entire sidewalk area will represent maximum conditions.

Street car loadings are so varied in nature that it is difficult to present typical loading diagrams. The structure should be designed to meet the known or proposed local conditions.

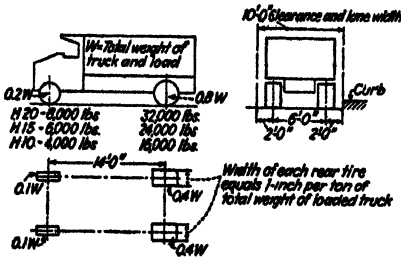

FIG. 65.—Standard H truck loadings.

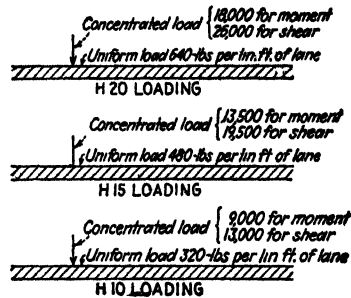

FIG. 66.—H lane loadings.

Impact allowances for highway bridges are sometimes determined by means of formulas, as in the case of railway bridges. The formula given by the American Association of State Highway Officials is

$$I = \frac{50}{L + 125} S$$

in which I = impact stress, S = live load stress, and L = loaded length in feet for maximum stress. The maximum value of I for highway loads is 30 per cent.

11c. Lateral Forces.—Wind pressures on highway bridges are generally assumed at 30 lb. per sq. ft. on $1\frac{1}{2}$ times the area of the structure as seen in elevation, including the floor system and railings. On the exposed surface of the truss, it is generally assumed that the horizontal forces for through bridges are not less than 150 lb. per lin. ft. for the top chord, and not less than 300 lb. per ft. for the lower chord. (These values are reversed for deck bridges.) It is also assumed that the wind pressure on the exposed surface of the moving live load is 200 lb. per ft. for highway bridges and 300 lb. per ft. for highway bridges carrying electric railway traffic; it shall be considered as acting 6 ft. above the roadway. All loads are generally considered as moving loads.

Centrifugal forces due to electric trains on curved track may be estimated by methods similar to those used for railway bridges.

12. Design of a Plate Girder Span.—The general methods used in the design of highway bridge plate girders are the same as used for the Design of Plate Girder Railway Bridges. To illustrate the methods used in highway bridge design, the computations will be given for the design of a 75-ft. through girder span. It will be assumed that the roadway is 22 ft. wide and that the floor system consists of a reinforced concrete slab supported on steel stringers and floor beams. The stringers will be spaced 2 ft. 6 in. centers and the floorbeams

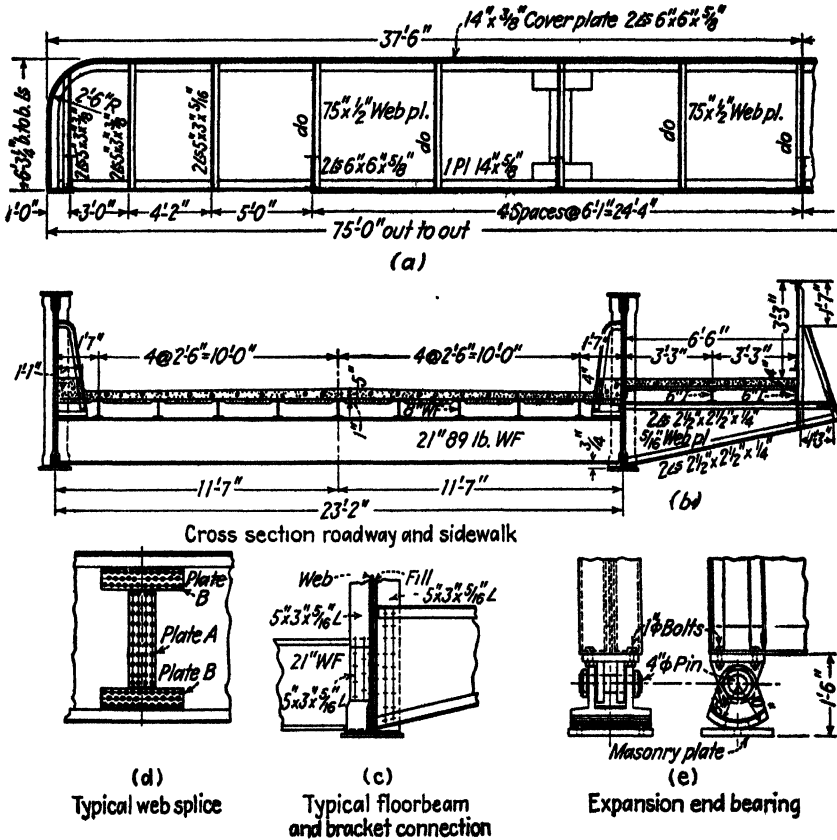

FIG. 67.—General drawing, 75-ft. plate girder highway bridge.

will be spaced 12 ft. 2 in. centers, as shown in Fig. 67. A sidewalk 6 1/2 ft. wide, supported on cantilever brackets, will be placed on one side of the roadway.

The working stresses used in the design will conform to those given in Standard Specifications for Highway Bridges by the American Association of State Highway Officials.

12a. Design of the Floor System.—Two types of floor systems are in common use for plate girders. In one system the concrete slab is supported by longitudinal stringers which in turn are supported by transverse floor beams. In the other system the floor slab is supported directly by closely spaced transverse floor beams. The latter floor system provides more headroom than the former, since the distance from the top of the floor to the lower flange is less when

transverse beams are used than it is when stringers and floor beams are used. In the design under consideration, the first mentioned type of floor will be used.

The floor slab will be made 6 in. thick and it will be reinforced with $\frac{1}{2}$ in. square rods placed 6 in. centers, as shown in Fig. 67(b). Computations will probably show that a 6-in. floor is excessively thick. However, the use of a thick slab is necessary, since the wearing surface for the roadway is also provided by the slab.

The longitudinal stringers are to be designed for the dead load due to the floor slab and the weight of the stringer itself, and for a live load due to an H15 loading shown in Fig. 65. Since the floor slab is 6 in. thick, its weight per foot of stringer is $(\frac{1}{2})(150)(2.5) = 187.5$ lb. Assuming an 8-in. 21-lb. WF beam stringer, the total load per foot is $187.5 + 21 = 208.5$ lb. Considering the stringer as a simple beam between floor beams, the dead load center moment for each stringer is $\frac{1}{8}(208.5)(12.17)^2(12) = 46,100$ in.-lb. The maximum live load moment will be found to occur when the rear wheels of the truck are placed at the center of the stringer. Proportion of wheel load on each stringer $\frac{2.5}{5}$

$\times 12,000 = 6,000$ lb. The live load moment at the stringer center is then $\frac{(6,000)(12.17)(12)}{4} = 219,000$ in.-lb. Applying the impact formula $I = \frac{50}{L + 125} S$

gives more than 30 per cent; therefore 30 per cent is used. The allowance for impact is then $219,000 \times 0.30 = 65,700$ lb. The total stringer moment is $46,100 + 219,000 + 67,500 = 331,600$ in.-lb. Assuming an allowable fiber stress of 18,000 lb. per sq. in., the stringer section must provide a section modulus of $\frac{331,600}{18,000} = 18.4$ in.³ This is only slightly over the 18 in.³ provided by the 8-in.

21-lb. WF beam, and no revision is necessary. As shown in Fig. 67, the stringers rest on the top of the floor beam. The stringers are fastened to the floor beam by means of two rivets at the end of each stringer. Using similar methods, it was found that a 6-in. 12.5-lb. I-beam stringer was required to support a 4-in. sidewalk slab under a live load of 80 lb. per sq. ft. At the edge of the sidewalk a 6-in. 8.2-lb. channel was used.

The transverse floor beam and the sidewalk bracket form a beam with an overhanging arm, as shown in Fig. 67(b). Figure 68 shows the loads in position for maximum stress in the floor beams between girders. The live load portion of the loads shown is obtained by placing the rear wheels of two trucks over the floor beam. This is equal to $12,000 \times 4 = 48,000$ lb. uniformly distributed over 20 feet.

As given above, the dead load per foot of stringer is 208.5 lb. Hence the dead load concentration at stringers 2 to 5 of Fig. 68(a) is $208.5 \times 12.17 = 2,530$ lb. For stringer 1, the dead load concentration is due to the weight of the slab, part of the curb, and the stringer. This load is found to be about 190 lb. per ft., or a total load of $190 \times 12.17 = 2,310$ lb.

The loads on the sidewalk bracket may be estimated from the details shown in Fig. 67(b). At the center of the bracket the dead load due to the 4-in. slab is $(\frac{1}{2})(150)(3.25)(12.17) = 1,980$ lb. and the stringer weight is $(12.5)(12.17) = 149$ lb., or a total of 2,129 lb. At the rail, the dead load concentration consists

of the following parts: slab $(\frac{1}{2})(150)(\frac{1}{2})(3.25)(12.17) = 990$ lb.; outside channel, $(8.2)(12.17) = 97$ lb.; railing and brace, 300 lb.; a total of 1,387 lb. The web plate of the bracket has an area of 5.8 sq. ft. and weighs 74 lb., and the flange angles have a total weight of 140 lb. These loads are applied at the center of gravity of the several members, as shown in Fig. 68(a). It can readily be shown that the resultant of all bracket loads is 3,730 lb., which acts 4.44 ft. from the right-hand girder, as shown by the dotted arrow.

For the loads shown in Fig. 68(a), the reaction at the left-hand girder is

$$R_1 = \frac{1}{2} [(2)(2,310) + (7)(2,530) + (2,400)(20)] - \frac{(3,730)(4.44)}{23.17} = 34,450 \text{ lb.}$$

This consists of a live load reaction of 24,000 lb. and a dead load reaction of 10,450 lb.

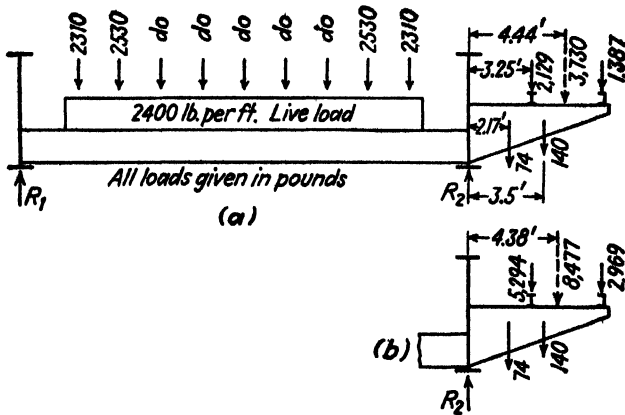

FIG. 68.

It will be found that the maximum moment occurs at stringer 5, where dead load moment is $10,450 \times 11.58 - [(2530)(1) + (2530)(2) + (2530)(3) + (2310)4]2.5 = 60,000$ ft.-lb. The live load moment is $24,000(11.58 - 5) = 158,000$ ft.-lb. Impact is $158,000 \times 0.30 = 47,400$ ft.-lb. Total $M = (60,000 + 158,000 + 47,000)12 = 3,180,000$ in.-lb. Assuming a 21-in. 89-lb. WF section for the floor beam, the dead load center moment is $\frac{1}{2}(89)(23.17)^2(12) = 71,300$ in.-lb. Hence the total moment at stringer 5 is $3,251,300^*$ in.-lb.

The section modulus required is $\frac{3,251,300}{18,000} = 180$ in.³ and the assumed beam

furnishes a section modulus of 182.8 in.³ The assumed beam will be adopted. Although the end floor beam carries a smaller load than the intermediate beams, the same section will be used for all floor beams.

In designing the brackets the sidewalk live load of 80 lb. per sq. ft. must be applied in addition to the dead loads shown in Fig. 68(a). At the center of the bracket, the live load concentration is $(3.25)(80)(12.17) = 3,165$ lb., and at the rail the live load concentration is one-half that at the center, or 1,582 lb. On adding these loads to the dead loads shown in Fig. 68(a), we have the concentrations shown in Fig. 68(b). The resultant of all loads on the bracket is found

to be 8,477 lb. applied 4.38 ft. from the girder, as shown by the dotted arrow in Fig. 68(b).

The bracket section consists of a web plate and flanges composed of two angles. At the center of the right-hand girder, the shear and moment carried by the bracket due to the loads shown in Fig. 68(b) are respectively 8,477 lb. and $(8,477)(4.38)(12) = 446,000$ in.-lb. The effective depth of the bracket section shown in Fig. 67(b) is about 25.3 in. at the point of maximum moment. Hence, assuming the moment as carried by the angles, the stress in the flange section is $\frac{446,000}{25.3} = 17,600$ lb. The net flange area required is $\frac{17,600}{18,000} = 0.98$ sq. in. Assuming $\frac{3}{4}$ -in. rivets, the adopted flange section shown in Fig. 67(b) provides a net area of 1.94 sq. in. At the point of maximum shear, the web area is about $(26.5)(\frac{5}{16}) = 8.28$ sq. in. Hence the shearing stress is $\frac{8,477}{8.28} = 1,020$ lb. per sq. in. Allowable shearing stress = 11,000 lb. per sq. in.

As shown in Fig. 67(c), the bracket is connected to the stiffener angles of the main girder by means of rivets which are subjected to shear and moment. If the lower flange angles of the bracket are made to bear against the flange angles of the main girder, it seems reasonable to assume that the resisting moment for the connecting rivets may be computed about a center assumed as located at the lower angles. Let r = stress on rivets in top bracket angles. For the conditions shown in Fig. 67(c) the top rivets are 24 in. above the lower angles, and 3-in. spacing is used for other rivets. Assuming the stress on a rivet to be proportional to its distance from the lower angles, it can readily be shown that the resisting moment of the rivets in place is $\frac{2r}{24} (3^2 + 6^2 + 9^2 + 12^2 + 15^2 + 18^2 + 21^2 + 24^2) = 153r$. As given above, the bending moment on the bracket is 446,000 in.-lb. Therefore, $153r = 446,000$, and $r = 2,920$ lb., which is the stress on the top rivets due to bending. Assuming the shear as carried uniformly by the rivets, the shear stress per rivet is $\frac{8,477}{18} = 470$ lb. Hence the resultant stress on the extreme rivet is $(2,920^2 + 470^2)^{\frac{1}{2}} = 2,950$ lb. For the arrangement shown in Fig. 67(c), the top rivets are field rivets in bearing on a $\frac{5}{16}$ -in. angle and the remaining rivets are field rivets in single shear. The values of these rivets are respectively 6,320 and 5,950 lb. Hence the stress on the rivets is within allowable limits.

12b. Design of the Main Girders.—The greatest moment under live load will be found to occur for the sidewalk loading of 80 lb. per sq. ft. and for a uniform load per linear foot of traffic lane combined with a single concentrated load so placed on the span as to produce maximum stress. From the A.A.S.H.O. specifications the uniform load per linear foot of lane for H15 loading is 480 lb. The concentrated load for moment is 13,500 lb., and for shear the load is 19,500 lb.

Figures 69(a) and (b) show the loads in position for maximum panel concentrations on the main girders. The dead loads on the main floor beam and the total dead and live load on the sidewalk bracket are the same as shown in Fig. 68(a). As shown in Fig. 67(b), the roadway between curbs is 21 ft. wide.

The live load consists of a uniform load of 480 lb. per lin. ft. over one-track lane of 10 ft., or 48 lb. per sq. ft., and a concentrated load of $2 \times 13,500 = 27,000$ lb. uniformly distributed over 20 ft. of floor beam six. These loads are shown in

Fig. 69(a). In addition to the dead loads on the main floor beam and the total dead and live load on the sidewalk bracket there is also shown in Fig. 69(a) a concentrated load of 5,390 lb. applied at the right-hand girder and 2,820 lb. at the left-hand girder. These loads are due to the weight of the portions of the floor slab and sidewalk live load which are carried directly by the main girders, and to the dead weight of the floor beam, which is also carried by the main girder.

The panel loads brought to the main girders are due to the floor beam reactions for the loads shown in Figs. 69(a) and (b). For the loading conditions shown, reactions R_1 and R_2 are unequal. The right-hand main girder will therefore receive greater loads than the left-hand girder, and it should be made somewhat stronger. However, it will probably be best to make both girders alike, using the section required for the right-hand girder.

For the dead loadings shown, $R_2 = \frac{\frac{1}{2}(2 \times 2310 + 7 \times 2530) + 5,390 + (8,477)(27.55)}{23.17} = 26,650$ lb. This load is the panel load for the right-hand girder due to the dead loads. The dead weight of the girder must be added. For girder spans of this type, the dead weight of the main girders in pounds per foot per girder is given approximately by the formula $w = 160 + L$, in which w = weight per foot and L = span in feet. Where the girder supports a sidewalk of the kind shown in Fig. 67, this weight should be increased 25 per cent. Hence, panel load due to weight of girder = $(\frac{1}{4})(160 + 75)(12.17) = 3,650$ lb. The total panel dead load is then $26,650 + 3,650 = 30,300$ lb.

For the live loadings $R_2 = \frac{(48 \times 12.17)20 \times 12.08}{23.17} = 6,100$ lb. This is a panel load for each panel point. $R_2 = \frac{27,000 \times 12.08}{23.18} = 14,100$ lb. This is the excess load to be placed at c , the center panel point. Maximum dead load moment at the girder center is $30,300 [(\frac{1}{2})(3) - (1 + 2)]12.17 \times 12 = 19,900,000$ in.-lb. Maximum live load moment at the girder center is $\{[(6,100 \times \frac{1}{2} + 14,100 \times \frac{1}{2}) \times 3 \times 12.17] - (6,100)(1 + 2)(12.17)\}12 = 7,100,000$ in.-lb. Moment due to impact is $7,100,000 \times \frac{50}{73 + 125} = 1,800,000$ in.-lb. Total moment is $19,900,000 + 7,100,000 + 1,800,000 = 28,800,000$ in.-lb. The complete moment diagram is shown in Fig. 69(b).

The maximum shear in the end panel occurs when all the panels are loaded with dead load and uniform live load and the excess live load for shear is at the first panel point.

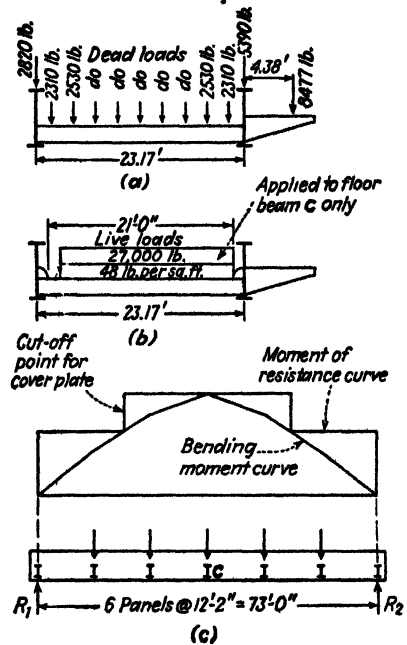

FIG. 69.

Dead load shear is $30,300 \times \frac{1}{2} = 75,500$ lb.

Uniform live load shear is $6,100 \times \frac{1}{2} = 22,300$ lb.

Excess live load shear is $\frac{19,500 \times 2 \times 12.08}{23.18} \times \frac{5}{6} = 16,950$ lb.

Total live load shear is $22,300 + 16,950 = 39,250$ lb.

Impact shear is $39,250 \times \frac{50}{73 + 125} = 9,900$ lb.

Total shear is $75,500 + 39,250 + 9,900 = 124,650$ lb.

The depth of the main girders will be taken as one-twelfth of the span length or 75 in., to conform to the depth requirements stated in Art 10, and the flange angles will be placed $75\frac{1}{4}$ in. back to back. To carry the end shear of 124,650 lb., as calculated above, the web area required is $\frac{124,650}{11,000} = 11.4$ sq. in. Using a $\frac{1}{2}$ -in. web plate, which is the minimum allowable by A.A.S.H.O. specifications, the web area furnished is $(75)(\frac{1}{2}) = 37.5$ sq. in.

A flange section consisting of two $6 \times 6 \times \frac{5}{8}$ -in. angles and one $14 \times \frac{5}{8}$ -in. cover plate will be assumed. Assuming $\frac{3}{4}$ -in. rivets, and deducting two rivet holes from the plate and two from each angle, the flange area is as follows: Cover plate, gross area 8.75 sq. in.; net area 7.65 sq. in.; angles, gross area 14.22 sq. in., net area 12.02 sq. in. If one-eighth of the web area be considered as available net flange area, the total available flange on the tension side is $7.65 + 12.02 + (\frac{1}{8})(75)(\frac{1}{2}) = 24.35$ sq. in.

The center of gravity of the assumed flange section is found to be 0.96 in. inside the backs of the angles. Hence the effective depth of the girder section is $75.25 - (2)(0.96) = 73.33$ in. Therefore, the required net area of the tension flange is

$$\frac{28,800,000}{(73.33)(18,000)} = 21.8 \text{ sq. in.}$$

The assumed section is sufficient with respect to the tension flange. For the compression flange, it is generally specified that the stress on the gross section shall not exceed $18,000 - 5 \frac{l^2}{b^2}$, in which l = unsupported length of top flange, and b = width of cover plate. As shown in Fig. 67, the top flange is supported at each floor beam by knee braces. Hence $l = 12.17$ ft. = 146 in. Also, $b = 14$ in., the width of cover plate. Hence the allowable unit stress is $18,000 - 5 \frac{(146)^2}{(14)^2} = 17,450$ lb. per sq. in. Assuming one-sixth of the web as available compression flange area, the total gross flange area is $8.75 + 14.22 + (\frac{1}{6})(75)(\frac{1}{2}) = 29.22$ sq. in. Hence the unit flange stress is $\frac{28,800,000}{(73.33)(29.22)} = 13,400$ lb. per sq. in. The assumed flange section is therefore satisfactory.

As shown in Fig. 67, the compression flange cover plate will be run full length of the girder. The allowable cut-off point for the lower flange cover plate is shown in Fig. 69b. This cut-off point is determined by the methods used on p. 304 for the railway plate girder span.

The rivet spacing in the flange angles and cover plates may be determined by the methods used for the railway girder spans. Since there is no vertical loading

on the flanges, eq. (5), p. 307 is to be used in determining rivet pitch in the vertical legs of the flange angles.

End stiffener angles must be provided which will transfer the total end reaction to the bearings. The maximum reaction occurs when the uniform live load extends over the entire span and the concentrated live load is at the end of the

span. The concentrated live load is $\frac{19,500 \times 2 \times 12.08}{23.18} = 20,300$ lb. Then the

end reaction $= (3 \times 30,300) + (3 \times 6100) + 20,300 = 129,500$ lb. The allowable bearing pressure on the foot of the stiffener angles is generally taken as 27,000 lb. per sq. in., and only the outstanding legs of the angles are to be counted

as bearing area. Hence, stiffener area required $= \frac{129,500}{27,000} = 4.8$ sq. in. The

arrangement shown in Fig. 67 provides excess area. Intermediate stiffeners composed of pairs of $5 \times 3 \times \frac{5}{16}$ -in. angles will be used, arranged as shown in Fig. 67. Stiffeners must be placed at each floor beam to provide means for connecting these beams and the sidewalk brackets to the main girders.

A web splice of the form shown in Fig. 67 (d) will be located in the position indicated in Fig. 67 (a). In designing a splice of this form, it is assumed that plate A carries the vertical shear at the splice and that plates B must be capable of developing the resisting moment produced by one-eighth of the web area considered as flange area. At the left of the splice the maximum shear will occur when the uniform live load is on the panels to the right and the concentrated

live load is at the splice. The shear is $\left[30,300 \times \frac{5}{2} + \frac{6100(1 + 2 + 3 + 4)}{6} + \right.$

$\left. 20,300 \times \frac{2}{3} \right] - 30,300 = 69,300$ lb. The rivets connecting plate A to the web

are in bearing on a $\frac{1}{2}$ -in. plate and have a value of 10,150 lb. per rivet. Hence $\frac{69,300}{10,150} = 7$ rivets are required on each side of the splice. The rivets shown in

position in Fig. 67 (d) are in excess of the number required. Not less than two vertical rows of rivets should be provided on each side of the splice.

One-eighth of the web area is $(\frac{1}{8})(75)(\frac{1}{2}) = 4.69$ sq. in. Considered as flange area, the equivalent resisting moment is $(4.69)(73.33)(18,000) = 6,160,000$ in.-lb. For the arrangement shown in Fig. 67 (d) the distance center

to center of plates B is 54.25 in. Hence the stress in each plate is $\frac{6,160,000}{54.25} =$

114,500 lb. The rivets connecting plates B to the web are in bearing on the $\frac{1}{2}$ -in. web. At the edge of the web plate these rivets have a value of 10,150 lb. per rivet.

Since the stresses in the web plate vary from a maximum value at the edges of the plate to zero at the center of the plate, the rivet values are subjected to a similar variation in value. Hence the value of a rivet at the center of plate B is $(10,150) \times$

$\left(\frac{54.25}{73.33} \right) = 7,500$ lb., and $\left(\frac{114,500}{7,500} \right) = 16$ rivets are required on each side of the

splice. The area furnished by plates B must be at least equal to one-eighth the web area. Plates of the minimum allowable thickness will be found sufficient.

The adopted end bearing details are shown in Fig. 67 (e). One end of the girder rests on a rocker bearing and the other end is bolted to the masonry.

The allowable bearing pressure per inch of rocker is equal to $\frac{p - 13,000}{20,000} \times 600d$, where d = diameter of rocker in inches and p = yield point in tension of steel in the roller or the base, whichever is the lesser. Assuming a rocker with a 10-in. radius, the allowable bearing pressure is $\frac{33,000 - 13,000}{20,000} \times 600 \times 20 = 12,000$ lb. per sq. in. As calculated above, the total end reaction is 129,500 lb. and the length of rocker required is $\frac{129,500}{12,000} = 10.8$ in. A 14-in. rocker will be used. All details are as shown in Fig. 67 (e). To transfer the reaction to the masonry, assuming the allowable bearing pressure on the masonry to be 700 lb. per sq. in., the area of the masonry plate must be $\frac{129,500}{700} = 185.0$ sq. in. A 12 × 16-in. plate will provide sufficient area.

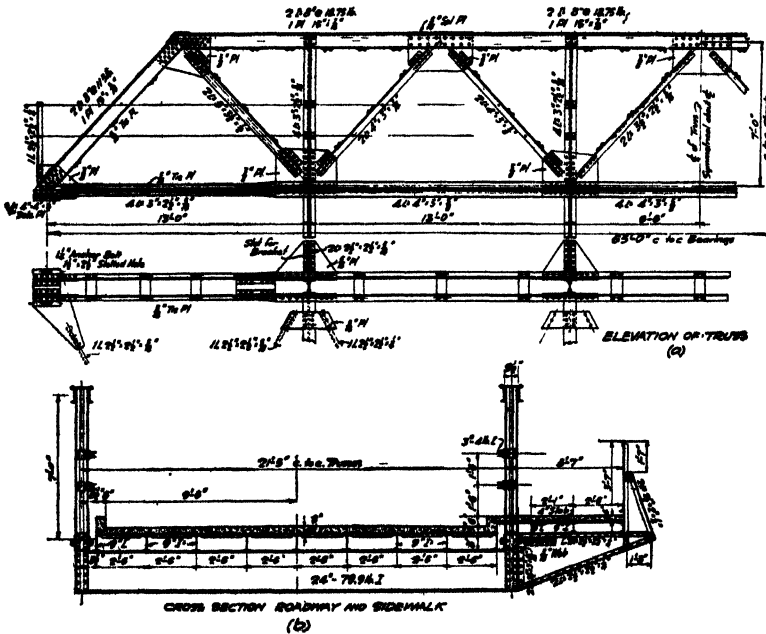

Fig. 70.—General drawing, 65-ft. highway bridge span.

13. Riveted Low Truss Highway Bridge.—Figure 70 shows the general drawing for a 65-ft., riveted, low truss highway bridge span. A 20-ft. roadway and a 5-ft. sidewalk are provided. This is a 2-ft. narrower roadway than permitted by the 1941 Standard Specifications for Highway Bridges of the A.A.S.H.O. In order to comply fully with these specifications, the live load should consist of a standard H truck loading or H lane loading. The working stress for tension members should be 18,000 lb. per sq. in., and the shearing and bearing stresses for rivets 13,500 and 27,000 lb. per sq. in. respectively. The allowable working

stress for compression members should be computed from the formula $15,000 - \frac{1}{4} \frac{L^2}{r^2}$ subject to the condition that $\frac{L}{r}$ must not exceed 140.

Since the general methods used in the design of the floor system are the same as given in Art. 12a for the plate girder span, this work will not be repeated here. Note that the sidewalk bracket is connected to the main truss by rivets in the vertical connection angles, which carry the shear, and by a horizontal gusset plate which is riveted to the lower chord angles. This gusset plate places the connecting rivets in bearing and avoids the use of rivets in direct tension.

The stresses in the main truss members will be determined for the truss which supports the sidewalk. Both trusses will be made alike. For the conditions shown in Fig. 70 (b) it can be shown that the panel load due to the dead weight of the floor system is 11,730 lb. The sidewalk and its supports weigh 4,570 lb. per panel. This load may be considered to act 3.1 ft. outside the truss center.

Hence the panel load at the truss due to the sidewalk dead load is $(4,570) \frac{24.5}{21.4} = 5,230$ lb. The panel load due to the weight of the floor system is 16,960 lb. The dead weight per foot of truss may be estimated from the weight formula given in Art. 11a or by the formula $w = 120 + 0.5L$. Using the latter formula for a truss with a 20-ft. roadway, $w = 120 + 0.5L = 120 + (0.5)(65) = 152.5$ lb. This load should be increased about 20 per cent to account for the presence of the sidewalk. Hence truss dead panel load = $(1.2)(152.5)(13) = 2,380$ lb. Total dead panel load = 19,340 lb.

TABLE 21.—STRESSES IN MEMBERS

Member	Dead load stress	Live load stress	Total stress
L_0L_1	+ 36,000	+ 36,700	+ 72,700
L_1L_2	+ 89,900	+ 91,600	+181,500
L_2L_3	+107,800	+110,000	+217,800
U_1U_2	- 72,000	- 73,500	-145,500
U_2U_3	-107,800	-110,000	-217,800
L_0U_1	- 52,700	- 53,900	-106,600
U_1L_1	+ 52,700	+ 53,900	+106,600
L_1U_2	- 26,350	- 32,300	- 58,650
U_2L_2	+ 26,350	+ 32,300	+ 58,650
L_2U_3	0	± 16,150	+ 16,150

+ = tension - = compression

The live load to be used in designing the truss is a uniform loading representing ordinary traffic conditions. The load varies with the span length and for a 65-ft. span is taken as 112 lb. per sq. ft. of floor. Hence the truss panel load due to live load on the highway floor is $(\frac{1}{2})(112)(19)(13) = 13,850$ lb. The sidewalk load is 80 lb. per sq. ft. Considering the effective width of the sidewalk as 5 ft., the sidewalk panel load is $(5)(80)(13) = 5,200$ lb. If this load be assumed as

applied 2.8 ft. outside the truss center, the panel load at the truss due to the sidewalk load is (5,200) $\left(\frac{24.2}{21.4}\right) = 5,880$ lb. Hence the total live panel load is 19,730 lb. Table 21 gives the dead load, live load, and total stresses in all members of the truss for these panel loads.

TABLE 22.—DESIGN OF TENSION MEMBERS

Member	Stress	Area required	Section	Net area provided	Rivets at joints	
					Rivet value	Number required
U_1L_1	106,600	6.67	2 \square 5 \times 3 $\frac{1}{2}$ \times $\frac{1}{2}$ in.	7.18	5,300	20
U_2L_2	58,650	3.67	2 \square 4 \times 3 \times $\frac{3}{8}$ in.	4.10	5,300	12
L_0L_1	72,700	4.55	4 \square 3 \times 2 $\frac{1}{2}$ \times $\frac{5}{16}$ in.	5.44	5,300	14
L_1L_2	181,500	11.35	4 \square 4 \times 3 \times $\frac{5}{8}$ in.	13.76		
L_2L_3	217,800	13.60	4 \square 4 \times 3 \times $\frac{5}{8}$ in.	13.76		

Tables 22 and 23 contain all data necessary for the design of the main truss members. The allowable working stress for tension members is taken at 16,000 lb. per sq. in. on the net section. The allowable working stress for compression members is computed from the formula $15,000 - 50 \frac{l}{r}$ subject to the conditions that $\frac{l}{r}$ must not exceed 120 and that the allowable working stress is not to exceed 12,500 lb. per sq. in. In computing the rivets required at the joints, the shearing value of a rivet is taken at 12,000 lb. per sq. in. and its bearing value at 24,000 lb. per sq. in.

TABLE 23.—DESIGN OF COMPRESSION MEMBERS

Member	Stress	l	r	Work- ing stress	Area re- quired	Section	Area pro- vided	Rivets at joints	
								Rivet value	Number required
L_0U_1	106,600	114.5	3.15	12,500	8.52	2 \square 8-in. 11.5 lb. 1 plate 15 \times $\frac{5}{16}$ in.	11.39	5,300	20
L_1U_2	58,650	114.5	1.25	10,370	5.66	2 \square 4 \times 3 \times $\frac{5}{16}$ in.	5.76	5,300	12
L_2U_3	16,150	114.5	1.11	9,860	1.64	2 \square 3 $\frac{1}{2}$ \times 2 $\frac{1}{2}$ \times $\frac{5}{16}$ in.	3.56	5,300	4
U_1U_2	145,500	78.0	Same as U_2U_3	5,300	28
U_2U_3	217,800	78.0	3.03	12,500	17.40	2 \square 8-in. 18.75 lb. 1 plate 15 \times $\frac{5}{16}$ in.	17.58		

Since a truss of the size under consideration may readily be transported to the bridge site in a single piece, all main truss joints have been made shop riveted.

A top chord shop splice is placed at joint U_2 . Such splices have milled bearing surfaces, and only enough rivets are required to hold the members in line. The lower chord member is spliced just to the left of joint L_1 . As shown in Fig. 70, members L_1L_2 and L_2L_3 are made continuous. This provides excess area for member L_1L_2 , but avoids the splicing of the member. The splice as located occurs where the chord stress is smallest.

SECTION 4

TIMBER BRIDGES AND TRESTLES

1. General Considerations.—The only excuse for a timber bridge is that it is cheaper than some other form of construction. It is less durable than either steel or masonry. It cannot be built in as long a span as steel. It is the least resistant to fire of any type of construction. It has, however, the advantage of cheapness for ordinary loads and spans, and as timber is usually found in abundance in new localities, it is made use of for the earliest of the bridges to be built. As these new localities in the early days did not need to provide for the heavy loads of the present day, the problem of building a timber bridge was a comparatively simple one. The loads were light; no excessive length of life was looked for; cast iron was usually not available for bearing blocks; and timbers long enough for chords without splices could be had. The problem was merely one of framing the timbers into each other and bolting up, and then tightening the tension rods until the desired camber was obtained. With the advent of the locomotive, the timber bridge began to require careful study and there was developed the cast-iron bearing block for all joints, the stiff lateral system, the multiple piece chords and webs, the steep diagonals and numerous counters, and other details that are now the earmarks of sturdy Howe Truss design.

Until very recently highway loadings were not studied with any seriousness. Most of the old timber bridges would stand the load of a 10- or 12-ton traction engine without failure and the old methods were considered good enough. For this reason, it is very hard to bring bridge builders of the old highway school to realize the necessity for the immense amount of lumber employed in a wooden bridge capable of carrying the present day traffic.

An analysis of the details of almost any wooden highway bridge over 20 years old will disclose conditions of stress that make it difficult to understand why it has not failed years ago. There are two answers: (1) That the computed load has probably not been realized, and (2) that the ultimate strength of the timber is better than anticipated. The most convincing argument against the older types of wooden highway bridge construction is usually a comparison of the present day highway loadings with the early locomotive loadings. It is seen that the heavy motor truck of today is as heavy as the railway engine of the early days and that the axle loading is as heavy as an ordinary electric interurban car of today. It is this greatly increased weight that calls for a far more careful consideration of the details of the wooden highway bridge than was customary a few years ago. The tendency of the wooden highway truss is more and more toward the old railroad Howe truss with certain modifications of width, height and panel length to suit the different class of traffic.

The actual selection of the sizes of the truss members is by far the smallest part of the work of designing a timber bridge. It is the careful working out of

the joint details and those of the splices and bracing that make the difference between a bridge which will be rickety and loose-jointed in a few years and one which will endure for a generation or more.

This attention to detail and consideration of heavier loadings has increased the cost of the timber truss bridge to such an extent that the steel truss bridge can usually show a very nearly equal first cost when the bridge is to be located near a railroad or other adequate means of transportation, allowing the materials for the steel bridge to be delivered at the site with a minimum of handling.

There are bridges to be built, however, where the loads are light and where lumber and timber is cheap and in these localities the timber bridge will continue to be the best type. When properly protected from climate and other deteriorating influences it has a very long life.

The foregoing paragraphs refer to the truss bridge in particular. The trestle bridge of timber has always and will doubtless continue to be far cheaper in first cost than any other type—even when built amply strong for today's loadings and given an ornamental treatment in keeping with the rest of the structures along the highways. It has been repeatedly demonstrated that a first class timber trestle can be built, maintained and replaced every 15 years (the estimated life of such a structure) for less than the interest on the investment required to build a truly permanent structure such as a concrete viaduct.

Very careful study should therefore be given to the question of whether a wooden bridge or some other type should be built at a given location, and if it is decided that the wood is preferable, there are several very important considerations which the designer should keep in mind in order to have a proper conception of the broader aspects of his problem.

2. Factors Affecting Design and Construction.—The basic idea which must be borne in mind by the designer of timber structures is that the material with which he is working will be subject, after its erection, to deteriorating circumstances over which he can have no further control.

In the case of masonry and metal structures, resort may be had to protective coatings which will prevent the elements from damaging the structural properties of the materials employed. The close inspection and frequent painting of exposed steel work will preserve the original size and strength of the members, and therefore prolong the life of the structure indefinitely. Concrete and stone structures are not subject, in so great a degree, to the action of the weather and if they do spall or show signs of weathering, the use of the Cement Gun will very readily restore the original section and strength.

In the case of structural timbers, there is no certain method of preventing season checks and even the prevention of warping due to the seasoning is beyond control. The fact that specifications for timber structures call for the use of thoroughly seasoned timbers, does much to reduce the liability of trouble from this cause, but does not relieve the designer of the responsibility for making provision, as far as possible, against the failure or deterioration of the structure as a result of checking or warping due to seasoning. Probably the most important factor in the above phenomena is that wood unlike almost any other structural material does not have the same strength in all directions. In other words, the wood has a grain which requires that the timber must be placed with the grain in a certain direction to gain the most benefit from the material. This appears so elemental

and self-evident as to be ridiculous when applied to long timbers, but it must be borne in mind that small blocks of wood form a very important part of every timber bridge and it is very difficult to impress the ordinary workman with a proper appreciation of the stress that may come upon these small but all-important portions of the structure.

It is this grain that allows abutting ends of compression members to seat themselves into each other, thereby causing a shortening of the original length and perhaps a sag in a truss. It is the grain that causes edge grain bridge flooring to wear longer and sliver less than slash or side grain. It is grain that tells whether a given size spike will split a board when driven, or go through and hold. It is on account of the grain that boat spikes are made with a chisel point to be placed across the grain so that they cut the fibers of the wood instead of spreading them and splitting the piece. The fact that wood is composed of longitudinal laminae of alternate hard and soft wood, causes timber to shrink more across the grain than endwise. These same alternate hard and soft streaks, called summer and spring wood, give a cushioning effect under loads above the elastic limit which are transverse with the grain, thus preventing sudden failure and allowing the timber to crush slowly and carry greater load. This same slow crushing, accompanied by separation of the fibers through longitudinal shear, makes it impossible to determine accurately the shearing strength of timber at right angles to the grain.

Timber, therefore, as a structural material must be so placed that its greatest stress is with the grain. As all structures with rigid joints are subject to secondary stresses, a structure of wood should always be considered as pin-jointed. This does not mean that pins should be used in the construction, but that the structure should be so detailed that slight angle changes will not induce secondary stresses. It is, of course, impossible to eliminate entirely the secondary stresses from the chord members as they are continuous past the panel points and must take bending due to the angle changes from distortion. The use of the angle block or dapped end for the intersections of the web members permits them to rock slightly on their bearing without taking bending. This action eliminates the secondary stress in the web members and lessens the secondary stress on the chords. In localities where only small boards are obtainable, an attempt is sometimes made to build truss members of laminated plank and imitate riveted joints at the connections. This is frequently disastrous as the small angle changes due to deflection of the truss tend to pry the fibers of the wood apart around the bolts and the whole value of the connection is then lost. Figure 1 represents a joint of this type which gave way under ordinary load, allowing the end post to push out along the top of the chord and the chord to pull out from the fish plates. Laminated timber can be successfully used for trusses where protected from the weather, but extra care should be taken to see that the details are not weaker than the main members.

In addition to the above basic idea, there are several other important considerations which are more or less under the control of the different persons who will be connected with the production of the material, the design, fabrication, erection and finishing of the structure. The deeper the appreciation of the designer for the problems of these different processes, the greater are the chances that the resulting structure will be consistent in design, low in first cost and in main-

tenance, and possessed of the long life that should be an inherent part of every timber structure.

These different considerations are so inter-related and dependent, one upon another, that any attempt to assign them a relative importance would be almost certain to give the reader a false perspective of the problem. For clearness of presentation, the points will be grouped as nearly as possible under the heads of: (1) Materials, (2) length of life desired, (3) nature and extent of loads to be carried, (4) skill of available labor, (5) equipment available for erection, (6)

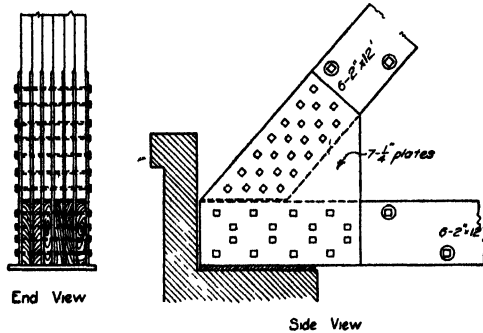

FIG. 1.

method of erection likely to be followed, and (7) deteriorating conditions at bridge site. These considerations are of such a nature that all of them are applicable to the study of any type of timber construction. They will, therefore, be taken up in turn and elaborated upon in this article and then referred to in the succeeding detailed portions of the chapter wherein the different kinds and types of timber bridges are treated.¹

The discussion under the first three headings should be considered as an outline of the causes affecting the selection of the unit stresses to be used in the design. The kind of timber selected, its condition at the time of framing, the thoroughness or lack of inspection during its manufacture, the purpose to which the resulting structure is to be put, the nature of the loads it will be called upon to sustain—are all items affecting the selection of the proper safety factor, and through that safety factor combined with the experimentally determined ultimate strength of the material in question, dictating the permissible unit stresses to be used. As such, they should be considered previous to the starting of the actual design. The questions which have a direct bearing upon the actual details and method of framing employed to secure the finished result are such as the skillful-

¹There are numerous other considerations which bear upon the problems of selecting, designing, building and maintaining a timber structure at any given location. Insofar as they are inseparably dependent upon the nature of the materials used, an attempt will be made to mention them, but when they are applicable to all types of construction of masonry, wood or steel alike, they have no particular place in this chapter and consequently will not be dwelt upon. Included in this elimination will be such questions as waterway area required, possibility of bank erosion and protection therefrom, considerations affecting the selection of a skew bridge in preference to a square crossing or vice versa, and kindred problems.

ness of the available labor, the kind of equipment with which it will be necessary to do the work, the method of erection most likely to be used, and the climatic or other deteriorating influences which surround the structure.

2a. Materials.—The designer must know first what species of timber is to be used for the main members, and secondly, the kind of material to be used in making the joints and fastenings. If the joints are to be framed without the use of metal angle blocks, it may still be possible to obtain and use angle blocks of some denser wood and, failing in this, the joints may be framed advantageously by using blocks of the same wood of which the structure is framed and turning the grain of the block in such a direction as to materially increase the strength of the joint. Lowest in point of strength is the oldest type of framed joint—that is, the one in which the intersecting main members are framed into each other on the angle and without recourse to any device for increasing the strength of the detail.

Knowing the species of wood to be used, the question of the condition of the wood at the time of fabrication becomes important. Green timber will shrink, lose weight, crack, warp and check due to seasoning, and all of these phenomena should be considered in the preparation of the design. The available size and length of individual pieces often plays a large part in the selection of panel lengths in truss bridges and spans of trestle bridges. It may be possible to obtain sawed timbers only in short lengths in a locality where hewed chord pieces can be had in extremely long lengths. These are questions which vitally affect the selection of the economic type of bridge for a given location. The availability of first class inspection is a guarantee that only fit material will be used in important parts while the lack of inspection forces the designer to take extra precautions in regard to the factors of safety used and, on account of the probability of inferior material, prevents his taking advantage of the full strength of what first grade material might find its way into the structure.

2b. Length of Life Desired.—Knowing the species of timber to be used for main members, its condition at the time of fabrication, the probabilities for and against it being first or second grade, and the kinds of materials to be used for details, the next question is whether or not the extreme life of the wood must be realized in the finished structure. If it is to be a trestle or truss on a highway or railway, the longest possible life is desirable from each and every piece of the finished work. On the other hand, if the structure is to be of a temporary nature, such as the falsework for a steel or concrete structure, the life of the structure or its individual parts is of secondary importance to its strength as first erected. Higher unit stresses are permissible in temporary structures on account of the fact that there is less danger of season checks or unforeseen loads injuring the structure and the danger from deterioration is practically negligible except in certain localities where the action of wood boring insects must be guarded against, as in the case of temporary trestles in teredo or limnoria infested waters.

2c. Nature and Extent of Loads to be Carried.—The extent to which the unit stresses for design may be increased on account of the nature of service desired from the finished structure depends, of course, upon the relative length of service desired as compared with the extreme limit of life of the timber under consideration. The usual factor of safety for long-life construction is four for housed or otherwise protected structures, and five to six for structures unpro-

tected from the action of the elements. The factor of five is common for highway construction and open frame structures such as wharves and docks, while railway and other heavily loaded structures, especially where failure would endanger human life, usually call for a safety factor of six as well as a very much more rigid inspection at the saw mills and during framing and placing. In the case of highly temporary structures, this factor may be reduced to three in general, and some parts of the details even allowed to work very close to their elastic limit when it can be shown that partial failure will only result in bringing more material into play, thus preventing further or complete failure. An exception to this rule should be noted in the consideration of forms and falsework for concrete construction where deflection under the load of wet concrete is the controlling factor in many cases. But even in this class of construction, considerably higher unit stresses are permissible when the deflection of the piece is not of importance as related to the whole structure. On p. 380 is given the Table of Allowable Unit Stresses for Structural Timber, and on p. 381 is given the Table of the Allowable Unit Stresses for Structural Timber Columns as given by the Forest Products Laboratory, Department of Agriculture. The strength of wood is influenced considerably by its moisture content. For wet locations the allowable working stresses should be reduced according to conditions and timber used. Recommendations covering specific cases may be obtained from the Forest Products Laboratory.

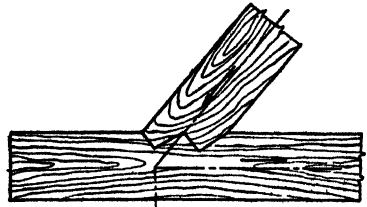

FIG. 2.

2d. Skill of Available Labor.—The more skillful the labor which can be obtained, the more intricate may be the details of framing employed and, conversely, the less skillful the labor, the simpler must be the joints. The greatest difficulty is always encountered in framing a joint whose value is dependent upon two or more separate steps coming into play at the same time. This detail

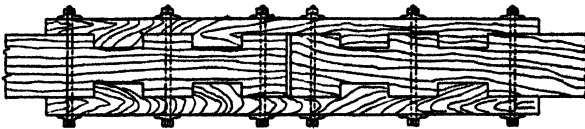

FIG. 3.

should be avoided wherever possible, and where unavoidable, should be made by the most skilled bridge carpenter obtainable. The best known examples of this class of framing are the end post and lower chord joint in a Howe truss (Fig. 2) and the multiple tabled splice plate for tension (Fig. 3). A very simple joint and one that requires a minimum of exactness in its execution is that shown in Fig. 4. It can be detailed to give fully as low stresses as the one shown in Fig. 2, and has the advantage that only one surface need bear to bring the block into full play. It will also be noted that all cuts on the main members are square cuts and that there are no diagonal re-entrant cuts to make on the truss members or on the blocks. Such cuts are not too difficult for the ordinary laborer and can be satisfactorily employed where a competent foreman is on hand to supervise the work.

While the joint shown in Fig. 2 is sometimes permissible in cases where high class carpenters are available, it is only because the partial failure of one surface will bring both to bear and perhaps prevent further breaking down. In the splice joint of Fig. 3 is shown a detail that has been very commonly used by bridge carpenters for splicing lower chords. It is extremely difficult to frame such a splice in a manner that will bring all surfaces tight at the same time and even if so framed, it is still subject to the criticism that it is prone to crack with seasoning and the tables fail to develop their expected shear. It is very probable that a tightly bolted plain timber as in Fig. 5, would develop as great a tensile value through friction of the adjacent pieces as the season checked pieces of the one in Fig. 3 after both had been in service for a number of years. (Figure 5 is a typical compression splice in a top chord of two pieces. It is merely introduced here to be used as a comparison with Fig. 3.)

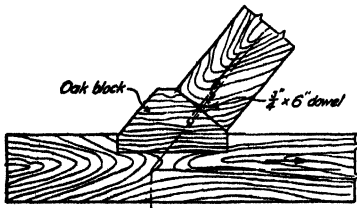

FIG. 4.

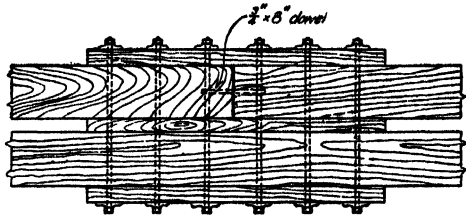

FIG. 5.

2e. Equipment Available for Erection.—The question of erection equipment will determinè the method to be followed in framing the truss—whether it is to be completely assembled flat and raised into place as a whole, or whether the floor beams will be strung out along the false work, the bottom chord laid on them, the top chord set on false work and the web system cut in between. If the truss is to be assembled flat and raised, the floor beams will very likely be rested on the bottom chord, thus calling for more distance between chords to secure the same clear height for the roadway. If on the other hand, the bottom chord is to be placed on the floor beams which are made part of the false work, the floor beams must be supported below the chord either by hanging them to the main rods, or by devising a separate fastening for them. The erection equipment will in many cases determine the size of timbers which can be used. Where ample power is available, quite large timbers can be used to advantage, but where all work is by hand, it may prove more economical to use smaller pieces and more of them.

2f. Method of Erection Likely to Be Followed.—The question of method to be followed in erection is one about which little concern need be felt in the designing office of the ordinary firm where nothing can be known of the erector until after a contract is let. For purposes of obtaining the desired camber, it is essential that the designer know the method to be followed or else leave the whole camber question to the erector, merely specifying the result desired. If the old established rule of $\frac{1}{4}$ -in. increase in length per each 10 ft. be applied to the top chord, the exact lengths of the diagonals must be computed and put on the drawings. This will not even then give the desired result unless the distance from the intersection point of the members to the face of the diagonal

timber is exactly right—a condition rarely obtained when using cast-iron blocks and well nigh impossible when using a framed joint of the style of Fig. 1. Again if the erector is in the habit of erecting the top chord on falsework and cutting the diagonals into place by a template, no extra length of top chord is necessary because he will set the bottom chord to the correct camber and having cut in the diagonals to fit snugly, will raise the bridge clear of the blocks by tightening on the tension rods, thus taking up the dead load. These questions are merely mentioned here to impress the reader with the fact as before stated that the designer must know the erection methods and equipment to be used in order to design intelligently any wooden structure.

2g. Deteriorating Conditions at Bridge Site.

The question of location and deteriorating conditions attendant thereon is one of vital interest to the designer. Some classes of wood as well as metals have peculiar properties, allowing them to resist certain influences which readily destroy other woods. Again some woods which readily decay under certain circumstances will be rendered very durable by certain preservative treatments. In the third place, it is possible to lessen the deterioration of the structure as a whole by substituting more durable woods at vulnerable points and using ordinary timber for the greater parts of the structure. The need of such protection as sheet metal fire and smoke guards where railways pass under wooden viaducts is too self-evident to call for more than mention.

These questions, again, are briefly brought out here in order to summarize the controlling points in design for the benefit of the reader and will be discussed under the different sections of this chapter as they apply to the questions under consideration.

Following are the U.S. Forest Products Laboratory tables of Allowable Unit Stresses for Structural Timbers. For a table of the ultimate values of different woods, the reader is referred to the Wood Handbook prepared by the Forest Products Laboratory, U.S. Department of Agriculture.

It will be noted that the compression perpendicular to the grain is roughly one-fourth of that parallel to the grain for short pieces. It naturally occurs that for angles of bearing between 0 and 90 deg. there must be decreasing values that depend upon the angle to the grain at which the load is applied. Extensive tests have been made and much has been written on the subject, several different empirical formulas having been established for determining this bearing value on inclined surfaces. One of the more recent of these is the Hankinson formula (U.S. Army, Engineering Division) which is

$$N = \frac{PQ}{P \sin^2 \theta + Q \cos^2 \theta}$$

In the formula N = the allowable unit stress on the inclined surface, P = the unit stress in compression parallel to the grain, Q = the unit stress in compression perpendicular to the grain, and θ = the angle between the direction of the load

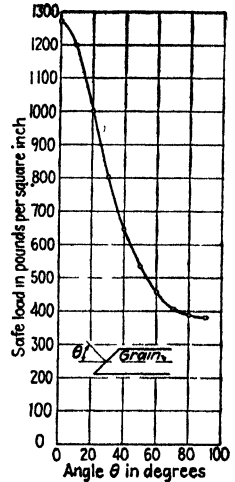

FIG. 6. --Inclined bearing on Douglas fir.

TABLE 1.—ALLOWABLE UNIT STRESSES FOR STRUCTURAL TIMBER¹
(Pounds per Square Inch)

Species of timber	American standard grade	Bending stress		Compression stress		Modulus of elasticity
		In extreme	Horizontal	Parallel	Perpendicular to grain	
Cedar, western red.....	Select	900	80	700	200	1,000,000
	Common	720	64	560	...	
Cedar, northern and southern white.....	Select	750	70	550	175	800,000
	Common	600	56	440	...	
Cedar, Port Orford.....	Select	1,100	90	900	250	1,200,000
	Common	880	72	720	...	
Cedar, Alaska.....	Select	1,100	90	800	250	1,200,000
	Common	880	72	640	...	
Cypress, southern.....	Select	1,300	100	1,100	350	1,200,000
	Common	1,040	80	880	...	
Douglas fir, Coast region (western Washington and Oregon).	Dense select	1,750	105	1,285	380	1,600,000
	Select	1,600	90	1,175	345	
	Common	1,200	72	880	325	
Douglas fir, Rocky Mountain region....	Select	1,100	85	800	275	1,200,000
	Common	880	68	640	...	
Fir, balsam.....	Select	900	70	700	150	1,000,000
	Common	720	56	560	...	
Fir, golden, Noble, silver, white (commercial white).	Select	1,100	70	700	300	1,100,000
	Common	880	56	560	...	
Hemlock, west coast.....	Select	1,300	75	900	300	1,400,000
	Common	1,040	60	720	...	
Hemlock, eastern.....	Select	1,100	70	700	300	1,100,000
	Common	880	56	560	...	
Larch, western.....	Select	1,200	100	1,100	325	1,300,000
	Common	960	80	880	...	
Oak, commercial white and red.....	Select	1,400	125	1,000	500	1,500,000
	Common	1,120	100	800	...	
Pine, southern yellow.....	Dense select	1,750	128	1,285	380	1,600,000
	Select	1,600	110	1,175	345	
	Common	1,200	88	880	325	
Pine, California, Idaho and northern white, lodgepole, ponderosa, sugar, western yellow.	Select	900	85	750	250	1,000,000
	Common	720	68	600	...	
Pine, Norway.....	Select	1,100	85	800	300	1,200,000
	Common	880	68	640	...	
Redwood.....	Select	1,200	70	1,000	250	1,200,000
	Common	960	56	800	...	
Spruce, red, white, Sitka.....	Select	1,100	85	800	250	1,200,000
	Common	880	68	640	...	
Spruce, Englemann.....	Select	750	70	600	175	800,000
	Common	600	56	480	...	
Tamarack, eastern.....	Select	1,200	95	1,000	300	1,300,000
	Common	960	76	800	...	

The strength of wood is influenced considerably by its moisture content. For wet locations, the allowable working stresses should be reduced according to conditions and timber used. Recommendations covering specific cases may be obtained from the Forest Products Laboratory.

¹ Taken from "Steel Construction," 1940, American Institute of Steel Construction.

TABLE 2.—ALLOWABLE UNIT STRESSES FOR STRUCTURAL TIMBER COLUMNS¹
(Pounds per Square Inch)

Species of timber	American standard grade	Ratio of length to least dimension (l/d)																																																																																																																																																																																																																																																															
		10 and less	12	14	16	18	20	25	30	35	40	50																																																																																																																																																																																																																																																					
Ash, commercial white.	Select	1,100	1,076	1,055	1,023	978	913	658	457	336	257	164																																																																																																																																																																																																																																																					
	Common	880	868	857	840	818	784	647					Cedar, western red; fir, balsam.	Select	700	686	674	656	629	592	438	304	224	171	110	Common	560	553	547	538	524	505	425	Cedar, northern and southern white.	Select	550	540	530	516	496	468	351	244	179	137	88	Common	440	435	430	423	412	398	338	Chestnut; pine, northern white, Idaho white, sugar, California white, and pondosa.	Select	750	733	718	695	663	617	433	304	224	171	110	Common	600	591	583	572	556	532	434	Cypress, southern; larch, western.	Select	1,100	1,063	1,030	981	909	810	526	365	268	206	132	Common	880	861	843	818	781	729	Douglas fir (Coast region); pine, southern yellow; beech; birch, yellow and sweet; maple, sugar.	Dense Select	1,285	1,251	1,222	1,176	1,112	1,022	702	487	358	274	175	Common	1,175	1,149	1,127	1,093	1,045	975	702	Douglas fir (Rocky mountain region); spruce, red, white, Sitka; Norway pine; Alaska cedar; elm, slippery and white; sycamore; gum, red and black; tupelo.	Select	800	786	774	753	726	688	526	365	268	206	132	Common	640	632	627	617	602	582	500	Hemlock, west coast.	Select	900	885	872	852	823	783	614	426	313	240	153	Common	720	712	706	696	680	660	573	Hemlock, eastern; fir, commercial white.	Select	700	689	678	664	641	611	482	335	246	188	121	Common	560	554	549	542	530	515	449	Oak, white and red.	Select	1,000	982	967	943	908	860	658	457	336	257	164	Common	800	790	783	771	753	728	625	Redwood.	Select	1,000	972	947	910	858	781	526	365	268	206	132	Common	800	786	773	754	726	688	Spruce, Englemann.	Select	600	586	574	556	530	494	351	244	179	137	88	Common	480	473	466	457	444	426	347	Tamarack.	Select	1,000	976	955	923	877	817	570	396	291	223	142	Common	800	788
Cedar, western red; fir, balsam.	Select	700	686	674	656	629	592	438	304	224	171	110																																																																																																																																																																																																																																																					
	Common	560	553	547	538	524	505	425					Cedar, northern and southern white.	Select	550	540	530	516	496	468	351	244	179	137	88	Common	440	435	430	423	412	398	338	Chestnut; pine, northern white, Idaho white, sugar, California white, and pondosa.	Select	750	733	718	695	663	617	433	304	224	171	110	Common	600	591	583	572	556	532	434	Cypress, southern; larch, western.	Select	1,100	1,063	1,030	981	909	810	526	365	268	206	132	Common	880	861	843	818	781	729	Douglas fir (Coast region); pine, southern yellow; beech; birch, yellow and sweet; maple, sugar.	Dense Select	1,285	1,251	1,222	1,176	1,112	1,022	702	487	358	274	175	Common	1,175	1,149	1,127	1,093	1,045	975	702	Douglas fir (Rocky mountain region); spruce, red, white, Sitka; Norway pine; Alaska cedar; elm, slippery and white; sycamore; gum, red and black; tupelo.	Select	800	786	774	753	726	688	526	365	268	206	132	Common	640	632	627	617	602	582	500	Hemlock, west coast.	Select	900	885	872	852	823	783	614	426	313	240	153	Common	720	712	706	696	680	660	573	Hemlock, eastern; fir, commercial white.	Select	700	689	678	664	641	611	482	335	246	188	121	Common	560	554	549	542	530	515	449	Oak, white and red.	Select	1,000	982	967	943	908	860	658	457	336	257	164	Common	800	790	783	771	753	728	625	Redwood.	Select	1,000	972	947	910	858	781	526	365	268	206	132	Common	800	786	773	754	726	688	Spruce, Englemann.	Select	600	586	574	556	530	494	351	244	179	137	88	Common	480	473	466	457	444	426	347	Tamarack.	Select	1,000	976	955	923	877	817	570	396	291	223	142	Common	800	788	777	761	737	706	566																
Cedar, northern and southern white.	Select	550	540	530	516	496	468	351	244	179	137	88																																																																																																																																																																																																																																																					
	Common	440	435	430	423	412	398	338					Chestnut; pine, northern white, Idaho white, sugar, California white, and pondosa.	Select	750	733	718	695	663	617	433	304	224	171	110	Common	600	591	583	572	556	532	434	Cypress, southern; larch, western.	Select	1,100	1,063	1,030	981	909	810	526	365	268	206	132	Common	880	861	843	818	781	729	Douglas fir (Coast region); pine, southern yellow; beech; birch, yellow and sweet; maple, sugar.	Dense Select	1,285	1,251	1,222	1,176	1,112	1,022	702	487	358	274	175	Common	1,175	1,149	1,127	1,093	1,045	975	702	Douglas fir (Rocky mountain region); spruce, red, white, Sitka; Norway pine; Alaska cedar; elm, slippery and white; sycamore; gum, red and black; tupelo.	Select	800	786	774	753	726	688	526	365	268	206	132	Common	640	632	627	617	602	582	500	Hemlock, west coast.	Select	900	885	872	852	823	783	614	426	313	240	153	Common	720	712	706	696	680	660	573	Hemlock, eastern; fir, commercial white.	Select	700	689	678	664	641	611	482	335	246	188	121	Common	560	554	549	542	530	515	449	Oak, white and red.	Select	1,000	982	967	943	908	860	658	457	336	257	164	Common	800	790	783	771	753	728	625	Redwood.	Select	1,000	972	947	910	858	781	526	365	268	206	132	Common	800	786	773	754	726	688	Spruce, Englemann.	Select	600	586	574	556	530	494	351	244	179	137	88	Common	480	473	466	457	444	426	347	Tamarack.	Select	1,000	976	955	923	877	817	570	396	291	223	142	Common	800	788	777	761	737	706	566																																					
Chestnut; pine, northern white, Idaho white, sugar, California white, and pondosa.	Select	750	733	718	695	663	617	433	304	224	171	110																																																																																																																																																																																																																																																					
	Common	600	591	583	572	556	532	434					Cypress, southern; larch, western.	Select	1,100	1,063	1,030	981	909	810	526	365	268	206	132	Common	880	861	843	818	781	729	Douglas fir (Coast region); pine, southern yellow; beech; birch, yellow and sweet; maple, sugar.	Dense Select	1,285	1,251	1,222	1,176	1,112	1,022	702	487	358	274	175	Common	1,175	1,149	1,127	1,093	1,045	975	702	Douglas fir (Rocky mountain region); spruce, red, white, Sitka; Norway pine; Alaska cedar; elm, slippery and white; sycamore; gum, red and black; tupelo.	Select	800	786	774	753	726	688	526	365	268	206	132	Common	640	632	627	617	602	582	500	Hemlock, west coast.	Select	900	885	872	852	823	783	614	426	313	240	153	Common	720	712	706	696	680	660	573	Hemlock, eastern; fir, commercial white.	Select	700	689	678	664	641	611	482	335	246	188	121	Common	560	554	549	542	530	515	449	Oak, white and red.	Select	1,000	982	967	943	908	860	658	457	336	257	164	Common	800	790	783	771	753	728	625	Redwood.	Select	1,000	972	947	910	858	781	526	365	268	206	132	Common	800	786	773	754	726	688	Spruce, Englemann.	Select	600	586	574	556	530	494	351	244	179	137	88	Common	480	473	466	457	444	426	347	Tamarack.	Select	1,000	976	955	923	877	817	570	396	291	223	142	Common	800	788	777	761	737	706	566																																																										
Cypress, southern; larch, western.	Select	1,100	1,063	1,030	981	909	810	526	365	268	206	132																																																																																																																																																																																																																																																					
	Common	880	861	843	818	781	729						Douglas fir (Coast region); pine, southern yellow; beech; birch, yellow and sweet; maple, sugar.	Dense Select	1,285	1,251	1,222	1,176	1,112	1,022	702	487	358	274	175	Common	1,175	1,149	1,127	1,093	1,045	975	702	Douglas fir (Rocky mountain region); spruce, red, white, Sitka; Norway pine; Alaska cedar; elm, slippery and white; sycamore; gum, red and black; tupelo.	Select	800	786	774	753	726	688	526	365	268	206	132	Common	640	632	627	617	602	582	500	Hemlock, west coast.	Select	900	885	872	852	823	783	614	426	313	240	153	Common	720	712	706	696	680	660	573	Hemlock, eastern; fir, commercial white.	Select	700	689	678	664	641	611	482	335	246	188	121	Common	560	554	549	542	530	515	449	Oak, white and red.	Select	1,000	982	967	943	908	860	658	457	336	257	164	Common	800	790	783	771	753	728	625	Redwood.	Select	1,000	972	947	910	858	781	526	365	268	206	132	Common	800	786	773	754	726	688	Spruce, Englemann.	Select	600	586	574	556	530	494	351	244	179	137	88	Common	480	473	466	457	444	426	347	Tamarack.	Select	1,000	976	955	923	877	817	570	396	291	223	142	Common	800	788	777	761	737	706	566																																																																														
Douglas fir (Coast region); pine, southern yellow; beech; birch, yellow and sweet; maple, sugar.	Dense Select	1,285	1,251	1,222	1,176	1,112	1,022	702	487	358	274	175																																																																																																																																																																																																																																																					
	Common	1,175	1,149	1,127	1,093	1,045	975	702					Douglas fir (Rocky mountain region); spruce, red, white, Sitka; Norway pine; Alaska cedar; elm, slippery and white; sycamore; gum, red and black; tupelo.	Select	800	786	774	753	726	688	526	365	268	206	132	Common	640	632	627	617	602	582	500	Hemlock, west coast.	Select	900	885	872	852	823	783	614	426	313	240	153	Common	720	712	706	696	680	660	573	Hemlock, eastern; fir, commercial white.	Select	700	689	678	664	641	611	482	335	246	188	121	Common	560	554	549	542	530	515	449	Oak, white and red.	Select	1,000	982	967	943	908	860	658	457	336	257	164	Common	800	790	783	771	753	728	625	Redwood.	Select	1,000	972	947	910	858	781	526	365	268	206	132	Common	800	786	773	754	726	688	Spruce, Englemann.	Select	600	586	574	556	530	494	351	244	179	137	88	Common	480	473	466	457	444	426	347	Tamarack.	Select	1,000	976	955	923	877	817	570	396	291	223	142	Common	800	788	777	761	737	706	566																																																																																																			
Douglas fir (Rocky mountain region); spruce, red, white, Sitka; Norway pine; Alaska cedar; elm, slippery and white; sycamore; gum, red and black; tupelo.	Select	800	786	774	753	726	688	526	365	268	206	132																																																																																																																																																																																																																																																					
	Common	640	632	627	617	602	582	500					Hemlock, west coast.	Select	900	885	872	852	823	783	614	426	313	240	153	Common	720	712	706	696	680	660	573	Hemlock, eastern; fir, commercial white.	Select	700	689	678	664	641	611	482	335	246	188	121	Common	560	554	549	542	530	515	449	Oak, white and red.	Select	1,000	982	967	943	908	860	658	457	336	257	164	Common	800	790	783	771	753	728	625	Redwood.	Select	1,000	972	947	910	858	781	526	365	268	206	132	Common	800	786	773	754	726	688	Spruce, Englemann.	Select	600	586	574	556	530	494	351	244	179	137	88	Common	480	473	466	457	444	426	347	Tamarack.	Select	1,000	976	955	923	877	817	570	396	291	223	142	Common	800	788	777	761	737	706	566																																																																																																																								
Hemlock, west coast.	Select	900	885	872	852	823	783	614	426	313	240	153																																																																																																																																																																																																																																																					
	Common	720	712	706	696	680	660	573					Hemlock, eastern; fir, commercial white.	Select	700	689	678	664	641	611	482	335	246	188	121	Common	560	554	549	542	530	515	449	Oak, white and red.	Select	1,000	982	967	943	908	860	658	457	336	257	164	Common	800	790	783	771	753	728	625	Redwood.	Select	1,000	972	947	910	858	781	526	365	268	206	132	Common	800	786	773	754	726	688	Spruce, Englemann.	Select	600	586	574	556	530	494	351	244	179	137	88	Common	480	473	466	457	444	426	347	Tamarack.	Select	1,000	976	955	923	877	817	570	396	291	223	142	Common	800	788	777	761	737	706	566																																																																																																																																													
Hemlock, eastern; fir, commercial white.	Select	700	689	678	664	641	611	482	335	246	188	121																																																																																																																																																																																																																																																					
	Common	560	554	549	542	530	515	449					Oak, white and red.	Select	1,000	982	967	943	908	860	658	457	336	257	164	Common	800	790	783	771	753	728	625	Redwood.	Select	1,000	972	947	910	858	781	526	365	268	206	132	Common	800	786	773	754	726	688	Spruce, Englemann.	Select	600	586	574	556	530	494	351	244	179	137	88	Common	480	473	466	457	444	426	347	Tamarack.	Select	1,000	976	955	923	877	817	570	396	291	223	142	Common	800	788	777	761	737	706	566																																																																																																																																																																		
Oak, white and red.	Select	1,000	982	967	943	908	860	658	457	336	257	164																																																																																																																																																																																																																																																					
	Common	800	790	783	771	753	728	625					Redwood.	Select	1,000	972	947	910	858	781	526	365	268	206	132	Common	800	786	773	754	726	688	Spruce, Englemann.	Select	600	586	574	556	530	494	351	244	179	137	88	Common	480	473	466	457	444	426	347	Tamarack.	Select	1,000	976	955	923	877	817	570	396	291	223	142	Common	800	788	777	761	737	706	566																																																																																																																																																																																							
Redwood.	Select	1,000	972	947	910	858	781	526	365	268	206	132																																																																																																																																																																																																																																																					
	Common	800	786	773	754	726	688						Spruce, Englemann.	Select	600	586	574	556	530	494	351	244	179	137	88	Common	480	473	466	457	444	426	347	Tamarack.	Select	1,000	976	955	923	877	817	570	396	291	223	142	Common	800	788	777	761	737	706	566																																																																																																																																																																																																											
Spruce, Englemann.	Select	600	586	574	556	530	494	351	244	179	137	88																																																																																																																																																																																																																																																					
	Common	480	473	466	457	444	426	347					Tamarack.	Select	1,000	976	955	923	877	817	570	396	291	223	142	Common	800	788	777	761	737	706	566																																																																																																																																																																																																																																
Tamarack.	Select	1,000	976	955	923	877	817	570	396	291	223	142																																																																																																																																																																																																																																																					
	Common	800	788	777	761	737	706	566																																																																																																																																																																																																																																																									

No column shall be used in which the unsupported length is more than fifty times the least diameter. *l* and *d* must be figured in the same unit of measurement.

The strength of wood is influenced considerably by its moisture content. For wet locations the allowable working stresses should be reduced according to conditions and timber used. Recommendations covering specific cases may be obtained from the Forest Products Laboratory.

¹ Taken from "Steel Construction," 1940, American Institute of Steel Construction.

and the direction of the grain. Figure 6 is the value on inclined bearing on longleaf pine and on Douglas fir according to the controlling values as given in Table 1.

For use at points where timbers in end compression bear against the side of the grain of other members, it is often advisable to place bearing blocks of harder wood to distribute the load to a safe pressure on the weaker piece. Such a case is illustrated in Fig. 7 which is a very common detail in building and in shipwork.

3. Design of Timber Bridges.

3a. Floors.—The flooring of a bridge is a beam over multiple elastic supports. The area over which a concentrated load is considered to act for purposes of design varies with different specifications. This distribution affects not only the design of the stringers, but also the design of the flooring. The Oregon State Highway Commission gives the following distribution for concentrated loads on timber floors.

Each wheel concentration shall be considered as being distributed over a rectangular area of dimensions A and B , the dimension A being longitudinal or parallel to the center line of the roadway and B being transverse or across the line of the roadway.

Thickness of decking, inches	A , feet	B , feet
2 to 4	1.0	2.5
5 to 6	1.0	4.0

As the stringer spacing is never over 4 ft., it follows that the design of the flooring for a 5- or 6-in. decking will be as for a continuous beam uniformly loaded over the distance between two supports. This deduction is within the limit of error and uncertainty on this class of work and it is needless to go into any closer or more

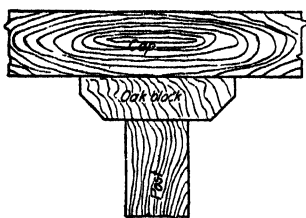

FIG. 7.

theoretical analysis because the wearing surface will reduce in thickness under traffic and destroy the value of any assumption as to the effective thickness of the flooring material. The continuous action can be said to extend over the whole width of the roadway as the detail of Fig. 8 shows how the bolted felloe guard or bull rail fixes the ends of the planking. This, of course, is not theoretically the case as the stringer can deflect

sidewise and allow the flooring to change its angle with the horizontal. The fact, however, that the wear is less near the felloe guard tends to make this portion of the deck of greater relative strength than the rest of the floor as time goes on.

Ample margin should always be allowed for wear in the planking and even when paving is to be laid over the structure at once, there should be extra thickness over the calculated thickness to allow for deterioration of the planking due to rot, and great care should be exercised to see that the deflection does not exceed 1-300th of the span. This will prevent many of the hitherto unexplained cracks in asphalt paving on timber bridge floors as it is almost certain that numbers of these failures were due to excessive deflection of the flooring and stringers.

The actual amount of extra thickness needed on a wood floor is something that cannot be determined with accuracy by making calculations. The best guide is an inherent sense of the fitness of things and a close study of the behavior of wooden bridges under traffic.

Stringers.—In the design of stringers, the same condition applies as in the case of the decking, but in the reverse order. The stringers are a series of yielding supports receiving their load from the decking. As the longitudinal distribution is only one foot, it can very well be considered as applied at a point. The lateral distribution may, in any case, be approximately determined by considering

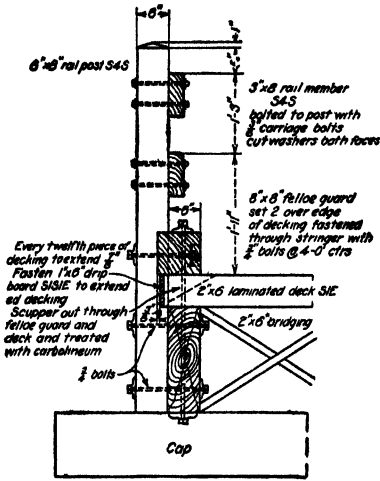

FIG. 8.

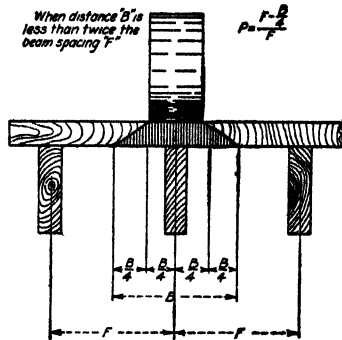

FIG. 9

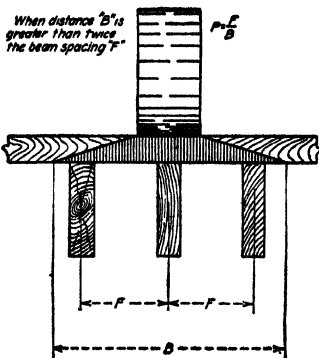
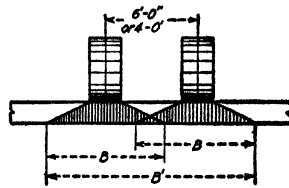
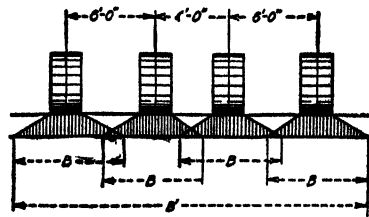

FIG. 10.



Note—When roadway is less than B' the width of roadway shall be substituted in formula. Where the lateral distribution ranges overlap, P = P' is proportion of single or double truck loading as the case may be.

FIG. 11.

the floor slab as continuous over a series of elastic supports and forming upon this hypothesis a series of work equations. The following assumptions, while more severe than those derived from the theory of elasticity, may however, be used for the ordinary types of floor construction with little if any ultimate waste of material.

Case 1.—When the distance B (lateral distribution) is less than twice the beam spacing F (see Fig. 9).

In this case the proportion of a wheel load carried by each joist is given by the expression

$$P = \frac{F - B/4}{F}$$

Case 2.—When the lateral distribution B is greater than twice the beam spacing F (see Fig. 10).

In this case the proportion of a wheel load carried by a single joist or beam is given by the term

$$P = \frac{F}{B}$$

Case 3.—Where the lateral distribution ranges overlap, as shown in Fig. 11.

In this case the proportion of a single or double truck (as the case may be) carried by any single beam or girder is given by the expression

$$P' = \frac{F'}{B'}$$

It should be noted that the expression in Case 1 is not strictly true when the stringers or joists are spaced farther apart than the wheel gage.

3b. Trestles. Caps.—About all that is necessary in the design of caps in the ordinary trestle is to make them wide enough to provide good bearing for the stringers. Present day highway design calls for roadways 18 ft. wide and wider, and for at least four piles or posts per bent. This decreases the span of the cap to something like 6 ft. and the 12×12 is ordinarily amply strong. In the case of falsework or other light framing, it may be desirable to use the lightest possible stick, in which case the ordinary rules for the design of timber beams apply.

Posts or Piles.—In the ordinary trestle, the load on the post or pile is usually very light as compared to the allowable working load. It only remains to see that the ratio of $\frac{L}{R}$ is not exceeded and to furnish bracing when the height demands it.

Bracing.—High trestles require the same analysis when built of wood as when built of steel. Both are subject to the same external forces. The manner of caring for the stresses is usually somewhat different as steel trestles are generally composed of two-post bents sway-braced with rods and turnbuckles and arranged in towers of two bents each by having the bents spaced alternately close together and further apart. A favorite spacing is 30 ft. and 60 ft., the 30-ft. opening being used to put longitudinal sway bracing between the posts, and no connection being made between the bents which are 60 ft. apart.

On account of the limited length of span allowable for the timber stringers, the timber trestle bents are always spaced equally. Horizontal braces transversely across the bent and bolted to each post or pile are called *sash braces* and stay the posts in a transverse direction. Horizontal longitudinal braces from bent to bent are called *girts* and stay the posts in the longitudinal direction.

Cross or X bracing is also placed both transversely and longitudinally, the transverse maintaining the individual posts in their upright position and the longitudinal maintaining the bents upright.

In high trestles the transverse bracing takes the side thrust of the wind load and, if the trestle is on a curve, takes the centrifugal force of the train or other live load. The longitudinal X bracing takes the tractive effort. It is very seldom, though, that the considerations of stress analysis will give an adequate size brace for timber trestles. The very stiffness of the whole structure as obtained by the use of generous sizes of bracing will tend materially to increase the life of the structure by preventing excessive vibration under rapidly moving loads. This will prevent the bolts and spikes from working loose and thereby keep the entire trestle tight and solid.

Footings.—The posts of a frame trestle usually rest on a timber sill of the same size as the cap, but longer, in order to accommodate the lower ends of the battered outside posts. This sill may be supported in a number of ways, depending upon the bearing power of the soil on which the trestle is built. Where the soil is firm enough to stand loads of two tons and more per square foot, the usual method is to set the sill on a row of concrete pedestals which extend into the ground to well below the frost line, or in a stream to well below the possible limit of scour. Where the soil is soft and greater area is needed, it is customary to employ mud blocks or short pieces of timber placed underneath the sill and extending far enough longitudinally that taken together they furnish the required bearing area. This is a makeshift construction at the best and has a very short life. There are cases, however, where only short service life is desired, or where renewal of the mud blocks will be cheap and easy. In such a case, they may be used to advantage. The design of either the concrete pedestals or the wooden mud blocks is a problem of furnishing sufficient bearing area to bring the pressure on the soil within the allowable working load. The posts of the trestle are set directly above the blocks or pedestals so that the sill is in direct compression perpendicular to the grain of the wood. In heavy work, this detail should always be carefully investigated as the maximum working load on a 12-in. square surface at 250 lb. per sq. in. is only 18 tons, which does not leave a great deal for live load if the deck is very heavy. It is sometimes necessary to use cast-iron or structural steel plates at the ends of the posts in order to distribute the load to the side grain properly.

In very soft soils where extra long mud blocks are necessary, they should be analyzed as a beam balanced over one support and uniformly loaded over its entire length, or, what amounts to the same thing, the beam should be considered as fixed at the sill and cantilevered out as far as the projecting end and loaded with the calculated pressure.

Fastenings.—If the matter of tension splices is not taken into consideration for the time being, there are but 3 accepted types of fastenings for present day bridge framing. They are bolts, drift pins and nails or spikes. As will be noted these are all of metal. The old practice of mortise and tenon, timber keys, wooden pins, etc., has no place in present day timber bridge construction. The dowel is purposely omitted from the above list of fastenings as it is not considered as fastening pieces together. It merely holds them in line and leaves them free to pull apart in the direction of the dowel.

The design of any of the above fastenings is more a matter of experience and judgment than of theoretical analysis. The size of washer (either cut, malleable, or cast) to use under a certain sized bolt-head usually cannot be calculated in terms of the stress which will come into the bolt on account of loads on the structure, as this stress is highly problematical. The rational procedure, then, is so to fix the size of the washer that it will be equal in allowable total pressure on the average strength timber to the capacity of the bolt at the root of the thread. This the manufacturers have done and the general specification of "Standard malleable or standard cast washers at each end of each bolt" insures a consistent design. The size of bolt to use at any given point is, however, subject to some difference of opinion in different circles. Only experience will teach what are the correct sizes to be used at different locations. In ordinary highway work, the standard for ends of braces, stringers, felloe guards and other main points is the $\frac{3}{4}$ -in. square head, square nut, machine bolt. For handrails and handrail posts the $\frac{3}{8}$ -in. or $\frac{1}{2}$ -in. carriage bolt is common practice. Railroad work usually calls for $\frac{3}{4}$ -in. bolts for bracing and guard rails and $\frac{3}{8}$ -in. or even 1-in. bolts for stringers.

In considering drift bolts and nails or spikes, the general rule is that the fastening should extend fully as far into the holding piece as it is through the held piece. Thus in nailing 4-in. decking, the size of spike used would be 8-in. and in nailing the intermediate contact points of bracing to posts or piles, a $7\frac{1}{2}$ -in. or 8-in. boat spike is used in connection with the 3-in. brace. Likewise when fastening a 12×12 cap to a post or pile with a drift bolt, the drift should be at least 26 in. long, 12 in. being in the cap and 14 in. in the post or pile.

All of the above in reference to bolts refers to parts in which the bolts are in shear or side bearing. When a bolt is used in such a way as to admit of the strain on it being calculated, it is a very simple matter to design a washer to distribute the stress properly to the timbers and such a case would not be covered by the foregoing statements.

3c. Connectors.—Modern connectors have been used extensively in this country since being introduced in 1933. These connectors, known as TECO, are patented by The Timber Engineering Company, Washington, D. C. Types of Teco timber connectors are shown in Figs. 12 to 16, and in Fig. 17 are shown typical connector joints. In Fig. 12 are shown the split-ring and the toothed-ring connectors. The split-ring connector is of steel, rectangular in cross section, and is used between two timber faces for heavy construction. It fits into pre-cut grooves in the timber faces with half the depth of the ring in the groove of each member. The steel toothed-ring is used for comparatively light construction. It is embedded into the contact faces of the joint members by means of pressure.

Another type of connector is the malleable iron claw plates shown in Fig. 13. These plates are used in pairs for timber-to-timber connections. In the installation the teeth are forced into the wood beyond the depth of the circular dap cut to receive the rim plate portions. For timber-to-metal connections only one plate is used.

Shear plates are made either of pressed steel or malleable iron. These plates, shown in Fig. 14, are used in pairs for timber-to-timber connections and singly for timber-to-metal connections.

Figure 15 shows malleable cast-iron spike grids that are used primarily in pier and trestle construction. They are embedded into the wood surfaces by means of pressure.

Clamping plates, shown in Fig. 16, are stamped from metal sheets. They are used as railroad "tie spacers" between ties and guard timbers to keep the ties properly spaced or where timbers overlap at right angles.

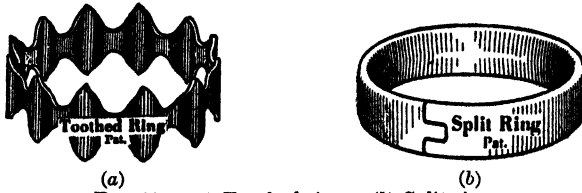

FIG. 12.—(a) Toothed ring. (b) Split ring.



FIG. 13.—Claw plates.



FIG. 14.—Shear plates.

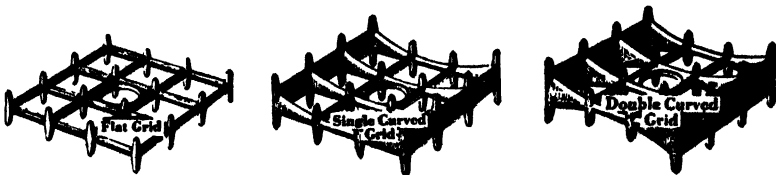

FIG. 15.—Spike grids.



FIG. 16.—Clamping plates.

3d. Truss Bridges. Compression Chords.—Having obtained the direct stress in the chords due to all causes, the problem of the design of the chord is a combination of column and beam design and the use of judgment regarding how much stick must be cut away in making the necessary joints and fastenings. It is universal practice to make all timber chords the same size from end to end

on account of the difficulty of using a different sized stick for the different panels. The only panel of top chord then that is closely computed is the center panel. From the figures for total stress, a piece is selected with approximately one-third more area than required. The cuts at the panel points and all nearby bolt holes are then taken out and the effect of the computed load on the net section is considered. If the chord is composed of a single stick or is a laminated chord, the size thus found is sufficient. If the chord is to be composed of two or more pieces side by side with air spaces between, it is customary to allow one stick for splic-

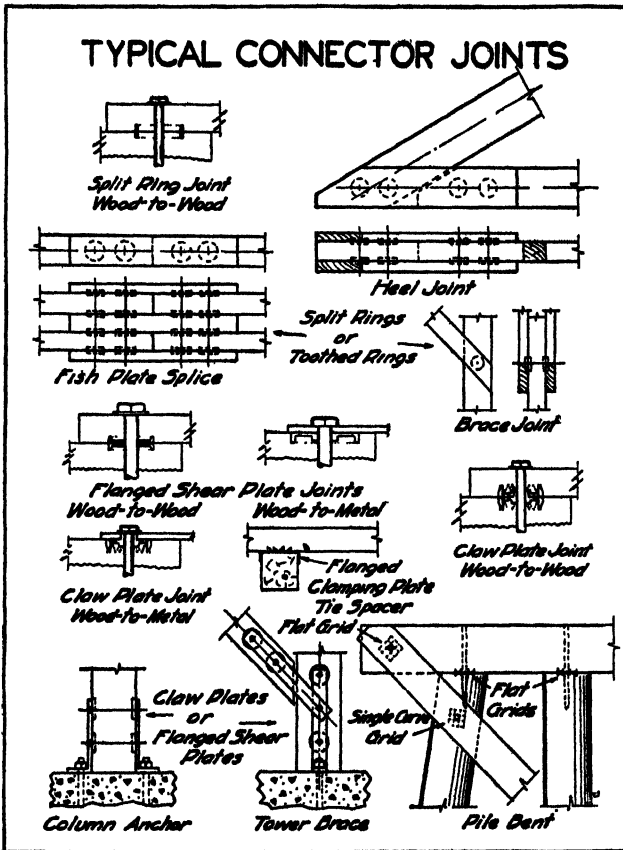
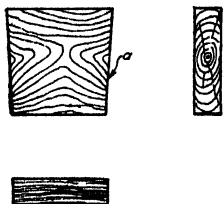

FIG. 17.—Connector joints.

ing and consider the stress as carried in the rest after deducting the cuts, daps and bolt holes as before. In this method, it is necessary that shear blocks be placed between the splice points in order to transfer the stress from the solid into the spliced stick by the time the next splice is reached. This requires the use of packing blocks which are framed into the space between the adjacent timbers. Figure 18 shows the details of a timber packing block for such a purpose and Fig. 19 a cast-iron block. The portions of these blocks which frame into the chord sticks (faces *a-a*) are in compression and the total faces *a* between two adjacent splices should be sufficient to develop the stick last spliced.

It is not customary to consider that any of the stress on a top chord of two or more sticks is taken by the spliced stick in the panel containing the splice. Thus in a three-leaved chord, two sticks are carrying the load and one is used for splicing. No dependence is placed upon the spliced stick, as shrinkage or other causes may pull the two adjacent ends apart and destroy the bearing. In light construction, should it become necessary to splice a compression chord of one stick, it is best to fully bolt up the two ends with two sticks on the sides and then bore holes along the contact surfaces and drive wooden or metal keys as in Fig. 20. These keys should always be driven horizontally so that in case of shrinkage, they would not tend to fall out if the splice were subjected to a reversal of stress. In such a splice, all the load is considered taken by the pins and none by the abutting ends. The bolts must be sufficient in number and size to care for the component of stress against the sloping side of the pins tending to spread the splicing plates apart. The holes for the pins should be bored under-



Timber Packing Block for Top Chord and End Post

FIG. 18.

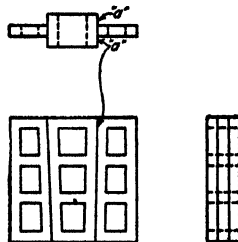

Cast Iron Packing Block for Bottom Chords

FIG. 19.

size and the pins driven in. This detail also makes an acceptable tension joint on unimportant work as will be mentioned in connection with the lower chord later on.

When the floorbeams over a deck truss are not set at the panel points, the top chord is subject to a combination of bending and direct stress and should be so designed. In this regard it is analyzed in the same manner as an eccentrically loaded column or a portion of an arch ring—that is, the direct stress is computed and to that is added algebraically the stresses in the upper or lower fibers of the chord which result from the load of the floorbeams. The resulting stress must not exceed the allowable value of the chord as a column as given in Table 2, p. 381. Thus on Douglas fir and longleaf pine, the combined bending and direct stress on the two acting sticks of a three-stick chord should not exceed 487 lb. per sq. in.

for an $\frac{L}{D}$ ratio of 30. In this combination if the floorbeam is set very close to the panel point, the bending stress over the panel point is nearly the same on the unspliced leaf (as a simple beam) as on the spliced stick (as a cantilever) and the bending stress is distributed over three leaves while the direct stress is taken by the two unspliced leaves. However, if the stringers run transversely so as to

give a practically uniform load across the chord, no credit should be allowed the spliced leaf as a stress carrier either in bending or in direct stress.

Tension Chords.—All of the foregoing paragraphs regarding distribution of stress between spliced and unspliced leaves of multiple stick chords apply equally to tension and to compression chords. There remain only the details of calculating the splice. Although it is not considered as carrying any of the load, the splice is always made as strong as possible as a factor of safety. The most desirable tension splice from a standpoint of certainty and ease of framing is one which has but one contact surface on each side of the joint. The second consideration to be taken into account is that it must be adjustable in order that it can be tightened up after the timber seasons and shrinks. The third consideration is that the splicing material shall be free from shrinkage or other tendency to deterioration insofar as possible. Last of all, because the joint is very important, is the question of cheapness, both as to material and as to labor. The

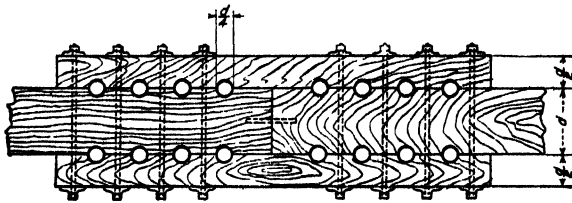

Elevation

FIG. 20.

splice that most nearly fills all these requirements is the one shown in Fig. 21. The calculations required are:

- (1) That the tension area left in the stick shall be equal to the compression area provided for the bearing channels.
- (2) That the flanges of the channel be stiff enough to stand the bearing without failure or be provided with stiffeners.
- (3) That the distance from the bearing faces of the channels to the end of the stick be long enough to provide ample shear area to develop the tension area left in the stick. (A large margin should be allowed here for possible seasoning checks.)
- (4) That the area of the four rods be sufficient to develop the tension area left in the stick.
- (5) That the channels be stiff enough in bending to carry the load from the compression faces of the timber to the tension rods. It will be seen that, with an allowed bearing load of 1,200 lb. per sq. in. and an allowed tension value of 1,600 lb. per sq. in., it is not possible to develop quite half the total tension value of the piece. With 1,600-lb. compression and 1,600-lb. tension, the stick could be half spliced.

The pin splice shown in Fig. 20 will develop nearly three-fourths the tension value of the stick, and, by extending the plates and putting in more but smaller pins, a yet higher efficiency may be obtained. This is a poor splice, however, for heavy work and should not be used on any important structure. The use of the tabled fish plate joint shown in Fig. 3 should be limited to cases of extreme emergency where metal is not to be had and where the use of the joint for a longer period than one season is not essential. If it should become necessary to use such a detail for a longer period, it should be given frequent inspection and the bolts be carefully tightened as often as it is inspected.

The use of plain plates of wood or metal in conjunction with a series of bolts or pins which depend on bearing of the timber on the bolt to transfer the strain to the plate in shear should not be used as there is a decided tendency in this type of joint to split the wood of the main member without any sign of the failure being apparent on the outside of the splice. This might lead to a serious accident.

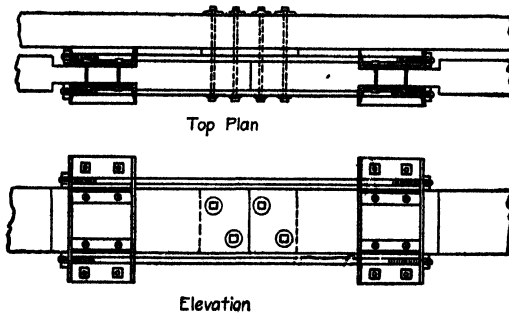

FIG. 21.

The same types of packing blocks should be used between the lower chord leaves as between the top chord leaves, and for the same reason.

Compression Web Members.—The compression web members of a wooden bridge are almost invariably the diagonals, making the truss a Howe type. Several examples of Pratt trusses with wood compression members are in existence, but they are not economical on account of the extra length of steel rods required.

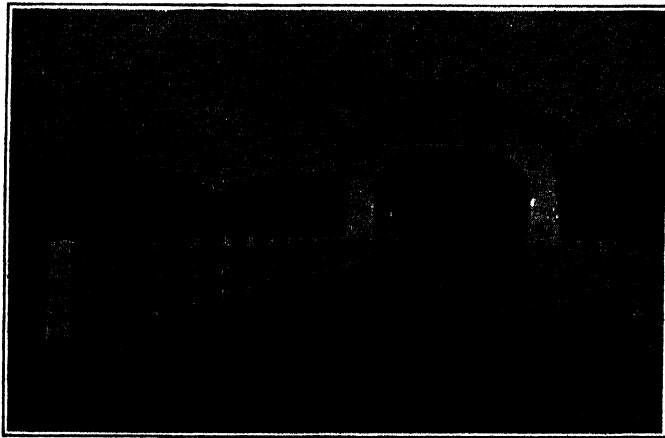

FIG. 22.

The design of the diagonals is merely a matter of applying the column formula until the end post is reached. This requires special treatment as the portal introduces a combination of direct and bending stresses which usually requires quite a bit larger timber or timbers than in the web system. It is customary to provide the end post with shear blocks when it is composed of two or more leaves and then consider the full width in bending due to wind stresses in the portal system.

In this connection, it should be noted that in many cases of long bridges of timber the end post cannot be reasonably made large enough to provide for both wind and live load stresses. In such a case the relief is obtained by putting in sub-portals at as many of the diagonal web members as is necessary and thus having the upper lateral system act only in short lengths of two or three panels before taking the wind stress to the lower lateral system.

The diagonal web members should not be considered as a whole when computing the allowable unit bearing loads but the least diameter of a single stick should be used. In some cases it will be found advantageous to have a smaller bearing area on the end of the diagonal than at the center. In such a case, it is permissible to trim the end of the stick down to the required size, but the designer should keep in mind the fact that the remaining available bearing area should be not only capable of carrying the load in compression, but also should be as nearly as possible in line with the axis of the stick in order that there may be no eccentricity.

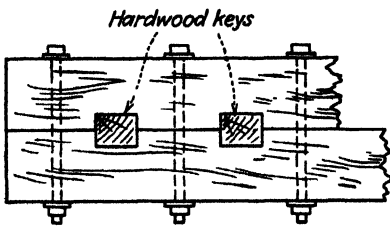

FIG. 23.—Built-up beam with keys.

Multiple stick web members should have packing blocks near the ends in order to prevent undue warping, tending to twist the diagonal away from the bearing. This need not be framed into the adjacent timbers, as in packing blocks for chords, because they carry no definite stress and are not for the purpose of transferring shear. They should be sufficiently bolted to prevent turning out, and for appearances should be trimmed flush with the members they separate.

If a beam is built up as shown in Fig. 23, the entire cross-section will be used in applying the column formula, but an efficiency of 80 per cent will be assumed for white oak keys. Thus in a chord of two 6- \times -18-in. timbers it would be treated as having a carrying capacity of 80 per cent of a timber 12 \times -18 in.

Tension Web Members.—The tension web members of a timber truss are usually of metal, either steel or wrought iron. Their design consists merely in the selection of the proper amount of cross-section and dividing that area into the most convenient number of bars. It involves also the selection of suitable bearing plates at the ends of the rods and the question of whether or not the rod is to be upset or used plain. The question of plain vs. upset rods (where both are available) is a question of the cost of making the upset as compared with the cost of extra metal required if a plain bar is used. As the cost per upset varies considerably in different localities, no rule can be given except to say that unless the rod is both short and small it will pay to employ the upset.

Counters.—By their nature, counters in a wood truss are also of wood and as usual are much smaller than the main diagonals. For this reason it is customary to place them between the two main diagonal timbers in large trusses and to consider them as fixed at the intersection of their line and that of the main diagonals in the same panel. This is a rational assumption and allows a somewhat smaller size of stick. Of course, where single stick web members are used it is necessary to place the main and counter diagonals alongside each other at their intersection and then the full length must be used in figuring column action.

Trusses have been built where a tension rod was placed on each side of the truss and in line with the main compression diagonal to take the reversal in tension, but the detail is awkward and causes a patched up appearance in the finished work.

Laterals and Portals.—The purpose of the lateral systems, both upper and lower, is to prevent sideways due to horizontal forces. These horizontal forces are from two causes. The first and most important is the wind. The second is centrifugal force due to the span being on a curve. The first is always considered, while the second is rarely ever necessary on trusses because their construction dictates that they be straight. Sometimes, however, they support curved track and the centrifugal force must be considered. The upper lateral system in through trusses and the lower lateral system in deck trusses have only their proportion of the exposed area of the truss to provide for. The lower lateral system in the through truss and the upper lateral system in the deck truss must provide for the exposed area of truss tributary to that chord and also take care of

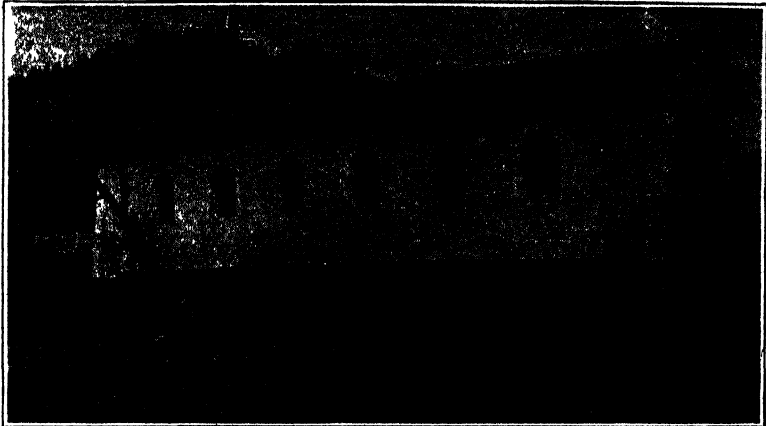

FIG. 24.

the wind load against the side of any vehicle on the span. The wind force on the structure is usually taken as a moving horizontal load equal to 30 lb. per sq. ft. on $1\frac{1}{2}$ times the area of the structure as seen in elevation, including the floor system and railings and on one-half the area of all trusses or girders in excess of two in the span. This holds for all exposed area of truss and floor system. When considering vehicles, the most common specification is 300 lb. per lin. ft. of span, acting as a moving load. The above applies, of course, to unhoused trusses. When housed, each lateral system takes one half the load of the wind on the side of the housing, vertical projection of the roof included.

In the shorter trusses, this load is transferred by means of the lateral system to the portal at the ends of the top chord and thence through the end posts into the pier. This puts a heavy bending stress into the end post and in the longer spans, making the combined stress so large that different steps must be taken for its transfer to the lower chord. This is done by putting in more portals at intermediate points and causing the lower lateral system to take the greater part of the load to the piers. This is very well shown in the illustration of the interior of the

housed Howe truss (Fig. 22). The main portal braces are visible at each end of the top chord, and half way through the truss can be seen the secondary portal. Provision must be made in the diagonal to which this secondary portal is fastened to take care of the extra stress thus induced. In the design of the 190-ft. truss shown on p. 400 these subportals are very well illustrated, quite a number of them being used to lessen the concentration of top chord wind load at the ends of the span. This 190-ft. span is a housed bridge and each lateral system takes care of half the wind load.

As the calculation of the stress in these laterals and portals is not any different than the calculation of like stresses in a steel structure, they are not reviewed here. The details of the various joints and members which follow illustrate fully the manner of caring for the stress after it is found and so are included under details instead of under stresses.

Joint Blocks for Trusses.—When the block is a solid piece, as an oak block, there is not much computing to be done except to see that the bearing and shearing values are safe both on the block and on the chord which carries it. An example of such a block is shown on the detail sheet accompanying the plan for the 190-ft. truss, p. 400.

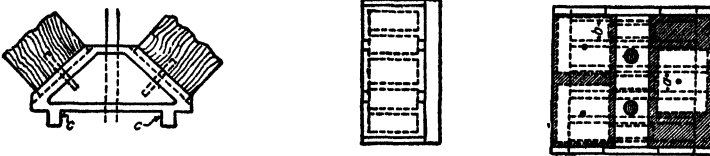

FIG. 25.

When a cast-iron block is used, the bearing and shearing stresses on the block and chord must be computed and also the bending on the metal between the ribs of the block from the pressure of the stick which the block carries. This will be due to the unit stress on the timber applied over the span "a" or "b" (see Fig. 25). The ribs must also be sufficient to carry the stress safely. The faces "c" of the lugs must be deep enough to provide ample bearing to transmit the horizontal component of the web system into the chord. Wherever possible, the entire horizontal load should be taken by one of these lugs only, thus preventing failure by reason of poor framing allowing one lug to bear before the other comes into contact and thereby shearing off one lug at a time. The distance between the lugs should be such that the allowable shear with the grain of the timber will not be exceeded when the computed bearing on "c" is realized.

In the design of these blocks as well as in the detailing of any cast work, care should be taken to have all parts of a uniform thickness and to avoid as far as possible any extra heavy parts adjacent to thin sections. This is to prevent cracking or warping in cooling which is a much more serious item than the uninitiated would suppose.

In laying out the members of the truss about the truss diagram, it is customary in wooden bridges to place the timbers for the chords far enough off center with the actual stress line to admit of using a small block at the joints. Thus in Fig. 26 it will be seen that although the distance between "working" or stress lines is 22 ft., the distance center to center of chords is 22 ft. 6 in.

The old railroad practice was to obtain flat angle blocks by making the panel lengths very short so that the diagonals were nearly vertical. This gave a very stiff truss and was excellent for use with train loadings. For present day highway work the panel length can be considerably lengthened and a greater saving made on timber than is expended due to the larger angle blocks.

Cast-iron angle blocks are sometimes used at the lateral intersections on the sides of the chord. These lateral blocks are subject to the same analysis as

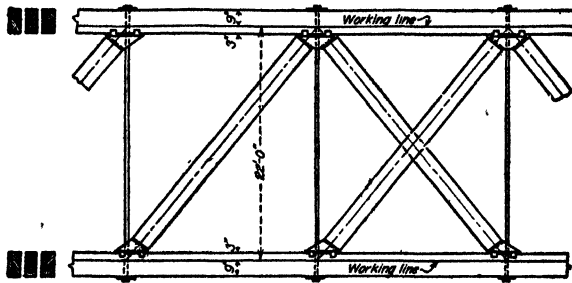

FIG. 26.

the main angle blocks but are usually provided with a single cylindrical lug on the side which bears against the chord. This is to prevent the block from slipping out and falling should the tension on the rod which holds the timbers be released. A detail of such a block is shown in Fig. 27. In the truss using this type the lateral diagonals are of timber and the rods run at right angles to the chords. This allows the whole lateral system to be brought up tight by tightening up the

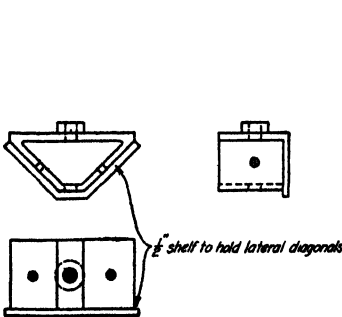

FIG. 27.

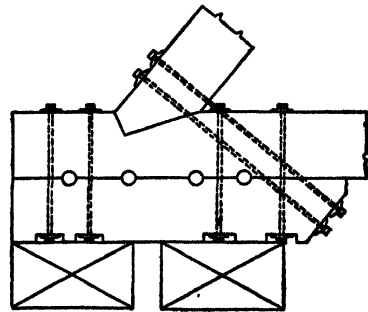

FIG. 28.

rods, and also is not subject to the rattling found where the lateral diagonals are of rods and the struts of wood.

Provisions for Housing.—As was mentioned in the preceding paragraphs, housing a truss subjects it to a greater stress during wind storms. This stress can be provided for by additional portal braces at intermediate panels. The portion of the roof of the housing which is between panel point "0" and panel point "1" must be sway-braced both horizontally and vertically. The lateral system can be extended to the end of the housing which takes care of the hori-

horizontal load. The end of the housing can be reinforced in the vertical direction by having knee-braces from the upper sill to the vertical posts which rest on the lower chord and support the ends of the longitudinal nailing girts. These knee braces are figured the same as portal braces.

The longitudinal sill for the roof rafters in the end panels usually needs some support to lessen the span over which the load of the roof need be carried. This can be done very readily by framing some more knee-braces from points near the middle of the end panel to the upper line of nailing girts near their end supports in the 0-1 panel. This reinforcement is not usually necessary in the inside panels as the top chord carries the load and only a narrow deep sill is placed on the top of the chord to support the rafters between panel points and to allow access to the main nuts for tightening up after seasoning and shrinkage.

While it is customary to run line girts or nailing strips along the side of the truss, fastening them to the main diagonals to support the housing, it must be borne in mind that the shrinkage of the timbers of the truss allows the bridge to settle and lose its camber which will tend to tear the siding from the girts if it is fastened too tightly. The siding should therefore be fastened in such a manner that this shrinkage and settlement will not tear it off. This means that the siding should consist of wide vertical boards nailed twice at the ends and once at each intervening nailing strip and with the cracks between the boards covered with battens which are nailed to one board only, leaving the projection to cover the opening and side on the adjacent plank. In making up standard plans for trusses to be used with or without housing, it has been found convenient to make the trusses just the same for housed as for the unhoused type, depending upon an upper sill laid from U1 to U0 to carry the rafters in that panel.

The practice of extending one of the leaves of a three-leaved top chord section to carry the end panel of roof is awkward to handle and does not give the rafters the correct height or support to fit the details on the main portion of the top chord where an extra sill is used to hold the rafters away from the nuts on the main rods.

Corbels and Pier Tops.—The only analysis necessary in the ordinary corbel is to hold the bearing on the side grain within the allowable unit stress. There are exceptions to this, however, when it is desired to have bolts through the foot of the end post and the corbel to keep the lower end of the end post from shearing off the dapped joint. In such a case (see Fig. 28) bolts should be placed vertically and wooden or pipe keys driven into the joint to assist in developing the shear along the line of contact of the corbel and the chord.

The pier caps are subject to side bearing, bending and shear when built of timbers. Care should be used when selecting the layout of the pier cap to be sure that the horizontal shear does not split the pier cap and ruin the structure.

4. Details of Timber Bridges.

4a. Floor Systems. Wearing Surfaces.—The simplest wearing surface is the ordinary plank floor. For present day highway traffic this should be from 3 to 5 in. thick with boards 10 to 16 in. wide. They should be laid at 90 deg. with the center line of the roadway and should be used in commercial lengths varying by 2 ft. in order to save sawing off the ends. These lengths when used in conjunction with a 6 in. wide felloe guard give a distance between felloe guards that is in odd feet but the junction between the felloe guards and adjacent paving

can be very easily adjusted. The plank should be nailed with spikes at least twice as long as the thickness of the planking and should have two spikes in each end of each plank with one spike in each intermediate stringer. The interior spiking should alternate from side to side of the plank. The ends of the planking should be held down to the outside stringer by means of a felloe guard at the edges of the roadway and have bolts extending through the stringer. This will prevent the ends of the planking pulling loose under loads in the center of the roadway and will also increase the strength of the planking by partly fixing it at the ends.

The next step in wearing surface development is the placing of longitudinal running strips down the bridge floor in order to give less impact due to different thickness of planks and to distribute the wheel loads over a greater number of planks. These should be nailed very securely at the ends and have the joints staggered in order to reduce the impact as much as possible. It is customary to leave a portion of the roadway without these strips placing only three or four widths under each wheelway. The only idea in this is to save lumber and labor. It makes a better roadway to lay the longitudinal plank for the full width. These longitudinal plank should not be used in damp climates or in any location where moisture is likely to collect between the two layers and rot the timber.

When the longitudinal strips are placed for the full width of the roadway, the result is a double system of flooring which will carry loads in both directions and prevent one transverse plank from deflecting independently of the ones adjacent to it. It is then possible to put on a wearing surface that is more easily renewable than the planking and which will stand more wear. One such covering is the creosoted wood block. The blocks can be nailed to the floor for use on moving spans such as the leaves of bascules, or they can be laid loose on a tar cushion. In either case it is advisable to fill the joints with tar filler and to sprinkle pea gravel and sand over the tops of the blocks and roll it in. The sand absorbs the excess tar and keeps the road from being sticky and the pea gravel is imbedded in the end grain of the blocks and increases their resistance to wear.

The greatest drawback to this type of floor is that the moisture penetrates between the blocks and rots the sub floor. In order to prevent this and form, as it were, a roof over the wooden deck, asphaltic concrete or even ordinary asphalt has been laid on the plank floor and where not subjected to excessive deflection has given excellent service.

The next improvement is in the nature of stiffening the flooring to give less deflection under live loads. This stiffening is obtained by the use of laminated decking instead of the double layer of plank. For the 20-ton truck, these laminated decks are made of 2 × 6 on edge with heavy stringers at about 30-in. centers. As the laminations are liable to catch and hold water they should not be used in damp climates unless it is possible to cover them with a good roof of asphalt.

In the above remarks an attempt has been made to show that rot is as serious a foe to a bridge as wear. For that reason all bridge floors should have a decided camber and wherever they are paved with asphalt they should be crowned to shed the water to the edges of the roadway.

The City of Seattle in its wooden bridges uses a beveled shim between the stringers and the cap or floorbeam which gives the desired crown at the center.

They also build a gutter at the curb line and provide inlets and downspouts at frequent intervals. This type of floor when covered with asphaltic concrete makes a very excellent structure and one that should have a long life.

The State of Washington has tried some new trestle work wherein the floor is composed of a 6-in. concrete slab reinforced both top and bottom and cast in lengths equal to one half panel. The joints come at bent and mid span and the slabs are designed sufficiently strong to carry from the bent and mid span when the stringer deflects. The balance of the structure is the regular timber or pile trestle with timber stringers. So far they have given excellent satisfaction, it being possible to remove two sections of slab and renew broken or torn stringers and replace the slabs with but very little trouble.

Stringers.—The stringer as a structural member is so simple as to need almost no comment. There are a few points worth mentioning, however, and of these probably the most important is the necessity for always using bridging at mid span on short spans and at the third points on longer spans. The ends of adjacent stringers are lapped at intermediate stringers and butt-jointed at the outside stringer. All stringers should be fastened to the cap or floorbeam and the outer ones should be bolted.

Some bridges are built with long panels and stringer joints made at every panel point. Others are made with panel lengths short enough to allow each stringer to reach two panels, thus making it unnecessary to have joints except on every alternate cap. This method gives a structure which is more firmly tied together and less liable to break at a bent. Where stringers of different depths rest on the same cap, the cap should be placed to take the deepest stringer. Blocks are then provided for use under the shallower stringers. No stringer should ever be dapped out on its lower edge, even at the supports, as these re-entrant cuts tend to start season checks which, when they spread, may ruin the piece. Intermediate stringers may be toe-nailed to the cap but outside stringers should be bolted with a bolt in each end of each stringer.

Floorbeams and Caps.—The floorbeam or cap is the base of the floor system; below this the structure may be either truss or trestle on even piers although a cap is not so much a structural member as it is a nailing strip when it rests directly on a concrete or masonry pier.

The truss floorbeam usually has two supports while the trestle cap has three or more. Both frequently have overhanging ends to accommodate sidewalks or runways. The problems encountered in their design are not serious. Floorbeams are often suspended from the truss by rods and have bearing plates on their lower edge. Such plates should always be amply large to accommodate the maximum assumed loading without overstress as they are called upon to take the initial impact from the floor system and should be in no danger from crushing or breaking down under repeated loadings. Care should also be taken that the holes bored in the floorbeam for the hanger bolts do not leave the piece with less section modulus than is required for bending. The cap is usually weakest in longitudinal shear, especially if numerous piles are used. By the use of rod diagonals and bevelled washers the floorbeam can be made to act as the strut in the lateral system either in a through, deck or pony truss. This is illustrated in some of the details accompanying this chapter, as are also the other points that

have been and will be brought out in the discussion of floor-systems, trusses and trestles.

Handrailings, Felloe Guards, Drainage Details.—A handrailing is placed on a vehicular roadway to define the limits of the roadway, not for the purpose of withstanding impact of collision from moving wagons or automobiles. Its function is almost purely a psychological one and as such it should create a feeling of security in the driver that will allow him to drive very close to the rail without fear, even though the rail is too weak to withstand a head-on collision.

The felloe guard is the real protection against vehicles running off a bridge or trestle but without a rail to be seen above the fenders a driver would be very reluctant to bring his wheels anywhere close to the edge of the roadway because he could not see where he was.

The felloe guard also holds down the ends of the roadway plank and is therefore bolted very firmly to the stringers. In order to provide drainage through the felloe guard, holes are cut in the planking and felloe guard at frequent intervals but are kept small enough not to injure the strength of either. One such detail is shown on the Oregon Highway Commission Standard Trestle details (Fig. 8). There is also shown in the same sketch a detail of a drip board designed to prevent moisture from blowing against and soaking into the ends of the laminated decking and rotting the decking over the outside stringer.

In addition to the trestle detail of the Oregon Highway Commission are shown some details of the City of Seattle's timber floors for bridges. (See Fig. 31 at the end of this chapter.) The main points of difference are first the design loadings, the Oregon Standard being a 20-ton truck while the Seattle Standard is a 12½-ton, and second the treatment from the standpoint of maintenance. The Oregon Standard is designed to be located away from centers of industry and sources of repair material and where the traffic will be very light in point of total tonnage carried per year but yet subject to occasional very heavy loads. For these reasons it is designed to be covered with an asphalt wearing surface and left to itself for months at a time without any more than a yearly inspection. Then if maintenance or repair is needed, time is not as important a factor as in a large city and more time can be spent in the repairs.

On the other hand the Seattle Standard is to be located on heavily travelled business streets carrying as much tonnage in a week perhaps as the Oregon Standard carries in a year. It is also convenient to the sources of supply. It is therefore designed with a view toward cheapness in first cost as the greatest essential and facility for speedy repair of wornout parts as of the next importance. As they are almost always built in wholesale and factory districts not very much attention has been paid to aesthetics. It will be realized though that it is a very simple matter to remove a few plank and replace them with new ones without delaying traffic for more than a few hours. This is the reason for the guard rail being set up on blocks. In the typical section shown, the cap is given a 4-in. super-elevation on the sidewalk side to drain the water to the outside edge. When a full width roadway of 40 ft. is built, the cap is set level and the beveled shims mentioned earlier in this chapter are used.

4b. Trestles.—The simplest form of wooden bridge sub-structure is the pile bent. It has but the one type of member. The pile is post, footing and

(usually) bracing all in one. Pile bents are used in locations where it is impossible to obtain suitable foundation for an ordinary post or column pedestal. As the piles penetrate well into the subsoil and beyond the action of frost they are more stable in ordinary soils than the frame trestle on mud sills. For this reason it is very common practice for railroads to use piles wherever possible for low trestle and to drive piles and cap them at the ground line to form a sill for a frame trestle when a high trestle is required. The piles have an added advantage in that their safe load can be computed from the facts recorded when they are driven, namely the weight and height of fall of the hammer and the penetration of the pile at the last few blows. Once driven and capped it is unusual for a pile bent to show any

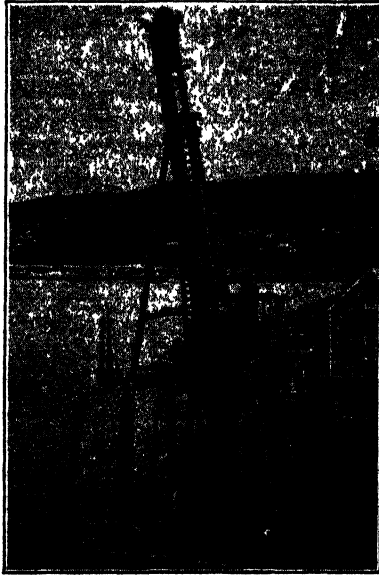

FIG. 29.—Young's Bay Bridge, Astoria, Oregon. Driving piles for the north trestle.

settlement under added load except in very soft ground. A pedestal or mud block under a frame trestle is much more likely to show settlement in ordinary soils. The choice between piling or framed timbers for bents will depend on (1) the soil, (2) the loadings to be carried, (3) the relative accessibility of piles and sawn timbers, and (4) the availability of a pile-driving outfit. Any trestle bent, either frame or pile, should have the outside piles or posts splayed outward at their lower ends to increase the lateral resistance to swaying. In driving batter piles in trestles it is customary to use what is called a *moonbeam driver* or one in which the top end of the hammer leads is pivoted and the bottom end swings in a vertical circle on a track, giving the pile any desired batter during the driving. Such a driver is shown at work in Fig. 29.

High bents are sway braced in both directions and have sash braces to divide the sway braces at regular intervals. In frame trestles the high bents can be built of a succession of low bents set one on top of the next (called *story framing*) as in the Oregon Standard or they can be built of full height sticks sash and sway

braced (called *balloon framing*) similarly to the high pile trestles. Both systems have their ardent advocates, but the designer will usually find that the available length of timber will fix the type.

Frame bents are usually set on a timber sill extending at right angles to the line of the trestle. These sills are carried either on concrete or timber blocks or on piles driven and capped at the ground line, the pile cap forming the sill for the frame bent. On rocky ground it is sometimes convenient to run in a sill of concrete and level it up and build the frame bent from that. Otherwise the concrete will be in the form shown on the Oregon Standard frame trestle.

Bracing is the most important item of a trestle bent. In low pile bents the stiffness of the pile forms the resistance to lateral and longitudinal distortion but in the frame trestle and in the high pile trestle it is necessary fully to reinforce the structure against swaying. These sway braces, sash braces, line braces or

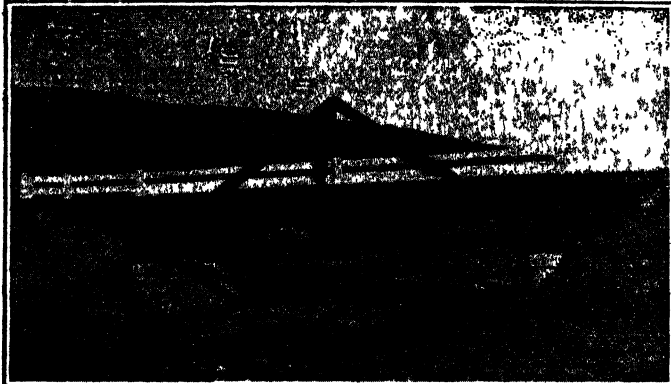

FIG. 30.

girts, and tower braces should be fastened at their ends with bolts and at the other intersections with boat spikes.

In connection with bracing it should be realized that a well-framed set of caps and bracing will present a neat and trim appearance that is not at all objectionable to the eye even if it cannot be said to be aesthetic. All ends of sway bracing should be trimmed to the line of the cap and no ragged corners of wood should ever be tolerated in the finished work. Correct finish is just as important on a trestle as on a concrete bridge and excites as much favorable comment from those who know good framing from bad.

Bracing in a longitudinal direction is of two main types: (1) Tower bracing and (2) lattice bracing. The horizontal girts, or line braces, should be run through in both, but in the tower braced type only the alternate openings are sway braced, leaving the others open.

4c. **Trusses.** *A-frames.*—The simplest form of truss is the A-frame or King post truss. In timber it is adaptable for spans of 20 to 40 ft. The inverted form in which the bottom chord is a V-shaped rod under a strut at the center of the beam is called a trussed beam and is not susceptible of analysis by simple statics.

The A-frame is almost always built as a pony truss when used for bridges and as such should have the apex supported laterally by a strut which is carried on the extended end of the floorbeam. Heavy construction calls for cast-iron bearing blocks at the bottom ends of the batter posts but in light or temporary work it is usually possible to frame the two timbers one against the other and bolt the intersection. The floorbeam may be suspended on the center rods or set on top of the chord, depending on the headroom desired. Hanging from the main rods gives a very much smaller distance from roadway floor to clearance but placing the floorbeam on top of the chord makes renewals and repairs easier and also lessens the height of pier required to reach a given roadway elevation.

The outrigger or strut from the apex should be framed and bolted to the side of the extended floorbeam and not set on top and bolted or spiked down. The bear-

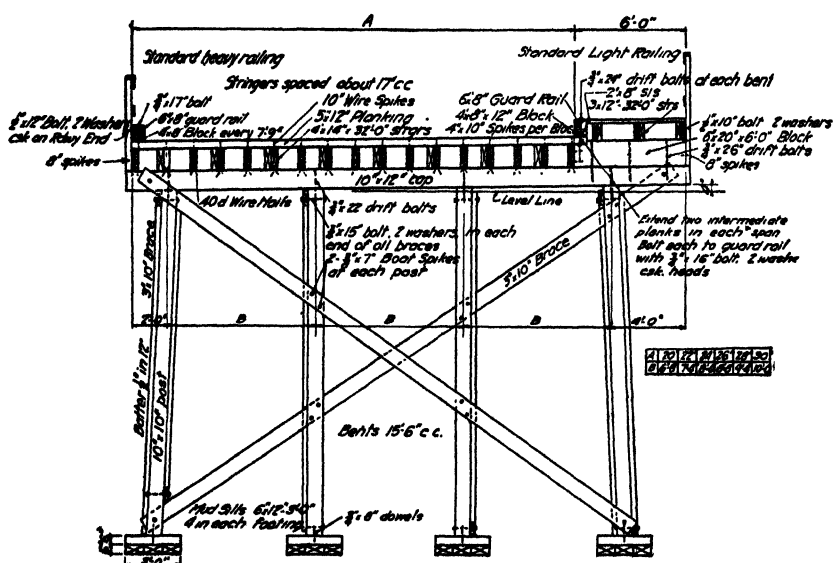

FIG. 31.—Typical section of roadway timber trestle, City of Seattle.

ing blocks at the ends of the batter posts can be either cast iron, oak or structural angles. Figure 30 shows the Oregon State Highway Commission 40-ft. A-frame with the floor beam above the chord.

Pony Trusses.—The simplest form of pony truss outside of the A-frame is the Queen post, wherein one panel of horizontal top chord is introduced between the end posts. The term applies more particularly to the type which has no diagonal web members in the center panel, thus causing the two chords to take in bending the shear that would otherwise be carried by the web.

Pony trusses of wood are adaptable for spans from 40 to about 70 ft. although this upper limit is rather too long for economy.

The railings on any truss with a diagonal web system of timber should be carried on posts independent of the web members because, if the rails are bolted to the diagonals, every passage of a load over the bridge works and strains the joints of the fence with the truss and the line of the rail cannot be maintained.

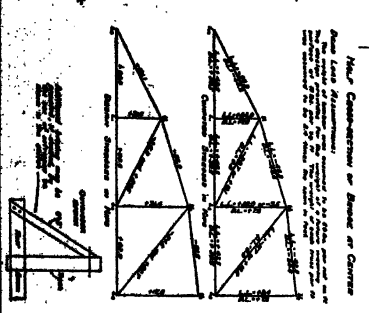
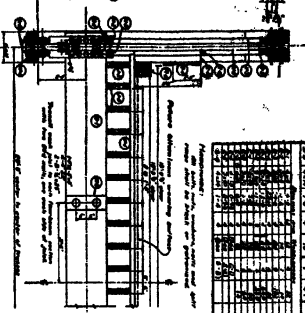
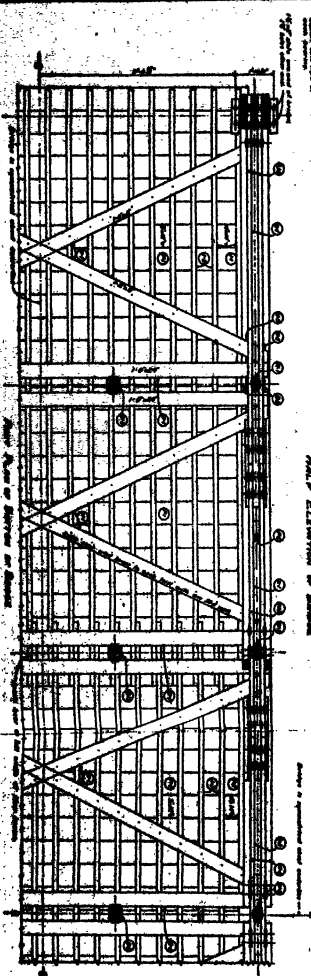
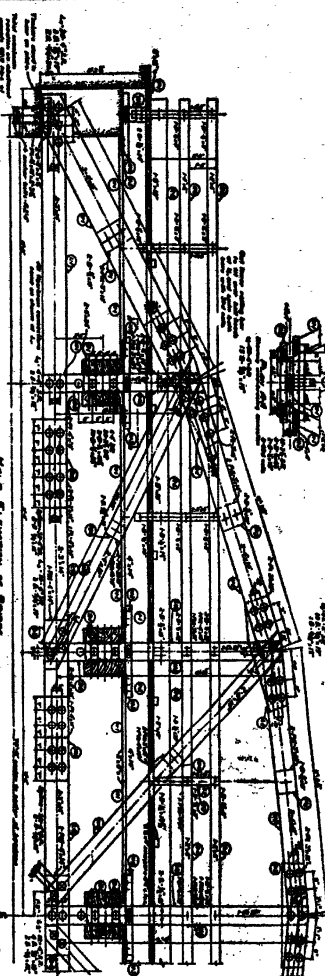
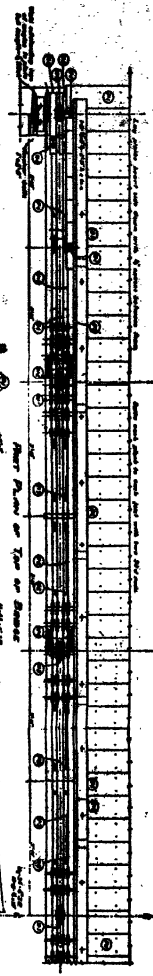

Item	Description	Quantity	Unit
1	Steel Trusses	1	Each
2	Steel Beams	1	Each
3	Steel Columns	1	Each
4	Steel Bracing	1	Each
5	Steel Decking	1	Each
6	Steel Girders	1	Each
7	Steel Plates	1	Each
8	Steel Bolts	1	Each
9	Steel Nuts	1	Each
10	Steel Washers	1	Each
11	Steel Rivets	1	Each
12	Steel Angles	1	Each
13	Steel Channels	1	Each
14	Steel I-Beams	1	Each
15	Steel H-Beams	1	Each
16	Steel L-Beams	1	Each
17	Steel Z-Beams	1	Each
18	Steel C-Beams	1	Each
19	Steel S-Beams	1	Each
20	Steel T-Beams	1	Each
21	Steel U-Beams	1	Each
22	Steel V-Beams	1	Each
23	Steel W-Beams	1	Each
24	Steel X-Beams	1	Each
25	Steel Y-Beams	1	Each
26	Steel Z-Beams	1	Each
27	Steel A-Beams	1	Each
28	Steel B-Beams	1	Each
29	Steel C-Beams	1	Each
30	Steel D-Beams	1	Each
31	Steel E-Beams	1	Each
32	Steel F-Beams	1	Each
33	Steel G-Beams	1	Each
34	Steel H-Beams	1	Each
35	Steel I-Beams	1	Each
36	Steel J-Beams	1	Each
37	Steel K-Beams	1	Each
38	Steel L-Beams	1	Each
39	Steel M-Beams	1	Each
40	Steel N-Beams	1	Each
41	Steel O-Beams	1	Each
42	Steel P-Beams	1	Each
43	Steel Q-Beams	1	Each
44	Steel R-Beams	1	Each
45	Steel S-Beams	1	Each
46	Steel T-Beams	1	Each
47	Steel U-Beams	1	Each
48	Steel V-Beams	1	Each
49	Steel W-Beams	1	Each
50	Steel X-Beams	1	Each
51	Steel Y-Beams	1	Each
52	Steel Z-Beams	1	Each
53	Steel A-Beams	1	Each
54	Steel B-Beams	1	Each
55	Steel C-Beams	1	Each
56	Steel D-Beams	1	Each
57	Steel E-Beams	1	Each
58	Steel F-Beams	1	Each
59	Steel G-Beams	1	Each
60	Steel H-Beams	1	Each
61	Steel I-Beams	1	Each
62	Steel J-Beams	1	Each
63	Steel K-Beams	1	Each
64	Steel L-Beams	1	Each
65	Steel M-Beams	1	Each
66	Steel N-Beams	1	Each
67	Steel O-Beams	1	Each
68	Steel P-Beams	1	Each
69	Steel Q-Beams	1	Each
70	Steel R-Beams	1	Each
71	Steel S-Beams	1	Each
72	Steel T-Beams	1	Each
73	Steel U-Beams	1	Each
74	Steel V-Beams	1	Each
75	Steel W-Beams	1	Each
76	Steel X-Beams	1	Each
77	Steel Y-Beams	1	Each
78	Steel Z-Beams	1	Each
79	Steel A-Beams	1	Each
80	Steel B-Beams	1	Each
81	Steel C-Beams	1	Each
82	Steel D-Beams	1	Each
83	Steel E-Beams	1	Each
84	Steel F-Beams	1	Each
85	Steel G-Beams	1	Each
86	Steel H-Beams	1	Each
87	Steel I-Beams	1	Each
88	Steel J-Beams	1	Each
89	Steel K-Beams	1	Each
90	Steel L-Beams	1	Each
91	Steel M-Beams	1	Each
92	Steel N-Beams	1	Each
93	Steel O-Beams	1	Each
94	Steel P-Beams	1	Each
95	Steel Q-Beams	1	Each
96	Steel R-Beams	1	Each
97	Steel S-Beams	1	Each
98	Steel T-Beams	1	Each
99	Steel U-Beams	1	Each
100	Steel V-Beams	1	Each

Item	Description	Quantity	Unit
1	Steel Trusses	1	Each
2	Steel Beams	1	Each
3	Steel Columns	1	Each
4	Steel Bracing	1	Each
5	Steel Decking	1	Each
6	Steel Girders	1	Each
7	Steel Plates	1	Each
8	Steel Bolts	1	Each
9	Steel Nuts	1	Each
10	Steel Washers	1	Each
11	Steel Rivets	1	Each
12	Steel Angles	1	Each
13	Steel Channels	1	Each
14	Steel I-Beams	1	Each
15	Steel H-Beams	1	Each
16	Steel L-Beams	1	Each
17	Steel Z-Beams	1	Each
18	Steel C-Beams	1	Each
19	Steel S-Beams	1	Each
20	Steel T-Beams	1	Each
21	Steel U-Beams	1	Each
22	Steel V-Beams	1	Each
23	Steel W-Beams	1	Each
24	Steel X-Beams	1	Each
25	Steel Y-Beams	1	Each
26	Steel Z-Beams	1	Each
27	Steel A-Beams	1	Each
28	Steel B-Beams	1	Each
29	Steel C-Beams	1	Each
30	Steel D-Beams	1	Each
31	Steel E-Beams	1	Each
32	Steel F-Beams	1	Each
33	Steel G-Beams	1	Each
34	Steel H-Beams	1	Each
35	Steel I-Beams	1	Each
36	Steel J-Beams	1	Each
37	Steel K-Beams	1	Each
38	Steel L-Beams	1	Each
39	Steel M-Beams	1	Each
40	Steel N-Beams	1	Each
41	Steel O-Beams	1	Each
42	Steel P-Beams	1	Each
43	Steel Q-Beams	1	Each
44	Steel R-Beams	1	Each
45	Steel S-Beams	1	Each
46	Steel T-Beams	1	Each
47	Steel U-Beams	1	Each
48	Steel V-Beams	1	Each
49	Steel W-Beams	1	Each
50	Steel X-Beams	1	Each
51	Steel Y-Beams	1	Each
52	Steel Z-Beams	1	Each
53	Steel A-Beams	1	Each
54	Steel B-Beams	1	Each
55	Steel C-Beams	1	Each
56	Steel D-Beams	1	Each
57	Steel E-Beams	1	Each
58	Steel F-Beams	1	Each
59	Steel G-Beams	1	Each
60	Steel H-Beams	1	Each
61	Steel I-Beams	1	Each
62	Steel J-Beams	1	Each
63	Steel K-Beams	1	Each
64	Steel L-Beams	1	Each
65	Steel M-Beams	1	Each
66	Steel N-Beams	1	Each
67	Steel O-Beams	1	Each
68	Steel P-Beams	1	Each
69	Steel Q-Beams	1	Each
70	Steel R-Beams	1	Each
71	Steel S-Beams	1	Each
72	Steel T-Beams	1	Each
73	Steel U-Beams	1	Each
74	Steel V-Beams	1	Each
75	Steel W-Beams	1	Each
76	Steel X-Beams	1	Each
77	Steel Y-Beams	1	Each
78	Steel Z-Beams	1	Each
79	Steel A-Beams	1	Each
80	Steel B-Beams	1	Each
81	Steel C-Beams	1	Each
82	Steel D-Beams	1	Each
83	Steel E-Beams	1	Each
84	Steel F-Beams	1	Each
85	Steel G-Beams	1	Each
86	Steel H-Beams	1	Each
87	Steel I-Beams	1	Each
88	Steel J-Beams	1	Each
89	Steel K-Beams	1	Each
90	Steel L-Beams	1	Each
91	Steel M-Beams	1	Each
92	Steel N-Beams	1	Each
93	Steel O-Beams	1	Each
94	Steel P-Beams	1	Each
95	Steel Q-Beams	1	Each
96	Steel R-Beams	1	Each
97	Steel S-Beams	1	Each
98	Steel T-Beams	1	Each
99	Steel U-Beams	1	Each
100	Steel V-Beams	1	Each

TRUSS ENGINEERING COMPANY
 270 HOWE TRUSS
 AND BRIDGE
 TRUSS
 (Various Types and Sizes)

Housing for a pony truss consists of a shed roof over each top chord and siding just far enough from the truss to permit of inspection of the truss members from inside the housing.

Through Trusses.—Through trusses of wood are built in spans as short as 60 ft. but the upper limit of length is problematical. Accompanying this chapter is

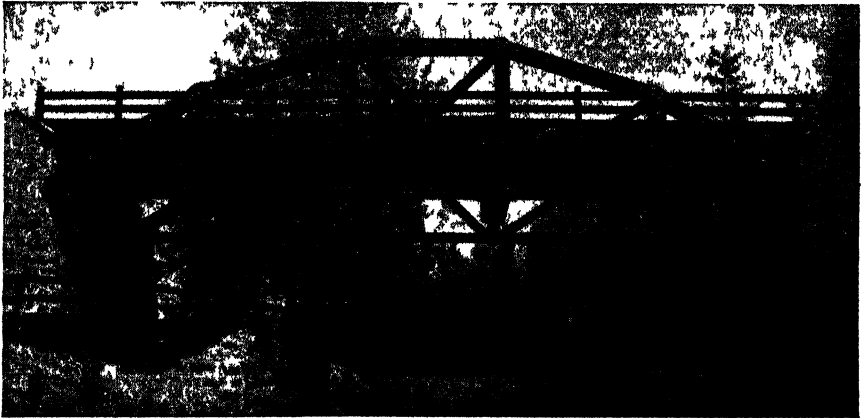

FIG. 35—Ring-connected timber bridge over Johnson Creek near Portland, Ore. Span is 60 ft. 0 in., roadway width 20 ft. 0 in., designed for the H-15 loading (Courtesy of Timber Engineering Co.).



FIG. 36—Timber bridge over Buffalo Creek, near Lewisburg, Pa. Span is 182 ft. 0 in. (Courtesy of Timber Engineering Co.).

a plan and the detail sheets for a 190-ft. 2-in. wood span to carry a 12-ton truck. Spans have been built as long as 212 ft., but anything over 150 ft. may be called rare. Especially is this true in connection with present day highway loadings.

Also accompanying this chapter are the Oregon State Highway Commission drawings of a 60-ft. and a 150-ft. wood span to carry a 20-ton truck. They are complete as to details and a careful perusal by the reader will disclose more

information than space permits of describing here. Attention is called to the single piece chords and resultant framing of the short span as compared to the triple stick chord and splices of the longer. The floorbeams of the shorter are suspended on the main rods while in the long span they are placed on the chord, thus producing bending in the chord as well as direct stress and requiring a much larger depth of chord stick. Splice details are not shown on the general drawing of the long truss but there is one tension splice at every break in the continuity of the lower chord sticks. The tension splices are detailed on the sheet of structural steel details. The packing blocks for transferring the stress from one stick to the others are also shown as well as the cast-iron angle blocks for use on all standard trusses from 60 to 150 ft. long, for the type with floor beams carried on the chord.

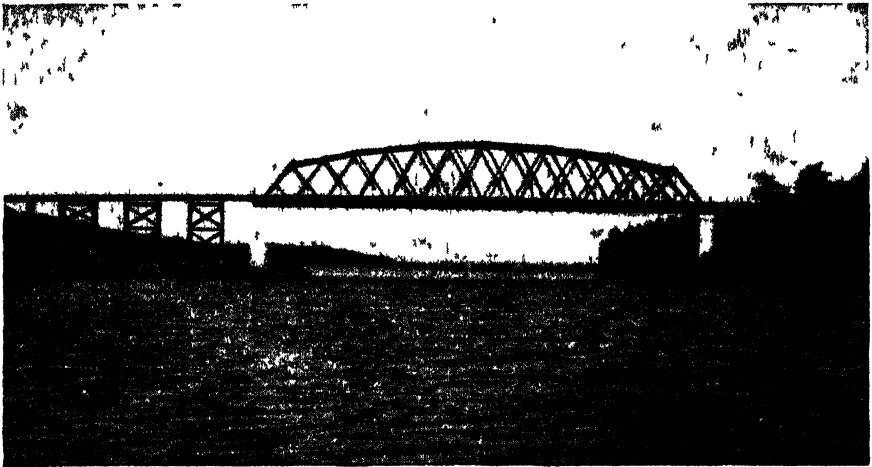

FIG. 37.—Sioux Narrows bridge, Ontario, Canada. This 210 ft span bridge, built by the Canada Creosoting Co., Montreal, is one of many connector-built bridges erected in the province of Ontario. Spans range from 90 ft to the 210-ft. bridge shown above. All framing of the approaches and superstructure made with Teco split ring connectors. (Courtesy of Timber Engineering Co.)

The sheet of structural details gives all plates and splices for the same range and type.

The 60-ft. truss and details shown with it are those for the type having suspended floorbeams and single stick chords. On this account the dimensions of splices and blocks are not given for trusses of lengths greater than 105 ft. as a longer stick than the lower chord of the 105-ft. truss is very difficult to obtain from a mill, or ship on the railroads. They can, however, be obtained by hewing from a special log if the span is being built in a locality where there is good timber.

Other details of interest in all three of the trusses shown are the lateral systems, main and intermediate portals, housing, railings, arrangement of tension verticals and the details of structural bearing plates for tension rods.

4d. Timber Bridges.—In Figs. 32, 33 and 34 are shown designs of three typical modern highway bridges in which the Teco connector system has been utilized to produce economical structures with good architectural lines.

Figure 32 is a line drawing of a King Post truss, having a span of 30 ft. 0 in. and a roadway width of 18 ft. 0 in. It was designed to accommodate H10 loading.

Figure 33 is a line drawing of a Double Warren truss, having a span of 70 ft. 0 in. and a roadway width of 18 ft. 0 in. The design is in accordance with H15 loading.

Figure 34 shows a line drawing of a Pony truss, with span of 70 ft. 0 in. and roadway width of 18 ft. 0 in. It was designed for H15 loading.

Figures 35, 36 and 37 illustrate several types of timber bridges of varying spans. All utilize timber connectors of the several types available.

SECTION 5

STEEL TANKS

Steel plate work that is to contain a liquid must be designed and detailed so as to be readily made liquid-tight by ordinary shop and erection methods. Not only should the design be such that the unit stresses are within proper limits but it is also very important that the design be such that the caulking can be continuous and can be done as the work progresses. Also, if possible, it should permit of the caulking being gone over after test. Frequently, these points are not given sufficient consideration in working up design drawings and specifications.

It is essential that the probable method and sequence of erection should be kept in mind, watching particularly the connection of the bottom to the tank shell, pipe connections, anchor bolt brackets, and any auxiliary members that may be fastened to the shell or bottom, or any special features that the tank may have. Frequently it is necessary to use structural members for stiffeners, guides, or girders, or to have a partition or enlarged opening. All these should be on the non-caulked side if possible, and should not cross a seam if on the caulked side, as it is next to impossible to get such a seam tight.

In this connection, it is well to keep in mind the following: (1) That the heel of an angle or channel, or the end of a rolled shape in general, cannot successfully be caulked tight against a plate; (2) that it is the best practice to have the newly formed head of the rivet (or, in other words, drive the rivet) on the caulked side, although rivets can be driven on the non-caulked side if extreme care is taken in heating and driving; (3) that all rivets in a seam should be in place before it is caulked as the driving of additional rivets is very liable to spring the caulking and cause leaks that are hard to correct; and (4) that it is almost universal practice to caulk large tanks on one side only (not both inside and outside). Sometimes, in somewhat complicated designs, both inside and outside caulking are specified. It is better practice to make the design such that the caulking will be continuous on one side and call for caulking on that side only—otherwise, the continuity of the caulking is very liable to be broken. Even if this does not occur on both sides in the same place, it is likely to cause leaks. On practically all tanks, due to pipe connections, ladder connections, roof framing, etc., it is almost impossible to make the caulking continuous both inside and outside. Thus specifying inside and outside caulking and trusting to luck will not make a liquid-tight tank.

VERTICAL CYLINDRICAL TANKS

1. Tank Size.—The most common of the vertical cylindrical tanks are water storage tanks and are commonly known as standpipes. The height and diameter are determined to meet local requirements. If the elevation of the tank is such that just as the standpipe is being emptied the pressure is sufficient to meet local

requirements, it is most economical to build a tank of large diameter and low height. (If a roof is included, height = about 0.4 the diameter; if no roof is included, make height somewhat lower.) On the other hand, if a minimum head has to be maintained at all times within the standpipe, to secure the desired pressure, a smaller diameter tank will be most economical. The minimum weight tank will have to be found by comparing trial designs. For designs quite similar, the cost will vary about as the weight.

The desired net capacity is determined in various ways, mostly by off-hand and arbitrary methods. It should be determined by computing the most economical tank when the plant as a whole is considered. Having the hourly requirements, the capacity of the tank should be such as to give the most efficient operation of the water plant as a whole and, at the same time, a proper margin of safety should the source of supply be cut off for a time. Too frequently the capacity of the tank is so small that the pumps have to be operated the full 24 hours of the day. A large tank would eliminate the night turn and help out at peak loads, thus allowing the pumps to operate at more nearly their maximum efficiency.

The cost of the standpipe, its foundations, and special supply main should be compared with the cost of an elevated tank of the same net capacity. By selecting the proper location for an elevated tank, a saving can be frequently made in the cost of the supply main and reduce friction losses.

2. Size of Plates.—It makes a better appearing tank to have the net width of the various rings the same. The lengths of the plates should be from 17 to 20 ft. Shorter plates make an undue number of plates to handle and an excess of vertical joints to be riveted and made tight, while plates longer than 20 ft. are difficult to handle both in the shop and field. Plates as wide as 8 to 9 ft. are often used but there is a great deal to recommend in the 6-ft. width, except perhaps on heavy plates where high efficiency butt joints are used or on very high tanks. The 6-ft. width can be handled quickly both in the shop and field and permits the thickness to be changed so as to have an economical design. Last, but not least, this width is rolled by all plate mills, being the maximum width for many mills. Thus advantage can be taken of steel prices and freight rates on 6-ft. plates and with the prevailing high freight rates, the latter makes a marked difference in cost. Frequently better deliveries can be had on this width as the plates can be bought from a large number of mills.

Plates of usual thickness, after allowance has been made for edging and bevel shearing, net about 3 in. less than their ordered width (see Fig. 1 for edging of various sized rivets).

3. Thickness of Plates and Designing of Vertical Joints.—Having selected the diameter of the tank, its height, the number of rings in the tank, and the number of plates per ring, the thickness for each ring can be found by means of the following equations and Tables 1 and 2.

$$S = 2.6HD \quad (1)$$

$$s = \frac{2.6HD}{t} \quad (2)$$

$$t = \frac{Te}{s} \quad (3)$$

$$t = \frac{S}{u} = \frac{2.6HD}{u} \quad (4)$$

Where

- S = stress per inch of vertical height of shell.
- D = diameter in feet.
- H = maximum head of water in feet above point.
- s = stress per square inch in plate.
- u = allowable unit stress in pounds per square inch.
- T = gross thickness of plate in inches.
- t = effective thickness in inches.
- e = efficiency of riveted joint.

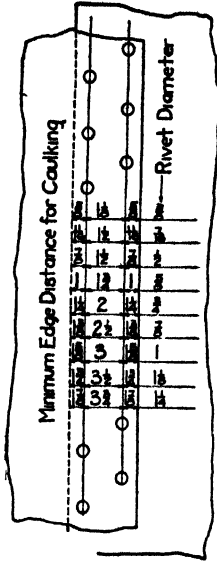

FIG. 1.

By taking the value of t , found by eq. (4), the gross thickness, riveting, etc., can be selected from Table 1 or 2, to meet the required unit stress. The best specifications call for a unit stress in water tanks of 12,000 to 15,000 lb. per sq. in. with no additional allowance for corrosion. Another method is to permit a unit stress of 15,000 to 21,000 lb. per sq. in. with $\frac{1}{16}$ to $\frac{1}{8}$ in. added to the computed gross thickness for corrosion. The first method is preferable and more workable as it gives a more balanced design. As corrosion is never as severe at the joint as in the main body of the plate, there is really extra metal in the body of the plate to offset corrosion. In large field off tanks unit stresses of 27,000 to 29,000 lb. per sq. in. are frequently found, but these stresses are not advisable.

If the unit stress is to be adhered to absolutely, some allowance must be made in the net thickness in the general design, due to the fact that in detailing the joint, the ideal rivet pitch as given in Tables 1 and 2 cannot be maintained. However, the variation from the ideal pitch of a lap joint will not usually change the unit stress more than 2 per cent.

The details of a vertical joint can be checked as follows: Assume $D = 30$ ft., $H = 57$ ft. 6 in., allowable unit stress in plates = 12,000 lb. per sq. in., allowable shear on rivets = 9,000 lb.

By eq. (4) we have

$$t = \frac{2.6HD}{u} = \frac{(2.6)(57.5)(30)}{12,000} = 0.373 \text{ in.}$$

Going to Table 1, we find that $\frac{1}{2}$ -in. plates with 4 rows of $\frac{3}{4}$ -in. diameter rivets pitched 3.53 in. have an effective thickness of 0.376 in., while $\frac{1}{2}$ -in. plates with 4 rows of $\frac{7}{8}$ -in. diameter rivets pitched 4.61 in. have an effective thickness of 0.391 in. and $1\frac{1}{8}$ -in. plate with four rows of $\frac{5}{8}$ -in. diameter rivets pitched 2.48 in. have an effective thickness of 0.371 in. Due to the saving in metal and the fact that $\frac{5}{8}$ -in. bolts are somewhat light to draw $1\frac{1}{8}$ -in. plates, the $\frac{1}{2}$ -in. plate will be used.

From Fig. 1, the edging for $\frac{3}{4}$ -in. diameter rivets is $1\frac{1}{4}$ -in. The standard allowance for bevel shearing is the thickness of the plate, or $\frac{1}{2}$ in., making $1\frac{3}{4}$ -in. allowance at each edge of the plate. Assume the plate to be ordered 6 ft. wide. This makes a net width of 5 ft. $8\frac{1}{2}$ in. It is the best practice to make the spacing across the end uniform. Nineteen spaces will make a rivet pitch of 3.6053 in. and twenty spaces will make a pitch of 3.425. As 3.6053 in. is nearest the ideal pitch of 3.53 in. it will be adopted.

Further investigation can be made if conditions seem to warrant it as follows:

$$S = 2.6HD \quad (1)$$

$$s = \frac{2.6HD}{t} = \frac{Sp}{(p-d)T} \quad (5)$$

$$r = \frac{Sp}{na} \quad (6)$$

Where

p = pitch of rivet in any one line of rivets in inches.

d = diameter of rivet hole in inches.

r = shear on rivet in pounds per square inch.

n = number of rivets in given pitch.

a = cross-sectional area of rivets in square inches.

$S, s, H, D, t,$ and T have values previously given.

Assuming the diameter of the rivet as $\frac{3}{4}$ in. and diameter of rivet holes as $\frac{3}{4} + \frac{1}{8} = \frac{7}{8}$ in.

$$S = 2.6 HD = (2.6)(57.5)(30) = 4,485 \text{ lb. per in.}$$

$$s = \frac{(4,485)(3.6053)}{(3.6053 - 0.875)(0.5)} = 11,825 \text{ lb. per sq. in.}$$

$$r = \frac{Sp}{na} = \frac{(4,485)(3.6053)}{(4)(0.4418)} = 9,125 \text{ lb. per sq. in., shear on rivets.}$$

It will be noted that the shear on the rivets is 1.4 per cent over the assumed unit stress for shear. The other rings can be designed similarly. For the top ring one row of rivets will be found to be sufficient and plates less than $\frac{1}{4}$ in. thick will meet the required unit stresses, but it is best not to have plates less than $\frac{1}{4}$ in. for water tanks and $\frac{3}{16}$ in. for oil. Frequently, $\frac{5}{16}$ in. or $\frac{3}{8}$ in. are the minimum thicknesses permitted. This depends upon the nature and size of the tank. It is practically always found that the upper plates of a water tank which are alternately wet and dry show signs of corrosion before the plates that are always immersed.

Where either the height or diameter is large so that plates much thicker than $\frac{1}{2}$ in. are required, it is best to use high efficiency butt joints in the vertical seams. Table 2 gives the properties of this type of joint. It will be noted that efficiencies greater than 90 per cent are readily obtained. At first glance, Table 2 seems to be inconsistent with Table 1 as the rivet hole is taken only $\frac{1}{16}$ in. larger than the nominal diameter of the rivet and the area of rivet as the area of hole. For lap joints and light plates, the holes are punched full size and are not usually reamed in the shop or field. Thus the area of the rivet is assumed for the nominal diameter. With heavier plates, however, where butt joints are used, the holes are

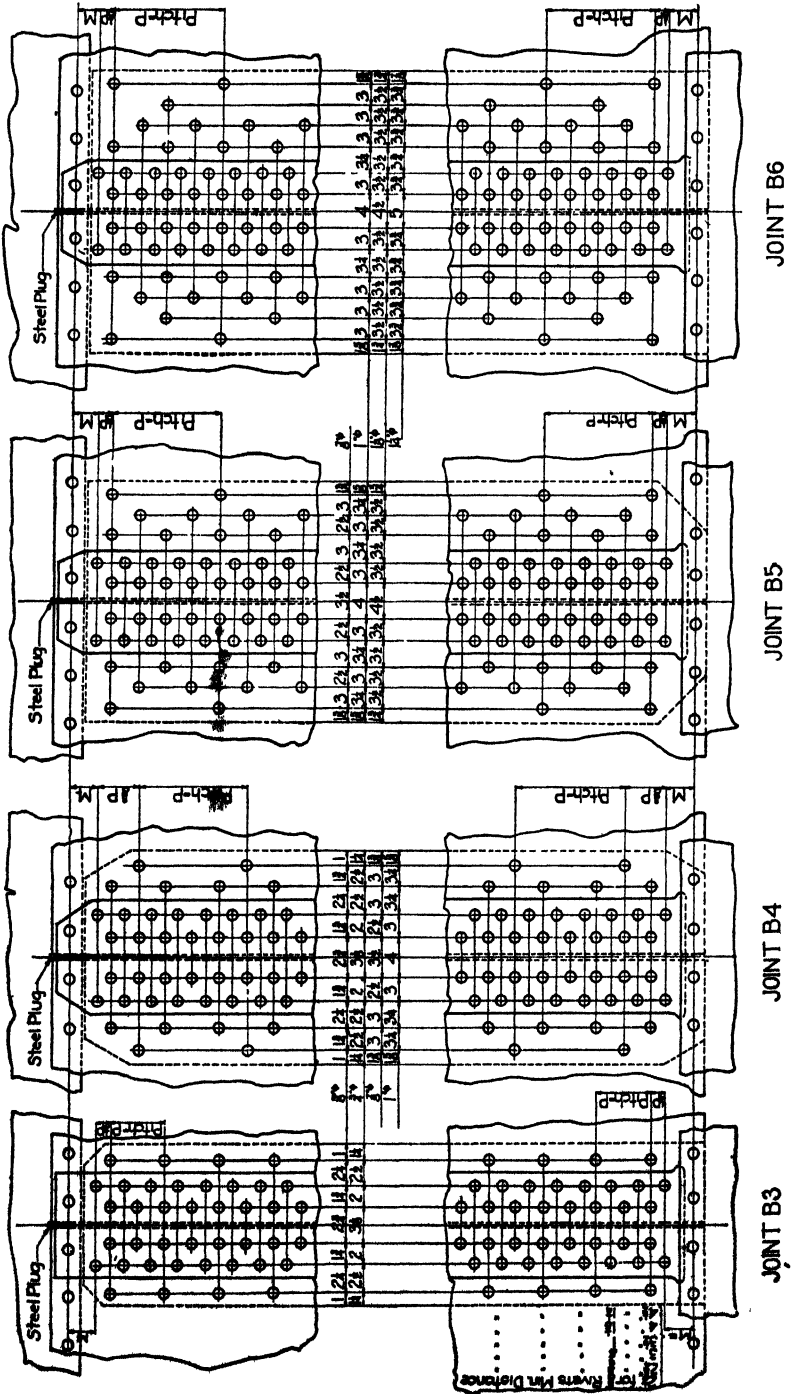

Fig. 2.

practically always sub-punched, and reamed, or drilled from the solid. This insures uninjured metal around the rivet hole and as the rivet will have to fill the full-sized hole, its area can be taken the same as the hole. This is in accordance with the American Society of Mechanical Engineers' specifications for boilers. This high efficiency butt joint is used extensively on large boilers that are subject to very strict specifications and inspection.

A glance at Fig. 1 will reveal that the edge distance is slightly less than $1\frac{1}{2}$ times the diameter of the rivet in some cases. This is done to facilitate caulking as it tends to prevent the plates springing apart when fullered. This in no way impairs the strength of the joint as the plates are always sufficiently thick for two or more rows of rivets at the same pitch.

It will be noted that Tables 1 and 2 are based on the following: Tension of plate = 1.0; shear on rivet = 0.75; bearing = 1.5. These ratios are in accordance with about what is found in general practice. A different set of ratios would change the various items in the tables somewhat.

As previously stated in connection with lap joints, it is not possible in detailing a joint to keep the ideal pitch of Tables 1 and 2. There is even more variation from this pitch in detailing the butt joint, as the pitch is much larger. A change from the ideal pitch of this joint affects the efficiency more than in a lap joint. It is feasible to use plates ordered about 100 in. wide, especially if there are several rings of butt joints. The distance M in Fig. 2 can be increased from the minimum distance to the maximum distance allowable for caulking—that is, eight times the thickness of the thinnest plate for one row of rivets; and nine times for two or more rows for oil, and ten times for water. With this adjustment in the distance M at each end and the variation of the pitch that can be had by changing the end detail, as will be explained later, the ideal pitch as given in Table 2 can be approached very nearly. If it cannot be followed exactly, it is usually better to adopt a pitch less than that in the table. If the rings are alternately in and out, as is customary where butt joints are used, both ends of the butt straps will be similar, except in the bottom ring due to the bottom angle. When the rings build in or build out—otherwise known as telescopic or shingle rings—the end details of the butt straps will be different.

In joint B_4 , it will be noted that there is $\frac{3}{8}$ of a pitch P after the distance M before the integral pitches P begin. This could just as well be $\frac{1}{8}$, $\frac{5}{8}$ or $\frac{7}{8}$ P . If both ends of the butt straps are similar, the net width of the plate will be taken up by $2M$ plus a number of integral pitches P and twice $\frac{3}{8}$, $\frac{5}{8}$ or $\frac{7}{8}$ P , whichever gives the nearest ideal value for P .

In exceptional cases, it may be best to make, say $\frac{3}{8}$ P at one end and $\frac{5}{8}$ P at the other, thus making the two ends of the butt strap different. Similarly $\frac{1}{4}$ and $\frac{3}{4}$ P can be used for B_3 , and $\frac{1}{8}$, $\frac{3}{8}$, $\frac{5}{8}$ or $\frac{7}{8}$ P for joints B_4 , B_5 or B_6 .

In some cases, in order that the plates can be sub-punched on a special spacing machine, it is necessary that the distance M be equal to the rivet pitch in the outside row of the narrow butt strap. This adds another condition so that it is quite hard to design the joint and keep the efficiency as shown in Table 2.

At the top of the joints, B_3 , B_4 , B_5 and B_6 , the narrow or caulked butt strap extends up over the roundabout seam while at the bottom it is scarfed to tuck under adjacent ring. At the top it is necessary to use a steel plug commonly called *dutchman*, 2 or 3 in. long, to fill the open space between the main shell plates. This plug should be made of such size that it can be securely driven into

place and then caulked. Note that the top edge distance of the narrow butt strap is slightly less than the edging on the main plate with which it is in contact, so that it can be caulked across the end. In some cases it may be necessary to make the edging on the main plate a little more than standard so as to get this result.

In the figures for joints *B3*, *B4*, *B5*, *B6*, the top and bottom ends are shown differently for economy of space.

If the pitch adopted varies more than $\frac{1}{8}$ or $\frac{1}{4}$ in. from the ideal pitch in the table, the joint should be checked for unit stresses.

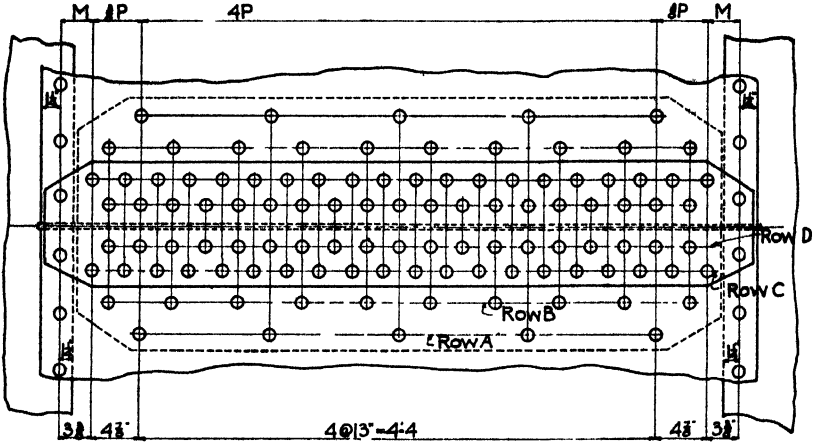

FIG. 2A.

Illustrative Problem.—Assume a tank 30 ft. in diameter and a joint with a head of 75 ft., allowable tension on plate = 12,000 lb. per sq. in., shear on rivets = 9,000 lb. per sq. in., bearing = 18,000 lb. per sq. in.

From eq. (1)

$$S = 2.6HD = (2.6)(75)(30) = 5,850 \text{ lb. per in.}$$

From eq. (4)

$$t = \frac{2.6 HD}{u} = \frac{(2.6)(75)(30)}{12,000} = 0.487 \text{ in.}$$

Referring to Table 2, it is found that a $1\frac{1}{2}$ in. plate with joint *B4*, and with four rows of $\frac{3}{4}$ -in. rivets pitched 13 in. has an effective thickness of 0.488 in. Assuming the ordered width of plate is 72 in., and allowing $\frac{1}{2}$ -in. at each edge for bevel shearing and $1\frac{1}{4}$ -in. edging for $\frac{3}{4}$ -in. rivets, the net width of the ring would be 68 $\frac{1}{2}$ in. Using $M = 3\frac{3}{8}$ in. there would be four integral pitches at 13 in. and $\frac{3}{8}$ of a pitch at each end (see Fig. 2A for layout of joint).

P = pitch in outside row = 13 in.

d = diameter of rivet hole in inches = 0.8125 in.

A = area of rivet hole = area of rivet = 0.5185 sq. in.

T = thickness of shell plate = 0.53125 in.

b = thickness of wide butt strap = 0.4375 in.

r = shear on rivets, allowable = 9,000 lb. per sq. in.

s = tension on plate, allowable = 12,000 lb. per sq. in.

B = bearing, allowable = 18,000 lb. per sq. in.

t = effective thickness of plates in inches.

c = value of a rivet in single shear.

From the above $S = 5,850$ lb. per in.

$PS = (5,850)(13) = 76,050$ lb., total stress in plate center to center of two outside rivets.

$$\frac{PS}{(P-d)T} = \frac{76,050}{(13-0.8125)(0.5313)} = 11,750 \text{ lb. per sq. in. in plate between two outside rivets. (Row A.)}$$

$$c = (9,000)(0.5185) = 4,667 \text{ lb. value of one rivet in single shear.}$$

$$\frac{PS-c}{(P-2d)T} = \frac{76,050-4,667}{(11.375)(0.5313)} = 11,825 \text{ lb. per sq. in. in plate between two rivets. (Row B.)}$$

$$\frac{PS-3c}{(P-4d)T} = \frac{76,050-14,000}{(9.75)(0.5313)} = 11,975 \text{ lb. per sq. in. in plate between two rivets. (Row C.)}$$

$$B = \frac{PS-3c}{(8d)T} = \frac{76,050-14,000}{(8)(0.8125)(0.5313)} = 17,900 \text{ lb. per sq. in., bearing on rivets that are in double shear.}$$

$$B' = \frac{4,667}{(0.8125)(0.375)} = 15,300 \text{ lb. per sq. in., bearing on rivets in single shear in a wide butt strap.}$$

The unit stress in the wide butt strap between two rivets in the row next to the center line (Row D) of the joint is

$$(a) \frac{\frac{1}{2}(PS-3c)+3c}{(P-4d)b} = \frac{\frac{1}{2}(76,050-14,000)+14,000}{(9.75)(0.4375)} = 10,550 \text{ lb. per sq. in. between two rivets in wide butt strap. (Row D.)}$$

$$r = \frac{PS-3c}{16A} = \frac{76,050-14,000}{(16)(0.5185)} = 7,500 \text{ lb. per sq. in. shear on rivets that are in double shear.}$$

Thus all unit stresses are below the allowable so that the joint is satisfactory. It will be noted that in designing this type of joint, a length P is taken as a unit and the stresses worked out accordingly. In statement (a) it is assumed that one-half of the stress remaining, after the value of three rivets in a single shear is taken from the total stress 76,050, is carried by the narrow strap and the other half is carried by the wide half. In addition the wide strap has to carry three rivets in single shear. This stress is taken care of in a length of plate equal to $P-4d$.

4. Design of Horizontal Joints.—The rivets in the circumferential seam can usually be spaced the maximum distance for caulking—namely, ten times the thickness of the thinnest plate for water and eight times for oil—as the only function of these rivets is to draw the plates together to make a liquid-tight joint. (In high tanks of small diameter this riveting should, of course, be checked for wind stresses, see Wind Stresses in self-supporting steel chimneys, Arts. 34 and 35, Sec. 6.) The rivets in this seam should not be spaced closer together than about three times the diameter nor further apart than six times the diameter. The spacing in this joint for any one seam should be uniform to eliminate expensive fabrication and erection, and aid in getting good fitting holes. It also permits the plates to move around the tank slightly should the occasion arise. Where there is no roof, or a roof that is not liquid or gas-tight, it is usual to make the rivet pitch in the vertical leg of the top angle twice that at the bottom of the top shell ring to which it is attached. On the other hand, the spacing in the vertical leg of the bottom angle that connects the bottom plates to the first shell ring (see Fig. 7, p. 421), should be about the minimum pitch—that is, 2 in. for $\frac{5}{8}$ -in. rivets, 2½ in. for $\frac{3}{4}$ -in. rivets, 3 in. for $\frac{7}{8}$ -in. rivets, and 3¼ to 3½ in. for 1-in. rivets.

This pitch should be used, as the bottom is very rigid when bolted up, and there should be plenty of opportunity to pull the first shell ring up to the bottom

angle. In case the bottom angle is omitted and the bottom plates flanged up to make the connection to the first shell ring, the same pitch should be used as mentioned above.

In the vertical leg of the bottom angle, the same size rivets are generally used as in the vertical joint of the first shell ring. Likewise the rivets in the circumferential seam between the first and second ring are the same size as those in the vertical joint in the second ring, and so on for the rest of the tank. The bottom angle is usually made one-half to three-fourths as thick as the bottom shell ring and it should be of such width as to take one row of rivets easily. A slightly wider gage than for structural work should be used so that the rivet heads on the horizontal leg do not interfere with the driving of the rivets in the vertical leg. This also permits of more clearance for the rivets in the splice angles

The splice angles that go on the inside of the main angle are of the same thickness as the main bottom angles or slightly less. It is not usual to make the splice for the full strength of the bottom angles but the splice should be long enough to take three rivets on each side of the center line of the splice on each leg of the angle. The edging on the splice angle should be less than on the main angle so that it may be caulked against the main angle. This point is often overlooked in detailing and fabricating but it should be given special attention.

5. Bottom Plates.—The minimum thickness for bottom plates for water tanks should be $\frac{1}{4}$ in., excepting $\frac{3}{16}$ in. may be used for light tanks that have $\frac{3}{16}$ -in. plates in the shell. Plates of $\frac{1}{4}$ -in. thickness may be used for the bottom of oil tanks, (although many oil companies specify $\frac{3}{8}$ -in. minimum thickness) in which case the plates that connect to the roundabout angle should be at least $\frac{1}{4}$ in. thick for large tanks (75 ft. in diameter and up) as there is considerable strain on these plates when the bottom is lowered. In water tanks, the tendency is to have the bottom plates $\frac{5}{16}$ in. and even $\frac{3}{8}$ in., while in oil tanks the tendency is to make the plates $\frac{1}{4}$ in. and frequently $\frac{5}{16}$ in. thick. Figure 3 shows some of the best arrangements of bottom plates for various diameter tanks, so as to have a minimum amount of riveting and caulking and at the same time cut well from rectangular plates. Bottoms less than 30 to 35 ft. in diameter may have the outer edge flanged up to make the connection to the shell. The flanging is usually done cold.

The rivets should be spaced about the minimum distance in the bottom and small rivets used in preference to large, as the smaller rivets with close pitch give a tighter bottom. The rivets through the horizontal leg of the bottom angle are usually the same size as the rivets in the bottom plates. Where the thickness of the bottom angle is much more than the diameter of the rivet in the bottom plating, it is necessary to use a larger size rivet through the angle.

6. Caulking at Bottom Angle.—The bottom should be caulked on the inside unless special requirements necessitate its being caulked on the bottom side. If the shell is to be caulked on the outside, a change from the inside to outside caulking should be made at the bottom angle. This can be done by caulking the major part of the horizontal leg of the bottom angle up to within 2 or 3 rivets of the splice and placing a stop-water between the angles and the bottom plate; then going on the outside and caulking the outer edge of the bottom plates against the horizontal leg of the bottom angle past the splice to a similar stop-water on the other side, where again the horizontal leg of the angle is caulked on the inside. Where this is done, it is necessary to splice the bottom angle by

means of a wrapper plate made in the shape of an angle curved to the diameter of the tank and having its ends tapered gradually to the thickness of $\frac{1}{8}$ in. or less. These wrapper plates are usually about $\frac{3}{8}$ in. thick and are placed between the

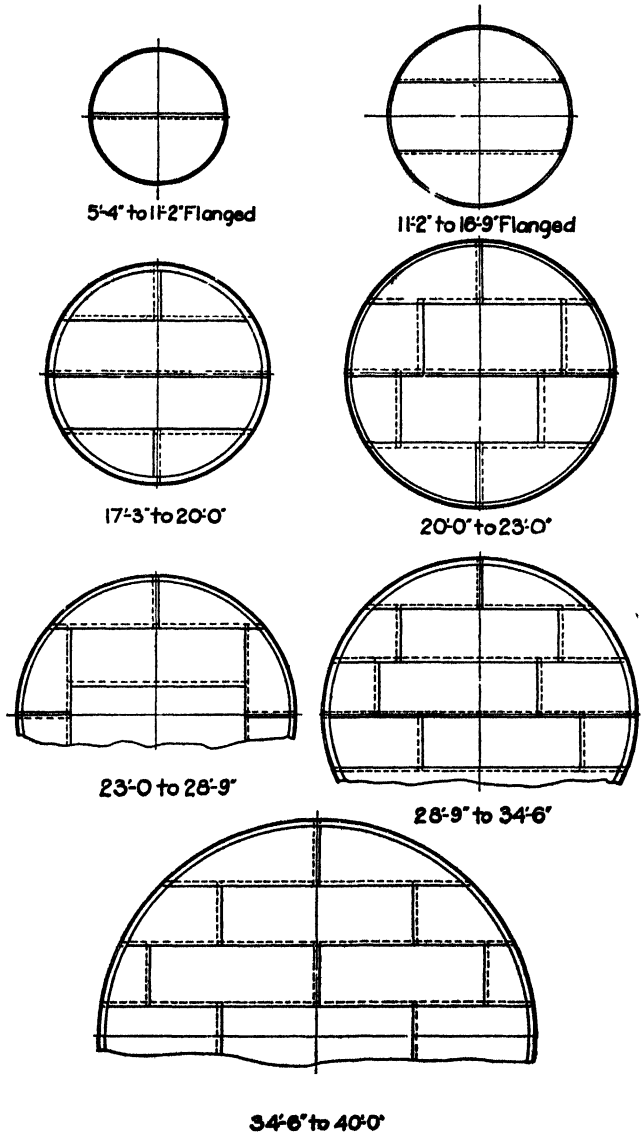

FIG. 3.—Arrangement of bottom plates for various diameter tanks.

bottom angle and the first shell ring and the bottom of the tank (see Fig. 4). Stop-waters are usually made from heavy canvas, soaked in red lead paste.

The same result can be had by cutting a V-shaped slot into the rivet on each side of the splice, if there is a single row of rivets in the horizontal leg of the

bottom angle. To do this, cut a V slot from the caulking edge of the horizontal leg of the bottom angle at a rivet near the splice. Caulk up to the slot and drive the metal well back against the shank of the rivet. Then on the outside cut a V slot in the outer edge of the bottom plates at the same rivet, also driving the metal well back against the shank of the rivet, caulking the splice as described when the stop-waters are used. It is necessary to either use the stop-waters or these slots to stop the liquid from flowing back under the angle and out where the outside caulking ceases. The ends of the wrapper plate should be caulked against the angle. This will make up-caulking on the bottom edge of the first shell ring. This must be done before the tank bottom is lowered to foundation or grade.

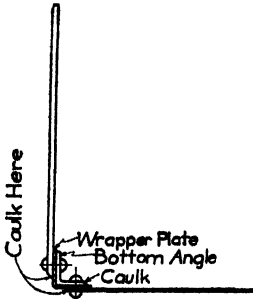

FIG. 4.—Showing bottom angle and wrapper plate.

7. **Standard Sized Tanks.**—For tanks up to 1,000,000- and 2,000,000-gal. capacity, where the height is less than one-half the diameter, and smaller tanks where the height is about equal to the diameter,

it will often be found that tank manufacturers will have a standard-sized tank of a capacity and approximate dimensions desired. This tank can be purchased at a less cost and better deliveries made than for a special design that may be prepared, as they will have on hand standard detail drawings, templets, and perhaps even stock plates to make up the tanks.

8. **Overturning Due to Wind.**—In tanks where the height is more than twice the diameter, an investigation should be made for overturning due to wind load when the tank is empty. It is usual to consider the wind as acting on the diametrical cross-sectional area of the tanks.

Let M = overturning moment due to wind in foot-pounds.

D = diameter of tank in feet.

H = height of tank and roof in feet.

W = weight of tank shell, roof and bottom angle.

w = assumed wind load in pounds per square foot.

v = uplift per foot of circumference of tank.

Then

$$M = \frac{wDH^2}{2}$$

and

$$v = \frac{4M}{\pi D^2} - \frac{W}{\pi D}$$

(See p. 470 for derivation of these formulas.)

9. **Anchor Bolt Connections.**—Multiplying the value of v from the above formula by the circumference of the tank in feet and dividing by the number of anchor bolts, gives the stress in the anchor bolt connection and the anchor bolts. Figure 5 shows typical anchor bolt connection that is simple, gives good service, and can be readily inspected or painted. It is best to use 30 per cent more rivets than obtained from the use of the above formulas, where the angles are short. The vertical angle should not come down so as to take the same rivets

that go through the bottom angle or so as to interfere with the caulking of this angle.

A wind load of 18 to 20 lb. per sq. ft. diametrical area is used very extensively in tank design. Such experiments as have been made on cylindrical surfaces seem to indicate that this is the maximum that can be expected. If the unit stress in the anchor bolts is kept at 15,000 to 16,000 lb. per sq. in., this should certainly give ample stability. It is best not to upset the ends of the anchor bolts, thus allowing extra sectional area in the bolt where it enters the masonry and corrosion is liable to occur.

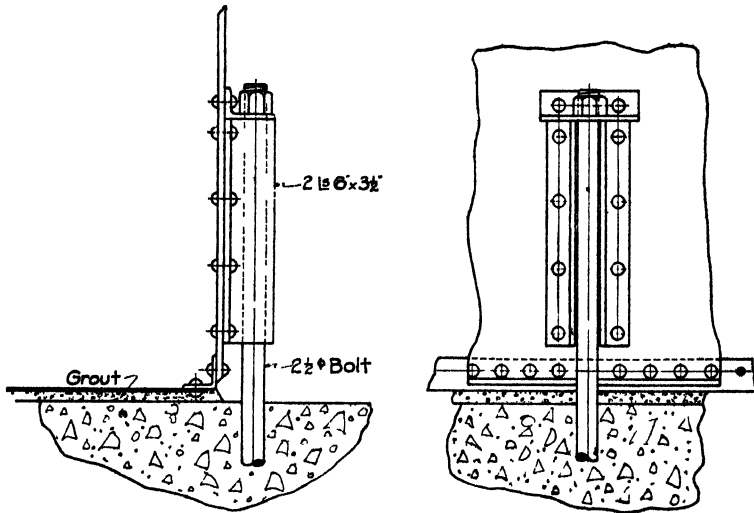

FIG. 5.—Anchor bolt connection.

If high efficiency butt joints are used in the lower rings, the rivet pitch in the anchor bolt brackets will have to be watched or the shell plates will be weakened at this connection. It may be necessary to use a reinforcing plate between the brackets and the shell plate in some cases. The riveting on the vertical edge of these plates will have to be similar to that on the edge of the wide butt strap at the main joint of the first ring.

10. Manhole.—If a manhole is used in the first shell ring, it should be reinforced if the shell is $\frac{3}{8}$ in. or more. This plate should also have riveting on the vertical edge similar to that on the edge of the wide butt strap. The net section through the manhole—that is, through the reinforcing plate, that part of the manhole frame in contact with the shell, and the main shell plate in contact with the reinforcing plate—should be the same as the net section in an equal height of the main plate at the vertical joint. Stated another way, the shell should be as strong at the manhole as at the main joint in the plate.

11. Pipe Connections.—Figure 6 shows three types of pipe connections to the bottom. Type (a) permits the bottom to be tested after it is riveted and caulked and before it is lowered. It also permits the pipe to be installed easily after the bottom is lowered. It has a great deal to recommend it over Types (b) and (c) if its projection into the tank is not objectionable. Type (b) is a hat flange for

flanged pipe connection, and Type (c) is a flange for screwed pipe. These same connections can be used on the shell except the contact face will have to be curved for small diameter tanks.

12. Tank Erection.—The bottom is usually assembled, riveted, caulked, and tested, on a frame work or horses about 3 ft. above the foundations or grade. The first shell ring and bottom angle are also riveted in place before testing. The bottom should be tested with 3 to 6 in. of water, before lowering, to insure its being perfectly tight.

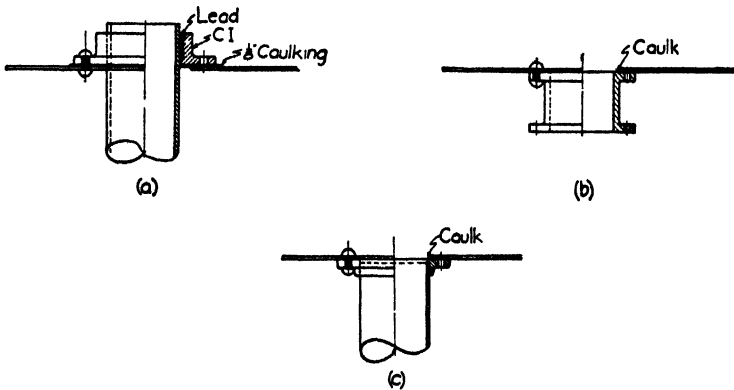

FIG. 6.—Connections to bottom of tank.

Cribs are now built under the edge of the tank 20 to 35 ft. apart, these cribs being built of 6×6 timber $2\frac{1}{2}$ to $3\frac{1}{2}$ ft. long. Beginning at the center, all framing or horses are removed by gradually working to the outside, until the bottom and first shell ring are resting upon the timbered cribs around the edge. Beginning at one crib, the tank is raised with a jack and one layer of 6-in. blocking removed from one or two cribs. The jacks are then moved and a layer removed from the adjacent cribs, and so on until the tank rests on its foundation or grade. Tank bottoms more than 120 ft. in diameter are lowered in this manner without springing the caulking.

When the tank rests on the masonry foundation, it should have a sand or a dry grout bed 1 to $1\frac{1}{2}$ in. thick. A dry grout (mixed about 1:3) is better than wet, as it can be spread more evenly, and will allow the rivet heads and plate laps to seat themselves. Wet grout will partially set before the bottom can be lowered, especially if the bottom is large. However, a ring of wet grout mixed 1:2 should extend about 1 ft. under the tank. Wedges can be placed under the bottom angle to hold the tank up while this is being placed and allowed to set. Any unevenness in the foundation can be taken care of at the time this is being done. The main tank shell can be raised into place by one of several different methods. Local conditions, size of tank, and other work going on at the same time, have so much to do with the method of erection that it is to be followed that it cannot be said which is the better. Up to about 20,000 rivets, it is generally better to use hand methods unless machinery and air equipment are very near at hand. In any case, the steel should be well bolted and fit up, so that the plates are in actual contact, at all points in the joint—otherwise, the job is sure to leak.

When the tank is more than 50 ft. in diameter, it should have temporary guys installed at about 30- to 40- ft. intervals around the circumference, while the thin plates are being erected—otherwise, the wind in excess of 20 to 25 miles per hour is liable to blow the shell in. After the shell is erected and the roof or top girder is in place, there is no danger from this source. One rule for the girder or top angle, when there is no roof, is that it should have a section modulus in inches cubed, equal to the diameter of the tank in feet squared divided by 250. This is quite an arbitrary rule and has very little or nothing to recommend it from the theoretical point of view. Tanks without roofs, built with such a top angle or girder, have stood for years, and there has not been a single case of trouble to the writer's knowledge. It does not take an excessive amount of material to stiffen the top of a tank in this manner.

13. Tank Roof.—The roof of a tank should be at least $\frac{3}{16}$ in. thick. Many tanks have been built with $\frac{1}{8}$ -in. roof plates or even lighter. The tendency now is towards heavier roof plates. It adds only slightly to the cost of the tank to have a $\frac{3}{16}$ -in. roof but it adds a great deal to the life of the roof. If a roof is needed at all, it should be so constructed that it will last as long as the rest of the tank.

Steel roofs on tanks are usually conical in form. For small diameter tanks, a steep pitch 9 vertical, 12 horizontal, is commonly used. This roof needs no supports except for erection purposes. Those of flatter pitch, say 4 or 5 to 12, need structural supports. These are usually radial channel rafters fastened to the tank shell and to a structural ring near the peak of the roof. The frame need only be strong enough to support one-third to one-half the usual roof load, its chief function being to keep the roof in shape. It is not common to rivet roof plates to the framing.

Large diameter tanks up to 40 or 50 ft. in height have flat roofs with a pitch of $1\frac{1}{2}$ vertical to 12 horizontal. These have radial rafters and trusses that carry the entire roof load. The trusses rest on a single center column while in quite large diameter tanks the radial rafters rest on girders which in turn connect to a series of columns. It seems to be standard practice to use very high unit stresses, 20,000 to 25,000 lb. per sq. in. in the rafters, girder and trusses. The $\frac{L}{r}$ in the

columns is as high as 180 to 190, although the unit stress in the columns is quite low—3,000 to 4,000 lb. per sq. in. Presumably, the basis for this is that only rarely does any considerable load come upon the roof framing and should it fail, due to overload, the only damage done is the loss of the roof, while in other classes of structures, there would be losses much greater than the loss of the roof.

Flat bottom tanks up to 40 ft. in diameter can have $\frac{3}{16}$ - or $\frac{1}{4}$ -in. dome or umbrella roofs. The dome or globe roof has the roof plates dished to a radius about equal to the diameter of the tank. In an umbrella roof, the plates are not dished but the narrow radial plates are laid out so that the roof will have about the same shape when assembled as the dome or globe roof. In fact, after being erected it is quite difficult for an experienced tank builder to distinguish a dome roof from an umbrella roof. In the above roofs, the plates are flanged or bent in each case so as to connect to the outstanding leg of the top shell angle. These roofs have no supporting framing but they make a very excellent roof up to 40 ft. in diameter. They make a more pleasing appearance to the eye than a conical

roof. For a roof for a 40-ft. tank with a center saucer plate about 6 ft. in diameter the radial plate would be about 18 ft. long, this being about the maximum length that cuts economically from rectangular plates and handles readily.

Most roofs for water tanks are riveted so as to be weatherproof only. Some roofs, as for molasses tanks, should be made absolutely waterproof as a small amount of leakage would cause the molasses to ferment. Oil tank roofs should be absolutely gas tight to prevent waste due to gas escaping. It is also found that when there is a gas-tight steel roof on an oil tank there is very little or no danger of fire due to lightning or other causes. Acid tanks should have an air-tight roof.

14. Rivets Used in Tank Construction.—Rivets are manufactured, generally either button or cone head, although there are several other special shapes for which there are claimed to be certain advantages. Better than 90 per cent of all rivets used in tank construction are either cone or button head. Cone head rivets are usually bucked up with a flat faced bar while the button heads are bucked up with a die. Between the two kinds there is a slight preference for cone head. The formed heads are either steeple, flat, Liverpool, or button, the first three being used with cone head rivets and the latter with button head rivets. Good riveting can be done with either type of rivets.

15. Scarfing.—Wherever a lap joint is made the corner that comes between the other thicknesses should be scarfed out to a thin edge, $\frac{1}{8}$ in. or less. There should be a gradual, fairly long taper to the scarf so that the lap can be laid up evenly. The scarfed edge should extend out beyond the caulked edge of the outside plate. Where the rings are alternately in and out, both corners at one end of the plate will be scarfed and if the rings build in or build out, the diagonally opposite corners should be scarfed. It is usual to heat plates over $\frac{5}{16}$ in. thick to a cherry red for scarfing.

16. Tank Foundations.—There is a wide variation as to the type and size of the foundation for a flat bottom tank—more so even for foundations that do not require anchor bolts than those that do require them. It is quite common for tanks up to 35 ft. in height to have a flat slab foundation about 1 ft. thick extending out 1 to $1\frac{1}{2}$ ft. beyond the tank all around, with a ring wall $1\frac{1}{2}$ to $2\frac{1}{2}$ ft. thick going 3 to 5 ft. into the ground (see Fig. 7). In this way the tank is 6 to 12 in. above the ground level. If the ground has unequal supporting power, this foundation will settle unequally and crack. With moderately good soil, however, this settlement is rarely enough to be serious. Some tanks are placed directly upon a grade. An area is leveled off and 6 in. or more of gravel is usually placed upon the grade. This is the only foundation used for a great many oil tanks. Many of these are 120 ft. in diameter and 45 ft. high. It is very essential if the roof plates are to fit and the roof give good service and that the tank will hold its rated capacity, that the grade be exactly level—otherwise, the top of the tank cannot be made round and the roof, consequently, can not be made to fit. The tank will change shape as it is filled and damage the roof.

A grade for a high tank is sometimes made by building a ring wall about 18 in. thick and 5 to 6 ft. deep with the inside diameter equal to the diameter of the tank plus about 6 ft. The earth inside the wall is then excavated and filled either with coarse gravel or coarse crushed rock. It is best to have no pipe openings in the tank bottom but have all pipe connections in the first shell ring. This foundation has been used for tanks 30 ft. in diameter and 65 ft. high. Care should be

taken that the bottom of the foundation is well drained by being connected to a sewer or other outlet. Many tank foundations are made of mass concrete 5 to 6 ft. in depth. It is very unusual to use reinforcing steel in flat bottom tank foundations excepting at the pipe tunnel.

Where anchor bolts are required, the foundation is of mass concrete 6 or 7 ft. deep. In exceptional cases, it may be 10 ft. deep. It is economical to make these circular in shape. The base diameter should not exceed the top diameter by more than twice the depth of the foundation, thus keeping the slope of the sides to less than 45 deg. with the vertical.

The overturning moment is found the same way for anchor bolts and for anchor bolt connection brackets excepting the thickness of the foundations is added to the moment lever arm. If M = overturning moment in foot-pounds, H = height of tank in feet, D = diameter of tank in feet, h = depth of foundation in feet, f = diameter top of foundation in feet, F = diameter base of foundation in feet, w = wind load on diametrical sectional area of tank in pounds per square foot, W = weight of steel in pounds, and p_s , p_m , p_w , and p_h = soil pressure in pounds per square foot due to steel, masonry, wind and water, respectively, we have

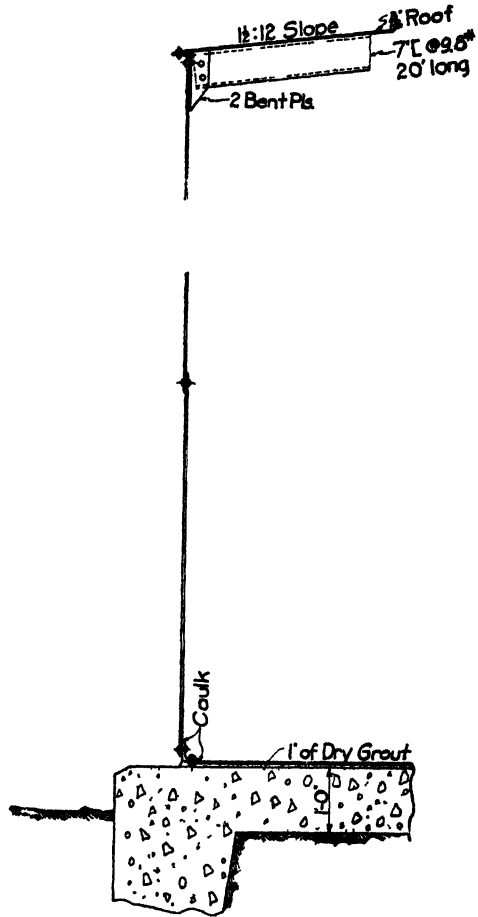

FIG 7.—Part section of tank and foundation.

$$M = wDH \left(\frac{H}{2} + h \right)$$

$$p_s = \frac{4w}{\pi F^2}$$

$$p_m = 18.33(F^2 + f^2 + fF)$$

$$p_w = \frac{M}{0.008F^3}$$

$$p_h = \frac{62.3DH}{F}$$

For stability when the tank is empty, $p_s + p_m > p_w$ and $p_s + p_m + p_A + p_u$ should be less than the allowable soil pressure.

In the above computation, it is assumed that the axis of rotation for the wind load passes through the center of the base. It is contended—and somewhat correctly—that the axis of rotation would shift to the leeward before overturning would take place when the tank is empty, as the soil on the leeward side would not be loaded to full capacity, thereby decreasing the uplift on the windward side of the foundation. It is uncertain just how far the axis of rotation would shift leeward before the danger point is reached and as it adds to the factor of safety to follow the criteria given above they are generally accepted as giving a proper design.

It is common to use 1:2:4 mix of standard material for concrete tank foundations, the top and sides exposed to view being given a sidewalk finish. Anchor bolts should extend down to within 1 ft. or less from the bottom, and they should have a nut or head with a washer on the lower head to insure a good grip on the concrete. The pipe tunnel should be made just large enough so that the pipes can be put in place, as it is rare that they need further attention. A small tunnel tends to prevent freezing in a cold climate. A minimum amount of roof slab should be omitted where the pipes connect to the tank, particularly on tanks more than 30 ft. high. A large opening in the slab would cause the tank bottom to spring and perhaps leak, and would also throw an excess load on the pipes and cause the connections to leak. Reinforcing steel should be used in the top slab of the pipe tunnel and, almost always, it should also be used in the floor of this tunnel.

17. Tank Accessories.—An outside ladder coming within about 10 ft. from the ground should always be included. A very good ladder can be made with side bars, $2\frac{1}{2}$ - \times - $\frac{3}{8}$ -in. with $\frac{5}{8}$ -in. square rungs 14 in. long, spaced 12 in. center to center. The corner of the rungs being turned up, there is a very secure feeling when the foot is placed on this rung as there is no tendency to slip even in wet or icy weather. The ladder should be fastened to the tank every 12 to 16 ft. A ladder on the inside may be advisable if there is no manhole in the bottom shell ring of the tank. The inside ladder should always be omitted if bad ice conditions are to be met. A revolving ladder on the roof or a painter's trolley should always be installed. This trolley can be made from a curved angle fastened to the tank shell by short lug angles spaced about 2- or 3-ft. centers, the vertical leg of the curved angle being turned up. A light traveler with two wheels should be installed on this angle. The traveler should be so constructed that it cannot be easily removed after once in place. A painter's trolley should also be installed on the inside of the tank, particularly if there is no inside ladder.

There should be an overflow on all water tanks. If this is allowed to discharge into the open near the top of the tank, it is the nearest to infallible of all indicators. On high tanks, due to local conditions, it may be necessary that the overflow be brought down on the inside of the tank and be allowed to discharge underground into a drain. This is not a desirable arrangement as the overflow pipe inside the tank may be broken and drain the tank.

There are several forms of apparatus to indicate the elevation of the water in the tank, none of which are infallible, under all conditions, in all climates, and at all times. A target that slides on a scale and is attached to a float is quite com-

monly used. When properly made and installed, it gives reliable indication except that with certain ice and weather conditions it is troublesome. There are many forms of spring gages, all of which can be said to be about equally poor. The proper kind of mercury gage correctly installed and connected gives about the best readings of all the telltales, and is more easily checked, adjusted, and repaired if necessary.

There are other tank accessories with which tanks may be equipped as the occasion may arise, but being mechanically operated, they need attention from time to time, so should be avoided if possible.

ELEVATED TANKS AND TOWERS

Elevated tanks are used mostly for the storage of water, although many are used to store such liquids as acids, alkali, alcohol, molasses, gasoline, benzine, etc. The principal reasons for their use are: (1) Their capacity is stored at any desired pressure economically; (2) the entire capacity is available for use; (3) the maximum pressure will be but slightly above minimum pressure, thus giving efficient operation of the pumps; and (4) the tank when filled depends only upon the unflinching law of gravitation for its pressure.

18. Capacity and Height of Tank.—The capacity and height to the bottom are determined from a consideration of the service of the tank. In sprinkler service, these are fixed by the rulings of the insurance company having jurisdiction. For municipal, factory and such service, the capacity should be based on the hourly consumption, the tank being sufficiently large to aid at peak loads and so that the pump may be closed down entirely at the off hour, thus getting the most efficient operation of the plant. The tank should also be large enough to take care of the immediate future demands, and give a margin of safety should the pumps be stopped for a short interval. The elevation of the bottom depends on local conditions, about 100 ft. to the bottom being a common height where the mains are level in municipal installations. In any case, the tank's height should be such that the proper service is given at all points in the system. The mains at the lowest point should be of such weight as to stand the pressure when the tank is full. There is a large tank in a city of over 200,000 population that can be filled less than one-tenth full as the city mains will not stand the pressure. If the tank is to act only as an equilibrant of pressure, as a surge tank on a hydroelectric development, it need have only a small capacity in relation to the water used. By using the tank as a reservoir, high-duty, highly efficient pumps may be operated at their best efficiency. This is a question that should be solved on a scientific basis for each installation and not be determined in a hit-or-miss manner.

19. General Shape of Tank.—The height to the bottom and capacity fixed, the general shape can then be decided. There are two types of elevated tanks, the flat bottom tank resting on a steel grillage and those with a suspended bottom having no grillage. The latter are much more commonly used, due to a saving in metal and cost for a given capacity, and because the bottom can be inspected and painted more readily and thoroughly. The suspended bottom can be classed as hemispherical, segmental or elliptical, and conical. In general these all have a cylindrical shell but occasionally for advertising purposes may be built with a

special bottom or shell to represent some object as a sack of flour, milk bottle, beer bottle, roll of roofing paper, can of cocoa, tub or can of lard, or an electric light bulb. The hemispherical and elliptical or segmental bottoms are more commonly used. The conical bottom tanks are used almost entirely on railways where water carrying considerable sediment is frequently found. The slope of the conical bottom permits the mud to collect at the apex of the bottom or at the bottom of the 4- to 6-ft. diameter riser. This sediment then can be removed from time to time through a washout valve.

In hemispherical bottom tanks, the ratio of the height of the cylindrical shell to the diameter is approximately 1:1 for smaller tanks and $1\frac{1}{4}$:1 for those of over 100,000 gal. capacity; while in elliptical bottom tanks, the ratio of the shell height to the diameter is approximately 0.6:1 for tanks less than 150,000-gal. capacity and 0.5:1 for tanks of 150,000 gal. and greater. The theoretical drop of the bottom from spring line for hemispherical bottom tanks is one-half the diameter and usually about one-fourth the diameter for elliptical bottom tanks. Tanks less than 30 ft. in height to the bottom commonly have vertical posts. For higher tanks, the tower posts are battered. The batter in a plane passing through a column and the vertical axis of the tank is about $1\frac{1}{4}$ to $1\frac{1}{2}$:12 for hemispherical bottom tanks up to about 500,000-gal. capacity and 1:12 for larger capacity hemispherical tanks, and for all elliptical bottom tanks. This batter decreases the wind stresses in the tower and makes a better appearing structure.

20. Tanks of Standard Size and Shape.—Ordinarily, if the capacity and height to the bottom are determined, a standard size and shape tank can be purchased more economically, and better delivery secured, than if a special design is made calling for new drawings, detail plans, templets, special fabrication and erection. These are very expensive when made for a single structure, being from 20 to 50 per cent of the purchase price in some cases. However, due to crowded conditions, large capacity or special use, it may be feasible to make a special design.

21. Tank Bottom.—The hemispherical is the most common of all elevated tanks. There is usually a dished circular plate at a lower point in the bottom called *saucer plate*. Plates with radial seams make up the rest of the bottom. When these become more than 18 ft. in length, there are usually two sets with a horizontal seam between the spring line and the saucer plate, thus making plates that can be dished and reducing the length of seam in the bottom, as wider plates can be used near the saucer than if the plates were in one length.

By making the plate arrangements as shown in Fig. 8 the tower can be erected first, then the balcony, then the first vertical shell ring, then the bottom plates that are fastened at the spring line, and finally the saucer plate. Absolutely no rivets whatsoever should be driven in this part of the tank until all bottom plates are bolted in place and the holes made fair. As it is only possible to caulk at the spring line and at the post to tank connection on the inside, it is universal practice to caulk elevated tanks on the inside only.

Table 3 gives the basis for the design of all the parts of the tank and tower. It is usual to figure the stress at any point in a hemispherical bottom as at a point in a sphere. Thus the stress is one-half what it would be in a cylindrical tank of the same diameter and head as at the point in question. Thus the bottom plates are somewhat lighter than the first shell ring. The unit stress on the

effective thickness of the bottom and first shell ring should be about five-sixths what it is in the shell of the tank, to take care of any secondary or additional stresses that may occur in the tank, the rest of the shell being designed for the usual unit stresses for cylindrical tanks. The shell rings are usually placed out-

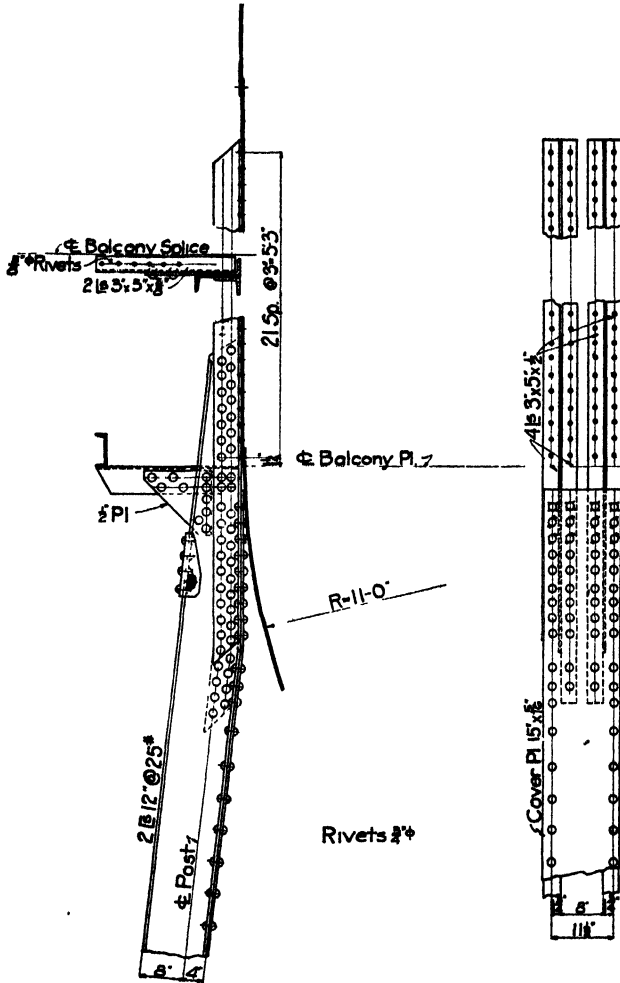

FIG. 8.—Post to tank connection for 100,000-gal. tank.

side the ring just below so as to make down caulking in the roundabout. The circumferential seams should have about the minimum rivet pitch of three times the diameter of the rivet. The rivets should be pitched equally in any one seam.

The rivets in the seam at the spring line should likewise be at minimum pitch but it is not possible to keep the rivet pitch uniform or even a pitch less than ten times the thickness of the bottom plates, on account of the post to tank connection. There will be two pitches at each column equal to twice the gage of the

column to tank connection angles plus the thickness of the web of the columns. The rest of the rivets in the top of the bottom plates should be spaced about the minimum when one row is used. The tops of all bottom plates are usually made alike so the wide space mentioned above occurs twice in the top of each bottom plate. This is not objectionable as the plate is backed up by the column or the angle at this connection, so that the plates cannot spring apart when fullered and caulked. The riveting at the spring line should be checked on large tanks to see that it will carry the weight of the water in the tank. These rivets should not be too small as they go through the bottom plates, shell rings and the balcony angle, and at the splices there are four thicknesses of material. Thus it is often advisable to use the next larger size rivet than would be used ordinarily. In an elliptical bottom, the stress should be computed at several points (from 8 to 10) along a radial seam and an average taken. The equation for this is

$\frac{W \sec.^2 \theta}{2\pi R} - 2.6HD \sec \theta$, as given in Table 3. It will be noted that at the point of compound curvature, the stress theoretically changes sign and is a maximum. As a matter of fact, in the way that the plates are dished at the shop, the change in radius is gradual, taking place over a length of plate of 3 ft. or more. Thus, there would not be a reversal of stress at a point or a maximum compression just to one side of a point with a high tension stress at the other side of the point. It has been found that to take an average of the compression stresses and take an average of the tension stresses, the highest of these averages being used in designing the bottom, gives a safe and satisfactory design. Such extensometer measurements with which the writer is familiar would seem to indicate that this is about correct.

It has been arbitrarily established that in tanks having a water leg or supporting cylinder, this cylinder carries a cylinder of water in the tank whose diameter is about 4 ft. greater than the diameter of the water leg. This has given very satisfactory results in a large number of tanks that have been installed. The large majority of these tanks are under 30 ft. in diameter. For tanks over 30 ft. in diameter, it would seem that a larger cylinder of water would be supported by the water leg. Such extensometer measurements as have been made would indicate that better than one-fourth the tank capacity was supported by the water leg. Thus, for a tank 30 ft. in diameter and over the water leg may be considered as supporting a cylinder of water in the tank equal to one-third the tank diameter. At least, the foundation under the water leg should be sufficient for such a load.

Conical bottom tanks are rarely in excess of 30 ft. in diameter and the water leg is considered to support the same diameter cylinder of water as in elliptical bottom tanks. The slope of the cone is usually 45 deg. from the vertical, there being a curved portion connecting the cone to the first shell ring to a radius of about one-fifth to one-sixth of the diameter of the tank. These tanks are not usually made so large that the stress in the bottom becomes a matter of much importance. Table 3 gives the equation for finding the stresses in the bottom.

Excepting for the bottoms, the other features of all tanks are similar and will be discussed collectively except where mentioned otherwise.

22. Balcony Girder.—There should be a balcony girder or angle (minimum width of horizontal leg = 5 in.) at the spring line of all tanks where the posts are vertical. For large capacity tanks a Z-section of two angles should be used at the

spring line. Technically there may not be a need for this but it is certainly in keeping with good judgment to have such a member to keep the tank in its true shape.

The minimum width of balcony or horizontal girder is 24 in. This is about as narrow as will give sufficient freedom for inspection and painting of the tank. The balcony is riveted up in sections with the field splices just back of the post to tank connection (see Fig. 9). This permits the balcony being put in place as soon as the top column sections are in place. The girder rests on horizontal

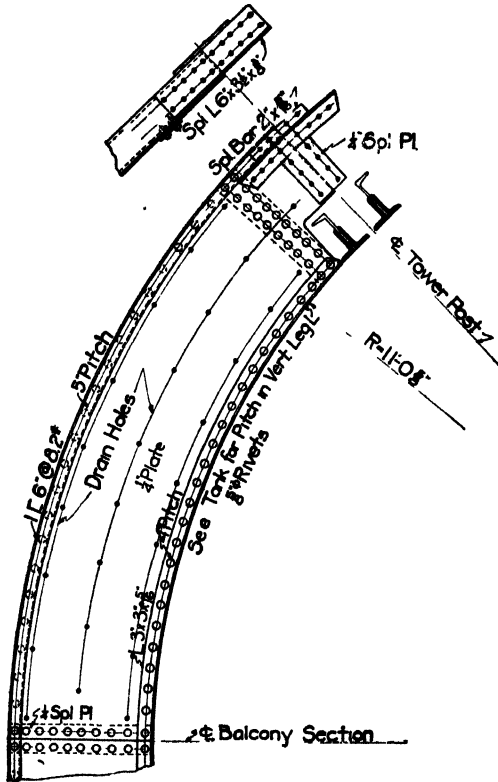

FIG. 9.—Balcony girder for 100,000-gal. tank.

shelf angles shown in Fig. 8 and has a web and outer flange splice at this point. Shelf or horn angles should be shop riveted to the upper tower sections with sufficient rivets to take all of the thrust due to the batter of the tower columns. In some designs, this is a very troublesome detail to get secure and should be watched carefully in all cases. The balcony outer flanged splice should be strong enough to take the maximum stress as it is at the point of maximum moment. When a channel is riveted to one side of the flange only, about 60 per cent of the channel area should be considered effective. A channel in this position gives vertical stiffness to the outer flange with a minimum amount of material, and makes an ideal member for connecting the hand railing. A design of a structural hand railing

is shown in Figs. 10 and 14. This is a good type of railing and has the added feature of stiffening the outer balcony flange.

The balcony is riveted to the tank by means of a single angle. This angle should be of such size and thickness as to be in keeping with the rest of the balcony design. Drain holes are punched in the balcony web at about 1-ft. centers.

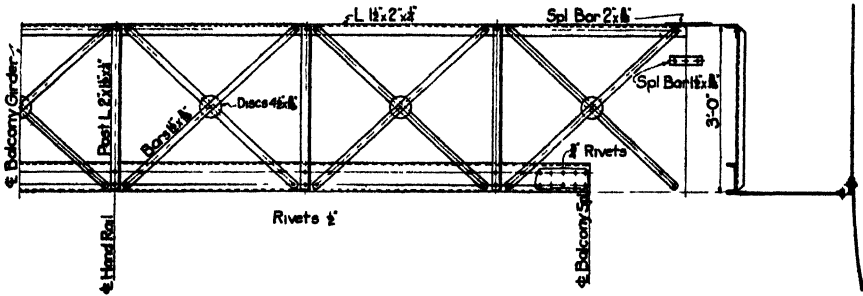

FIG. 10.—Balcony hand rail.

23. Tank Roof.—At the top of the tank, there should be an angle to which the roof connects or to act as a girder if there is no roof, the same rule applying to the top angle or girder when roof is omitted as in flat bottom tanks—namely, the section modulus in inches cubed, should be equal to the diameter in feet squared divided by 250. This angle is placed most frequently on the outside of the tank, and the roof plates are connected to it by means of bent bolts or by special bolts having the head set at the angle of the roof. A common pitch for the roof is from one-sixth to three-eighths, the flatter roof making the better looking tank where the bottom is shallow. The roof plates should not be less than $\frac{3}{16}$ in. thick, although many roofs are made with $\frac{1}{8}$ -in. material, as often there is considerable condensation on the under side of the roof that tends to cause corrosion. There should be sufficient framing under the roof so that it may be erected readily, and help keep it in shape for slight concentrated load. A $\frac{3}{16}$ -in. cone roof of the pitch mentioned is practically self supporting up to 30 ft. in diameter for one-sixth pitch and up to 50 ft. for three-eighths pitch. For tanks with the above style roof, the framing usually consists of radial angle or channel rafters spaced about 6 ft. center to center at the outer end and connecting into a structural ring near the center. For large roofs, the supports are trusses or have a truss effect.

The roof should project 6 in. when the columns are vertical and when there is no balcony and should extend out to within about 6 in. of the outer edge of the balcony for best appearances.

24. Number of Plates in Each Shell Ring.—Each ring of the tank shell should have the same number of plates around as there are columns, the post to tank connection being in the middle of each plate of the first shell ring. The maximum length of plate is about 22 ft. There should not be less than four columns. A 3-post tower has considerable to recommend it for small capacity tanks but the wind stresses are high and its appearance, when the line of vision is parallel to

one side, is so objectionable, that it is rarely built except for very special cases as over the corner of a low building.

25. Tank to Post Connection.—The tank to post connection is the most difficult detail in tower and tank design. The choice of the section to make up the tower columns, the batter of the column, and the balcony sections depend materially on this detail. None of these should be fixed until this connection is completely detailed. The shear on the rivets connecting the tank to the connection angles should be only about 6,000 lb. per sq. in. Every detail should be examined carefully to see that it is entirely safe and will go together properly. Figure 8 shows a form of this connection that has given very good satisfaction on many installations. All the best forms of this connection are quite similar to the details shown. There should be about 25 per cent more section opposite the spring line than in the main body of the top column. This connection should be made so that the center line of the column, center line of the balcony girder web and the outside of the first tank shell are concurrent—otherwise there would be bending strains in the columns.

26. Tower Columns.—The tower columns are made of various shapes. Two channels laced two sides or a cover plate and laced one side are commonly used. For large capacity tanks, a section built of two web plates, four angles and a cover plate are common. When a cover plate is used, it brings the center line of the column near the inside face of the column, which is an advantage in detailing the upper end of the top panel tower column. A single angle or two angles are sometimes used for a column for small tanks, also I-sections are used, but neither of these permit of a good post to tank connection or of a combined strut and rod connection. They are also more expensive to erect as they cannot be scaled as well as columns with lacing.

The splices in the columns should be just above the strut connection, but as near the center line of the strut as possible. This splice and strut connection needs to be designed very carefully so that the tower can be assembled easily without the necessity of bolts being removed and being replaced as erection progresses, and that all rivets can be driven satisfactorily. In all tank construction, the field labor is always more than the shop labor, being as much as two, or possibly three times as much—in some cases, even five times as much.

It is not enough that a structure is designed with safe unit stresses and so it can be fabricated and can be erected, but it should be designed so that it can be fabricated conforming to standard shop practice and be erected without an undue amount of effort and equipment. Engineers frequently seem to lose sight of the sequence of events in the shop and field—as, for example, an undue number of changes in the rivets and small details, changes in rivet pitch, sections that are awkward to handle and have to be taken to too many different machines, and sections that are difficult to assemble and rivet or in which the assembling and riveting have to be alternated several times in the shop or the field.

The splice plates at the end of the columns should be sufficient to take all the possible tension due to the wind and to thoroughly hold the ends of the section in line. When the ends of the columns are milled, it is not usual to have the splice plates take a very large proportion of the compression strain (25 to 33 per cent only).

All parts of a tower should be open so that the structure can be cleaned and painted as required.

The bottom shoe and anchor bolt connections are details that are also difficult. Figure 11 shows one type that is fairly satisfactory and that can be readily cleaned and painted. It will be noted that there is only one anchor bolt. This has the advantage that it can be set more nearly correct in the foundation than if there were two at each column. One large anchor bolt is less susceptible to corrosion than two small anchor bolts.

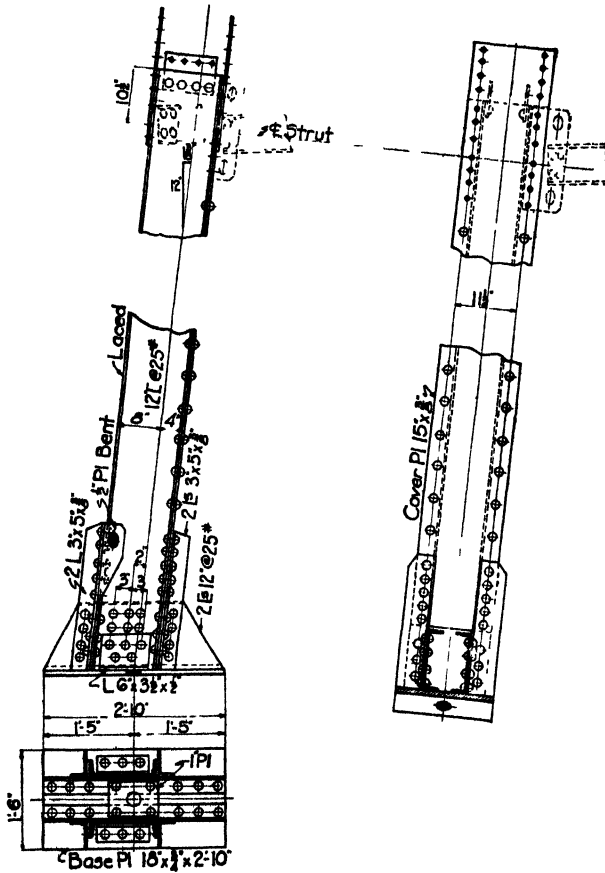

FIG. 11.—Lower tower post for 100,000-gal. tank.

27. Struts.—Figure 12 shows a type of channel struts that is used extensively. The lacing is unusual but, excepting during erection, the only load in the struts is due to wind, and the unit stress then is very low. This lacing has given satisfactory results. The struts can be laced top and bottom when thought necessary. Struts can be made of four angles laced in the form of an I-beam and for large towers are made of four angles laced four sides. The laced I-strut does not give the support to the tower column that the other types do. During erection the struts are commonly subject to a much higher stress than they will ever receive

thereafter. In fact, the size of the strut is most frequently determined from the erection strains.

28. Tower Rods.—The tower rods are made of either square or round rods, with a good grade of iron or mild steel that can be welded easily. The ends are attached to a single plate by means of clevis nuts or forked loop ends. The ends are upset for threading and a turnbuckle used for adjustment in lining up the tower.

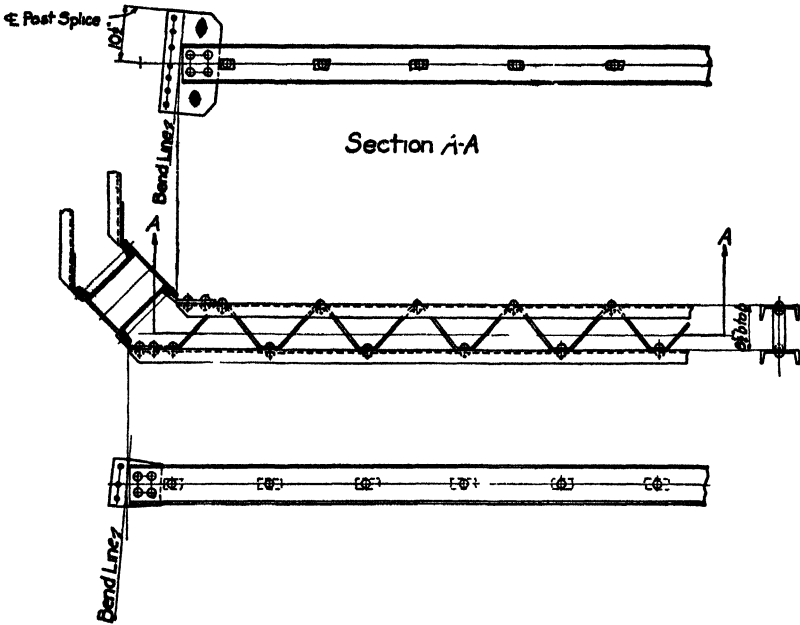

FIG. 12.—Typical strut.

There is a pipe rod leading from each post splice to the riser pipe or water leg, about the same diameter as the rivets in the tower column. These serve the double purpose of latterly supporting the riser and bracing the tower.

29. Elevated Tank Foundations.—Figure 13 gives a typical foundation plan. The foundations should be laid out so that the center line of the tower post produced passes through the center of the top and bottom of the pier, so that the soil pressure will be uniform on the base. The usual concrete mix is 1:3:5 for standard materials. The top and exposed surfaces should have a sidewalk finish. It is essential that the tops of all piers be level and at the same elevation, so that the tower columns will carry equal loads and that the roof plates may be put on and the roof have a good shape.

30. Riser Pipe.—For hemispherical bottom tanks the riser should be flanged cast-iron pipe. This will give better service than bell and spigot or wrought-iron pipe. The riser should be connected to the tank by an expansion joint. There should also be a walkway from the ladder column to the expansion joint (see Fig. 14). This walkway is usually hung by rods from the bottom of the tank. The lower end of the riser should connect to a foot elbow that has a masonry founda-

tion (see Fig. 13). The riser pipe should be protected by two-ply wooden frost case or its equal in the territory included between the latitude of Atlanta, Ga. and Chicago, and three-ply for Northern United States and Southern Ontario, and four-ply for Northern Canada. This frost case should be made of a good grade

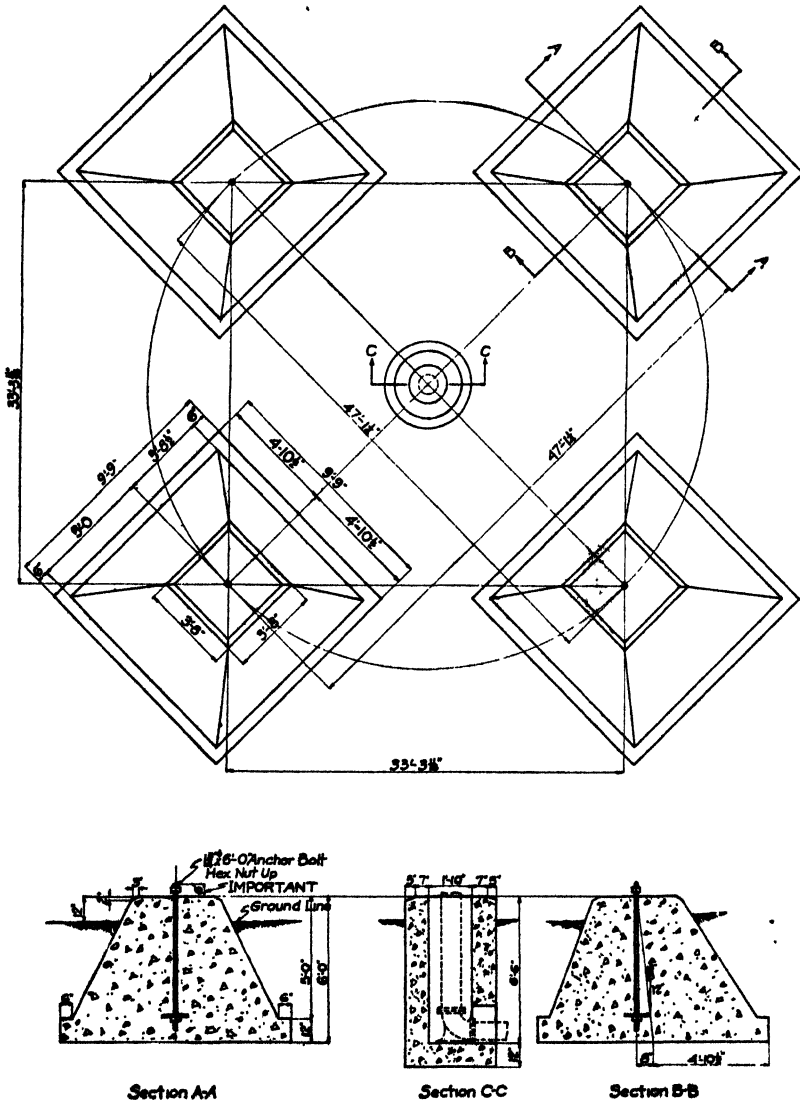

FIG. 13.—Foundation for 100,000-gal. tank, 100 ft.—0 in. to bottom, concrete mixture 1:3:5.

of lumber, dressed and matched with about a 2-in. air space between each course of lumber. There should also be a good grade of tar building paper over each ply excepting the outside. The wooden separators between plies are spaced 2½ to 3½ ft. apart. If the frost case is circular in section, it is best to have the lumber dressed to the proper curvature.

31. Water Heaters.—If water does not flow either into or out of the tank at all times there should be some means provided to heat the riser and the tank. The best way to do this is by means of a steam operated heater that takes cold water out of the base elbow and discharges hot water into the tank through a heater pipe that goes up inside the frost case. The hot water in the heater pipe will prevent water in the main riser from freezing. Coal fired heaters can also be used but are not as successful as the steam operated. A steam coil is

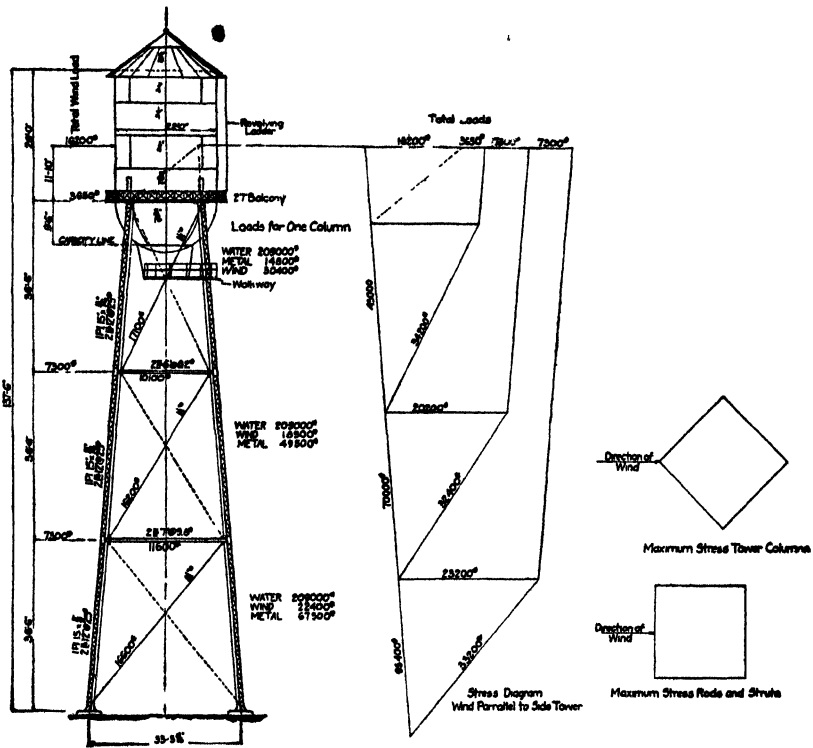

FIG. 14.—100,000-gal. tank 100 ft.—0 in. to bottom.

also placed in the bottom of the tank with a flow and return line inside the frost case. These heater pipes have either a swing joint or an expansion joint near the bottom of the tank and by no means the least important is to have their lower end anchored or fixed so that the swing joint or expansion joint will not be pulled apart. Neglect of this point is sure to cause trouble in time. When a steam operated heater is used, it is ordinarily placed in a concrete pit at the base of the riser. In sprinkler tanks this pit will also contain one or two gate valves and a check valve.

32. Water Legs.—The water leg or cylinder for elliptical or conical bottom tanks is from 4 to 6 ft. in diameter. The pipe connections are made into the bottom of the head the same as in a flat bottom tank, the leaded connection being preferable. A 6-in. wash out valve is installed to take care of any sediment that may collect. For any service except sprinkler in the United States there is no need for heating these two types of tanks. This, and the fact that there is no expansion joint is a point in their favor.

33. Tank Accessories.—On all tanks there should be a ladder on one tower post to the balcony and a revolving ladder on the roof and side of the tank—also a ladder on the inside of the tank. The overflow, tell-tale, and other accessories are open to the same discussion as in cylindrical tanks. ●

34. Painting.—The painting on all tanks and towers should be done as on any other steel structure excepting where bad water conditions are encountered it may be best to use an asphaltum or bituminous coating. Practically all the so-called water resisting paints give no better service than a good grade of paint which is made by reputable paint manufacturers commonly used on steel work.

35. Tower and Tank Erection.—The usual method of erecting the tower is with a gin pole about 10 ft. longer than the longest column section. At least four and better six guys are used. The bottom column section is raised and the anchor bolt nuts made tight. A second bottom section is then raised and the struts put in place, and so on until the bottom section of the tower is assembled. A spur is then bolted on the side of the gin pole extending 4 to 6 ft. below the bottom of the pole. A set of blocks is fastened to the lower end of the spur and to the strut near a column. By taking up on this set of blocks and letting out on the guy line the gin pole is raised until the bottom of the pole rests upon the strut. A second panel column is then raised and the pole is worked along the strut and jumped around the column in about the same way it is raised from the ground. A second panel strut is then put in place and the second panel completed similar to the first. In erecting the tank shell, brackets are bolted down about 20 in. from the top of the ring on the inside before the next ring is raised. These brackets are on about 10-ft. centers so that planking can be placed on them to serve as a scaffold. A cage with flanged wheels that roll on the top of the ring is used on the outside for the men to heat and buck rivets. In this way a considerable saving of time and material for scaffolding is made.

36. Designing Practice.—Table 3 gives the fundamental equations for computing the stresses in the tower, tank, and balcony. The tank design is worked up by means of these equations and by the use of Table 1 and possibly Table 2 as explained in Art. 2. For the wind stresses on the rods, columns, and struts a graphical solution can be made more easily for a four post tower (see Fig. 14) while an algebraic solution is the most reasonable for towers with more than four posts. The diagram of Fig. 14 is for a 100,000 gal. hemispherical bottom tank, 100 ft. to the bottom. The capacity line referred to at the bottom of the tank is about 18 in. above the theoretical bottom so as to allow for pipe connections. The wind load is for the entire structure so one-half of the stress in the diagram should be taken for the stress in any one rod or strut. This diagram is drawn with the wind blowing parallel to one side of the tower, giving the maximum rod stress. The maximum post stress occurs when the wind is blowing parallel to a long diagonal. This is true for either 6-, 8-, 10- or 12-post towers.

The column stresses are found by taking one-half the value of the stress diagram and multiplying by 1.4142, or by multiplying the value in the stress diagram by 0.7071. The other stresses in the column due to metal and water are easily computed.

It is customary practice to consider the metal and water load to be carried equally by all tower posts. In case of a water leg or large cylinder being installed, it carries a water load as explained in Art. 21. If the foundations are not at exactly the same elevation or the tower columns are not exactly the same length, this would not seem to be true, but the top of the tank cannot be rounded up so that the roof can be installed, until the columns are carrying equal loads. This has come up time after time in tower construction, so that a set of light radial rods called spider rods are temporarily placed in the top of the tank to help round out the tank so that the roof can be assembled, but very little can be done until the columns are equally stressed, the bases being at the same elevation or at least in the same place. As there is no chance of the columns being very much overloaded and as they are well fixed at the top, bottom, and panel points, it is usual to use a higher unit stress in elevated tank columns than in other structures.

The maximum stress in a column will occur when the tank is full and the wind is blowing parallel to a long diagonal. At this time the reactions of all columns will be downward (no anchor bolts acting). The axis of rotation will be at right angles to the direction of the wind and will pass through the center of the tower. Another condition exists in computing the maximum uplift for foundation and anchor bolts. The maximum uplift would occur just before overturning takes place so that the axis of rotation would pass through the extreme leeward pier or piers. For a four post tower the worst condition is with the wind blowing parallel to one side, as in the stress diagram, so the maximum uplift would equal one-half the wind stress for the bottom column as found in the diagram, minus one-fourth the total weight of the structure. The anchor bolts should be made large enough for this stress and the weight of one pier should be in excess of this amount. The weight of the soil above the foundation will give an additional factor of safety.

In checking over the equations in Table 3 it should be kept in mind that the only means of additional wind load being put upon the column is by means of the tower rod.

The following values are recommended for use in elevated tower and tank design: Steel of A.S.T.M. (A 7-39) specifications excepting for the bottom which should be flange or pressing quality and the rods of the best grade of iron, or mild steel that will weld readily; wind load on the tank to be taken as 18 to 20 lb. per sq. ft. of the vertical projected area, and for the tower 50 lb. per vertical foot of height per column; foundations, concrete mix 1:2:4; maximum soil load = 3,600 lb. per sq. ft. including all loads; center pier where there is a large cylinder should have the same bearing for soil as for the piers under the outside column; tension tank plates = 12,000 lb. per sq. in.; lower shell ring and bottom elevated tanks = 10,000 lb. per sq. in.; rods = 15,000 lb. per sq. in.; shapes = 16,000 to 18,000 lb. per sq. in.; anchor bolts = 15,000 lb. per sq. in. on net section, minimum diameter $1\frac{3}{4}$ in.

TABLE 1.—LAP JOINT EFFICIENCY TABLE

Calculations are based on the following:

Value of plate in tension = 1.00

Value of rivet in shear = 0.75

Value of rivet in bearing = 1.50

Diameter of rivet hole $\frac{1}{8}$ in. more than the nominal diameter of rivet.

Diameter of rivet = nominal diameter.

Weight of plate (lb. per sq. ft.)	Thickness of plate (in.)	RIVETS		Rivet pitch (in.)	Efficiency of joint in per cent	Effective net thickness of plate	O = Oil only W = Water only	Weight of plate	Thickness of plate (in.)	RIVETS		Rivet pitch (in.)	Efficiency of joint in per cent	Effective net thickness of plate	O = Oil only W = Water only			
		Diameter	Rows							Diameter	Rows							
7.0125	1 3/4	3/8	1	1.12	42.9	0.074	W O	12.75	3/8	1	2	1.50	31.4	0.098	W O			
			2	1.40	68.8	0.118					2	1.57	60.6	0.187				
		1/2	1	1.31	50.0	0.086				3	2.04	69.2	0.216					
			2	1.55	67.8	0.116				4	2.50	75.0	0.235					
		1/4	1	1.50	57.0	0.098				1	1.88	39.2	0.122					
			2	1.72	71.0	0.122				2	2.22	66.3	0.207					
	7.65	3/8	3/8	1	1.12	39.3		0.074	W O	14.02	1 1/2	3/8	1	2.25		47.1	0.147	W O
				2	1.32	67.0		0.125					2	3.00		70.8	0.221	
			1/2	1	1.76	75.0		0.141				2	2.81	73.4		0.229		
				2	1.69	74.2		0.139				1	1.88	35.6		0.122		
			1/4	1	1.31	46.0		0.086				2	2.09	64.0		0.220		
				2	1.50	40.1		0.075				3	2.76	72.7		0.250		
8.925	3/8	3/8	1	1.70	70.6	0.133	W O	15.3	3/8	3/8	1	2.25	42.8	0.207	W O			
			2	1.88	73.5	0.138					2	2.80	68.8	0.237				
		1/2	1	1.69	70.4	0.132				3	3.44	74.5	0.256					
			2	1.50	52.4	0.098				3	3.09	71.6	0.246					
		1/4	1	1.88	66.3	0.126				1	1.88	32.7	0.123					
			2	1.69	63.0	0.118				2	1.98	61.5	0.231					
	10.2	3/8	3/8	1	1.31	39.4	0.086	W O	16.57	1 3/8	3/8	1	2.25	39.3	0.147	W O		
				2	1.50	34.4	0.075					2	2.64	66.9	0.251			
			1/2	1	1.53	37.4	0.147				3	3.53	75.2	0.282				
				2	1.75	71.5	0.156				3	3.38	74.1	0.278				
			1/4	1	1.50	45.0	0.098				1	2.25	39.3	0.147				
				2	1.98	68.0	0.149				2	2.63	45.8	0.172				
11.47	3/8	3/8	1	1.88	56.0	0.122	W O	17.85	3/8	3/8	1	2.63	70.7	0.265	W O			
			2	2.19	65.3	0.144					2	3.40	70.4	0.264				
		1/2	1	1.97	62.0	0.135				3	3.38	70.4	0.264					
			2	1.31	30.6	0.076				2	1.88	60.3	0.245					
		1/4	1	1.37	59.0	0.150				3	2.45	69.3	0.282					
			2	1.77	68.0	0.170				4	3.02	70.5	0.286					
	11.47	3/8	3/8	1	1.50	39.3	0.098	W O	18.57	1 3/8	3/8	1	2.25	36.3	0.147	W O		
				2	1.80	65.4	0.133					2	2.51	65.1	0.264			
			1/2	1	2.39	73.8	0.185				3	3.32	73.7	0.289				
				2	2.25	72.2	0.180				4	4.06	78.5	0.319				
			1/4	1	1.88	49.0	0.122				4	3.66	76.0	0.308				
				2	2.50	70.0	0.175				1	2.63	42.3	0.172				
11.47	3/8	3/8	1	2.25	50.0	0.125	W W	19.57	3/8	3/8	1	2.25	33.7	0.147	W O			
			2	2.50	65.0	0.160					2	2.39	63.4	0.277				
		1/2	1	1.50	34.9	0.098				3	3.15	72.2	0.316					
			2	1.67	62.7	0.176				4	3.90	77.6	0.340					
		1/4	1	1.50	34.9	0.098				1	2.63	39.3	0.172					
			2	2.20	71.4	0.200				2	3.03	67.1	0.294					
11.47	3/8	3/8	1	1.88	43.5	0.122	W O	20.57	3/8	3/8	1	2.63	75.6	0.321	W O			
			2	2.89	68.4	0.192					2	4.09	75.6	0.331				
		1/2	1	2.81	73.3	0.206				3	4.09	75.6	0.331					
			2	3.53	70.4	0.198				4	3.94	74.6	0.326					
		1/4	1	1.50	34.9	0.098				1	2.63	39.3	0.172					
			2	2.20	71.4	0.200				2	3.03	67.1	0.294					

TABLE 1.—LAP JOINT EFFICIENCY TABLE—Continued

Weight of plate	Thickness of plate (in.)	RIVETS		Rivet pitch (in.)	Efficiency of joint in per cent	Effective net thickness of plate	O = Oil only W = Water only	Weight of plate	Thickness of plate (in.)	RIVETS		Rivet pitch (in.)	Efficiency of joint in per cent	Effective net thickness of plate	O = Oil only W = Water only
		Diameter	Rows							Diameter	Rows				
19.12	1 1/2	3/4	2	2.29	61.8	0.290	WO	29.32	3 1/2	3/4	2	2.25	41.0	0.294	
			3	3.00	70.8	0.332					3	2.26	61.3	0.441	
			4	3.70	76.4	0.358					4	2.72	67.8	0.487	
		1/2	1	2.63	36.6	0.172				5	3.18	72.5	0.521		
			2	2.92	65.9	0.309				2	2.63	47.8	0.344		
			3	3.89	74.2	0.348				3	2.88	65.4	0.470		
20.4	1/2	3/4	2	2.25	58.9	0.294	WO	30.6	3/4	3/4	2	2.25	39.3	0.295	
			3	2.86	69.5	0.347					3	2.25	58.9	0.442	
			4	3.53	75.2	0.376					4	2.64	66.9	0.502	
		1/2	2	2.80	64.4	0.322				5	3.08	71.6	0.537		
			3	3.71	72.9	0.364				2	2.63	45.8	0.344		
			4	4.61	78.3	0.391				3	2.80	64.4	0.483		
21.67	1 1/4	3/4	2	2.25	55.4	0.294	WO	30.6	1/2	3/4	2	2.63	45.8	0.344	
			3	2.75	68.2	0.362					3	3.40	70.7	0.580	
			4	3.37	74.0	0.393					4	3.40	70.7	0.580	
		1/2	2	2.70	63.0	0.335				5	4.00	75.1	0.563		
			3	3.55	71.8	0.381									
			4	4.41	77.2	0.410									
22.95	3/4	3/4	2	2.25	52.4	0.295	WO	30.6	3/4	3/4	2	2.25	58.9	0.442	
			3	2.63	66.9	0.376					3	2.25	58.9	0.442	
			4	3.22	72.9	0.410					4	2.64	66.9	0.502	
		1/2	2	2.63	61.1	0.344				5	3.08	71.6	0.537		
			3	3.40	70.8	0.398									
			4	4.21	76.2	0.429									
24.22	1 1/2	3/4	2	2.25	49.6	0.294	WO	30.6	3/4	3/4	2	2.25	58.9	0.442	
			3	2.55	65.7	0.390					3	2.25	58.9	0.442	
			4	3.11	71.9	0.427					4	2.64	66.9	0.502	
		1/2	2	2.63	57.7	0.343				5	3.08	71.6	0.537		
			3	3.27	69.5	0.413									
			4	4.02	75.2	0.447									
25.5	3/4	3/4	2	2.25	47.1	0.294	WO	30.6	3/4	3/4	2	2.25	58.9	0.442	
			3	2.47	64.5	0.403					3	2.25	58.9	0.442	
			4	3.00	70.8	0.443					4	2.64	66.9	0.502	
		1/2	2	2.63	55.0	0.344				5	3.08	71.6	0.537		
			3	3.16	68.5	0.428									
			4	3.89	74.2	0.464									
26.77	2 1/4	3/4	2	2.25	44.9	0.295	WO	30.6	3/4	3/4	2	2.25	58.9	0.442	
			3	2.39	63.4	0.416					3	2.25	58.9	0.442	
			4	2.90	69.8	0.458					4	2.64	66.9	0.502	
		1/2	5	3.40	74.3	0.488				5	3.08	71.6	0.537		
			2	2.63	52.4	0.344									
			3	3.03	67.1	0.440									
28.05	1 1/2	3/4	2	2.25	42.8	0.294	WO	30.6	3/4	3/4	2	2.25	58.9	0.442	
			3	2.32	62.3	0.428					3	2.25	58.9	0.442	
			4	2.80	68.8	0.473					4	2.64	66.9	0.502	
		1/2	5	3.28	73.4	0.505				5	3.08	71.6	0.537		
			2	2.63	50.0	0.344									
			3	2.97	65.2	0.455									
4	3	3.62	72.5	0.498											
	4	4.28	76.6	0.527											

NOMENCLATURE
Weight of Plate.—Given in pounds per square foot.
Thickness of Plate.—Plate thicknesses are nominal only.
Rivet Diameter.—Diameter before driving.
Rivet Rows.—Number of rows of rivets in a joint.
Rivet Pitch.—Distance between centers of rivets along outside row of rivets.
Efficiency of a Joint.—The ratio which the strength of a rivet joint has to the same unit length of the solid plate.
Effective Net Thickness.—The product of the efficiency of a joint times the plate thickness. This in the table is given in square inches per linear inch of a joint.

Calculations sometimes result in a pitch greater than the maximum allowed for caulking. In this case the caulking pitch governs.
 For oil tanks the rivet pitch should not exceed eight times the thickness of the thinnest plate for one row of rivets and nine times for two or more rows.
 For water tanks the pitch should not exceed ten times the thickness of the thinnest plate.

"O" = Oil
 "W" = Water

¹ Butt strap joints are recommended for plates more than 1/2 in. in thickness.

TABLE 2.—RIVETED BUTT JOINT

Calculations are based on the following:

Value of plate in tension = 1.00

Value of rivet in shear = 0.75

Value of rivet in bearing = 1.50

Diameter of rivet and rivet hole both $\frac{1}{16}$ in. larger than nominal diameter of rivet.

Plate		Diameter rivet (in.)	Type of joint	Pitch of rivets in outside row (in.)	Efficiency of joint (per cent)	Effective net thickness (in.)	Narrow butt strap (in.)	Wide butt strap (in.)																																																																																																																																																																																																																																					
Weight lb. per sq. ft.	Thickness (in.)																																																																																																																																																																																																																																												
15.30	$\frac{3}{8}$	$\frac{5}{8}$	B3	5.5	87.5	0.328	$8\frac{1}{2} \times \frac{5}{8}$ $8\frac{1}{2} \times \frac{5}{8}$	$13 \times \frac{5}{8}$ $17\frac{1}{2} \times \frac{5}{8}$																																																																																																																																																																																																																																					
			B4	11.2	93.5	0.350			16.57	$1\frac{1}{8}$	$\frac{5}{8}$	B3	5.5	87.5	0.335	$8\frac{1}{2} \times \frac{5}{8}$ $8\frac{1}{2} \times \frac{5}{8}$	$13 \times \frac{5}{8}$ $17\frac{1}{2} \times \frac{5}{8}$	B4	11.0	93.5	0.350	17.85	$\frac{1}{2}$	$\frac{3}{4}$	B3	6.6	87.8	0.334	$9\frac{3}{4} \times \frac{3}{4}$ $9\frac{3}{4} \times \frac{3}{4}$	$14\frac{3}{4} \times \frac{3}{4}$ $19\frac{3}{4} \times \frac{3}{4}$	B4	13.2	93.9	0.410	19.12	$1\frac{1}{8}$	$\frac{3}{4}$	B3	6.5	87.5	0.410	$9\frac{3}{4} \times \frac{3}{4}$ $9\frac{3}{4} \times \frac{3}{4}$	$14\frac{3}{4} \times \frac{3}{4}$ $19\frac{3}{4} \times \frac{3}{4}$	B4	13.0	93.7	0.439	20.40	$\frac{1}{2}$	$\frac{3}{4}$ $\frac{3}{8}$	B4	13.0	93.0	0.465	$9\frac{3}{4} \times \frac{1}{2}$ $11\frac{1}{2} \times \frac{1}{2}$	$19\frac{3}{4} \times \frac{3}{8}$ $23\frac{1}{2} \times \frac{3}{8}$	B4	15.3	94.0	0.469	21.67	$1\frac{1}{8}$	$\frac{3}{4}$ $\frac{1}{2}$	B4	13.0	91.8	0.485	$9\frac{3}{4} \times \frac{1}{2}$ $11\frac{1}{2} \times \frac{1}{2}$	$19\frac{3}{4} \times \frac{3}{8}$ $23\frac{1}{2} \times \frac{3}{8}$	B4	15.1	93.8	0.498	22.95	$\frac{3}{8}$	$\frac{3}{4}$ $\frac{1}{2}$	B4	13.0	91.0	0.512	$9\frac{3}{4} \times \frac{1}{2}$ $11\frac{1}{2} \times \frac{1}{2}$	$19\frac{3}{4} \times \frac{1}{2}$ $23\frac{1}{2} \times \frac{1}{2}$	B4	15.0	93.4	0.525	24.22	$1\frac{1}{8}$	$\frac{1}{2}$	B4	15.0	92.3	0.549	$11\frac{1}{2} \times \frac{1}{2}$ $13\frac{1}{2} \times \frac{1}{2}$	$23\frac{1}{2} \times \frac{1}{2}$ $26\frac{1}{2} \times \frac{1}{2}$	B4	17.1	93.8	0.557	25.50	$\frac{3}{8}$	$\frac{1}{2}$	B4	15.0	91.5	0.572	$11\frac{1}{2} \times \frac{1}{2}$ $13\frac{1}{2} \times \frac{1}{2}$	$23\frac{1}{2} \times \frac{1}{2}$ $26\frac{1}{2} \times \frac{1}{2}$	B4	17.0	93.6	0.585	26.77	$1\frac{1}{8}$	$\frac{1}{2}$	B4	15.0	90.8	0.595	$11\frac{1}{2} \times \frac{1}{2}$ $13\frac{1}{2} \times \frac{1}{2}$	$23\frac{1}{2} \times \frac{1}{2}$ $26\frac{1}{2} \times \frac{1}{2}$	B4	17.0	92.9	0.610	28.05	$1\frac{1}{8}$	$\frac{1}{2}$	B4	15.0	90.0	0.619	$11\frac{1}{2} \times \frac{1}{2}$ $13\frac{1}{2} \times \frac{1}{2}$	$23\frac{1}{2} \times \frac{1}{2}$ $26\frac{1}{2} \times \frac{1}{2}$	B4	17.0	92.1	0.634	29.32	$1\frac{1}{8}$	$\frac{1}{2}$	B4	15.0	89.4	0.641	$11\frac{1}{2} \times \frac{1}{2}$ $13\frac{1}{2} \times \frac{1}{2}$	$23\frac{1}{2} \times \frac{1}{2}$ $26\frac{1}{2} \times \frac{1}{2}$	B4	17.0	91.2	0.656	30.60	$\frac{1}{2}$	$\frac{1}{2}$	B5	15.7	92.5	0.694	$11\frac{1}{2} \times \frac{1}{2}$ $13\frac{1}{2} \times \frac{1}{2}$	$23\frac{1}{2} \times \frac{1}{2}$ $26\frac{1}{2} \times \frac{1}{2}$	B5	18.3	93.3	0.700	31.87	$1\frac{1}{8}$	$\frac{1}{2}$	B5	15.1	92.0	0.718	$11\frac{1}{2} \times \frac{1}{2}$ $13\frac{1}{2} \times \frac{1}{2}$	$23\frac{1}{2} \times \frac{1}{2}$ $26\frac{1}{2} \times \frac{1}{2}$	B5	18.1	93.0	0.726	33.15	$1\frac{1}{8}$	$\frac{1}{2}$	B5	14.6	91.6	0.744	$11\frac{1}{2} \times \frac{1}{2}$ $13\frac{1}{2} \times \frac{1}{2}$	$23\frac{1}{2} \times \frac{1}{2}$ $26\frac{1}{2} \times \frac{1}{2}$	B5	18.0	92.8	0.754	34.42	$1\frac{1}{8}$	$\frac{1}{2}$	B5	14.1	91.1	0.767	$11\frac{1}{2} \times \frac{1}{2}$ $13\frac{1}{2} \times \frac{1}{2}$	$23\frac{1}{2} \times \frac{1}{2}$ $26\frac{1}{2} \times \frac{1}{2}$	B5	17.6	92.4	0.778	35.70	$\frac{1}{2}$	$\frac{1}{2}$	B5	13.7	90.7	0.798	$11\frac{1}{2} \times \frac{1}{2}$ $13\frac{1}{2} \times \frac{1}{2}$	$23\frac{1}{2} \times \frac{1}{2}$ $26\frac{1}{2} \times \frac{1}{2}$	B5	17.2	92.0	0.804	36.97	$1\frac{1}{8}$	$\frac{1}{2}$	B5	16.7	91.6	0.830	$13\frac{1}{2} \times \frac{1}{2}$ $15\frac{1}{2} \times \frac{1}{2}$	$32\frac{1}{2} \times \frac{1}{2}$ $36\frac{1}{2} \times \frac{1}{2}$	B5	20.5	93.0	0.843	38.25	$1\frac{1}{8}$	$\frac{1}{2}$	B5	16.2	91.2	0.855	$13\frac{1}{2} \times \frac{1}{2}$ $15\frac{1}{2} \times \frac{1}{2}$
16.57	$1\frac{1}{8}$	$\frac{5}{8}$	B3	5.5	87.5	0.335	$8\frac{1}{2} \times \frac{5}{8}$ $8\frac{1}{2} \times \frac{5}{8}$	$13 \times \frac{5}{8}$ $17\frac{1}{2} \times \frac{5}{8}$																																																																																																																																																																																																																																					
			B4	11.0	93.5	0.350			17.85	$\frac{1}{2}$	$\frac{3}{4}$	B3	6.6	87.8	0.334	$9\frac{3}{4} \times \frac{3}{4}$ $9\frac{3}{4} \times \frac{3}{4}$	$14\frac{3}{4} \times \frac{3}{4}$ $19\frac{3}{4} \times \frac{3}{4}$	B4	13.2	93.9	0.410	19.12	$1\frac{1}{8}$	$\frac{3}{4}$	B3	6.5	87.5	0.410	$9\frac{3}{4} \times \frac{3}{4}$ $9\frac{3}{4} \times \frac{3}{4}$	$14\frac{3}{4} \times \frac{3}{4}$ $19\frac{3}{4} \times \frac{3}{4}$	B4	13.0	93.7	0.439	20.40	$\frac{1}{2}$	$\frac{3}{4}$ $\frac{3}{8}$	B4	13.0	93.0	0.465	$9\frac{3}{4} \times \frac{1}{2}$ $11\frac{1}{2} \times \frac{1}{2}$	$19\frac{3}{4} \times \frac{3}{8}$ $23\frac{1}{2} \times \frac{3}{8}$	B4	15.3	94.0	0.469	21.67	$1\frac{1}{8}$	$\frac{3}{4}$ $\frac{1}{2}$	B4	13.0	91.8	0.485	$9\frac{3}{4} \times \frac{1}{2}$ $11\frac{1}{2} \times \frac{1}{2}$	$19\frac{3}{4} \times \frac{3}{8}$ $23\frac{1}{2} \times \frac{3}{8}$	B4	15.1	93.8	0.498	22.95	$\frac{3}{8}$	$\frac{3}{4}$ $\frac{1}{2}$	B4	13.0	91.0	0.512	$9\frac{3}{4} \times \frac{1}{2}$ $11\frac{1}{2} \times \frac{1}{2}$	$19\frac{3}{4} \times \frac{1}{2}$ $23\frac{1}{2} \times \frac{1}{2}$	B4	15.0	93.4	0.525	24.22	$1\frac{1}{8}$	$\frac{1}{2}$	B4	15.0	92.3	0.549	$11\frac{1}{2} \times \frac{1}{2}$ $13\frac{1}{2} \times \frac{1}{2}$	$23\frac{1}{2} \times \frac{1}{2}$ $26\frac{1}{2} \times \frac{1}{2}$	B4	17.1	93.8	0.557	25.50	$\frac{3}{8}$	$\frac{1}{2}$	B4	15.0	91.5	0.572	$11\frac{1}{2} \times \frac{1}{2}$ $13\frac{1}{2} \times \frac{1}{2}$	$23\frac{1}{2} \times \frac{1}{2}$ $26\frac{1}{2} \times \frac{1}{2}$	B4	17.0	93.6	0.585	26.77	$1\frac{1}{8}$	$\frac{1}{2}$	B4	15.0	90.8	0.595	$11\frac{1}{2} \times \frac{1}{2}$ $13\frac{1}{2} \times \frac{1}{2}$	$23\frac{1}{2} \times \frac{1}{2}$ $26\frac{1}{2} \times \frac{1}{2}$	B4	17.0	92.9	0.610	28.05	$1\frac{1}{8}$	$\frac{1}{2}$	B4	15.0	90.0	0.619	$11\frac{1}{2} \times \frac{1}{2}$ $13\frac{1}{2} \times \frac{1}{2}$	$23\frac{1}{2} \times \frac{1}{2}$ $26\frac{1}{2} \times \frac{1}{2}$	B4	17.0	92.1	0.634	29.32	$1\frac{1}{8}$	$\frac{1}{2}$	B4	15.0	89.4	0.641	$11\frac{1}{2} \times \frac{1}{2}$ $13\frac{1}{2} \times \frac{1}{2}$	$23\frac{1}{2} \times \frac{1}{2}$ $26\frac{1}{2} \times \frac{1}{2}$	B4	17.0	91.2	0.656	30.60	$\frac{1}{2}$	$\frac{1}{2}$	B5	15.7	92.5	0.694	$11\frac{1}{2} \times \frac{1}{2}$ $13\frac{1}{2} \times \frac{1}{2}$	$23\frac{1}{2} \times \frac{1}{2}$ $26\frac{1}{2} \times \frac{1}{2}$	B5	18.3	93.3	0.700	31.87	$1\frac{1}{8}$	$\frac{1}{2}$	B5	15.1	92.0	0.718	$11\frac{1}{2} \times \frac{1}{2}$ $13\frac{1}{2} \times \frac{1}{2}$	$23\frac{1}{2} \times \frac{1}{2}$ $26\frac{1}{2} \times \frac{1}{2}$	B5	18.1	93.0	0.726	33.15	$1\frac{1}{8}$	$\frac{1}{2}$	B5	14.6	91.6	0.744	$11\frac{1}{2} \times \frac{1}{2}$ $13\frac{1}{2} \times \frac{1}{2}$	$23\frac{1}{2} \times \frac{1}{2}$ $26\frac{1}{2} \times \frac{1}{2}$	B5	18.0	92.8	0.754	34.42	$1\frac{1}{8}$	$\frac{1}{2}$	B5	14.1	91.1	0.767	$11\frac{1}{2} \times \frac{1}{2}$ $13\frac{1}{2} \times \frac{1}{2}$	$23\frac{1}{2} \times \frac{1}{2}$ $26\frac{1}{2} \times \frac{1}{2}$	B5	17.6	92.4	0.778	35.70	$\frac{1}{2}$	$\frac{1}{2}$	B5	13.7	90.7	0.798	$11\frac{1}{2} \times \frac{1}{2}$ $13\frac{1}{2} \times \frac{1}{2}$	$23\frac{1}{2} \times \frac{1}{2}$ $26\frac{1}{2} \times \frac{1}{2}$	B5	17.2	92.0	0.804	36.97	$1\frac{1}{8}$	$\frac{1}{2}$	B5	16.7	91.6	0.830	$13\frac{1}{2} \times \frac{1}{2}$ $15\frac{1}{2} \times \frac{1}{2}$	$32\frac{1}{2} \times \frac{1}{2}$ $36\frac{1}{2} \times \frac{1}{2}$	B5	20.5	93.0	0.843	38.25	$1\frac{1}{8}$	$\frac{1}{2}$	B5	16.2	91.2	0.855	$13\frac{1}{2} \times \frac{1}{2}$ $15\frac{1}{2} \times \frac{1}{2}$	$32\frac{1}{2} \times \frac{1}{2}$ $36\frac{1}{2} \times \frac{1}{2}$	B5	20.0	92.7	0.867								
17.85	$\frac{1}{2}$	$\frac{3}{4}$	B3	6.6	87.8	0.334	$9\frac{3}{4} \times \frac{3}{4}$ $9\frac{3}{4} \times \frac{3}{4}$	$14\frac{3}{4} \times \frac{3}{4}$ $19\frac{3}{4} \times \frac{3}{4}$																																																																																																																																																																																																																																					
			B4	13.2	93.9	0.410			19.12	$1\frac{1}{8}$	$\frac{3}{4}$	B3	6.5	87.5	0.410	$9\frac{3}{4} \times \frac{3}{4}$ $9\frac{3}{4} \times \frac{3}{4}$	$14\frac{3}{4} \times \frac{3}{4}$ $19\frac{3}{4} \times \frac{3}{4}$	B4	13.0	93.7	0.439	20.40	$\frac{1}{2}$	$\frac{3}{4}$ $\frac{3}{8}$	B4	13.0	93.0	0.465	$9\frac{3}{4} \times \frac{1}{2}$ $11\frac{1}{2} \times \frac{1}{2}$	$19\frac{3}{4} \times \frac{3}{8}$ $23\frac{1}{2} \times \frac{3}{8}$	B4	15.3	94.0	0.469	21.67	$1\frac{1}{8}$	$\frac{3}{4}$ $\frac{1}{2}$	B4	13.0	91.8	0.485	$9\frac{3}{4} \times \frac{1}{2}$ $11\frac{1}{2} \times \frac{1}{2}$	$19\frac{3}{4} \times \frac{3}{8}$ $23\frac{1}{2} \times \frac{3}{8}$	B4	15.1	93.8	0.498	22.95	$\frac{3}{8}$	$\frac{3}{4}$ $\frac{1}{2}$	B4	13.0	91.0	0.512	$9\frac{3}{4} \times \frac{1}{2}$ $11\frac{1}{2} \times \frac{1}{2}$	$19\frac{3}{4} \times \frac{1}{2}$ $23\frac{1}{2} \times \frac{1}{2}$	B4	15.0	93.4	0.525	24.22	$1\frac{1}{8}$	$\frac{1}{2}$	B4	15.0	92.3	0.549	$11\frac{1}{2} \times \frac{1}{2}$ $13\frac{1}{2} \times \frac{1}{2}$	$23\frac{1}{2} \times \frac{1}{2}$ $26\frac{1}{2} \times \frac{1}{2}$	B4	17.1	93.8	0.557	25.50	$\frac{3}{8}$	$\frac{1}{2}$	B4	15.0	91.5	0.572	$11\frac{1}{2} \times \frac{1}{2}$ $13\frac{1}{2} \times \frac{1}{2}$	$23\frac{1}{2} \times \frac{1}{2}$ $26\frac{1}{2} \times \frac{1}{2}$	B4	17.0	93.6	0.585	26.77	$1\frac{1}{8}$	$\frac{1}{2}$	B4	15.0	90.8	0.595	$11\frac{1}{2} \times \frac{1}{2}$ $13\frac{1}{2} \times \frac{1}{2}$	$23\frac{1}{2} \times \frac{1}{2}$ $26\frac{1}{2} \times \frac{1}{2}$	B4	17.0	92.9	0.610	28.05	$1\frac{1}{8}$	$\frac{1}{2}$	B4	15.0	90.0	0.619	$11\frac{1}{2} \times \frac{1}{2}$ $13\frac{1}{2} \times \frac{1}{2}$	$23\frac{1}{2} \times \frac{1}{2}$ $26\frac{1}{2} \times \frac{1}{2}$	B4	17.0	92.1	0.634	29.32	$1\frac{1}{8}$	$\frac{1}{2}$	B4	15.0	89.4	0.641	$11\frac{1}{2} \times \frac{1}{2}$ $13\frac{1}{2} \times \frac{1}{2}$	$23\frac{1}{2} \times \frac{1}{2}$ $26\frac{1}{2} \times \frac{1}{2}$	B4	17.0	91.2	0.656	30.60	$\frac{1}{2}$	$\frac{1}{2}$	B5	15.7	92.5	0.694	$11\frac{1}{2} \times \frac{1}{2}$ $13\frac{1}{2} \times \frac{1}{2}$	$23\frac{1}{2} \times \frac{1}{2}$ $26\frac{1}{2} \times \frac{1}{2}$	B5	18.3	93.3	0.700	31.87	$1\frac{1}{8}$	$\frac{1}{2}$	B5	15.1	92.0	0.718	$11\frac{1}{2} \times \frac{1}{2}$ $13\frac{1}{2} \times \frac{1}{2}$	$23\frac{1}{2} \times \frac{1}{2}$ $26\frac{1}{2} \times \frac{1}{2}$	B5	18.1	93.0	0.726	33.15	$1\frac{1}{8}$	$\frac{1}{2}$	B5	14.6	91.6	0.744	$11\frac{1}{2} \times \frac{1}{2}$ $13\frac{1}{2} \times \frac{1}{2}$	$23\frac{1}{2} \times \frac{1}{2}$ $26\frac{1}{2} \times \frac{1}{2}$	B5	18.0	92.8	0.754	34.42	$1\frac{1}{8}$	$\frac{1}{2}$	B5	14.1	91.1	0.767	$11\frac{1}{2} \times \frac{1}{2}$ $13\frac{1}{2} \times \frac{1}{2}$	$23\frac{1}{2} \times \frac{1}{2}$ $26\frac{1}{2} \times \frac{1}{2}$	B5	17.6	92.4	0.778	35.70	$\frac{1}{2}$	$\frac{1}{2}$	B5	13.7	90.7	0.798	$11\frac{1}{2} \times \frac{1}{2}$ $13\frac{1}{2} \times \frac{1}{2}$	$23\frac{1}{2} \times \frac{1}{2}$ $26\frac{1}{2} \times \frac{1}{2}$	B5	17.2	92.0	0.804	36.97	$1\frac{1}{8}$	$\frac{1}{2}$	B5	16.7	91.6	0.830	$13\frac{1}{2} \times \frac{1}{2}$ $15\frac{1}{2} \times \frac{1}{2}$	$32\frac{1}{2} \times \frac{1}{2}$ $36\frac{1}{2} \times \frac{1}{2}$	B5	20.5	93.0	0.843	38.25	$1\frac{1}{8}$	$\frac{1}{2}$	B5	16.2	91.2	0.855	$13\frac{1}{2} \times \frac{1}{2}$ $15\frac{1}{2} \times \frac{1}{2}$	$32\frac{1}{2} \times \frac{1}{2}$ $36\frac{1}{2} \times \frac{1}{2}$	B5	20.0	92.7	0.867																					
19.12	$1\frac{1}{8}$	$\frac{3}{4}$	B3	6.5	87.5	0.410	$9\frac{3}{4} \times \frac{3}{4}$ $9\frac{3}{4} \times \frac{3}{4}$	$14\frac{3}{4} \times \frac{3}{4}$ $19\frac{3}{4} \times \frac{3}{4}$																																																																																																																																																																																																																																					
			B4	13.0	93.7	0.439			20.40	$\frac{1}{2}$	$\frac{3}{4}$ $\frac{3}{8}$	B4	13.0	93.0	0.465	$9\frac{3}{4} \times \frac{1}{2}$ $11\frac{1}{2} \times \frac{1}{2}$	$19\frac{3}{4} \times \frac{3}{8}$ $23\frac{1}{2} \times \frac{3}{8}$	B4	15.3	94.0	0.469	21.67	$1\frac{1}{8}$	$\frac{3}{4}$ $\frac{1}{2}$	B4	13.0	91.8	0.485	$9\frac{3}{4} \times \frac{1}{2}$ $11\frac{1}{2} \times \frac{1}{2}$	$19\frac{3}{4} \times \frac{3}{8}$ $23\frac{1}{2} \times \frac{3}{8}$	B4	15.1	93.8	0.498	22.95	$\frac{3}{8}$	$\frac{3}{4}$ $\frac{1}{2}$	B4	13.0	91.0	0.512	$9\frac{3}{4} \times \frac{1}{2}$ $11\frac{1}{2} \times \frac{1}{2}$	$19\frac{3}{4} \times \frac{1}{2}$ $23\frac{1}{2} \times \frac{1}{2}$	B4	15.0	93.4	0.525	24.22	$1\frac{1}{8}$	$\frac{1}{2}$	B4	15.0	92.3	0.549	$11\frac{1}{2} \times \frac{1}{2}$ $13\frac{1}{2} \times \frac{1}{2}$	$23\frac{1}{2} \times \frac{1}{2}$ $26\frac{1}{2} \times \frac{1}{2}$	B4	17.1	93.8	0.557	25.50	$\frac{3}{8}$	$\frac{1}{2}$	B4	15.0	91.5	0.572	$11\frac{1}{2} \times \frac{1}{2}$ $13\frac{1}{2} \times \frac{1}{2}$	$23\frac{1}{2} \times \frac{1}{2}$ $26\frac{1}{2} \times \frac{1}{2}$	B4	17.0	93.6	0.585	26.77	$1\frac{1}{8}$	$\frac{1}{2}$	B4	15.0	90.8	0.595	$11\frac{1}{2} \times \frac{1}{2}$ $13\frac{1}{2} \times \frac{1}{2}$	$23\frac{1}{2} \times \frac{1}{2}$ $26\frac{1}{2} \times \frac{1}{2}$	B4	17.0	92.9	0.610	28.05	$1\frac{1}{8}$	$\frac{1}{2}$	B4	15.0	90.0	0.619	$11\frac{1}{2} \times \frac{1}{2}$ $13\frac{1}{2} \times \frac{1}{2}$	$23\frac{1}{2} \times \frac{1}{2}$ $26\frac{1}{2} \times \frac{1}{2}$	B4	17.0	92.1	0.634	29.32	$1\frac{1}{8}$	$\frac{1}{2}$	B4	15.0	89.4	0.641	$11\frac{1}{2} \times \frac{1}{2}$ $13\frac{1}{2} \times \frac{1}{2}$	$23\frac{1}{2} \times \frac{1}{2}$ $26\frac{1}{2} \times \frac{1}{2}$	B4	17.0	91.2	0.656	30.60	$\frac{1}{2}$	$\frac{1}{2}$	B5	15.7	92.5	0.694	$11\frac{1}{2} \times \frac{1}{2}$ $13\frac{1}{2} \times \frac{1}{2}$	$23\frac{1}{2} \times \frac{1}{2}$ $26\frac{1}{2} \times \frac{1}{2}$	B5	18.3	93.3	0.700	31.87	$1\frac{1}{8}$	$\frac{1}{2}$	B5	15.1	92.0	0.718	$11\frac{1}{2} \times \frac{1}{2}$ $13\frac{1}{2} \times \frac{1}{2}$	$23\frac{1}{2} \times \frac{1}{2}$ $26\frac{1}{2} \times \frac{1}{2}$	B5	18.1	93.0	0.726	33.15	$1\frac{1}{8}$	$\frac{1}{2}$	B5	14.6	91.6	0.744	$11\frac{1}{2} \times \frac{1}{2}$ $13\frac{1}{2} \times \frac{1}{2}$	$23\frac{1}{2} \times \frac{1}{2}$ $26\frac{1}{2} \times \frac{1}{2}$	B5	18.0	92.8	0.754	34.42	$1\frac{1}{8}$	$\frac{1}{2}$	B5	14.1	91.1	0.767	$11\frac{1}{2} \times \frac{1}{2}$ $13\frac{1}{2} \times \frac{1}{2}$	$23\frac{1}{2} \times \frac{1}{2}$ $26\frac{1}{2} \times \frac{1}{2}$	B5	17.6	92.4	0.778	35.70	$\frac{1}{2}$	$\frac{1}{2}$	B5	13.7	90.7	0.798	$11\frac{1}{2} \times \frac{1}{2}$ $13\frac{1}{2} \times \frac{1}{2}$	$23\frac{1}{2} \times \frac{1}{2}$ $26\frac{1}{2} \times \frac{1}{2}$	B5	17.2	92.0	0.804	36.97	$1\frac{1}{8}$	$\frac{1}{2}$	B5	16.7	91.6	0.830	$13\frac{1}{2} \times \frac{1}{2}$ $15\frac{1}{2} \times \frac{1}{2}$	$32\frac{1}{2} \times \frac{1}{2}$ $36\frac{1}{2} \times \frac{1}{2}$	B5	20.5	93.0	0.843	38.25	$1\frac{1}{8}$	$\frac{1}{2}$	B5	16.2	91.2	0.855	$13\frac{1}{2} \times \frac{1}{2}$ $15\frac{1}{2} \times \frac{1}{2}$	$32\frac{1}{2} \times \frac{1}{2}$ $36\frac{1}{2} \times \frac{1}{2}$	B5	20.0	92.7	0.867																																		
20.40	$\frac{1}{2}$	$\frac{3}{4}$ $\frac{3}{8}$	B4	13.0	93.0	0.465	$9\frac{3}{4} \times \frac{1}{2}$ $11\frac{1}{2} \times \frac{1}{2}$	$19\frac{3}{4} \times \frac{3}{8}$ $23\frac{1}{2} \times \frac{3}{8}$																																																																																																																																																																																																																																					
			B4	15.3	94.0	0.469			21.67	$1\frac{1}{8}$	$\frac{3}{4}$ $\frac{1}{2}$	B4	13.0	91.8	0.485	$9\frac{3}{4} \times \frac{1}{2}$ $11\frac{1}{2} \times \frac{1}{2}$	$19\frac{3}{4} \times \frac{3}{8}$ $23\frac{1}{2} \times \frac{3}{8}$	B4	15.1	93.8	0.498	22.95	$\frac{3}{8}$	$\frac{3}{4}$ $\frac{1}{2}$	B4	13.0	91.0	0.512	$9\frac{3}{4} \times \frac{1}{2}$ $11\frac{1}{2} \times \frac{1}{2}$	$19\frac{3}{4} \times \frac{1}{2}$ $23\frac{1}{2} \times \frac{1}{2}$	B4	15.0	93.4	0.525	24.22	$1\frac{1}{8}$	$\frac{1}{2}$	B4	15.0	92.3	0.549	$11\frac{1}{2} \times \frac{1}{2}$ $13\frac{1}{2} \times \frac{1}{2}$	$23\frac{1}{2} \times \frac{1}{2}$ $26\frac{1}{2} \times \frac{1}{2}$	B4	17.1	93.8	0.557	25.50	$\frac{3}{8}$	$\frac{1}{2}$	B4	15.0	91.5	0.572	$11\frac{1}{2} \times \frac{1}{2}$ $13\frac{1}{2} \times \frac{1}{2}$	$23\frac{1}{2} \times \frac{1}{2}$ $26\frac{1}{2} \times \frac{1}{2}$	B4	17.0	93.6	0.585	26.77	$1\frac{1}{8}$	$\frac{1}{2}$	B4	15.0	90.8	0.595	$11\frac{1}{2} \times \frac{1}{2}$ $13\frac{1}{2} \times \frac{1}{2}$	$23\frac{1}{2} \times \frac{1}{2}$ $26\frac{1}{2} \times \frac{1}{2}$	B4	17.0	92.9	0.610	28.05	$1\frac{1}{8}$	$\frac{1}{2}$	B4	15.0	90.0	0.619	$11\frac{1}{2} \times \frac{1}{2}$ $13\frac{1}{2} \times \frac{1}{2}$	$23\frac{1}{2} \times \frac{1}{2}$ $26\frac{1}{2} \times \frac{1}{2}$	B4	17.0	92.1	0.634	29.32	$1\frac{1}{8}$	$\frac{1}{2}$	B4	15.0	89.4	0.641	$11\frac{1}{2} \times \frac{1}{2}$ $13\frac{1}{2} \times \frac{1}{2}$	$23\frac{1}{2} \times \frac{1}{2}$ $26\frac{1}{2} \times \frac{1}{2}$	B4	17.0	91.2	0.656	30.60	$\frac{1}{2}$	$\frac{1}{2}$	B5	15.7	92.5	0.694	$11\frac{1}{2} \times \frac{1}{2}$ $13\frac{1}{2} \times \frac{1}{2}$	$23\frac{1}{2} \times \frac{1}{2}$ $26\frac{1}{2} \times \frac{1}{2}$	B5	18.3	93.3	0.700	31.87	$1\frac{1}{8}$	$\frac{1}{2}$	B5	15.1	92.0	0.718	$11\frac{1}{2} \times \frac{1}{2}$ $13\frac{1}{2} \times \frac{1}{2}$	$23\frac{1}{2} \times \frac{1}{2}$ $26\frac{1}{2} \times \frac{1}{2}$	B5	18.1	93.0	0.726	33.15	$1\frac{1}{8}$	$\frac{1}{2}$	B5	14.6	91.6	0.744	$11\frac{1}{2} \times \frac{1}{2}$ $13\frac{1}{2} \times \frac{1}{2}$	$23\frac{1}{2} \times \frac{1}{2}$ $26\frac{1}{2} \times \frac{1}{2}$	B5	18.0	92.8	0.754	34.42	$1\frac{1}{8}$	$\frac{1}{2}$	B5	14.1	91.1	0.767	$11\frac{1}{2} \times \frac{1}{2}$ $13\frac{1}{2} \times \frac{1}{2}$	$23\frac{1}{2} \times \frac{1}{2}$ $26\frac{1}{2} \times \frac{1}{2}$	B5	17.6	92.4	0.778	35.70	$\frac{1}{2}$	$\frac{1}{2}$	B5	13.7	90.7	0.798	$11\frac{1}{2} \times \frac{1}{2}$ $13\frac{1}{2} \times \frac{1}{2}$	$23\frac{1}{2} \times \frac{1}{2}$ $26\frac{1}{2} \times \frac{1}{2}$	B5	17.2	92.0	0.804	36.97	$1\frac{1}{8}$	$\frac{1}{2}$	B5	16.7	91.6	0.830	$13\frac{1}{2} \times \frac{1}{2}$ $15\frac{1}{2} \times \frac{1}{2}$	$32\frac{1}{2} \times \frac{1}{2}$ $36\frac{1}{2} \times \frac{1}{2}$	B5	20.5	93.0	0.843	38.25	$1\frac{1}{8}$	$\frac{1}{2}$	B5	16.2	91.2	0.855	$13\frac{1}{2} \times \frac{1}{2}$ $15\frac{1}{2} \times \frac{1}{2}$	$32\frac{1}{2} \times \frac{1}{2}$ $36\frac{1}{2} \times \frac{1}{2}$	B5	20.0	92.7	0.867																																															
21.67	$1\frac{1}{8}$	$\frac{3}{4}$ $\frac{1}{2}$	B4	13.0	91.8	0.485	$9\frac{3}{4} \times \frac{1}{2}$ $11\frac{1}{2} \times \frac{1}{2}$	$19\frac{3}{4} \times \frac{3}{8}$ $23\frac{1}{2} \times \frac{3}{8}$																																																																																																																																																																																																																																					
			B4	15.1	93.8	0.498			22.95	$\frac{3}{8}$	$\frac{3}{4}$ $\frac{1}{2}$	B4	13.0	91.0	0.512	$9\frac{3}{4} \times \frac{1}{2}$ $11\frac{1}{2} \times \frac{1}{2}$	$19\frac{3}{4} \times \frac{1}{2}$ $23\frac{1}{2} \times \frac{1}{2}$	B4	15.0	93.4	0.525	24.22	$1\frac{1}{8}$	$\frac{1}{2}$	B4	15.0	92.3	0.549	$11\frac{1}{2} \times \frac{1}{2}$ $13\frac{1}{2} \times \frac{1}{2}$	$23\frac{1}{2} \times \frac{1}{2}$ $26\frac{1}{2} \times \frac{1}{2}$	B4	17.1	93.8	0.557	25.50	$\frac{3}{8}$	$\frac{1}{2}$	B4	15.0	91.5	0.572	$11\frac{1}{2} \times \frac{1}{2}$ $13\frac{1}{2} \times \frac{1}{2}$	$23\frac{1}{2} \times \frac{1}{2}$ $26\frac{1}{2} \times \frac{1}{2}$	B4	17.0	93.6	0.585	26.77	$1\frac{1}{8}$	$\frac{1}{2}$	B4	15.0	90.8	0.595	$11\frac{1}{2} \times \frac{1}{2}$ $13\frac{1}{2} \times \frac{1}{2}$	$23\frac{1}{2} \times \frac{1}{2}$ $26\frac{1}{2} \times \frac{1}{2}$	B4	17.0	92.9	0.610	28.05	$1\frac{1}{8}$	$\frac{1}{2}$	B4	15.0	90.0	0.619	$11\frac{1}{2} \times \frac{1}{2}$ $13\frac{1}{2} \times \frac{1}{2}$	$23\frac{1}{2} \times \frac{1}{2}$ $26\frac{1}{2} \times \frac{1}{2}$	B4	17.0	92.1	0.634	29.32	$1\frac{1}{8}$	$\frac{1}{2}$	B4	15.0	89.4	0.641	$11\frac{1}{2} \times \frac{1}{2}$ $13\frac{1}{2} \times \frac{1}{2}$	$23\frac{1}{2} \times \frac{1}{2}$ $26\frac{1}{2} \times \frac{1}{2}$	B4	17.0	91.2	0.656	30.60	$\frac{1}{2}$	$\frac{1}{2}$	B5	15.7	92.5	0.694	$11\frac{1}{2} \times \frac{1}{2}$ $13\frac{1}{2} \times \frac{1}{2}$	$23\frac{1}{2} \times \frac{1}{2}$ $26\frac{1}{2} \times \frac{1}{2}$	B5	18.3	93.3	0.700	31.87	$1\frac{1}{8}$	$\frac{1}{2}$	B5	15.1	92.0	0.718	$11\frac{1}{2} \times \frac{1}{2}$ $13\frac{1}{2} \times \frac{1}{2}$	$23\frac{1}{2} \times \frac{1}{2}$ $26\frac{1}{2} \times \frac{1}{2}$	B5	18.1	93.0	0.726	33.15	$1\frac{1}{8}$	$\frac{1}{2}$	B5	14.6	91.6	0.744	$11\frac{1}{2} \times \frac{1}{2}$ $13\frac{1}{2} \times \frac{1}{2}$	$23\frac{1}{2} \times \frac{1}{2}$ $26\frac{1}{2} \times \frac{1}{2}$	B5	18.0	92.8	0.754	34.42	$1\frac{1}{8}$	$\frac{1}{2}$	B5	14.1	91.1	0.767	$11\frac{1}{2} \times \frac{1}{2}$ $13\frac{1}{2} \times \frac{1}{2}$	$23\frac{1}{2} \times \frac{1}{2}$ $26\frac{1}{2} \times \frac{1}{2}$	B5	17.6	92.4	0.778	35.70	$\frac{1}{2}$	$\frac{1}{2}$	B5	13.7	90.7	0.798	$11\frac{1}{2} \times \frac{1}{2}$ $13\frac{1}{2} \times \frac{1}{2}$	$23\frac{1}{2} \times \frac{1}{2}$ $26\frac{1}{2} \times \frac{1}{2}$	B5	17.2	92.0	0.804	36.97	$1\frac{1}{8}$	$\frac{1}{2}$	B5	16.7	91.6	0.830	$13\frac{1}{2} \times \frac{1}{2}$ $15\frac{1}{2} \times \frac{1}{2}$	$32\frac{1}{2} \times \frac{1}{2}$ $36\frac{1}{2} \times \frac{1}{2}$	B5	20.5	93.0	0.843	38.25	$1\frac{1}{8}$	$\frac{1}{2}$	B5	16.2	91.2	0.855	$13\frac{1}{2} \times \frac{1}{2}$ $15\frac{1}{2} \times \frac{1}{2}$	$32\frac{1}{2} \times \frac{1}{2}$ $36\frac{1}{2} \times \frac{1}{2}$	B5	20.0	92.7	0.867																																																												
22.95	$\frac{3}{8}$	$\frac{3}{4}$ $\frac{1}{2}$	B4	13.0	91.0	0.512	$9\frac{3}{4} \times \frac{1}{2}$ $11\frac{1}{2} \times \frac{1}{2}$	$19\frac{3}{4} \times \frac{1}{2}$ $23\frac{1}{2} \times \frac{1}{2}$																																																																																																																																																																																																																																					
			B4	15.0	93.4	0.525			24.22	$1\frac{1}{8}$	$\frac{1}{2}$	B4	15.0	92.3	0.549	$11\frac{1}{2} \times \frac{1}{2}$ $13\frac{1}{2} \times \frac{1}{2}$	$23\frac{1}{2} \times \frac{1}{2}$ $26\frac{1}{2} \times \frac{1}{2}$	B4	17.1	93.8	0.557	25.50	$\frac{3}{8}$	$\frac{1}{2}$	B4	15.0	91.5	0.572	$11\frac{1}{2} \times \frac{1}{2}$ $13\frac{1}{2} \times \frac{1}{2}$	$23\frac{1}{2} \times \frac{1}{2}$ $26\frac{1}{2} \times \frac{1}{2}$	B4	17.0	93.6	0.585	26.77	$1\frac{1}{8}$	$\frac{1}{2}$	B4	15.0	90.8	0.595	$11\frac{1}{2} \times \frac{1}{2}$ $13\frac{1}{2} \times \frac{1}{2}$	$23\frac{1}{2} \times \frac{1}{2}$ $26\frac{1}{2} \times \frac{1}{2}$	B4	17.0	92.9	0.610	28.05	$1\frac{1}{8}$	$\frac{1}{2}$	B4	15.0	90.0	0.619	$11\frac{1}{2} \times \frac{1}{2}$ $13\frac{1}{2} \times \frac{1}{2}$	$23\frac{1}{2} \times \frac{1}{2}$ $26\frac{1}{2} \times \frac{1}{2}$	B4	17.0	92.1	0.634	29.32	$1\frac{1}{8}$	$\frac{1}{2}$	B4	15.0	89.4	0.641	$11\frac{1}{2} \times \frac{1}{2}$ $13\frac{1}{2} \times \frac{1}{2}$	$23\frac{1}{2} \times \frac{1}{2}$ $26\frac{1}{2} \times \frac{1}{2}$	B4	17.0	91.2	0.656	30.60	$\frac{1}{2}$	$\frac{1}{2}$	B5	15.7	92.5	0.694	$11\frac{1}{2} \times \frac{1}{2}$ $13\frac{1}{2} \times \frac{1}{2}$	$23\frac{1}{2} \times \frac{1}{2}$ $26\frac{1}{2} \times \frac{1}{2}$	B5	18.3	93.3	0.700	31.87	$1\frac{1}{8}$	$\frac{1}{2}$	B5	15.1	92.0	0.718	$11\frac{1}{2} \times \frac{1}{2}$ $13\frac{1}{2} \times \frac{1}{2}$	$23\frac{1}{2} \times \frac{1}{2}$ $26\frac{1}{2} \times \frac{1}{2}$	B5	18.1	93.0	0.726	33.15	$1\frac{1}{8}$	$\frac{1}{2}$	B5	14.6	91.6	0.744	$11\frac{1}{2} \times \frac{1}{2}$ $13\frac{1}{2} \times \frac{1}{2}$	$23\frac{1}{2} \times \frac{1}{2}$ $26\frac{1}{2} \times \frac{1}{2}$	B5	18.0	92.8	0.754	34.42	$1\frac{1}{8}$	$\frac{1}{2}$	B5	14.1	91.1	0.767	$11\frac{1}{2} \times \frac{1}{2}$ $13\frac{1}{2} \times \frac{1}{2}$	$23\frac{1}{2} \times \frac{1}{2}$ $26\frac{1}{2} \times \frac{1}{2}$	B5	17.6	92.4	0.778	35.70	$\frac{1}{2}$	$\frac{1}{2}$	B5	13.7	90.7	0.798	$11\frac{1}{2} \times \frac{1}{2}$ $13\frac{1}{2} \times \frac{1}{2}$	$23\frac{1}{2} \times \frac{1}{2}$ $26\frac{1}{2} \times \frac{1}{2}$	B5	17.2	92.0	0.804	36.97	$1\frac{1}{8}$	$\frac{1}{2}$	B5	16.7	91.6	0.830	$13\frac{1}{2} \times \frac{1}{2}$ $15\frac{1}{2} \times \frac{1}{2}$	$32\frac{1}{2} \times \frac{1}{2}$ $36\frac{1}{2} \times \frac{1}{2}$	B5	20.5	93.0	0.843	38.25	$1\frac{1}{8}$	$\frac{1}{2}$	B5	16.2	91.2	0.855	$13\frac{1}{2} \times \frac{1}{2}$ $15\frac{1}{2} \times \frac{1}{2}$	$32\frac{1}{2} \times \frac{1}{2}$ $36\frac{1}{2} \times \frac{1}{2}$	B5	20.0	92.7	0.867																																																																									
24.22	$1\frac{1}{8}$	$\frac{1}{2}$	B4	15.0	92.3	0.549	$11\frac{1}{2} \times \frac{1}{2}$ $13\frac{1}{2} \times \frac{1}{2}$	$23\frac{1}{2} \times \frac{1}{2}$ $26\frac{1}{2} \times \frac{1}{2}$																																																																																																																																																																																																																																					
			B4	17.1	93.8	0.557			25.50	$\frac{3}{8}$	$\frac{1}{2}$	B4	15.0	91.5	0.572	$11\frac{1}{2} \times \frac{1}{2}$ $13\frac{1}{2} \times \frac{1}{2}$	$23\frac{1}{2} \times \frac{1}{2}$ $26\frac{1}{2} \times \frac{1}{2}$	B4	17.0	93.6	0.585	26.77	$1\frac{1}{8}$	$\frac{1}{2}$	B4	15.0	90.8	0.595	$11\frac{1}{2} \times \frac{1}{2}$ $13\frac{1}{2} \times \frac{1}{2}$	$23\frac{1}{2} \times \frac{1}{2}$ $26\frac{1}{2} \times \frac{1}{2}$	B4	17.0	92.9	0.610	28.05	$1\frac{1}{8}$	$\frac{1}{2}$	B4	15.0	90.0	0.619	$11\frac{1}{2} \times \frac{1}{2}$ $13\frac{1}{2} \times \frac{1}{2}$	$23\frac{1}{2} \times \frac{1}{2}$ $26\frac{1}{2} \times \frac{1}{2}$	B4	17.0	92.1	0.634	29.32	$1\frac{1}{8}$	$\frac{1}{2}$	B4	15.0	89.4	0.641	$11\frac{1}{2} \times \frac{1}{2}$ $13\frac{1}{2} \times \frac{1}{2}$	$23\frac{1}{2} \times \frac{1}{2}$ $26\frac{1}{2} \times \frac{1}{2}$	B4	17.0	91.2	0.656	30.60	$\frac{1}{2}$	$\frac{1}{2}$	B5	15.7	92.5	0.694	$11\frac{1}{2} \times \frac{1}{2}$ $13\frac{1}{2} \times \frac{1}{2}$	$23\frac{1}{2} \times \frac{1}{2}$ $26\frac{1}{2} \times \frac{1}{2}$	B5	18.3	93.3	0.700	31.87	$1\frac{1}{8}$	$\frac{1}{2}$	B5	15.1	92.0	0.718	$11\frac{1}{2} \times \frac{1}{2}$ $13\frac{1}{2} \times \frac{1}{2}$	$23\frac{1}{2} \times \frac{1}{2}$ $26\frac{1}{2} \times \frac{1}{2}$	B5	18.1	93.0	0.726	33.15	$1\frac{1}{8}$	$\frac{1}{2}$	B5	14.6	91.6	0.744	$11\frac{1}{2} \times \frac{1}{2}$ $13\frac{1}{2} \times \frac{1}{2}$	$23\frac{1}{2} \times \frac{1}{2}$ $26\frac{1}{2} \times \frac{1}{2}$	B5	18.0	92.8	0.754	34.42	$1\frac{1}{8}$	$\frac{1}{2}$	B5	14.1	91.1	0.767	$11\frac{1}{2} \times \frac{1}{2}$ $13\frac{1}{2} \times \frac{1}{2}$	$23\frac{1}{2} \times \frac{1}{2}$ $26\frac{1}{2} \times \frac{1}{2}$	B5	17.6	92.4	0.778	35.70	$\frac{1}{2}$	$\frac{1}{2}$	B5	13.7	90.7	0.798	$11\frac{1}{2} \times \frac{1}{2}$ $13\frac{1}{2} \times \frac{1}{2}$	$23\frac{1}{2} \times \frac{1}{2}$ $26\frac{1}{2} \times \frac{1}{2}$	B5	17.2	92.0	0.804	36.97	$1\frac{1}{8}$	$\frac{1}{2}$	B5	16.7	91.6	0.830	$13\frac{1}{2} \times \frac{1}{2}$ $15\frac{1}{2} \times \frac{1}{2}$	$32\frac{1}{2} \times \frac{1}{2}$ $36\frac{1}{2} \times \frac{1}{2}$	B5	20.5	93.0	0.843	38.25	$1\frac{1}{8}$	$\frac{1}{2}$	B5	16.2	91.2	0.855	$13\frac{1}{2} \times \frac{1}{2}$ $15\frac{1}{2} \times \frac{1}{2}$	$32\frac{1}{2} \times \frac{1}{2}$ $36\frac{1}{2} \times \frac{1}{2}$	B5	20.0	92.7	0.867																																																																																						
25.50	$\frac{3}{8}$	$\frac{1}{2}$	B4	15.0	91.5	0.572	$11\frac{1}{2} \times \frac{1}{2}$ $13\frac{1}{2} \times \frac{1}{2}$	$23\frac{1}{2} \times \frac{1}{2}$ $26\frac{1}{2} \times \frac{1}{2}$																																																																																																																																																																																																																																					
			B4	17.0	93.6	0.585			26.77	$1\frac{1}{8}$	$\frac{1}{2}$	B4	15.0	90.8	0.595	$11\frac{1}{2} \times \frac{1}{2}$ $13\frac{1}{2} \times \frac{1}{2}$	$23\frac{1}{2} \times \frac{1}{2}$ $26\frac{1}{2} \times \frac{1}{2}$	B4	17.0	92.9	0.610	28.05	$1\frac{1}{8}$	$\frac{1}{2}$	B4	15.0	90.0	0.619	$11\frac{1}{2} \times \frac{1}{2}$ $13\frac{1}{2} \times \frac{1}{2}$	$23\frac{1}{2} \times \frac{1}{2}$ $26\frac{1}{2} \times \frac{1}{2}$	B4	17.0	92.1	0.634	29.32	$1\frac{1}{8}$	$\frac{1}{2}$	B4	15.0	89.4	0.641	$11\frac{1}{2} \times \frac{1}{2}$ $13\frac{1}{2} \times \frac{1}{2}$	$23\frac{1}{2} \times \frac{1}{2}$ $26\frac{1}{2} \times \frac{1}{2}$	B4	17.0	91.2	0.656	30.60	$\frac{1}{2}$	$\frac{1}{2}$	B5	15.7	92.5	0.694	$11\frac{1}{2} \times \frac{1}{2}$ $13\frac{1}{2} \times \frac{1}{2}$	$23\frac{1}{2} \times \frac{1}{2}$ $26\frac{1}{2} \times \frac{1}{2}$	B5	18.3	93.3	0.700	31.87	$1\frac{1}{8}$	$\frac{1}{2}$	B5	15.1	92.0	0.718	$11\frac{1}{2} \times \frac{1}{2}$ $13\frac{1}{2} \times \frac{1}{2}$	$23\frac{1}{2} \times \frac{1}{2}$ $26\frac{1}{2} \times \frac{1}{2}$	B5	18.1	93.0	0.726	33.15	$1\frac{1}{8}$	$\frac{1}{2}$	B5	14.6	91.6	0.744	$11\frac{1}{2} \times \frac{1}{2}$ $13\frac{1}{2} \times \frac{1}{2}$	$23\frac{1}{2} \times \frac{1}{2}$ $26\frac{1}{2} \times \frac{1}{2}$	B5	18.0	92.8	0.754	34.42	$1\frac{1}{8}$	$\frac{1}{2}$	B5	14.1	91.1	0.767	$11\frac{1}{2} \times \frac{1}{2}$ $13\frac{1}{2} \times \frac{1}{2}$	$23\frac{1}{2} \times \frac{1}{2}$ $26\frac{1}{2} \times \frac{1}{2}$	B5	17.6	92.4	0.778	35.70	$\frac{1}{2}$	$\frac{1}{2}$	B5	13.7	90.7	0.798	$11\frac{1}{2} \times \frac{1}{2}$ $13\frac{1}{2} \times \frac{1}{2}$	$23\frac{1}{2} \times \frac{1}{2}$ $26\frac{1}{2} \times \frac{1}{2}$	B5	17.2	92.0	0.804	36.97	$1\frac{1}{8}$	$\frac{1}{2}$	B5	16.7	91.6	0.830	$13\frac{1}{2} \times \frac{1}{2}$ $15\frac{1}{2} \times \frac{1}{2}$	$32\frac{1}{2} \times \frac{1}{2}$ $36\frac{1}{2} \times \frac{1}{2}$	B5	20.5	93.0	0.843	38.25	$1\frac{1}{8}$	$\frac{1}{2}$	B5	16.2	91.2	0.855	$13\frac{1}{2} \times \frac{1}{2}$ $15\frac{1}{2} \times \frac{1}{2}$	$32\frac{1}{2} \times \frac{1}{2}$ $36\frac{1}{2} \times \frac{1}{2}$	B5	20.0	92.7	0.867																																																																																																			
26.77	$1\frac{1}{8}$	$\frac{1}{2}$	B4	15.0	90.8	0.595	$11\frac{1}{2} \times \frac{1}{2}$ $13\frac{1}{2} \times \frac{1}{2}$	$23\frac{1}{2} \times \frac{1}{2}$ $26\frac{1}{2} \times \frac{1}{2}$																																																																																																																																																																																																																																					
			B4	17.0	92.9	0.610			28.05	$1\frac{1}{8}$	$\frac{1}{2}$	B4	15.0	90.0	0.619	$11\frac{1}{2} \times \frac{1}{2}$ $13\frac{1}{2} \times \frac{1}{2}$	$23\frac{1}{2} \times \frac{1}{2}$ $26\frac{1}{2} \times \frac{1}{2}$	B4	17.0	92.1	0.634	29.32	$1\frac{1}{8}$	$\frac{1}{2}$	B4	15.0	89.4	0.641	$11\frac{1}{2} \times \frac{1}{2}$ $13\frac{1}{2} \times \frac{1}{2}$	$23\frac{1}{2} \times \frac{1}{2}$ $26\frac{1}{2} \times \frac{1}{2}$	B4	17.0	91.2	0.656	30.60	$\frac{1}{2}$	$\frac{1}{2}$	B5	15.7	92.5	0.694	$11\frac{1}{2} \times \frac{1}{2}$ $13\frac{1}{2} \times \frac{1}{2}$	$23\frac{1}{2} \times \frac{1}{2}$ $26\frac{1}{2} \times \frac{1}{2}$	B5	18.3	93.3	0.700	31.87	$1\frac{1}{8}$	$\frac{1}{2}$	B5	15.1	92.0	0.718	$11\frac{1}{2} \times \frac{1}{2}$ $13\frac{1}{2} \times \frac{1}{2}$	$23\frac{1}{2} \times \frac{1}{2}$ $26\frac{1}{2} \times \frac{1}{2}$	B5	18.1	93.0	0.726	33.15	$1\frac{1}{8}$	$\frac{1}{2}$	B5	14.6	91.6	0.744	$11\frac{1}{2} \times \frac{1}{2}$ $13\frac{1}{2} \times \frac{1}{2}$	$23\frac{1}{2} \times \frac{1}{2}$ $26\frac{1}{2} \times \frac{1}{2}$	B5	18.0	92.8	0.754	34.42	$1\frac{1}{8}$	$\frac{1}{2}$	B5	14.1	91.1	0.767	$11\frac{1}{2} \times \frac{1}{2}$ $13\frac{1}{2} \times \frac{1}{2}$	$23\frac{1}{2} \times \frac{1}{2}$ $26\frac{1}{2} \times \frac{1}{2}$	B5	17.6	92.4	0.778	35.70	$\frac{1}{2}$	$\frac{1}{2}$	B5	13.7	90.7	0.798	$11\frac{1}{2} \times \frac{1}{2}$ $13\frac{1}{2} \times \frac{1}{2}$	$23\frac{1}{2} \times \frac{1}{2}$ $26\frac{1}{2} \times \frac{1}{2}$	B5	17.2	92.0	0.804	36.97	$1\frac{1}{8}$	$\frac{1}{2}$	B5	16.7	91.6	0.830	$13\frac{1}{2} \times \frac{1}{2}$ $15\frac{1}{2} \times \frac{1}{2}$	$32\frac{1}{2} \times \frac{1}{2}$ $36\frac{1}{2} \times \frac{1}{2}$	B5	20.5	93.0	0.843	38.25	$1\frac{1}{8}$	$\frac{1}{2}$	B5	16.2	91.2	0.855	$13\frac{1}{2} \times \frac{1}{2}$ $15\frac{1}{2} \times \frac{1}{2}$	$32\frac{1}{2} \times \frac{1}{2}$ $36\frac{1}{2} \times \frac{1}{2}$	B5	20.0	92.7	0.867																																																																																																																
28.05	$1\frac{1}{8}$	$\frac{1}{2}$	B4	15.0	90.0	0.619	$11\frac{1}{2} \times \frac{1}{2}$ $13\frac{1}{2} \times \frac{1}{2}$	$23\frac{1}{2} \times \frac{1}{2}$ $26\frac{1}{2} \times \frac{1}{2}$																																																																																																																																																																																																																																					
			B4	17.0	92.1	0.634			29.32	$1\frac{1}{8}$	$\frac{1}{2}$	B4	15.0	89.4	0.641	$11\frac{1}{2} \times \frac{1}{2}$ $13\frac{1}{2} \times \frac{1}{2}$	$23\frac{1}{2} \times \frac{1}{2}$ $26\frac{1}{2} \times \frac{1}{2}$	B4	17.0	91.2	0.656	30.60	$\frac{1}{2}$	$\frac{1}{2}$	B5	15.7	92.5	0.694	$11\frac{1}{2} \times \frac{1}{2}$ $13\frac{1}{2} \times \frac{1}{2}$	$23\frac{1}{2} \times \frac{1}{2}$ $26\frac{1}{2} \times \frac{1}{2}$	B5	18.3	93.3	0.700	31.87	$1\frac{1}{8}$	$\frac{1}{2}$	B5	15.1	92.0	0.718	$11\frac{1}{2} \times \frac{1}{2}$ $13\frac{1}{2} \times \frac{1}{2}$	$23\frac{1}{2} \times \frac{1}{2}$ $26\frac{1}{2} \times \frac{1}{2}$	B5	18.1	93.0	0.726	33.15	$1\frac{1}{8}$	$\frac{1}{2}$	B5	14.6	91.6	0.744	$11\frac{1}{2} \times \frac{1}{2}$ $13\frac{1}{2} \times \frac{1}{2}$	$23\frac{1}{2} \times \frac{1}{2}$ $26\frac{1}{2} \times \frac{1}{2}$	B5	18.0	92.8	0.754	34.42	$1\frac{1}{8}$	$\frac{1}{2}$	B5	14.1	91.1	0.767	$11\frac{1}{2} \times \frac{1}{2}$ $13\frac{1}{2} \times \frac{1}{2}$	$23\frac{1}{2} \times \frac{1}{2}$ $26\frac{1}{2} \times \frac{1}{2}$	B5	17.6	92.4	0.778	35.70	$\frac{1}{2}$	$\frac{1}{2}$	B5	13.7	90.7	0.798	$11\frac{1}{2} \times \frac{1}{2}$ $13\frac{1}{2} \times \frac{1}{2}$	$23\frac{1}{2} \times \frac{1}{2}$ $26\frac{1}{2} \times \frac{1}{2}$	B5	17.2	92.0	0.804	36.97	$1\frac{1}{8}$	$\frac{1}{2}$	B5	16.7	91.6	0.830	$13\frac{1}{2} \times \frac{1}{2}$ $15\frac{1}{2} \times \frac{1}{2}$	$32\frac{1}{2} \times \frac{1}{2}$ $36\frac{1}{2} \times \frac{1}{2}$	B5	20.5	93.0	0.843	38.25	$1\frac{1}{8}$	$\frac{1}{2}$	B5	16.2	91.2	0.855	$13\frac{1}{2} \times \frac{1}{2}$ $15\frac{1}{2} \times \frac{1}{2}$	$32\frac{1}{2} \times \frac{1}{2}$ $36\frac{1}{2} \times \frac{1}{2}$	B5	20.0	92.7	0.867																																																																																																																													
29.32	$1\frac{1}{8}$	$\frac{1}{2}$	B4	15.0	89.4	0.641	$11\frac{1}{2} \times \frac{1}{2}$ $13\frac{1}{2} \times \frac{1}{2}$	$23\frac{1}{2} \times \frac{1}{2}$ $26\frac{1}{2} \times \frac{1}{2}$																																																																																																																																																																																																																																					
			B4	17.0	91.2	0.656			30.60	$\frac{1}{2}$	$\frac{1}{2}$	B5	15.7	92.5	0.694	$11\frac{1}{2} \times \frac{1}{2}$ $13\frac{1}{2} \times \frac{1}{2}$	$23\frac{1}{2} \times \frac{1}{2}$ $26\frac{1}{2} \times \frac{1}{2}$	B5	18.3	93.3	0.700	31.87	$1\frac{1}{8}$	$\frac{1}{2}$	B5	15.1	92.0	0.718	$11\frac{1}{2} \times \frac{1}{2}$ $13\frac{1}{2} \times \frac{1}{2}$	$23\frac{1}{2} \times \frac{1}{2}$ $26\frac{1}{2} \times \frac{1}{2}$	B5	18.1	93.0	0.726	33.15	$1\frac{1}{8}$	$\frac{1}{2}$	B5	14.6	91.6	0.744	$11\frac{1}{2} \times \frac{1}{2}$ $13\frac{1}{2} \times \frac{1}{2}$	$23\frac{1}{2} \times \frac{1}{2}$ $26\frac{1}{2} \times \frac{1}{2}$	B5	18.0	92.8	0.754	34.42	$1\frac{1}{8}$	$\frac{1}{2}$	B5	14.1	91.1	0.767	$11\frac{1}{2} \times \frac{1}{2}$ $13\frac{1}{2} \times \frac{1}{2}$	$23\frac{1}{2} \times \frac{1}{2}$ $26\frac{1}{2} \times \frac{1}{2}$	B5	17.6	92.4	0.778	35.70	$\frac{1}{2}$	$\frac{1}{2}$	B5	13.7	90.7	0.798	$11\frac{1}{2} \times \frac{1}{2}$ $13\frac{1}{2} \times \frac{1}{2}$	$23\frac{1}{2} \times \frac{1}{2}$ $26\frac{1}{2} \times \frac{1}{2}$	B5	17.2	92.0	0.804	36.97	$1\frac{1}{8}$	$\frac{1}{2}$	B5	16.7	91.6	0.830	$13\frac{1}{2} \times \frac{1}{2}$ $15\frac{1}{2} \times \frac{1}{2}$	$32\frac{1}{2} \times \frac{1}{2}$ $36\frac{1}{2} \times \frac{1}{2}$	B5	20.5	93.0	0.843	38.25	$1\frac{1}{8}$	$\frac{1}{2}$	B5	16.2	91.2	0.855	$13\frac{1}{2} \times \frac{1}{2}$ $15\frac{1}{2} \times \frac{1}{2}$	$32\frac{1}{2} \times \frac{1}{2}$ $36\frac{1}{2} \times \frac{1}{2}$	B5	20.0	92.7	0.867																																																																																																																																										
30.60	$\frac{1}{2}$	$\frac{1}{2}$	B5	15.7	92.5	0.694	$11\frac{1}{2} \times \frac{1}{2}$ $13\frac{1}{2} \times \frac{1}{2}$	$23\frac{1}{2} \times \frac{1}{2}$ $26\frac{1}{2} \times \frac{1}{2}$																																																																																																																																																																																																																																					
			B5	18.3	93.3	0.700			31.87	$1\frac{1}{8}$	$\frac{1}{2}$	B5	15.1	92.0	0.718	$11\frac{1}{2} \times \frac{1}{2}$ $13\frac{1}{2} \times \frac{1}{2}$	$23\frac{1}{2} \times \frac{1}{2}$ $26\frac{1}{2} \times \frac{1}{2}$	B5	18.1	93.0	0.726	33.15	$1\frac{1}{8}$	$\frac{1}{2}$	B5	14.6	91.6	0.744	$11\frac{1}{2} \times \frac{1}{2}$ $13\frac{1}{2} \times \frac{1}{2}$	$23\frac{1}{2} \times \frac{1}{2}$ $26\frac{1}{2} \times \frac{1}{2}$	B5	18.0	92.8	0.754	34.42	$1\frac{1}{8}$	$\frac{1}{2}$	B5	14.1	91.1	0.767	$11\frac{1}{2} \times \frac{1}{2}$ $13\frac{1}{2} \times \frac{1}{2}$	$23\frac{1}{2} \times \frac{1}{2}$ $26\frac{1}{2} \times \frac{1}{2}$	B5	17.6	92.4	0.778	35.70	$\frac{1}{2}$	$\frac{1}{2}$	B5	13.7	90.7	0.798	$11\frac{1}{2} \times \frac{1}{2}$ $13\frac{1}{2} \times \frac{1}{2}$	$23\frac{1}{2} \times \frac{1}{2}$ $26\frac{1}{2} \times \frac{1}{2}$	B5	17.2	92.0	0.804	36.97	$1\frac{1}{8}$	$\frac{1}{2}$	B5	16.7	91.6	0.830	$13\frac{1}{2} \times \frac{1}{2}$ $15\frac{1}{2} \times \frac{1}{2}$	$32\frac{1}{2} \times \frac{1}{2}$ $36\frac{1}{2} \times \frac{1}{2}$	B5	20.5	93.0	0.843	38.25	$1\frac{1}{8}$	$\frac{1}{2}$	B5	16.2	91.2	0.855	$13\frac{1}{2} \times \frac{1}{2}$ $15\frac{1}{2} \times \frac{1}{2}$	$32\frac{1}{2} \times \frac{1}{2}$ $36\frac{1}{2} \times \frac{1}{2}$	B5	20.0	92.7	0.867																																																																																																																																																							
31.87	$1\frac{1}{8}$	$\frac{1}{2}$	B5	15.1	92.0	0.718	$11\frac{1}{2} \times \frac{1}{2}$ $13\frac{1}{2} \times \frac{1}{2}$	$23\frac{1}{2} \times \frac{1}{2}$ $26\frac{1}{2} \times \frac{1}{2}$																																																																																																																																																																																																																																					
			B5	18.1	93.0	0.726			33.15	$1\frac{1}{8}$	$\frac{1}{2}$	B5	14.6	91.6	0.744	$11\frac{1}{2} \times \frac{1}{2}$ $13\frac{1}{2} \times \frac{1}{2}$	$23\frac{1}{2} \times \frac{1}{2}$ $26\frac{1}{2} \times \frac{1}{2}$	B5	18.0	92.8	0.754	34.42	$1\frac{1}{8}$	$\frac{1}{2}$	B5	14.1	91.1	0.767	$11\frac{1}{2} \times \frac{1}{2}$ $13\frac{1}{2} \times \frac{1}{2}$	$23\frac{1}{2} \times \frac{1}{2}$ $26\frac{1}{2} \times \frac{1}{2}$	B5	17.6	92.4	0.778	35.70	$\frac{1}{2}$	$\frac{1}{2}$	B5	13.7	90.7	0.798	$11\frac{1}{2} \times \frac{1}{2}$ $13\frac{1}{2} \times \frac{1}{2}$	$23\frac{1}{2} \times \frac{1}{2}$ $26\frac{1}{2} \times \frac{1}{2}$	B5	17.2	92.0	0.804	36.97	$1\frac{1}{8}$	$\frac{1}{2}$	B5	16.7	91.6	0.830	$13\frac{1}{2} \times \frac{1}{2}$ $15\frac{1}{2} \times \frac{1}{2}$	$32\frac{1}{2} \times \frac{1}{2}$ $36\frac{1}{2} \times \frac{1}{2}$	B5	20.5	93.0	0.843	38.25	$1\frac{1}{8}$	$\frac{1}{2}$	B5	16.2	91.2	0.855	$13\frac{1}{2} \times \frac{1}{2}$ $15\frac{1}{2} \times \frac{1}{2}$	$32\frac{1}{2} \times \frac{1}{2}$ $36\frac{1}{2} \times \frac{1}{2}$	B5	20.0	92.7	0.867																																																																																																																																																																				
33.15	$1\frac{1}{8}$	$\frac{1}{2}$	B5	14.6	91.6	0.744	$11\frac{1}{2} \times \frac{1}{2}$ $13\frac{1}{2} \times \frac{1}{2}$	$23\frac{1}{2} \times \frac{1}{2}$ $26\frac{1}{2} \times \frac{1}{2}$																																																																																																																																																																																																																																					
			B5	18.0	92.8	0.754			34.42	$1\frac{1}{8}$	$\frac{1}{2}$	B5	14.1	91.1	0.767	$11\frac{1}{2} \times \frac{1}{2}$ $13\frac{1}{2} \times \frac{1}{2}$	$23\frac{1}{2} \times \frac{1}{2}$ $26\frac{1}{2} \times \frac{1}{2}$	B5	17.6	92.4	0.778	35.70	$\frac{1}{2}$	$\frac{1}{2}$	B5	13.7	90.7	0.798	$11\frac{1}{2} \times \frac{1}{2}$ $13\frac{1}{2} \times \frac{1}{2}$	$23\frac{1}{2} \times \frac{1}{2}$ $26\frac{1}{2} \times \frac{1}{2}$	B5	17.2	92.0	0.804	36.97	$1\frac{1}{8}$	$\frac{1}{2}$	B5	16.7	91.6	0.830	$13\frac{1}{2} \times \frac{1}{2}$ $15\frac{1}{2} \times \frac{1}{2}$	$32\frac{1}{2} \times \frac{1}{2}$ $36\frac{1}{2} \times \frac{1}{2}$	B5	20.5	93.0	0.843	38.25	$1\frac{1}{8}$	$\frac{1}{2}$	B5	16.2	91.2	0.855	$13\frac{1}{2} \times \frac{1}{2}$ $15\frac{1}{2} \times \frac{1}{2}$	$32\frac{1}{2} \times \frac{1}{2}$ $36\frac{1}{2} \times \frac{1}{2}$	B5	20.0	92.7	0.867																																																																																																																																																																																	
34.42	$1\frac{1}{8}$	$\frac{1}{2}$	B5	14.1	91.1	0.767	$11\frac{1}{2} \times \frac{1}{2}$ $13\frac{1}{2} \times \frac{1}{2}$	$23\frac{1}{2} \times \frac{1}{2}$ $26\frac{1}{2} \times \frac{1}{2}$																																																																																																																																																																																																																																					
			B5	17.6	92.4	0.778			35.70	$\frac{1}{2}$	$\frac{1}{2}$	B5	13.7	90.7	0.798	$11\frac{1}{2} \times \frac{1}{2}$ $13\frac{1}{2} \times \frac{1}{2}$	$23\frac{1}{2} \times \frac{1}{2}$ $26\frac{1}{2} \times \frac{1}{2}$	B5	17.2	92.0	0.804	36.97	$1\frac{1}{8}$	$\frac{1}{2}$	B5	16.7	91.6	0.830	$13\frac{1}{2} \times \frac{1}{2}$ $15\frac{1}{2} \times \frac{1}{2}$	$32\frac{1}{2} \times \frac{1}{2}$ $36\frac{1}{2} \times \frac{1}{2}$	B5	20.5	93.0	0.843	38.25	$1\frac{1}{8}$	$\frac{1}{2}$	B5	16.2	91.2	0.855	$13\frac{1}{2} \times \frac{1}{2}$ $15\frac{1}{2} \times \frac{1}{2}$	$32\frac{1}{2} \times \frac{1}{2}$ $36\frac{1}{2} \times \frac{1}{2}$	B5	20.0	92.7	0.867																																																																																																																																																																																														
35.70	$\frac{1}{2}$	$\frac{1}{2}$	B5	13.7	90.7	0.798	$11\frac{1}{2} \times \frac{1}{2}$ $13\frac{1}{2} \times \frac{1}{2}$	$23\frac{1}{2} \times \frac{1}{2}$ $26\frac{1}{2} \times \frac{1}{2}$																																																																																																																																																																																																																																					
			B5	17.2	92.0	0.804			36.97	$1\frac{1}{8}$	$\frac{1}{2}$	B5	16.7	91.6	0.830	$13\frac{1}{2} \times \frac{1}{2}$ $15\frac{1}{2} \times \frac{1}{2}$	$32\frac{1}{2} \times \frac{1}{2}$ $36\frac{1}{2} \times \frac{1}{2}$	B5	20.5	93.0	0.843	38.25	$1\frac{1}{8}$	$\frac{1}{2}$	B5	16.2	91.2	0.855	$13\frac{1}{2} \times \frac{1}{2}$ $15\frac{1}{2} \times \frac{1}{2}$	$32\frac{1}{2} \times \frac{1}{2}$ $36\frac{1}{2} \times \frac{1}{2}$	B5	20.0	92.7	0.867																																																																																																																																																																																																											
36.97	$1\frac{1}{8}$	$\frac{1}{2}$	B5	16.7	91.6	0.830	$13\frac{1}{2} \times \frac{1}{2}$ $15\frac{1}{2} \times \frac{1}{2}$	$32\frac{1}{2} \times \frac{1}{2}$ $36\frac{1}{2} \times \frac{1}{2}$																																																																																																																																																																																																																																					
			B5	20.5	93.0	0.843			38.25	$1\frac{1}{8}$	$\frac{1}{2}$	B5	16.2	91.2	0.855	$13\frac{1}{2} \times \frac{1}{2}$ $15\frac{1}{2} \times \frac{1}{2}$	$32\frac{1}{2} \times \frac{1}{2}$ $36\frac{1}{2} \times \frac{1}{2}$	B5	20.0	92.7	0.867																																																																																																																																																																																																																								
38.25	$1\frac{1}{8}$	$\frac{1}{2}$	B5	16.2	91.2	0.855	$13\frac{1}{2} \times \frac{1}{2}$ $15\frac{1}{2} \times \frac{1}{2}$	$32\frac{1}{2} \times \frac{1}{2}$ $36\frac{1}{2} \times \frac{1}{2}$																																																																																																																																																																																																																																					
			B5	20.0	92.7	0.867																																																																																																																																																																																																																																							

Plate		Diam- eter rivet (in.)	Type of joint	Pitch of rivets in outside row (in.)	Effi- ciency of joint (per cent)	Effective net thick- ness (in.)	Narrow butt strap (in.)	Wide butt strap (in.)
Weight lb. per sq. ft.	Thick- ness (in.)							
39.52	$1\frac{1}{8}$	1 $1\frac{1}{8}$	B5 B5	15.7 19.5	90.8 92.3	0.878 0.893	$13\frac{1}{2} \times \frac{3}{4}$ $15\frac{1}{2} \times \frac{3}{4}$	$32\frac{1}{2} \times 1\frac{1}{8}$ $36\frac{1}{2} \times 1\frac{1}{8}$
40.80	1	1 $1\frac{1}{8}$	B6 B6	15.6 19.4	93.2 94.0	0.922 0.940	$13\frac{1}{2} \times \frac{3}{4}$ $15\frac{1}{2} \times \frac{3}{4}$	$38 \times \frac{3}{8}$ $43\frac{1}{2} \times \frac{3}{8}$
42.07	$1\frac{1}{8}$	1 $1\frac{1}{8}$	B6 B6	15.2 18.9	93.0 93.8	0.920 0.928	$13\frac{1}{2} \times \frac{3}{4}$ $15\frac{1}{2} \times \frac{3}{4}$	$38 \times \frac{3}{8}$ $43\frac{1}{2} \times \frac{3}{8}$
43.35	$1\frac{1}{8}$	1 $1\frac{1}{8}$	B6 B6	14.8 18.4	92.8 93.6	0.920 0.928	$13\frac{1}{2} \times \frac{3}{4}$ $15\frac{1}{2} \times \frac{3}{4}$	$38 \times 1\frac{1}{8}$ $43\frac{1}{2} \times 1\frac{1}{8}$
44.62	$1\frac{1}{8}$	1 $1\frac{1}{8}$	B6 B6	14.4 17.9	92.4 93.4	1.010 1.018	$13\frac{1}{2} \times \frac{3}{4}$ $15\frac{1}{2} \times \frac{3}{4}$	$38 \times 1\frac{1}{8}$ $43\frac{1}{2} \times 1\frac{1}{8}$
45.90	$1\frac{1}{8}$	1 $1\frac{1}{8}$	B6 B6	14.0 17.4	92.5 93.2	1.040 1.047	$13\frac{1}{2} \times \frac{3}{4}$ $15\frac{1}{2} \times \frac{3}{4}$	38×1 $43\frac{1}{2} \times 1$
47.17	$1\frac{1}{8}$	1 $1\frac{1}{8}$	B6 B6	13.6 17.0	92.2 93.0	1.064 1.072	$13\frac{1}{2} \times \frac{3}{4}$ $15\frac{1}{2} \times \frac{3}{4}$	38×1 $43\frac{1}{2} \times 1$
48.45	$1\frac{1}{8}$	1 $1\frac{1}{8}$	B6 B6	13.3 16.6	92.0 92.9	1.090 1.100	$13\frac{1}{2} \times \frac{3}{4}$ $15\frac{1}{2} \times \frac{3}{4}$	$38 \times 1\frac{1}{8}$ $43\frac{1}{2} \times 1\frac{1}{8}$
49.72	$1\frac{1}{8}$	1 $1\frac{1}{8}$	B6 B6	13.0 16.2	91.8 92.7	1.118 1.128	$13\frac{1}{2} \times \frac{3}{4}$ $15\frac{1}{2} \times \frac{3}{4}$	$38 \times 1\frac{1}{8}$ $43\frac{1}{2} \times 1\frac{1}{8}$
51.00	$1\frac{1}{8}$	1 $1\frac{1}{8}$	B6 B6	12.7 15.8	91.6 92.5	1.145 1.156	$13\frac{1}{2} \times \frac{3}{4}$ $15\frac{1}{2} \times \frac{3}{4}$	$38 \times 1\frac{1}{8}$ $43\frac{1}{2} \times 1\frac{1}{8}$
52.27	$1\frac{1}{8}$	1 $1\frac{1}{8}$	B6 B6	12.4 15.4	91.4 92.3	1.171 1.182	$13\frac{1}{2} \times 1\frac{1}{8}$ $15\frac{1}{2} \times 1\frac{1}{8}$	$38 \times 1\frac{1}{8}$ $43\frac{1}{2} \times 1\frac{1}{8}$
53.55	$1\frac{1}{8}$	$1\frac{1}{8}$ $1\frac{1}{4}$	B6 B6	15.1 18.1	92.1 92.8	1.210 1.216	$15\frac{1}{2} \times 1\frac{1}{8}$ $16\frac{1}{2} \times 1\frac{1}{8}$	$43\frac{1}{2} \times 1\frac{1}{8}$ $46\frac{1}{2} \times 1\frac{1}{8}$
54.82	$1\frac{1}{8}$	$1\frac{1}{8}$ $1\frac{1}{4}$	B6 B6	14.8 17.8	91.9 92.7	1.222 1.245	$15\frac{1}{2} \times 1\frac{1}{8}$ $16\frac{1}{2} \times 1\frac{1}{8}$	$43\frac{1}{2} \times 1\frac{1}{8}$ $46\frac{1}{2} \times 1\frac{1}{8}$
56.10	$1\frac{1}{8}$	$1\frac{1}{8}$ $1\frac{1}{4}$	B6 B6	14.5 17.6	91.8 92.6	1.262 1.272	$15\frac{1}{2} \times \frac{3}{4}$ $16\frac{1}{2} \times \frac{3}{4}$	$43\frac{1}{2} \times 1\frac{1}{4}$ $46\frac{1}{2} \times 1\frac{1}{4}$
57.37	$1\frac{1}{8}$	$1\frac{1}{8}$ $1\frac{1}{4}$	B6 B6	14.2 17.2	91.6 92.5	1.286 1.296	$15\frac{1}{2} \times \frac{3}{4}$ $16\frac{1}{2} \times \frac{3}{4}$	$43\frac{1}{2} \times 1\frac{1}{4}$ $46\frac{1}{2} \times 1\frac{1}{4}$
58.65	$1\frac{1}{8}$	$1\frac{1}{8}$ $1\frac{1}{4}$	B6 B6	14.0 16.8	91.4 92.4	1.310 1.326	$15\frac{1}{2} \times \frac{3}{4}$ $16\frac{1}{2} \times \frac{3}{4}$	$43\frac{1}{2} \times 1\frac{5}{8}$ $46\frac{1}{2} \times 1\frac{5}{8}$
59.92	$1\frac{1}{8}$	$1\frac{1}{8}$ $1\frac{1}{4}$	B6 B6	13.7 16.5	91.2 92.2	1.325 1.350	$15\frac{1}{2} \times \frac{3}{4}$ $16\frac{1}{2} \times \frac{3}{4}$	$43\frac{1}{2} \times 1\frac{5}{8}$ $46\frac{1}{2} \times 1\frac{5}{8}$
61.20	$1\frac{1}{8}$	$1\frac{1}{8}$ $1\frac{1}{4}$	B6 B6	13.4 16.2	91.0 92.0	1.365 1.380	$15\frac{1}{2} \times 1\frac{3}{8}$ $16\frac{1}{2} \times 1\frac{3}{8}$	$43\frac{1}{2} \times 1\frac{3}{8}$ $46\frac{1}{2} \times 1\frac{3}{8}$

NOTE.—Nomenclature of column headings is same as shown for lap joint tables.

TABLE 3.—TOWER AND TANK-STRESSES

Shape	Stress		Compression
	Joint cut by vertical plane	Joint cut by horizontal plane	Balcony line
Hemispherical....	$1.3 \times H \times D'$	$\frac{W}{37.7 \times D} \times \sec \theta$	0
Segmental.....	$1.3 \times H \times D'$	$\frac{W}{37.7 \times D} \times \sec \theta$	$0.158 \times W \times \tan \theta$
Elliptical.....	$\frac{W \times \sec^2 \theta}{2 \times \pi \times R} - 2.6 \times H \times D \times \sec \theta$	$\frac{W}{37.7 \times D} \times \sec \theta$	see below
Conical.....	$2.6 \times H \times D \times \sec \theta$	$\frac{W}{37.7 \times D} \times \sec \theta$	$0.158 \times W \times \tan \theta$
Any curved shape.	$\frac{W \times \sec^2 \theta}{2 \times \pi \times R} - 2.6 \times H \times D \times \sec \theta$	$\frac{W}{37.7 \times D} \times \sec \theta$	$0.158 \times W \times \tan \theta$

H = Head in feet on section considered.

D' = Diameter in feet of tank cylinder.

D = Horizontal diameter in feet of section considered.

W = Weight in pounds of water and metal supported by the bottom below section considered.

θ = Angle tangent to bottom at point considered makes with vertical.

R = Radius of curvature in vertical plane expressed in inches. Most elliptical bottom tanks have small *R* from .333 to .375 the radius of the cylindrical portion of the tank and the large *R* from 1.75 to 2.00 times the tank radius.

NOTE.—That the formula for joint cut by a vertical plane through an elliptical bottom tank shows compression when the first term is larger and tension when the second term is larger. This compression in tanks of over 300,000 gallons capacity is too great to be taken care of by a reasonable plate thickness at the allowable unit stress. In such event the excess stress can be taken care of by a balcony girder.

WIND-STRESSES—POSTS VERTICAL

No. posts	<i>P</i> = posts	Rods	Struts	Standard (uplifts)	A.F.M.I.Co.
3	$M + 0.75D$	$0.500 (P - P') \sec \alpha$	$1.15W + E \sin \alpha$	$1.000 P - S + 3$	$P - S + 3$
4	$M + 1.0D$	$0.707 (P - P') \sec \alpha$	$W + E \sin \alpha$	$0.707 P - S + 4$	$P - S + 4$
6	$M + 1.5D$	$1.000 (P - P') \sec \alpha$	$W + E \sin \alpha$	$0.692 P - S + 5$	$P - S + 6$
8	$M + 2.0D$	$1.307 (P - P') \sec \alpha$	$W + E \sin \alpha$	$0.682 P - S + 6.35$	$P - S + 8$
10	$M + 2.5 D$	$1.618 (P - P') \sec \alpha$	$W + E \sin \alpha$	$0.678 P - S + 7.75$	$P - S + 10$

WIND-STRESSES—POSTS INCLINED

No. posts	$P =$ posts	Rods	Struts	Uplifts	Uplifts
3	$M \times \sec \phi + 0.75D$	$0.500(V - V') \sec \alpha$	$1.15W + R \cos \theta - 0.575(P - P') \sin \phi$	$1.000V - S + 3$	$V - S + 3$
4	$M \times \sec \phi + 1.00D$	$0.707(V - V') \sec \alpha$	$W + R \cos \theta - 0.500(P - P') \sin \phi$	$0.707V - S + 4$	$V - S + 4$
6	$M \times \sec \phi + 1.50D$	$1.000(V - V') \sec \alpha$	$W + R \cos \theta - 0.500(P - P') \sin \phi$	$0.692V - S + 5$	$V - S + 6$
8	$M \times \sec \phi + 2.00D$	$1.307(V - V') \sec \alpha$	$W + R \cos \theta - 0.500(P - P') \sin \phi$	$0.682V - S + 6.35$	$V - S + 8$
10	$M \times \sec \phi + 2.50D$	$1.618(V - V') \sec \alpha$	$W + R \cos \theta - 0.500(P - P') \sin \phi$	$0.678V - S + 7.75$	$V - S + 10$

- M = Moment of wind at bottom panel considered.
- D = Diameter of post circle in plane considered.
- S = Weight of steel above section considered.
- W = Total wind panel load + number of posts.
- P = Compression in leeward post.
- P' = Tension in windward post = pin panel next above.
- V = Vertical component of post stress P .
- V' = Vertical component of post stress P' .
- R = Rod stress in panel above strut.
- α = Angle rod makes with vertical.
- θ = Angle strut makes with rod in panel above.
- ϕ = Angle post makes with vertical.

$$\left\{ \begin{array}{l} \text{Bevel} - (1\frac{1}{4} - 12) - (1 - 12) \\ \text{Sec } \phi - 1.008 - 1.003 \\ \text{Sin } \phi - 1.115 - 0.083 \end{array} \right.$$

BALCONY STRESS

No. posts	Bending moment		Shear		Compression	
	Under load	Midway between loads	Under load	Midway between loads	Under load	Midway between loads
4	+0.068QB	-0.0352QB	0.50Q	0	0.50Q	0.707Q
6	+0.045QB	-0.0225QB	0.50Q	0	0.87Q	1.00Q
8	+0.034QB	-0.0165QB	0.50Q	0	1.21Q	1.31Q
10	+0.027QB	-0.0138QB	0.50Q	0		
12	+0.022QB	-0.011 QB	0.50Q	0	1.87Q	1.93Q

- Q = Horizontal thrust at top each post.
- B = Diameter to center balcony girder.

STRESSES IN THE CIRCULAR GIRDER

	Number of posts	Maximum shear	Moment at posts	Moment midway	Torsion
19°-12'	4	$\frac{W}{8}$	$-0.03415Wr$	$+0.0176 Wr$	$0.0053 Wr$
12°-44'	6	$\frac{W}{12}$	$-0.01482Wr$	$+0.0075 Wr$	$0.00151Wr$
9°-33'	8	$\frac{W}{16}$	$-0.00827Wr$	$+0.00416Wr$	$0.00063Wr$
6°-21'	12	$\frac{W}{24}$	$-0.00365Wr$	$+0.00190Wr$	$0.000185Wr$

W = Total load.

r = Radius in feet.

M = Moment in ft.-lb.

SECTION 6

CHIMNEYS

DRAFT AND SIZE OF CHIMNEY

1. General.—Before designing a large chimney it is necessary to decide on the proper height and diameter. The height must be such as will give the draft required and the cross-sectional area must be large enough to permit the passage of the burnt gases.

The draft depends on the height of the chimney, the temperature of the gases, the altitude or elevation of the chimney above sea level, the nature of the fuel, the furnace used, and the design and arrangement of the various flues connecting the furnace with the chimney. The cross-sectional area depends on the kind and quantity of fuel to be burned in the plant, the draft available for carrying the burnt gases up the chimney, and the friction losses within the stack.

It is obviously impractical (if not impossible) to produce any single formula for determining stack sizes which will satisfactorily take all of the various factors into consideration and, consequently, the formulas used in selecting stack sizes are largely empirical.

2. Draft Theory.—Draft may be defined as the difference in pressure available for producing a flow of gases. If the gases in a chimney are heated, they will expand and occupy a larger volume than before, and their weight per cubic foot will be less. Consequently, the unit pressure at the bottom of a chimney due to the column of heated gases will be less than the unit pressure exerted by a column of cold air outside the chimney. The difference between these two pressures will cause a flow of the gases up the stack. In an ordinary plant, the cold air comes in through the furnaces and becomes heated before it arrives in the chimney thus maintaining a column of heated gases in the chimney and causing a continuous movement of the gases up the chimney as long as the furnaces are in operation.

The intensity of the draft is usually measured in inches of water instead of pounds per square inch or pounds per square foot. The pressure of an inch of water is equal to a pressure of 5.193 lb. per sq. ft., assuming the water to weigh 62.32 lb. per cu. ft.

The intensity of the draft is given by the following formula. No allowance is made for the difference in density between the air and flue gases.

$$D = 0.52 PH \left(\frac{1}{t} - \frac{1}{t_1} \right).$$

where

D = theoretical draft in inches of water.

P = atmospheric pressure in pounds per square inch or 14.7 lb. per sq. in. at sea level.

H = height of chimney above grates in feet.

t = absolute temperature of atmosphere in degrees Fahr.

t_1 = absolute temperature of gases in chimney in degrees Fahr.

To obtain the absolute temperature in degrees Fahr., add 461 to the common or ordinary temperature in degrees Fahr.

Taking P as 14.7 lb. per sq. in. and 60 deg. Fahr. as the average atmospheric temperature, the formula becomes

$$D = 0.52 \times 14.7 \left(\frac{1}{521} - \frac{1}{t_1} \right) H$$

Let

$$K = 0.52 \times 14.7 \left(\frac{1}{521} - \frac{1}{t_1} \right)$$

Then

$$D = KH$$

K will vary according to the temperature of the gases in the chimney as shown in the following table:

TABLE 1

Temperatures of chimney gases in deg. Fahr. . . .	350	400	450	500	550	600	650	700	750
Values of K	0.0053	0.0058	0.0063	0.0067	0.0071	0.0075	0.0078	0.0081	0.0084

Illustrative Problem.—Find the theoretical draft for a chimney 200 ft. high above grates and located at sea level when the temperature of the flue gases is 600 deg. Fahr.

$K = 0.0075$ from Table 1.

$H = 200$ ft.

$D = (0.0075)(200) = 1.50$ in. of water.

3. Draft Losses.—In the ordinary power plant there are various draft losses due to possible leakage and to resistances offered to the passage of the gases by the furnace, boiler, flues, and interior of the chimney. Sometimes the loss due to leakage around boiler sections and flue joints is considerable.

The draft loss in the furnace will vary considerably depending on the kind and size of coal and the rate of combustion. This will be discussed in more detail in a later paragraph.

The draft loss caused by the boiler heating surface will vary largely according to the design of the boiler and the percentage of its capacity at which it is being operated. In a good Babcock & Wilcox boiler this loss may be about 0.25 in. at rated capacity, 0.40 in. at 50 per cent overload, and as much as 0.65 in. at 100 per cent overload. At rated capacity, the draft loss between grates and damper for a good horizontal return tubular boiler will be about 0.25 in. of water (practi-

cally the same as for a Babcock & Wilcox boiler); about 0.50 in. for a Stirling boiler; and about 0.40 in. for a vertical tubular boiler.

The use of economizers in connection with boilers, will cause a reduction of about 75 deg. Fahr. or more in the flue gas temperatures. The loss of draft through the economizers will amount to about 0.3 in. of water. The installation of economizers frequently requires the use of a fan for increasing the draft.

The draft loss in straight round flues may be computed by the formula given later for the friction loss in chimneys. The loss in square or rectangular flues will be about 12 per cent more than that in round flues. Abrupt turns should be avoided as a short right-angled turn will reduce the draft by approximately 0.05 in. for each turn. In designing, ample flue areas should be provided, say approximately a cross-sectional area of 35 sq. ft. for each 1,000 rated boiler horsepower. In computing flue losses in round steel flues, approximately 0.10 in. should be allowed for each 100 ft. of flue length and 0.05 in. for each right-angled turn including the turns from boiler to flue and from flue to chimney. These figures should be doubled for brick or concrete flues.

The loss in the chimney may be computed from the following formula:

$$d = \frac{fW^2CH}{A^3}$$

where

d = loss of draft in inches of water.

W = weight of gases in pounds passing per second.

C = circumference of chimney in feet.

H = height of chimney in feet.

A = area of passage in chimney in square feet.

f = a sea level value depending on the temperature of the gases and the interior surface of the chimneys, as given by the following table:

TABLE 2

<i>f</i>	Temperature of gases, deg. Fahr.	Interior surface of chimney
0.0011	350	steel
0.0015	600	steel
0.0015	350	brick
0.0020	600	brick

4. Available Draft.—The available draft (*D*₁) in a chimney is equal to the theoretical draft (*D*) minus the frictional loss (*d*). Expressed as a formula and substituting values for *D* and *d*

$$D_1 = D - d = KH - \frac{fW^2CH}{A}$$

The following table shows the available draft at the base that a steel chimney 100 ft. high will produce when connected to boilers of various horsepowers.

TABLE 3.—AVAILABLE DRAFT FOR 100-FT. STEEL CHIMNEYS OF VARIOUS DIAMETERS
(Based on a chimney temperature of 500 deg. Fahr. and 100 lb. of gas per horsepower)

Horse- power	Diameter of chimney in inches														
	36	42	48	54	60	66	72	78	84	90	96	108	120	132	144
	Available draft in inches of water														
100	0.64														
200	0.55	0.62													
300	0.41	0.55	0.61												
400	0.21	0.46	0.56	0.61											
500	0.34	0.50	0.57	0.61										
600	0.19	0.42	0.53	0.59	0.62									
800	0.23	0.43	0.52	0.58	0.61	0.63							
1,000	0.29	0.45	0.53	0.58	0.61	0.63	0.64					
1,200	0.35	0.47	0.54	0.58	0.61	0.63	0.64				
1,400	0.40	0.49	0.55	0.59	0.61	0.63	0.65			
1,600	0.31	0.43	0.52	0.56	0.59	0.62	0.64	0.65		
1,800	0.37	0.47	0.54	0.57	0.60	0.63	0.65		
2,000	0.31	0.43	0.50	0.55	0.59	0.62	0.64	0.65	
2,200	0.38	0.47	0.53	0.57	0.61	0.64	0.65	
2,400	0.32	0.43	0.50	0.55	0.60	0.63	0.65	
2,600	0.39	0.47	0.53	0.59	0.62	0.64	0.65
2,800	0.44	0.50	0.58	0.61	0.64	0.65
3,000	0.40	0.48	0.56	0.61	0.63	0.64
3,200	0.45	0.55	0.60	0.63	0.64
3,400	0.42	0.53	0.59	0.62	0.64
3,600	0.52	0.58	0.61	0.63
4,000	0.48	0.56	0.60	0.62
4,500	0.43	0.53	0.58	0.61
5,000	0.49	0.56	0.60

NOTE.—For other chimney temperatures add or deduct, before multiplying by height and dividing by 100, as follows:

For 350 deg. Fahr. deduct 0.14 in.
 For 400 deg. Fahr. deduct 0.09 in.
 For 450 deg. Fahr. deduct 0.04 in.
 For 550 deg. Fahr. add 0.04 in.

For 600 deg. Fahr. add 0.08 in.
 For 650 deg. Fahr. add 0.11 in.
 For 700 deg. Fahr. add 0.14 in.
 For 750 deg. Fahr. add 0.17 in.

Illustrative Problem.—What is the available draft produced by a steel chimney 72 in. in diameter and 120 ft. high serving boilers of 1,700 rated horsepower, the temperature of the chimney gases being assumed as 650 deg. Fahr.?

From Table 3, a steel chimney 100 ft. high and 72 in. in diameter serving boilers of 1,700 rated horsepower would have an available draft of 0.40 in., of water (by interpolation).

For a temperature of 650 deg. Fahr., add 0.11 in. This gives 0.51 in. of water.

To obtain the available draft for a chimney 120 ft. high, multiply 0.51 by 120 and divide by 100. This gives an available draft of 0.612 in. of water.

Wm. Kent, in computing required diameters of chimneys, assumes that the friction effect is equal to a layer of gas 2 in. thick around the perimeter—that is, the diameter is increased by 4 in. to offset frictional losses in the chimney.

In general, the available draft in a chimney must be equivalent to the sum of the draft losses in furnace, boiler, and flue.

5. Rates of Combustion and Draft Requirements for Different Coal Fuels.—

The rate of combustion or the amount of coal burned per hour per square foot of grate surface depends upon the fuel burned and the draft available. The efficiency will vary little for different rates of combustion (within reasonable limits) if the boiler and grates are correctly proportioned. The greater the draft, the greater the amount of fuel that can be burned in a given time on a given grate.

It has been found by numerous tests and experiments that, for any particular fuel and rate of combustion, there is a certain draft which will give the best results. In general a light draft is better for free burning bituminous coals. More draft is required for coals having higher amounts of fixed carbon or lesser amounts of volatile matter. Hence, a small sized anthracite coal would require a comparatively large draft. Of course, such things as percentage of ash, percentage of air space in grates, and thickness of fire also affect the draft required.

The following table is compiled from data given by the Babcock and Wilcox Company. It is practically impossible to show by a table or set of curves the exact draft required for various kinds of fuel under different rates of combustion and different grate and firing conditions. Consequently, the values in the table are more or less approximate.

TABLE 4.—DRAFT REQUIRED FOR VARIOUS KINDS OF COAL AT DIFFERENT COMBUSTION RATES

Force of Draft between Furnace and Ash Pit in Inches of Water

Kind of coal	Pounds of coal burned per hr. per sq. ft. of grate surface							
	10	15	20	25	30	35	40	45
	Draft in inches of water							
No. 3 anthracite buck-wheat.....	0.40	0.75	1.23					
No. 1 anthracite buck-wheat.....	0.24	0.44	0.68	1.00	1.52			
Anthracite pea.....	0.17	0.30	0.45	0.64	0.89	1.23		
Md., Pa., Va., and W. Va. semi-bituminous.....	0.11	0.18	0.26	0.35	0.46	0.57	0.71	0.87
Ala., Ky., Pa., and Tenn. bituminous.....	0.10	0.16	0.23	0.31	0.40	0.49	0.60	0.72
Ill., Ind., and Kan. bituminous.....	0.09	0.14	0.20	0.26	0.33	0.40	0.48	0.57

6. Correction of Chimney Sizes for Altitude.—As the altitude increases, the density or weight per unit volume of the air decreases. Consequently, as a certain weight of air for combustion is required per boiler horsepower, a larger volume of air will be required to produce the same results at higher altitudes than at sea level. "If the areas of the boiler grates and flues are not changed, then the air at higher altitudes must pass through these grates and flues at a greater velocity in order to obtain the increase in volume required. This means that the draft must be greater than at sea level and, consequently, the chimney must be increased in height to obtain this increase in draft. For any given boiler horsepower and constant weight of gases, the mean velocity of the gases will be inversely proportional to the barometric pressure and the velocity head (or pressure), measured in column of external air, will be inversely proportional to the square of the barometric pressure. That means that the height at sea level must be multiplied by the square of the ratio of the barometer reading at sea level to that at the altitude given.

Frequently in designing a boiler for higher altitudes, the assumption is made that a certain fuel will require the same draft (measured in inches of water at the boiler damper) as at sea level. This means that the chimney height at sea level must be multiplied by the ratio of the barometer reading at sea level to that at the given altitude, and not according to the square of this ratio, in order to obtain the height necessary to give the required draft.

The Babcock and Wilcox Co. says that the correct height probably falls between the values given by these two theories, as the flues are usually made larger for the boilers to be used in higher altitudes. Further, that in making capacity tests with coal fuel, no difference has been noted in the rates of combustion for a given draft suction, measured by a water column, at high and low altitudes. This indicates that the height of chimney at sea level should be multiplied by the direct ratio rather than the square of the ratio. Also if the direct ratio is used, the difference in capacity would not be more than 10 per cent at an altitude of 10,000 ft., assuming that the correct height lies between the values found by the two theories.

If the height of a chimney is increased, the friction loss in the chimney is increased by this added height. Consequently the diameter of the chimney must be increased to offset this added friction loss. This increase in diameter, in order to keep the total friction loss the same, is inversely as the two-fifths power of the barometric pressure. Hence, the diameter at sea level should be multiplied by the two-fifths power of the ratio of the sea level barometer reading to that at the given altitude.

The following table gives the altitude correction factors for chimney capacities. It is seen that altitude affects the height more than the diameter and that practically no increases in diameter are needed for altitudes less than about 3,000 ft. For very high altitudes, the increase in chimney height would increase the cost very greatly and also make the proportions of height to diameter impractical. In such cases it is better to increase the grate areas so that the required rate of combustion and the accompanying required draft will be lessened so that a shorter chimney will be satisfactory.

TABLE 5.—ALTITUDE CORRECTION FACTORS FOR CHIMNEYS

Altitude in feet above sea level	Normal barometer	R	$(R)^2$ Height factor	$(R)^{3/4}$ Diameter factor
0	30.00	1.000	1.000	1.000
1,000	28.88	1.039	1.079	1.015
2,000	27.80	1.079	1.164	1.030
3,000	26.76	1.121	1.257	1.047
4,000	25.76	1.165	1.356	1.063
5,000	24.79	1.210	1.464	1.079
6,000	23.87	1.257	1.580	1.096
7,000	22.97	1.306	1.706	1.113
8,000	22.11	1.357	1.841	1.130
9,000	21.28	1.410	1.988	1.147
10,000	20.49	1.464	2.144	1.165

$$R = \frac{\text{Sea level barometer reading}}{\text{Altitude barometer reading}}$$

To obtain correct height of chimney at any altitude, multiply height at sea level by height factor, R^2 , for the altitude selected.

To obtain correct diameter of chimney at any altitude, multiply diameter at sea level by diameter factor, $(R)^{3/4}$, for the altitude selected.

Illustrative Problem.—A chimney designed for sea level conditions has a diameter of 72 in. and a height of 175 ft. Find the correct diameter and height for a chimney which is to have the same capacity and is to be built at an altitude of 4,500 ft. above sea level.

Interpolating between diameter factors given for 4,000 and 5,000 ft., the diameter factor for 4,500 ft. is 1.071.

$$\text{Required diameter} = (1.071)(72) = 77.11 \text{ in.}$$

Interpolating between height factors given for 4,000 and 5,000 ft., the height factor for 4,500 ft. is 1.410.

$$\text{Required height} = (1.410)(175) = 246.75 \text{ ft.}$$

7. Formulas for Height and Diameter of Chimneys.—From the formula given in the article on Available Draft (Art. 4) it is evident that if a chimney of a certain diameter was increased in height, it would give the same available draft as one of larger diameter. Thus, various chimneys could be selected which would give the same results. However, in studying the relation of costs to heights and diameters, it has been found that the chimney of minimum cost will have a diameter dependent on the boiler horsepower served and a height dependent on the available draft required.

Assuming 120 lb. of flue gas per hr. per boiler hp., which is the same as a consumption of 5 lb. of coal per hp. per hr. allowing 24 lb. of gas for 1 lb. of coal, and which provides for ordinary overloads and the use of poor coal, this method gives the following formulas for sea level conditions:

For an unlined steel stack

$$\text{Diameter in inches} = 4.68 (\text{hp.})^{3/4}$$

For a stack lined with masonry

$$\text{Diameter in inches} = 4.92 (\text{hp.})^{3/4}$$

where

hp. = the rated horsepower of the connected boilers. Values calculated from these two formulas have been plotted in the two curves shown in Fig. 1A, so as to facilitate the finding of the chimney diameter at sea level required to serve a certain boiler horsepower.

The diameter from the curves must be corrected for altitude according to the method explained in the article on Altitude Corrections (Art. 6).

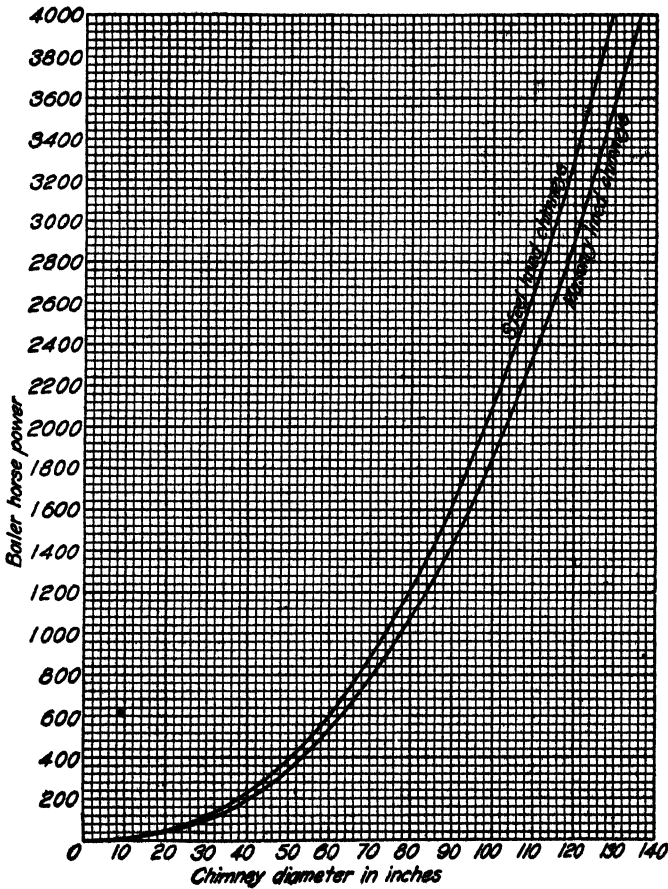

FIG. 1A.—Curves showing relation between chimney diameters and boiler horsepower served.

When a large chimney serves a number of boilers equipped with mechanical stokers, the area calculated by these formulas should be increased by about 33¼ per cent to allow for leakage of air through the settings of idle boilers and for irregular operating conditions.

Chimneys, whose diameters are found by the above two formulas, will give an available draft which bears a constant ratio to the theoretical draft. This ratio, allowing for the cooling of the gases in their passage up the chimney, is about 0.8.

Then the formula for the required height becomes

$$H = \frac{D_1}{0.8K}$$

where

H = required height of chimney in feet above level of grates.

D_1 = available draft required in inches of water.

K = the value given in the formula $D = KH$ in the article on Draft Theory (Art. 2).

The three preceding formulas for diameter and height of chimneys are those used by the Babcock and Wilcox Co.

This company states that a convenient rule for large chimneys, 200 ft. high or over, is to provide 30 sq. ft. of cross-sectional area per 1,000 rated hp.

Kent's formula for chimney sizes is

$$\text{hp.} = 3.33(A - 0.6A^{1/2})H^{1/2}$$

where

hp. = rated boiler horsepower based on a coal consumption of 5 lb. per hr. per rated boiler hp.

A = Area of chimney in square feet.

H = height of chimney in feet.

$A - 0.6A^{1/2}$ = effective area of chimney assuming that the frictional resistance in the chimney is equivalent to a layer of gas 2 in. thick around the inside circumference.

The Babcock and Wilcox Co. strongly recommend that the sizes given by Kent's formula be increased from 25 to 60 per cent for the low grade bituminous coals of the Middle or Western states depending on the nature of the coal and the capacity desired.

Christie's formula for chimney sizes is

$$\text{hp.} = 3.25A\sqrt{H}$$

where

hp. = rated boiler horsepower based on 4 lb. of coal burned per hp. per hr.

A = cross-sectional area of chimney in square feet.

H = height of chimney in feet.

The M. W. Kellogg Co. recommends that, for the Middle States and Western bituminous coal, the height as determined by Christie's formula be unchanged and that the areas be increased 25 per cent. Temperatures, flues, type of boilers, economizers, and other accessories may have a great influence on the proper size.

Illustrative Problem.—Determine the proper height and diameter of a brick chimney to serve Babcock and Wilcox boilers rated at 2,000 hp. under the following conditions:

Boilers to operate at 50 per cent overload.

Altitude = 1,500 ft. above sea level.

Atmospheric temperature = 60 deg. Fahr.

Flue gas temperature = 500 deg. Fahr.

Grate surface = 400 sq. ft.

Combustion rate = 35 lb. per hr. per sq. ft. of grate surface.

Length of flues = 150 ft. with two right-angle turns.

Kind of flues = round steel.

Kind of coal = Illinois bituminous.

The available draft required at the base of the stack will equal the sum of the draft losses in the furnace, boiler, and flues.

Draft required in furnace for combustion of this coal at this rate (see Table 4) = 0.40 in.

Boiler losses at 50 per cent overload = 0.40 in.

Flue losses = $(0.10) \left(\frac{150}{100} \right) + (2) (0.05)$ = 0.25 in.

Available draft required = D_1 = 1.05 in.

Substituting in formula $H = \frac{D_1}{0.8K}$

($K = 0.0067$ for 500 deg. Fahr. — see Table 1)

$$H = \frac{1.05}{(0.8)(0.0067)} = 196 \text{ ft.}$$

Altitude correction factor for height for an altitude of 1,500 ft. is 1.122 by interpolation in Table 5.

Required height = $(1.122) (196) = 220$ ft.

Diameter of a brick chimney to serve 2,000 rated boiler hp. from curve in Fig. 1 is 103 in.

Altitude correction factor for diameter for an altitude of 1,500 ft. is 1.023 by interpolation in Table 5.

Required diameter = $(1.023) (103) = 105$ in.

8. Chimneys for Oil Fuels.—The requirements for chimney sizes when oil fuel is used are quite different than when coal is burned, because some of the boiler losses are eliminated and the volume and temperature of the gas entering the chimney is less than with coal. This means that the cross-sectional area required for oil fuel is much less than that required for coal, as the volume of gas in the case of oil may be taken as approximately 60 per cent of that for coal. Also, as the draft requirements are less, the height of chimney required for oil fuel is less than that for coal.

In designing chimneys for oil fuel, care must be taken not to have an excess of draft, as the admission of too much air reduces the efficiency fairly rapidly. If the stack is too high, some form of automatic control will give better results than ordinary hand control. This is especially true in the case of varying loads. Too little draft is also bad because if the draft is not enough to carry off the hot burnt gases, the action of the heat on the brick work of the furnace will be very injurious. Consequently, great care should be used in designing chimneys where oil fuel is to be used.

The following table is taken from one calculated by C. R. Weymouth from actual test data. This table will ordinarily give satisfactory results.

TABLE 6.—CHIMNEY SIZES FOR OIL FUEL

Diameter, inches	Height in feet above boiler room floor					
	80	90	100	120	140	160
Nominal rated hour power						
33	161	206	233	270	306	315
36	208	253	295	331	363	387
39	251	303	343	399	458	467
42	295	359	403	474	521	557
48	399	486	551	645	713	760
54	519	634	720	847	933	1,000
60	657	800	913	1,073	1,193	1,280
66	813	993	1,133	1,333	1,480	1,593
72	980	1,206	1,373	1,620	1,807	1,940
84	1,373	1,587	1,933	2,293	2,560	2,767
96	1,833	2,260	2,587	3,087	3,453	3,740
108	2,367	2,920	3,347	4,000	4,483	4,867
120	3,060	3,660	4,207	5,040	5,660	6,160

Sizes given are good for 50 per cent overloads.

Sizes are based on centrally located chimneys with short direct flues and ordinary operating efficiencies.

9. Chimneys for Blast Furnace Gas.—Chimneys for blast furnace gas should be about the same diameter as those used for coal as the slight increase in volume of gas is offset by the higher temperatures. A height of 130 ft. will produce a draft sufficient to care for 175 per cent of the boilers' rated capacity. Too much draft may result in improper mixtures of gas and air which may cause a pulsating action of the flame or, perhaps, explosions.

GENERAL CONSIDERATIONS

[Steel stacks are of two types—guyed steel stacks and self-supporting steel stacks. Their shape is cylindrical and they are of constant diameter (that is, not tapered) except the base of the self-supporting stack which is usually conical.]

[10. Forces Acting on Stack.—The main forces acting on steel stacks are: The weight of the stack and lining, the foundation reactions, the wind pressure, the pull of the guys on guyed stacks, and those forces due to possible earthquake shocks.]

11. Wind Pressures.—It has been generally accepted that the wind pressure on a surface increases directly with the square of the velocity and that the wind velocities are greater at higher than at lower elevations. In studying the pressure of wind on a chimney the following things should be considered: (1) The wind velocities in the section of the country where the chimney is to be built, (2) the

location of the chimney—that is, whether it is in a high exposed place or in a comparatively low and sheltered spot, and (3) the height of the chimney itself.

The United States Weather Bureau has proposed the following formula:

$$p = 0.004 \frac{B}{30} V^2$$

where

p = pressure in pounds per square foot on a flat surface.

B = barometric pressure in inches.

V = velocity of wind in miles per hour.

For a barometric pressure of 30 in. the formula becomes

$$p = 0.004 V^2$$

Considering that the wind pressure on the side of a circle is about 60 per cent of that on the side of a square, the formula may be reduced to

$$p_c = 0.0025 V^2$$

where

p_c = pressure in pounds per square foot on the projected area of a cylindrical stack.

In most localities, a wind velocity of 100 m.p.h. is about a maximum. This velocity will give a pressure on the projected area of a cylindrical stack equal to 25 lb. per sq. ft., which value is commonly used in the design of steel stacks. In localities where the maximum wind velocities are rarely severe, a value of 20 lb. per sq. ft. has been satisfactorily used. In sections of the country where wind velocities sometimes exceed 100 m.p.h., and especially if the chimney is to be in a high exposed place, values larger than 25 lb. per sq. ft. should be selected.

It has been observed that wind velocities, and consequent wind pressures, increase with the distance above the earth's surface. Consequently, it has been advised that, in the design of high cylindrical chimneys the value found for p_c be used for the first 300 ft. and that this value be increased about $2\frac{1}{2}$ lb. per sq. ft. for each additional 100 ft. or fractional part—that is, if for a steel chimney 440 ft. high a wind pressure of 25 lb. per sq. ft. be used for the first 300 ft., a pressure of $27\frac{1}{2}$ lb. per sq. ft. should be used from 300 ft. to 400 ft., and 30 lb. per sq. ft. from 400 ft. to 440 ft.

12 (Effect of Earthquake Shocks.—The usual effect of an earthquake shock is to cause the foundation to be moved quickly in a horizontal direction.) The damaging effect is due to the rate of acceleration—the higher the acceleration the greater the effect.

J. G. Mingle, in his article on the Design of Reinforced Concrete Chimneys in the *Proceedings* of the American Concrete Institute, vol. 14, p. 283, says that the earthquake acceleration may be taken from 7 to 9 ft. per sec. per sec. and that the force is applied instantaneously.

(The maximum stresses in a chimney will occur at a section about two-thirds of the height of the chimney instead of at the base. If the chimney is considered as an inverted pendulum, this section would correspond to the center of percussion approximately.)

The force due to an earthquake shock is applied at the base of the chimney and is given by the formula

$$F_s = \frac{A_s}{32.2} W$$

where

F_s = force in pounds due to the shock.

32.2 = gravity acceleration in feet per second per second.

W = weight of the chimney in pounds.

A_s = acceleration in feet per second per second due to the quake.

The moment due to this force is given by the formula

$$M_s = F_s y = \frac{A_s}{32.2} W y$$

where

M_s = moment in inch-pounds.

y = distance in inches of the center of gravity above the base of the chimney. For steel stacks, y is a little less than half the height.

13. **Lining.**—{Guyed steel stacks are usually unlined, while the self-supporting stacks are usually lined. The lining should be of fire brick or other refractory material capable of withstanding high temperatures up to 1994 deg. Fahr} This lining should extend from below the breech opening to a height where the heat of the gases will not damage the chimney. This height should not be less than 10 diameters or $\frac{1}{2}$ the height above the breech opening, and the lining may extend all the way from the base to the top, depending on conditions. Self-supporting steel stacks are usually designed to carry lining all the way to the top.

{In a lined steel stack, the lining is usually supported in sections by brackets fastened to the steel shell. Fire brick lining in steel stacks up to about 150 ft. in height is usually 5 in. thick and consists of 4 in. of brick and 1 in. of backing} The 5-in. lining is usually supported by an angle attached to every second horizontal section. A 4- \times 3-in. angle from $\frac{1}{16}$ to $\frac{1}{2}$ in. thick, placed with the 4-in. side horizontal makes a satisfactory support. {If the stack is higher than 150 ft., the bottom part should have a 7-in. lining, consisting of 6 in. of fire brick and 1 in. of backing} A suitable support may be provided at about every second section by a 6- \times 6-in., a 6- \times 4-in., or a 6- \times 3 $\frac{1}{2}$ -in. angle from $\frac{1}{8}$ to $\frac{1}{2}$ in. thick placed with the 6-in. side horizontal. The angles for supporting the lining may or may not be placed at the horizontal joints, except that a support is required at the joint connecting the conical base to the main body of the stack. These angles are usually placed with the vertical leg up (for ease in erection) and they rarely cross a vertical joint. The supports are usually spaced from 10 to 15 ft. apart—that is, at about every other section.

{A cast-iron cap is placed on the top of a lined steel stack to protect the steel and lining at that place.}

14. **Breech Opening.**—The breech opening is usually made about 20 per cent larger than the internal cross-sectional area of the chimney. The maximum width of the breech opening should not exceed two-thirds of the diameter. Reinforcement should be provided around the breech opening to compensate for the material removed.) The amount of vertical reinforcing material provided

should be greater than the amount of material removed in the ratio of the diameter to the long chord at right angles to the face of the opening (Chicago Bridge and Iron Works). The reinforcing material should provide sufficient vertical stiffness and should extend above and below the opening so as to transfer and distribute the stress into the steel of the stack. The reinforcing material at the top and bottom of the opening should be about the same as that on the sides. In a self-supported steel stack, the breech opening should be far enough above the conical base so that the reinforcement will not extend into the conical base section. In guyed steel stacks, the breech opening is often below the base of the stack so that the gases enter the stack proper at the bottom.

[15. Baffle Plates.—When there are two or more breech openings or flues entering the chimney, baffle plates should be provided to properly direct the gases from each flue up the chimney and prevent them from interfering with the operation of the other flues.] The baffle plates in steel chimneys are usually built up of plates and structural steel sections strongly riveted together. A facing of fire brick should be provided to prevent the hot gases from damaging the steel work. The baffles should extend from a few feet below the bottom of the breech opening to the top or a few feet above the top of the breech opening so that the flue gases will come together when they are moving in parallel lines.

16. Clean Out Doors.—Clean out doors of ample size should be provided at the base of the stack.

17. Ladder and Pulley Block.—Permanent ladders should be built in the outside of all large chimneys. Smaller chimneys should be provided with a pulley attached to the top of the stack and a wire cable left in place. A painter's trolley should be placed on the outside near the top.

18. Lightning Conductor.—A steel chimney needs no lightning conductor under ordinary conditions. If the chimney is supported so that there is no metal connection between the chimney and the ground—that is, the chimney is not grounded—some suitable form of metal connection should be provided. The metal in the chimney should be well grounded to prevent damage from lightning discharges.]

19. Corrosion.—The effect of corrosion in steel stacks is very great and practically determines the length of life or usefulness in most cases. Keeping the outside well painted decreases the corrosion and increases the life of the stack.

[To allow for corrosion, a steel stack may be designed with reduced allowable unit stresses or it may be designed with the allowable unit stresses for the material and the thickness increased $\frac{1}{16}$ in.] It seems preferable to design the stack with reduced allowable unit stresses and make no allowance for corrosion.)

[It has been observed that the effects of corrosion are frequently greater on the top section than on the other parts of the stack.] Consequently, in self-supporting stacks, many designers increase the thickness of the plates in top section $\frac{1}{16}$ in.

In the case of foundation bolts, $\frac{1}{8}$ in. (and in extreme cases $\frac{1}{4}$ in.) should be added to the diameter to allow for corrosion.

20. Allowable Unit Stresses.—In steel stack design it has been found satisfactory to use an allowable unit stress of 12,000 lb. per sq. in. in tension in the

net section of the plate (rivet holes deducted) and make no allowance for corrosion. In deducting for rivet holes in a lap joint, it is customary to consider the rivet holes as being $\frac{1}{8}$ in. larger in diameter than the rivet. The unit tension stress in the gross section will vary from 5,000 to 9,000 lb. per sq. in. depending on the efficiency of the joint.

In order to provide sufficient thickness in the plates near the top of the stack to resist the tendency to buckle or flatten, it is customary to consider the stresses in the gross section of the plate and use comparatively low stresses. In a self-supporting stack, the thickness of the plates should never be less than $\frac{1}{4}$ in. and the plates in the top section not less than $\frac{5}{16}$ in. The width of these plates should be about 6 or 8 ft. and the length preferably not over 18 ft.

The Chicago Bridge and Iron Works suggests the following formula for the unit stress in the gross section of the plate with a maximum of 10,000 lb. per sq. in.

$$s = 14,000 - 125 \frac{D}{t}$$

where

- s = unit compressive stress in gross section (maximum 10,000) in pounds per square inch.
- D = diameter of stack in feet.
- t = thickness of plate in inches.

Other designers, for self-supporting lined steel stacks up to about 300 ft. in height, use unit compressive stresses on the gross section of from 8,000 to 10,000 lb. per sq. in. for the $\frac{1}{4}$ -in. plates and from 10,000 to 12,000 lb. per sq. in. for the $\frac{5}{16}$ -in. and thicker plates.

The allowable unit stresses in rivets are usually taken as $\frac{3}{4}$ of the allowable unit tension in the plate for bearing, and $\frac{3}{4}$ of the allowable unit tension in the plate for shear. For an allowable unit tension in the plate of 12,000 lb. per sq. in., the unit bearing stress in the rivets would be 18,000 lb. per sq. in., and unit shearing stress in the rivets would be 9,000 lb. per sq. in.

For foundation bolts a unit stress of 15,000 lb. per sq. in. on the net section is allowable, provided that from $\frac{1}{8}$ to $\frac{1}{4}$ in. is added for corrosion.

21. Rivets and Rivet Spacing.—In general, the diameter of the rivets will be from 1.5 to 2.5 times the thickness of the plate.] The following diameters of rivets are generally used for the different thicknesses of plates:

Plate.....	No. 12 BWG	No. 10 BWG	No. 8 BWG	$\frac{3}{16}$	$\frac{1}{4}$	$\frac{5}{16}$
Rivets (in.)....	$\frac{1}{4}$	$\frac{3}{8}$	$\frac{3}{8}$ and $\frac{1}{2}$	$\frac{3}{8}$ and $\frac{1}{2}$	$\frac{1}{2}$ and $\frac{5}{8}$	$\frac{5}{8}$ and $\frac{3}{4}$
Plate	$\frac{3}{8}$	$\frac{1}{2}$	$\frac{1}{2}$	$\frac{5}{8}$	$\frac{3}{4}$	$\frac{3}{4}$
Rivets (in.)....	$\frac{3}{4}$	$\frac{3}{4}$	$\frac{7}{8}$	$\frac{7}{8}$	1	1

The minimum pitch for any rivet is about 3 diameters. The following gives the usual pitches for various rivets in steel stacks:

Rivet (in.).....	$\frac{1}{4}$	$\frac{3}{8}$	$\frac{1}{2}$	$\frac{5}{8}$
Pitch for single row (in.)	$\frac{3}{4}$ to $1\frac{1}{4}$	$1\frac{1}{8}$ to $1\frac{3}{4}$	$1\frac{1}{2}$ to $2\frac{1}{4}$	2 to $2\frac{1}{2}$
Rivet (in.).....	$\frac{3}{4}$	$\frac{7}{8}$	1	
Pitch for single row (in.)	$2\frac{1}{4}$ to 3	$2\frac{5}{8}$ to $3\frac{1}{2}$	3 to $4\frac{1}{2}$	

This spacing is increased somewhat (say about 50 per cent or so) for two or three rows of rivets.

Some allowance in the rivet pitch should be made so that the joint will be efficient and also so that there will be an integral number of rivet spaces which is divisible by the number of plates. If one row of rivets at the minimum pitch is not enough, the size of rivet should be increased or two rows of rivets used. Three rows are about the maximum number for the horizontal joints.

The maximum pitch should not be more than ten times the thickness of the plate, as it is difficult to secure a tight joint if this spacing is exceeded.

22. Lap Joints.—(Steel chimneys are invariably built with lap joints, usually with one row of rivets in the vertical joints and one, two, or three rows in the horizontal joints. A lap riveted joint usually is of the same strength in compression as in tension as, in the joint design) the value of the tension in the net section of the plate is made equal to either the total bearing or shearing value of the rivets. Considering that the bending moment of the wind would cause equal unit stresses in tension and compression at any section and that the weight of the stack would cause unit stresses in compression, the plates should be designed for compressive stress. (Lap joint efficiencies usually vary from 35 to 55 per cent for single riveted lap joints and from 55 to 75 per cent for double and triple riveted lap joints.)

The following table for lap joints, Table 7, shows the rivet pitch, efficiency of joint, and effective net thickness of plate for various plates, rivets, and rows of rivets. (A more complete table for the larger plates is given on p. 436.)

This table is based on the following values:

Value of plate in tension = 1.00. Value of rivet in shear = 0.75.

Value of rivet in bearing = 1.50. Minimum spacing = $3 \times$ diam. of rivet.

Maximum spacing = $10 \times$ thickness of plate.

Diameter of rivet = nominal diameter.

Diameter of rivet hole = $\frac{1}{8}$ in. + nominal diameter for values in table below dotted line.

Diameter of rivet hole = $\frac{1}{16}$ in. + nominal diameter for values in table above dotted line.

Values for $\frac{3}{16}$ -in. plates and larger are taken from the Lap Joint Rivet Tables of the Chicago Bridge and Iron Works.

TABLE 7.—LAP JOINT RIVET TABLE

Thickness of plate, inches	Rivets		Rivet pitch, inches	Efficiency of joint, per cent	Effective net thickness of plate, inches
	Diameter, inches	Rows			
#12 BWG 0.109	¼	1	0.75	45.0	0.049
		2	0.99	68.8	0.075
#10 BWG 0.134	⅜	1	1.125	50.0	0.067
		2	1.34	67.2	0.090
#8 BWG 0.165	⅜	1	1.125	44.8	0.074
		2	1.44	69.7	0.115
	½	1	1.50	50.0	0.083
		2	1.65	66.0	0.109
⅝ ₆ 0.1875	⅜	1	1.125	39.3	0.074
		2	1.32	67.0	0.125
		3	1.76	75.0	0.141
	½	1	1.50	50.0	0.094
		2	1.875	66.8	0.126
¾ 0.250	½	1	1.50	39.3	0.098
		2	1.80	65.4	0.163
		3	2.39	73.9	0.185
	⅝	1	1.88	49.0	0.122
		2	2.50	70.0	0.175
	¾	1	2.25	50.0	0.125
2		2.50	65.0	0.160	
⅞ ₆ 0.3125	½	1	1.50	31.4	0.098
		2	1.57	60.0	0.187
		3	2.04	69.2	0.216
	⅝	1	1.88	39.2	0.122
		2	2.22	66.3	0.207
		3	2.96	74.6	0.233
	¾	1	2.25	47.1	0.147
		2	3.00	70.8	0.221

TABLE 7. (Continued)

Thickness of plate, inches	Rivets		Rivet pitch, inches	Efficiency of joint, per cent	Effective net thickness of plate, inches	
	Diameter, inches	Rows				
3/8 0.375	3/8	1	1.88	32.7	0.123	
		2	1.98	61.5	0.231	
		3	2.59	71.0	0.266	
	1/4	1	2.25	39.3	0.147	
		2	2.64	66.9	0.251	
		3	3.53	75.2	0.282	
	5/8	1	2.63	45.8	0.172	
		2	3.40	70.7	0.265	
	3/16 0.4375	1/4	1	2.25	33.7	0.147
2			2.39	63.4	0.277	
3			3.15	72.2	0.316	
4			3.90	77.6	0.340	
3/8		1	2.63	39.3	0.172	
		2	3.03	67.1	0.294	
		3	4.09	75.6	0.331	
1/2 0.500		1/4	2	2.25	58.9	0.294
			3	2.86	69.5	0.347
	4		3.53	75.2	0.376	
	3/8	2	2.80	64.4	0.322	
		3	3.71	72.9	0.364	
		4	4.61	78.3	0.391	

GUYED STEEL STACKS

23. Classification.—For convenience, guyed steel stacks may be grouped into classes according to the number of sets of guys attached. Each set of guys is usually composed of three or four wires, though as many as six have been used. Stacks built fairly close together in a continuous row are usually provided with a lattice bracing between them, and each of the end stacks has one or two sets of guys of three or four wires in each set, while each of the intermediate stacks has one or two sets of guys of two wires in each set.

The classification is as follows:

(1) Stacks with one set of guys (usually 3 or 4, and sometimes 6 wires) attached to a collar at one third or one quarter of the distance from the top.

(2) Stacks with two sets of guys, usually of 3 or 4 wires each, attached to collars at various heights.

✓(3) Stacks with three sets of guys, usually of 3 or 4 wires each, attached to collars at various heights.

✓(4) Stacks in a continuous row with lattice bracing between them as previously described.

✓24. **General Design of Guyed Steel Stacks.**—In designing guyed steel stacks the following things must be provided for:

- (1) Vertical weight of the stack.
- (2) Vertical components of the pulls of the guy wires.
- (3) Bending stresses produced by wind.
- (4) Shearing stresses due to wind.
- (5) Tendency of stack to flatten or buckle.
- (6) An allowance for corrosion (usually about $\frac{1}{16}$ in. is added for this).
- (7) Vertical weight of lining if any (guyed steel stacks are practically always unlined).

In a particular design of a guyed steel stack the thickness of the plates must be computed; the joints designed as to rivets, rivet spacing, tension, compression, bearing and shear; the number of sets of guys chosen; the collar and size and number of guys in each set selected; the size of breach opening determined and the reinforcing around the opening designed; the band around the top and the attachment of the pulley block and cable determined; the support at the base of the stack proportioned to resist the vertical compression and the horizontal shear; and in some cases the foundations must be proportioned and detailed.

✓ 25. **Thickness of Plates.**—In general the steel plate in a guyed steel stack must be thick enough to be able to resist compression, bending, shear, and buckling—that is, the plate must resist all stresses caused by the weight of the stack, the wind, and the guys. The unit stresses should be within the limits previously mentioned.

The following table is used to give the minimum thicknesses of plates advisable for guyed steel stacks of different diameters:

TABLE 8

Diameters, inches	Minimum thickness of plate
30 to 48 in.	No. 12 BWG.
30 to 60 in.	No. 10 BWG.
36 to 72 in.	No. 8 BWG.
39 to 72 in.	$\frac{3}{16}$ in.
42 in. up	$\frac{1}{4}$ in.

The initial size of plate selected depends upon the particular design in question and is influenced by the cost, estimated length of life, composition of smoke gases, height of chimney, diameter of chimney, wind pressures, climate, and various human equations. It is not desirable to have many thicknesses of plates and many sizes of rivets entering into one design.

✓26. **Weight per Foot of Guyed Steel Stacks.**—The weight per foot of unlined guyed steel stacks may be estimated by the following formula (the weights of the guy wires, bands, and clips are not included):

$$W = 12.5D^2H$$

The foregoing table, Table 9, has been prepared showing the weights per foot of height for guyed steel stacks of various diameters and various thicknesses of steel plates. These figures should be increased about 10 per cent for the weights of guy wires, bands, clips, etc.

Illustrative Problem.—Find the approximate weight of a guyed steel stack 7 ft. in diameter and 110 ft. high, the steel in the upper 50 ft. being $\frac{1}{4}$ in. thick and that in the lower 60 ft. being $\frac{5}{16}$ in. thick.

From Table 9 the weight per foot of a 7-ft. (84-in.) diam. stack of $\frac{1}{4}$ -in. plate = 262.5 lb., and of $\frac{5}{16}$ -in. plate = 328.1 lb.

$$\begin{aligned} \text{Weight of upper 50 ft.} &= (50 \times 262.5) = 13,125 \text{ lb.} \\ \text{Weight of lower 60 ft.} &= (60 \times 328.1) = 19,686 \\ \text{Total weight} &= 32,811 \text{ lb.} \end{aligned}$$

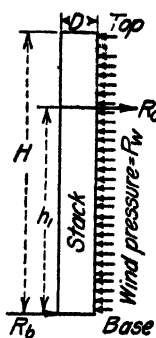

FIG. 1.—Horizontal forces acting on a guyed steel stack with one set of guys.

Illustrative Problem.—Considering the stack in the preceding illustrative problem what is the compression in the lower plate due to the weight of the stack?

Cross-sectional area of steel near bottom is

$$\frac{\pi}{4}(84.625^2 - 84^2) = 82.8 \text{ sq. in.}$$

(For a thin steel stack, the cross-sectional area of the steel = (π) (average diameter) (thickness) = (π) (84.3125) (0.3125) = 82.8 sq. in.)

$$\text{Unit compressive stress} = \frac{32,811}{82.8} = 396 \text{ lb. per sq. in.}$$

27. Pull on Guy Wires.—The guy wires must be designed to take care of the entire wind reaction at a collar. The maximum pull in any guy wire will occur when the wind blows along that guy wire.

This maximum pull in pounds may be expressed by the equation

$$\text{Pull in guy wire} = P_g = R_h / \sin \theta \text{ or } R_h \csc \theta$$

where

R_h = the horizontal reaction at the collar due to wind pressure, in pounds.
 θ = angle that the guy makes with the vertical, in degrees.)

The vertical component of the pull in the guy wire is equal to $R_h \times \cos \theta$ or, substituting $(R_h / \sin \theta)$ for the pull,

$$\frac{R_h \cos \theta}{\sin \theta} = R_h \cot \theta$$

The angle θ will be between 30 and 75 deg. in most instances.

The collar must be strong and stiff enough to withstand any tendency to buckle.

TABLE 10.—SHOWING PULL IN POUNDS IN GUY WIRE AND VERTICAL COMPONENT OF PULL FOR A HORIZONTAL COLLAR REACTION OF 1 LB. FOR GUYS MAKING VARIOUS ANGLES OF INCLINATION WITH THE VERTICAL

Angle θ (deg.)	Pull csc θ (lb.)	Vert. comp. cot θ (lb.)	Angle θ (deg.)	Pull csc θ (lb.)	Vert. comp. cot θ (lb.)	Angle θ (deg.)	Pull csc θ (lb.)	Vert. comp. cot θ (lb.)
29	2.063	1.804	45	1.414	1.000	61	1.143	0.554
30	2.000	1.732	46	1.390	0.966	62	1.133	0.532
31	1.942	1.664	47	1.367	0.933	63	1.122	0.510
32	1.887	1.600	48	1.346	0.900	64	1.113	0.488
33	1.836	1.540	49	1.325	0.869	65	1.103	0.466
34	1.788	1.483	50	1.305	0.839	66	1.095	0.445
35	1.743	1.428	51	1.287	0.810	67	1.086	0.424
36	1.701	1.376	52	1.269	0.781	68	1.079	0.404
37	1.662	1.327	53	1.252	0.754	69	1.071	0.384
38	1.624	1.280	54	1.236	0.727	70	1.064	0.364
39	1.589	1.235	55	1.221	0.700	71	1.058	0.344
40	1.556	1.192	56	1.206	0.675	72	1.051	0.325
41	1.524	1.150	57	1.192	0.649	73	1.046	0.306
42	1.494	1.111	58	1.179	0.625	74	1.040	0.287
43	1.466	1.072	59	1.167	0.601	75	1.035	0.268
44	1.440	1.036	60	1.155	0.577	76	1.031	0.249

The initial stress (tension) in each guy wire may be assumed at 5,000 lb. per sq. in. This would amount to about 1,000 lb. on a $\frac{1}{2}$ -in. wire; and about 250 lb. on a $\frac{1}{4}$ -in. wire. The weight of the guy wires may be neglected with this assumption.

Illustrative Problem.—A steel stack has one set of four $\frac{1}{2}$ -in. galvanized stranded guy wires attached to a collar at $\frac{2}{3}$ of the height. The reaction at this collar due to wind pressure of 25 lb. per sq. ft. on the stack is 4,850 lb. The guy wires make an angle of 55 deg. with the vertical and are subject to an assumed initial stress of 5,000 lb. per sq. in. (a) What is the maximum pull in each guy wire and the corresponding unit stress? (b) What is the vertical component of the pull in the guy wires?

(a) Maximum pull occurs in one guy when the wind blows along it. Pull due to initial tension must be added.

Pull = R_v csc θ + pull due to initial tension.

$$\text{Pull} = (4,850)(1.221) + (5,000)\left(\frac{\pi}{4}\right)\left(\frac{1}{4}\right)^2 = 6,900 \text{ lb.}$$

$$\text{Unit stress} = \frac{6,900}{\left(\frac{\pi}{4}\right)\left(\frac{1}{4}\right)^2} = 35,100 \text{ lb. per sq. in.}$$

(b) The total vertical component of the pulls on the guy wires is equal to the sum of the vertical component due to the wind and the vertical components of the initial tension in all four wires.

Total vertical component = $R_o \cot 55^\circ + 4 \times \text{initial tension} \times \cos 55^\circ$
 $\cos 55^\circ = 0.574$
 $\cot 55^\circ = 0.700$ (see Table 10)
 $R_o = 4,850$ lb.
 Initial tension = 985 lb. in each wire.
 Total vertical component = $(4,850)(0.700) + (4)(985)(0.574) = 5,655$ lb.

28. Wind Moments and Reactions for Stacks with One Set of Guys. The simplest way is to consider the stack as a beam simply supported at the base and at the collar where the guys are attached. If the base of the stack is securely bolted to a rigid foundation, the base end of the stack could be considered as fixed and the moments, reactions, and shears computed accordingly. However the condition is quite rare where the base of the stack can be considered as fixed, though there are many instances where the base might be considered as partially fixed. The best and simplest method appears to be the one in which no allowance is made for the partial fixing of the base. In designing the base, the allowable unit bearing and shearing stresses should not be exceeded.

The horizontal reaction (R) at the collar is found by taking moments about the base, or

$$\Sigma M_{base} = R_o h_1 - \frac{P_w H}{2} = 0$$

$$R_o = \frac{P_w H}{2h_1}$$

where R_o = horizontal collar reaction in pounds due to wind.
 P_w = total wind pressure in pounds on stack.
 R_b = horizontal reaction in pounds at base due to wind.
 H = total height of stack in feet.
 h_1 = height of collar in feet.

The horizontal reaction at the base is

$$R_b = P_w - R_o = P_w - \frac{P_w H}{2h_1}$$

The shear at the top of the collar = $-\frac{P_w}{H}(H - h_1)$

The shear just below the collar = $R_o - \frac{P_w}{H}(H - h_1)$
 $= \frac{P_w H}{2h_1} - P_w + \frac{P_w h_1}{H}$

The shear at the base = $R_b = P_w - \frac{P_w H}{2h_1}$

The bending moment at the collar =

$$-\frac{P_w}{H}(H - h_1)\frac{(H - h_1)}{2} = -\frac{P_w}{2H}(H - h_1)^2$$

The maximum positive bending moment between collar and base = $P_w H \left(1 - \frac{H}{2h_1}\right)^2$ and occurs at a point of zero shear = $\left(H - \frac{H^2}{2h_1}\right)$ feet above the base.

Figures 2 and 3 are curves showing how the shear and moment vary from the top to the base of the stack.

For a stack with the collar at $\frac{1}{3}$ of the distance from the top:

$$h_1 = \frac{2H}{3}$$

The reactions are:

$$R_s = \frac{3P_w}{4}$$

$$R_b = \frac{P_w}{4}$$

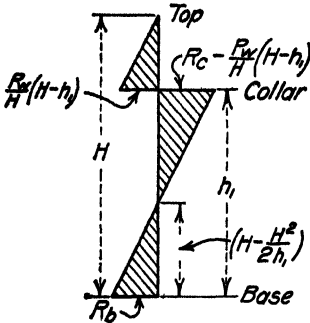

FIG. 2.—Shear diagram for a guyed steel stack with one set of guys

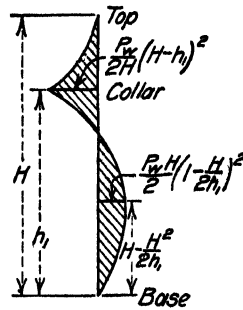

FIG. 3.—Moment diagram for a guyed steel stack with one set of guys

The shears are:

$$\text{Just above the collar} = -\frac{P_w}{3}$$

$$\text{Just below the collar} = +\frac{5P_w}{12}$$

$$\text{At the base} = -\frac{P_w}{4}$$

$$\text{The point of zero shear} = \frac{H}{4} \text{ feet above the base}$$

The moments are:

$$\text{At the collar} = \frac{P_w H}{18}$$

$$\text{At the point of zero shear} = \frac{P_w H}{32}$$

In designing a guyed stack with a collar at $\frac{2H}{3}$ from the base, all sections below the collar should be computed to carry a moment of $\frac{P_w H}{18}$.

For a stack with the collar at $\frac{1}{4}$ of the distance from the top:

$$h_1 = \frac{3H}{4}$$

The reactions are:

$$R_s = \frac{2P_w}{3}$$

$$R_b = \frac{P_w}{3}$$

The shears are:

$$\text{Just above the collar} = -\frac{P_w}{4}$$

$$\text{Just below the collar} = +\frac{5P_w}{12}$$

$$\text{At the base} = -\frac{P_w}{3}$$

The point of zero shear = $\frac{H}{3}$ feet above the base.

The moments are:

$$\text{At the collar} = \frac{P_w H}{32}$$

$$\text{At the point of zero shear} = \frac{P_w H}{18}$$

In designing a stack with a collar at $\frac{3H}{4}$ from the base, all sections between the collar and a point $\frac{H}{3}$ from the base should be computed to carry a moment varying directly from $\frac{P_w H}{32}$ at the collar to $\frac{P_w H}{18}$ at $\frac{H}{3}$ from the base. Sections below $\frac{H}{3}$ from the base should be designed to carry a moment of $\frac{P_w H}{18}$.

Illustrative Problem.—Determine the horizontal reactions and moments due to a wind pressure of 25 lb. per sq. ft. on a guyed steel stack 48 ft. high and 3 ft. in diameter having one set of guys attached to a collar 16 ft. from the top of the stack.

$$H = 48 \text{ ft.}$$

$$h_1 = 48 - 16 = 32 \text{ ft.} = \frac{2}{3}H.$$

The collar is at a point $\frac{3}{4}H$ above the base and formulas for this particular case apply.

$$P_w = (48)(3)(25) = 3,600 \text{ lb.}$$

$$R_c = \frac{(3)(3,600)}{4} = 2,700 \text{ lb.}$$

$$R_b = \frac{3,600}{4} = 900 \text{ lb.}$$

$$\text{Moment at collar} = \frac{(3,600)(48)}{18} = 9,600 \text{ ft.-lb.} = 115,200 \text{ in.-lb.}$$

$$\text{Moment at point of zero shear (12 ft. above base)} = \frac{(3,600)(48)}{32} = 5,400 \text{ ft.-lb.} =$$

64,800 in.-lb.

29. Wind Moments and Reactions for Stacks with Two Sets of Guys.—If the stack could be considered as a continuous beam in a vertical position with a number of simple rigid supports, the Three Moment Theorem could be applied and exact values found for the reactions, shears, and moments caused by the wind. However, with the exception of the base, the supports can not be considered as rigid and the values determined by the use of the Three Moment Theorem will be inaccurate. Further, as the upper collar is rarely fastened at the top of the stack and as the span between the upper and lower collars does not always equal

the span between the lower collar and the base, the application of the Three Moment Theorem is apt to prove to be cumbersome and the computations to be tedious.

An approximate method of determining the reactions, shears, and moments due to the wind for a stack of this type is to consider that the upper collar carries the wind load from the top of the stack to a point midway between the two collars, that the second collar carries the load from this point to a point midway between the lower collar and the base, and that the base carries the remainder of the load. This method gives a reaction at the upper collar less than, a reaction at the lower collar greater than, and a reaction at the base about the same as the corresponding values obtained by the use of the Three Moment Theorem. The sum of the moments of the two collar reactions about the base is practically always a little less than the moment of the wind pressure about the base. This indicates that probably the upper collar reaction found by this method is less than the actual reaction there.

Another approximate method of determining the reactions, shears, and moments due to the wind is to consider that the upper collar carries the wind load from the top of the stack to a point at a distance below the top of the stack equal to 2 times the distance from the top of the stack to the collar + $\frac{1}{2}$ the remaining distance to the lower collar. The lower collar carries the wind load from this point to a point midway between the lower collar and the base, while the base carries the remainder of the load. This method gives reactions which agree quite closely with those found by the use of the Three Moment Theorem. Further, the sum of the moments of the reactions, found by this method, about the base is practically equal to the moment of the wind pressure about the base. This approximate method has been used to determine the values given in the following table (Table 11).

In many instances, the number and diameter of the guys attached to the upper collar are the same as those of the guys attached to the lower collar, and the angles between the guys and the stack are all equal. In such cases, it is advantageous to place the collars so that the collar reactions are equal.

The following table gives the values found by the latter approximate method for the reactions and moments in a guyed steel stack with the collars placed at various heights. H = height of stack and P_w = total horizontal wind pressure.

From this table it will be noted that the reaction at the upper collar will be larger than the lower collar reaction in most instances. The design of the upper collar and its guys should be based on the reaction value given in the table and the lower collar and guys should be the same as the upper. This seems to give a stronger lower collar and guys than is warranted by the tabulated reactions. However, if the upper guys stretch a little, the upper collar reaction will be decreased and the lower collar reaction increased while the base reaction will stay about the same. Hence it is advisable to make the lower collar and guys stronger than the tabulated reaction requires. Making both collars and sets of guys the same simplifies the design and construction.

In designing for moment, it is practical and safe to design each of the middle and lower sections over their whole length for the maximum moment which occurs in that section. The upper section should be designed as a cantilever beam with the maximum moment at the upper collar.

TABLE 11.—APPROXIMATE WIND REACTIONS AND MOMENTS FOR GUYED STEEL STACKS WITH TWO SETS OF GUY WIRES

Height of collar above base		Reactions at			Moments to be used in design			Sum of moments of reactions about base should = $(0.5P_wH)$
Upper	Lower	Upper collar	Lower collar	Base	At upper collar	Between upper and lower collars	Between lower collar and base	
$\frac{2H}{3}$	$\frac{H}{3}$	$\frac{2P_w}{3}$	$\frac{P_w}{6}$	$\frac{P_w}{6}$	$\frac{P_wH}{18}$	$\frac{P_wH}{18}$	$\frac{P_wH}{18}$	$\frac{P_wH}{2}$
$\frac{3H}{4}$	$\frac{H}{2}$	$\frac{P_w}{2}$	$\frac{P_w}{4}$	$\frac{P_w}{4}$	$\frac{P_wH}{32}$	$\frac{P_wH}{32}$	$\frac{P_wH}{32}$	$\frac{P_wH}{2}$
$\frac{8H}{10}$	$\frac{H}{2}$	$\frac{9P_w}{20}$	$\frac{3P_w}{4}$	$\frac{P_w}{4}$	$\frac{P_wH}{50}$	$\frac{P_wH}{50}$	$\frac{P_wH}{32}$	$\frac{51P_wH}{100}$
$\frac{85H}{100}$	$\frac{6H}{10}$	$\frac{7P_w}{20}$	$\frac{7P_w}{20}$	$\frac{3P_w}{10}$	$\frac{9P_wH}{800}$	$\frac{9P_wH}{800}$	$\frac{9P_wH}{200}$	$\frac{203P_wH}{400}$
$\frac{85H}{100}$	$\frac{5H}{10}$	$\frac{4P_w}{10}$	$\frac{7P_w}{20}$	$\frac{P_w}{4}$	$\frac{9P_wH}{800}$	$\frac{9P_wH}{800}$	$\frac{P_wH}{32}$	$\frac{103P_wH}{200}$

30. Wind Moments and Reactions for Stacks with Three Sets of Guys.—The discussion relating to the wind moments and reactions for a stack with two sets of guys applies to a stack with three sets of guys. The same approximate method is used for determining the collar reactions in the following table (Table 12) as was used for Table 11.

TABLE 12.—APPROXIMATE WIND REACTIONS AND MOMENTS FOR GUYED STEEL STACKS WITH THREE SETS OF GUY WIRES

Height of collar above base			Reactions at				Moments to be used in design				Sum of moments of reaction about base should = $(0.5P_wH)$
Upper	Middle	Lower	Upper collar	Middle collar	Lower collar	Base	At upper collar	Between upper and middle collars	Between middle and lower collars	Between lower collar and base	
$\frac{3H}{4}$	$\frac{H}{2}$	$\frac{H}{4}$	$\frac{P_w}{2}$	$\frac{P_w}{8}$	$\frac{P_w}{4}$	$\frac{P_w}{8}$	$\frac{P_wH}{32}$	$\frac{P_wH}{32}$	$\frac{P_wH}{32}$	$\frac{P_wH}{32}$	$\frac{P_wH}{2}$
$\frac{8H}{10}$	$\frac{6H}{10}$	$\frac{3H}{10}$	$\frac{4P_w}{10}$	$\frac{3P_w}{20}$	$\frac{3P_w}{10}$	$\frac{3P_w}{20}$	$\frac{P_wH}{50}$	$\frac{P_wH}{50}$	$\frac{P_wH}{50}$	$\frac{P_wH}{50}$	$\frac{P_wH}{2}$
$\frac{85H}{100}$	$\frac{7H}{10}$	$\frac{4H}{10}$	$\frac{3P_w}{10}$	$\frac{3P_w}{20}$	$\frac{7P_w}{20}$	$\frac{P_w}{5}$	$\frac{9P_wH}{800}$	$\frac{9P_wH}{800}$	$\frac{9P_wH}{800}$	$\frac{P_wH}{50}$	$\frac{P_wH}{2}$

Each collar and attached guys should be designed to carry the maximum tabulated collar reaction for safety and other practical reasons. The steel over the entire length of each section, except the top section, should be able to carry the tabulated bending moment for that section. The steel in the top section acts as a cantilever with the maximum moment at the upper collar.

31. Unit Stress in Stack Plates Due to Wind Moments.—In determining the unit stress due to the bending moment caused by the wind pressure, it is assumed that the stack may be considered as a vertical beam and that the ordinary formula for finding the unit bending stress in a beam applies

$$s = \frac{Mv}{I}$$

where

s = unit stress in pounds per square inch in extreme fiber due to bending.

M = bending moment in inch-pounds.

v = distance from neutral axis to extreme fiber in inches.

I = moment of inertia of section in inches.⁴

For a hollow cylinder

$$v = \frac{D}{2}$$

$$I = \frac{\pi}{64}(D^4 - D_1^4)$$

where

D = external diameter in inches.

D_1 = internal diameter in inches.

Now $D - D_1 = 2t$

where t = thickness of steel plate in inches

$$D_1 = D - 2t$$

$$I = \frac{\pi}{64}[D^4 - (D - 2t)^4]$$

$$\begin{aligned} s &= \frac{M \frac{D}{2}}{\frac{\pi}{64}[D^4 - (D - 2t)^4]} = \frac{32MD}{\pi[D^4 - (D - 2t)^4]} \\ &= \frac{32MD}{\pi[D^4 - D^4 + 8D^3t - 24D^2t^2 + 32Dt^3 - 16t^4]} \\ &= \frac{32MD}{\pi[8D^3t - 24D^2t^2 + 32Dt^3 - 16t^4]} \end{aligned}$$

As the values of t^2 , t^3 , and t^4 are quite small, the three terms in the denominator containing them may be neglected without appreciable error in the result.

Then

$$s = \frac{32MD}{8\pi D^3t} = \frac{4M}{\pi D^3t} \quad (\text{unit stress formula})$$

Thickness of plate required for bending moment only:

$$t = \frac{4M}{\pi D^3s} \quad (\text{thickness formula})$$

The stress per inch of circumference

$$st = \frac{4M}{\pi D^3} \quad (\text{stress per inch of circumference formula})$$

The stress per foot of circumference

$$\frac{48M}{\pi D^3} = \frac{4M_f}{\pi D^3_f} \quad (\text{stress per foot of circumference formula})$$

where

M_f = bending moment in foot-pounds.

D_f = diameter in feet.

DESIGN OF A GUYED STEEL STACK

Assume that it is required to design a guyed steel stack for the following conditions:

Diameter: 4 ft. 3 in.

Height: 90 ft.

Breech opening below base of stack so that gases enter stack at bottom.

Unit stresses: Tension (and compression) on net section of plate = 12,000 lb. per sq. in. Shear in rivets = 9,000 lb. per sq. in. Bearing in rivets = 18,000 lb. per sq. in.

Wind pressure: 25 lb. per sq. ft. on vertical projected area.

Stack is unlined.

Minimum thickness of plate = $\frac{3}{16}$ in.

Note.—Plates $\frac{3}{16}$ in. thick are much stronger than are actually needed to carry the loads on this stack. No. 10 BWG or No. 8 BWG plates would be strong enough. However, $\frac{3}{16}$ -in. plates may be procured in widths up to 90 in. while plates of No. 10 and No. 8 BWG may be procured in widths up to 72 and 84 in. respectively (Bethlehem Manual of Steel Construction). This would mean that there would have to be more sections and as many more horizontal joints and consequent riveting if these thinner plates were used. A stack made of $\frac{3}{16}$ -in. plates is stronger and should have about twice the life of one constructed of No. 10 BWG plates.

Stack must be designed for the unit stresses caused by the following loads:

- (1) Weight of stack.
- (2) Horizontal wind pressure.
- (3) Pull of the guy wires.

Tension and compression will be caused by the moment due to the wind pressure, while the weight of the stack and the vertical components of the pulls of the guy wires will cause compression only. Hence, the unit compressive stresses will be larger than the unit tensile stresses. The wind pressure and the horizontal components of the pulls of the guys will cause horizontal shearing stresses. The resulting unit shearing stresses will usually be quite small on the area on any cross-section of a guyed stack. Provision must be made at the base of the stack so that the horizontal shear there will be transmitted to the supports.

Wind Pressure and Bending Moment.

The total wind pressure:

$$P_w = (4.25) (90) (25) = 9,562.5 \text{ lb.}$$

The total bending moment of the wind about the base:

$$\begin{aligned} M_b &= (9,562.5) \left(\frac{90}{2}\right) = 430,312.5 \text{ ft.-lb.} \\ &= 5,163,750 \text{ in.-lb.} \end{aligned}$$

Number of Sections.—Other conditions being equal, it is usually advantageous to use plates about 6 or 8 ft. wide. The width selected should be such as will give an integral

number of sections, and, if 4 in. is allowed for laps on an average, sixteen 72-in. sections will be required. Of course, if plates other than 72 in. wide are more available, the stack may be constructed of these. About 3 in. may be allowed for the lap for a single riveted lap joint, about 5 in. for a double riveted lap joint, and about 7 in. for a triple riveted lap joint. This allowance will vary somewhat depending on the size of the rivets and the allowable spacing between rows of rivets and between a row of rivets and the edge of the plate.

Location of Collars and Resulting Stresses in Guys.—Two collars each with four $\frac{1}{2}$ -in. galvanized wire cables should be sufficient for guying the stack. One collar will be located at $\frac{8H}{10}$ or 72 ft. above the base and the other collar at $\frac{H}{2}$ or 45 ft. above the base of the stack. It will be assumed that the guy wires make an angle of approximately 60 deg. with the vertical and that the initial tension in each guy is not more than 5,000 lb. per sq. in.

Table 11 shows that the horizontal wind reaction at the upper collar, $R_c = \frac{9P_w}{20}$.

Upper collar reaction = $\frac{(9)(9,562.5)}{20} = 4,300$ lb.

Maximum pull in one guy occurs when the wind blows along it or

$$P_g = R_c \csc 60^\circ = (4,300)(1.155) = 4,965 \text{ lb.}$$

$$\csc 60^\circ = 1.155 \text{ (See Table 10)}$$

Total pull in guy wire = 4,965 + pull due to initial tension = 4,965 + $\frac{5,000\pi}{16} = 5,950$ lb.

This total pull gives a maximum unit tensile stress in the guy equal to $\frac{(5,950)(16)}{\pi} = 30,300$ lb. per sq. in.

Total maximum vertical component of the pulls of the guys at the upper collar

$$= 4,300 \cot 60^\circ + (4)(985 \cos 60^\circ)$$

$$= (4,300)(0.577) + (3,940)(0.500) = 4,450 \text{ lb.}$$

The lower collar will be considered to have the same forces acting on it as act on the upper collar. This assumption is safe.

Upper Portion of Stack.—The upper portion of the stack, extending from the upper collar to the top of the stack will be designed first.

As this upper portion acts as a cantilever above the collar and as $\frac{3}{16}$ in. is the minimum plate thickness permitted in this design, the section just above the upper collar will be tested to see if it can safely carry the loads at that point. If this section is safe, all sections above it will be safe as the loads on them will be less.

The maximum compressive stress on this section will be caused by the weight of the stack above the section and the bending moment due to the wind acting on the stack above this section.

The maximum compressive stress per inch of circumference will equal

$$\frac{W}{\pi D} + \frac{4M_c}{\pi D^3}$$

$$\frac{W}{\pi D} = \frac{(90 - 72)119.6}{\pi \times 51} = 13.4 \text{ lb. per in. (see Table 9 and interpolate to get value of}$$

119.6 for 51 in. in diameter).

$$M_c = \text{moment at collar} = \frac{P_w H}{50} = \frac{(9,562.5)(90)(12)}{50} = 206,550 \text{ in.-lb. (see Table 11).}$$

$$\frac{4M_c}{D^3} = \frac{(4)(206,550)}{51^3} = 101.1 \text{ lb. per in.}$$

Maximum compression stress per inch of circumference = 13.4 + 101.1 = 114.5 lb. per in. compression.

Maximum tension stress per inch of circumference = 101.1 - 13.4 = 87.7 lb. per in. tension.

A $\frac{3}{16}$ -in. plate with one row of $\frac{3}{8}$ -in. rivets spaced 1.125 in. on centers will give an allowable stress of

$$(0.074)(12,000) = 888 \text{ lb. per inch of circumference (see Table 7 for value 0.074).}$$

Same plate with one row of $\frac{1}{2}$ -in. rivets spaced 1.50 in. on centers will give an allowable stress of

$$(0.094)(12,000) = 1,128 \text{ lb. per inch of circumference}$$

Use the one row of $\frac{1}{2}$ -in. rivets spaced 1.50 in. on centers for both horizontal and vertical joints above the upper collars. This spacing of 1.50 in. will have to be modified slightly in order to get an integral number of rivets in any horizontal joint.

For example, $\pi \times 51 \text{ in.} = 160.22 \text{ in.}$

160.22 = 107 rivets = 1.497 in on centers rivet spacing based on internal diameter of stack.

$$\begin{aligned} \text{Horizontal shear just above upper collar} &= \frac{4}{20} P_w \\ &= \left(\frac{1}{5}\right) (9,562.5) = 1,912.5 \text{ lb.} \end{aligned}$$

Horizontal shear below upper collar

$$= \frac{3}{20} P_w - \frac{1}{20} P_w = \frac{1}{20} P_w = \frac{1}{20} (9,526.5) = 2,390.6 \text{ lb.}$$

Unit shear = 2,390.6 ÷ net cross-sectional area

$$= 2,390.6 \div (\pi)(51)(0.094) = 158.5 \text{ lb. per sq. in.}$$

Upper portion of stack is safe in shear, compression, tension, and bending.

Central Portion of Stack.—This part of the stack is the portion between the upper and lower collars, and extends from a section 72 ft. above the base to a section 45 ft. above the base.

The maximum bending moment in this section = $\frac{P_w H}{50}$ (see Table 11).

Substituting value for P_w and H , this moment equals $\frac{(9,562.5)(90)(12)}{50} = 206,550 \text{ in.-lb.}$

While the bending moment varies to some extent between the collars, it is safe to consider this maximum moment $\left(\frac{P_w H}{50}\right)$ as applying to any horizontal section between the collars.

The weight of the stack at a section just above the lower collar will equal

$$(90 - 45) 119.6 = 5,382 \text{ lb. (See Table 9.)}$$

This portion of the stack will also have to carry the load caused by the vertical components of the guy wires attached to the upper collar. The maximum value of these vertical components equals 4,450 lb. as computed in a previous paragraph.

The maximum compression stress per inch of circumference will occur on a section just above the lower collar and will

$$\begin{aligned} &= \frac{4M_c}{\pi D^3} + \frac{W}{\pi D} + \frac{P(\text{guys})}{\pi D} \\ &= \frac{(4)(206,550)}{(\pi)(51)^3} + \frac{5,382}{(\pi)(51)} + \frac{4,450}{(\pi)(51)} \\ &= 101.1 + 33.5 + 27.7 = 162.3 \text{ lb. per in. comp.} \end{aligned}$$

Maximum tension stress per inch of circumference = $101.1 - 27.7 - 13.4 = 60 \text{ lb. per in.}$ tension, and occurs just below the upper collar.

A $\frac{3}{16}$ -in. plate with $\frac{1}{2}$ -in. rivets spaced about 1.50 in. on centers is safe, as this plate can carry a compressive load of 1,128 lb. per in. of circumference.

The maximum unit shearing stress will occur at a section just below the upper collar and equals 158.5 lb. per sq. in.

Lower Portion of Stack.—This part of the stack extends from the base to the lower collar 45 ft. above the base.

The maximum bending moment in this section

$$= \frac{P_w H}{82} \text{ (see Table 11).}$$

Substituting values for P_w and H , this moment equals

$$\frac{(9,582.5)(90)(12)}{32} = 332,735 \text{ in.-lb.}$$

This moment will be considered as applying to any horizontal section in this portion of the stack.

The weight of the stack will be a maximum at the base, and will equal

$$(90)(119.6) = 10,764 \text{ lb.}$$

The compressive load due to the vertical components of the pulls of the two sets of the guys will equal, considering the pulls in the lower set equal to the pull of the upper set,

$$(2)(4,450) = 8,900 \text{ lb.}$$

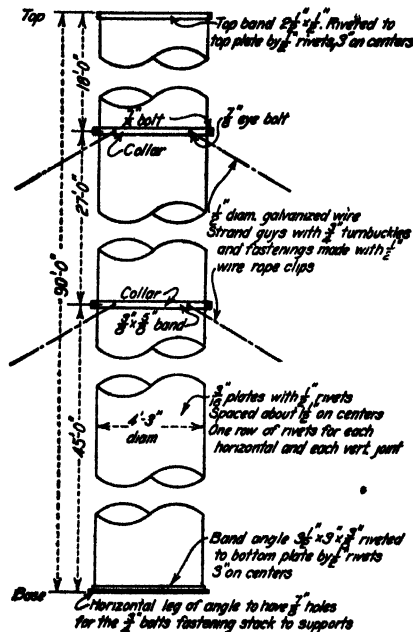

FIG. 4.—Ninety-foot guyed steel chimney.

The maximum compression stress per inch of circumference will occur on a section just above the base, and will

$$\begin{aligned} &= \frac{4M_s}{\pi D^3} + \frac{W}{\pi D} + \frac{P(\text{guys})}{\pi D} \\ &= \frac{4 \times 332,735}{(\pi)(51)^3} + \frac{10,764}{(\pi)(51)} + \frac{8,900}{(\pi)(51)} \\ &= 162.9 + 67.0 + 55.4 = 285.3 \text{ lb. per in. comp.} \end{aligned}$$

The maximum tension stress per inch of circumference will be less than half of this compression stress.

The $\frac{3}{16}$ -in. plate with $\frac{1}{2}$ -in. rivets spaced about 1.50 in. on centers is safe as it will carry a compressive stress of 1,128 lb. per in. of circumference.

The unit shear at the base equals $\frac{P_w}{4}$, divided by the net cross-sectional area of the steel or

$$\frac{2,390.6}{(\pi)(51)(0.94)} = 158.5 \text{ lb. per sq. in.}$$

The $\frac{3}{16}$ -in. plate with $\frac{1}{2}$ -in. rivets spaced about 1.50 in. on centers in both horizontal and vertical rows is satisfactory. The pitch of the rivets could be increased to 10 times the

thickness of the plate (which is about the maximum for tight joints), or 1.875 in. on centers, without causing any high stresses in rivets or plates.

Figure 4 shows the details of this 90-ft. stack.

Band at Top of Stack.—A flat steel band, say $\frac{1}{2}$ by $2\frac{1}{2}$ in. should be riveted to the top of the uppermost plate at the top of the stack to stiffen it at this point and also to provide a support for the block and wire cable. If desired, a $2\frac{1}{2}$ -by-2-in. angle, $\frac{3}{8}$ or $\frac{1}{2}$ in. thick and with the 2-in. leg horizontal, may be substituted for the band.

Band at Bottom of Stack.—The band at the bottom of the stack should be an angle, say $3\frac{1}{2} \times 3 \times \frac{3}{8}$ in. thick with the $3\frac{1}{2}$ -in. leg horizontal, riveted to the bottom of the lowest plate. This angle should be bolted to the supports of the stack by about 12 or more bolts of about $\frac{3}{4}$ in. in diameter to make a tight joint and to transmit the horizontal shear at the bottom of the stack to the supports. In a stack of this diameter, about 12 bolts would be needed to make a tight joint. The unit shearing stress in each bolt will be very small.

When the supports have a vertical projection which fits inside the bottom of the stack and makes a tight joint and transmits the shear, only a few bolts are needed to keep the stack in place.

When the stack rests on its own foundation, and the breech opening is above the base, a $\frac{3}{8}$ -in. circular plate is placed between the foundations and the bottom band of the stack. The base of the stack should be bolted to the foundations by $\frac{3}{4}$ -in. bolts spaced about a foot apart and passing through the plate and angle band.

Clean Out Door.—No clean out door is needed, if the stack is supported in such a manner that the gases enter the stack through the base.

When the stack rests on its own foundations and there is a breech opening above the base, a clean out door, say 18×24 in., should be placed near the bottom of the stack. The plate around the opening should be reinforced in both vertical and horizontal directions by angles, say about $2\frac{1}{2} \times 2\frac{1}{2} \times \frac{1}{4}$ in. in size.

Collars and Guys.—Each collar for this stack is to be made of two semi-circular bands $3 \times \frac{5}{8}$ in. in size bolted together on the stack by two $\frac{7}{8}$ -in. bolts. Each collar is to have four $\frac{7}{8}$ -in. eye bolts equally spaced for attaching the guy wires.

The guy wires shall be $\frac{1}{2}$ -in. galvanized wire cables of sufficient length provided with $\frac{3}{4}$ -in. turn buckles, and the fastenings shall be made with $\frac{1}{2}$ -in. wire rope clips.

Erection of Guyed Steel Stacks.—Guyed steel stacks are usually constructed in sections in the shops and then shipped to the place where they are to be erected. In the smaller and shorter stacks, the sections are usually riveted together on the ground and then the whole stack is erected by the aid of a gin pole, shear legs, or block and tackle fastened to a high structure near by. In some instances the stack is erected by sections, each section being securely guyed in place before the next section is added. Guyed steel stacks constructed of about $\frac{1}{4}$ in. or thicker plates are often erected plate by plate on the job as are the larger self supporting stacks. Guys are placed in position as the stack is erected.

SELF-SUPPORTING STEEL CHIMNEYS

[Self-supporting steel chimneys have been satisfactorily constructed and used up to 30 ft. in diameter and 400 ft. in height.] Comparatively large numbers of these chimneys from 150 ft. to 300 ft. in height have been built for various industries. [They are invariably of a cylindrical section and usually have a conical section at the base.]

[The lining usually extends over the entire height.] A few chimneys have been constructed with the lining extending from half to three-fourths the height, and possibly a few with no lining at all.

32. Self-supporting Steel Chimney Weights. [The weight of a self-supporting steel chimney equals the weight of the steel plus the weight of the lining.]

[The weight of the steel may be taken at 490 lb. per cu. ft. and from 15 to 20 per cent added to care for laps, rivets, and manufacturers' overweights.] In the

following table (Table 13) about 17½ per cent has been added to the net weight of the plate.

The weight of the lining is usually taken at 120 lb. per cu. ft. for the fire brick masonry, though a weight of 135 lb. per cu. ft. has been used. The thickness of the lining is usually 5 in. (4-in. brick and 1-in. backing) for the upper 150 ft. of the height and 7 in. (6-in. brick and 1-in. backing) for the remainder of the height.

TABLE 13.—WEIGHTS PER CIRCUMFERENTIAL INCH AND PER CIRCUMFERENTIAL FOOT OF SELF-SUPPORTING STEEL CHIMNEY SECTIONS 1 FT. HIGH DUE TO STEEL AND MASONRY

Steel plates			Brick masonry		
Thickness, (inches)	Weight per circumferential inch, (pounds)	Weight per circumferential foot, (pounds)	Weight 120 lb. per cu. ft.		
			Thickness, (inches)	Weight per circumferential	
				inches	feet
¼	0.75	9	5	4.17	50.0
⅜	1.00	12	6	5.00	60.0
½	1.25	15	7	5.83	70.0
⅝	1.50	18	8	6.67	80.0
¾	1.75	21	9	7.50	90.0
			Weight 135 lb. per cu. ft.		
½	2.00	24	5	4.68	56.3
⅝	2.25	27	6	5.63	67.5
¾	2.50	30	7	6.56	78.8
⅞	2.75	33	8	7.50	90.0
1	3.00	36	9	8.43	101.3
1 ¼	3.25	39	Steel is considered to weigh 490 lb. per cu. ft. and 17½% is added for laps, rivets, and manufacturers' overweights.		
1 ⅝	3.50	42			
1 ¾	3.75	45			
2	4.00	48			

NOTE.—In making computations, the diameter shall be taken equal to that of the steel plate, or equal to the interior diameter plus twice the thickness of the lining

Illustrative Problem.—A lined self-supporting steel chimney is 7 ft. in internal diameter and 145 ft. high. For the upper 75 ft., ¼-in. plates are used; for the next 20 ft., ⅜-in. plates; for the next 20 ft., ½-in. plates; and ¾-in. plates for the remainder of the stack. The lining is of brick masonry 5 in. thick and 120 lb. per cu. ft. estimated weight. What is the total weight of the stack?

The diameter of the steel shell equals

$$7 + 1\frac{1}{2} = 7\frac{1}{2} \text{ ft.}$$

The weight of 5-in. masonry per circumferential foot for a stack section 1 ft. high is (see Table 13) 50 lb. per ft.

The total weight of masonry

$$= (50)(\pi)(7\frac{5}{8})(145) = 179,000 \text{ lb.}$$

Weight per circumferential foot of $\frac{1}{4}$ -in. steel for a stack section 1 ft. high (see Table 11) = 12 lb. per ft.

Of $\frac{5}{16}$ -in. steel = 15 lb. per ft.	
Of $\frac{3}{8}$ -in. steel = 18 lb. per ft.	
Of $\frac{1}{2}$ -in. steel = 21 lb. per ft.	
Wt. of $\frac{1}{4}$ -in. steel = $(12)(75)(\pi)(7\frac{5}{8}) =$	22,200
Wt. of $\frac{5}{16}$ -in. steel = $(15)(20)(\pi)(7\frac{5}{8}) =$	7,400
Wt. of $\frac{3}{8}$ -in. steel = $(18)(20)(\pi)(7\frac{5}{8}) =$	8,870
Wt. of $\frac{1}{2}$ -in. steel = $(21)(30)(\pi)(7\frac{5}{8}) =$	15,530
	54,000
Total weight of steel =	54,000
Total weight of stack = $54,000 + 179,000 =$	233,000 lb.

33. **Conical Section at Base.**—[The conical section of the base reduces the unit stresses in the steel in the base of the stack and makes it easier to transfer the stack loads to the foundation. The height of the conical section is usually taken as about $\frac{1}{6}$ of the height of the chimney. The diameter of the conical section at the base is usually from 50 to 75 per cent larger than the stack diameter.] The proportioning of the conical base section varies with different companies and designers and, consequently, no definite rules can be given.

34. **Design in General.**—[In general, a self-supporting steel stack may be treated as a vertical cantilever beam subjected to loads caused by the horizontal wind pressure (usually 25 lb per sq. ft. of vertical projected area) and the weight of the stack. An allowance for possible earthquake stresses must be made for chimneys to be constructed in certain localities. The maximum unit stress will be compression and will occur on a section when the wind is blowing.] The maximum unit stresses should not exceed the allowable unit stresses, given in Art. 20, p. 456.

[In designing a horizontal joint, the rivets must be able to transmit the maximum compressive stresses occurring in any part of the joint without exceeding the allowable unit rivet stresses in bearing and shear. The gross thickness of the plate must also be able safely to take this compressive stress, while the net or effective thickness of the plate must be able safely to take the maximum tensile stress in any part of the joint.]

[The thickness of a plate should not be less than $\frac{3}{4}$ in. and the upper section (or two upper sections in case of a very high stack) should be a $\frac{5}{16}$ -in. plate to allow for more corrosion at the top of stack. The width of a plate is usually chosen at about 6 or 8 ft. so as to reduce the number of sections required and yet not have the plates too wide for ease of erection. A length of about 18 ft is convenient for shop and erection work. The horizontal joints should be designed with one, two, or three rows of rivets keeping the rivet spacing within the limits prescribed and making the joints as efficient as it is practical to do. One row of rivets is usually enough for a vertical joint.] After the plates and joints have been selected and designed, such details as lining supports, chimney cap, ladders, painter's trolley, base plates, etc. should be considered.] Care should be taken in designing the breech opening so that it will be properly reinforced and the stack not weakened at this point. The details of the base, base plate, size and number of foundation bolts should be carefully determined.

The foundations should be properly designed so that the allowable soil pressures will not be exceeded and the unit stresses in the foundation itself kept below the allowable unit stresses specified.

35. Method of Procedure in Design.—The following method of procedure is practically the same as that used by the Chicago Bridge and Iron Works and gives a practical design of the chimney with a reasonable amount of time and work. The general method of procedure is as follows:

(a) Lay out the stack to scale, 8 or 10 ft. to the inch being a convenient scale.

(b) Choose the number of sections or courses including laps, using a plate width of about 6 or 8 ft.

(c) At various sections compute the stresses per inch or foot of circumference due to wind and the weights of the lining and the metal. The compressive stress equals the sum of these, and the tensile stress equals the wind stress minus the weight of the metal.

(d) Draw a vertical base line parallel to the axis of the stack and equal to its height. Lay off the tensile stress values to the right of the line and plot points. Draw a curve through these points. This is known as the tension curve.

Then lay off the compressive stress values to the right of the line, plot the points, and draw a curve. This is the compression curve. A scale of 1,000 lb. per in. of circumference to 1 in. is convenient.

(e) From a lap joint rivet table or by computation, select a suitable joint for a $\frac{1}{4}$ -in. plate with one row of rivets, say $\frac{5}{8}$ or $\frac{3}{4}$ in. in diameter. Compute the compressive value of the joint per inch or per foot of circumference. This will depend on the bearing or shearing value of the rivets or on the compression value of the gross section. Plot this value to the right of the base line. Where a vertical line representing this value cuts the compression curve thus limits the length of stack in which this joint can be used. Compute the tension value of the joint per inch or per foot of circumference, plot this value and note if the part of the stack in which this joint is used is safe in tension. The tension value per inch of circumference equals the product of the net thickness in inches times 12,000 lb. per sq. in.

Repeat the process for a $\frac{1}{4}$ -in. plate with 2 rows of rivets, say $\frac{5}{8}$ or $\frac{3}{4}$ in. in diameter.

Repeat the process for a $\frac{5}{16}$ -in. plate with 2 rows of rivets, say $\frac{5}{8}$ or $\frac{3}{4}$ in. in diameter.

Repeat the process for the next size of plate and 2 rows and then 3 rows of rivets.

Continue until enough plates and joints have been selected for the entire height of the stack.

(f) Design the supports for the lining.

(g) Design the cap at the top of the chimney.

(h) Design the painter's trolley and track.

(i) Design the ladder.

(j) Design the lightning conductor. No lightning conductor is needed for a self-supporting steel chimney under ordinary conditions. If the chimney is supported so that there is no metal connection between the plates and the ground, some form of metal connection should be provided.

(k) Design the breech opening. This is an important part of the design and should be very carefully done so that the stack will not be unduly weakened.

(l) Design the baffle plates, if any are required.

(m) Design the clean out door at the base.

(n) Select the size and number and spacing of the foundation bolts, being careful that the unit stress of 15,000 lb. per sq. in. is not exceeded on the net section, and that $\frac{1}{8}$ or $\frac{1}{4}$ in. is added to the bolt diameter to allow for corrosion.

(o) Design the base plate. This may be cast iron, cast steel, or it may be built up of structural elements. Cast iron is not as satisfactory as steel. See that the necessary foundation bolt holes are correctly located and that proper provision is made for transferring the stresses in the stack to the foundation through the base plate. The base plate should be securely riveted to the base of the stack.

(p) Check the unit shearing stresses caused by the horizontal pressure of the wind at various horizontal sections of the stack. Suggested sections are joints where the number of rows of rivets or the plate thicknesses are changed, the joint at the top of the conical section, a section through the breech opening, and a section near the bottom of the conical section. The foundation bolts should be investigated for shear also. The net sections should always be considered. In general, the unit shearing stresses caused by the wind in any horizontal section will be found to be quite small.

(q) Design the foundation so that the allowable unit soil pressures will not be exceeded. The foundation must be of such size that the line of resultant pressure will never fall outside the base as this would cause the overturning of the stack. When practical, the foundation dimensions should be such that the resultant pressure will cause compression over the whole bottom section of the foundation. Provide washers or hooks for the foundation bolts so that the unit stresses in the concrete due to these bolts will not be too large. Design the foundation so that the allowable unit stresses within the foundation itself will not be exceeded.

(r) Check over the design to see that it is reasonable and practical, and that no details have been omitted.

(s) Make all general and detail drawings required.

36. Design of Foundation Bolts. [It is practically impossible to derive an exact formula for determining the stresses in foundation bolts because of the varying physical conditions entering into the problem. The planes of the contact surfaces of the foundation and the stack base may not be exactly plane and parallel. The nuts on the bolts may be a little loose or just tight or they may be turned up until there is considerable initial tension in the bolts.]

There have been several formulas proposed for the design of foundation bolts for self-supporting steel standpipes and chimneys. These formulas give different results because of different assumptions made when they were derived.

An article on "Anchor Bolt Tension" with editorial discussion appearing in the *Engineering News* of April 30, 1914, gives the results obtained from six different formulas. The editorial discussion brings out the difficulties of deriving an exact formula and shows how different results may be obtained due to different physical conditions.

In designing anchor bolts for a self-supporting steel chimney, the weight of the lining is not considered as the steel work is usually built first and the masonry lining added afterwards. Sometimes a considerable portion of the lining is removed and renewed during the life of the chimney. (This means that the anchor bolts must be large enough to keep the chimney from overturning before the lining is built and also in case the lining is removed.)

The following formula is the same as that used by the Chicago Bridge and Iron Works. It is easy to understand and apply and it gives results for the anchor bolts which are on the safe side.

In deriving the formula it is assumed that the neutral axis is perpendicular to the direction of the wind and passes through the center of the horizontal base section of the stack (see Fig. 5).

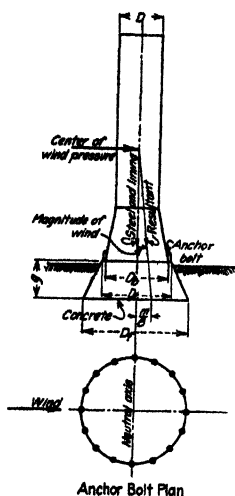

FIG. 5.

The approximate maximum tension stress per inch of circumference due to wind moment, on the side towards the wind

$$= \frac{4M}{\pi D_b^2}$$
 (See Art. 31 for general derivation of this formula) where

M = bending moment due to wind in inch-pounds

D_b = diameter of bolt ring in inches.

The stress per inch of circumference due to weight of the steel of the chimney

$$= \frac{W_s}{\pi D_b} \text{ compression}$$

where

W_s = weight of steel in stack in pounds.

The maximum tension stress per inch of circumference

$$= \frac{4M}{\pi D_b^2} - \frac{W_s}{\pi D_b}$$

If there are N bolts, then each bolt will carry stress over $\frac{\pi D_b}{N}$ inches of the circumference.

The maximum tension stress per bolt

$$= \frac{\pi D_b}{N} \left(\frac{4M}{\pi D_b^2} - \frac{W_s}{\pi D_b} \right) = \frac{4M}{ND_b} - \frac{W_s}{N}$$

If the bolt is also under initial tension, T_i , due to tightening of the nuts, then the maximum tension stress on one anchor bolt

$$= \frac{4M}{ND_b} - \frac{W_s}{N} + T_i$$

The number of foundation bolts for a self-supporting steel stack should never be less than 8 and should preferably be 10 or 12 or more depending on the size

of the stack. The larger the number of the bolts, the better the stress is distributed, and the less the danger due to a loose nut on any one bolt. The nuts on the bolts should always be tight, and preferably should have some initial tension to insure that the nuts will remain tight. If small, this initial tension may be neglected in the design.

[After the number of bolts have been assumed, the required bolt diameter may be found using an allowable unit stress of not more than 15,000 lb. per sq. in. on the net section. The diameter found must be increased for depth of thread and for corrosion.]

The following table gives the strength of bolts of different diameters. The strength values are based on the areas of the net section at the root of the thread

TABLE 14—TENSILE STRENGTH OF BOLTS

Diameter of bolt inches	Diameter of root of thread inches	Strength of rod in pounds	
		At 12,000 lb per sq. in	At 15,000 lb. per sq. in
$\frac{3}{4}$	0 620	3,620	4,530
$\frac{7}{8}$	0 731	5,040	6,300
1	0 837	6,600	8,250
$1\frac{1}{8}$	0 940	8,325	10,400
$1\frac{1}{4}$	1 065	10,700	13,400
$1\frac{3}{8}$	1 160	12,700	15,850
$1\frac{1}{2}$	1 284	15,550	19,400
$1\frac{5}{8}$	1 389	18,200	22,700
$1\frac{3}{4}$	1 490	20,950	26,200
$1\frac{7}{8}$	1 615	24,600	30,700
2	1 712	27,600	34,500
$2\frac{1}{4}$	1 692	36,200	45,300
$2\frac{1}{2}$	2 175	44,600	55,700
$2\frac{3}{4}$	2 425	55,500	69,300
3	2 629	65,200	81,500
$3\frac{1}{4}$	2 879	78,100	97,700
$3\frac{1}{2}$	3 100	90,500	113,200
$3\frac{3}{4}$	3 317	103,500	129,500
4	3 567	120,000	150,000

The anchor bolt lugs are usually riveted to the bottom plate of the stack. Each lug should be strong enough to develop the full strength of the bolt. The shearing strength and the bearing strength of the rivets fastening the lug to the

stack plate should equal the tensile strength of the bolt. Figure 6 shows how a lug is fastened to the stack plate. Anchor bolt lugs are usually not required with cast-steel base plates.

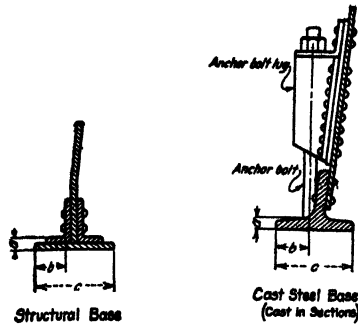

FIG. 6.—Base plates for self-supporting steel chimneys.

Illustrative Problem.—A self-supporting lined steel stack weighs 86,200 lb. (steel only) and is subjected to a wind bending moment of 50,000,000 in.-lb. The diameter of the foundation bolt circle is 20 ft., and there are to be 16 bolts. What diameter of bolt is required if the allowable unit stress is 15,000 lb. per sq. in. and the initial tension is neglected?

$$\begin{aligned} \text{Tension stress in one bolt} &= \frac{4M}{ND_b} - \frac{W}{N} \\ &= \frac{(4)(50,000,000)}{(16)(20)(12)} - \frac{86,200}{16} = 46,700 \text{ lb.} \end{aligned}$$

Table 14 shows that a bolt $2\frac{1}{2}$ in. in diameter will carry this stress, and allow more than $\frac{1}{8}$ in. for corrosion. Sixteen $2\frac{1}{2}$ -in. anchor bolts are needed.

37. Design of Base Plate.—(Base plates for self-supporting steel stacks may be made of cast iron, cast steel, or structural steel) Cast steel is always preferred to cast iron and structural steel is even better than cast steel for the larger stacks. The base plate should be riveted to the bottom plate of the stack by 2 or 3 rows of rivets. (The rivets should be such size and number as will transmit the compressive stresses from the stack plates to the base plate. The base plate must be wide enough to safely transmit the stresses to the foundation. The bearing pressure allowed on a good concrete foundation usually varies from 300 to 600 lb. per sq. in., fair values being 400 lb. per sq. in. with wind pressure neglected and 600 lb. per sq. in. with wind pressure included. The base plate must be thick enough so that the allowable unit bending and shearing stresses will not be exceeded.) Figure 6 shows sections of a cast steel base and of a built up structural steel base.

✓ The maximum compressive stress on the base plate is caused by the weight of the steel and lining and the pressure due to the wind.

✓ The maximum compressive stress per circumferential inch on the base plate in pounds per inch

$$= \frac{4M}{\pi D_b^3} + \frac{W_s + W_l}{\pi D_b}$$

where

M = bending moment due to wind in inch-pounds.

D_b = diameter of base plate in inches (usually taken same as the diameter of the foundation bolt ring).

W_s = weight of steel in stack in pounds.

W_l = weight of lining in pounds.

The width in inches (c) of the base plate required

$$= c = \frac{\text{max. compressive stress in pounds per circumferential in.}}{\text{allowable bearing stress in pounds per square inch on foundation.}}$$

The required thickness of the base plate is given by the equation

$$a = b \sqrt{\frac{3f_c}{f_b}}$$

where

a = thickness in inches (see Fig. 6)

b = unsupported width of base plate in inches (see Fig. 6)

f_c = allowable bearing stress on foundation in pounds per square inch

f_b = allowable bending stress in base plate in pounds per square inch
(usually taken as 16,000 to 18,000 lb. per sq. in. for structural steel).

This formula is derived as follows: Consider a section of the base plate 1 in. long. Using the bending moment formula $f_b = \frac{Mv}{I}$

in which

$$M = \frac{f_c b^2}{2}$$

$$v = \frac{a}{2}$$

$$I = \frac{1 \times a^3}{12} = \frac{a^3}{12}$$

Substituting

$$f_b = \frac{\left(\frac{f_c b^2}{2}\right)\left(\frac{a}{2}\right)}{\frac{a^3}{12}} = \frac{3f_c b^2}{a}$$

Solving for a

$$a = b \sqrt{\frac{3f_c}{f_b}}$$

This thickness should be checked to see if the allowable unit shearing stress (12,000 lb. per sq. in. for structural steel) is not exceeded in the base plate.

$$\text{Actual unit shear in pounds per square inch} = \frac{b}{a} \times f_s$$

The vertical leg of the base plate must be high enough to allow it to be riveted to the lower plate of the stack by 2 or 3 rows of rivets. This leg must also be thick enough so that the allowable unit compressive stresses in it will not be exceeded. The riveted joint is designed using the allowable unit stresses used in the stack.

Illustrative Problem.—Design the cast-steel base plate for a self-supporting lined steel stack under the following conditions:

Weight of steel = W_s = 86,200 lb.

Weight of lining = W_l = 398,000 lb.

Bending moment due to wind = M = 50,000,000 in.-lb.

Diameter of base plate (average) = D_b = 20 ft.

Lower plate of stack is fastened to base plate with two rows of $\frac{3}{4}$ -in. rivets. The upright leg of the base plate makes an angle with the vertical of 6 deg. 55 min. (an angle whose tangent is 0.1212).

Allowable unit stresses:

Steel plate = f_s = 16,000 lb. per sq. in.

Bearing on concrete = f_c = 400 lb. per sq. in. including wind.

Pressure per circumferential inch due to wind and weights of steel and lining

$$= \frac{W_s + W_l}{\pi D_b} + \frac{4M}{\pi D_b^2} = \frac{86,200 + 398,000}{(\pi)(20)(12)} + \frac{(4)(50,000,000)}{(\pi)(240)^2}$$

$$= 642 + 1,104 = 1,746 \text{ lb. per in. compression.}$$

Width of base plate required

$$= \frac{1,746}{400} = 4.37 \text{ in.}$$

Use 5 in. (this will make plenty of allowance for foundation bolt holes).

Assuming that $b = (0.45)(5) = 2.25$ in., the thickness of the horizontal leg

$$= a = b \sqrt{\frac{3f_s}{f_c}} = 2.25 \sqrt{\frac{(3)(400)}{16,000}} = 1.2 \sqrt{\frac{1,200}{16,000}}$$

$$= \frac{2.25}{2} \sqrt{0.3} = \frac{(2.25)(0.548)}{2} = 0.6165 \text{ in.}$$

Use $\frac{5}{8}$ in. or $\frac{3}{4}$ in.

For the height of the upright leg use $5\frac{3}{4}$ in. above base to secure necessary clearances and spacing for 2 rows of rivets. The thickness of the upper leg should be $\frac{5}{8}$ or $\frac{3}{4}$ in. The base plate may be cast in 6, 8, or 10 sections. Note that in this design the lugs for foundation bolts are to be fastened to the lower plates of the stack. Sometimes the cast-steel base plates are designed to take care of the foundation bolts so that no lugs need to be riveted to the stack plates.

If structural sections instead of cast steel were used, the base plate might be constructed of an 8-in. \times $\frac{1}{2}$ -in. plate and two 6- \times $3\frac{1}{2}$ - \times $\frac{1}{2}$ -in. angles with the 6-in. legs of the angles vertical.

38. Design of Foundations. Foundations for self-supporting steel chimneys are usually made of concrete (plain or reinforced) of sufficient size at the bottom so that the allowable unit pressures on the soil will not be exceeded, and of sufficient weight to prevent overturning. The shape of the foundation is usually in the form of the frustum of a cone or of the frustum of an eight sided pyramid. Square shaped foundations are not often used because of the high pressures which may occur in the corners when the wind blows along the direction of a diagonal of the square. Round or eight sided foundations are more economical. If the slope of the side of the foundation makes an angle with the vertical less than 45 deg., it is not customary to use any reinforcement in the base. However, if the angle is more than 45 deg., reinforcement should be used. The stresses in the foundation and the reinforcement required, etc., may be found by the use of the formulas used in the design of plain and reinforced concrete. The weight of concrete may be taken at 145 or 150 lb. per cu. ft.

The allowable unit pressure on the soil varies greatly with different kinds of soil. A value of 4,000 lb. per sq. ft. should not be exceeded for average soil conditions.)

(The foundation should be of such size and weight that there will always be compression on the under surface.) (The best design will have a zero compressive stress on one edge increasing to a maximum compressive stress at the opposite edge under the extreme conditions of loading—that is, the unit stress due to the

weight of chimney and foundation should just equal the unit stress due to the overturning moment of the wind.

In designing the foundations for a self-supporting lined steel chimney, the weight of the lining is usually omitted as the most severe case will occur when the wind is blowing on a new stack where the steel has been erected and the lining not yet put in. After the dimensions of the foundation have been selected, the maximum unit compressive stress should be computed (with weight of lining included) to see if the allowable unit compressive stress on the foundation has been exceeded.

Foundations are designed by the "cut and try" method. A size is assumed and the maximum unit soil pressures computed. If this unit pressure is practically equal to the allowable unit soil pressure, the design is satisfactory; if not, another size is selected and the computations re-made. For an experienced designer, two or three trials will give a suitable design. Foundation depths of from 5 to 12 ft. are common.

✓39. Foundation Design Formulas.

Let D_f = diameter of foundation base in inches

D_t = diameter of foundation top in inches

W_f = weight of foundation in pounds

W_l = weight of lining in stack in pounds

W_s = weight of steel in stack in pounds

P_w = total pressure due to wind in pounds

M_f = overturning moment of wind about base of foundation in inch-pounds

A_f = area of foundation base section in square-inches

h_f = height of foundation in feet

H = height of chimney in feet

I_f = moment of inertia of foundation base section in inches⁴

$$W_f = \frac{(150)(\pi)(h_f)}{(144)(12)} (D_f^2 + D_f + D_t + D_t^2) = \text{for a frustum of a cone}$$

$$W_f = \left(\frac{150}{144}\right)\left(\frac{h_f}{3}\right)(0.828)(D_f^2 + D_t^2 + D_f D_t) = \text{for a frustum of an 8-sided pyramid.}$$

$$M_f = 12P_w\left(\frac{H}{2} + h_f\right)$$

In the case of an octagonal section the diameter is the perpendicular distance between any two parallel sides.

In order to have compressive stress over all of the foundation, the unit compressive stress caused by the direct loads must always be greater than or equal to the unit stress caused by the bending moments. When these two unit stresses are exactly equal, the maximum unit compressive stress is equal to their sum, or twice either, and the minimum unit stress is equal to their difference, or zero. The unit stress on the base of the foundation due to weights of stack and foundation

$$= \frac{W_s + W_f}{A_f} = \frac{W_s + W_f}{A_f} \text{ compression in pounds per square inch.}$$

✓The unit stress on the base of the foundation due to bending moment of the wind

$$= \frac{M_f \left(\frac{D_f}{2} \right)}{I_f} = \frac{M_f D_f}{2I_f} \quad \text{in pounds per square inch. Tension on windward side. Compression on leeward side.}$$

Then $\frac{(W_s + W_f)}{A_f} \geq \frac{M_f D_f}{2I_f}$ if there is to be compression all over the base section.

For an economical design

$$\frac{W_s + W_f}{A_f} = \frac{M_f D_f}{2I_f}$$

For a circular section

$$\frac{W_s + W_f}{\frac{\pi D_f^2}{4}} = \frac{M_f D_f}{\frac{2\pi D_f^4}{64}}$$

or

$$W_s + W_f = \frac{8M_f}{D_f}$$

or

$$D_f(W_s + W_f) = 8M_f$$

For an octagonal section with wind blowing perpendicular to a side

$$\frac{W_s + W_f}{0.828D_f^2} = \frac{M_f D_f}{2 \times 0.0545D_f^4}$$

or

$$D_f(W_s + W_f) = 7.60M_f$$

The maximum unit compressive stress on the base of the foundation (neglecting lining)

$$= \frac{W_s + W_f}{A_f} + \frac{M_f D_f}{2I_f}$$

And the minimum unit compressive stress (neglecting lining)

$$= \frac{W_s + W_f}{A_f} - \frac{M_f D_f}{2I_f}$$

Including the lining, the maximum unit compressive stress on the base of the foundation

$$= \frac{W_s + W_l + W_f}{A_f} + \frac{M_f D_f}{2I_f}$$

And the minimum unit compressive stress (including lining)

$$= \frac{W_s + W_l + W_f}{A_f} - \frac{M_f D_f}{2I_f}$$

Illustrative Problem.—Design a plain concrete foundation for a self-supporting lined steel chimney under the following conditions:

Weight of steel = W_s = 86,200 lb.

Weight of lining = W_l = 398,000 lb.

Height of chimney above foundation = 167 ft.

Diameter of chimney = 12 ft.

Wind pressure = 25 lb. per sq. ft.

Diameter of base plate = 20 ft.

Diameter of top of foundation = D_f = 22 ft.

Maximum allowable unit soil pressure = 3,600 lb. per sq. ft.

Shape of foundation = frustum of a cone.

Assume a depth of 10 ft. and a base diameter of 36 ft. for the foundation.

Then:

$$D_f = 22 \text{ ft.} = 264 \text{ in.}$$

$$D_f = 36 \text{ ft.} = 432 \text{ in.}$$

$$W_s = 86,200 \text{ lb.}$$

$$W_t = 398,000 \text{ lb.}$$

$$W_f = \frac{(150)(10)(\pi)}{1,728} [(432)^2 + (264)^2 + (432)(264)] = 1,009,500 \text{ lb.}$$

$$M_f = (12)(25)(12)(167) \left(\frac{167}{2} + 10 \right) = 56,000,000 \text{ in.-lb.}$$

$$h_f = 10 \text{ ft.}$$

$$H = 167 \text{ ft.}$$

$$A_f = \left(\frac{\pi}{4} \right) (432)^2 = 146,800 \text{ sq. in.}$$

$$I_f = \left(\frac{\pi}{64} \right) (432)^4 = 1,709,650,000 \text{ in.}^4$$

Check by formula

$$D_f(W_s + W_f) \geq 8M_f$$

to see if there is compression all over the base

$$432(86,200 + 1,009,500) \geq (8)(56,000,000)$$

$$473,350,000 > 448,000,000$$

The dimensions are satisfactory as there will be a little compressive stress on the windward side under the most severe condition

Check by formula

$$\frac{W_s + W_t + W_f}{A_f} + \frac{M_f D_f}{2I_f}$$

to see if the allowable unit compression of 3,600 lb. per sq. ft. on the soil has been exceeded.

The maximum unit compressive stress

$$= \frac{86,200 + 398,000 + 1,009,500}{146,800} + \frac{(56,000,000)(432)}{2 \times 1,709,650,000}$$

$$= 10.18 + 7.07 = 17.25 \text{ lb. per sq. in.}$$

or $17.25 \times 144 = 2,485 \text{ lb. per sq. ft.}$

This foundation is safe in regard to the allowable unit compressive stress on the soil.

No reinforcement is required for shearing and bending stresses as a rough check shows that the unit shear is less than 12 lb. per sq. in., the unit bending stress (tension) is less than 30 lb. per sq. in., and the unit shear (punching) at edge of the base plate is about 8 lb. per sq. in.

40. Erection of Self-supporting Steel Chimneys.—The plates and other steel material for a self-supporting steel chimney are all cut, punched, and bent in the shop and shipped to the place where the chimney is to be erected. Minor parts are complete as far as practical before being shipped. On the job, the base plate is placed on the foundation, the plates of the lower section of the stack riveted to it, and the foundation bolts tightened. The steel work is erected by a floating scaffold placed inside the stack, and this scaffold is raised section by section as each section is completed. On the outside, a cage is used that has rollers that fit on top of the plate. The general procedure is to raise a plate to its place, bolt it in position, and then rivet it. The bottom of any plate should fit outside of the plate just below it so that the flat hooks of the inside erection scaffold can remain in place when the plate is raised to position. Usually the lining supports, ladder, and other minor steel work are riveted in place as the stack is erected.

After the steel work is complete, the lining is built in place by means of an inside scaffold built up from the bottom or by means of an inside scaffold hung from the top of the stack.

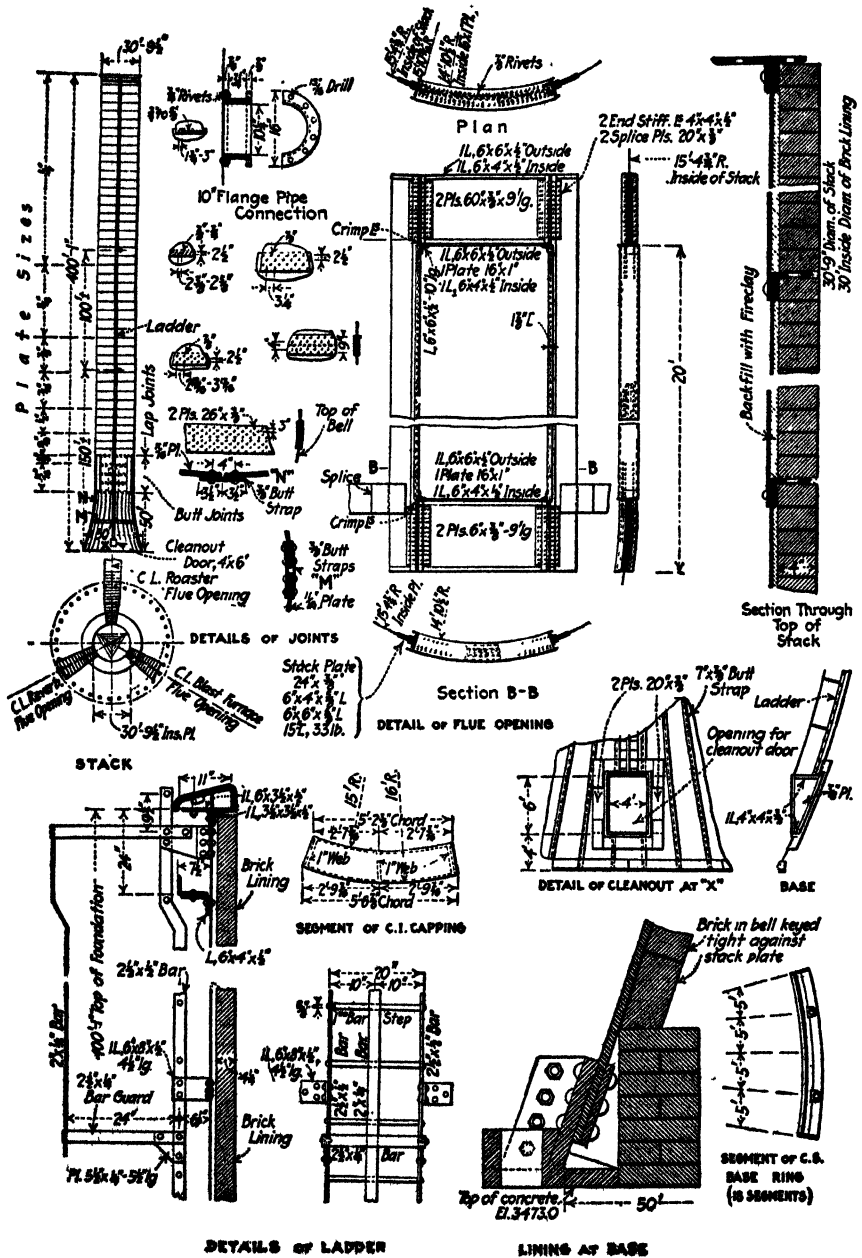

FIG. 7.—Details of 400 ft. steel chimney, Jerome, Arizona. (Chicago Bridge & Iron Works, Erectors.)

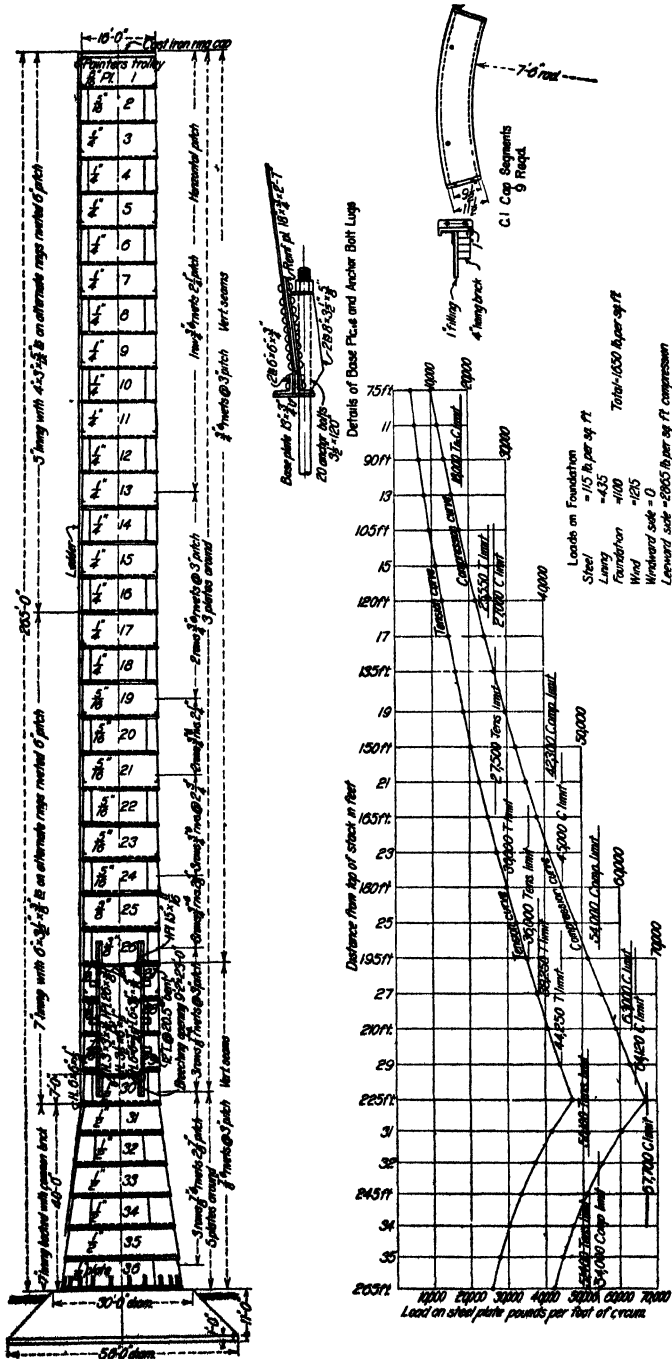

FIG. 8.—Self-supporting 265-ft. steel chimney—general design sheet.

Rivets = 18,000 lb. per sq. in. bearing.
 = 9,000 lb. per sq. in. shear.

Foundation bolts = 15,000 lb. per sq. in. tension on net section.

Soil pressure = 3,000 lb. per sq. ft. (max).

Concrete = 400 lb. per sq. in. bearing.
 = 80 lb. per sq. in. shear.

Wind pressure = 25 lb. per sq. ft. on vertical projected area.

Weight of brick lining = 120 lb. per cu. ft.

Thickness of plates = $\frac{1}{4}$ in. minimum.

Base plate—To be built up of structural steel sections.

Layout of Stack to Scale.—The first step in the design is to lay out the stack to scale. A convenient scale is 8 or 10 ft. to the inch. The stack may be laid out in pencil on drawing paper showing height, diameter, conical section, breech opening, height of different thicknesses of lining, and any other data that is available (see Fig. 8 for the general design details of this chimney).

Number of Sections.—The second step is to select the number of sections. If the plate width is chosen as 8 ft. with about 6 in. allowed for laps, the number of sections will be $225 \div 7\frac{1}{2}$ or 30 for the cylindrical portion of the stack. For the conical base section 40 ft. in height, 6 full sections will be required because the sides are battered (not vertical) and because 8 or 9 in. will be needed for each lap as there will probably be 3 rows of rivets in each horizontal joint. Total number of sections will be 36. Mark the limits of each section on the drawing.

Stresses per Foot of Circumference.—The third step is to compute the tensile and compressive stresses per foot (or inch) of circumference due to wind moment, weight of steel, and weight of lining. Table 13 may be used for computing the weights, while the stress due to the wind moment may be computed by the formula $\frac{4M}{\pi D_b^3}$.

Remember that M should be in foot-pounds and D_b in feet if the stress is to be in pounds per foot of circumference; also that the wind moment will cause tension on the windward side and compression on the leeward side. The maximum tension stress per foot of circumference equals the wind moment stress minus the steel weight stress. The maximum compression stress per foot of circumference equals the sum of the wind moment, steel weight, and lining weight stresses. For convenience, these values have been computed and tabulated in Table 15 following. It will usually save time in designing to select the thicknesses of plates and the riveted joints along with the computations of stresses per circumferential foot.

Tension and Compression Curves.—After the tension and compression stress values have been computed, they should be plotted as previously directed in Art. 35. These curves will generally show whether or not any of the tension or compression stress values are in error (see Fig. 8).

Selection of Plate Thicknesses and Riveted Joints.—By computations and the use of a Lap Joint Rivet Table like Table 7, the thickness of plate, both gross and net, and the size, number of rows and pitch of rivets may be easily selected. The pitch, in each case, will probably have to be changed a little from the values given in the table to make the number of rivets an integral number in any one row. The strength of each joint per foot of circumference may be computed and tabulated with the stress values in Table 15 and later plotted with the tension and compression curves as previously directed in Art. 35. The allowable tension stress per foot of circumference will be equal to $12,000 \times 12 \times$ the effective net thickness of the plate, provided that the allowable unit stresses in shearing and bearing on the rivets is not exceeded. The allowable compressive stress per foot of circumference will depend on the bearing or shearing values of the rivets or on the allowable compression stress on the gross section. In this design problem the least of these three values is taken for the strength of the joint.

For the $\frac{1}{4}$ -in. plate, the compression value of the joint per foot of circumference equals the least of the following three values for the case in question.

One row of $\frac{3}{4}$ -in. rivets.

Gross plate compression value = $(\frac{3}{4}) (9,000) (12) = 27,000$ lb. per ft.)

$$\text{Bearing value} = \left(\frac{3}{4}\right) \left(\frac{1}{4}\right) \left[\frac{(18,000)(12)}{\text{pitch in inches}} \right] \quad (\text{lb. per ft.})$$

$$\text{Shear value} = \left(\frac{\pi}{4}\right) \left(\frac{9}{16}\right) \left[\frac{(9,000)(12)}{\text{pitch in inches}} \right] \quad (\text{lb. per ft.})$$

Two rows of $\frac{3}{4}$ -in. rivets

Gross plate compression value = $(\frac{3}{4}) (900) (12) = 27,000$ lb. per ft.

$$\text{Bearing value} = (2) \left(\frac{3}{4}\right) \left(\frac{1}{4}\right) \left[\frac{(18,000)(12)}{\text{pitch in inches}} \right] \quad (\text{lb. per ft.})$$

$$\text{Shear value} = (2) \left(\frac{\pi}{4}\right) \left(\frac{9}{16}\right) \left[\frac{(9,000)(12)}{\text{pitch in inches}} \right] \quad (\text{lb. per ft.})$$

For the $\frac{5}{16}$ -in. and thicker plates, the compression value of the joint per foot of circumference equals the least of the following three values for the case in question.

Two rows of $\frac{3}{4}$ -in. rivets.

Gross plate compression value = $(12,000) (12)$ (thickness of plate in inches) (lb. per ft.)

$$\text{Bearing value} = (2) \left(\frac{3}{4}\right) \left[\frac{(18,000)(12)}{\text{pitch in inches}} \right] \text{ (thickness of plate in inches)} \quad (\text{lb. per ft.})$$

$$\text{Shear value} = (2) \left(\frac{\pi}{4}\right) \left(\frac{9}{16}\right) \left[\frac{(9,000)(12)}{\text{pitch in inches}} \right] \quad (\text{lb. per ft.})$$

Three rows of $\frac{3}{4}$ -in. rivets

Gross plate compression value = $(12,000) (12)$ (thickness of plate in inches) (lb. per ft.)

$$\text{Bearing value} = (3) \left(\frac{3}{4}\right) \left[\frac{(18,000)(12)}{\text{pitch in inches}} \right] \text{ (thickness of plate in inches)} \quad (\text{lb. per ft.})$$

$$\text{Shear value} = (3) \left(\frac{\pi}{4}\right) \left(\frac{9}{16}\right) \left[\frac{(9,000)(12)}{\text{pitch in inches}} \right] \quad (\text{lb. per ft.})$$

Three rows of $\frac{7}{8}$ -in. rivets.

Gross plate compression value = $(12,000)(12)$ (thickness of plate in inches) (lb. per ft.)

$$\text{Bearing value} = (3) \left(\frac{7}{8}\right) \left[\frac{(18,000)(12)}{\text{pitch in inches}} \right] \text{ (thickness of plate in inches)} \quad (\text{lb. per ft.})$$

$$\text{Shear value} = (3) \left(\frac{\pi}{4}\right) \left(\frac{49}{64}\right) \left[\frac{(9,000)(12)}{\text{pitch in inches}} \right] \quad (\text{lb. per ft.})$$

Wherever practical, the joints are designed to give a high efficiency in tension. However, in designing the lower joints of the chimney, it will be found necessary to decrease the rivet spacing from that giving the best tension value in order to obtain the necessary compressive strength. This decrease in rivet spacing will decrease the tension value of the joint, but it is better to decrease this tension value instead of increasing the thickness of the plates. The tension value of each joint should be carefully checked to see if it will safely carry its tension stress.

Plates $\frac{5}{16}$ in. thick will be selected for the two top sections to allow for the greater corrosion at the top of the stack. Then $\frac{1}{4}$ -in. plates will be used as far as they are strong enough, followed by $\frac{3}{8}$ -, $\frac{1}{2}$ -, $\frac{5}{8}$ -, $\frac{3}{4}$ -in., etc., as these thicknesses are required. Beginning at the top, one row of $\frac{3}{4}$ -in. rivets should be used; then two rows of $\frac{3}{4}$ -in. rivets; followed by three rows of $\frac{3}{4}$ -in. rivets; and three rows of $\frac{7}{8}$ -in. rivets. This will limit the rivets to two sizes. For the vertical joints, one row of rivets will be enough. Use $\frac{3}{4}$ -in. rivets in plates where $\frac{3}{4}$ -in. rivets are used for the horizontal joints and $\frac{7}{8}$ -in. rivets in plates where $\frac{7}{8}$ -in. rivets are used in the horizontal joints.

Check on Stress on Gross Section.—The unit compressive stresses in the gross sections of the plates should be checked to see that they do not exceed the values given. As the unit compressive stresses on the gross sections of the plates were considered when the computations were made in selecting plates and joints, these stresses do not need to be checked again.

TABLE 15.—DESIGN SHEET FOR A SELF-SUPPORTING STEEL LINED CHIMNEY
Height = 265 ft. Diameter of steel = 16 ft.

Number of horizontal joint from top	Distance from top (ft.)	Thickness of plate (in.)	Stress per circumferential foot					Rivets horizontal joints			Strength of joint per ft. of circumference		Rivets in vertical joints
			Wind moment stress (lb. per ft.)	Steel weight stress (lb. per ft.)	Lining weight stress (lb. per ft.)	Maximum tension (lb. per ft.)	Maximum compression (lb. per ft.)	Diameter (in.)	Rows	Approximate pitch (in.)	Tension (lb. per ft.)	Compression (lb. per ft.)	
0	0	3/16	0	0	0	0	0						
1	7.5	3/16	56	113	375	0	545						
2	15.0	3/16	225	225	750	0	1,200						
3	22.5	3/16	505	315	1,125	190	1,915						
4	30.0	3/16	895	405	1,500	490	2,800						
5	37.5	3/16	1,395	495	1,875	900	3,765						
6	45.0	3/16	2,010	585	2,250	1,425	4,845						
7	52.5	3/16	2,740	675	2,625	2,065	6,040						
8	60.0	3/16	3,575	765	3,000	2,810	7,340						
9	67.5	3/16	4,525	855	3,375	3,670	8,755						
10	75.0	3/16	5,585	945	3,750	4,640	10,280						
11	82.5	3/16	6,760	1,035	4,125	5,725	11,920						
12	90.0	3/16	8,050	1,125	4,500	6,925	13,675						
13	97.5	3/16	9,450	1,215	4,875	8,235	15,540						
14	105.0	3/16	10,950	1,305	5,250	9,645	17,505						
15	112.5	3/16	12,550	1,395	5,625	11,155	19,570						
16	120.0	3/16	14,300	1,485	6,000	12,815	21,785						
17	127.5	3/16	16,100	1,575	6,375	14,525	24,200						
18	135.0	3/16	18,100	1,665	7,050	16,435	26,815						
19	142.5	3/16	20,100	1,780	7,575	18,322	29,455						
20	150.0	3/16	22,350	1,890	8,100	20,460	32,340						
21	157.5	3/16	24,600	2,005	8,625	22,495	35,130						
22	165.0	3/16	27,050	2,115	9,150	24,935	38,315						
23	172.5	3/16	29,400	2,230	9,675	27,170	41,305						
24	180.0	3/16	32,200	2,340	10,200	29,860	44,740						
25	187.5	3/16	34,700	2,475	10,725	32,625	47,900						
26	195.0	3/16	37,750	2,610	11,250	35,140	51,610						
27	202.5	3/16	40,600	2,770	11,775	37,830	55,145						
28	210.0	3/16	43,800	2,925	12,300	40,875	59,025						
29	217.5	3/16	46,900	3,085	12,825	43,815	62,810						
30	225.0	3/16	50,300	3,265	13,350	47,035	66,915						
31	231.67	3/16	44,700	3,140	12,650	41,560	60,490						
32	238.33	3/16	40,100	3,045	12,100	37,055	55,245						
33	245.0	3/16	36,300	2,975	11,650	33,325	50,925						
34	251.67	3/16	33,300	2,915	11,300	30,385	47,515						
35	258.33	3/16	30,700	2,860	11,050	27,820	44,430						
36	265.0	3/16	28,600	2,860	10,850	25,740	42,310						
	Base												

Rivets 3/4-in. diameter (rows 1-10)
 Rivets 3/4-in. diameter (rows 11-18)
 Rivets 3/4-in. diameter (rows 19-26)
 Rivets 3/4-in. diameter (rows 27-30)
 Rivets 3/4-in. diameter (rows 31-36)

Lining Supports.—To support the 5-in. lining, 4 × 3 × $\frac{5}{16}$ -in. bent angles may be used with the 4-in. leg horizontal. These angles should be of such a length that, when one is riveted to a plate, it will not interfere with the vertical joints. These lining supports should be provided in every odd numbered section beginning at the top. The vertical spacing will be about 15 ft. Rivets, $\frac{3}{4}$ in. in diameter and spaced about every 2 ft. will be more than sufficient to transfer the load from the angles to the plates.

For the 7-in. lining supports, 6 × 3 $\frac{1}{2}$ × $\frac{3}{8}$ -in. bent angles with the 6-in. leg horizontal may be used. These angles should be cut in lengths, bent, and riveted to the plates in the same manner as prescribed for the angle supports for the 5-in. lining. The drawing (Fig. 8) indicates the sections where the lining supports are to be attached to the plates. The angle just at the top of the conical base should be about 6 × 6 × $\frac{1}{2}$ in., as extra strength and rigidity are desired at this place.

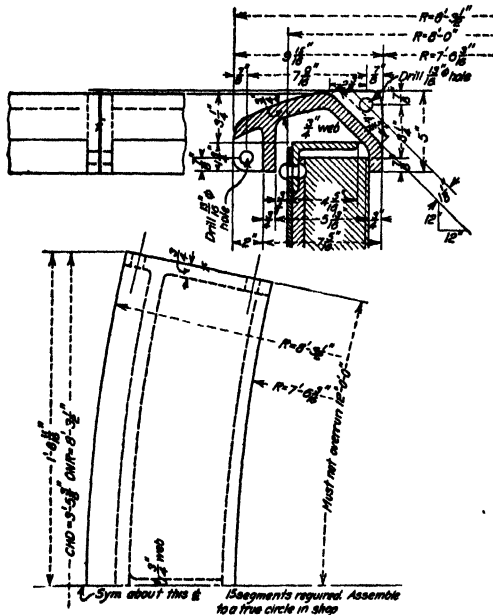

FIG. 9.—Cast-iron top cap details.

Top Cap.—For the necessary rigidity and strength of the cap and to provide the protection for the lining, a top cap about 1 in. thick and 12 in. wide is required. Figure 8 shows the details of a satisfactory cap for this chimney. Figure 9 shows the details of another form of cast-iron top cap.

Painter's Trolley and Track.—The painter's trolley and track should be fastened as near the top of the stack as practicable and should be of sufficient strength and rigidity to carry a two-man painter's platform or cage. Figure 10 shows the details of the painter's track and trolley suitable for this chimney.

Ladder.—A satisfactory ladder should be provided extending from the base, or about 10 ft. above the base, to the top of the stack. This ladder should be constructed in about 15-ft. sections (except the conical base sections). The sides should be iron bars 2 $\frac{1}{2}$ × $\frac{3}{8}$ × 15 ft. 6 in. long. The extra 6 in. is for the joint with the next section. The rungs should be $\frac{3}{4}$ in. square or $\frac{3}{4}$ in. round and they should be spaced about 1 ft. apart. The side bars should overlap 6 in. at the joints and each joint should have two $\frac{3}{8}$ -in. rivets. The center of the ladder should be about 8 in. away from the stack. The ladder lugs may be made of 2 × $\frac{3}{8}$ -in. bars about 12 in. long and bent so that one leg is 9 $\frac{1}{4}$ in. long and the other 2 $\frac{3}{4}$ in. The 2 $\frac{3}{4}$ -in. leg has a hole for a $\frac{3}{4}$ - or $\frac{1}{2}$ -in. rivet as the case may be, while

the long leg has a hole for a $\frac{5}{8}$ -in. rivet $1\frac{1}{4}$ in. from the end. Enough lugs should be provided to fasten the ladder to the stack at every other horizontal joint.

Design of Breech Opening.—The size of the breech opening is 9 ft. 2 in. by 23 ft. and the bottom of the opening is located 47 ft. above the base of the stack or 7 ft. above the top of

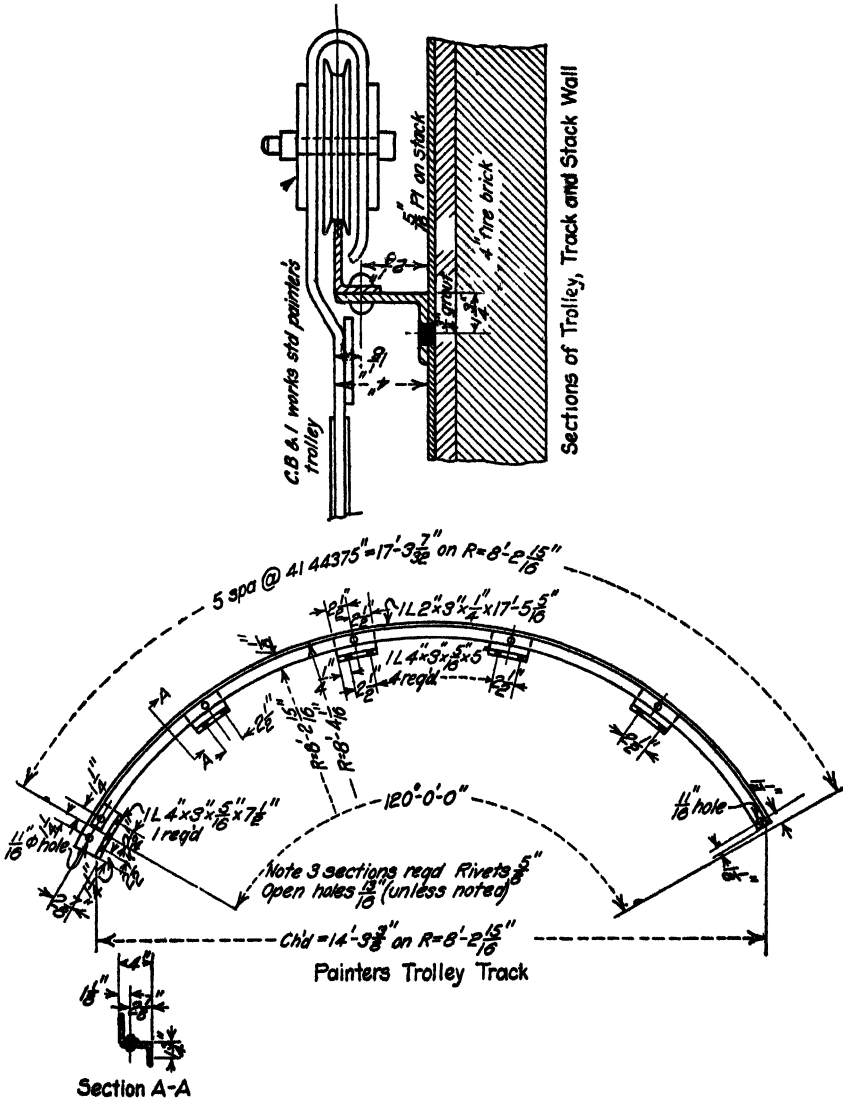

FIG. 10.—Details of painter's trolley and track.

the conical section. As previously stated, a little more than the weight of the metal removed should be placed around the opening in the form of vertical reinforcement. Using the general rule recommended by the Chicago Bridge and Iron Works, the ratio of vertical reinforcing material to removed material would be about 16 to 13.

Assume the vertical reinforcement on each side of the breech opening to consist of 1 angle $6 \times 6 \times \frac{3}{8}$ in., 1 plate $15 \times 1\frac{1}{8}$ in., and 1 angle $6 \times 3\frac{1}{2} \times \frac{5}{8}$ in. This gives a cross-sectional area on one side equal to $8.44 + 10.31 + 5.55 = 24.30$ sq. in. or 48.60 sq. in. for both sides. The cross-section of the metal removed is approximately $\frac{7}{16}$ in. \times 9 ft. 2 in. or 48.12 sq. in. In addition to this vertical reinforcement, six bent braces (three on each side) made of 12-in. 20.5-lb. channels each about 30 in. long, will be used to stiffen and keep the vertical reinforcement in its correct position in regard to the stack plates. One of these channel sections will be placed at about the center of each stack plate on each side of the opening. The vertical reinforcement should be of sufficient length to extend about 5 ft. above the top and 5 ft. below the bottom of the breech opening.

It will be noted that the cross-sectional area of the vertical reinforcement provided is nearly equal to that of the metal removed. However, when the total weight of the vertical reinforcement is computed, with allowances for the bent channel braces and for the 5-ft. extensions above and below the top and bottom of the breech opening, it will be found that the weight of the vertical reinforcement provided is considerably more than $1\frac{1}{3}$ of the weight of the parts of the stack plates removed.

The horizontal reinforcement at the top and bottom of the breech opening will be made up of 1 angle $6 \times 3\frac{1}{2} \times \frac{1}{2}$ in., 1 plate $26 \times \frac{3}{8}$ in., and 1 angle $3 \times 3 \times \frac{3}{8}$ in. The cross-sectional area of this horizontal reinforcement is approximately $\frac{2}{3}$ of the cross-sectional area of the vertical reinforcement, but it is sufficient for the purpose.

The rivets for the reinforcement at the breech opening should be sufficient to transmit the stresses from the stack plate to the reinforcement so that the reinforcement will carry its proper part of the loads and so that the stack plates at the opening will not be overstressed. The rivets between reinforcement and stack plates should preferably be $\frac{7}{8}$ in. in diameter and spaced so that they will not interfere with the rivets in the horizontal joints.

See Fig. 8 for the general arrangement of the breech opening reinforcement.

Clean Out Door.—The clean out door should preferably be placed opposite the breech opening and in about the second section from the base. Clean out doors vary in size from about 18×24 in. to 24×36 in. In a chimney of this size, a clean out door 18×30 in., or even 24×36 in., is not too large. No special reinforcement is needed around the opening as the size of the door is small compared with the size of the stack. If desired, angles about $3\frac{1}{2} \times 3\frac{1}{2} \times \frac{5}{8}$ in. in size, may be placed on the sides and top and bottom of the clean out door opening. The vertical angles should preferably extend about a foot past the top and bottom of the opening.

Design of Anchor or Foundation Bolts.—A self-supporting chimney of this size (base 25 ft. in diameter) may be anchored to its foundation by 16, 20, or 24 bolts. Assume 20 bolts.

These bolts must be able to transmit the tension in the plates to the foundations. From Table 15, it is seen that the maximum tension in pounds per circumferential foot is 25,740 lb. Then the pull that one bolt would have to transmit would equal

$$\frac{(25,740)(25)(\pi)}{20} = 101,300 \text{ lb. tension per bolt.}$$

From Table 14, it is seen that a $3\frac{1}{2}$ -in. bolt will transmit this load and allow about $\frac{1}{8}$ in. for corrosion. It should be noted that this maximum tensile stress may occur before the lining is placed in the chimney. A $2\frac{3}{4}$ -in. bolt would be large enough to care for the tensile stress after the lining is in place. But as the chimney may be subjected to a wind storm before the lining is in place, twenty $3\frac{1}{2}$ -in. bolts will be used. The length of bolt should be about 120 in. so that they may extend nearly to the bottom of the concrete foundation.

Washers will be required for the ends of the bolts embedded in the concrete as the bond stress between the concrete and bolts will not transmit all of the load. Assuming an allowable bond stress of 80 lb. per sq. in. and an imbedment of 90 in., the total bond stress would be $80 \times 90 \times 3\frac{1}{2} \times \pi$ or 79,300 lb. per bolt. The load to be carried by each washer is equal to 101,300 minus 79,300 or 22,000 lb. Assuming 400 lb. per sq. in. bearing pressure between the washer and the concrete, the net area of the washer would need to be 36.67 sq. in. The area of the bolt hole ($3\frac{1}{2} + \frac{1}{8} = 3\frac{5}{8}$ diam.) for a $3\frac{1}{2}$ -in. bolt is 10.32 sq. in. The gross area of the washer would need to be 65.32 sq. in. The required diameter would be $9\frac{1}{8}$ in. Use cast-iron washers $9\frac{1}{2}$ or 10 in. in diameter.

Another way would be to make the bolt rods a little longer and bend the end, which is to be embedded in the foundation, in the shape of a hook as is done in the construction of reinforced concrete beams.

Design of Lugs or Brackets for Foundation Bolts.—The lug or bracket for each foundation bolt may be made of 2 angles, $8 \times 3\frac{1}{2} \times \frac{5}{8}$ in., with a clear space of $3\frac{3}{4}$ in. between them for the bolt. The angles should be about 31 in. long and should bear on the base plate angle. A filler plate will be needed between these two lug angles and the stack plates. This filler plate should be about 31 in. long, 18 in. wide, and $\frac{3}{4}$ in. thick (thickness depends on thickness of the leg of the base plate angle). A section of an angle $8 \times 3\frac{1}{2} \times \frac{5}{8}$ in. in size and 11 in. long should be placed on top of the two vertical angles (see Fig. 8 for details of this lug).

As the single shearing value of one $\frac{7}{8}$ -in. rivet is 5,410 lb., the number of rivets required to fasten the lug angles to the stack plates would be $101,300 \div 5,410$ or 19 rivets. If 1-in. rivets are used, $101,300 \div 7,070$ or 14 would be needed. The bearing value for a $\frac{7}{8}$ -in. rivet in a $\frac{1}{2}$ -in. plate is 7,880 lb. and 9,000 lb. for a 1-in. rivet so that the number of rivets required is limited by the shearing value. Use 18 rivets $\frac{7}{8}$ in. in diameter for each lug (8 rivets for each vertical lug angle and 2 rivets in the horizontal angle section at the top). There will also be another $\frac{7}{8}$ -in. rivet passing through the lower part of each lug angle, the lower part of the stack plate, and the vertical legs of the 2 angles of the base plate, giving a total of 20 rivets.

Checking the vertical lug angles to see if the allowable unit stress of 12,000 lb. per sq. in. has been exceeded, the unit stress equals

$$101,300 \div (2)(6.80) = 7,450 \text{ lb. per sq. in.}$$

a safe value.

Deducting for 2 rivets gives

$101,300 \div [2(6.80 - 1.125 \times 0.625)] = 101,300 \div (2)(6.10) = 8,300$ lb. per sq. in. which is much less than the 12,000 lb. per sq. in. allowed.

Base Plate Design.—A base plate built up of structural elements is required. A plate with two angles will be used. The angles may be used with one of their legs vertical and the lower edge of the plates of the bottom section of the conical base bent so that this edge is vertical for a fraction of an inch above the top of the legs of the angles. This eliminates considerable difficult shop and field work and makes a very satisfactory detail in cases where the plates of the conical base make an angle of about 16 or 17 deg. or less with the vertical. In this chimney, the angle is about $6\frac{1}{2}$ deg.

The maximum compression per foot of circumference at the base of the stack is 42,310 lb. (see Table 15). The maximum compression per inch of circumference equals 42,310 divided by 12, or 3,525 lb. If the allowable bearing pressure on the concrete is 400 lb. per

sq. in., the base plate should be at least $\frac{3,525}{400}$ or 8.81 in. wide. To allow for possible unequal bearing between the concrete and the plate and also to provide a proper support for the angles resting on the plate, the width of the plate will be taken as 13 in. Assume the thickness of the plate as $\frac{3}{4}$ in. Take the two base plate angles as $6 \times 6 \times \frac{3}{4}$ in. The 6-in. leg is required for the two rows of rivets (staggered) connecting the stack plates to the angles (see Fig. 8 for a cross-section of this structural steel base plate).

Check the base plate and the angles to see that the allowable unit stress in bending of 16,000 lb. per sq. in., is not exceeded in the base plate.

Use the bending stress formula

$$S = \frac{Mv}{I}$$

where

S = unit stress in pounds per square inch.

M = bending moment in inch-pounds.

v = distance from neutral axis to extreme fiber in inches.

I = moment of inertia of section in inches.⁴

The projection of the plate from the vertical leg of the angle is $\frac{13 - 1\frac{1}{2} - \frac{1}{2}}{2} = 5\frac{1}{2}$ in.

The average load for a section of base plate 1 in. long is $\frac{3,525}{13} = 271$ lb. per in.

$$M = \frac{(271)(5.5)(5.5)}{2} = 4,090 \text{ in.-lb.}$$

As the plate and angle are each $\frac{3}{4}$ in. thick, the total thickness is $1\frac{1}{2}$ in. and $v = \frac{3}{4}$ in. I for the section 1 in. long (assuming neutral axis between angle and plate)

$$= \frac{(2)(1)(\frac{3}{4})^3}{3} = \frac{(2)(27)}{(3)(64)} = \frac{9}{32} = 0.28125 \text{ in.}^4$$

$$s = \frac{(4,090)(0.75)}{0.28125} = 10,900 \text{ lb per sq. in.}$$

which indicates that the thickness of plate is ample.

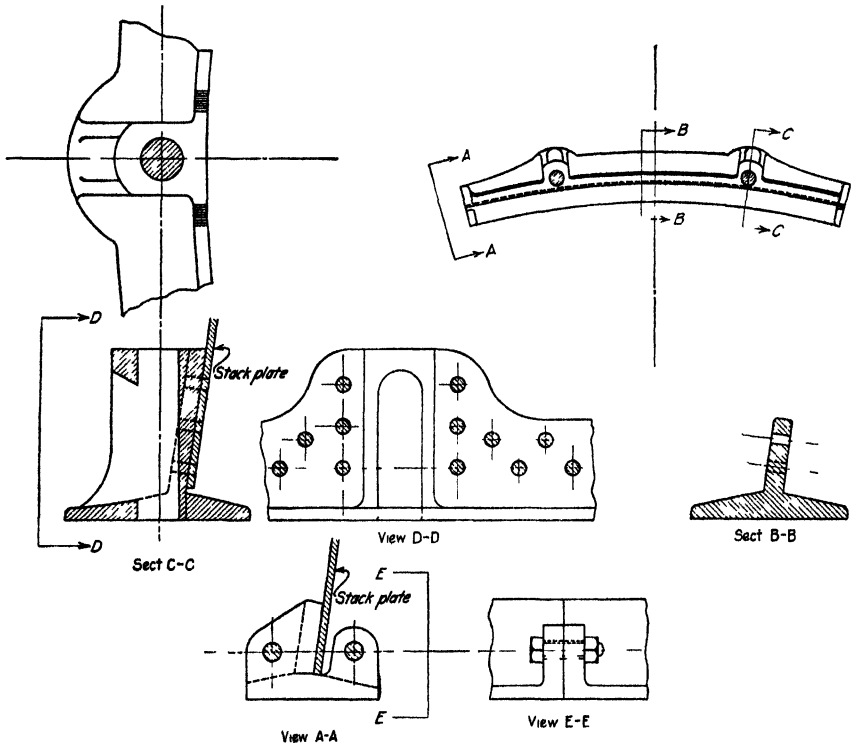

FIG. 11.—Case-steel base plate details for a 265-ft. chimney.

If the distance (projection of the plate) is taken from the center of the plate,

$$M = \frac{(271)(6.5)(6.5)}{2} = 5,720 \text{ in.-lb}$$

and

$$s = \frac{(5,720)(0.75)}{0.28125} = 15,250 \text{ lb. per sq. in.}$$

which shows that $\frac{3}{4}$ in. is the economical plate thickness.

To transfer the compressive stress in the lower plates of the chimney to the base plate, two rows (staggered) of rivets, $\frac{7}{8}$ in. in diameter will be used.

For the compressive stress of 42,310 lb. per foot of circumference the number of rivets in each row required for 1 ft. for bearing would

$$= \frac{42,310}{(2)(\frac{3}{4})(\frac{3}{4})(18,000)} = 2.63 \text{ rivets. Required pitch} = \frac{12}{2.63} = 4.56 \text{ in.}$$

The number of rivets in each row required for a length of 1 ft. for shearing (there is double shear and two rows) would

$$= \frac{42,310}{(2)(2)(0.6013)(9,000)} = 1.95 \text{ rivets}$$

$$\text{Required pitch} = \frac{12}{1.95} = 6.15 \text{ in.}$$

Use two rows (staggered) of $\frac{7}{8}$ -in. rivets with a pitch of about $3\frac{1}{2}$ in. to fasten base plate angles to lower plates of chimney. While the pitch may be as great as $4\frac{1}{2}$ in., a pitch of $3\frac{1}{2}$ in. gives a better joint for the tension and compression stresses.

See Fig. 11 for the details of a cast-steel base plate suitable for a chimney of this size. Note that no structural steel lugs for foundation bolts are required with this base.

Unit Shear in Horizontal Stack Sections.—A few sections of the chimney will be checked to see that the allowable unit shearing stress in the plates is not exceeded.

This unit shearing stress will be caused by the horizontal force of the wind.

Consider the horizontal section just above joint 18. The plate thickness is increased at this joint.

$$\begin{aligned} \text{Horizontal unit shear} &= \frac{\text{Wind force}}{\text{Steel area}} \\ &= \frac{(25)(16)(135)}{(\pi)(12)(16)(\frac{3}{4})} = 358 \text{ lb. per sq. in.} \end{aligned}$$

Consider the horizontal section just above joint 24.

$$\text{Horizontal unit shear} = \frac{(25)(16)(180)}{(\pi)(12)(16)(\frac{5}{16})} = 381 \text{ lb. per sq. in.}$$

Consider the horizontal section through the breech opening just above joint 29.

$$\text{Horizontal unit shear} = \frac{(25)(16)(217.5)}{(\pi)(12)(16)(\frac{3}{16}) - (110)(\frac{3}{16})} = 400 \text{ lb. per sq. in.}$$

It is seen that these horizontal unit shearing stresses caused by the wind are all very low and do not affect the design of the chimney.

Design of Foundations.—The foundations will be of concrete. The allowable bearing pressure on the concrete is 400 lb. per sq. in., the allowable unit shear in the concrete is 80 lb. per sq. in., and the allowable bearing pressure in the soil is 3,000 lb. per sq. ft. or 20.8 lb. per sq. in.

Assume a foundation 11 ft. deep with a top diameter of 30 ft. and a bottom diameter of 50 ft. The slope of the sides will be 45 deg for the first 10 ft. of depth and vertical for the last foot. The weight of this foundation (assuming 150 lb. per cu. ft. for the concrete)

$$\begin{aligned} &= 150 \left[\left(\frac{10}{3}\right) \left(\frac{\pi}{4}\right) (50^2 + 30^2 + 50 \times 30) + \left(\frac{\pi}{4}\right) (50)^2 (1) \right] \\ &= (150) \left(\frac{\pi}{4}\right) (18,330) = 2,165,000 \text{ lb.} \end{aligned}$$

Unit pressure per sq. ft. on soil due to foundation, steel, and lining,

$$\begin{aligned} &= \frac{2,165,000}{\left(\frac{\pi}{4}\right)(50)^2} + \frac{(2,860)(\pi)(25)}{\left(\frac{\pi}{4}\right)(50)^2} + \frac{(10,850)(\pi)(25)}{\left(\frac{\pi}{4}\right)(50)^2} \\ &= 1,100 + 115 + 435 = 1,650 \text{ lb. per sq. ft.} \end{aligned}$$

The pressure per sq. ft. on the soil due to the overturning moment of the wind at the bottom of the foundation

$$= \pm \frac{Mv}{I} = \pm \frac{(25)(16)(265) \left(\frac{265}{2} + 9\right) (25)}{\frac{(\pi)(50)^4}{64}} = \pm 1,215 \text{ lb. per sq. ft.}$$

On the windward side, the resulting soil pressure

$$= 1,650 - 1,215 = 435 \text{ lb. per sq. ft., compression.}$$

On the leeward side, the resulting soil pressure

$$= 1,650 + 1,215 = 2,865 \text{ lb. per sq. ft., compression.}$$

Considering the chimney before the lining is put in:

On the windward side, the resulting soil pressure

$$= 1,100 + 115 - 1,215 = 0 \text{ lb. per sq. ft.}$$

On the leeward side the resulting soil pressure

$$= 1,100 + 115 + 1,215 = 2,430 \text{ lb per sq. ft. compression.}$$

The foundation is satisfactory as to size and weight as there is no tension over any of the foundation area under the most extreme condition and the unit soil pressure is not exceeded

The greatest unit shearing stress on the foundation will be at the edge of the base of the chimney. Consider a radial section 1 in. wide on the leeward side of the chimney extending from the base plate to the edge of the foundation.

The load due to soil pressure

$$= \frac{1}{2} \left(\frac{2,865}{144} + \frac{2,255}{144} \right) (12.5) (12) = 2,665 \text{ lb.}$$

The weight of this section of the foundation

$$= \frac{150}{12} \left[12 \frac{1}{2} + \frac{(12 \frac{1}{2} + 2 \frac{1}{4})(10)}{2} \right] = \frac{150}{12} (12.5 + 75) = 1,095 \text{ lb.}$$

Net shearing load = 2,665 - 1,095 = 1,570 lb.

$$\text{Unit shearing stress} = \frac{1,570}{(11)(12)} = 11.9 \text{ lb. per sq. in.}$$

The greatest unit tension stress in the foundation will probably be at a point under the edge of the base of the chimney on the leeward side and at the bottom of the foundation.

Consider a radial section as before.

The moment about a vertical section through this point equals the moment due to soil pressure minus the moment due to weight of this part of the foundation.

Moment due to soil pressure (breaking this load up into a rectangle and a triangle).

$$= \left(\frac{2,255}{144} \right) (12.5) (12) \left(\frac{12.5}{2} \right) (12) + \frac{(610)(12.5)(12)}{(2)(144)} \left(\frac{2}{3} \right) (12.5) (12)$$

$$= 208,300 \text{ in.-lb.}$$

Moment due to weight of foundation (breaking this load up into a rectangle and two triangles)

$$= \frac{150}{12} \left[(12.5) \left(\frac{12.5}{2} \right) (12) + \left(\frac{12.5 \times 10}{2} \right) \left(\frac{12.5}{2} \right) (12) + \left(\frac{2.5 \times 10}{2} \right) \left(\frac{1}{3} \right) (2.5) (12) \right]$$

$$= 150 (78.12 + 390.63 + 10.42) = 71,900 \text{ in.-lb.}$$

Net moment = 208,300 - 71,900 = 137,400 in.-lb.

Unit tensile stress at bottom of foundation under base plate of stack

$$= \frac{(137,400)(6)}{(121)(144)} = 47.3 \text{ lb. per sq. in.}$$

While this unit tensile stress is not large yet it would be advisable to place some steel reinforcement in the bottom of the foundation to care for this tensile stress and also for the temperature stresses.

Two layers of 1 in. square deformed rods placed at right angles to each other about 6 in. above the bottom of the foundation, with the rods spaced about $4 \frac{1}{2}$ in. on centers in each layer, will give sufficient reinforcement.

About 6 in. below the top of the foundation, two layers of 1 in. square deformed rods should be placed at right angles to each other. The spacing of the rods in each layer should be about 9 in. on centers.

If thought advisable, some reinforcement might be placed near the surface on the inclined sides of the foundation to prevent possible cracking there due to temperature changes.

Detailing.—After the completion of the general design, detailed drawings should be prepared for the foundation and the steel work.

For the foundation, drawings should show the dimensions of the concrete work, the size and location of the reinforcement, and the size and location of the anchor bolts. Templates should be used to hold the anchor bolts in place while the foundation is being poured.

For the steel work, a general drawing should show the stack to scale with general data in regard to sections, rivets, breech opening, etc. Detailed drawings should be made for each plate showing all dimensions, rivet holes, etc. Location of lining supports should be shown. Detailed drawings are also needed for the cast-iron top cap, painter's trolley, ladder, breech opening reinforcement, base plate, lugs for foundation bolts, etc. Instructions for the shop men and for the erectors should be included whenever necessary. Painting requirements, usually one shop coat inside and out and one field coat inside and out, should be noted.

SECTION 7

STRUCTURAL STEEL DETAILING

The material in this section will deal exclusively with the work of that part of the drafting room of a structural steel fabricating concern wherein shop detail drawings are prepared. The work of designing and estimating departments of necessity precedes the work described and illustrated in this section.

It is generally understood among structural engineers that structural steel detailing knowledge can best be acquired by actual experience in the drafting room where details are made. In fact, among our best detailers may be classed many of those who have entered the drawing room as apprentices, and with little or no theoretical training, have acquired their ability by practice, observation, and contact with experienced draftsmen, templet makers and shopmen. The following description and illustrations are given with the thought of presenting to the less experienced draftsmen, some practical suggestions and methods that may be of value to them. It is further hoped that the more experienced may find herein some valuable data.¹

1. Drafting Room Organization and Procedure.—Shop detail drawings are the working drawings by means of which structural steel is fabricated in the shop. They form the medium by which the architect's or engineer's sketches or general drawings are interpreted to the fabricating shop, in order that the latter may intelligently and quickly manufacture the required product. Structural steel, unlike many other materials, is not readily worked in the field or on the job. Hence accurate drawings, showing the sizes and lengths of all materials, size and location of all holes and rivets, all cuts, coping, and in fact every detail of a structure, must be made from which the shop can accurately work. A complete structure must be divided into sections of such dimensions that they can be readily handled, shipped, and erected and these sections must be marked with identifying marks, called erection or shipping marks, which are shown on a sketch of the completed structure for use of the erector. All this drafting work is done under the direction of the chief draftsman, who has entire charge of the drafting room and should be a man of unquestioned and practical ability. The draftsmen under the chief are usually divided into squads of from six to eight men, who are under the direction of a squad chief. Those under the squad chief may be divided into checkers, draftsmen and tracers, although sometimes checkers work independent of squad chiefs. After the drawings are made and checked, final bills of material are made therefrom for purposes of determining accurate weights for payment, shipping, etc. Shop lists and shipping lists are also made. These bills

¹ For more elaborate treatment of this subject, the reader is referred to "Structural Steel Drafting and Elementary Design" by Chas. D. Conklin, Jr., published by John Wiley & Sons.

are prepared in a separate department, called the billing department, under the direction of a chief bill clerk.

The procedure of the drafting room is somewhat as follows: Information, including sketches, design sheets, general drawings, surveys, copy of estimate and other miscellaneous data which have been worked up in the designing and estimating department is handed to the chief draftsman, who examines same, assigns a contract number to the job, prepares his files for correspondence, etc. and assigns work to the squad best able to get out the details. The squad chief studies the work thoroughly and in detail, so that he has in mind every point that may arise in the preparation of the shop detail drawings. He usually makes a preliminary bill of material required for the job, so that the material can be ordered from the mill or reserved from stock. In preparing this preliminary bill, it may be necessary for the squad chief or an assistant to lay out accurately to large scale (say 3 in. to 1 ft.) any details which cannot be determined by inspection. The preliminary bill is passed on to the stock clerk, who reserves from stock any desired material and hands a list of the balance to the purchasing agent to be purchased from the mill. This is in the form of a requisition, copies of which, together with copies of the material reserved from stock, are handed to the chief draftsman and squad chief. The squad chief then apportions the work among his men, according to their ability to handle it. After drawings are prepared, they are handed to the checker, who goes over them in detail, noting any corrections or desired changes. Drawings are then returned to draftsmen, who back check corrections or changes, make them, and return drawings to checker for approval. Drawings are then sent to the billing department for billing, and are then blue printed for the shop.

A list of all drawings and blue prints made should be kept, usually on printed forms, by the squad chief. Extremely complicated drawings may be made in pencil on detail paper and traced in ink by a less experienced man. The more usual and simpler method, however, consists of making a pencil drawing directly on the dull side of tracing cloth and inking it in, all work being done by the same draftsman. It is very common now to have drawings made on either tracing paper or a specially prepared cloth, in pencil only, using a medium pencil and making lines very heavy. These drawings make very good blue prints, and effect a large saving of time. Some drafting rooms require their draftsmen to make a complete bill of material of the work detailed on a sheet, on the extreme right hand side of the same sheet. This greatly simplifies the work of the billing department.

2. Ordering Material.—In the preparation of the preliminary order of material from which structural shapes and plates may be ordered from the rolling mill or reserved from stock, the following rules may be used as they represent average practice:

(1) Order main material first.

(2) Beams and channels should be so ordered that a variation of $\frac{3}{8}$ in. in length either way will not affect the detail. If an exact length is desired, so state in the order and an extra charge may be made.

(3) Beams and Channels.

For wall bearing beams, and foundation beams, order neat length.

For beams framing into other beams, order $1\frac{1}{2}$ in. less (to the nearest $\frac{1}{2}$ in.) than the center to center distance.

For beams framing into columns, order 1 in. less (to the nearest $\frac{1}{2}$ in.) than the metal to metal distance.

For beams framing into riveted members, order $1\frac{1}{2}$ in. less than the metal to metal distance.

Crane runway beams, order 1 in. less than the distance center to center of columns.

Purlins, order 1 in. short (to nearest $\frac{1}{2}$ in.) of distance center to center of trusses.

If the end connections on beams are milled after riveting, increase thickness of connecting angles to allow for this.

(4) Columns.

Order column material milled one end $\frac{1}{2}$ to $\frac{5}{8}$ in. longer than figured length.

Order column material milled two ends, $\frac{3}{4}$ to $\frac{7}{8}$ in. longer than figured length.

Order column details in 30-ft. lengths (base angles, cap angles, shelf angles, etc.).

Order lattice bars in 20-ft. lengths.

(5) Roof Trusses.

Order chord angles $\frac{3}{4}$ in. long.

For web angles, lay out to scale, scale the length, add about $1\frac{1}{2}$ in. and multiple to 30-ft.

For gusset plates, order in multiple lengths of about 20 ft., arranging for as little waste as possible if corners are sheared.

(6) Plate Girders.

Use an even inch depth of web plate and make distance back to back of angles $\frac{1}{2}$ in. greater.

Order web plate of girder not milled on the ends, $\frac{3}{4}$ in. shorter than overall length. If milled on the ends, order $\frac{1}{2}$ in. longer than overall length for one milled end, and $\frac{3}{4}$ in. for two milled ends.

Order flange angles $\frac{3}{4}$ in. longer than overall length.

Order full length cover plates $\frac{3}{4}$ in. longer than overall length.

For cover plates less than full length, order the neat length.

Mark cover plate U.M. (universal mill or rolled edges).

Order stiffener angles with fillers $\frac{1}{4}$ in. longer than neat distance between outstanding legs of flange angles.

For crimped stiffener angles, order length equal to distance back to back of flange angles plus 1 in.

For heavy fitted stiffeners, allow $\frac{1}{2}$ in. for one fitted end and $\frac{3}{4}$ in. for two fitted ends.

Order fillers under stiffeners $\frac{1}{4}$ in. clear of flange angles.

For diagonal bracing angles, scale length and add $1\frac{1}{2}$ in.

(7) Miscellaneous.

Plates planed top or bottom should be ordered $\frac{1}{16}$ in. thicker than finished thickness, for each planing.

Plates having diagonal cuts may be ordered to sketch when over 36 in. wide and say $\frac{3}{4}$ in. thick, depending somewhat on the equipment of the shop for which material is ordered.

Channels, I-beams, and Z-bars are seldom ordered in multiple lengths.

In arranging multiple lengths make lengths about 30 ft. and not over 32 ft. Allow about 1 in. more than product of length times number required. Make all multiples end with the nearest $\frac{1}{4}$ in.

Order plates to the nearest whole inch in width. Use stock sizes when possible.

3. Layouts—Riveted Connections.—When the preliminary bill of material (for ordering purposes) has been completed, the next logical step in the preparation of shop details consists of designing the riveted connections and making layouts of difficult points, if such have not already been made for ordering purposes. The methods of designing riveted connections have been described in a previous chapter. All connections should be carefully investigated so that there may be no weak links in an otherwise strong structure. Difficult connections should be drawn out in pencil to a large scale, say 3 in. to 1 ft., in order to determine clearances, end distances, and other necessary data for detailing. These layouts are sometimes made and riveted connections designed by squad chiefs

although often such are left to the detailer. Layouts consume much time and should not be made unless absolutely necessary. The usual scale to which shop detail drawings are made is $\frac{3}{4}$ in. to 1 ft.; sometimes 1 in. to 1 ft. is used. In such cases, it is unnecessary to make layouts of simple truss connections or other diagonal connections of similar nature. A careful draftsman can readily determine all necessary data from the shop detail drawing, which for trusses and similar work should be made accurately to scale. All shop details should be drawn to scale insofar as possible, the only exception to this being the length of beam sketches which may be distorted to save space and time.

Theoretically, the working lines or skeleton upon which a truss or similar structure is laid out, should be the gravity lines of the members composing the truss. Practically, however, for light roof trusses, the rivet lines are used, thus much simplifying the work for draftsman and shop. The skeleton diagram for the truss is laid out first to scale and the angles or other truss members are drawn around the skeleton using the latter as the rivet lines of the angles, the proper gages (as found in the steel handbook) being used. For heavy trusses, or similar structures, in order to avoid excessive moments at the connections, the gravity lines should be used as working lines.

4. Shop Detail Drawings.—After all layouts have been made and connections designed, the draftsman proceeds to make the shop detail drawing to scales as indicated below. In preparing shop detail drawings, the draftsman might well keep in mind the following rules, which are typical of modern practice:

Make shop details to scale of $\frac{3}{4}$ in. to 1 ft. or 1 in. to 1 ft. In exceptional cases, $\frac{1}{2}$ or $1\frac{1}{2}$ in. to 1 ft. may be used.

Use care in placing drawing on sheet to avoid unnecessary crowding of sketches or dimensions.

Size of sheet for large drawings is usually 24 × 36 in. Small sheets may be used for detailing beams, channels, pins, etc. Printed beam and channel sheets, with outline of beams and channels and dimension lines printed in black ink, save considerable time in this type of detailing.

Title of sheet should be placed in lower right-hand corner.

Detail members as nearly as practicable in the position which they occupy in the finished structure. Horizontal members should be detailed lengthwise and vertical members, crosswise on the sheet. Inclined members and vertical members, such as columns, may be detailed lengthwise on the sheet in which case the lower end should be placed to the left.

Show elevations, sections, and other views in their proper positions. Place top view directly above and bottom view below the elevation. The bottom view is always drawn as a horizontal section as seen from above.

For a member symmetrical about a center line, draw only the left-hand half and note that it is symmetrical about the center line.

Several members, when similar, but slightly different, may be detailed on one sketch, the difference being shown by notes. Make such notes positive. Do not use the word "omit." If such notes become cumbersome and lead to ambiguity, avoid them and make another sketch.

Eliminate all unnecessary views and lines. Show just enough to express to the shop what is intended. A shop detail is just a working drawing and not a masterpiece of art. Do not cross hatch, blacken or otherwise elaborate a shop detail unless it is absolutely necessary to make the drawing clearly understood.

On the other hand, make all work shown clear and distinct and all dimensions in large figures so that all can be easily followed. If a detail is worth making, it is worth making right and in such manner that the shop will have no difficulty in interpreting it.

Make the part representing the steel work detailed of heavy black lines. Do not show hidden parts unless necessary for clearness and then show these parts by heavy dotted lines.

In detailing members which connect to others, the latter may be shown in red lines, in order to illustrate their relative position. Avoid the use of colored inks on shop drawings except in this case.

Dimension lines and rivet lines should be made of fine black lines, full and not dotted. Dimensions should be placed above dimension lines, and not in or on them. Make fractions with horizontal dividing lines.

Holes for field connections should be blackened. All holes in a group should be shown, as a rule. Rivet heads of shop driven rivets shall be shown only when necessary, as at the ends of members, when countersunk, flattened, or adjacent to field connections. Make open holes smaller in diameter (on the drawing) than the circles representing shop driven rivets.

When part of one member to be detailed is the same as another already detailed, it is unnecessary to repeat dimensions, etc. It is only necessary to refer to the previous sketch, describing the parts that are the same.

Main dimensions, such as story heights, center to center distances, etc., when given on a detailed drawing, are very helpful to a checker.

The size and length of material should be given close to the part which it represents, in clear, neat figures. If placed to one side, an arrowhead should indicate the material referred to.

If a series of dimension lines are given adjacent to a sketch, largest dimensions should be given farthest from sketch, and small dimensions next to the sketch. Dimension lines should be drawn from $\frac{1}{4}$ to $\frac{3}{8}$ in. apart.

Refer to steel handbook or the volume on "Structural Members and Connections" for conventional signs for rivets; that is, for method of representing, on detail drawings, the various kinds of rivet heads, such as button head, countersunk one or both sides, etc.

The usual maximum sizes for shipping by railway in one freight car are 8 ft. for width, 10 ft. for height, and 40 to 60 ft. for length. In detailing structures, field connections should be placed so as to keep the member shop rivets within the above sizes. In exceptional cases, members may be made longer than the above and shipped on two or more cars. In export work, structures are usually shipped knocked down (in small pieces) to facilitate shipping by boat.

Each piece that is shipped separately should have an erection or shipping mark which shall consist of capital letters and numerals or numerals only. Do not use small letters for erection marks. Pieces which are absolutely alike may have the same erection mark. Trusses are usually marked $T1-T2$, etc.; columns $C1-C2$, etc.

For purposes of assembling the various parts of one member in the shop, assembling marks should be used for each plate or shape. These shall consist of small letters and numerals. No capital letters should be used. One system of assembling marks in common use is given on the next page.

Members which are absolutely similar but opposites are called rights and lefts. The member detailed in such cases is called the right-hand piece and the opposite one, the left-hand piece. The erection mark of the former is followed by a large R and the erection mark of the latter by a large L .

The number of members required should be distinctly stated on a drawing. In a list giving the required number of members, write the word "one" out.

Parts of members which must be shipped bolted so that they can be taken off during the erection should be marked "Bolt for shipment."

The size of rivets, open holes, nature of shop paint, and other notes should be specified near the lower right-hand corner of each sheet.

For title main dimensions, and shipping or erection marks, letter in heavy type. Use plain lettering, medium type, for other data.

Usual size of rivets for building work is $\frac{3}{4}$ in. in diameter. Other sizes may be used in exceptional cases.

In writing shop bills, main material should be billed first, followed by smaller pieces. Begin at the left end of a girder or truss and at the bottom of a column. Do not bill all angles and then all plates; group the material together that is assembled together. In case of a column containing brackets, bill each different bracke complete by itself. The shop bill is used as a guide in laying out and assembling the member in the shop as well as a list of material required, and should be made accordingly. Members radically different should be billed separately and not bunched together.

Use standard beam connections for connecting beams to beams, as indicated in steel handbook except in special cases. Watch the limiting values of such connections to see that they are not exceeded.

In beam details, it is usual to make the distance center to center of end connection holes $5\frac{1}{2}$ in. In a beam detail showing the elevation of the web of a beam, it is usually understood that the horizontal distance center to center of lines of holes, when this distance is not given on drawing, is $5\frac{1}{2}$ in. and the vertical distance between holes, when not given, is 3 in.

Most structural steel shops have numerous standard details which should be followed when possible.

Avoid unnecessary countersunk rivets, as they are very costly. Use the least possible number of such in the bases of columns.

Steel handbooks give standard gages (distances center to center of lines of holes for flanges of beams and columns or distances from back of angle to lines of holes for angles) for beams, columns, and angles and these gages should be used when possible.

Rivets should be so spaced that they can be readily driven in a shop or field as may be necessary. Proper clearances and spacing can be obtained from the steel handbook.

Holes for anchor bolts are usually $\frac{1}{4}$ to $\frac{5}{16}$ in. larger than the size of the bolts, to allow for discrepancies in setting the bolt.

The usual minimum shop clearance between diagonal steel members and chords, as in truss work, is $\frac{1}{4}$ in. Filled clearance, minimum, in such cases, should be $\frac{1}{2}$ in. A beam framing to other steel members by means of connection angles should have an overall length $\frac{1}{8}$ in. less than the figured distance between surfaces against which the beam frames.

When one beam frames into another with flanges at the same elevation, the flange of the former must be cut out or "coped" to fit against the flange of the latter. It is not customary to dimension a cope on a detailed drawing, but merely to call for the size of beam to which one detailed must be coped (see typical beam details). The shop does the rest in such cases.

An erection diagram, usually a line diagram of the completed structure, should be made with the erection or shipping marks thereon, to enable the erector to easily assemble the work in the field.

Lettering should be simple, straight line Gothic style, preferably inclined although vertical lettering is frequently used. Drawings should be neat and clear so as to inspire confidence in their accuracy.

Dimensions given on a column, when not otherwise shown, are measured from the top of the base plate to the point indicated.

Wherever a note on a drawing will help the erector, by all means use it. It is quite common to place a mark on a member showing the position of one end of the member in the finished structure so that the erector will erect the member as intended.

5. Assembling Marks.—The system of assembling marks which follows is in very common use. It has been used in the typical details at the end of the section.

Shop Assembling Marks

Typical letter	Where used
a	For base and cap angles on columns.
b	For bottom seat angles supporting beams and girders, connecting to columns or girders.
c	For base plates, cap plates, and splice plates.
d	For fillers with two or more lines of holes.
f	For fillers with single line of holes.
g	For gusset plates on columns or trusses.
h	For all bent angles and plates.
k	For stiffener angles fitted at one end only, such as angles under beam seats or at column bases.
m	For miscellaneous angles and shapes not covered by the above.

- n* For miscellaneous plates not covered by the above; also tie plates.
- p* For pin plates.
- s* For stiffener angles fitted at both ends.
- t* For top connection angles tying beams or girders to columns.
- v* For purlin clips.
- w* For web members of trusses, laterals in girders or angles in cross-frames unless such material is shipped loose without being connected to any other part.
- y* For lattice bars.

Material that appears on two or more sheets shall be identified as standard pieces. Standard pieces will be identified by the typical letter given under shop assembling marks and a figure, followed by the letter "x." The letter "x" indicates that the pieces are standard. For example, a series of standard stiffener angles, fitted at one end only will be given as "*k1x*," "*k2x*," etc., the letter *k* indicating a stiffener angle fitted at one end only, the numerals 1, 2, etc. being the identifying marks, and the letter *x* making them standard pieces.

For all standard pieces on an order, a summary shall be prepared. This summary must give the number of pieces, size, length, mark, and the sheet number on which the piece is first detailed. All pieces having the same typical letter shall be grouped together as far as possible in the summary, the numbers to follow each other consecutively. Summary sheets shall be numbered consecutively X1 — X2, etc. Summary of standard pieces shall be made for each tier or shipment.

Pieces not standard are pieces that occur only on one sheet. They will be identified by the typical letter given under the shop assembling marks followed by a small letter and the sheet number. For example, the odd seat angle shown on sheet number 1 is marked "*ba1*." The numeral "1," giving the sheet number, should not be given on the drawing; it should only be given in the marking column provided in the shop bill. Hence the angle "*ba1*" would appear on the drawing as "*ba*" and in the shop bill as "*ba1*." Additional seat angles on the same sheet would be marked "*bb1*," "*bc1*," etc. No summary is made for pieces not standard.

All material shipped loose shall have a shipping mark.

The material ordered from the rolling mill must be so noted in the last column of the shop bill.

6. Typical Detail Drawings.—Figures 1 to 6 inclusive are here presented as being typical shop detail drawings of members most frequently met with in building construction. Simple members were selected for these illustrations because of their simplicity but the methods of laying out and arrangement of sketches and dimensions might be studied to advantage and applied to more complicated structures. These methods are typical of modern practice and are easily and quickly applied and readily understood by shop workmen.

Figures 1 and 2 give typical beam details. Where the horizontal distance between holes is omitted, distance center to center is understood to be $5\frac{1}{2}$ in. When the vertical distance between holes is omitted, such distance center to center is understood to be 3 in. These beam sketches are taken from The American Bridge Company's standard and are typical of current practice. In general detailing, which might be used by any shop, it is better to provide the omitted dimensions, size of angles, etc. on the drawing.

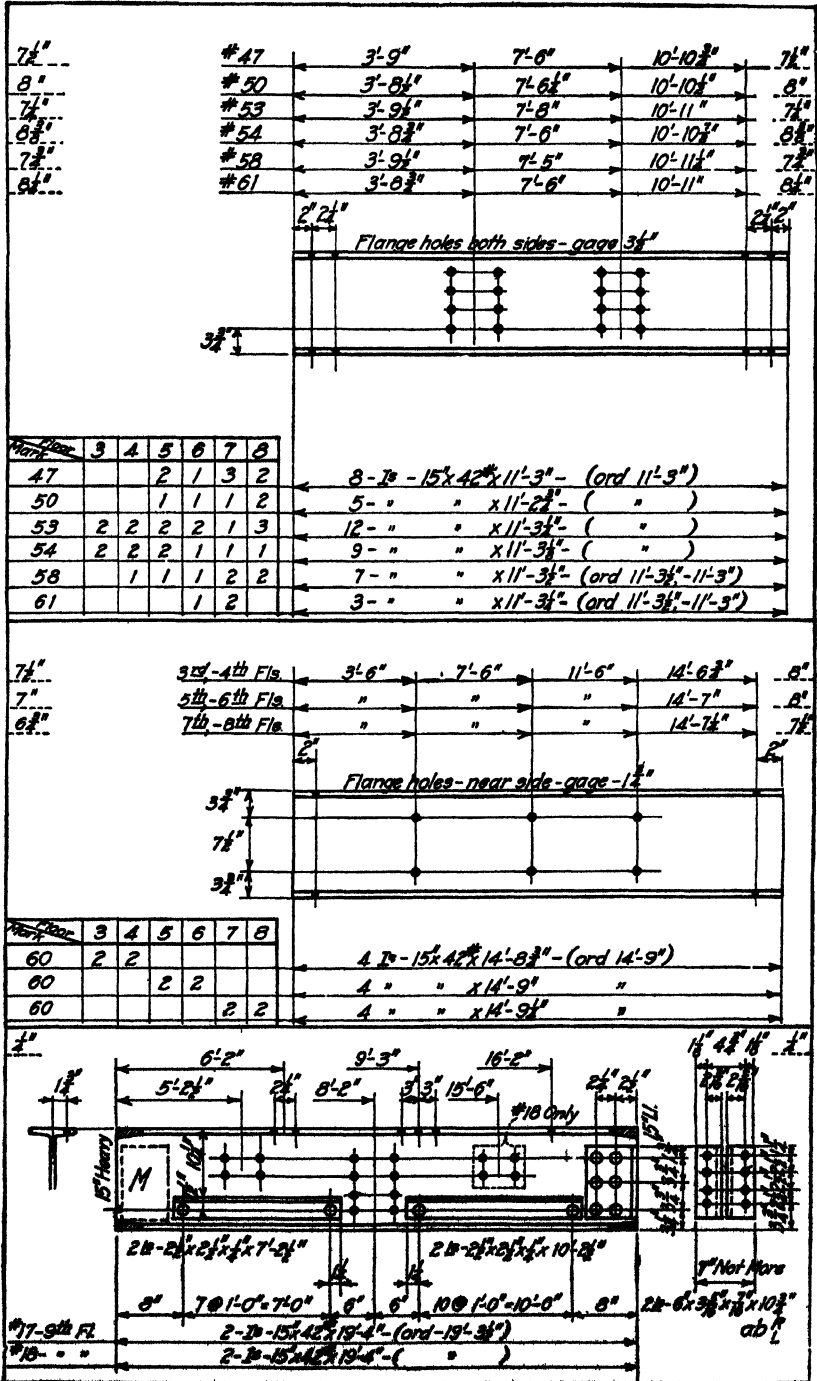

FIG. 1.

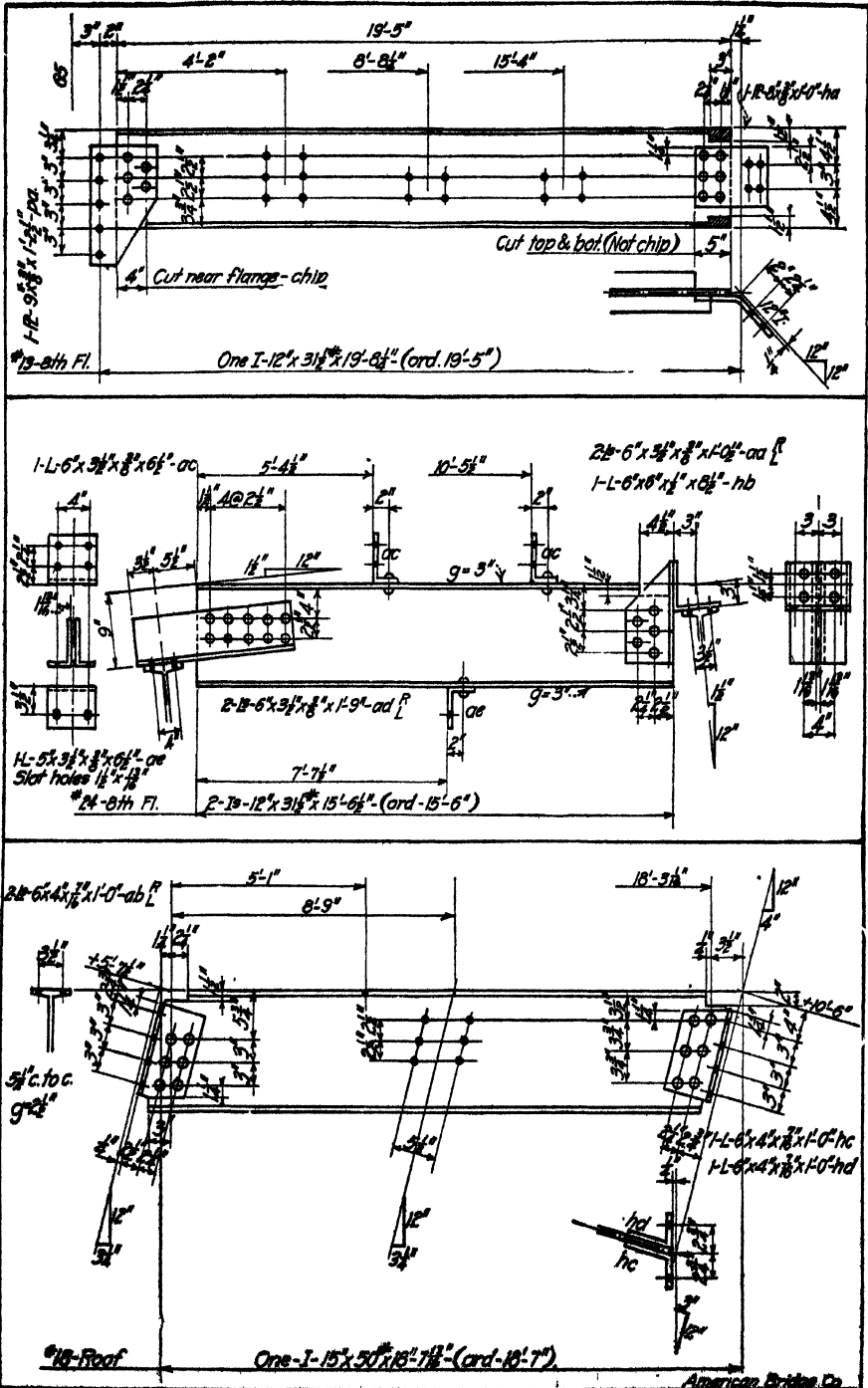

FIG. 2.

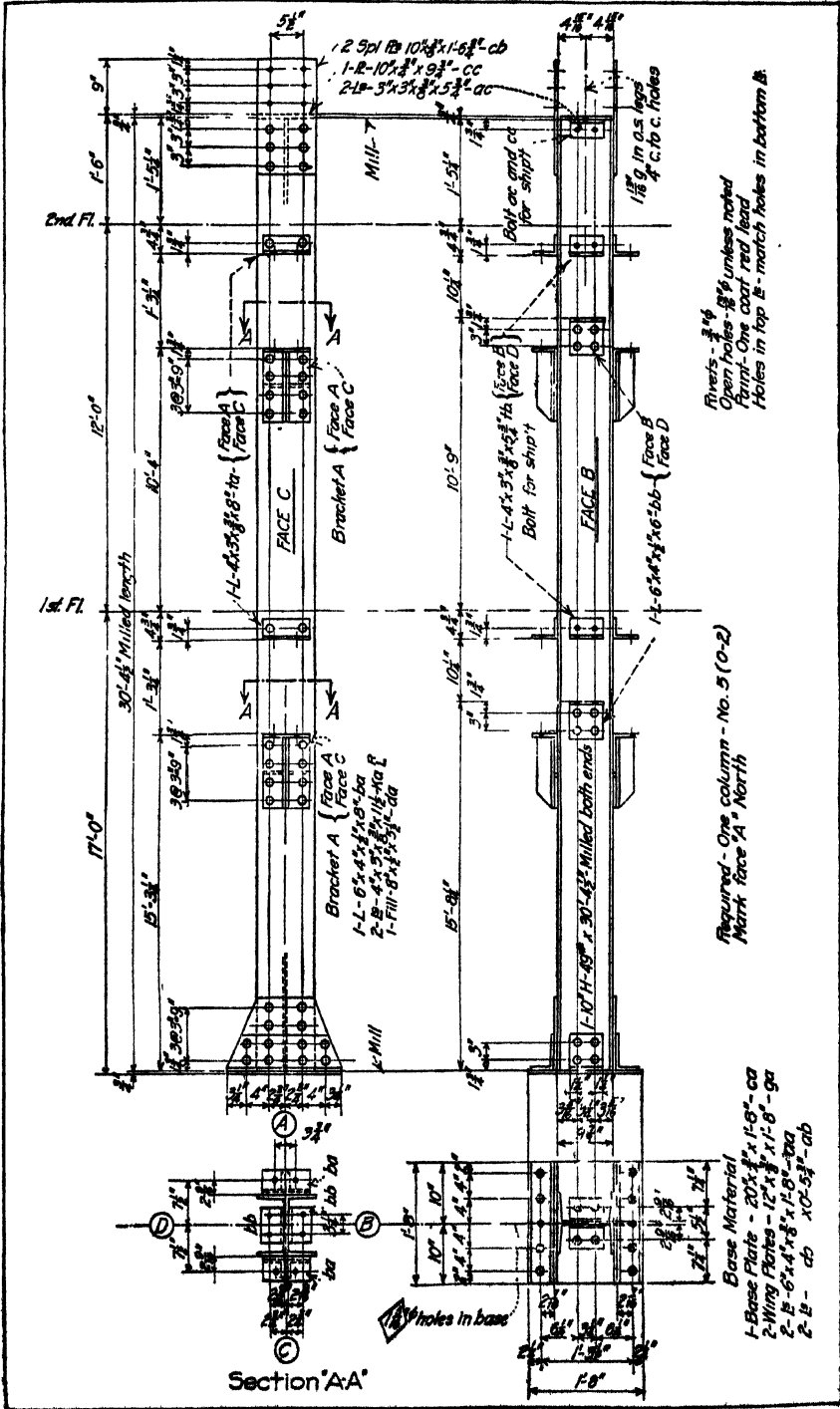

FIG. 3.

Figures 3 and 4 show shop detail drawings of Bethlehem H and built-up mill building columns. Figure 5 is a shop detail drawing of modern roof trusses, and Fig. 6 of a building plate girder. Figures 1, 2, and 5 have been taken from Conklin's "Structural Steel Drafting and Elementary Design."

The details shown in Fig. 5 are those for a series of steel roof trusses for a building roof, the complete connections for purlins, struts, and bracing being shown. Trusses of this type and size are usually shipped in halves, the hanger at center and center bottom chord being shipped loose. Note the open holes to provide for this.

SECTION 8

FABRICATION OF STRUCTURAL STEEL

1. Organization of Structural Companies.—Each company has a different organization and methods for estimating, making bids, preparing shop drawings and fabricating. All of the companies aim to eliminate duplication of work and unnecessary departments with the object of fabricating at minimum costs to meet competition.

The smaller companies operate one plant and maintain a general office where the executive officers are located. The main office handles all of the correspondence for submitting bids and taking contracts. The estimates for new work, designs, and shop drawings are made at the plant.

The larger companies have a general office, sales offices in a number of the larger cities and several plants. Contracts are taken by the executive officers from estimates furnished by the Engineer. Different departments perform the special duties made necessary in handling a large volume of work.

To understand the duties performed by the different departments in their relation to the plant operations, the organization of a large structural company will be briefly described.

The company is divided into three divisions. In each division is a general office, the headquarters of the division officials. The President and other executive officers maintain their offices in one of the division offices.

The contracting department is under the supervision of the Vice-President. In each division is a Division Contracting Manager directing the work of the Contracting Managers who are located in various cities of the division. The Contracting Managers submit bids and take contracts for work which is erected in their territories.

The Chief Engineer is at the head of the engineering department. Under this official are three Division Engineers in charge of the engineering forces in their respective divisions. The Division Engineers prepare designs, make estimates of weights and costs and supervise the work of the Plant Engineers.

The operating department in each division is in charge of a Division Operating Manager. Each of these officials assigns the contracts to a plant in his division best suited for the fabrication of each particular contract, taking into consideration the nature of the work and the time of deliveries. An Operating Manager has general supervision of the operations of his plants. Under his direction are the Plant Managers who are each in charge of a plant.

The auditing department is directed by the Auditor who renders invoices to the customers and compiles all data on costs and accounts of each plant. A Plant Accountant furnishes the Auditor with shipping statements of weights, costs pertaining to each contract, classified costs of shop operations, and the auditing of all accounts at his plant.

The purchasing department under the Purchasing Agent buys all materials and supplies for the company. The purchasing of the structural material is handled separately from that of all other supplies and materials. In each division, the Purchasing Agent has offices for local purchases.

The treasury department under the Treasurer of the company has paymasters at the division offices whose duties are to approve the credits of customers before contracts are signed, collect bills, pay any indebtedness and disburse the salaries and wages of employees. At some of the larger plants, an assistant paymaster handles the payrolls of his plant.

The erecting department under the General Erecting Manager maintains three division offices. Each Division Erecting Manager has charge of the erecting equipment and directs the field forces erecting steel in his division.

The mechanical engineering department deals with all problems pertaining to the fuel, power and machinery of the plants. The Mechanical Engineer has offices in charge of assistants in each division.

The traffic department issues instructions for the routing of all shipments, furnishes information for train clearances, investigates the freight rates and adjusts all claims with the railroads and shippers. Briefly, the traffic department handles all correspondence relating to the shipment of material. The General Traffic Manager is in charge of the department with a Division Traffic Manager in each division.

The duties of the casualty department hardly requires any description. It investigates and handles all cases of injury or death occurring in the shops or field. The General Casualty Manager is assisted by three Division Casualty Managers.

2. Bidding on Contracts.—Before attempting a description of the methods and equipment used in the fabrication of structural steel, the process of bidding on contracts will be described to show the conditions under which the work is taken for fabrication.

The method followed in letting the contract is substantially the same, whether it may be a highway bridge designed by a highway commission, a railroad bridge designed by the bridge engineer of a railroad, or an office building designed by the engineering department of the architect. The design and specifications are submitted to the various bridge companies with requests for bids within a stated time. The time of delivery is given and prices asked for either on the basis of a unit price per pound, a lump sum for the entire structure, cost plus a profit, or cost plus a fixed sum. Generally railroad bridges, large office buildings, and mill buildings are purchased by a unit price per pound. Highway bridges and miscellaneous structures are usually purchased for a lump sum for the entire structure. Sometimes repair work and such structures which cannot be approximately estimated are purchased on the basis of actual cost plus a percentage or a fixed sum. The big majority of contracts are taken on a unit price and lump sum basis. Contracts taken on the basis of the actual cost are comparatively rare.

Upon receipt of the plans and specifications submitted for a bid, the structural companies "set up" an estimate to determine the price to be submitted in the proposal. The various items comprising the estimate are as follows:

Cost of Raw Material.—The weights of plates, shapes and other material having different mill prices are separated and multiplied by the market mill unit prices to ascertain the

cost of the raw material at the fabricating plant. Any mill extras for special sizes, cutting etc., are included in this item.

Cost of Drawings and Shop Work.—The estimate for making drawings and fabricating the steel work are usually included in one item. Obviously the cost is determined by judgment based on similar work fabricated on which actual records of cost were kept. For special classes of work, when there are no precedents of cost available, the different shop operations are estimated to arrive at the total shop costs. Drawing room and shop records are usually kept on a unit basis of 100 lb. thus, \$0.80 indicates that the cost of drawings and shop work is \$0.80 per 100 lb.

Distribution.—This item is often expressed as the "overhead" expense and includes a determined percentage of the actual labor charged to contracts caused by the maintenance of general offices, selling offices and advertising.

Freight.—If the structural company is requested to ship the steel "f.o.b. site"—that is, to the site—this item includes the estimated freight of the fabricated steel from the fabricating plant to the site of the erected structure. If the steel is estimated "f.o.b. plant," the customer pays the freight and the item for freight is not included in the estimate.

Profit.—A percentage of the cost of material, cost of drawings and shop work, and distribution is generally added. This percentage will vary depending upon circumstances. To illustrate, if the structural company had considerable work on hand, the percentage of profit would be larger than if the work was required to keep their shops operating to their full capacity. Again, if the work was not very desirable, the percentage of profit would be high. During dull periods, proposals are often made on the basis of the estimated cost or an estimated loss in order to keep the shop organization intact. It is a recognized fact that a good shop organization takes a number of years to develop and generally it is advisable to suffer a loss in shop operations rather than disrupt the shop organization.

The proposals are submitted by the various structural companies and the contract let to the lowest responsible bidder who can deliver the steel in the required time. Frequently the time of delivery is so important that higher rates are paid to secure quick deliveries.

3. Preparation of Shop Drawings.—When a contract is awarded, the designs, specifications, and all correspondence relating to the contract are sent to the plant assigned for its fabrication. Good designs, specifications and complete information without any subsequent revisions are the ideal conditions for making the drawings quickly and economically with the least chances for errors. Before attempting to order any material, the engineer familiarizes himself with the designs and specifications, noting carefully the time of delivery and such material for which quick deliveries are uncertain. Often, missing information must be obtained before the work may proceed, or it may be desirable to request changes in design or details to simplify the shop work. Sometimes the time of delivery is too soon to permit of any delays in making changes. The judgment of the engineer must always be guided by the circumstances and conditions surrounding the contract.

In the smaller drawing rooms, the work is assigned to draftsmen under the direct supervision of the engineer—in larger drawing rooms, the work is given to a squad foreman who assumes charge of the ordering of material and the preparation of the shop drawings. Layouts of the connections are made when necessary to determine the sizes of the material, the object being to order the material with the least amount of work and still use the layouts for the detail drawings. Where possible, the layouts of connections are made to the same scale (usually 1 in. to the foot) as the detail drawings, to be traced as part of the shop drawing. Complete bills of material are generally made for small structures. For large structures the bills are made out by installments in the sequence of erection.

The bills of material are sent to the order office to be separated and classified for the rolling mills. Thus, 6×6 angles, 12-in. I-beams etc., are grouped together. The mill sheets thus made are used by the mills without recopying. Generally items of small quantity and details, if of standard material, are taken from stock. If the contract calls for immediate delivery, the material is taken from stock as far as possible, substitutions of some of the sections are made to use stock sizes and other sections are bought from available warehouses.

Such material for which quick deliveries cannot be expected are ordered as soon as possible before the detail drawings are started. In this class may be mentioned such material as eye-bars, pins, lomas nuts, pilot and driving nuts, castings, heavy forgings, malleable and other special fittings, checkered plates, rails, gas pipe fittings, buckle plates, special bolts and nuts, large size rivets, large quantities of bolts and nuts, special steel, cold rolled shafting, sheet lead, lumber, sheet steel, corrugated steel and fittings, lag screws, hardware, windows and doors, wrought iron, wire rope and fittings, turnbuckles and clevises.

Detail shop drawings are made to conform to the engineer's designs, suit the shop equipment and practice, and incorporate good details for simple shop work consistent with strength and theory.

When the drawings of a contract have been sufficiently developed to begin checking, one of the more experienced men begins checking and continues until the entire contract is checked and corrections made. On large contracts or for work on which many changes were made or drawings made by inexperienced men, it is customary to supplement the checking with a "field check." This is done by experienced men and includes the checking of shipping marks, number of pieces, over-all dimensions, matching of connections, clearances and possible erection. The checked plans are then ready to be submitted to the customer's engineer for approval if an approval is requested. If the contract requires a large number of drawings or if early deliveries must be made, the plans are sent for approval in two or more installments. Upon receipt of the shop plans, the customer's engineer examines the drawings and returns them to the structural company with his approval or his approval subject to changes or corrections. His examination will depend upon his personal preference. Some make a complete check of the drawings but most engineers are content with checking the general design, sizes of material used and strength of the connections. The structural company is responsible for the correctness of the shop drawings, the approval being merely the authority to proceed with the fabrication.

Shop and shipping bills are written before the drawings are sent to the shop for fabrication.

The shop bills contain a list of all the members on the contract with the material used to fabricate each member, the weight of each individual piece of material, the weight of the completed member, a list of the mill material with item numbers showing the lengths from which the pieces are cut and the sections applied from stock. The shop bills enable the shop to apply the proper material and gives them a list of all the members to fabricate to fulfill the contract.

The shipping bills contain a list of all the shipping pieces with descriptions and shipping marks, gives the over-all dimensions of each member for purposes of identification and includes the figured weights which are used by the shipper as a check against the scale weights.

The number of sets of blue prints of the drawings, shop and shipping bills to be sent to the shop varies according to the size of the shop and the shop routine in handling work. Generally, about six sets of drawings, four sets of shop bills and two sets of shipping bills are sufficient.

At the time the drawings are printed for the shop, prints are sent to the customer for his files and the use of the erectors.

4. Shop Organization.—Shop organization, equipment and the routine of handling work will naturally vary for each shop. Some shops are the outgrowth of many extensions to take care of a growing business and the resulting equipment is not the most economical one. In the building of new plants, engineers have tried different ideas in the layout of buildings and equipments. The usual plan for a small structural plant is to have one structural shop with auxiliary buildings or departments for a forge and machine shop; for the larger plants, there is a large structural shop, possibly a small auxiliary shop for fabricating light material and other buildings devoted to machine work, forge work, founding of castings, etc., or several units of structural shops with an auxiliary shop and such other departments required for the plant production. All equipments, however, are based on handling the mill material progressively from the receiving yard to the shipping yard with the least handling of the material.

The description of the organization and methods for fabricating steel given herewith is typical of many of the larger structural shops. At the head of the organization is the manager who directs the operations of all of the departments. The engineer with his assistants and draftsmen prepares estimates, designs and shop details and handles all correspondence relating to engineering. The order clerks write the mill requisitions, keep records of material received and applied on contracts, have charge of the stock and write shop and shipping bills. The auditor has charge of the time keeping, renders shipping statements and audits the financial affairs of the plant. The paymaster disburses the wages and salaries of the employees of the plant. A rate department makes time studies of different shop operations and sets the rates for punching, fitting, riveting, etc., which enable the men to make bonuses for rapid and efficient work. A storekeeper handles all supplies purchased except mill material and maintains a store room of general supplies required throughout the plant. An employment department secures new men to fill vacancies subject to the approval of the foremen and keeps records of employees with the object of retaining the good men and placing men in the positions for which they are best adapted. Practically all large shops have medical departments for the examination of prospective employees and the treatment of cases of injury.

In the shops, a superintendent has charge of the various departments of the fabrication, each of which is in charge of a foreman and each foreman directs the work of his sub-foremen in charge of the "gangs." The principal departments in a shop are the receiving yard, templet shop, structural shop, possibly an auxiliary shop, a finishing shop, rivet and bolt shop, beam shop, forge shop, machine shop, assembling yard and a shipping yard. The shop inspectors comprise another department for the inspection of the material before shipment. For the repairs and maintenance of the buildings and machines, the installation of new machinery and construction of new buildings, a master mechanic's office is maintained.

Material is rolled at the mills according to schedules—that is, rollings are made of such sections for which sufficient tonnage is ordered. Thus, 15-in. I-beams, 12-in. channels, and 8 × 8 angles of different weights may be rolled for a number of contracts. Chemical and physical tests are usually made by the customer's inspectors. As fast as the material is inspected, it is shipped. While on any one contract, the structural shop may receive a large percentage of the tonnage, generally certain kinds of sections are missing, the lack of which delays the fabrication. The elimination of many varieties of sections and of special sections is a big aid in securing quicker deliveries from the mills.

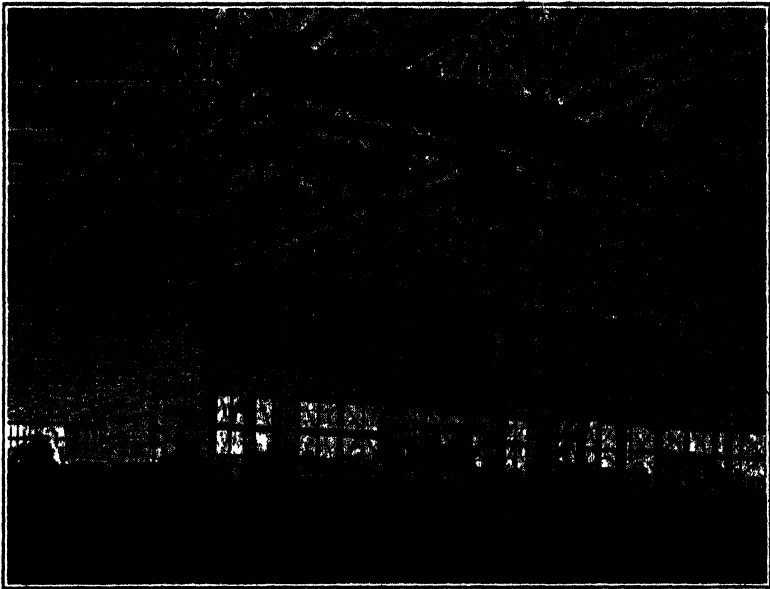

FIG. 1 —Electric crane.

When the material is received at the plant, each piece is checked to see if the size of the section and length agrees with the order. The material is sorted by sections on skids, in piles located conveniently for their transfer to the punches.

The material is moved from the receiving yard to the shops on "buggies." They are small trucks with flat tops and run on narrow gage tracks. Two or more of these buggies are required to support the long material. Usually they are shoved by hand but sometimes electric or gasoline tractors are used for the heavy loads. A "caterpillar" tractor has been used in some cases where tracks were not available.

When a foreman is ready to begin the punching of a section, he "orders in" the material from the yard. If the material asked for is angles, they are sent to the machine noted without trimming; if plates, they are straightened; and if beams or channels, they are sheared or cut to length before being sent to the punches.

The material is taken off the buggies by an overhead crane which travels transversely across the shop and carries the material to any machine required. Cranes are of different capacities depending upon the probable loads to be carried. Receiving yard cranes are comparatively light, 10- to 20-ton capacity being ample. Cranes of about 10-ton capacity are used for handling material over the machines and cranes of about 30- to 75-ton capacity for the finishing shop and shipping yard. Figure 1 is a picture of a 10-ton crane carrying a plate to a punch. The material is fed to some of the machines by jib cranes which lift the material off the buggies directly to the machines. A jib crane is simply a cantilever bracket pivoted to a post. At the extreme end of the bracket is a differential chain hoist, an air hoist or an electric hoist.

The progress of the material through the shops varies according to the material and class of work. Material under 10 ft. in length is called detail material. Such material is sheared, punched, given paint marks for identification and stored in piles near the fitting skids until required for fitting. I-beams and channels are generally sent to a beam shop where they are laid out, punched, coped (if required), fitted with detail material and riveted ready for inspection, painting and shipping. Angles follow the tables of the angle punches. If for single punching, they are laid out, punched, sheared and sent to the fitting skids. If for multiple punching, the laying out is omitted. Plates follow the tables for the plate punches. If single punched, the plates are punched and trimmed and if punched on the multiple punches, they are punched, trimmed on the sides in the multiple punches and the ends are sheared. The plates are then stored in a convenient location ready for fitting.

When all of the materials comprising a member or number of duplicate members are ready, they are assembled together. If reaming is required, the member is first reamed, otherwise the member is ready for riveting. The riveted member is transferred to the finishing shop where the ends are milled, if required. There remains only the inspection and the painting and the member is ready for shipment.

Castings and forgings are finished in their respective shops. Their progress is regulated by the deliveries required for the structural work of the same contracts.

Having a general idea of the routine of handling material through the shops, a more detailed description will be given of the various operations.

5. Templet Shop.—Various methods and devices are used for locating rivet holes, pin holes and cuts on the steel before the material can be sheared and punched. Different shops have different practices for marking the steel, depending principally upon the shop equipment for punching. Generally this is accomplished by the use of templets or by marking the steel directly from the drawings, without the use of templets—a process called *scratching*. If the shop equipment includes machines for punching two holes, a line, or group of holes at one time, wooden strips called *pole strips* are made to locate the rivet spacing. Machines of this kind are called *multiple, rack or spacing punches*.

A templet is made of wood or cardboard or a combination of both to a full size scale. It locates every hole and cut and gives a description and identifica-

tion mark of the piece to be made from the templet. The markings on a templet are somewhat as follows: 4,210, $12L \cdot 4 \times 4 \times \frac{1}{2} \times 2' - 0''$ sa 10, item 61. The number 4,210 refers to the contract number; $12L \cdot 4 \times 4 \times \frac{1}{2} \times 2' - 0''$ covers the number of pieces and description of the steel; sa 10 is the assembly mark of the piece detailed on sheet 10 and identifies the piece from the drawing; and item 61 is the number given to the material when ordered from the mills and enables the shop to use the exact piece of steel ordered.

Templets are made for detail material under 10 ft. long and for such material over 10 ft. having no duplication or when the spacing of the holes is not adapted for multiple punching. However, practically all long material is detailed for multiple punching and requires no templets.

Sometimes a web or other plate is detailed with the majority of holes arranged for multiple punching and the remainder are spaced irregularly. An example of such a case is a web plate for a round end girder. A templet is made of the round end with the holes located on circles and several other holes added which coincide with some of the holes punched on the multiple punch. The plate is first passed through the multiple punch. Then the templet, called a *catch templet*, is laid on the plate with the matched holes coinciding, and the holes in the templet are center punched and then single punched.

Templets for short angles are usually made of cardboard. For the longer angles, the templets are made of wood for one leg and cardboard for the other. Cardboard backs are used for a small quantity of angles and wooden backs for large quantities. Templets for crimped angles are made of wood entirely.

At some plants it is the practice to make the shop plans complete by showing all rivet spacing and complete dimensions, while at other plants the spacing of rivets is not given and many details are omitted to be developed by the templet maker.

Frequently a structure or part of a structure is a complicated design and the details cannot be readily computed. For such cases, much time and expense is saved by sending general drawings to the templet shop, to be "laid out" to a full size scale on the floor. Skew box portals, arches, laterals for crossings on a curve, etc., may be mentioned as examples of this kind of work.

6. Receiving Material.—During the time that the drawings are being prepared and the templets made, the material is received from the mills. As the cars are unloaded, each item is carefully checked against the mill orders for correct length and thickness. Although the material was inspected at the mills, a further examination is made to discover any signs of cracks, pipes, buckles or laminations. If any material is found defective, discrepancy reports are immediately sent to the mills for the replacement of the faulty sections. The inspection at the time when the material is received is quite thorough as serious delays will occur if any of the sections are rejected during the process of fabrication.

The material is sorted and piled on skids conveniently near tracks leading to the machines to which the material is to be consigned. Thus the beams will be placed in line with the beam shears and punches, the angles conveniently for transfer to the angle punches and the plates near the straightening rolls and plate punches.

The longer beams are ordered to the correct lengths required. Shorter beams are ordered in multiple lengths and are sheared before being marked for punching. A sketch showing the method of shearing a beam is shown in Fig. 2. The blade is $1\frac{1}{4}$ in., pierces the web in the middle of the beam and shears outward to the flanges leaving a distorted piece of metal $1\frac{1}{4}$ in. wide. Beams which are heavier

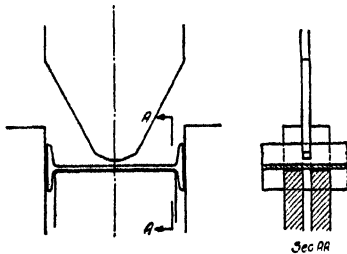

FIG. 2.—Beam shearing.

than the capacity of the beam shears are cut with an acetylene flame, by sawing with a cold saw, or with a friction saw. If it is necessary to reduce the length of a beam by a few inches, the end is usually cut down by "coping"—that is, rectangular punches are coped off of the ends.

I-beams and channels requiring finishing of the ends are sometimes finished to length on rotary planers before being punched. Some examples are I-beam stringers and floor beams, and I-beams

and channels of columns supporting crane girders.

Long angles are usually ordered to the lengths required with allowances of about 1 in. for trimming, the excess being removed after punching. Short angles

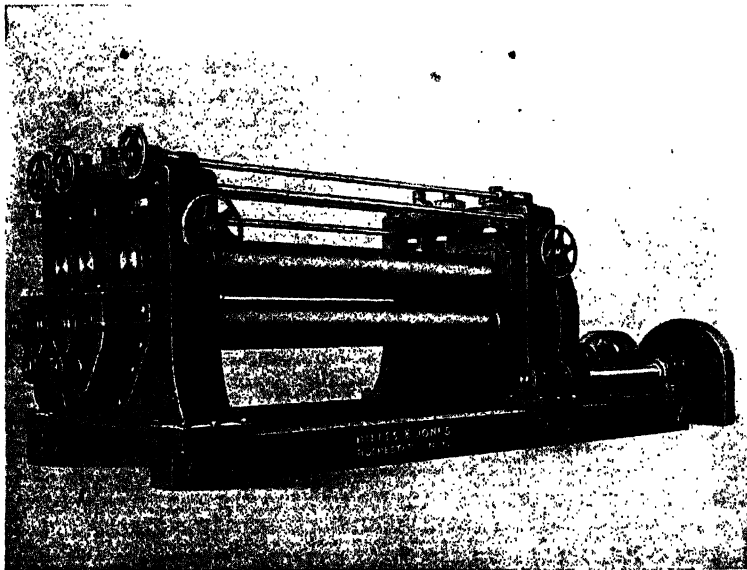

FIG. 3.—Straightening rolls.

are ordered in multiple lengths and generally sheared to the lengths required before punching, but sometimes, when there is a large duplication, the long material is punched on multiple punches and sheared afterwards.

Plates are ordered as *sheared plates*, *U.M. plates* or *sketch plates*. Sheared plates are generally over 48 in. wide with edges "hot" sheared. U.M. plates are called universal milled plates and are made up to 48 in. wide with rolled edges—that is, the edge of the plate is rolled as the plate is rolled. Some mills furnish such plates up to 60 in. Sketch plates are irregular in shape with three or more edges.

Sheared plates usually are received with straight edges but the U.M. plates are generally bowed, the mills being allowed a camber of $\frac{1}{8}$ in. for each 5 ft. in length. The cambered plates are straightened in rolls (see Fig. 3). The straightening rolls consist of two sets of rolls parallel to each other. A filler plate about $\frac{1}{8}$ in. in thickness is placed near the concave edge and as the plate passes between the rolls, the edge is stretched. By repeating this process several times, the plate is straightened.

Long plates are usually ordered to the lengths required without any excess, unless the ends are to be finished. Short plates are ordered in multiple lengths and generally sheared to the lengths required before punching but sometimes, when there is a large duplication, the long material is punched in multiple punches and sheared afterwards. Tie plates for chords and diaphragm plates are examples of plates which often are punched in long lengths on multiple punches.

7. Laying Out.—Material that is not punched on the multiple punches must be marked to locate the holes and cuts. The process of marking the material is called *laying out*. The material required for laying out is ordered in from the yard. When templets are provided, they are clamped to the material and the holes marked with center punches through the templet on the steel. Sometimes, for small pieces, the holes are punched through the templets without center punching. After laying out, the assembly mark and contract number is painted on the piece or pieces and the material is ready to be punched.

Scratching is the process of marking all cuts and location of holes directly from the drawings without the use of templets. Beams having no duplication, plate work with curved intersections and complicated work in general are scratched at less cost than when marked from templets. A good layer-out is necessary to secure the best results with this process.

8. Punching, Reaming and Drilling.—There are two requisites in punching—the punch and the die. Figure 4 is a sketch of a punch, perforated hole, and a die. Note that the hole is larger on the die side than on the punch side, the hole being conical and not cylindrical.

Most specifications will limit the die to $\frac{1}{16}$ in. larger than the size of the punch. Material of a thickness not greater than the nominal diameter of the rivet or bolt plus $\frac{1}{8}$ in. may be punched. If the thickness of the material is greater than the nominal diameter of the rivet or bolt plus $\frac{1}{8}$ in., the holes shall be either drilled from the solid or sub-punched and reamed.

Material over 1 in. in thickness should not be punched but should be drilled from the solid. It is advisable, however, to limit the thickness to 1 in. for main

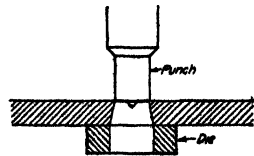

FIG. 4.—Punch and die.

sections, as tests have shown that the ultimate stresses decrease as the thicknesses increase.

A source of trouble to a structural shop is caused by the stretching of the material due to punching under certain conditions. Plates, I-beams and channels do not stretch. The single punching of steel from templets or when the steel has been scratched is commonly called *standard* punching by shop men. When standard punched, the stretch of angles, bars and flats increases the distance

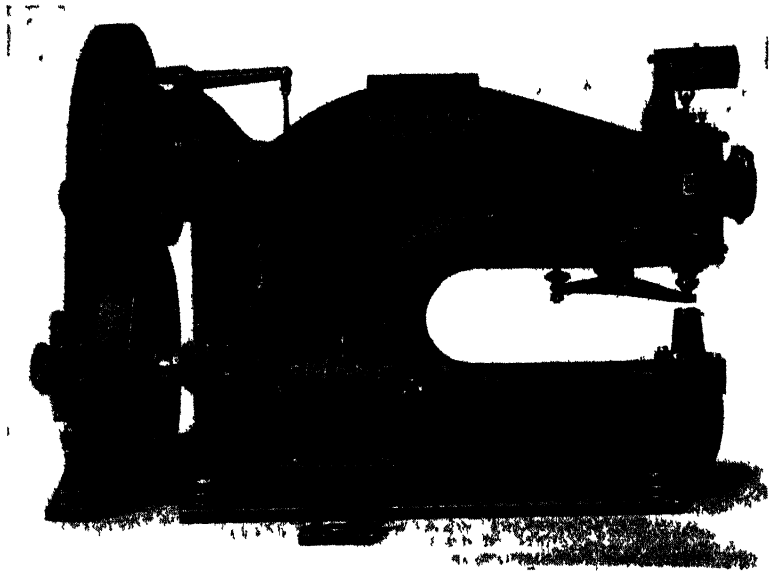

FIG. 5—Standard punch.

between the first and last holes. When angles, bars and flats are “pulled” through punches having stops, the stretch is compensated for by the stops, the distance between the first and last holes conforming to the distance between the stops. If the material was “shoved” through the punches having stops, the stretch would be apparent in the increased distance between the holes. For this reason, the steel is generally “pulled” through the punches. There is also a certain amount of stretch caused by the riveting. The amount of the stretching due to punching and riveting is quite uncertain depending upon the quality and thickness of the material and the number of holes punched and riveted. The shops follow various rules to allow for the stretch in making templets or setting the stops.

Lateral plates, gusset plates, detail material and material which cannot be multiple punched are single punched. When single punched, one hole at a time is punched with the center punches as guides, through paper templets without marking or by means of mechanical stops. A standard punch is shown in Fig. 5. Mechanical stops are often used in single punching for angles or bars of which there is considerable duplication. A variety of these stops are made. One kind

of stop is made up of a guide in which spacing blocks are placed to correspond with the spacing of holes in the steel. The operator inserts a plug consecutively in each slot as the angle moves through the punch. In Fig. 6 is a sketch of these stops (called *Hunter stops*), also of the plug which the operator inserts in the slots.

A horizontal punch, as the name implies, punches in a horizontal direction. This kind is particularly adapted for punching bent work as the material can be swung horizontally. Zee bars also are easily punched on this machine.

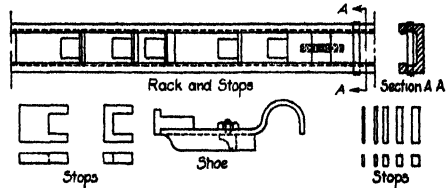

FIG. 6.—Hunter bar.

Washers and lacing bars are punched on a single punch with special dies and punches. Each washer including the hole is perforated out of a plate with one punch and die. Lacing bars are made by punching out the material between two bars, making the ends circular with the same stroke that punches the holes near the ends.

A type of single punch which is used for punching large quantities of small plates and angles is the *Weatherson spacer*. The first plate is punched on an ordinary punch from a templet, and the steel plate is then used for punching the remainder of the plates. The blank plate is clamped under the punch and the guide plate is clamped alongside of it under a dowel. By rolling the table backwards, forwards, or sidewise, the dowel is dropped in each hole of the guide plate and simultaneously trips the machine which punches the corresponding hole in the blank plate. Figure 7 is a diagram illustrating this method of punching. The process is rapid and insures accurate work.

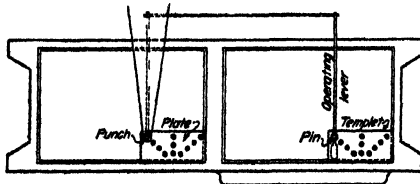

FIG. 7.—Weatherson spacer.

Multiple punches, also known as *rack* or *spacing punches*, differ greatly in capacities but they are all based on the same principle. The punches in the machine are set to locate the holes transversely to the travel of the material. Guide strips or stops determine the holes longitudinally. Web plates of girders and chords, cover plates of girders and columns, and flange angles belong to the class of material which is usually punched on multiple punches. Two or four angles in pairs are often punched at one time and sometimes two or more narrow plates laid side by side are punched on the larger punches.

In detailing any material for multiple punching, the draftsman provides a minimum space of $2\frac{1}{4}$ in. center to center of holes in the transverse direction, which distance is limited by the closeness with which two punches can be set and a minimum space longitudinally of about $\frac{1}{2}$ in. if "pole" strips are used, or $1\frac{1}{2}$ in. if mechanical stops are used. Pole strips are made of wood $3\frac{1}{2}$ or 4 in. wide and $\frac{3}{4}$ in. in thickness. The top of the wood is marked to indicate the longitudinal spacing of the holes. The marks are made either on the wood

directly or on a white painted surface. In the latter case the wood is used for other work by repainting and removing the old marks. On some punches, the material is pulled through the machine by turning a wheel until the index stops at each mark consecutively on the pole strips, the machine punching the required

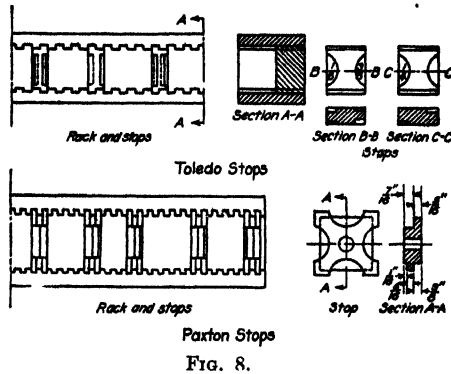

FIG. 8.

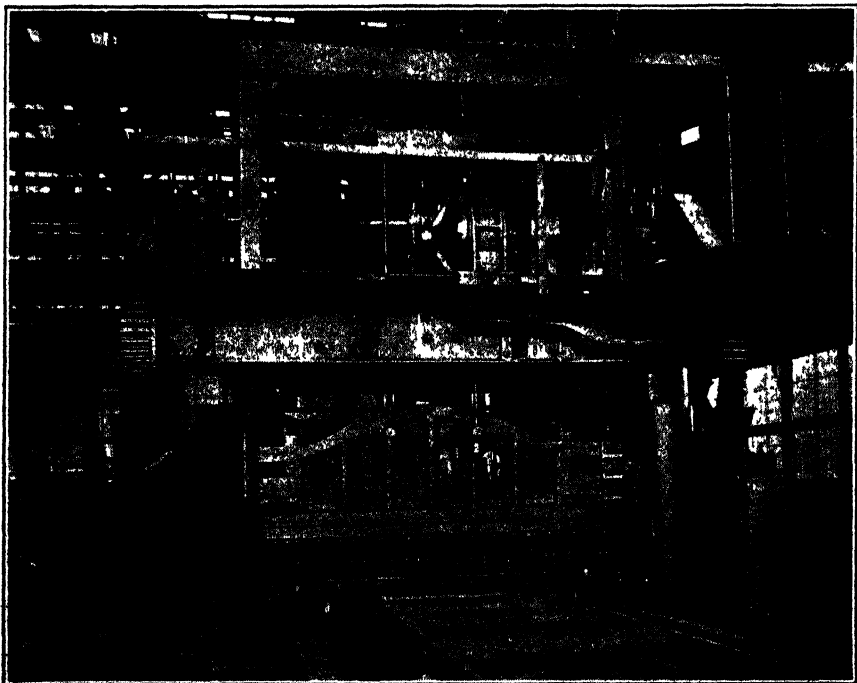

FIG. 9.—Multiple punch.

holes in a transverse line each time the index stops. On other punches, the pole strips are used to set mechanical stops which automatically trip an electric carriage pulling the material through the punch. Two types of stops are shown in Fig. 8. The first sketch shows the Toledo stops which consist of rectangular

stops fitting between two racks whose teeth have a pitch of $\frac{1}{2}$ in. Variations in the rivet spacing must be in multiples of $\frac{1}{4}$ in. Special shaped stops are required if the spacing contains $\frac{1}{8}$ or $\frac{1}{16}$ in. The second sketch shows the Paxton stops which consist of square blocks also fitting between two racks, with teeth of $\frac{1}{2}$ -in. pitch. By turning the blocks 90 deg. at a time, variations of $\frac{1}{8}$ or $\frac{1}{16}$ in. in the spacing of holes are obtained.

A picture of a multiple punch is shown in Fig. 9. This particular machine is capable of punching a plate 120 in. wide. The punches are set up at the correct distances center to center to agree with the spacing of the holes on the drawing. The punches are connected on "gags" so that all or a group of the punches will penetrate at one stroke; besides any one of the punches can be operated alone by tripping a lever on the punch wanted. If a web plate is being punched, the first line of holes for the end post angles are punched by tripping one gag, the holes for the flange angles by tripping another, and so on. This punch is equipped with 6-in. shear blades which trim one or two edges of the plate simultaneously with the punching.

The multiple punch is most profitable for punching large quantities of plates which are identical. Generally it pays to set up the stops for four or more plates which are alike. It sometimes occurs that the transverse spacing for different plates is the same, and such plates are handled on the multiple punches by changing the stops only.

For plates of large duplication having a uniform pitch of holes—as, for example, on tank work—tandem blocks of punches are sometimes used which will punch from 6 to 8 holes longitudinally on two edges at one stroke. A diagram showing how the punches and tandem blocks are set up is shown in Fig. 10. The punches between the tandem blocks punch the end connections and the 7 punches in each block punch the holes longitudinally. If the punches are 3 in. apart as shown in the diagram and $1\frac{1}{2}$ in. spacing is required, the 7 holes are punched 3 in. center to center; the material is moved forward $1\frac{1}{2}$ in. and 7 more holes punched; the next movement is $1\frac{1}{2}$ in.; and the operation is repeated for the length of the plate.

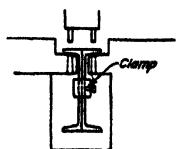

Fig. 11.—Flange punching channels in pairs.

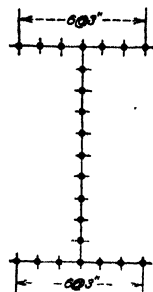

Fig. 10.—Tandem punching.

Sometimes on tank work, the plates are laid "shingle" fashion, each plate being part of a cone. The end holes are in lines coinciding with the elements of the cone and the holes along the edges lie in circular lines with different pitches for each line. Conical plates can be punched on a multiple punch by skewing the beds on each side of the punch which permits pulling the plates with a slight circular motion.

Generally three operators are required for one multiple punch—one at the punch, one at the carriage and one getting the material ready. At least in one instance a method to eliminate the operator at the carriage is used by having the carriage controlled by the punch operator. By pressing a push button, he releases the carriage to travel the length of the next space. A number of colored

lights are attached to the punch to notify the puncher of any change in the transverse spacing. If one color flashes, it indicates that the carriage has stopped where an outside stagger is wanted, if another color, an inside stagger is wanted, another for a line of stiffener holes, etc.

Another type of multiple punch is one employing the use of a perforated paper roll for locating the holes similar to the principle of operating a mechanical piano player with a music roll.

A press has been rigged up at one structural shop with punch and die blocks for punching all of the holes in a plate at one stroke. Such a device naturally is only profitable when there is a very large quantity of plates to be punched. This may be regarded as special equipment to take care of special work.

There are different ways of punching beams and channels. The I-beam flanges are either single punched or punched in a machine set up with two punches so that one or two holes transversely are punched at one stroke. The channel flanges are single punched or placed in pairs and the two flanges punched at one stroke. Figure 11 is a sketch showing this method of punching the flanges of two channels. The webs of I-beams and channels are single punched, transverse groups punched at one stroke, or an entire standard connection punched at one time. A method of locating the holes without marking has been used and is called *taping*. A tape with the longitudinal spacing of the holes is hooked to the I-beam or channel and determines when the material is stopped for punching. The punches are set up from the drawing and fix the location of the holes transversely.

Angles, flats, zee-bars and tees will be bent or bowed somewhat due to the punching. Before the bent material is ready for fitting, it is straightened on a machine called a *bull-dozer* which consists of a horizontal ram pressing the material against two supports.

The workmanship specified for structural steel is usually of two kinds, *punched work* and *reamed work*.

Punched work is generally used for building work, light highway work and secondary members of railroad work. The holes are punched full size which is $\frac{1}{16}$ in. greater than the nominal diameter of the rivet. When three or more thicknesses of material are assembled together, the holes will not match perfectly, and it is the practice in some shops to pass a reamer of the same size as the punch through the holes to freely admit the hot rivets and facilitate the riveting. This process is called *spearing*.

Reamed work is generally used for the important members of railroad work, heavy highway work and structures with large stresses. The holes are sub-punched $\frac{1}{16}$ in. smaller and reamed to $\frac{1}{16}$ in. larger than the nominal diameter of the rivet. Thus, if the size of the rivets is $\frac{3}{8}$ in., the holes are sub-punched $1\frac{3}{16}$ in. and reamed to $1\frac{5}{16}$ in. The sub-punching and reaming serve the two-fold purpose of removing the torn material caused by the punching and securing perfectly fair holes for the riveting.

A picture of a reaming gantry is shown in Fig. 12. There are electric reamers which are pivoted and can reach all of the holes vertically in the material lying on the skids.

Bracket reamers are electric reamers attached to walls and pivoted to have a circular movement. Small members and small pieces which require reaming are reamed by these machines.

Portable electric reamers are used for such reaming which is inaccessible under the gantry or for the connections of truss members which are reamed after assembling.

Drilling from the solid is necessary to provide holes in castings, in some of the alloy steels, and in material the thickness of which is more than permissible for punching.

Cast steel with a carbon content of 0.25 to 0.40 of 1 per cent can safely be punched up to 1 in. in thickness with a $1\frac{5}{16}$ -in. punch. Cast steel of greater thickness and all cast iron must be drilled.

The alloy steels vary as regards punching and drilling. O. H. silicon steel with a carbon content of 0.40 of 1 per cent can be punched up to $\frac{7}{16}$ in. inclusive

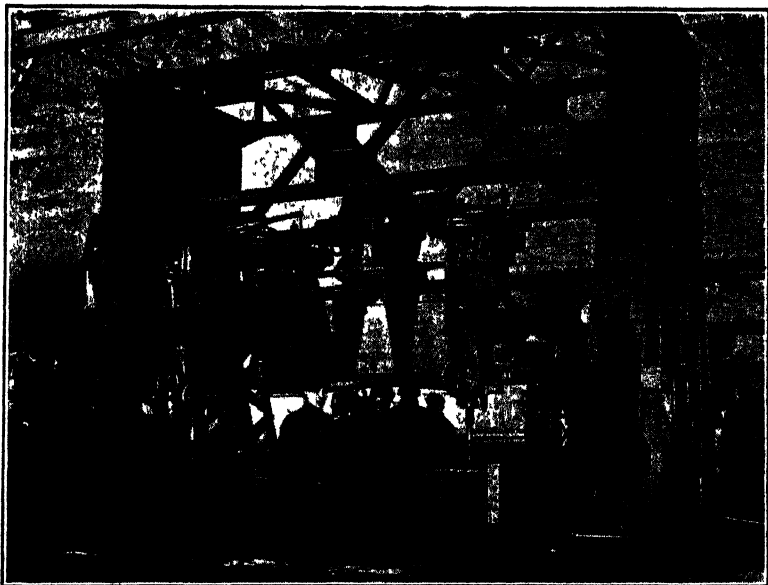

FIG. 12.—Reaming gantry.

in thickness and must be drilled for greater thicknesses. Nickel steel having about 3 per cent nickel can be punched. The cast phosphorus bronze metals must be drilled. Manganese steel can neither be punched or drilled, any holes required must be "cored" holes. A cored hole derives its name because of the fact that a core of baked sand is placed in the mould where the hole is required and after the metal is poured to make the casting, the core is removed leaving a hole in the casting.

Specifications vary in regard to the thicknesses of carbon steel which must be drilled, but tests made indicate that material may be punched whose thickness does not exceed the nominal diameter of the rivet. Thus, for full size punching in 1-in. material, the size of the punch may be $1\frac{1}{8}$ in. for 1-in. rivets; for sub-punched and reamed work, the size of the punch is $1\frac{5}{16}$ in. and the holes reamed $1\frac{1}{16}$ in. for 1-in. rivets.

Machines for drilling are stationary or portable. The stationary ones have either fixed or radial spindles. The portable drills are serviceable in drilling large members which cannot be conveniently moved to a stationary drill.

A picture of an eight head multiple drill is shown in Fig. 13. The material is center punched from templets or center punched on a multiple punch. After

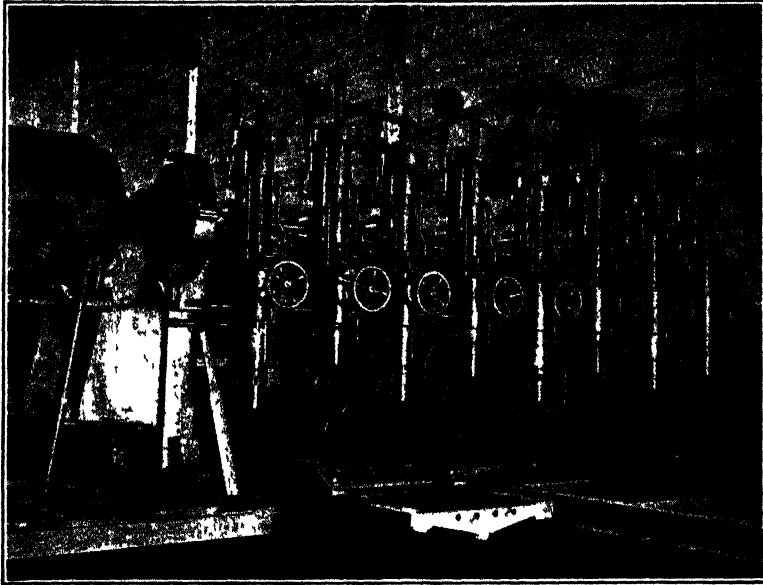

FIG. 13.—Eight head multiple drill.

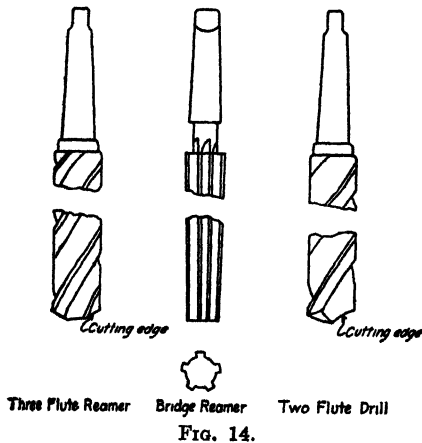

FIG. 14.

marking, the material is clamped to a bed which is electrically driven moving the material under the drills.

Three flute reamers are used in reaming holes in sub-punched and reamed work. The cutting edge is on the bottom of the tool as shown in the sketch. With this tool, the reaming is concentric with the first hole.

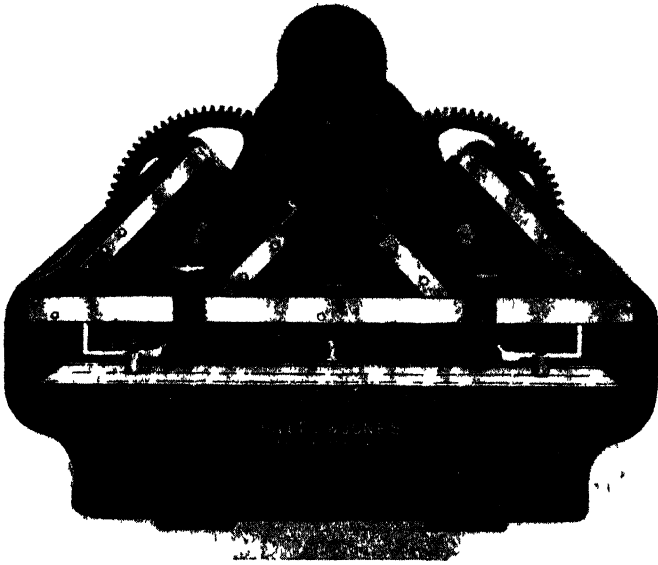

FIG. 15 Angle shear

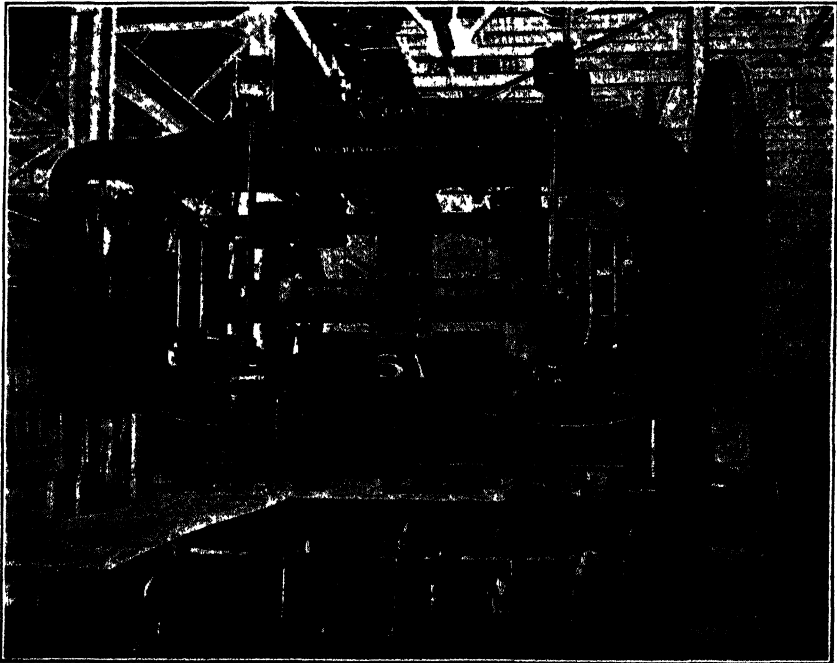

FIG. 16.—Gate shear.

Five flute reamers, called *bridge reamers*, are used generally for portable reaming and for "spearing"—that is, for cleaning out of full size punched holes to secure fair holes for riveting. As the sides of the reamer cut the material, the tool removes the interfering metal only with the least amount of slotting.

Two flute drills are used for drilling from the solid. The reamers and drill are shown in Fig. 14.

9. Shearing, Coping, Burning, Sawing and Various Operations.—The four processes of cutting steel are by shearing, coping, burning and sawing.

There are different kinds of machines for shearing angles, plates, flats, bars, rounds, tees and zebs.

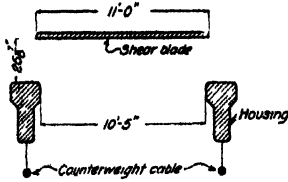

FIG. 17.—Diagram of 10-ft. 5-in. gate shears.

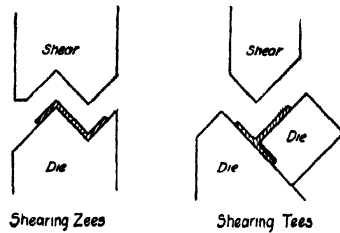

FIG. 18 -- Zee and tee shears

An angle shear cuts both legs at one time with either square or bevelled ends. For cutting ends on a bevel, the machine is rotated rather than have the material inclined obstructing tracks and walkways. A picture of an angle shear is shown in Fig. 15.

Plate shears are of various sizes and capacities. A plate shear with a 24-in. shear blade is known as a 24-in. *plate shear*. If the machine is made to rotate for cutting plates on a bevel, it is known as a *rotary shear*.

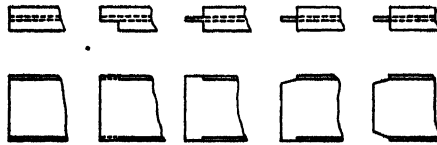

FIG. 19.—Coping I-beam.

A gate shear has the housings set back from the shear blade so that long plates may be sheared by moving the plate in the direction of the blade. A picture of a gate shear is shown in Fig. 16. The limiting sizes of plates that can be sheared and a cross-section of the blade and housing is shown in the sketch, Fig. 17. The capacity of this machine is limited to shearing a plate not exceeding 102 in. wide and $1\frac{1}{4}$ in. in thickness.

Bar shears will cut rounds, squares and flats. The ordinary shear, though, is limited to capacity up to $2\frac{1}{2}$ in. for rounds, 2 in. for squares and $6 \times 1\frac{1}{4}$ in. for flats.

Zees and tees are sheared on a punch equipped with special dies and shear blades. Diagrams of these dies and shears are shown in Fig. 18.

Coping machines are operated on the same principle as punches, the cutting tools being of various shapes. All cuts are made by "blocking out" small pieces at a time. Thus if it is desired to cope the end of a 15-in. beam to clear another 15-in. beam to which it frames, each flange is removed and finally the parts of the web as desired. A diagram of the various cuts necessary to cope a beam is shown in Fig. 19. Similarly, the ends of beams, channels, angles, zeos and tees are coped when it is desired to shorten their lengths.

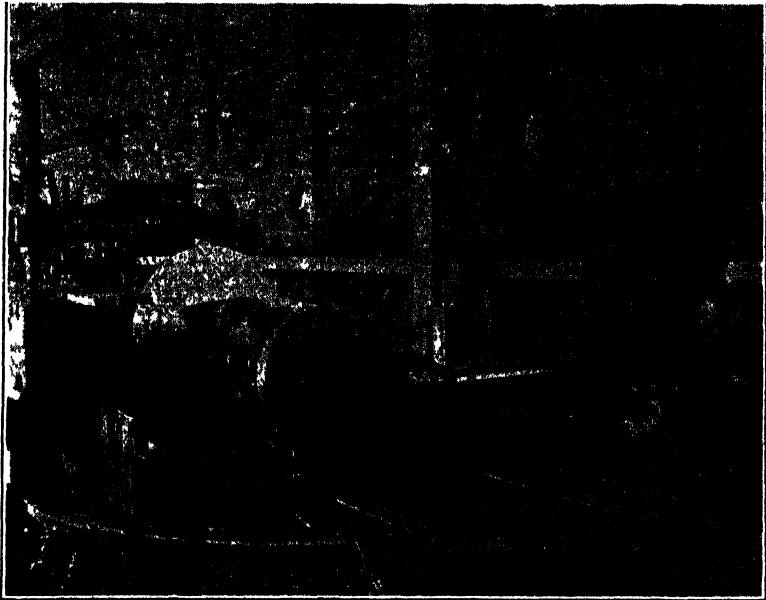

FIG. 20.—Cold saw.

In recent years, cutting material by means of the acetylene flame has been largely used. The acetylene flame is produced by combining oxygen and acetylene gases under pressure in a torch. The flame readily penetrates thicknesses of steel up to about 12 in. making a "cut" about $\frac{1}{4}$ in. wide. Scleroscopic tests have been made showing that the material adjacent to the burned cut is not injured by the use of the flame. The use of the torch is of great importance in cutting heavy slabs and forgings, cutting members apart for repairing or wrecking, cutting shapes which are beyond the capacities of the shears, making re-entrant cuts, burning out pin holes preliminary to boring, burning holes and reaming out for rivet holes as a substitute for drilling and for welding purposes. A motor driven instrument, called a *radiograph*, is sometimes used in connection with a torch to direct the torch in straight lines or curved lines with uniform cutting speed. By means of templet guides, almost any desired curve may be obtained.

Steel is sawed while cold as in a structural shop, or while hot as is usual in a rolling mill. The two methods are known as cold and hot sawing. In the ordi-

nary type of cold saw, the saw is a circular disc to which adjustable teeth of tempered tool steel are fitted. A picture of a cold saw is shown in Fig. 20. To some extent, the process of sawing has been superseded by that of burning due to the high cost and slowness of sawing compared with that of burning. High speed friction saws are also used in some shops for sawing. The saw is a disc of high grade tempered steel without teeth, rotating at a very high speed. The saw literally burns its way through the steel it is cutting.

A machine for planing the edges of plates is shown in Fig. 21. The plate is securely held in place by the clamps on the segmental girder, then a tool travels the length of the plate planing the edge. The edge planer illustrated will plane edges 30 ft. long with one setting. Longer lengths of plates can be edge planed by shifting the plate lengthwise

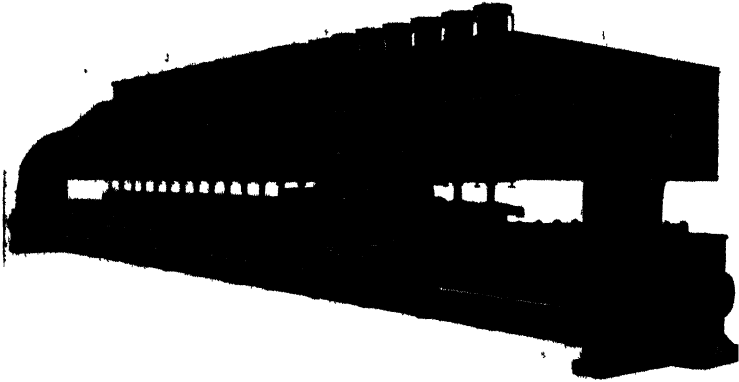

FIG. 21.—Edge planer.

In small shops, stiffeners which fit the fillets of flange angles are chamfered by grinding. In large shops, the stiffeners are sheared or milled to the exact length and chamfered on a machine. The cutting tool travels vertically, has two circular cutting edges and chamfers a pair of angles at one end with one setting. There are chamfering machines which also mill the ends as well as chamfer them during the same operation.

Plates for water tanks, oil tanks, and other work, which are riveted up to be oil or waterproof, must be caulked in the field along the exposed edges outside of the tank or on top of the bottom plates. Edges which are caulked are usually sheared on a bevel to render the caulking more effective. A diagram showing a plate passing between the wheels of a bevel shear is shown in Fig. 22. After the plates are bevel sheared, devices called *kick-offs* are sometimes used to throw the plates off the shear bed on to a pile in front of the shear. The "kick-offs," of course, save extra handling by cranes. Figure 23 is a sketch of one of the kick-offs which is simply a set of arms operated by small air cylinders.

The corners of the plates are scarfed in three different ways. In the first two methods, the ends are flattened under a pneumatic hammer when the steel is cold or when it is heated. Usually the plates are hammered cold up to about $\frac{5}{8}$ in. in thickness and the corners heated for scarfing over this thickness. The third method is called machine scarfing. The plate is clamped in an inclined position to give the correct angle for the scarfing. Two vertical milling cutters travel over the corners removing the material to form two scarfs.

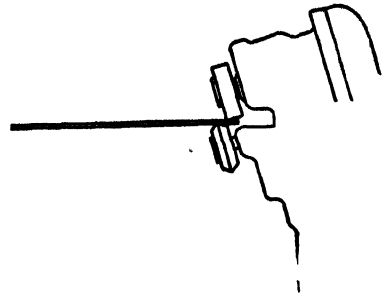

FIG. 22.—Bevel shearing plates.

Plates which require counterboring for countersunk rivets are laid on the floor and the holes counterbored with a counterbore buggy. This device is simply an electric drill fitted with a counterbore tool and mounted on two wheels. The operator moves the buggy from hole to hole and counterbores the holes by inserting the counterbore in each hole and pressing down on the handle. A sketch of a counterbore buggy is shown in Fig. 24.

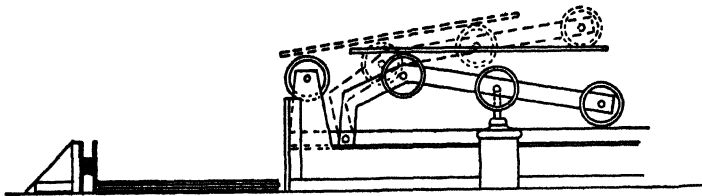

FIG. 23.—Kickoff for plates.

10. Fitting.—After the detail pieces and main material of a member or duplicate members have been punched, sheared and straightened, the next process is that of “fitting” or the assembling of the various parts of a member in condition

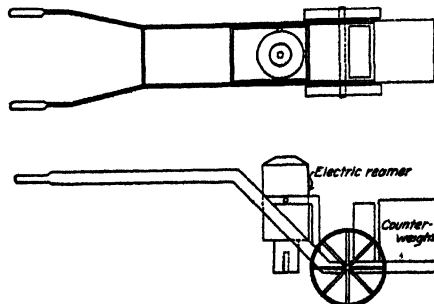

FIG. 24.—Counterbore buggy.

for riveting. All of the pieces are fitted by direct reference to the shop drawings. The main sections are identified by the description painted on the steel and the detail material by the assembly marks given on the drawings and painted on the pieces.

Before putting material together, the burrs around the rivet holes are removed and all of the surfaces in contact are given a coat of paint, usually the same kind of paint which is used for the exterior surfaces. The exception to this is that sometimes for material embedded in concrete, the fitting up paint is omitted.

Fitting-up bolts are used to hold and draw the material tightly together, one bolt being used about every 3, 4 or 5 ft. depending upon the number of thicknesses to pull together. If the holes are $1\frac{3}{16}$ in. or $1\frac{5}{16}$ in. in diameter, $\frac{3}{4}$ -in. fitting-up bolts are used, if $1\frac{1}{8}$ -in. $\frac{5}{8}$ -in. bolts are used. The larger size bolts are always desirable to pull the material together more tightly. When deciding upon the size of rivets to be used, this feature should be considered to give the shop the advantage of using fitting-up bolts of sufficient size.

For light work, sometimes, wedge bolts are used instead of the ordinary fitting-up bolts, as it was found that the wedge bolts can be inserted in the holes and locked in less time than it takes to insert the threaded bolts and put on the washers and nuts. Wedge bolts are simply unthreaded bolts with rectangular slots in them through which wedges are driven to bring the assembled pieces together. Their use, however, is limited to light work as they do not exert as much pressure as the threaded bolts.

After a member is fitted, it is sent to the reamers for spearing if the holes were punched full size or for reaming if the holes were sub-punched. If any counter-sunk rivets are required, the counterboring of the holes for such rivets is also taken care of by the reamers.

Plate girders are fitted up in a vertical position. The top and bottom flanges are assembled with their cover plates, separators being used between the angles to allow for the web thickness and the holes in the cover plates speared or reamed if required. The complete bottom flange is laid on the skids and the web plates inserted between the angles, followed by fitting on the splice plates, fillers and stiffeners on the web plates and finally the top flange is dropped down over the web completing the fitting of the girder. Small details (if any) are added and then the girder is sent to the reamers to have the web holes speared out or reamed if required.

Fitting up is probably the most difficult and responsible of any work in a structural shop. Great care must be used to maintain important dimensions and the various pieces must be correctly assembled. Any errors made by the fitters cannot be detected until inspected after the work is riveted or in the field. At this stage of the fabrication, the correction of an error is expensive.

11. Riveting.—The various methods of riveting may be divided into three general classes, stationary riveters, portable riveters and hand riveters. The method employed in driving rivets is governed by the size of the member, accessibility for riveting and the shop equipment.

When riveting in a stationary riveter, the material is brought to the riveter and all rivets driven which are in a vertical plane, the riveter driving horizontally. Figure 25 is a picture of a stationary riveter operated by electric power in connection with a gantry for moving the material. The operator at the riveter controls all of the movements—that of the riveter driving the rivets, the raising and lowering of the riveter, and the travel of the gantry which moves the material.

A type of stationary machine used only to a limited extent is the electric riveter. The essential feature of this machine is a large screw which is operated by a motor and furnishes the pressure for driving the rivets.

A portable riveter of the kind in common use in structural shops is shown in Fig. 26. Its shape gives it the name of horseshoe riveter. The jaw is 21 in. and the throat 36 in. for the riveter illustrated. These figures indicate that the riveter will reach over a member 21 in. wide to a depth of 36 in.



FIG. 25.—Hanna riveting gantry (Courtesy of Hanna Engineering Works).

In former years when steel construction was in its infancy the heads of field rivets were formed with hand sets and a sledge hammer. Rivets driven in this way were called *hand rivets*. The hand sets and sledge hammers have been superseded by pneumatic hammers but the name hand rivets is still retained for those driven by a pneumatic hammer. Besides being used for field rivets, hand rivets are used in structural shops for rivets which are inaccessible for the stationary and portable riveters. Hand rivets, as far as possible, should be avoided in the details as they are more expensive to drive than the *machine rivets* driven by the stationary and portable riveters. In Fig. 27 are sketches of two pneumatic hammers, the long one being 26½ in. in length and the short one 21½ in. The figures indicate the space required on the driving side necessary for driving hand rivets. The space required for "bucking-up" the rivets is considerably less—5 in. being about a minimum—but of course, ample room will give better facilities for driving.

The outside burrs around the holes are removed before riveting is begun. A long handled tool called a spudding bar with a triangular shaped cutting edge is used for scraping off the burrs. The process is called *spudding*. On some classes of work, the edges of the holes under the rivet heads are filleted. The fillets are made with a tool similarly to counterboring or the edges are chamfered with a hand tool.

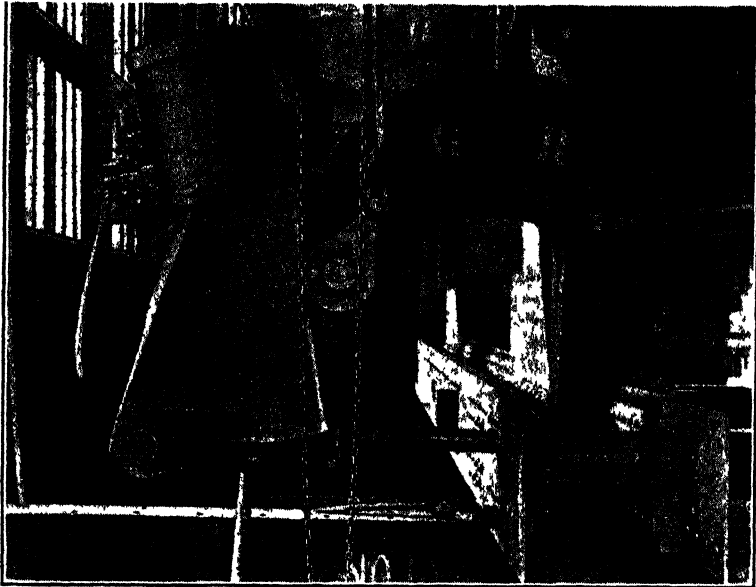

FIG. 28.—Horse shoe riveter.

Stationary, portable and pneumatic hammer riveters are generally used in riveting up ordinary girders. The girder is sent to the stationary riveter, stitch rivets are driven at intervals of a few feet and all fitting up bolts removed, after which all of the rivets through the web are driven. Then the girder is laid flat on skids and the accessible rivets in the cover plates driven with a horseshoe riveter. The girder is turned over and the remaining half of the cover plate rivets driven. The riveting is completed with a pneumatic hammer by driving such rivets around stiffeners, etc., which were inaccessible for the horseshoe riveter.

Rivets are driven with full heads and with flattened heads. Flattened heads should be $\frac{3}{8}$ in. high for $\frac{3}{4}$ -in. rivets and over and $\frac{1}{4}$ in. high for $\frac{1}{2}$ - and $\frac{5}{8}$ -in. rivets. Heads $\frac{1}{8}$ in. high and countersunk heads require counterboring. In both cases the rivet heads are driven $\frac{1}{8}$ in. high and chipped flush with the metal when countersinking is required.

Rivet sets for driving the full heads and flattened heads of rivets are shown in Fig. 28. Dimensions are not given as they vary for different sizes of rivets.

There is a countless variety of dolly bars for bucking up rivets. The different shapes are required to suit the small openings and long reaches in which rivets

must be inserted and bucked up for driving. Three different kinds of dolly bars are shown in Fig. 29. A pneumatic buckler-up, such as shown in Fig. 30, is used frequently where space will permit and has proven very satisfactory in securing tight rivets. The buckler-up is adjusted with a gas pipe extension to the correct length for bracing against the rivet, the compressed air exerted pressing the set against the rivet while the head is being formed on the driving side.

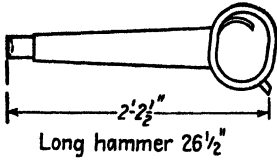

Long hammer 26 1/2"

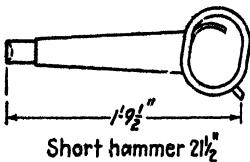

Short hammer 21 1/2"

FIG. 27.—Pneumatic hammers.

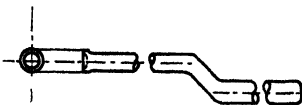

FIG. 28.—Rivet sets.

Rivets are generally driven cold up to 3/16 in. inclusive. Cold driven rivets are made of soft steel, the driven head being smaller than those driven hot. Seven-sixteenth-inch rivets as a maximum for cold driven rivets may be regarded as general practice for structural shops but this size is often exceeded in field practice according to circumstances. Rivets as large as 1 in. in diameter have been driven cold when the presence of explosives, gases or gasoline prohibited any fire in the vicinity.



Heel Dolly Bar



Goose Neck Dolly Bar

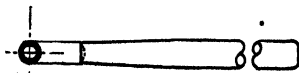

Straight Swing Dolly Bar

FIG. 29.—Dolly bars.

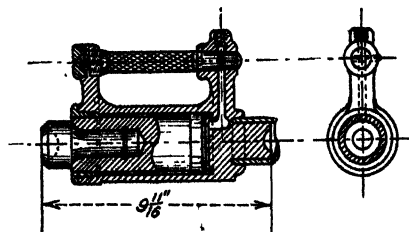

FIG. 30.—Pneumatic buckler-up.

as rotary planers, chord boring machines, ordinary planers, electric furnaces and air for driving hand rivets, hand reamers, etc.

The rotary planers are used for planing the ends of columns, chords, I-beams, stringers and floor beams to secure finished surfaces for bearing, square ends and members of the correct length. A rotary planer mills off the end of the member which is clamped to a bed. A large disc has small cutting tools on its periphery

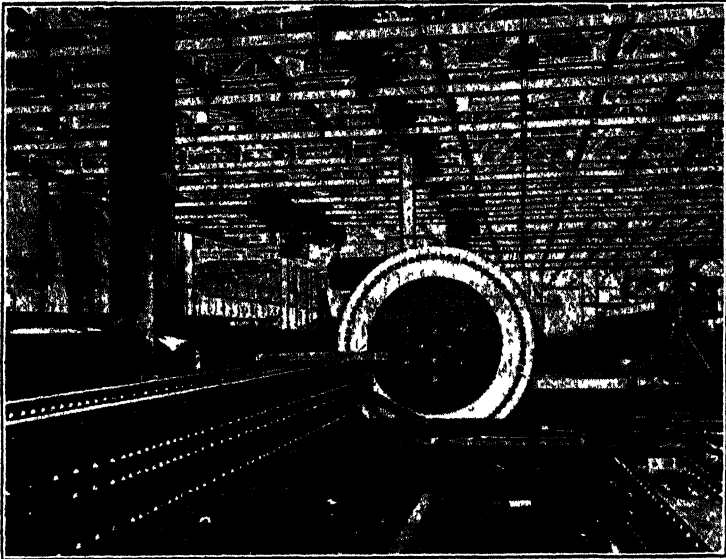

FIG. 31.—Rotary planer.



FIG. 32.—Chord boring.

a few inches apart which cut the material in a circular direction. As the disc travels across the end of the material, the surface is planed or finished evenly. A picture of a rotary planer is shown in Fig. 31. The planer is made to rotate horizontally, the disc forming any angle desired with the material for planing bevelled ends. The planer illustrated is known as a 60-in. single head rotary planer, swivel head. The travel of the head is 10 ft. and will mill a member whose cross-section does not exceed 4 ft. 6 in. and 7 ft. 6 in. and length unlimited. When two planers are arranged to plane both ends of a member at the same time, it is known as a double head rotary planer.

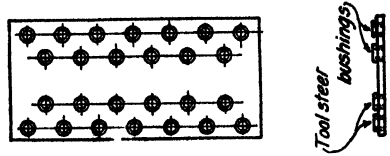

FIG. 33.—Reaming templet.

A chord boring machine is used to bore pin holes. A picture of such a machine is shown in Fig. 32. Three spindles holding the cutting tools are spaced accurately on one rod to bore three pin holes at one time. A machine of this description is known as a three head chord boring machine. The machine shown in the picture is capable of boring holes 96 ft. apart.

On sub-punched and reamed work, the floor beam connections to trusses, the stringer connections to floor beams and other important connections are reamed through steel templets. When reamed by this method, the holes are perfectly fair. The duplicate members also are interchangeable during erection and do not require any match-marking such as is required when the connections of members are reamed while assembled. Figure 33 shows a sketch of a reaming templet. They are made of $\frac{3}{8}$ -in. plates in which bushings 1 in. long are inserted to guide the reamer square with the face of the material.

Other operations are performed in the finishing shop, such as planing base plates, driving hand rivets, chipping rivets and other work necessary to complete the members ready for assembling in the yard or for inspection.

13. Assembling of Trusses.—Trusses are fabricated in different ways depending upon the requirements of the specifications and the practice of the structural shop.

If the trusses have been punched full size, the material is handled in any one of three ways:

(1) The truss members are shipped as punched without attempt to match the connections. A certain amount of cleaning out of the holes or spearing must be done in the field to make the holes fair.

(2) The members of the truss are assembled on skids and the connecting holes cleaned out with a reamer of the same size as the punched holes. When this method is used, the holes are made fair to receive the field rivets but some of the holes are elongated. The connections are match-marked so that the members assembled together will be re-assembled in the same positions during erection.

(3) To avoid elongated holes and still retain full size punching, the members are sometimes assembled and the holes in the connections reamed out $\frac{1}{8}$ in. larger than the size of the punching. Thus, if the shop rivets are $\frac{3}{4}$ in. all of the holes are punched $1\frac{1}{8}$ in. and, after assembling, the holes in the connections are reamed to $1\frac{5}{8}$ in. for $\frac{3}{4}$ -in. field rivets. The connections are match-marked for erection. For full size punched work, this method gives the best results.

If the trusses are fabricated according to sub-punched and reamed workmanship, the material is handled in either of two ways:

(1) All holes in the members are sub-punched $\frac{3}{16}$ in. smaller than the diameter of the rivets. The holes for shop rivets are reamed $\frac{1}{16}$ in. larger than the rivets and the shop rivets driven. The holes for the connections are reamed through steel templets making the members of the same shipping mark interchangeable during erection. When reamed by this method, the assembling in the yard is eliminated. An advantage is that the members can be shipped as fast as they are reamed. For a number of duplicate spans, the interchanging of members of the same mark is a big help to the erector. The workmanship obtained in reaming to templet depends upon the accuracy in setting the templets at the correct angles and distances from the panel points.

(2) The members of the truss are assembled on skids and the holes in the connections reamed out while the members are pinned together. As the reaming removes $\frac{1}{4}$ in. of metal around the punched holes, the holes are fair and cylindrical. The members are reassembled during erection in the same positions occupied while reamed, thus insuring fair holes and accurate work.

Of the five methods of workmanship described, the one of reaming out the connections after the members are assembled gives the best results.

Figure 34 is a picture of a 720-ft. truss assembled in the yard. The truss is part of the Metropolis Bridge over the Ohio River. The 720-ft. span of this bridge is the longest simple span in existence. Note that for the panels requiring eye bars, two eye bars of the number required in the structure were assembled to maintain the correct distances between pin holes. The holes were sub-punched $1\frac{3}{16}$ in. in diameter and after the members were assembled and pinned together, the holes in the connections were reamed to $1\frac{1}{4}$ in. for 1-in. rivets. All of the connections were match-marked to be reassembled in the same positions during erection.

The holes in the upper plane of the trusses are reamed with electric portable reamers fitted with three flute reamers. The skids on which the trusses rest are about 3 ft. above the ground so that the holes in the lower plane of the trusses may be reamed. This is done with electric reamers mounted on reaming buggies. A sketch of one of these buggies is shown in Fig. 35. By pressing on the handle, the action of the reamer is upward.

To get a close contact between the abutting ends of compression members, "steamboat ratchets" are sometimes used. This device consists of two screws with an eye at each end and connected at the center by a sleeve which is turned by a ratchet thereby moving the eyes toward each other. Tie rods with threaded ends are also used for the same purpose.

14. Inspection.—Nearly all of the tonnage fabricated in structural shops is inspected by organized companies making a specialty of mill and shop inspection. These companies are employed by the purchasers of steel to see that the specifications and plans are adhered to in the rolling and fabrication.

The duties of a shop inspector are to report the receipt of material from the mills, inspect the material by a physical examination, have physical and chemical tests made when such tests seem advisable, render progress reports periodically of the condition of the work, inspect the workmanship in the different departments, check dimensions and field connections, request changes if necessary to make the work conform to the specifications and plans, reject material which is objectionable and check the weights of the shipments. When any member is accepted, the inspector paints his insignia or mark on the material as an indication of his approval and that the member may be cleaned, painted and shipped.



FIG. 34 — Assembled truss.

The structural companies also have their own inspectors as a safeguard against shop errors. The need for such inspection is more apparent on contracts which do not receive outside inspection. In having their own inspection, the structural companies eliminate most of the errors which cause delays and are very expensive to correct in the field and strive to maintain a reputation for fabricating accurate work of good workmanship.

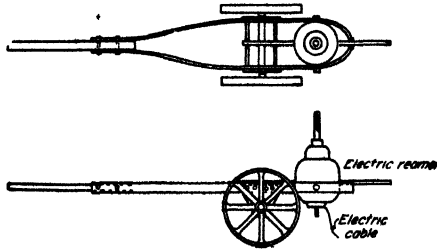

FIG. 35.—Reaming buggy.

15. Cleaning, Sand Blasting, Painting and Galvanizing.—After the members have been inspected and accepted, they are sent out of the shop to the skids in the shipping yard to be cleaned and painted. The process of cleaning is important as the durability of the paint depends to some extent upon the preparation of the surface of the steel for painting. Grease is removed by cleaning with gasoline or kerosene and loose scale is removed with scrapers and wire brushes. When paint is applied, the surface should be dry and free from all dirt and loose particles. Obviously, too, paint should not be applied in freezing weather.

Sand blasting of surfaces preparatory to painting is often resorted to for cleaning old steel and on repair work. In a few cases, sand blasting has been used to remove the mill scale and clean the surfaces of new steel. Within a few hours after sand blasting, the painting must be applied as the surfaces which are sand blasted very quickly begin to corrode. There is no doubt but what the sand blasting of the steel gives the best preparation a surface can get for painting. The cost, however, is considerably greater than for the customary method of cleaning. It is a question whether engineers are justified in spending the additional money for the advantages received. In sand-blasting, dry sand is mixed with compressed air at a pressure of 80 or 90 lb. and emitted through a nozzle about $\frac{3}{8}$ in. in diameter against the surface to be cleaned. Special grades of sand are used to get the best results.

Various kinds and colors of paint are specified by engineers in accordance with their preferences. Most steel work receives one coat of paint applied at the shop and two additional coats in the field. The field coats are usually of different shades or colors as a precaution that the second field coat will cover the first coat. Some engineers prefer to apply the three coats of paint in the field as the shop coat is to some extent scratched and marred in handling before the steel is erected. When not shop painted, the steel is usually given a protective coating of linseed oil which must be scraped and brushed off before painting. Generally, steel which is encased in concrete in the structure is shipped unpainted as the cement adheres better to the unpainted steel.

The paints used most extensively for shop painting in recent years are the red leads, graphite paints and iron oxides.

A small number of plants only are equipped for galvanizing steel because of the small demand for galvanizing as compared with painting. Galvanizing is a process of coating steel with zinc spelter to resist corrosion. Before galvanizing, the surfaces must be thoroughly cleaned and free from mill scale, rust, grease and paint. The steel is placed in a bath containing a solution of sulphuric acid which removes the scale, rust, grease and paint. The sulphuric acid is then washed off in a bath of muriatic acid or soda water. The steel is then dried and is ready for galvanizing.

There are three methods of galvanizing in common use:

(1) *The Hot-dip Process.*—The piece is dipped in a tank of melted zinc spelter. This method is used for coating structural work and castings.

(2) *The Electrolytic Process.*—The spelter is deposited on the steel by electrical contact similar to the process of copper plating. Small pieces of materials, bolts, castings, etc., are best adapted for this method of galvanizing.

(3) *Sherardizing.*—The steel is placed in an air tight tube filled with zinc oxide. The tube and contents are then heated to a certain temperature, the heat causing the zinc to be deposited on the steel. The tube and contents are then allowed to cool; the tube is opened and the galvanized steel removed. As in the Electrolytic Process, small pieces of steel are best adapted for sherardizing.

The identification marks are put on with steel stencils as painted marks would be removed during the cleaning.

16. Forge Shop.—A forge shop will generally be equipped to handle a variety of work including forging, bending, crimping, upsetting, rivet and bolt making, sawing, thread cutting, eye bar making, welding and tempering. In the larger plants, separate buildings or departments may be used to make rivets, bolts, eye bars, etc. If the shop makes a specialty of forgings, separate departments and equipment may be devoted to welding and the heat treatment of steel.

Forgings are made by hammering to the shape desired or by pressing. Steam or air hammers are used in the hammering process. Hydraulic presses are generally used for pressing. A picture of a 3,000-ton hydraulic press is shown in Fig. 36. The steel is heated in coal or fuel oil furnaces. The modern coal furnaces are quite elaborate. The coal is carried from hoppers on belt conveyors to mechanical crushers, from there to hoppers in back of the furnaces to be fed through mechanical stokers into the furnaces. The ashes are scraped on to conveying belts which run in a tunnel under ground and directly in back of the ash doors. Some of the waste heat of the furnaces is utilized to generate steam in vertical boilers located nearby and connected to the furnaces.

Light material is usually bent without heating the material; heavy material and steel having sharp bends must be heated. Angles, I-beams and channels are bent to circular shape in special rolls. A sketch showing how the angles, I-beams and channels are rolled is shown in Fig. 37. The rolls are vertical and the material is bent in a horizontal plane. The rolls are detachable for various purposes. Angles are usually bent in pairs. If the outstanding leg is bent outward the two rolls are separated, if inward the single roll is separated. Rolls for bending I-beams and channels are made with grooves to fit the flanges as shown in the sketch.

Circular plates required for stacks, tubular piers, pipes and tanks are bent in plate rolls. Figure 38 is a picture of plate bending rolls capable of bending plates 18 ft. 4 in. wide by 1 in. in thickness. Circular or segmental ends of plate girder flange angles or other special bends are made in a bending press by the use of properly shaped blocks between which the material is pressed to the shape required.



FIG. 36.—Hydraulic press.

A bending press is also used for crimping stiffener angles. The crimping is the offset on each end of a stiffener angle made to fit over the flange angle thereby saving the filler which would be required if the stiffener was not crimped.

Machines for upsetting rods contain dies in which the heated end of the rod is placed and pressed to conform to the shape of the dies. The diameters of the upsets are standard for the different sizes of threads, large enough so that the diameter at the root of the thread is greater than the body of the bar. As rods are partially heated for upsetting, it is necessary that they be annealed to remove the internal stresses caused by the partial heating. The annealing consists of heating the entire length of the rods in an annealing furnace up to a certain temperature and then allowing the rods to cool slowly.

In making rivets, the rounds of special rivet steel or soft steel are heated to a white heat and inserted in the rivet dies of a rivet making machine. The head is formed and the rivet cut at one stroke. The process is rapid, one of the machines making from 10,000 to 15,000 rivets in one 10-hr. day. Some rivet

machines are equipped with continuous feeders which save the labor and time of inserting the rounds in the dies. The output of a continuous fed rivet machine is larger than one fed by hand, producing from 15,000 to 20,000 in one 10-hr. day. The finished rivets are stored in bins separated according to diameters and lengths and sent out as required in the shop or field. Unfinished bolts are made in the same kind of machines as rivets with special dies to form the square or hexagonal heads.

A cold saw in a forge shop is used for sawing forgings, slabs and rounds and such material which cannot be made sufficiently accurate in forging.

The ordinary threads are cut by dies in thread cutting machines. The dies in the machines revolve and cut out the threads while the material is held stationary. Threads are also "cold rolled"—that is, the thread is rolled into the steel without cutting away any material. On account of the slight upsetting of the material during the rolling of the thread, the stock required is a little smaller than the diameter of the thread. In a vertical rolled thread machine, there are two

blocks parallel to each other which move upward and downward in opposite directions. One of these blocks is the die block which rolls the threads. The rod to be threaded is placed between the blocks and as the blocks move up and down, the thread is rolled on the rod as it revolves. A thread not exceeding 6 in. long can be rolled for threads $\frac{3}{4}$, $\frac{7}{8}$, 1, $1\frac{1}{8}$, $1\frac{1}{4}$ and $1\frac{3}{8}$ in. on one of these machines.

Eye bars in former years were made by welding the heads on the bars. Because of the uncertainty of the efficiency of the weld, this method of welding was superseded by the process of making the eye bar heads and bar of one piece of material. A small number of plants throughout the country manufacture eye bars as the equipment for their manufacture is very costly and the demand for eye bars limited. The process is to upset the heated ends of the bars in dies conforming to the shape of the head. For the larger heads, the operation of upsetting must be repeated two or three times before the head is of the correct shape. While still heated, the pin holes are punched out about $\frac{1}{2}$ in. smaller than the diameter of the finished holes. The bars are then annealed, allowed to cool and prepared for boring. The bars of the same dimensions are clamped together and both pin holes bored at one time. This is very important as the bars occupying the same panel in a truss must be of the same length to transmit an equal amount of tension. When tests of eye bars are requested, one bar each of several sizes is ordered in excess. After the bars are finished, the customer's inspector selects at random any one of the sizes of which there is one in excess. The selected bars are tested to destruction. If the test of any bar is unsatisfactory, the bars represented by the test bar are rejected. Rejections, however, are very rare as the material for the bars passed the mill inspection and the

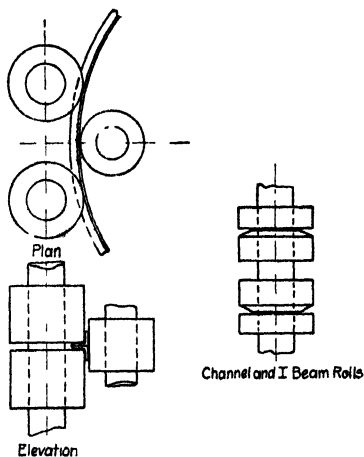

FIG. 37.—Bending rolls for angles, channels and I-beams.

standard sized heads are made with an excess of about 33 per cent greater than the body of the bar.

Two processes of welding are commonly used; arc welding by electricity and acetylene welding. These processes, known as "fusion welding," play an increasing part in the fabrication of structural steel. "Tack-welding" is used as an aid to shop assembling processes. The method of joining parts for the transfer of stress is known as "strength-welding." In electric welding either direct or alternating current may be used. The arc is formed between the metal



FIG. 38.—Bending rolls.

to be welded acting as one electrode and the fusion steel wire acting as the other electrode. The arc melts the fusion steel wire which is deposited on the parts to be welded. The welding current is of low voltage, usually from about 15 to 45 volts with an amperage of 50 to 100 for thin plates, increasing to 350 and more for thicker plates.

17. Machine Shop.—The machine shop of a structural plant will generally be equipped to finish bridge castings, pins, rollers, bases, draw span and bascule bridge and turntable machinery.

Such equipment will include a tool shop, lathes, lathe grinders, boring lathes, boring mills, planers, drills, shapers, gear cutters, bevel gear planers, key seaters, bolt cutters, nut taps, a hydraulic press and other machines.

In the tool shop are machines for making tools required in the shop and field including drills, reamers, punches, rivet dies, rivet sets, various lathe tools, etc. There are lathes, milling machines, shapers, and grinders for making the tools.

The larger lathes are used for turning bridge pins, shafting for movable bridges, large gears and large circular pieces. One of these lathes will swing a

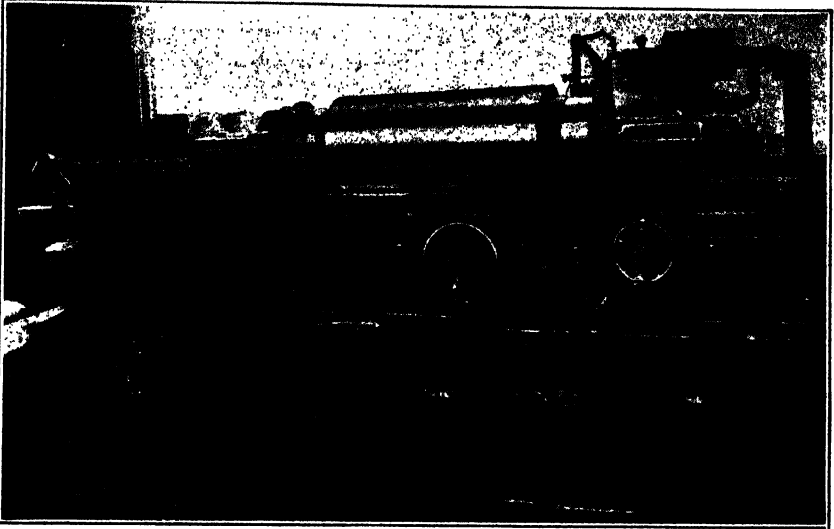

FIG. 39.—Lathe grinder.



FIG. 40.—Boring lathe.

piece 80 in. in diameter on the face plate and 60 in. in diameter over the tool carriage and can turn a piece up to 60 ft. in length.

Shafting, bridge pins, rollers, conical rollers for turntables, and draw span rollers are generally ground to the finished dimensions to secure accuracy and smoothness. The steel to be ground is centered in a lathe. In contact with the steel is an emery wheel attached to an auxiliary shaft. As the steel revolves in the lathe, the emery wheel is rotated at a high speed and automatically travels the length of the steel which the emery wheel is grinding. A lathe grinder of this description is shown in Fig. 39. In the picture the emery wheel may be seen in back of the lathe.



FIG. 41.—Boring and turning mill.

Large pins and shafting have holes bored through their centers. The purpose of this boring is to expose the interior of the metal for inspection and to reduce the weight. The boring is done on a boring lathe, a picture of one of these machines being shown in Fig. 40. The material is held in chucks at the head of the lathe and supported at intervals for its entire length. The boring head is attached to a boring rod which is fastened to a carriage moving automatically along the bed of the lathe. The material is rotated while the boring head is fed slowly into it while boring out the hole. A cutting compound of diluted grease is forced by a pump through a hole in the boring rod and up to the cutting edges, the drillings are discharged with the cutting compound into a pan below the lathe from whence the cutting compound is pumped back to the boring rod, to be used over and over. The boring heads for this machine vary up to about 16 in. in diameter. Larger sizes can be made as the occasion demands. The longest pieces which can be swung are 26 ft. by 17 in. in diameter. The largest size which can be swung is 32 in. in diameter by 14 ft. long.

A picture of a boring and turning mill is shown in Fig. 41. The material rotates while the tools automatically feed horizontally, vertically or in an inclined direction as desired. This mill will finish pieces 10 ft in diameter by 6 ft. high. When the housings are moved back to the extreme position, pieces 16 ft. in diameter can be handled. Circular pieces such as discs, turntable centers, gears, etc., are turned on this mill. The machine can also be used for planing level surfaces provided the circular cuts are not considered objectionable for the purpose the casting is used.

The planers are used for planing bases and generally all surfaces in one plane. A number of castings are set up on the planer bed and all planed at one time with one or two cutting tools. The material moves horizontally while the tools are fed mechanically in the direction desired. One tool will take the "rough cut" followed by a second tool taking the "finishing cut." Figure 42 is a picture of a



Fig. 42—Planer.

planer capable of planing a piece 10 ft. wide by 10 ft high and 30 ft long. Many kinds of special work can be planed. Take, for example, the special teeth on straight rack sections. The rack sections are clamped transversely to the bed of the planer side by side so that the tool cuts the faces of several teeth in one travel of the bed of the planer. The tool is fed by hand to conform to a templet of the profile of the teeth.

The conical surfaces of the upper and lower sections of circular tracks for draw span drums or balance wheels are sometimes planed on planer beds. This is done by having the tool mechanically travel in a plane making a small angle with the horizontal and moving the segments in a circular direction on the planer bed. Greased guides force the segments to slide with a movement such that the tool will cut the length of the casting and in a path concentric with the sides of the casting.

On the shapers, the material is clamped to the bed and the tool travels the length of the material to be cut. The ordinary type of shaper has the tool work "away" from the machine, another kind has the tool "pull" toward the machine and is known as a draw cut shaper. The shapers are used for many purposes, such as making keys for shafting, joints for split bearings, finishing dies, etc.—briefly, all small material requiring finishing in one plane.

Comparatively few structural shops are equipped to cut gear teeth. The tendency at the present time is to cut gear teeth instead of casting them because of

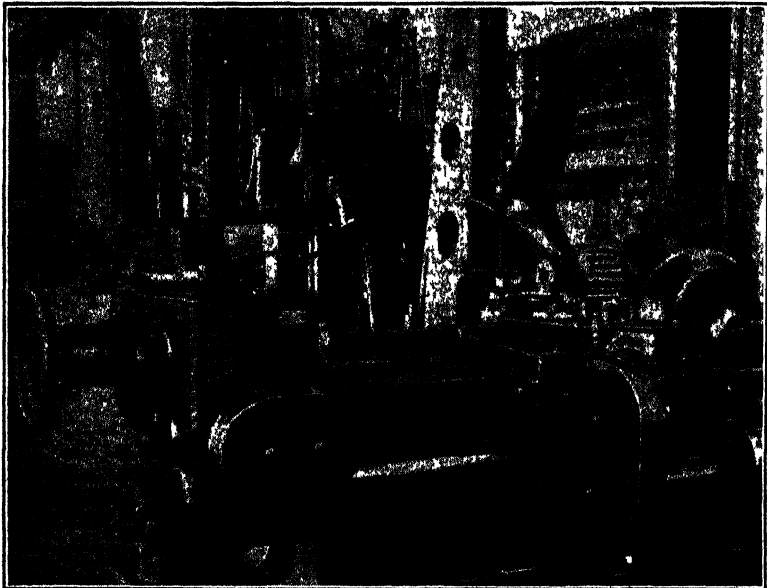

FIG. 43.—Gear cutter.

the greater accuracy secured with cut teeth. Unfortunately, four different standards of gear teeth are in use, involute teeth of $14\frac{1}{2}$ -deg. obliquity with diametrical or circular pitch or 20-deg. obliquity with either pitch. It is therefore necessary to keep four sets of cutters of the sizes commonly used or, as frequently happens, request changes to suit the cutters on hand.

The teeth of gears are cut on a gear cutter such as shown in Fig. 43. A spindle holding the circular cutter revolves and removes the material from the blank gear between two consecutive teeth. The gear has a mechanical feed of about the length of a tooth. After the cut is made, the gear automatically revolves the space of one tooth, the revolving cutter mills out the next space and so on until the full number of teeth are made. For the larger gears, two or three sizes of cutters are used to make the finished profile of the teeth. For the machine shown, spur gears up to 72 in. in diameter can be cut.

A bevel gear planer is shown in Fig. 44. It is capable of planing gears whose maximum pitch diameter is 60 in. for bevel gears and 54 in. for mitre gears.

A key seater for cutting key grooves in gears and structural members has a cutter on a vertical spindle which is inserted in the hole to be key seated and made to feed up and down during the operation of cutting the key seat. The machine described will cut key seats as wide as 4 in. and as long as 24 in. The capacity of the table is 15 tons.

Threads for bolts are made with bolt cutters on a lathe or are cold rolled. In the bolt cutters, the dies revolve around the bolts which are held stationary.

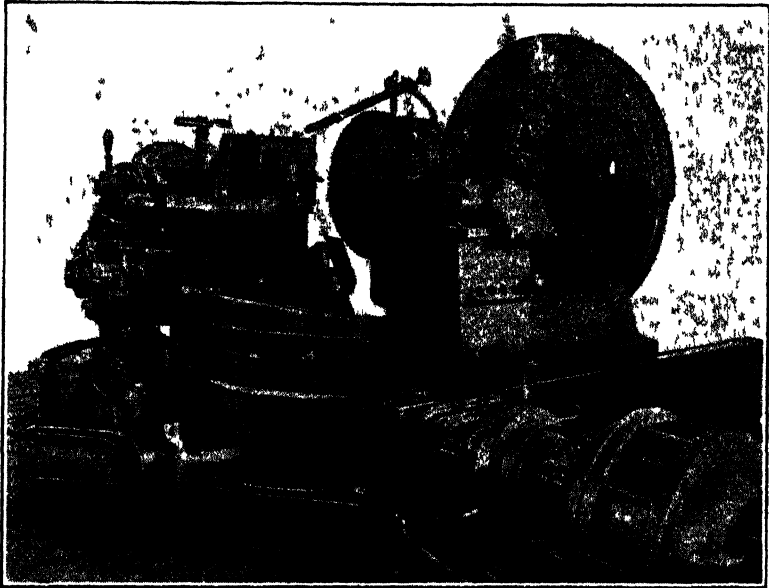

FIG 44.—Bevel gear planer

Threads in rods, bolts and pins up to 6 in. in diameter can be made on a bolt cutter. Threads of larger sizes must be cut on lathes. Square threads must also be cut on lathes. The method of cold rolled threading was previously described.

Bolts in shear which are used in place of rivets which are inaccessible for driving are usually turned $\frac{1}{32}$ in. under size and are called tight fit bolts. They are often made on the automatic lathe machines. These machines are capable of making from 200 to 300 turned bolts in 10 hr. whereas an ordinary lathe can only make from 25 to 40 turned bolts in the same time.

The nut taps are machines in which the nuts are held in a chuck and the taps revolved inside of the nuts cutting out the threads. The threads are U. S. standard, up to $1\frac{1}{2}$ in. diameter. The sizes vary by $\frac{1}{8}$ in. and, from $1\frac{1}{2}$ in. to $2\frac{1}{2}$ in. diameter, the sizes vary by $\frac{1}{4}$ in. The exception to these standard sizes of threads are the threads of bridge pins which have 6 threads per inch.

A horizontal press is used for pressing gears on shafting and for other purposes where great pressure is required to press material together. One kind of these presses is operated by hydraulic power with a capacity of 300 tons, the distance between the housings being 18 ft.

A special method is sometimes used for fitting up and finishing the complete drum, tracks and wheels of a rim bearing draw span. Formerly the rim bearing draw spans were used a great deal; at present most designs of draw spans have center bearings. A combination of the center and rim bearings has been designed in a few cases for long draw spans carrying a heavy live load. In fitting up and finishing the drum, tracks and wheels in accordance with the following method, a specially prepared floor and center pit is required. The floor is made of concrete about 30 to 40 ft. in diameter with radial beams embedded in the

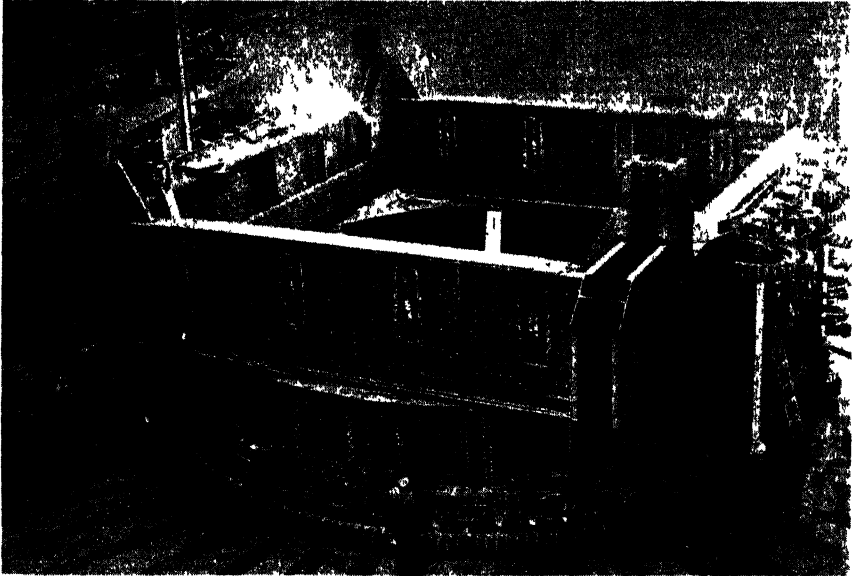

FIG. 45.—Assembled drum wheels and tracks.

concrete. The center casting of the draw span is laid in the center pit at the correct elevation and fastened down. The lower track segments are planed on the bottom for an even bearing and finished on the ends to secure the correct length of each segment. The lower track is then assembled and after being connected with the bracing to the center casting is spiked to the radial timbers. The rack segments are planed on top, finished on the ends and connected to the lower track. The drum is assembled on stool castings which connect to the web leg of the lower flange of the drum and rest on the finished top of the rack. All of the radial struts are erected connecting the drum to the center casting. The pinion shafts and bearings are assembled with the teeth of the pinions meshing with those of the racks. Above the drum a temporary horizontal shaft is connected with mitre gears to the two pinion shafts. A temporary motor with a speed reduction is connected to the horizontal shaft and completes the equipment for revolving the drum. Two tool posts, one for a rough cut and one for a finishing cut, are fastened to the upper track and, when the drum is revolved, the top of the lower track is planed. By fastening the tool posts to the lower track, the bottom surface of the upper track is planed. The drum wheels are assembled with live

rings and spider connecting the rings to the center, temporary stool supports removed and the completed drum is turned for several hours on the wheels to insure that all of the parts are in good running order. There remains but to match-mark the joints, take the pieces apart and paint ready for shipment. Figure 45 is a picture of a drum of a 425-ft. draw span for the Northern Pacific R. R. at Duluth, Minnesota. The picture shows the loading girders, drum, wheels and rack completely assembled.

18. Shipping.—The office advises the shipper of the deliveries of a contract, consignment and routing. Empty cars are ordered several days in advance of the dates of shipments. Great care is exercised in placing orders for cars at the proper time to avoid the payment of demurrage. The shipping bills containing the number of pieces, description, shipping marks and weights are used to ship from. The bills are invaluable to the shipper in showing the list of complete material comprising a contract and the figured weights of each piece which are used to check the scale weights.

On pound price contracts, beams and small material are generally invoiced according to the figured weights. All other steel is invoiced from the scaled weights. The shipping pieces are either weighed separately or a complete carload weighed in which case the weight of the car and loading material is deducted from the weight of the car and its load.

On lump sum contracts, the weights of the members are figured and obtained by scale for purposes of cost and production records. The invoices are based on the percentage of the total weight shipped.

The cars must be correctly consigned and routed over the roads designated by the office. If the freight is paid by the customer, he naturally will decide upon the routing—otherwise, the structural company will take advantage of shortest hauls and the least switching. The routing being decided upon, it is necessary to know what the minimum train clearance is, to be certain that the loaded cars will clear the bridges, viaducts and tunnels on the route selected. Frequently, material is routed over special lines to ship loads of larger dimensions.

The weights of the shipments must be carefully investigated to secure the advantage of smaller freight rates for minimum carload shipments. The minimum weights vary in different states from 36,000 to 50,000 lb. for single cars, 45,000 to 75,000 lb. for double cars and 60,000 to 75,000 lb. for triple cars. Minimum carload shipments have the smallest freight rates; less than carload shipments (L.C.L. loads) have higher rates. Naturally the L.C.L. loads are avoided when possible.

All cars must be loaded to conform to the rules of the Master Car Builders Association. The sizes of timbers used, strength of connections and the arrangement of the loading must conform or be equal to the requirements given in the rules. The loading is inspected by a railroad inspector, either at the structural shop or at a terminal point before being switched to a trunk line. The object of the rules and their strict enforcement, of course, is to prevent wrecks and injury to the material in transit. After acceptance by the inspector, the railroad assumes all responsibility for damages to the material while on their tracks.

Three kinds of freight cars are used for shipments; flat cars, gondola cars and box cars. Flat cars are used for shipping long material which requires overhang, double or triple loading. Flat cars for single loading are avoided because of

the staking and bracing necessary to hold the material. A single overhang load is one in which the members project at one end beyond the car on which it is supported. A double overhang load has the members projecting beyond both ends of the supporting car. The limit in length for a double overhang load is 65 ft. When the members exceed this length, they are shipped on bolsters. If the members are less than two car lengths, about 85 ft. or less, they are shipped on pivoted bearings, one of which is on each car. If longer than two car lengths, the bolsters are placed on the first and third car of the load. The car between the bolster cars is called an *idler*. Gondola cars have sides about 3 ft. high with fixed ends or "drop" ends. They are generally used for shipping material shorter than a car length. Materials in gondola cars require little if any staking or bracing.

Box cars are seldom used except for the shipment of small material which can be carried by hand or handled by wheel barrows, or such material which it is desired to ship sealed.

The engineer should be familiar with loading methods and rules to avoid expensive loadings. Over-all dimensions of shipping members should be determined to conform to train clearances, unwieldy pieces which cannot be easily handled by crane, should be avoided, projecting pieces should be shipped loose or on such members which will save excessive blocking, details should be arranged for compact loading which will save excessive blocking, etc. Most important of all, the engineer should design and arrange the field splices of the members for single car, single or double car overhang shipments, thereby avoiding bolster loading as far as possible. As all members over 65 ft. in length are shipped on bolsters, lengths under 65 ft. should be used as far as possible.

19. Simplified Shop Work.—The following items will simplify the fabrication, thereby reducing the costs and expediting the deliveries. The purchasers are benefited to the extent that they are able to buy at reduced unit prices with quicker shipments. Engineers who design and detail structural steel should be familiar with shop practice to make the best designs and details. In the suggestions given herewith, the strength, economy and efficiency of the design is not impaired. Some of the suggestions because of their simplicity also permit of better shop work.

STRUCTURAL STEEL

(1) In the designs, more consideration should be given to the sections used. Special material should be avoided. Sections varying by $\frac{1}{16}$ in. should be combined to use one section except where large quantities are involved. Very often the delivery of a contract is delayed because the shop has to wait for a small quantity of a special section.

(2) Standard widths of plates should be used as far as possible for gusset and lateral plates. Special widths will generally be required for girder and stringer webs.

(3) For box-shape columns, diagonals, chords, etc., turn the angles or channels out where possible to permit the use of power driven instead of hand rivets for driving the rivets in the tie plates and lacing bars.

(4) For chord sections, the use of reinforcing plates between the angles should be avoided, by using thicker or additional web plates the full depth of the chord. This design has the advantage of connecting more of the main material to the flange angles directly and avoids the use of a great many rivets which are necessary to connect the reinforcing plates to the webs. When two webs are riveted together the rivets holding the plates together

should be about 12 in. apart, the edges being held together by the rivets through the flange angles.

(5) Frequently on stringers and light girders, the webs are designed very light which necessitates the use of many stiffeners to prevent the buckling of the webs. It is a big advantage to thicken the webs and omit the stiffeners. The weight in either case is about the same as the omission of the stiffeners will nearly offset the increased weight of the thicker web.

(6) Avoid round end girders for such conditions when square end girders are satisfactory. The round ends increase the shop work very materially. The radii of the round ends should never be less than 2 ft. 6 in. as the shop work for round ends of small radii is not as satisfactory as for those of large radii.

(7) For round end girders with side plates, the side plate should be cut where the bottom edge meets the curvature of the flange angle, thereby avoiding the bending of the side plates.

(8) On skew spans the design should be studied with the idea of squaring the ends of the stringers, end frames, etc.

(9) For skew crossings, subways, etc., the amount of skew varies often by small amounts. By using a mean of the different angles of skew, more members and details are made identical. For instance, if the angles of skew of three crossings are 29 deg. 48 min., 30 deg. 28 min. and 31 deg. 2 min. respectively, the three crossings should be designed with a mean of these angles, which in this case is 30 deg. 26 min.

(10) Instead of using built up bolsters which are uncertain in their workmanship because of the fitted stiffeners, use cast iron for light work and cast steel for heavy work.

(11) For complicated pin bearing shoes very good results can be obtained by using cast steel instead of building up with a large number of plates, stiffeners and diaphragms.

(12) Use cast-steel bases instead of rail beds under the rollers at expansion ends of girder or truss spans.

(13) When detailing the sections for top chords and end posts, place the pin holes in the middle of the members. It is not necessary to change the working line to the center of gravity as the weight of the members will to some extent offset the effect of the unsymmetrical sections.

(14) A common mistake is to design the members with too small a width causing trouble in packing the pins, clearances for verticals and pin plates and insufficient space for driving field rivets.

(15) The size of pins should be determined with the idea of using as few different sizes as possible,—usually two or three sizes are sufficient for one span.

(16) Eye bars, adjustable members, turnbuckles, screw threads, segmental rollers, clevises, upsets, etc., should be designed according to the standards of the structural companies.

(17) In any one structure, avoid a needless variety of details or members. A few illustrations may be mentioned. Girder spans or truss spans should be of the same length or of as few different lengths as possible; towers in viaducts of the same heights or as few different heights as possible; plate girders including tower girders made of the same depth in a viaduct, stringers of the same depth in a bridge of various lengths of spans; and so on.

(18) The bases of tower and building columns are often designed with large wing plates, reinforcing diaphragms and distributing angles to carry the bearing directly to the masonry. A simpler and more efficient design is to transmit the bearing through a casting. The structural base will then be of simple design, the base of the column being held to the casting by two or more connection angles. The base plate should be omitted as being superfluous in this design. Often a rolled slab is used on building work and bridge work to distribute the load to the grillage or supporting girders. The use of the slab saves the making of a pattern and for the same depth as a casting gives a larger moment of inertia.

(19) The type of column which is most satisfactory to the shop is the one composed of four angles and a web plate, cover plates being added when needed for section. However, the column should be designed with as much metal in the angles and webs as possible to eliminate the use of the cover plates, provided there is no waste of material caused by such omission. This type of column may be used to advantage for office and mill buildings, diagonal truss members, single bent columns, etc.

(20) Column and chord sections should be detailed preferably under 40 ft. in length, a car length, but should not generally exceed 65 ft., the limit in length for a double overhang load. If longer than 65 ft., the members must be shipped on pivoted bolsters.

(21) On viaduct work, when the track is on a small grade, make the two bents of one tower alike by adding filler plates on the top of the up-grade columns. When the track is on a steep grade, the two bents of one tower should be made of the same height by setting the masonry to different elevations. Also the longitudinal bracing should be made square with the columns.

(22) For very light columns, use plain I-beams or H-columns instead of built-up columns.

(23) For floor girders or wind bracing girders, when two or more girders are alike except for small variations in length, add fillers at the ends of the girders to make them identical. In this way variations as large as 1 in. may be taken care of by adding $\frac{1}{2}$ -in. fillers at each end.

(24) The details of wind bracing girders with bracketed connections should be carefully considered to avoid unnecessary varieties and too many detail pieces.

(25) When shallow beams frame into deep beams with their tops at the same elevation, it is often possible to drop the shallow beams a few inches and avoid the coping of the top flanges.

(26) Crane girders in mill buildings are often stiffened transversely by horizontal bracing. If possible, the top flanges of the plate girders should be designed wide enough and of such stiffness to resist side bending without the necessity of the horizontal bracing.

(27) On mill building columns, horizontal stiffeners are sometimes used to prevent the buckling of the webs caused by the bending stresses. The web plates should be increased in thickness without the use of stiffeners sufficiently to resist the buckling. If this is not possible, the ends of the stiffener angles should be set back from the column angles, eliminating the milling and chamfering.

(28) Instead of using close lacing on compression members it is often advisable to use a solid web. This will sometimes permit the use of a lighter weight of main angles by counting the web as part of the section and besides will greatly facilitate the painting.

(29) For tension members use tie plates instead of lacing bars. The exception to this is for such members which require the lacing to prevent sagging.

(30) The lacing bars should generally be lapped instead of the ends being side by side. In a comparison of the two methods, the one having lapped bars requires about one-half the number of rivets.

(31) Good results are obtained by straightening base, sole and cap plates up to $1\frac{1}{2}$ in. in thickness instead of planing them. Beyond this thickness, the plates should be planed.

(32) Angle bracing should be used instead of rod bracing. Simpler connections are possible for the angle bracing and the structure is also more rigid. The vertical leg of the angle bracing should be large enough to prevent excessive sagging.

(33) In long structures, adjustment points should be provided to allow for slight inaccuracies in the steel and variations in setting the columns. Such adjustment will also serve the purpose of allowing for the expansion of the steel, if desired.

(34) Designs and details should be made to afford the structural shops every facility to use their equipment to advantage. For instance, details should be arranged for the multiple punches and to suit requirements for bending, machining and other shop operations.

(35) Chord members extending over two panels should be made of the same section to avoid the shop splices although the stresses in each panel are different. The weight of the shop splices will offset the increased weight due to making the sections alike for both panels.

(36) A common error is in not allowing sufficient clearances at the ends of sheared members, entering connections or when cutting pieces to clear other pieces. Shearing and coping is not an exact operation and reasonable allowances must be made for practical work. A clearance of $\frac{1}{2}$ in. is considered reasonable at the ends of sheared members or cuts while the opening to receive an entering member should be usually $\frac{1}{8}$ in. larger than the size of the entering member.

(37) Sufficient clearance should be allowed between the movable and fixed portions of movable bridges. If possible, 2 in. should be allowed for such clearance.

(38) When designing lateral angles of small section, omit the lug angles to develop the outstanding leg if the number of rivets required for the connections does not exceed 6 rivets.

(39) Generally, the ends of laterals, diagonals, etc., should be designed square, so that the mill lengths can be used without additional shearing and trimming.

Channel diagonals of trusses when turned out and exposed to view, should, however, be cut on a bevel. When turned in and not exposed the ends should be square.

(40) When the bevels on connection angles are slight, the material should be punched as if the connections were square. During the fitting the angles are given the bevel desired. This will generally apply to floor construction which is on a grade and roof floor construction which is pitched for drainage.

(41) Plates with beveled cuts should be designed with the idea of cutting in the shop with the least number of cuts and the least waste.

(42) Avoid crimping long flange angles as it is very difficult to handle long material in the crimping press.

(43) Angle railings may often be used instead of the more expensive gas pipe railing.

(44) Bent top flange angles of through girders should be spliced near the ends of the girder to permit of better handling in the shop. When this is not done, it means that the long angles have to be swung across the shop, thereby interfering with other operations.

(45) Plates or other shapes should never be bent on the width. When it is necessary to use plates whose edges are circular or shaped with re-entrant cuts, shear the plates out of sizes of large enough dimensions so that the bending is not necessary.

(46) Eliminate excessive numbers of rivets. Study each line of rivets and connection using the spacing or quantity required for transmitting the stress and holding the material together. Very often the larger size rivets can be used with a corresponding decrease in the number of rivets.

(47) The handling of material is a big part of the fabricating costs. Details should be made to avoid extra handling of the pieces. As an illustration of this, two sizes of shop rivets used in a member causes an extra handling for punching two sizes of holes.

(48) The details of a member should be arranged to avoid any riveting before the member is completely fitted. For instance, countersunk rivets under a stiffener should never be used because such rivets must be driven with an extra handling before the stiffener is fitted.

(49) The size of rivets used is governed by the thickness of material to be punched and the grips of the rivets. The judgment of the engineer should incline toward the use of the larger rivets for the reasons that a less number of rivets are necessary, larger fitting up bolts can be used to exert greater force in pulling the material together, and tighter rivets are driven.

(50) On floor plates, skew back angles, stiffening channels, etc., space rivets 8 to 12 in. apart. On some classes of work the spacing of rivets may be even greater, depending upon the conditions under which the material is used.

(51) When the shoes of columns are imbedded in concrete or set in grout, it is not necessary to countersink the rivets in the base.

(52) When the specifications call for material to be drilled from the solid—as, for example, in alloy or high carbon steel—the sections should be designed with as few pieces as possible. Instead of using $\frac{5}{8}$ - or $\frac{3}{4}$ -in. plates which generally are of the right thickness for punched work, the material should be ordered in thicknesses as large as 1 in. maximum whenever possible.

(53) Very often it is not necessary to mill the ends of I-beams carrying shear only. All requirements are fulfilled by setting the I-beams back from the face of the connection angles. The shops are prepared to rivet on connection angles and get them square with a variation in the length of the member not more than $\frac{1}{32}$ in. without milling. The right lengths and square ends can be obtained without the use of milling.

(54) When columns are set to stone bolts which have been imbedded in masonry, the holes should be $\frac{3}{4}$ or 1 in. larger than the diameter of the bolt to provide adjustment to take care of the inaccuracies in setting the stone bolts or to allow clearance for drilling the holes in the concrete or stone after the steel is erected.

(55) When vertical angles riveted to a column are used to carry the uplift of an anchor bolt, the angles should not be fitted between horizontal angles but extend to the milled line to be finished with the main section of the column. The fitted angles are uncertain in action whereas the angles milled with the column give the best workmanship.

SECTION 9

STEEL ERECTION

The progress made in steel erection has kept pace with the improved methods of making and fabricating steel and construction in general. The modern erecting equipment and tools are better and larger than those of former years and more rapid methods are employed in erection with less risk.

The most important consideration in erection is the one pertaining to risk of both men and materials. All other items are secondary to that of conserving the lives of the men and of saving the loss of the steel with the consequent delays and cost of replacement.

Rapidity in the progress of erection is important. Delays in building work cause financial losses in valuable lease holds or increase the constant danger from wind storms. Delays in bridge construction often hold up the trunk line traffic or add to the menace of rising waters or ice floes.

1. Organization of Erecting Forces.—Erection organizations have different routines and methods of doing work. The larger structural companies maintain their own erecting departments in conjunction with the fabrication of the steel. Then there are companies organized solely for the purpose of erecting steel. There are also a number of large contracting companies, principally building contractors, who erect the steel on work for which they have general contracts.

In any one company, there are the office and field forces. If the company has a number of contracts underway, the office is quite a busy place. In the office, the executives are surrounded by their engineers, clerical and stenographic help. As the mind controls the muscles of the body so the office force of an erecting company directs the work of the entire organization.

The duties of the office forces are varied and many. The estimates for new work are made by the engineers and such estimates often involve considerable work and investigation. To illustrate, possible and safe erection must be considered. Is the available equipment adequate for the work or must new appliances be purchased? Is it possible to erect the work in the time required? Are the labor conditions such at the site that sufficient help can be secured? Is the season of the year favorable for the successful completion of the work without undue risk of floods or storms to destroy the falsework or superstructure? Is there suitable trackage at the site for unloading material and handling for erection and to what extent must new tracks be laid? Must traffic on the existing railroad be maintained and what effect will this have on the erection of the new structure? What housing arrangements should be made for the men? These and many other questions must be settled before an intelligent bid can be made. Often it is necessary to send an engineer to the site to study the local conditions in order to obtain all the information desired.

The movements of the field forces are directed from the office. The foremen, timekeepers and a number of experienced men are usually permanently employed by the company and are assigned to the various contracts under construction. Labor and other help required are secured locally at the site. A field force consists of a foreman, possibly an assistant foreman, a timekeeper, leaders in charge of the different gangs, structural workers and laborers. In the erection of the larger structures, the erectors usually have an engineer in charge and the customer has an engineer stationed at the site to see that the work progresses satisfactorily. Progress reports and photographs are periodically sent to the office for record and inspection.

The shipments of the structural material are regulated by the office as it is of great importance to receive the material at the site on time and in the sequence of erection.

Accurate records of the equipment and tools stored in different cities and in use are kept. It is necessary from time to time to ship the equipment and tools to the required locations.

Many other matters are attended to by the office—such as engaging men, arranging for the transportation and assignment of men in the field, payment of salaries and wages and all casualty details.

2. Falsework.—Except for cantilever erection, riveted and pin spans are erected on falsework. Short spans which can be assembled and bolted up on the ground are swung into place without the use of falsework. The falsework supports the weight of the span until the span is completely pinned, bolted up and self-sustaining. Naturally the cost of the falsework is a big item of the erecting expense and several designs are often made to minimize the amount of timber used in the falsework. When possible, members from the permanent structure are utilized temporarily in the falsework construction—for example, stringers to carry the track for the erecting equipment.

The falsework for spans erected over streams is usually erected built up on foundation bents of piling. The piles are capped and braced and support the falsework proper, the falsework being made of sawed timbers. Sometimes, however, when the span is not high, the piling itself constitutes the falsework.

When traffic is not maintained during erection, the falsework is comparatively light, the loads to be carried being the weight of the new span and the erecting equipment. When traffic is maintained, of course, there are the stresses caused by the moving trains which, however, travel at reduced speed. In maintaining traffic on deck structures, additional falsework must be placed on top of the main falsework to bring the track to the proper elevation.

In the building up of falsework for the support of a simple span, a bent is placed at each panel point and one near each abutment for the support of the end stringers. If the loads are very large at the panel points, two bents are used.

A simple bent is made up of two battered legs, two vertical or plumb legs, a horizontal cap piece and a lower horizontal piece called a sill. More than two battered and plumb legs are often used depending upon the load induced by the dead load of the span and erecting equipment and it is only in rare cases that the number of vertical legs is as low as two. Falsework for a span is usually erected with a derrick car which with a front truck reaction of from 150,000 to 175,000

lb. would require four or five legs for the support of the equipment. This load with the weight of the heaviest member erected, together with the dead load of the span, would increase the number of legs above four or five. The number of legs to be used in a bent may be determined by dividing the total reaction by the bearing power of one leg. If a 12×12 timber is used, and assuming the bearing value at 400 lb. per sq. in., the load carried by each leg is about $28\frac{1}{2}$ tons. The bents are braced with planks bolted to each side to give stability. Longitudinal

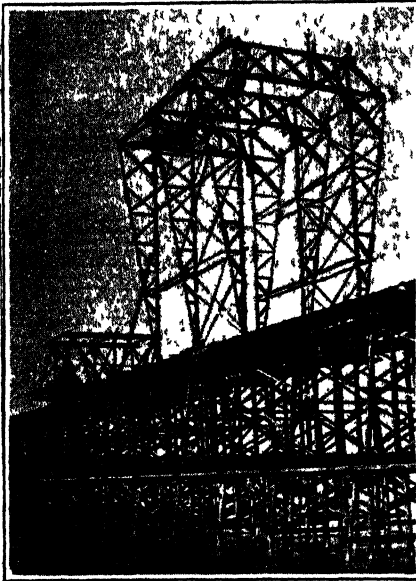

FIG. 1—Falsework

timbers or I-beams are bolted to the caps of the bents under the trusses to be erected and also for supporting tracks for the traveler and the handling of material, such timbers or I-beams make up the deck of the falsework. Some of the bents are braced together longitudinally to form braced towers to give stability to the falsework. When the height of the falsework is considerable, the bents are built up in stories or tiers and properly braced. Horizontal timbers or I-beam struts extending the entire length of the span are bolted to the bents as required and are called sash or level bracing. For high falsework, the bases of the bents are spread to prevent lateral overturning.

In figuring the loads on the bents, an excess load must be provided for to take care of unequal settlement of the bents and stresses caused by using jacks in case jacking is required to adjust or move the span.

The building of falsework is always a precarious undertaking. The soil at the bottom of the river must be known so that the loads imposed on the piles can be safely figured with the proper penetration in the soil. There is the ever present danger of drift or ice wrecking the falsework or high waters floating the timbers. In deep water, there is a source of danger if the piles are not braced under the water level.

The falsework used to erect the three 476-ft. riveted truss spans for a bridge at Bismarck, North Dakota, is shown in Fig. 1. The picture shows a good view of the traveler used.

3. Erecting Equipment.—The erecting equipment used in any given case depends upon the kind and size of structure and the loads to be lifted. The equipment described below is typical of the many kinds in common use.

3a. Travelers.—The different types of travelers may be divided into four general kinds, the gantry travelers, boom travelers (sometimes called mule travelers), tower travelers and overhanging travelers. Modifications of the ordinary travelers and travelers of special designs are used for structures involving

unusual problems. An advantage possessed by a traveler is that any number of falls and runner lines desired can be supported.

The typical gantry traveler is made up of two or three bents in section straddling the structure to be erected. The bents are substantially braced in the longitudinal direction and also transversely between the plumb and batter legs for wind bracing. "Jigger sticks" of heavy timbers or I-beams are placed on the

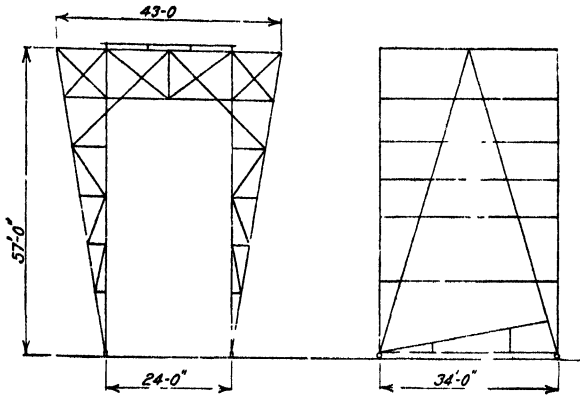

FIG. 2.—Through bridge traveler.

top of the traveler bents over the center lines of the trusses, to which are attached the rigging used for hoisting purposes. The hoisting engine is supported on a platform at the base of the traveler or is kept on shore. The material to be erected is moved out from the shore to the traveler, picked off of the cars and erected in place. Figure 2 is a diagram of a through bridge gantry traveler.

A very simple form of a gantry traveler is the gallows frame (Fig. 3) consisting of a single bent held longitudinally with guy ropes. Gallows frames are sometimes used in plate girder erection, the gallows frames working in pairs or one in conjunction with a derrick.

The boom traveler is made up of two booms which are attached to a single deck traveler on which are two masts, two stiff legs and two sills with variable lengths of cross struts and framing so that the traveler can be adjusted to different widths. The booms and masts are generally interchangeable with derricks of different capacities.

This class of traveler is used on viaduct and bridge erection where there are no railroad connections, replacing the derrick car or locomotive crane which generally would be used if track facilities were available.

The tower traveler has two or more booms mounted on top of a well-braced tower. Such a traveler is of advantage in making high lifts. The towers are made in one or more stories to secure the required height. The engine is placed at the base of the tower.

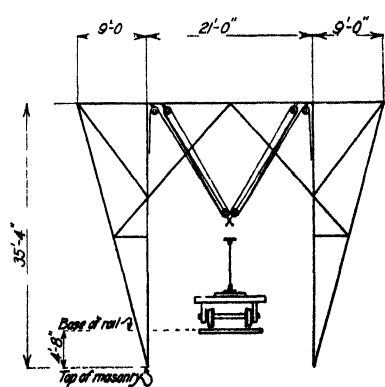

FIG. 3.—Gallows frame.

The overhanging traveler is not used extensively at the present time. It is either a gantry or a tower traveler of some description which has one or more overhanging extensions from which falls are hung for raising material.

3b. Steel Derrick Cars.—A steel derrick car is shown in Fig. 4, with the A-frame laid down and in position for transportation. When the car is in service for erecting, the A-frame is vertical and forms the mast for supporting the boom at the forward end of the car. The engine and boiler are at the rear end to aid in counterweighting the car when weights are lifted. The car is self-propelling in addition to furnishing the power for lifting the steel. One of the features of a derrick car is its low mast which is short to clear overhead obstructions. The low mast increases the derrick stresses considerably more than the higher masts of the other types of derricks.

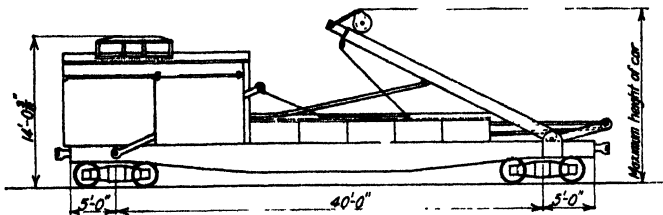

FIG. 4.—Steel derrick car.

The derrick car is serviceable for many purposes. The steel can be picked up near the site and moved forward to the span to be lifted in place without extra handling or use of locomotives. Its lifting capacity is limited, however, for side lifts. When the side lift is considerable, the car must be anchored to the track and securely blocked underneath the frame of the car or anchored by guys attached to the top of the mast and to heavy objects or structures in order to prevent the overturning of the car.

Derrick cars are used in the erection of many kinds of structures, being ideal for viaduct work, plate girder erection and riveted and pin truss spans.

3c. Locomotive Erecting Cranes.—A diagram of a locomotive erecting crane of 50-ton capacity is shown in Fig. 5. The crane is self-propelling and has the advantage of a lifting capacity for the entire circular area covered by the swing of the boom.

For heavy side lifts, beams, called "outriggers," are pulled out on the sides of the car body and blocked up from the ground or structure, thereby greatly increasing the possible load to be lifted without overturning the crane.

Sometimes curved or straight extensions are added to the top of the boom. An auxiliary line called a "runner" line is used for the extension, being independent of the main falls used in lifting the loads. While the extension increases the reach of the boom for light loads, the greatest advantage of the extension is in the erection of trusses on mill buildings. A truss is lifted into place with the main load lines and purlins are raised with the extension without releasing the truss. This method provides stability for the truss until the purlins are erected and hold the truss securely in position.

Locomotive erecting cranes can be used to advantage on many classes of structures where there is available trackage and the steel raised is within reach

of the booms. Two cranes working together can handle long members which are beyond the reach of one boom.

Locomotive cranes are used extensively on work provided the freight of the crane to the site is not excessive. They are very useful in erecting bridge spans,

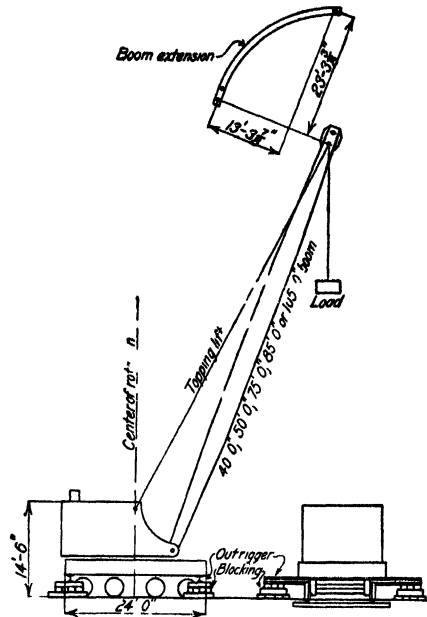

FIG 5 — Fifty-ton locomotive erecting crane

mill building work, tiered building work up to 100 ft. in height and for yarding purposes. Their use is economical as they are self-propelling and only one man is required to handle the mechanical operations.

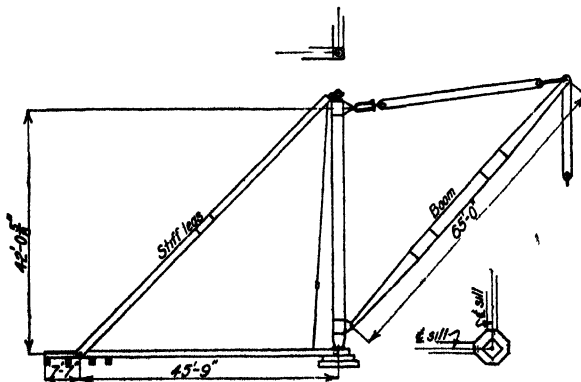

FIG. 6.—Twelve-ton stiff-leg steel derrick.

3d. Steel Derricks.—Derricks are of various designs and capacities. The stiff legs, masts and booms are usually made of structural steel, replacing the timber which was formerly used. If made with two stiff legs, the derrick is

known as a stiff-leg derrick; if the mast is held in position with guy ropes, it is called a guy derrick; and if one stiff leg is used, guy ropes bracing the mast normal to the stiff leg, it is a combination derrick.

Figure 6 is a sketch of a stiff-leg derrick of 12-ton capacity. The two stiff legs are placed at right angles to each other secured at the bottom to two sills and at the top to the mast. A set of tackle connects the top of the mast to the top of the boom and another set of tackle is used for lifting the loads. The power required for moving the derrick boom and lifting the loads is supplied by a hoisting engine.

A guy derrick of 12-ton capacity is illustrated in Fig. 7. It is similar to the stiff-leg derrick except that the mast is held in position with guy ropes and also

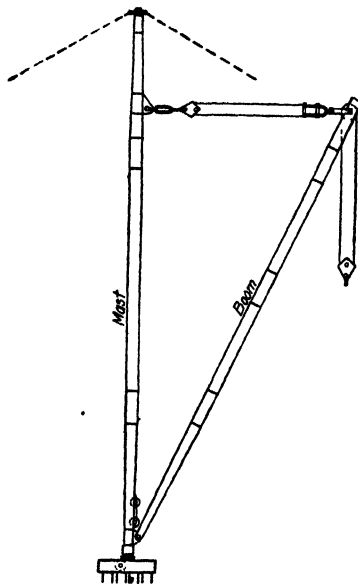

FIG. 7.—Twelve-ton guy derrick.

that the mast is higher in relation to the boom. On a guy derrick, the mast is slightly longer than the boom to allow the boom to clear the guys when swinging. This type of derrick is chiefly used on office building erection and in yards for storing steel.

The masts are turned by hand, by swing lines or by means of a bull wheel operated by lines from the hoisting engine. Figure 8 is a diagram of a bull wheel showing the mast, boom and the connection of the bull wheel to the hoisting engine.

Floating derricks are simply derricks mounted on scows and are an advantage when the material can be floated to the site as for the erection of seaport piers, dock structures or bridges in sea coast inlets. Erection by this method can proceed without waiting for the completion of the approaches or the laying of the tracks.

3e. Ginny Winks.—A ginny wink (Fig. 9) is simply an A-frame derrick of small capacity. The one shown in the figure is of 6-ton capacity. The mast is an A-frame which is braced by a stiff leg to the sill. The lead lines for operating the boom and the hoisting lines are similar to other derricks.

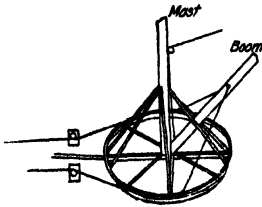

FIG. 8.—Bull wheel.

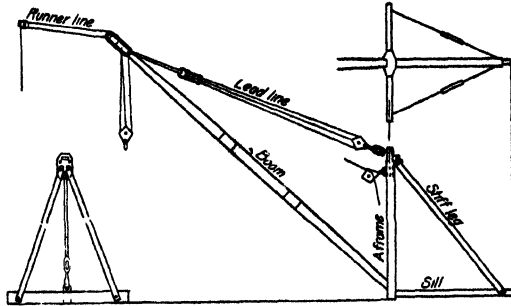

FIG. 9.—Six-ton steel ginnywink.

3f. Gin Poles.—Gin poles are not used as extensively as formerly. A gin pole (Fig. 10) is a timber or steel mast supported at the top with guy ropes. A block at the top of the mast holds the hoist lines which are operated by a crab or hoisting engine. The base of the pole rests on a shoe made of timber to distribute the lifting load over a greater ground area. In lifting loads, the gin pole

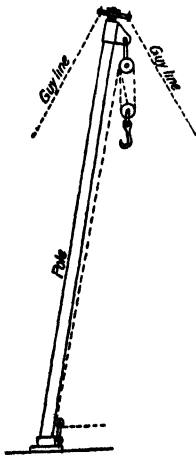

FIG. 10.—Gin pole.

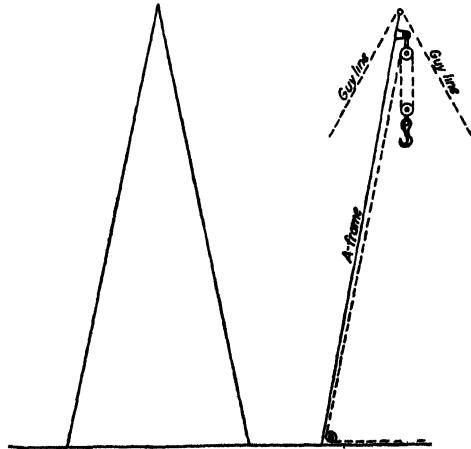

FIG. 11.—Shear legs.

should not be shifted more than a few degrees from the vertical—otherwise, there is danger of the bottom of the mast kicking out. The guy ropes are tied to surrounding structures or to “deadmen” buried in the ground. Long lengths of gin poles have been used by trussing the pole. As the pole has practically no reach, the pole is moved to each new position required.

3g. Shear Legs.—The shear legs (Fig. 11) is a modification of the gin pole. Instead of a single mast, there is an A-frame requiring two guy ropes to hold in position. The shear legs answer the same purpose as the gin pole.

4. Erecting Tools.—Most of the hoists, erecting appliances and tools are standard products on the market. There are so many varieties that only those in common use will be described.

4a. Hoists.—Steam, gasoline, diesel, or electric engines are used for supplying the hoisting power. There are many makes of hoists and the manufacturers' catalogs should be consulted for details. The capacities and sizes of steam hoisting engines of 8, 10, 16, 20, 22, 28, 30, 32, 40, 45, 50, 55, and 80 horsepower are given in the following table:

Hp.	Line pull (lb.)	Hoisting drums		A.S.M.E. boiler		Size of cylinder Diam. : stroke (in.)
		Diam. (in.)	Length (in.)	Diam. (in.)	Height (in.)	
8	2,500	9	18	28	68	4½ × 6
10	3,500	10	20	32	80	5 × 8
16	5,000	14	22	36	84	6½ × 10
20	6,000	14	24	38	90	7 × 10
22	7,500	14	26	40	90	7¼ × 10
28	8,500	14	30	42	96	7½ × 12
30	8,500	14	29	42	96	8¼ × 10
32	9,500	16	30	44	102	8 × 12
40	10,000	16	30	46	102	9 × 10
45	11,500	16	30	48	102	9 × 13
50	12,500	16	30	50	102	10 × 12
55	13,500	18	30	50	102	10 × 13
80	20,000	22	40	60	120	12 × 16

The drums are geared to the engine and operate the lead lines. The spools, sometimes called nigger heads, are located on the ends of the drum shafts. By means of clutches, they can be thrown in gear and operated by the engine. The spools handle the swing lines or runner lines of the booms by throwing three or four turns of the rope around the spools. The spools are also used for hoisting loads when manila rope rigging is used. A speed of 75 to 100 ft. per min. is obtained in taking in the line on a spool.

Crabs and winches are operated by hand for hoisting loads but are very seldom used in modern erection. A crab consists of a drum geared and turned by a crank, fastened to a frame which can be lashed or bolted to a derrick or mast. A winch is similar to a crab except that it is supported on a timber frame, making it self-contained.

4b. Blocks.—Hoisting tackle is made up of blocks with wooden or steel shells for manila or wire rope. Shackles instead of hooks are generally provided for the blocks of heavy capacities.

WOODEN BLOCKS FOR MANILA ROPE

Type of block	Nominal size (in.)	Capacity (tons)	Size of line (in.)	Weight (lb.)
Single with hook.....	8	2	$\frac{3}{4}$	15
Double with hook.....	8	4	$\frac{3}{4}$	20
Single with hook.....	12	5	$1\frac{1}{4}$	45
Double with hook.....	12	7	$1\frac{1}{4}$	70
Triple with hook.....	12	8	$1\frac{1}{4}$	95
Single with hook.....	14	6	$1\frac{1}{2}$	70
Double with hook.....	14	10	$1\frac{1}{2}$	115
Triple with hook.....	14	12	$1\frac{1}{2}$	150
Quadruple with shackle.....	14	14	$1\frac{1}{2}$	190
Single with hook.....	16	8	$1\frac{3}{4}$	90
Double with hook.....	16	12	$1\frac{3}{4}$	140
Triple with hook.....	16	15	$1\frac{3}{4}$	190
Quadruple with shackle.....	16	20	$1\frac{3}{4}$	270
Single with hook.....	20	15	2 or $2\frac{1}{4}$	170
Double with hook.....	20	22	2 or $2\frac{1}{4}$	230
Triple with hook.....	20	30	2 or $2\frac{1}{4}$	360
Quadruple with shackle.....	20	35	2 or $2\frac{1}{4}$	430

STEEL BLOCKS FOR WIRE ROPE

Type of block	Outside diameter of sheaves (in.)	Diameter of rope (in.)	Size of hook or shackle (in.)	Capacity (tons)	Weight (lb.)
Snatch with hook.....	16	$\frac{3}{4}$	$2\frac{1}{2}$	8	128
Single with shackle.....	18	$\frac{7}{8}$	2	10	157
Double with shackle.....	18	$\frac{7}{8}$	2	15	240
Triple with shackle.....	18	$\frac{7}{8}$	$2\frac{1}{2}$	25	398
Quadruple with shackle.....	18	$\frac{7}{8}$	3	30	518
Five sheaves with shackle....	24	$\frac{7}{8}$ -1	...	50	1,382

4c. Rope.—The following tables give the weight, ultimate strength and working stress of manila rope, crucible steel and plough steel rope:

MANILA ROPE
(3 Strands)

Diameter (in.)	Circumference of rope (in.)	Weight per lin. ft. (lb.)	Ultimate strength (lb.)	Working load (lb.) (factor of 5)
$\frac{1}{4}$	$\frac{3}{4}$	0.0172	550	110
$\frac{3}{8}$	$1\frac{1}{8}$	0.0371	1,275	255
$\frac{1}{2}$	$1\frac{1}{2}$	0.0750	2,650	530
$\frac{3}{4}$	$2\frac{1}{4}$	0.164	5,400	1,080
$\frac{7}{8}$	$2\frac{3}{4}$	0.22	7,700	1,540
1	3	0.265	9,000	1,800
$1\frac{1}{4}$	$3\frac{3}{4}$	0.408	13,500	2,700
$1\frac{1}{2}$	$4\frac{1}{2}$	0.588	18,500	3,700
$1\frac{3}{4}$	$5\frac{1}{2}$	0.877	26,500	5,300
2	6	1.05	31,000	6,200
$2\frac{1}{2}$	$7\frac{1}{2}$	1.63	46,500	9,300
3	9	2.37	64,000	12,800
$3\frac{1}{2}$	11	3.60	91,000	18,200
4	12	4.27	105,000	21,000

CRUCIBLE STEEL ROPE

Wire rope composed of 6 strands and a hemp center, 19 wires to the strand

Diameter (in.)	Approximate circumference (in.)	Weight per ft. (lb.)	Ultimate strength (lb.)	Safe working load for derricks (factor of 5)
$\frac{1}{4}$	$\frac{3}{4}$	0.10	5,800	1,160
$\frac{5}{16}$	1	0.16	9,000	1,800
$\frac{3}{8}$	$1\frac{1}{8}$	0.23	12,600	2,520
$\frac{7}{16}$	$1\frac{3}{8}$	0.31	16,800	3,360
$\frac{1}{2}$	$1\frac{5}{8}$	0.40	21,600	4,320
$\frac{9}{16}$	$1\frac{3}{4}$	0.51	27,000	5,400
$\frac{5}{8}$	2	0.63	33,200	6,640
$\frac{3}{4}$	$2\frac{1}{8}$	0.90	47,400	9,480
$\frac{7}{8}$	$2\frac{3}{4}$	1.23	64,400	12,880
1	$3\frac{1}{8}$	1.60	84,000	16,800
$1\frac{1}{8}$	$3\frac{1}{2}$	2.03	106,000	21,200
$1\frac{1}{4}$	$3\frac{3}{8}$	2.50	130,000	26,000
$1\frac{3}{8}$	$4\frac{1}{8}$	3.03	157,000	31,400
$1\frac{1}{2}$	$4\frac{3}{4}$	3.60	185,000	37,000
$1\frac{5}{8}$	$5\frac{1}{8}$	4.23	216,000	43,200
$1\frac{3}{4}$	$5\frac{1}{2}$	4.90	248,000	49,600
$1\frac{7}{8}$	$5\frac{3}{4}$	5.63	284,000	56,800
2	$6\frac{1}{4}$	6.40	322,000	64,400
$2\frac{1}{8}$	$6\frac{3}{8}$	7.22	362,000	72,400
$2\frac{1}{4}$	$7\frac{1}{8}$	8.10	404,000	80,800
$2\frac{1}{2}$	$7\frac{3}{8}$	10.00	492,000	98,400

WIRE ROPE COMPOSED OF 6 STRANDS AND A HEMP CENTER, 19 WIRES TO THE STRAND

Diameter (in.)	Approximate circumference (in.)	Weight per ft. (lb.)	Ultimate strength (lb.)	Safe working load for derricks (lb.) (factor of 5)
1/4	3/4	0.10	5,000	1,000
5/16	1	0.16	7,800	1,560
3/8	1 1/8	0.23	11,000	2,200
7/16	1 3/8	0.31	14,600	2,920
1/2	1 5/8	0.40	18,800	3,760
5/8	1 3/4	0.51	23,400	4,680
3/4	2	0.63	28,800	5,760
7/8	2 3/8	0.90	41,200	8,240
1	2 3/4	1.23	56,000	11,200
1 1/8	3 1/8	1.60	73,000	14,600
1 1/4	3 1/2	2.03	92,000	18,400
1 3/8	3 7/8	2.50	113,000	22,600
1 1/2	4 3/8	3.03	136,000	27,200
1 5/8	4 3/4	3.60	161,000	32,200
1 3/4	5 1/8	4.23	188,000	37,600
1 7/8	5 1/2	4.90	216,000	43,200
2	5 7/8	5.63	246,000	49,200
2 1/8	6 1/4	6.40	280,000	56,000
2 1/4	6 5/8	7.22	314,000	62,800
2 1/2	7 1/8	8.10	352,000	70,400
2 3/4	7 3/8	10.00	428,000	85,600

The following table shows the efficiency of tackle as determined by tests. The table may be used in calculating the loads that can be lifted by the tackle as follows:

Given the pull in lead line, to find the load lifted. Divide the pull by 1.20 each time the line is snatched or passes over sheaves other than those in tackle blocks; multiply the quotient by the ratio of the load to lead line pull (see table below) and the result is the load lifted. If the load to be lifted is given and if it is desired to find the pull in the lead line, reverse the above operation.

RATIOS OF LOAD TO PULL IN LEAD LINE

Diameter of rope (in.)	Working load (lb.)	Manila rope													
		Lift per unit pull in lead line for tackle with parts as follows													
		1	2	3	4	5	6	7	8	9	10	11	12	13	14
3/4	1,900	0.86	1.93	2.73	3.48	4.12	4.71	5.23	5.71	6.12	6.50	6.83	7.14	7.40	7.64
3/8	2,300	0.83	1.92	2.68	3.37	3.95	4.48	4.92	5.32	5.66	5.96	6.22	6.45	6.64	6.82
1	3,100	0.87	1.93	2.74	3.50	4.16	4.77	5.30	5.80	6.23	6.63	6.98	7.30	7.58	7.85
1 1/4	4,300	0.83	1.92	2.68	3.37	3.95	4.48	4.92	5.32	5.65	5.96	6.21	6.44	6.63	6.81
1 1/2	5,900	0.83	1.91	2.67	3.36	3.93	4.45	4.89	5.28	5.61	5.91	6.15	6.38	6.56	6.73
1 3/4	7,900	0.81	1.91	2.64	3.30	3.84	4.33	4.72	5.08	5.37	5.64	5.85	6.04	6.20	6.34
2	10,300	0.82	1.91	2.65	3.32	3.87	4.37	4.78	5.14	5.45	5.72	5.94	6.15	6.31	6.46
2 1/4	13,100	0.80	1.90	2.63	3.28	3.80	4.28	4.65	5.00	5.27	5.52	5.72	5.90	6.04	6.17
		Wire rope													
3/4	16,000	0.86	1.93	2.73	3.47	4.11	4.70	5.20	5.68	6.08	6.46	6.78	7.06	7.34	7.58

4d. Chains.—The following table gives the sizes of chains and data concerning the proof tests and working loads. Some erectors, however, prohibit the use of chains for hoisting.

DATA ON CHAINS

Trade size (in.)	Actual size (in.)	Links per ft.	Proof test (lb.)	Actual breaking strain (lb.)	Suggested load limit (lb.)	Weight per 100-ft. (lb.)
1/4	9/32	16	2,500	6,600	1,375	90
5/16	10/32	15	2,800	7,800	1,540	105
3/8	11/32	14	3,600	8,800	1,980	125
7/16	12/32	13	4,200	11,100	2,310	155
1	13/32	12	5,000	12,800	2,750	170
1 1/8	15/32	10 1/2	7,000	15,600	3,850	220
1 1/4	17/32	9 1/2	9,000	20,300	4,950	275
1 3/8	19/32	8	11,500	26,500	6,325	360
1 1/2	21/32	7 1/2	14,000	31,000	7,700	450
1 3/4	25/32	6 1/4	20,000	48,500	11,000	650
2	29/32	5 3/4	26,000	61,200	14,300	840
1	1 1/32	4 3/4	32,850	82,300	18,000	1,080
1 1/8	1 5/32	4 1/8	40,000	96,400	22,000	1,450
1 1/4	1 9/32	3 7/8	51,000	112,100	28,000	1,650

4e. Hooks.—Hooks of various designs for various purposes are used. A few of those in common use are the girder hook (Fig. 12), the balance beam (Fig. 13) the I-beam hook (Fig. 14), and the eye bar hook (Fig. 15).

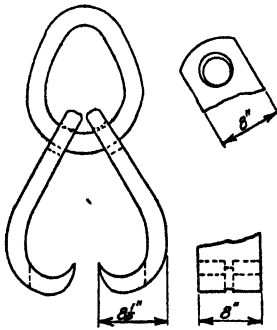

FIG. 12.—Girder hook.

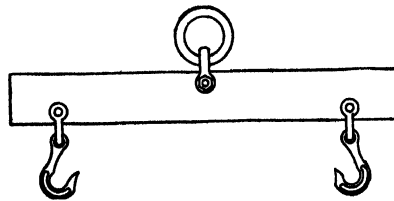

FIG. 13.—Balance beam.

4f. Miscellaneous.—A device called an old man (Fig. 16) consists of a spindle with a flange support on which an adjustable arm slides. It is used for various purposes when backing up is required, as in drilling. The support is clamped to the member to be drilled, the arm is adjusted for the length of the ratchet drill or air drill and carries the thrust of the drill during the operation of drilling.

An old man wolf (Fig. 17) is similar except for the detail of the support which is so constructed that the old man wolf can be swung at an angle, vertically or horizontally. It can be attached to almost any shape of member for support.

The steamboat ratchet is commonly used for many purposes for pulling members together—for example, two adjacent top chords to secure a bearing, pulling up bracing and plumbing columns. A steamboat jack is sometimes used

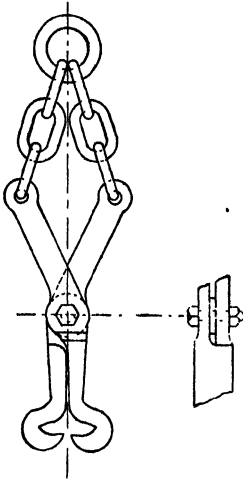

FIG. 14.—I-beam hook for I-beams 15 in. deep and over.

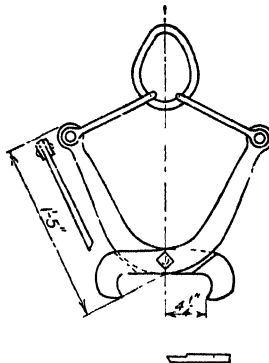

FIG. 15.—Eye bar hook.

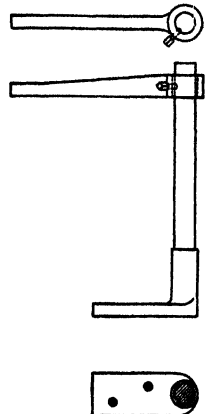

FIG. 16.—Old man.

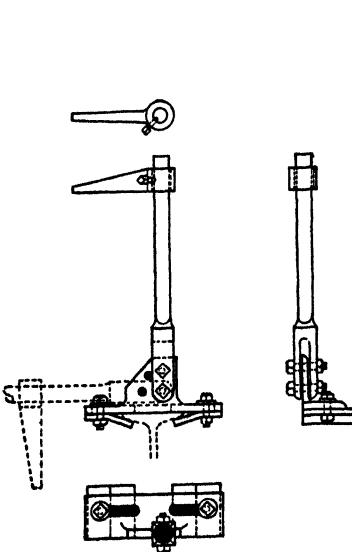

FIG. 17.—Old man wolf.

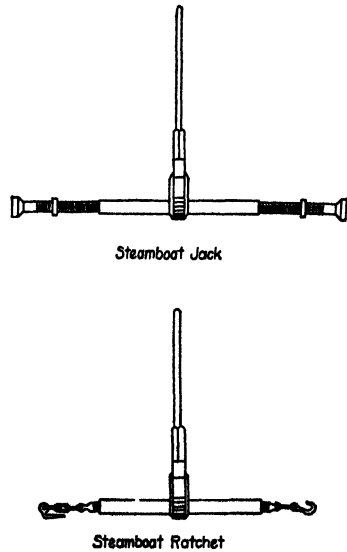

FIG. 18.—Steamboat jack and ratchet.

when a jack of light capacity is wanted to push two members or bodies apart. Figure 18 shows sketches of a steamboat ratchet and jack.

Pilot nuts are placed on pins to prevent injury to the threads or pins and to facilitate the driving of the pins through the various members. Short pilot nuts

are used in places where there is not enough room for the long pilot nuts. Sometimes a gas pipe is used as a toggle to support the eye bars during the assembly of the joint. The pilot nut is then inserted in the gas pipe and the pin driven. Driving nuts are fastened to the pins to save them from mutilation from the concussion of the ram which drives the pin. A variety of pilot and driving nuts are shown in Figs. 19 and 20.

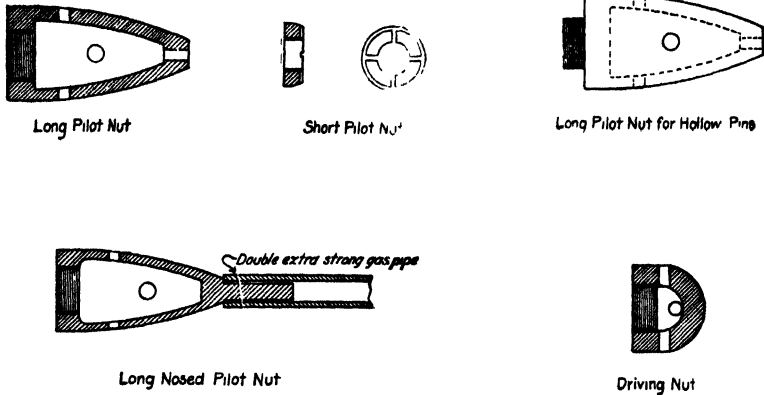

FIG. 19.—Pilot nuts.

FIG. 20.—Pilot and driving nuts.

A timber buggy (Fig. 21) is used to move heavy timbers and beams by hand, especially when not in proximity to tracks or derricks.

I-beams and other structural shapes are more easily moved along tracks by means of rail jacks (Fig. 22). The steel is supported on the jack which is rolled on a rail the rim of the wheel being concave to hold to the rail.

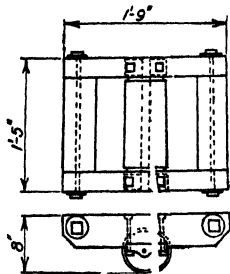

FIG. 21.—Timber buggy.

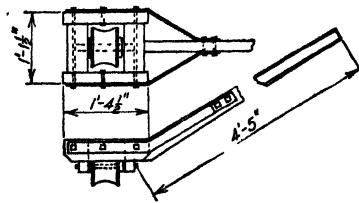

FIG. 22.—Rail jack.

In modern erection, an erecting outfit is not complete without the acetylene torch. Acetylene and oxygen gases under pressure are emitted through a nozzle furnishing a flame of such intensity that steel as thick as 12 in. is penetrated. In field operations, the torch replaces the laboriously slow processes of chipping and sawing by hand with a hack saw, and moreover opens up possibilities in welding. Briefly, the acetylene torch is used for cutting pieces to the correct length if too long, cutting off corners which interfere, cutting members apart on repair work, burning holes and reaming to size as a substitute for

drilling, welding cracks on unimportant members, sometimes welding seams in lieu of calking and in certain classes of work, the flame has been used for spot welding. In a case reported, the plates of a steel ship were spot welded while the ship was on the ways. In another case, the field connections of a small mill building were spot welded instead of being riveted.

5. Pinning, Bolting and Riveting.—The field connections of all steel structures are riveted or connected with permanent bolts. The use of bolts, however, should be restricted to such connections not in shear or bearing nor subject to vibration of live loads. These restrictions will limit its use to light material generally of nominal stress—as, for instance, purlins walkways, handrailing, girt framing, monitors and spandrel details.

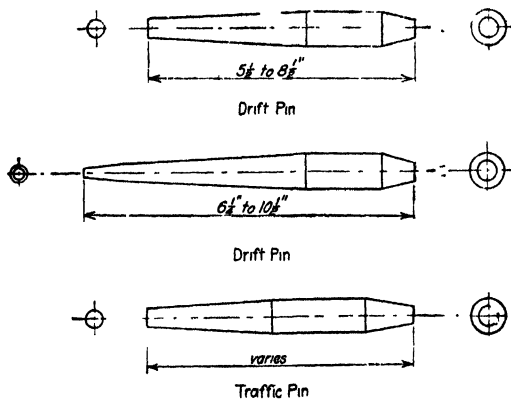

FIG. 23.—Drift and traffic pins.

The field bolting is more economical than the riveting but should only be permitted for unquestionable connections, the riveting being safer if any doubt exists. In bridge work, all connections should be riveted, the exceptions being for the shoe connections and the handrailing. In office buildings, the connections should be riveted except for such minor details as stairways, handrailing, spandrel supports for stone or terra cotta, etc. In mill buildings, purlins, girt framing, monitor framing and such bracing not subject to crane vibrations may be bolted. In tank and hopper work which is always specified to be air-, water-, dust- or oil-proof, the connections must be riveted. In such rare cases where bolts must be used, lead washers are placed under the heads and nuts to prevent leakage.

Before the general use of air in the field for driving rivets, the rivet heads were formed by means of a maul hammering on a hand set which was held over the hot rivet. Rivets thus formed were properly called hand rivets. With the advent of compressed air and pneumatic hammers for driving rivets, the name hand rivets was retained for designating pneumatic hammer rivets, in distinction from the rivets called power rivets driven by air of high compression, hydraulic or electric power in the structural shops.

When the members of a structure are raised in place, the connections are "pinned" together with drift pins. The drift pins are tapered and completely

fill the holes, thus holding the connections securely in place which loose fitting bolts cannot do. The connections being lined up properly, fitting up bolts are used to draw the various thicknesses of metal together. Drift pins and traffic pins, samples of which are shown in Fig. 23, are of different diameters to conform to the sizes of the holes and of different lengths to suit large variations of the thicknesses connected.

The number of drift pins and bolts used will depend upon the nature of the connection. On trusses, a small number of drift pins and bolts are necessary for the top chord splices as the bearings carry the stresses. It is usual to rivet the top chord splices after the span is swung. The bottom chord splices of riveted trusses are usually riveted up before the span is swung. When this is not done, possibly one-half of the holes must be filled with drift pins and one-quarter with

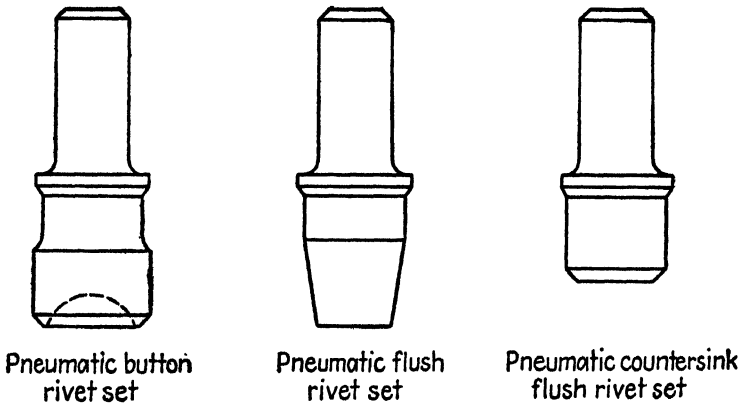

FIG. 24.—Rivet sets.

bolts to carry the tension across the splices. The number used will vary with the ratio of the dead load (as swung) to the total dead and live load designed for the finished structure. The floor beam connections to the posts may be riveted up before swinging the span but it is best to rivet up the stringer connections afterwards. All diagonals of the trusses and horizontal bracing should be riveted up afterwards.

There are several operations employed in riveting—namely, heating the rivets in a hand forge at a convenient location close to the place of driving, catching and entering the hot rivets in the holes, bucking up the rivets on the side opposite to the driver and forming the rivet heads (called *driving* the rivets). A rivet gang consists generally of the rivet heater, the man who catches the hot rivets in a bucket and inserts them in the holes with a pair of tongs, the man who bucks up the rivets and the man who drives the rivets. The rivets are heated in hand forges, rivet pots or in electrical heaters. The familiar hand forges need no description. The rivet pots are receptacles for holding the coal or coke and the rivets. These pots are provided with a grate at the bottom and compressed air is passed through the fuel for heating the rivets, thereby eliminating the work of turning the hand fans as required for the hand forges. The electrical heaters are capable of heating a number of rivets simultaneously depending upon the size of the heaters. The rivets are heated by passing an electrical current through them.

The heads are formed with sets made of various sizes to conform to the diameters of the rivets (see Fig. 24). In the figure the sketches show sets for forming full heads and for making flat and countersunk flush head rivets. There are several pneumatic riveting hammers, the Thor and Boyer hammers being two of those well known. The long hammers are 26½ in. in length and the short hammers 21½ in., space for which must be provided in designing and detailing to make the driving possible. Figure 25 is a sectional view of a Boyer air-cooled

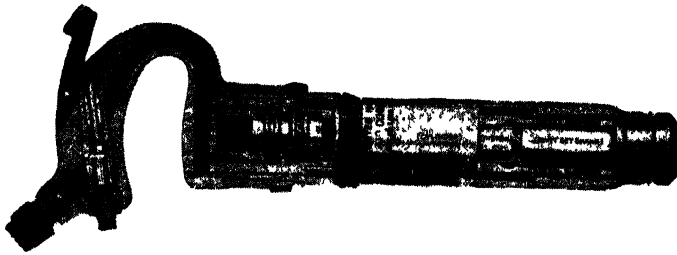

FIG. 25.—Sectional view, Boyer air-cooled riveting hammer (Courtesy of Chicago Pneumatic Tool Co).

hammer, made by Chicago Pneumatic Tool Company. The table below gives pertinent data regarding all sizes of Boyer air-cooled and non-air-cooled riveting hammers.

BOYER AIR-COOLED RIVETING HAMMERS

Size and style	Capacity rivets (in.) (hot)	Diameter piston (in.)	Length stroke (in.)	Blows per min.	Over-all length (in.)	Set shank letter symbol		Weight (lb.)	
						Straight shank	Parker taper shank	Net	Shipping
10 superior	¾	1¼	4	1,525	14¾	S	T	15¾	19
50	¾	1¼	5	1,400	16	S	T	18¾	21
60	¾	1¼	6	1,340	17¾	S	T	20¾	25
80	1¼	1¼	8	1,050	19¾	S	T	22¾	25

NOTE:—Above hammers can be furnished in non-air-cooled type, if specified.

BOYER NON-AIR-COOLED RIVETING HAMMERS

40-ES (ex. short)	¾	1¼	4	1,525	8¾	S		17	18
90	1¼	1¼	9	910	20¾	S	T	23	26
80-X	1¾	1¾	8	950	20¾	S	T	26	29
11	1¾	1¾	11	700	23¾	..	V	28¾	31
60 (heavy type)	¾	1¼	6	1,340	18	S	T	23¾	27
80 (heavy type)	1¼	1¼	8	1,050	20	S	T	25¾	29
90 (heavy type)	1¼	1¼	9	910	21	S	T	26¾	31

The proper bucking up of the rivets in driving is important to get tight rivets. Very often the space available for bucking up is very small and tools of special shapes are used. When space will permit, the ordinary straight dolly is used,

the buckler up pressing the dolly against the rivet head while the head on the other side is being formed. When the hole is located close to the root of an angle or the web of a beam, a goose neck dolly is used. For bucking up rivets in a narrow space, as between the webs of two beams, a heel dolly is used. A bolt hole is provided in the bar in which a bolt with washers is placed to back the dolly against the steel to take the thrust. Dolly bars of the kind mentioned are shown in Fig. 26. Two more kinds of bars, shown in Fig. 27, are called spring

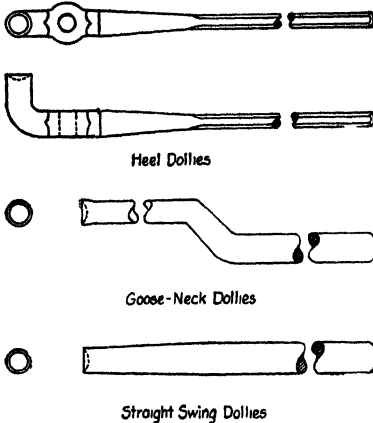

FIG. 26.—Dolly bars.

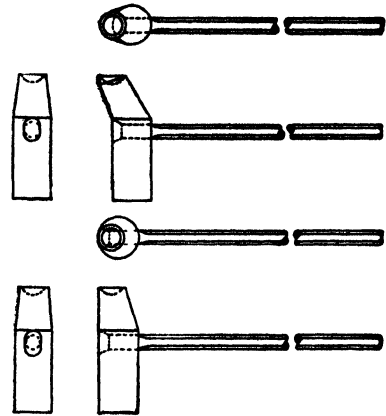

FIG. 27.—Spring dollies.

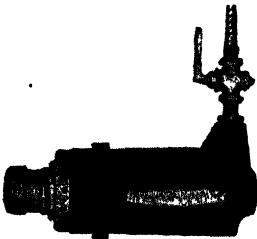

FIG. 28.—Thor buckler-up (Courtesy of Independent Pneumatic Tool Co.).

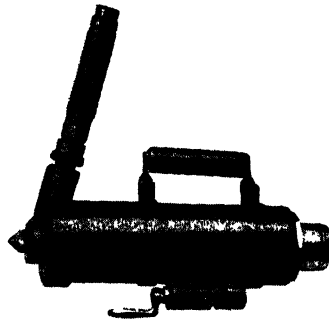

FIG. 29.—Number 50 Boyer hammer holder-on (Courtesy of Chicago Pneumatic Tool Co.).

dollies, having handles of spring steel. The handle is suspended in a hook which acts as a fulcrum in obtaining proper leverage for bucking up the rivets.

For the purpose of obtaining a constant pressure in bucking up and thus getting tight rivets, a Thor buckler-up made by the Independent Pneumatic Tool Co. (Fig. 28) is frequently used. The rivet set is held against the rivet head, and compressed air is admitted through a valve operated by a handle and exerts a constant pressure against the rivet while the rivet is being driven.

A hammer type holder-on (Fig. 29) made by the Chicago Pneumatic Tool Company, is similar in action to a pneumatic hammer but is used for bucking up.

The holder-on point at the end makes it possible to brace the hammer by using as many filler blocks as necessary.

When space will permit on the bucking-up side, erectors have also used two driving hammers, one for driving and one for bucking up.

In cutting out rivets, the rivet heads are knocked off and the rivets backed out of the holes. A few of the many tools used for this purpose are shown in Fig. 30. Another tool for cutting off rivet heads is a rivet cutting gun which is operated with compressed air. These have been found very useful on heavy work for cutting out the larger sizes of rivets. In the erection of heavy work, the equipment is not complete without at least one rivet cutting gun.

6. Methods of Erection.—There are different methods used in the erection of structural steel depending upon the equipment available, preference of the erector, type of the structure, size of the structure, maintenance of traffic during erection, time permitted for the erection and the risk to be taken. Naturally the equipment closest to the site which will do the work required will be used

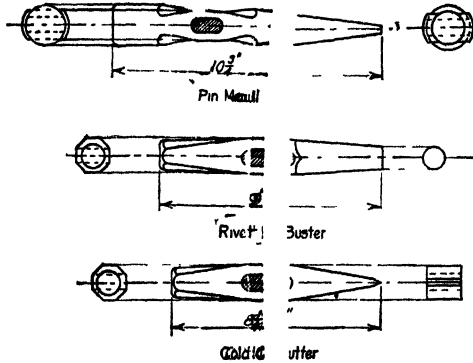

FIG. 30.—Hand tools for cutting out rivets.

in preference to the purchase of any new equipment which may give better service. Different erectors will prefer different methods at times for erecting the same kind of work. The type of the structure is a determining factor, of course, as different equipment is required for office buildings than for viaducts or bridge spans. The sizes of the members determine the size and number of booms used, etc. Ordinarily in erecting a truss span, a derrick car might be used but if a new span is built around an old span and it is necessary to maintain traffic, then an overhead traveler must be used. If the time of erection is limited, it may be necessary to start erection simultaneously from both ends of the structure or add more equipment in the way of derricks, etc., all of which greatly adds to the expense of the erection. The question of the risk taken is very important—for instance, the danger of a flood or of ice floes may make it advisable to use cantilever erection instead of falsework, or the prevalence of high winds may affect the sequence of erection.

In emergencies, the erectors are ingenious in accomplishing a great deal with very simple appliances such as crow bars, rollers, jacks and hoisting tackle.

6a. Girder Spans.—Under certain conditions, deck plate girder spans can be assembled, riveted at the site and rolled into place. It is customary,

though, to rivet up deck spans up to 60 or 70 ft., either in the shop or at the site. The spans up to 40 ft. in length are erected to advantage with a locomotive crane; spans over this length with a derrick car.

In the erection of through plate girder spans, the main girders are placed first and then the floor beams and stringers panel by panel. If traffic is to be maintained, the floor system is erected first on falsework and the girders placed afterwards.

The erection of a deck girder span is shown in Fig. 31. The span is riveted up complete, ties laid and raised in place with a locomotive erecting crane.

6b. Riveted Truss Spans.—The erection of truss spans requires the use of falsework, except for the shorter spans of 100 to 125 ft. in length. These short trusses are usually riveted up complete at the site and swung into place with a derrick car or locomotive crane. The floor is then erected in place and connected to the trusses.

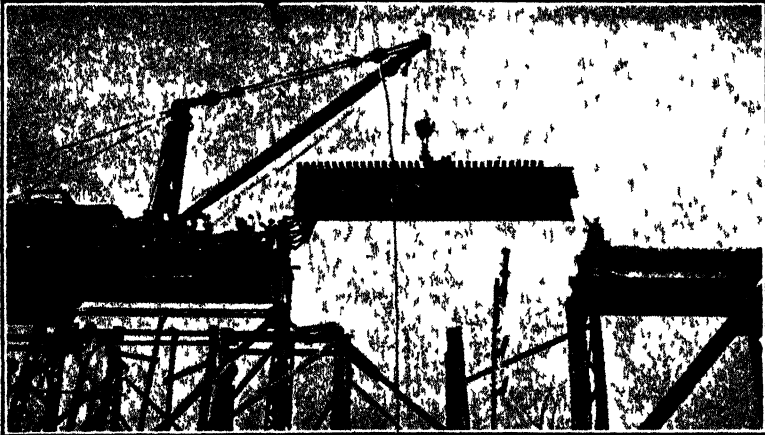

FIG. 31.—Girder span erection.

One of the methods used in erecting through riveted truss spans is to assemble each panel of a span complete before proceeding to the next one. Thus, the shoes and first bottom chord sections of one end are placed first and the floor system between these chords set, the end posts and web members are bolted to the bottom chord gusset plates, and then the top chords, portal strut and top lateral bracing completes this braced section. Similarly the second bottom chord sections, floor, truss members and top chord bracing follow and other sections until the entire span is erected.

It is customary in the erection of through riveted truss spans to put the floor system in first, then put the lower chords in place, set up the web members and put the top chords on last. It is more advantageous to have the gusset plates connecting the web members with top chords riveted to the top chord sections rather than to posts or diagonals, as the rivets in the gusset plates connecting the top chords with the web members are more easily driven in the web members than in the top chord sections.

The erection of riveted truss spans with a traveler is shown in Fig. 32. The structure is a bridge at Bismarck, North Dakota, consisting of three 476-ft.

riveted truss spans. In the picture, one of the spans has been swung and the false work removed; another span has been partly erected.

6c. Pin Truss Spans.—Pin truss spans are erected generally with derrick cars or locomotive cranes and occasionally with travelers. On highway structures where the concentrated load of a derrick car or locomotive crane will not permit the use of this equipment, it is necessary to use a traveler. In other cases, a derrick car or locomotive crane is usually more economical. The locomotive cranes are more valuable for the shorter reaches; the derrick cars for the longer ones. It is customary to put the floor system in first and erect the trusses afterward. This method has a great many advantages over that of raising the trusses first: (1) There is a great saving in falsework, as longer panels can be used, putting bents directly under the panel points and using the new floor system for carrying traffic and running out material for the trusses; (2) it permits the posts to be bolted to the floor beams and released from the tackles on the boom; (3) it

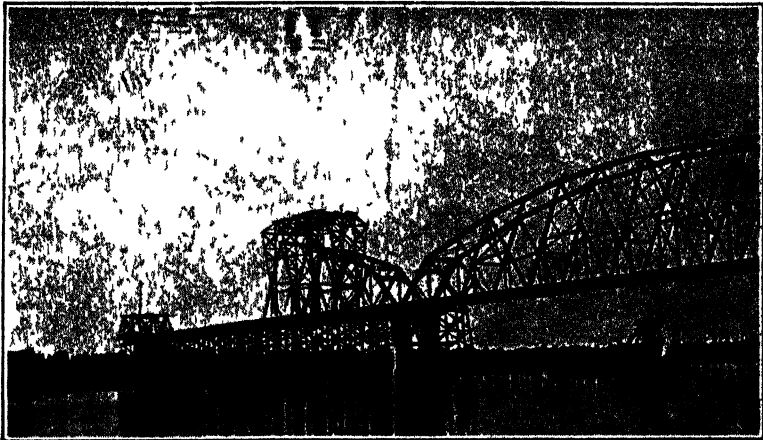

FIG. 32.—Riveted span erection.

fixes the exact position of the shoes on the piers so that the erection may proceed from the center either toward the fixed or roller end; (4) it has the advantage of giving more opportunity for jacking up the spans to secure the proper camber; and (5) it requires a minimum amount of blocking.

The erection of a pin truss span begins with the placing of the entire floor and the bottom chord eye bars. The center panels of the trusses are erected first as these panels have adjustable members and the trusses can be squared up before proceeding to the other panels. The details should be arranged so that the center panel can be completed and made self-sustaining before the derrick car or locomotive crane is moved. In erecting a panel of the truss, the posts are bolted to the floor beams. The diagonal eye bars are held up by the boom while the bottom chord pins are driven, the top chord section is then placed in position and the top chord pins driven. It is usual to proceed from the center panel toward the fixed end, and after this half of the span is erected, to proceed toward the roller end. It is especially desirable in heavy work that the top chord sections can be lifted above the posts and set directly in place without being moved on

end or sidewise. Therefore, in heavy work, the splice plates connecting two adjoining chord sections should be shipped loose

Over dangerous streams, where there is a possibility of the loss of the steel during erection, it is sometimes desirable to erect the trusses first, so as to have as little material on the falsework as possible, thereby reducing the amount of material in danger. On heavy truss spans, and this applies to both riveted and pin spans, the end posts and top chord members must be raised into position at



FIG. 33 —Driving top chord pin



FIG. 34 —Driving bottom chord pin.

the inclination the piece occupies in the truss. This is especially true of the end posts and inclined top chords which are very difficult to hold at the proper angles for making the connections. To overcome this difficulty, a pair of angles with a cross bolt, called *erecting hitch*, is sometimes bolted temporarily to the top of the member and located at the center of gravity of the member to give the proper inclination. The hoisting hook is fastened to the bolt of the hitch and raises the member at approximately the angle required.

Figure 33 shows the method of driving a top chord pin. The pin with a pilot nut to guide it, and a driving nut to protect it, is held suspended by the falls of the boom. A rail held up by a runner line is the ram. By moving the ram backward and forward, the pin is driven into place.

Another view of driving a pin is shown in Fig. 34—that of a bottom chord pin. The picture shows the pin and-eye bars being held up and the ram in contact with the driving nut.

6d. Floating Spans into Position.—Under certain conditions truss spans are assembled on scows, riveted up complete, floated to the site and anchored to the piers. This method of erection will save the falsework and is of particular advantage when the steel can be shipped easily to sites for assembling. The depth of the water, of course, must be great enough and water conditions such that this method of erection is feasible.

The span is assembled on two or more scows as required, riveted up and the scows towed to the bridge site. If the span is erected high above the water, the span is raised to position on the piers. If a low span, it is assembled on the scows, cribbing being used to bring the span at an elevation somewhat higher than required to rest on the piers. By means of guy ropes, the span is brought to the correct position over the piers and lowered by ballasting the scows.

The same method of erection may be followed in erecting trusses. After the trusses are in place, the floor system is set by running out the material from one end.

The channel span of the Quebec Bridge was erected on scows and floated into position. By means of specially designed lifts, the span was raised into position to the correct elevation.

Figure 35 shows a truss which was assembled on a scow, floated to the bridge site and raised to the top of the piers with a gallows frame at one end and a derrick at the other end.

6e. Cantilever Erection.—A cantilever bridge is one in which the spans are carried continuously over the piers, the stresses in each span thereby being reduced due to the negative moments developed at the pier points. A sketch showing the cantilever portion of the Kennewick-Pasco Bridge over the Columbia River is shown in Fig. 36. This part of the bridge was erected by the method called cantilever erection. The erection started with travelers at both ends simultaneously and advanced towards the center of the bridge, panel by panel.

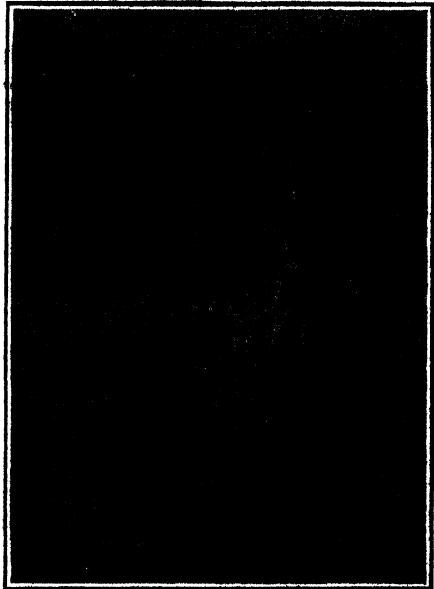

Fig. 35.—Truss floated into position.

Sometimes a bridge composed of simple spans cannot be erected as simple spans on falsework on account of the deep gullies or deep and fast running waters spanned and must be erected by the cantilever method. The bridge designer must be familiar with the erecting program to be used and it is advisable that he consult with erectors for this purpose as the entire design depends upon the plan of erection. Not only must the finished structure carry the dead and live loads

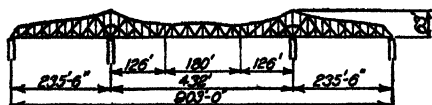

FIG. 36.—Cantilever bridge.

and the wind forces but the members must carry the stresses imposed upon them during erection. The bottom chords of the trusses which normally carry tension under dead and live loads are in compression when the trusses are cantilevered and the top chords which are in compression in the finished structure are in tension during erection. Special members and mechanical devices must be designed which are used only during erection.

The following description will serve to illustrate some of the many phases of cantilever erection. The example taken is that of a bridge composed of simple spans but on account of the high towers and deep water, falsework could not be used and cantilever erection was resorted to. The completed bridge is shown in Fig. 37. It is a deck structure composed of three 250-ft. riveted truss spans, one 60-ft. and two 90-ft. approach spans, three towers 120 ft. high and one bent supporting the 90-ft. spans. The erection will begin from the pier 1 end. Either a traveler or a derrick car could be used for moving out the material but in this description a derrick car is used. As it is very important that the erector use the same methods and sequence of erection which was used in designing the

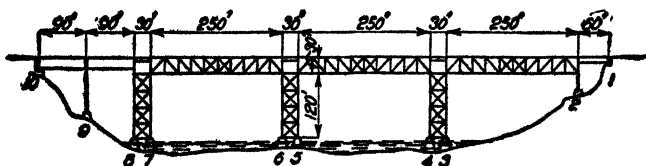

FIG. 37.—Bridge erected by cantilever method.

structure and erecting appliances, it is customary to issue a book of instructions to the erector for work having difficult erecting features.

To set the first span, 60 ft. long, it is necessary to erect the end posts and bracing of the truss span at pier 2. The bent can be set with the derrick car but if the reach is too long for the weight handled, the posts and bracing can be erected with a gin pole or A-frame. When the bent is properly secured in place, it is an easy operation to swing the 60-ft. span on to the seat of the bent and abutment. The track is then laid on the 60-ft. span and the derrick car moved ahead ready for the erection of the truss span 2-3. The span 2-3 cannot be erected as a cantilever span as sufficient anchorage cannot be obtained at the shore end to carry the unbalanced weight of the span if erected as a cantilever. It can be erected on falsework but because of the height of 120 ft. to be built up, a simpler method was adopted as indicated in Fig. 38. One of the permanent towers was temporarily set up between piers 2 and 3 upon which two sand jacks were placed. The first part of the span was cantilevered out, suitable anchorage being made with

the 60-ft. approach span and the abutment, until the portion of the erected span rested on the jacks. These jacks were placed at such an elevation that the free end of the span, when erected, would be about 15 or 16 in. above the top of the tower—otherwise, if the free end of the span was erected below the level of the top of the tower, the free end of the span could not be raised to the correct elevation. The derrick car is advanced as far as the temporary tower will permit and the tower on piers 3 and 4 is erected, after which the remainder of the truss span is erected complete, the projecting span being balanced by the part of the span between the temporary tower and pier 2. The sand is emitted from the sand jacks until the span rests on the bent at pier 3 and the temporary tower is removed.

Span 4-5 is erected as a cantilever for its entire length. Tension members with screw devices are provided to connect span 2-3 with the span to be erected along the line of the top chords and similar compression members and screw devices at the bottom chords. Toggle arrangements and hydraulic jacks have also been used for the same purpose. The truss span is erected panel by panel, the derrick car moving successively forward after each panel is completed.

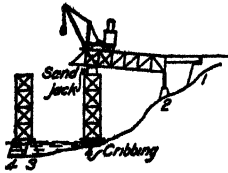

FIG. 38.—Erection of span 2-3.

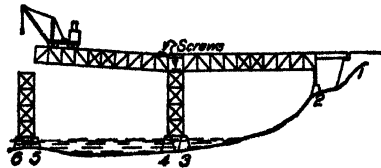

FIG. 39.—Erection of span 4-5.

When the span is erected, the tower is placed and the span lowered to rest on the tower by releasing the screws (see Fig. 39).

Span 6-7 is erected similarly to span 4-5. In erecting the 90-ft. girders, if it is found that the reach and weight are beyond the capacity of the boom, the erector sometimes counterweights the girder. Thus, if the reach without counterweighting is 45 ft., he may reduce the reach to say 30 ft. by adding weight to the short lever arm of the girder.

6f. Viaducts.—Gin pole erection was formerly used for viaducts. The bents were bolted up on the ground and then raised in place with a gin pole. For rapid erection, a second gin pole would raise the girders.

At present, derrick cars are generally used to erect viaducts. Travelers are used for light highway structures which cannot sustain the weight of a derrick car. The boom must be long enough to erect a tower in advance with the derrick car or traveler on the completed portion. The erection continues forward span by span, the derrick car or traveler advancing as fast as the span ahead is erected.

The erection of a viaduct over railroad tracks offers the opportunity of utilizing the railroad tracks for handling the material and raising the steel. The erection of the 18th Street Viaduct, Kansas City, Fig. 40, is an example of this kind. A locomotive erecting crane is raising the steel from the railroad tracks below the viaduct.

6g. Office Buildings.—In the erection of most steel office buildings, the available space for storing material is limited. The shipments of steel, therefore, are generally in lots in the sequence of erection. Stiff leg derricks, guy

derricks or A-frame derricks are used to raise the material. If the building covers a large area, possibly as many as four derricks erect the steel to hasten the erection. Sometimes, the building is constructed in two sections, one section at a time replacing the old building and thus permitting the owner to occupy one-half and then the other half during the erection of the building.

It is customary to erect an office building in tiers of two stories each. After the grillage and bases are set, the basement tier of columns is raised by two booms from the ground level. The beams and girders for two floors are lifted into place and the upper floor temporarily covered with planking to minimize the risk to the men. The temporary floor also provides space for sorting the material for the next tier. Upon completion of each tier of columns and beams, the derricks are raised to the higher level for the erection of the next tier, the



FIG. 40.—Viaduct erection.

process being repeated until the roof is reached. When two derricks are on the ground, each raises the other to higher levels.

In the erection of some buildings, derricks have been used which were lashed to columns of an adjoining building or to columns of the new building. Other material such as stone, terra cotta, etc., also is raised by this means.

When the building contains two or more basements, the basement floors usually are not erected until some of the upper floors are in place. The column caissons are poured, the grillage and basement columns set after which the first floor is erected complete. As the erection proceeds upward, the excavation for the basements is begun, retaining walls constructed and each basement floor erected as the excavation progresses. The basement floors are designed to carry the thrusts of the earth work on the retaining walls.

An exception to the ordinary method of erecting office buildings is that of a tiered building not exceeding 100 ft. in height. This type of building can be erected very economically with a locomotive crane provided there are railroad facilities for delivering the crane to the site. The shipment of steel must be made in vertical tiers rather than horizontal tiers as is the case with derrick

erection. The erection by a locomotive crane is by complete vertical sections from the basement to the roof.

The first section of the Illinois Merchants' Bank Building, Chicago, is shown in Fig. 41. Two guy derricks were used to raise the steel. When completed, the building occupies a city square and contains about 15,000 tons of steel.

6h. Mill Buildings.—The mill buildings are usually divided into one or more aisles, each aisle carrying an overhead crane. The length of the building is spaced into bays, the bays varying in accordance with the crane loads and the structural design.

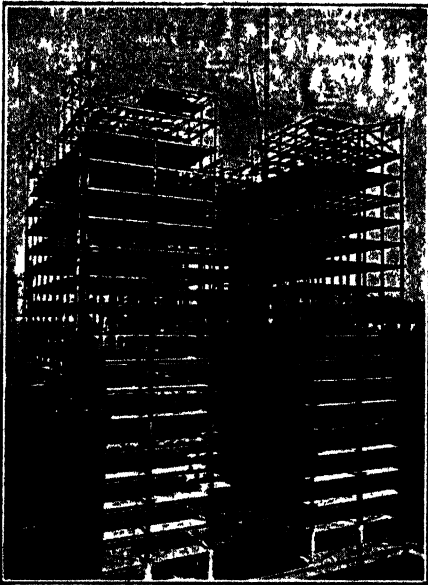

FIG. 41.—Office building erection

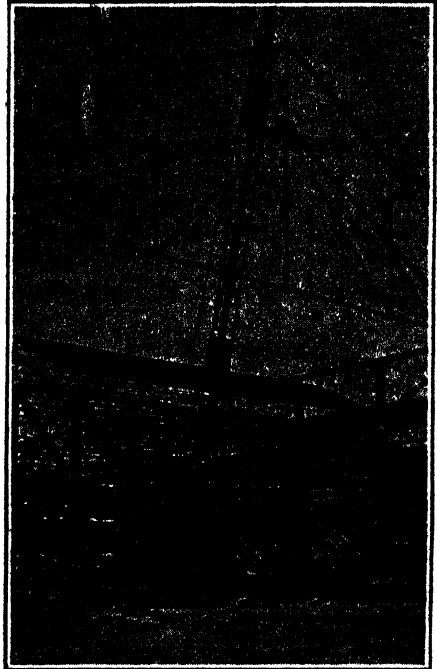

FIG. 42.—Mill building erection.

For the smaller buildings, say with three aisles, the simplest erection is to run a track through the center aisle and raise all of the steel in the three aisles with the boom of a locomotive crane. The crane picks up the material by running back and forth and completes each bay at a time.

If the aisles are wide and the building stands high above the ground, a similar method of erection can be used by placing two tracks in different aisles and using two locomotive cranes.

The roof trusses are riveted up on the ground before erecting in place. Figure 42 shows a locomotive erecting crane hoisting a complete roof truss.

7. Details to Facilitate Erection.—When designing and detailing structural steel, consideration should be given to good designs of ample strength, economy in weight, simplified shop work and easy erection. Any care used along these lines has the effect of giving the owner a better structure at a minimum of cost. Too much importance should not be attached to any one of these items at the

expense of the other. It is possible to design with the utmost economy in the weight of the steel at the expense of increased shop costs; or the shop details simplified to the extent that the erection costs are increased in greater proportion than the saving in shop work; or the details arranged for easy erection at a sacrifice of good designing and shop work. The decisions made by the engineer should be based on the economy to the customer of the structure as a whole.

(1) *Avoid as Far as Possible Entering Connections.*—When it is necessary to slide a member into a connection without having any leeway vertically or horizontally to move the member, the connection is known as an entering connection. An example of such a connection is sometimes seen on the top chord of a truss when the splice plates are shop riveted to the four sides of the chord. Entering connections are usually the most difficult and expensive to make, and where at all possible should be avoided, but, where they must be used, particular attention should be given to the necessary clearances. An entering connection is not only an expensive and dangerous operation but in a great many cases it cannot be accomplished on account of the interference with back walls, adjoining spans, etc.

(2) *See That Proper Clearances Are Given.*—It is very important to allow ample clearance when members are packed in chords, posts, etc., as lack of sufficient clearance causes trouble and expense, not only increasing the cost of erection by requiring more time to make the span safe, but adding to the risk. In putting in tie bars and diagonals, it is customary to connect them on the bottom chord pins first, and then swing them into the chords and posts around the lower pins as a center. All rivet heads coming in the path of the bars swung in this way should be cleared.

(3) *Minimize the Number of Field Rivets.*—Particular attention should be given to the question of arranging the connections with a view to using a minimum number of field rivets as far as possible. Shop rivets are more economical to drive than field rivets and besides are practically all machine driven rivets as compared with the hand driven field rivets. Shop rivets should preferably be used instead of field rivets provided: (1) That the sizes and weights are such that minimum carload shipments may be obtained; (2) that the shipping pieces are not too bulky or involve too much risk to handle; (3) that the members conform in size to the train clearances; and (4) that the weight of any one piece is not too great for the lifting capacity of the erecting equipment. The connections should be arranged to suit the method of erection decided upon.

(4) *Details Arranged to Permit of More Than One Method of Erection.*—An example of this is the floor system of truss spans which may be erected either before or after the trusses have been erected in their final position. The floor connections and packing of posts and bottom chords should be detailed so that either method may be used. The illustration given is only one of many details occurring in the erection of all classes of structures. An adherence to this fundamental principle of erection is very important as the erector does not, always know in advance the conditions which may arise and decide what the sequence of erection shall be.

(5) *Attention Should Be Given to the Field Connections So That Enough Space Is Allowed Around All Field Rivets to Enable Them to Be Driven.*—There should be sufficient space for bucking up and for the driving of the rivets. Moreover the

location of the field rivets should permit accessible driving, as far as possible, without the use of expensive scaffolding.

(6) In all work, as far as practicable, the details should be arranged so that the members can be swung into position without shifting from their final position the members to which they connect.

(7) Stiffeners to which cross frames or floor beams connect should not be crimped, but have fillers. The outstanding legs should preferably be not less than 5 in., and never less than 4 in. Open holes in stiffener angles should be gaged so that the cross frames can be swung into place without spreading the main girders. The cross frames or floor beams should be so detailed to permit them to be swung into place without interfering with the rivet heads in the main girders. When the cross frames of deck spans connect to the top and bottom flanges of the girders, $\frac{1}{16}$ -in. clearance should be allowed at both top and bottom.

(8) The details should be made so that the members can be placed in their final positions before riveting is commenced.

(9) Generally all girders or beams should rest on the tops of columns or other members or on erection seats. This arrangement will give the easiest erection with the minimum amount of risk and will save pinning the connections together when the members are brought into place. The erection seats are not necessary for light beams framing into columns or girders but are desirable for heavy beams and girders. When erection seats are used, a clearance of $\frac{1}{8}$ in. should be left between the bottom of the girder and the seat angle to allow for inaccuracies in setting the seat angle. No clearance should be allowed when the open holes are reamed to a steel templet.

(10) The sections of top chords nearest the center of truss spans should be made with at least two full pin holes. In skew spans, the top chord splices should be located so that the two opposite panels can be erected without moving the derrick or traveler. For trusses with inclined top chords, the top chords should be designed so that each opposite panel of the trusses can be erected and self-sustained before moving the derrick or traveler to the next panel.

(11) At least $\frac{1}{2}$ -in. clearance should be allowed to cover shop variations for cutting, shearing and coping. For riveted web members entering between chords, allow $\frac{1}{8}$ -in. clearance on each side for heavy work and $\frac{1}{16}$ in. for light work. For plates to be inserted between angles, allow a clearance of $\frac{1}{16}$ in. on each side. For beams and girders erected between top and bottom angles, allow $\frac{1}{4}$ -in. clearance under the top angle.

(12) When a beam frames directly into the webs of two columns, to permit the beams to be dropped into place, the rivets above one of the connections should be countersunk or left open for field driving. This will save the spreading of the columns.

(13) Portals and top bracing of truss spans are erected after the pins are driven. Therefore, it is advisable to use long pilot nuts to facilitate the driving of the pins.

(14) In packing eye bars, the following clearances should be allowed: Eye bars 8 in. and under, $\frac{1}{16}$ in. for each bar plus not less than $\frac{1}{2}$ in. between the two sides of the chord; eye bars over 8 in. and up to and including 12 in., $\frac{1}{8}$ in. for each bar plus not less than 1 in. between the two sides; eye bars over 12 in., $\frac{1}{16}$ in. for each bar plus not less than $1\frac{1}{2}$ in. between the two sides.

(15) In packing pin plates, when more than two pin plates are used on a member, allow $\frac{1}{8}$ in. addition for each pin plate.

(16) Clearances should be provided at the ends of girders or beams framing between other members. Girders or beams with milled ends generally have a clearance of $\frac{1}{8}$ in. at each end. Girders or beams not milled at the ends generally have a clearance of $\frac{1}{16}$ in. at each end. In building construction when a beam frames between two other beams, it is customary to provide $\frac{1}{8}$ in. at each end.

(17) For all structures in which girders or beams with end connections occur in long continuous lines, it is necessary to make some provision for the over- or under-run of the steel. This is done in various ways. A good method is to make the girders or beams $\frac{1}{8}$ in. short and supply fills for one-half the number of spaces, the fills being inserted by the erector as required.

(18) Adjustable rods or bars placed close together should have sleeve nuts or turnbuckles staggered.

(19) Girders which frame into the webs of columns should, when necessary, have their flanges notched to clear the rivet heads in the outstanding legs of columns. The clearance provided will permit the erection of the girder without spreading the columns.

(20) In detailing new work adjacent to old work or to walls, the field connections should be arranged so that the rivets can be driven when the new work is placed. Spandrel beams which adjoin old walls should be detailed to swing into place from the inside of the new building.

(21) Girders and stringers which rest in expansion pockets should be set back enough to allow the insertion of the field rivets for the end connection of the adjacent fixed member, as both members are erected before the field rivets are driven.

(22) On deck girder spans and on stringers in through spans, lateral plates and rivet heads should be kept low enough to clear the ties.

(23) It is advisable to shop rivet fillers in place to prevent their loss in transit and also to facilitate the erection as there are less pieces to hold in place when making the connection.

(24) When a long line of field rivets occurs in two or more thicknesses of metal, occasional countersunk rivets should be provided to hold the plates in contact.

(25) As far as practicable, all members should be detailed so that they can be reversed in erection. When the members are not symmetrical and cannot be reversed in erection, one end should be marked to indicate the correct turning of the members.

(26) When two spans rest on a bent, as in a viaduct, the details should be arranged so that either span can be set in place entirely independent of the other. The end cross frames should be detailed to be swung into place from the center of the span.

(27) The overrun or packing out of the cover plates on built-up columns can be neglected for columns with one or two cover plates on each side. For columns with three or more cover plates on each side, an allowance of $\frac{1}{8}$ in. for each plate over two plates should be made.

(28) In replacing an old bridge of more than one span, a separate bed plate should be provided for each shoe.

(29) In special cases where adjustment is needed, it may be advisable to drill certain holes in the field. The erection drawings should contain notes showing the special drilling.

(30) Holes in steel work should be provided for connecting all auxiliary work, such as nailing strips, spiking pieces, skylight curbs, windows, doors, etc. Often, time and labor can be saved in erection by bolting the woodwork in place on the ground before setting the steel in place.

(31) When reamed work is specified, the important connections are reamed to a steel templet or the connections are reamed with the connecting members assembled at the structural shop. With such workmanship, the holes are fair and the field rivets are entered without drifting or cleaning out.

When full size punched work is required, the connections are punched with full size holes, no opportunity being given to check the fairness of the holes. It should be understood that with this class of workmanship, a certain amount of drifting and cleaning out of holes should be considered as a legitimate part of the erection.

SECTION 10

ESTIMATING STEELWORK

1. Estimating in General.—Before the cost for structural steel can be determined it is necessary to have an accurate and carefully prepared estimate of the weight of every piece of steel that is to be included. From this weight or tonnage the cost data are made up, and these in turn are used to estimate the final amount of bid or selling price.

Estimating structural steel is a matter of figuring weights rather than costs. The estimator is rarely called on to consider the question of prices and costs, or assist in the preparation of bids. He is concerned solely in making up a complete detailed summary of the weight of the steel in the structure, and from this estimate the costs will be made up by the manager of sales, general manager, or some officer of the steel company, who has had long experience in preparing bids, is familiar with current prices, and market and trade conditions, and who must assume full responsibility for the correctness of the quotation, after it has been sent out.

2. Estimating from Plans Made by Architects.—Estimates of weight of the structural steel for buildings are taken from plans made by architects. These plans, together with the accompanying specifications, should offer complete information and data required by the estimator. Architectural plans with the exception of details for special connections are usually drawn to $\frac{1}{8}$ - or $\frac{1}{4}$ -in. scale.

The lengths of the members are not given on the plans but must be scaled. Distances center to center of columns, out to out of walls, story heights, dimensions of stair halls, elevator shafts, etc., are all clearly indicated, and enable the estimator to calculate closely the lengths of the different pieces of steel shown in the design.

The steel framing is sometimes shown in dotted or broken lines on the architectural plans, but it is always preferable to have separate framing plans drawn for the steel construction. The liability of error on the part of the estimator is greatly minimized if he is not obliged to take off the steel from the architectural plans, which have so much information on them, that it is often a difficult matter to find all of the steel, and make an accurate estimate.

3. Estimating from Plans Made by Engineers.—Estimates of the weight of steel for highway and railroad bridges, and similar structures, are usually made from plans and specifications prepared by engineers. Plans furnished for estimating this class of work are usually more complete than those provided for buildings, and show the stress sheets, loading diagrams, plot plans and profiles, location plans, general design with sizes, and members detailed to scale. For a small bridge, the complete design and detail may appear on one sheet.

Specifications for bridges are of equal importance with the plans, and will contain much of the information required by the estimator.

Bridge specifications should be carefully read and analyzed by the estimator, before starting work, as the requirements in different sections of the country, and the standards of the various railroad and county engineers will vary as to the allowable loading, impact stresses, provision for wind, formulas for calculations, and character and physical properties of the materials specified, and this will tend to have a considerable effect on the weight and consequently the cost of the structure.

4. Qualifications for Successful Steel Estimator.—A successful steel estimator should have had some previous experience in steel design, a thorough training in structural steel detailing, and should be familiar with and have some knowledge of modern shop practice and erection methods.

He should be of a studious disposition, careful and accurate in his work, with the ability to concentrate, and should have patience and perseverance. He should also enjoy the best of health, as the work is very trying.

Estimating structural steel is rush work, very little time being allowed for taking off the steel. It is frequently necessary for an estimator to do considerable overtime work.

5. Estimating Procedure.—The work of estimating must be handled in a systematic manner, and while the methods employed in different fabricating shops may vary somewhat, the following plan will illustrate the usual procedure employed for making a structural steel estimate.

Plans and specifications are received in the contracting office, from owners or builders, who request a bid and fix definitely the date on which the quotation must be sent out. Established concerns will receive many such requests, unsolicited, but depend in the main on the work of salesmen and solicitors who are employed not only for the purpose of securing contracts, but also are expected to seek new business, arrange the preliminaries, investigate building reports, and get information on proposed work at the earliest possible date.

When a set of plans is received with a request for a bid, the sales manager should decide whether the job will be figured or not. It is often impossible to estimate all of the proposed work, and for various reasons, many of the plans have to be returned without a quotation.

If the estimate is to be made, the job is given an estimate number, and the plans, specifications and all information at hand are sent into the estimating department. This estimate number should appear on all papers in connection with the particular work, and it is always advisable to have the date stamped on each sheet, in connection with the number.

For future reference a record should be made in a book filed in the office and the entry should include the estimate number, date, description of job, location, name of owner, or purchaser of steel. Every estimate made should be listed in this book.

The plans and specifications are then handed to the estimator who is to make the "take off"—that is, he will be required to list every piece of steel shown on the plans, scale the length, give the number of pieces of each kind and size, and check off on the blue prints, preferably with a colored pencil, each piece of steel that has been taken off, and which is entered on the estimate sheets. At the

top of each page of the estimate will appear the estimate number, date, sheet number and the initials of the man who made the estimate.

The sheets of the estimate are numbered consecutively, and when the entire job has been taken off, the sheets are handed to an assistant, who is employed to make the extensions—that is, he is required to calculate the weight of all the steel which the first man has listed. This result is obtained by multiplying the weight per linear foot by the length of the piece, and if there is more than one piece in any item, it is necessary to multiply the weight of one by the total number required.

After the weight of each item has been entered in the proper place, it is required to sum up the weights of all the items on the sheet, and the total weight or tonnage for the sheet is entered at the bottom. It is always advisable to keep the totals of each sheet of the estimate separate and then add the totals of all the sheets together for the final summary. This method minimizes the chance for errors, and if any changes have to be made on any particular sheet, it can be done without reference to the others. The summation is simplified, as it is easier to add the totals of the different sheets, than it is to carry forward from one sheet to another.

In making up the estimate, it is first necessary to find the cost of the plain material purchased from the mill. This refers to the steel shapes delivered to the shop, and before any fabrication has been started.

Certain shapes are sold by the mill at the base price, which is the minimum, and all others take an extra, which must be added to the base price to find the cost. In making up the estimate the different classes of material must be separated in the summary, so that the exact cost of all the steel can be calculated. Allowance must be made for all extras and specials.

The base price for Standard steel shapes used in fabrication applies to beams 3 to 15 in. deep, channels 3 to 15 in. deep, and angles 3 to 6 in. for one or both legs (and if $\frac{1}{4}$ in. thick or over).

Steel plates suitable for structural purposes are sometimes sold at the base price, but as this does not always hold true, it is necessary to make a separate item of plates in the estimate. Bolts, nuts and rivets must also be kept separate in the summary, as the price is somewhat higher than for the shapes, and they will be purchased direct from a dealer.

The steel shapes which are known as wide-flange are of lighter weight than the Standard shapes of equal depth and strength, but as they take a slightly higher price, the wide-flange shapes must be separated from the Standard in the estimate. The rate of extras varies for different classifications of wide-flange beams, and so all beams with the same extra price should be grouped together.

In order to find the cost of the bought material delivered at the shop from the mill, the summary estimate sheet should be divided as follows:

PLAIN MATERIAL CLASSIFICATION

- | | |
|--|------------|
| (1) Standard beams..... | 3" to 15" |
| (2) Standard beams..... | 18" to 24" |
| (3) Channels..... | 3" to 15" |
| (4) Wide-flange beams with extra price of ____ for 100 lb. | |
| (5) Wide-flange beams with extra price of ____ for 100 lb. | |

- | | |
|--|-----------|
| (6) Wide-flange beams with extra price of ____ for 100 lb. | |
| (7) Wide-flange beams with extra price of ____ for 100 lb. | |
| (8) H-columns | All sizes |
| (9) WF Sections and Light columns..... | All sizes |
| (10) Light beams | All sizes |
| (11) Joists..... | All sizes |
| (12) Steel plates..... | All sizes |
| (13) Angles..... | 3" to 6" |
| (14) Angles.. | Under 3" |
| (15) Angles. | Over 6" |
| (16) Rivets | |
| (17) Bolts and nuts | |
| (18) Anchors | |
| (19) Rods | |
| (20) Turnbuckles and clevises | |
| (21) Pipe separators | |
| (22) Cast-iron separators | |
| (23) Cast-iron column bases | |
| (24) Cast-iron columns | |
| (25) Cast-iron lintels | |
| (26) Cast-iron washers | |
| (27) Cast-iron rail bumpers | |
| (28) Steel eye bars | |
| (29) Steel pins | |
| (30) Special steel or iron castings | |

Any items other than those listed above, should be specially noted when required.

When all of the steel has been taken off, listed, the weights carried out, and extensions made, the sheets should be returned to the first estimator who is required to check over the entire estimate. This checking should always be done in red ink.

The summary, then, should show the total tonnage and the weights of each class of material, the total cost of material purchased from the mill delivered to the shop, and the cost of other special material not bought from the mill. The estimator should note, at the bottom of the summary sheet, any information referring to the particular job which would affect the cost.

The estimator should be careful to state explicitly what items in the specifications are to be omitted. Also reference should be made to any alternates. He should note if the steel is to be delivered to the job, or if erection is to be included. If the steel is to be erected, he should note what proportion of work is to be riveted and what bolted. A statement should be made as to the specification requirements for shop and field painting. Information should be given as to whether there is to be any shop or field inspection; whether shop detail drawings are to be made by the fabricator, or furnished by the purchaser; and whether trucking of material from railroad to job will be necessary.

When all of the above work has been completed, the estimate sheets and the plans and specifications are returned to the sales manager or contracting engineer, or whoever has the authority to fix prices and make up the bid.

The cost of the fabricated steel will then be made up and divided among the following items which appear in the summary:

Bought material delivered at the shop.
 Shop costs of fabrication.
 Overhead expense on fabrication.
 Trucking.
 Freight.
 Shop details (drawings).
 Office overhead expense.
 Insurance.
 Shop inspection.
 Field inspection.
 Erection.
 Field painting.

To the total cost of the above items will be added the amount decided on to be fixed as profit, and when this has been done the bid price will have been determined, and quotations sent out through the mail. All estimates in the form of proposals, or bids, must be in writing, and should bear the signature of some person in authority, or some officer of the company.

6. Estimating Data.

6a. Estimate Sheet and Forms.—It is necessary to have some standard forms for use in making an estimate, and specially ruled, printed sheets are generally provided. The estimate sheet should be of some light color, preferably a light buff or tan shade, and the final cost summary sheet can be white. The size of sheet may be $8\frac{1}{2} \times 11$ in., which conforms to the usual letter size, and is found most convenient for filing.

A sheet that is in use in some offices is $8\frac{1}{2} \times 11\frac{3}{4}$ in. This size has been proven very satisfactory, and as it allows more room at top and bottom of page for headings and footnotes, it is the size of sheet that is recommended (see illustration).

At the top of the sheet a 1-in. space is left for the heading. In this space should appear the date, estimate number, sheet number, and the initials of each man who has worked on the sheet.

Vertical columns are ruled at the left, in which are entered the number of pieces required, size and length of each member and the weight per linear foot of each piece. To the right are seven columns, about $\frac{3}{8}$ in. in width, in which the total weight of each item is entered. Forty horizontal lines $\frac{1}{4}$ in. wide are ruled for this purpose, and at the bottom a space is left for the summations and totals of all the material on the sheet.

Some concerns prefer a wider sheet for taking off the steel, using a sheet 11×17 in. or double the letter size. This size sheet can be conveniently doubled over, and filed with other papers and is very satisfactory, where the weights are carried down in separate vertical columns running across the full width of sheet. On the smaller sheet the weights are carried down in the first two columns and then separated in the summary. It is a matter of opinion which method is the best.

6b. "Taking Off."—As an illustration, an estimate will be given of part of the structural steel for a typical office or loft building. Only those members will be listed which are shown checked off on the floor framing plan.

The beams framing between the girders are listed $1\frac{1}{2}$ in. shorter than the actual span, center to center of girder beams. In the 16-ft. center bay, the

length of the 12-in. beams will thus be 15 ft. 10½ in. When the end connection angles are riveted on, the length of the fabricated beam, out to out of angles will be ½ in. short of 16 ft. which will allow clearance at each end. This enables the erector more easily to swing the beams into place.

ESTIMATE No. 312

DATE 7-22

FOR Office Bldg

SHEET No. 7 OF

EST. BY F.W. CHECK BY M.L. EXTENSION BY H. CHECK BY J.W.G.

NOTE	No. BEAM	DESCRIPTION	WGT. PER FT.	LENGTH FT. IN.																
4th Floor																				
F	2	15" I	229	18 2½	1 502															
F	2	do	40	18 6	1 390	3 152														
F	2	18" I	547	19 10	2 170	2 170														
J	2	15 4"x3 ½"x ½"	85	19 9	336	336														
	40	¾" Rivets	480	0 2½	17	17														
	1	15" I	229	15 11	285	285														
J	1	15 4"x3 ½"x ½"	85	15 11	135	135														
	20	¾" Rivets	480	0 2½	10	10														
F	5	12" I	225	15 7½	2 260	2 260														
F	2	15" I	229	16 2½	1 390															
F	2	7" I	158	6 1½	188	1 578														
cl	14	15 4"x3 ½"x ½"	85	0 6	60	60														
	2	¾" Tie Rods	15	7 3	22	22														
	4	Square Nuts	232	-	2	2														
One Platc Girder - P 6 2"																				
	1	Web P 48x8	1224	26 9½	3 300															
	4	Pls 28x8	476	10 0	1 303															
	2	Pls 18x8	383	26 9½	2 257															
	2	Pls 18x8	459	24 0	2 223	3 725														
	4	18 8x8x1	510	26 10	3 320	3 320														
	8	18 6x6x½	287	3 11½	916															
	8	18 6x6x½	162	3 11½	370	1 226														
	4	Pls 10x8	170	2 8	103															
	4	Pls 5x8	153	2 8	186	343														
	500	Rivets ¾"	1000	0 4½	600	600	17 420													
12	10	Connections	18		180															
18	4	do	24		96															
7	2	do	12		24	300														
Field Rivets																				
	200	¾" Diameter	429	0 2½	85															
	75	7"	828	0 3½	68	148														
	200	¾" Bolts				129														
TOTAL WEIGHT FOR SHEET					28916	16														

FIG. 1.

The beam framing between columns 6 and 9 should be ordered with a clearance at each end of ¼ in. between the ends of the beam and the face of the columns. This clearance can be more, but should never exceed ½ in. at each end. The beam between columns 5 and 6 should have similar clearance but it must be noted that one end of the beam frames into the web of the column, and, on this

end, the clearance will be one-half of the thickness of the web of the column, plus $\frac{1}{4}$ to $\frac{1}{2}$ in.

Beams which frame into girders, flush top or bottom, must be coped to fit. Coping adds to the shop labor cost. The beams to be coped should be separated in the estimate, when estimating the cost of shop labor.

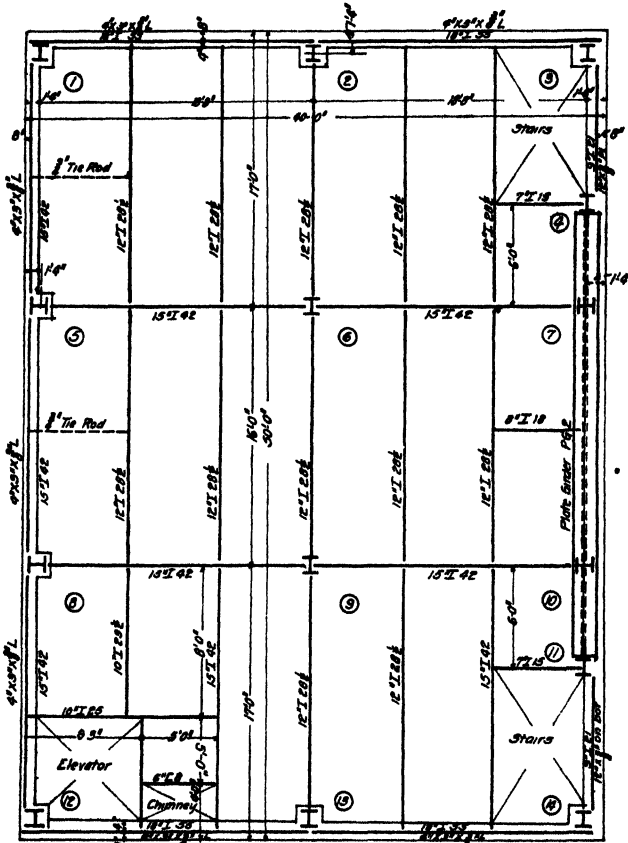

Plate Girder P&E
 1 Web Plate 48"x $\frac{1}{2}$ "
 4 Rivet Plates 28"x $\frac{1}{2}$ "
 4 Flange ls 8"x8"x1"
 2 Flange Plates 18"x $\frac{1}{2}$ " Full Length
 2 do 18"x $\frac{1}{2}$ "x20'0"
 SHIF End 6"x6"x $\frac{1}{2}$ " Doubled
 do Int 6"x6"x $\frac{1}{2}$ " Under Load
 at cols 7 & 10
 Rivets $\frac{3}{4}$ " Diameter

Fourth Floor Framing Plan
 Scale $\frac{1}{4}$ "=1'0"

Notes
 All beams flush top - $\frac{3}{8}$ " below
 finished floor
 Top of plate girder +1'2" above
 No tie rods except where shown
 All connections riveted
 Rivets $\frac{3}{4}$ " diameter except for
 plate girder. See schedule
 Paint-as specified

FIG. 2.

The tie rods shown on the plan are $\frac{3}{4}$ in. in diameter, and must be long enough, and have sufficient thread at each end, to allow of securely tightening up a square nut on both ends.

The spandrel beams, or the beams which are shown in the outer walls, have either an angle iron or steel plate riveted or bolted to the bottom flange, and this

weight must be added and listed in the estimate; and the weight of the rivets or bolts, and the special shop work must be noted.

The plate girder marked "PG2" in the illustration is shown framing into the face of the column, which will require the same clearance as for beams. Where possible, the girder should run over and be carried directly on top of the columns (as 4 and 11), as this method eliminates bending strains due to eccentricity in the connection of the girder to the column. The latter method, of course increases the length of the girder, but this extra weight is more than offset by the saving in the column, and makes a more desirable detail.

The estimator should note what size rivets and bolts for field connections are called for, and make a separate item of each. He should also list any steel templates required. Separators should be used where two or more beams are used in combination to form a girder and the estimator should note whether the separators are to be gas pipe, or cast. He should list any anchor bolts that may be required, and list separately any angle lintels and any material which is to be furnished plain—that is, without any shop work on it. A special item should also be made of any material which is punched but not framed.

It is advisable before taking off the columns, to estimate the footings for the columns. If this is not done, there is a possibility of overlooking the bases and leaving them out of the estimate. Steel columns may have a built-up steel base attached to the shaft of the column, in which case the weight is added in directly to the weight of the columns. This base will usually include a bearing plate, wing plates, four or more angles, and two or more anchor bolts. The base will set on a concrete or granite block foundation.

If the load is heavy, the base of the column may be carried on a steel billet, grillage beams, or on a cast-iron base. The steel column may also be carried on a reinforced concrete base, in which case the reinforcing rods may be included in the structural steel estimate, but more often are furnished with the reinforcing steel contract.

The estimator should list the materials for the columns separately, and should check off each section as it appears on the schedule. If there is no schedule, then the size of columns shown on floor plans and sections must be checked off on the architectural plans.

Steel columns are usually in two or three-story lengths, making the total length of the piece from 30 to 40 ft. The estimate should include the weight of the splice, where the top of the lower column is joined with plates and angles to the base of the column above. It should also include the weight of the details, which includes the weight of the connections of the beams to the columns at each story, the column cap, and the rivets occurring in the shaft of the column. H-columns which do not have reinforcing plates or angles riveted on, have no rivets in the shaft. It is customary to figure the weight of two heads for each shop rivet in the column, the shank of the rivet filling the hole in the metal punched for the rivet and equalizing the weight lost in the punchings.

Figure 3 is a typical steel column schedule, as will be usually furnished to the estimator for taking off column weights. The story heights are given in the first column on the left-hand side of the sheet, the numbers of the columns appear at the top of the sheet, and the loads on each column, and the section of each length are given directly under.

This schedule covers the columns shown on framing plan, Fig. 2, and the numbers on the schedule correspond with the numbers on the plan, and serve to identify the different sections.

Columns are combined in the schedule, and are grouped in the estimate whenever possible. The location of splices is shown, and the weight of one splice will be from 60 to 100 lb., and must be added in with the details. The base of columns will be shown in detail on the foundation plan, and the weight of this, also the connections of beams and girders to the columns at each floor, must be included with the weight of the shaft, to find the total weight of each column.

		Column Schedule				Loads in Tons	
Column		1-12	5-8 2-19	3-14	4-11	6-9	7-10
Roof		9	12	9		16	12
Ceiling	10' 0"			4 Ls 3" x 3" x 8" Latticed 2 1/2" x 1 1/2"			
7th	10' 0"	19	24	18		38	28
		8 H 32	8 H 32			8 H 32	8 H 32
6th	12' 0"	29	44	28		60	44
		14 1/2"					
5th	12' 0"	35	60	38		82	60
		8 H 34 1/2	8 H 39	4 Ls 3" x 3" x 8" 1 1/2" 8" x 1 1/2"		10 H 19	8 H 39
4th	12' 0"	49	77	48	Girder	104	Girder
		14 1/2"					
3rd	12' 0"	60	94	58	98		
		10 H 49	10 H 54	4 Ls 4" x 3" x 8" 1 1/2" 10 1/2"	13 1/2"	12 1/2"	
2nd	10' 6"	72	102	76	141 H 33 1/2	126	
		14 1/2"					
1st	16' 6"	85	120	82	132	170	
		10 H 55 1/2	10 H 62 1/2	4 Ls 4" x 3" x 8" 1 1/2" 10 1/2"	14 H 106 1/2	12 H 91 1/2	
Basement	10' 0"	100	136	96	130 1/2"	134	
		1-12	5-8 2-19	3-14	4-11	6-9	7-10

FIG. 3.

The weight of H-columns is found by multiplying the weight per foot, taken from the schedule, by the length, and adding the details.

Columns 3 and 14, in the third column, are known as built-up and the weight of the angles and web plate must first be found, and this weight per foot will be multiplied by the length, and details added as for the H-columns.

In estimating cast-iron columns, which are cast in one length, the weight is obtained, by multiplying the weight per linear foot of the shaft by the length in feet, and adding the weight of the top and bottom flanges and the details for beam connections. These beam connections include a seat and bracket to which the beams are bolted; also any ribs which are shown on the detail. An allowance is made for fillets in corners and where the metal of the shaft has been

thickened, as where a column of smaller diameter is carried on a column of greater diameter and it is necessary to increase the thickness at top of the lower column so that full bearing will be provided.

Cast columns are bolted to bases and at splices, with at least four bolts of $\frac{3}{4}$ -in. diameter. Beams which frame into cast columns are connected with bolts connecting through the web of the beam to a bracket on the column. Bolts used in cast iron work, should be of sufficient length to allow $\frac{1}{4}$ in. at least over the top of the nut.

Field rivets and bolts, which are used by the erector in joining the different members together in the course of construction, are taken off the number actually required, noting the different sizes, diameter and length, and allowing from 10 to 20 per cent excess over the total number required, to cover waste, loss and defective stock. Usually fitting up bolts are required, especially on the mill building type of construction. These are bolts long enough to hold two members together while the final riveting is being done on the connection. A sufficient number of washers should be supplied with them, so as to enable the erector to draw up the connection hard and tight while the rivets are being driven and while they are cooling.

In estimating steel roof trusses, the lengths of the top and bottom chords and web members must be scaled from the diagram. As this is usually a simple line drawing, the estimator must depend in great measure on his ability to visualize the finished truss in detail, and make proper allowance for the length of angles, size of gusset plates, details, number of washers holding two angle members together, and the number of shop rivets and loose pieces which are bolted for shipment.

Plate girders consist of a web plate with a top and bottom flange, stiffener angles with fillers, and shop rivets. The sizes are specified on the plans, and the length scaled, and the estimator should experience no difficulty in arriving at the exact weight of the complete girder. If the girder is over 40 ft. in length, it is shipped from the shop in two or more sections, and the weight of the material forming the splice must be added.

The weights of the plates, angles, channels, rivets and bolts are found separately and added together to obtain the weight of the girder.

In buildings having a traveling crane, it is customary to support the crane rails on the top flange of a plate girder. The rails are the usual light railroad type and are fastened to the girder by means of hook bolts, which extend over and clamp around the edges of the top flange of the girder.

The rails are in 30-ft. lengths, and a splice is required at each joint. A bumper is provided at each end of the runway, and this is usually of cast iron.

The above rails and fittings are standard, and the details and weights can be found in handbooks and catalogues of railway supplies. The girder is similar in detail to others used in building work, except that the top flange is reinforced with a channel laid flat, and flanges turned down, to increase the lateral stiffness of the girder. Some provision must be made for expansion in the length of the runway.

A truss with level top chord is sometimes used instead of the plate girder where the span exceeds 40 ft. and the weight of the truss is calculated in the usual manner.

Crane runway girders are sometimes supported on towers or bents, which are riveted truss frames, and the method of taking off the members and details is the same as employed for trusses.

Wind bracing for tall buildings is required where the width of the building is small in proportion to the height, and there is danger of overturning. The estimator will find the bracing specified or shown in detail on the plans, and no difficulty should present itself in finding the weight.

On mill building construction, it is customary to have a system of bracing in the plane of the top and bottom chords. This will consist of angles or rods laid diagonally, and connected to the trusses by plates and angles riveted at each end. Also, a single line or more of longitudinal rods, angles, channels or beams may be used, running continuously in the length of the building, at the bottom chord level. Similar bracing is not required in the top chord plane, as the roof purlins answer the same purpose.

Some type of brace or strut should be provided at the ridge or peak and eaves. This may be a simple beam or channel, or a riveted truss frame. Additional bracing is sometimes necessary in the end bays to take up the wind pressure on the ends of the building.

Knee-braces are often provided, connecting trusses, girders and beams to columns. These are usually two angles riveted back to back.

All of the above work is estimated in the usual manner, and the weight is found by multiplying the weight per foot by the length in feet for each piece, and the results added together to find the total. As this class of work is light in weight in proportion to the cost for fabricating and erecting, it should be classified in the summary separately from the heavier material.

Anchors for structural work are specified and shown on the plans and the estimator should note particularly the detail—also whether washers or plates are required.

In mill building work, it is sometimes necessary to include a corrugated iron or steel covering for the roof and sides of the building. This is taken off in squares of 100 sq. ft. and 25 per cent is added to the actual area, to cover side and end laps and waste. A flashing is specified on first class work. This is of flat metal and should be applied around all window and door openings, gables and eaves. Flashing can be figured in linear feet, noting the width of sheet used. A ridge roll which is put on the peak of the roof, where the top row of sheets join, is estimated the same way as flashing.

The estimator should note what gage of metal is specified, the number and depth of corrugations, and if the metal is black or to be galvanized. The latter is slightly heavier than the black, and costs more. The weight per square can be found in the steel handbooks.

Corrugated iron is fastened to the steel frame with hook bolts, straps, or ordinary bolts. The quantity of each kind should be listed, and a price secured from the dealer who carries them in stock.

Where turnbuckles or clevises are required, they are of standard sizes and design, and are carried in stock, and all that is necessary is to specify in the summary, the quantity of each size to be ordered.

A set of blue print standards is found in the drafting room of every steel fabricating plant, which the draftsmen are required to follow in making shop details,

and the estimator should also familiarize himself with these details and instructions and as far as possible learn in a general way the methods in use in the shop in fabricating the steel.

If the shop standard details are to be used, the weights can be easily figured, as the weights of all the details can be found in the standards. If a particular set of details must be used in detailing which are not standard, then the estimator must ascertain the weight of each particular piece. Any special or unusual details will increase the cost of the fabrication, and mention must be made of this in the estimate summary.

In taking off the steel, the length of each piece may be marked in feet and inches, as 12 ft. 5 in. or in decimals, as 12.42 ft. Either method is correct, but one or the other should be followed throughout by everybody working on the estimate, to avoid confusion and possibility of error. The weights are usually given in decimals, as 18.4. The loads are in pounds, and in the final estimate may be reduced to tons of 2,000 lb.

Slide rules are of assistance in figuring the weights, and computing machines simplify the work of making the extensions and in the summation of weights, and should always be used in estimating structural steel.

While accuracy is of the most importance, no attempt should be made to have the estimate too exact, and a few pounds lost or gained on a single item, will not materially affect the total weight of the structure. The estimator should be careful, however, in listing every piece of steel, and especially so when more than one piece is combined in a single item. An error in an item where a number of pieces have been combined—as for example, where one or more tiers of beams are duplicated in the estimate—may prove costly.

If a number of trusses (10, for example) are to be taken off, either of the following two methods should be followed: (1) Estimate one truss complete, taking off the angles, plates, channels, rivets and bolts, etc., and when the weight of one truss is found, multiply this total by ten; or (2) after finding the weight of the one truss, write directly under the total weight for one, the following: *Add nine trusses like above.* Thus, in order to find the weight of the ten trusses, add the weight of nine trusses to the weight of one, the result being the same as in the first case.

In order to avoid liability of error, a notation should be made at the top of the estimate, calling attention to the fact that there are a number of pieces alike, and combined in one item, and this is usually taken care of by the following note—as, for example, *Ten trusses required—one off.*

Sometimes an estimator will prefer to take off all of the steel which is alike, in one item, and when this is done it is, of course, necessary to multiply the weight of one piece by the number required, to find the total. Either of the first two methods described, however, is preferable, as an experienced estimator can more easily check himself if he first finds the weight of any single member. If all of the trusses in the above example are to be taken off at once, then the following note will appear at the top of the estimate: *Ten trusses required—all off.*

When trusses are symmetrical—that is, both halves are exactly the same—then it is customary to take off only one-half of one truss. This must be carefully noted, and the notation at the top of the estimate, will be, for the same example: *Ten trusses required—one-half off.* To find the weight of the ten complete trusses,

it will then be necessary to add the weight of nineteen half trusses, to the weight found for one half truss, making twenty halves in all.

The same rule will apply in taking off a number of columns or girders, or any special material. But for ordinary beam work, it is usual to write in at once the exact number of pieces of each item which are exactly alike—as, for example,

22 beams 10 in. × 25.4 lb. × 16 ft. 8 in.	9,315 lb.
14 beams 10 in. × 25.4 lb. × 15 ft. 9 in.	5,600 lb.
3 beams 12 in. × 31.8 lb. × 19 ft. 6 in.	1,860 lb.
Total weight.	16,775 lb.

If the beams listed above are framed—that is, have connection angles at one or both ends—then it is necessary to estimate the weight of the material of which the connections are made up, and this material must be separated in the summary.

Weight of details for steel beams												
Description	Depth of beam in inches											Remarks
	5.6	7.8	9.10	12	15	18	20	24	26	28	30	
One connection	7	12	12	18	24	28	28	32	37	41	46	Pair of angles & shop rivets
Beam to column	8	10	12	15	20	25	30	35	40	50	50	On web of column
Beam to column	10	12	15	20	25	30	35	40	45	55	55	On flanges of column
Bearing plates	7	10	15	25	33	45	50	60	60	70	70	Steel plate on wall
Separators	7	10	15	22	25	30	30	40	50	60	60	Cast iron and bolts

Above weights are not to be used for WF girders

FIG. 4.

The weight of the connections comes under the general heading of *Details*, and there are several methods for finding the weight for all the details on any particular job. The method that is recommended is to actually estimate the weight of each individual detail or connection, and enter the totals in the proper place in the summary. As many of the connections are standard, and the weight have been previously calculated, the estimator can take the weights directly from the book of shop standards, or some hand book, and with the weight for one piece known, it is a simple matter to find the total weight, by multiplying the weight of the single piece by the number required.

For the convenience of the estimator, standard weights for beam details are shown in the accompanying table. These weights should be used only for ordinary conditions where the actual loading will not exceed the safe load for the beams, and where the shear will not be excessive. Allowance should be made for any special conditions by the estimator, by increasing the weights of the details. The weight of the connections for beams to columns is taken off as a part of the column. Bearing plates are steel plates which are used where the beam bears on a wall. Cast-iron separators are used to tie two beams together, when they are in pairs. The bolts which pass through the separators and the web of the beam are included in the weights given.

Where there are more than two beams joined together, as in grillages, the weight of the separators will be the same, but the bolts will change in accordance with the length. The weight of separators, however, will vary depending on the spacing of the beams center to center. If the beams are placed far apart, the weight of the separator must be increased.

Gas-pipe separators are sometimes used, and the weight is found by finding the weight per foot for the pipe (1-in. diameter is generally specified) and multiplying this by the length.

An experienced estimator may prefer to figure the weight of the details by adding a certain percentage to the total weight of all of the steel in the structure, without actually taking off the details, or to add to the weight of each of the main members, as for columns, trusses and girders, a percentage, which his experience would indicate would be correct. While these approximate methods in the hands of an experienced man may give satisfactory results, it is rather a danger-





Percentage of Details for Steel Trusses							
Sketch	Type	Span	Height	Wt of One	Percentage		
					Angles	Plates	Rivets
	Light	31'0"	8'0"	1330	76	20	4
	Light	50'0"	10'4"	2355	81	15	4
	Heavy	36'0"	8'0"	2750	70	27½	2½
	Heavy	100'0"	22'0"	34000	84	14	2
	Bent	7'0"	26'0"	2000	81½	14½	3½

FIG. 5.

ous method for a beginner or novice in estimating, and should be avoided in favor of the surer plan of actually taking off the details and figuring the exact weights.

An example of the use of percentage for details is shown in the accompanying illustration (see Fig. 5). A number of roof trusses are given having different spans, and the data are compiled from shop details and shipping bills for steel which has been fabricated for several different types of buildings erected in New York City.

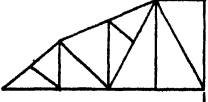
The total weight for each truss is given, and the percentage shown for the angles, plates, and rivets which go to make up the truss. The weights being accurate, this table can be used as a basis for estimating the weights of similar trusses, and for comparison.

Details for steel columns include the bases of the lower length, splices for the upper lengths, and the connections at each floor where the beams frame into the column shaft. The ratio of the weight of the details to the total weight of a column will vary as the length of the column changes. The percentage for details for long columns will then be less than for short columns of the same section. This rule will also hold true for beams and girders.

The completed estimate for any structural steel job should be within 3 per cent of the actual shipping weight of the fabricated steel, and the estimator should make it a rule to take off full, or slightly heavy, rather than to have his tonnage run under the correct weight.

When all of the steel has been detailed and checked, and shop bills prepared, the weights should be calculated and entered in the bills of material on each drawing. Then the total tonnage should be checked up with the original estimate, and if there is any great variance, investigation should be made to find the reason.

It is the custom today, where a contract is taken for structural steel on a price per ton instead of a lump sum amount, to abide by what is known as the book weights in preference to using the shipping weights. The reason for this is that the weights taken from the shop details are found more accurate than the weights which are furnished by the railroad freight departments.

7. Cost Data.—Estimating the cost of structural steel is something apart from figuring weights, and it is impossible to give data that will be of any real use to the novice. In fact, only one who has had a thorough training in all branches of the structural steel business, with a full knowledge of prices and costs and market conditions, and an aptitude for selling, should ever attempt this important work.

The estimator can, however, easily obtain the costs of plain materials to be purchased from the mills. The base prices are quoted in the trade papers. This price, figured on base and extras, is variable and is fixed as f.o.b. cars basing points.

To the price f.o.b. basing point should be added the freight charges for bringing the steel from the mill to the fabricating shop. As these charges are changed from time to time, the estimator should verify the current freight rates. This can be done by applying direct to the railroad freight agents, who will give the information. Less than carload shipments take an increased rate, and should be avoided wherever possible, as it takes much longer to get a small shipment through to destination than it does for a full car. An inquiry sent to the mill will receive prompt attention, and the mill will quote prices to any destination.

The fixing of costs for shop work, office overhead and erection is a much more difficult problem, and is handled in many different ways depending a great deal on the capacity and conditions existing in any particular shop, the business methods in vogue for handling the office and engineering, and the efficiency of the erection force.

The possibility of securing competent shop labor is an important problem in any shop today. The efficiency of the mechanical equipment in the shop, and the ability of the shop management to get the work out economically, will also directly affect the cost of the fabricated steel.

The following table gives a fair average cost for fabricating structural steel under favorable conditions and in normal times for a shop of from 500 to 1,000 tons capacity per month. Costs of erection are also given. The figures are based on reliable data, but are meant to be taken only as relative values. They should not be considered as a standard which will be universal for all times and in all sections of the country.

COSTS OF STEEL FABRICATION AND ERECTION

Description	Fabrication (cost per ton) net	Erection (cost per ton) net
Foundation		
Anchor bolts	18 00	By Mason
Grillage beams, separators and bolts	8 00	11 00
Steel columns		
H-columns	8 00	11 00
I-beam columns	9 00	11 00
4 angles and web plate	11 00	11 00
4 angles, web and cover plates	15 00	11 00
4 angles latticed web	18 00	11 00
2 channels and cover plates	14 00	11 00
2 channels laced	18 50	11 00
2 angles star post	20 00	14 00
4 angles star post	18 00	14 00
Riveted trusses		
Light angle frame and gusset plates	17 00	19 00
Heavy angle frame and gusset plates	12 00	17 00
Boxed chords and latticed	14 00	14 00
Monitor frames	18 00	22 00
Knee braces		
2 angles plate and angle connections	17 00	21 00
2 angles, ends bent	15 00	21 00
2 angles, curved	18 00	21 00
Plate girders		
4 angles and one web plate	10 00	11 00
4 angles, web plate and covers	14 00	11 00
4 angles, box girder, two webs	15 00	11 00
4 angles, chords and webs	17 00	14 00
Struts		
2 channels, web of one to flange of other	8 00	14 00
1 channel and angle on back	8 00	14 00
1 angle or channel punched	4 00	14 00
2 angles, star shape	20 00	14 00
4 angles, latticed	20 00	14 00
Beams and channels		
Plain	2 00	6 00
Punched	3 00	7 00
Framed	4 00	8 00
Coped or mitred	5 00	11 00
Plate riveted on flange	8 00	11 00
Double beam lintel	8 00	11 00
Fittings		
Bolts, rods, anchor plates, etc	8 00	8 00
Miscellaneous		
Skylight frames and curbs	18 00	17 00
Dormers	24 00	21 00
Girts, angles	8 00	11 00
Angle braces	10 00	14 00
Door frames	20 00	25 00
Floor plates:		
Steel flat	6 00	15 00
Checked flat	8 00	16 00
Crane rails:		
Tee rails	8 00	14 00
Bumpers	2 00	8 00
Rail clips	3 00	11 00

To arrive at an accurate shop labor cost, it is necessary to separate the different classes of material, and the accompanying costs are for actual labor with nothing added for overhead or management expense. If a schedule similar to this classification is in operation in the shop, then the estimators and men in the drafting room should also follow the same arrangement in getting out their work.

There will be a small charge for handling material which is known as plain, without any special shop work, amounting to about an average price of \$2 per ton. Also a charge must be made for any work done in the structural shop on castings, when delivered unfinished from the foundry. Furnishing and applying one coat of an approved metallic paint is included in above shop and erection costs.

The question of figuring the cost for overhead expenses is one that can not be definitely fixed without taking into consideration the conditions both at the office and shop. This is handled in many different ways, but on an average the estimator can safely assume that the overhead for the shop will approximate from 50 to 100 per cent of the labor cost.

The overhead for a steel fabricating office, one that employs a fair sized drafting room force and two or more estimators, will average about 100 per cent of the cost of making the steel details.

Where a number of jobs are being put through at the same time, the overhead per ton, will be proportionately reduced, as the expense will be divided between the different contracts.

The overhead cost on erection of structural steel will usually approximate from 20 to 35 per cent of the cost of the labor plus insurance.

The cost for painting structural steel usually covers one coat of paint in the shop after fabrication, and one or more coats in the field after erection. It is sometimes specified to use a red lead and linseed oil paint for the shop coat, but otherwise any of the standard brands of metallic paint will be acceptable. The red lead paint is the more expensive, and is seldom required for the field coats, except on Government work. A good quality of metallic paint will cover on an average 250 sq. ft. of surface for the first coat, depending on the condition of the metal. The first field coat will average 300 sq. ft. and 350 sq. ft. for the second coat if it is required. The metal should be dry, clean and have rust and scale removed by a wire brush before the paint is applied.

In estimating, it is common practice to allow one gallon of metallic paint per ton of structural steel to cover two coats. The cost of the paint will be from \$1 to \$1.50 per gallon purchased in barrel lots of 48 gal. each.

The cost of furnishing and applying one coat of metallic paint in the shop will average about \$1 per ton, and for one coat in the field, where the work can be easily reached without much climbing, \$1.25 per ton. If this is done by a contractor, the price quoted will include his overhead and profit.

Paint for the shop is bought from the manufacturers in large quantities, and is applied by a force of painters employed at the shop.

Where structural steel is to be hauled a short distance, delivery is made by motor trucks. A 5-ton motor truck will make two trips in one day, and the cost will be from \$3 to \$5 per ton.

For transporting long pieces of fabricated steel, it is usual to employ trucks with trailers.

Fabricated steel is sold, either by the price per pound, or a lump sum, usually the latter—f.o.b. cars at shop, f.o.b. cars at the railroad freight station nearest to the job, f.o.b. lighter at a dock having facilities for handling heavy steel, on

ESTIMATE No. 312 DATE Mar 10 '22
FINAL ESTIMATE
 BUILDING Office Bldg OWNER Phillips Estate Inc
 LOCATION New York City ARCHITECT T W Golding

COST OF MATERIAL				ESTIMATE		
DESCRIPTION	WEIGHT POUNDS	COST PER LB	TOTAL	SUMMARY	UNIT PRICE	TOTAL COST
Std Beams-15"	2019	15	30285	Material	32 40	25018
do -18"	2170	16	34720	Shop Labor	7 75	11000
Beth Beams-12"	2260	172	38880	Shop Overhead	5 00	7100
Plates	10070	15	15105	Trucking	3 00	2260
Angles 5"to 6"	2257	15	33855	Freight	7 60	10800
do 8"	3320	17	56440	Drawings	2 50	3550
Rivets	750	30	22500	Office Overhead	2 50	3550
Bolts & Nuts	150	45	6750	Insurance		
Tie Rods	22	17	374	Shop Inspector		
Total Weight	28416 1/2		46019	Field Inspector		
	+ 42 tons			Erection	12 50	17700
Shop Labor				Field Painting	1 25	1770
Punched Beams 15"	3152		400			
Framed Beams 15"	4521		550			
do 18"	2170		630			
Plate Girder	17420		8800			
Shelf Angles	331		200			
Connections 15"	300		300			
Tie Rods	22		120			
Rivets	175		-			
Bolts and Nuts	125		-			
	28416		11800			
				TOTAL COST	74 50	105749
				PROFIT	5 50	7857
				BID PRICE	80 00	113606

REMARKS-
 Shop details to be included
 Field connections riveted
 Paint-Shop-One coat-RL-Red-
 Field-One coat-Iron oxide-Black-
 Inspection-None of shop
 Omit Miscellaneous and Ornamental Iron & Bronze Work
 Delivery-Four to six weeks

FIG 6.

company trucks at shop, or to be delivered to the job. The quotation and contract must state clearly what delivery is intended.

The phrase, f.o.b. cars, when used in a contract between buyer and seller of structural steel, where the use of a common carrier is necessary, means that the seller will secure the cars, load them, and do whatever may be required to make

the shipment, all free of expense to the buyer. It is not the duty of the buyer to furnish the cars, or to load the goods.

The cost of inspection of fabricated structural steel, at the shop and in the field, will average from \$1 to \$2 per ton, depending on the location and the size of the job, and provision must be made for expenses of the inspector.

The rate for liability and compensation insurance varies in different parts of the country, and the estimator when making up his cost sheet should apply for the exact figures in force at the time. The insurance on shop labor is comparatively light, but the rate for the iron workers employed on erection is very heavy.

The insurance rates are fixed by law in many localities, also the amount of compensation which is allowed for any particular accident.

Figure 6 is the final cost sheet for the steel taken off the framing plan as shown in Fig. 2. It should be understood that the prices quoted are only relative, and are printed here solely to illustrate the method used in making up the cost for the job.

The cost of applying corrugated steel, fastened to the steel frame with hook bolts and straps, and laps bolted to make joints tight, will average from \$3 to \$5 per square for roofing sheets, and from \$4 to \$8 per square for siding. Sheets from 8 to 12 ft. long are provided wherever possible, and No. 20 gage is specified for the roof and No. 24 for the siding sheets. Sheets nailed directly to wood sheathing will cost from \$1 to \$2 per square. The cost of applying flashing, ridge rolls and corners will be from 5 to 10 cts. per lin. ft.

On small jobs, or contracts which call for immediate shipment, it is sometimes necessary for the fabricator to purchase some or all of the material from stock from a local warehouse. The extra cost over buying from the mill will be from \$20 to \$35 per ton. This price will include delivery by truck to the shop, and is for plain material only.

The use of second-hand material is sometimes allowed and, if the steel is in good condition, may be satisfactory. This material, however, should not be permitted except for simple beam framing, and only when it is impossible to secure new steel from the mills within the specified time. This material is sold *as is*, not cut to lengths, and as considerable waste results it will seldom prove economical in comparison with new steel purchased *cut to length* from the mills.

Pressed steel lumber and fabricated open-web steel joist are modern adaptations of steel shapes of a lighter section than usually found in structural steel and are sold at a price per pound, approximately double that for the structurals. This material is not considered as coming directly under the heading of structural steel, but is sometimes specified for purlins or beams in connection with the standard structural steel girders or trusses. Prices are obtained on application from the concerns who handle pressed steel and steel joist.

8. Selling Steel.—In addition to figuring the weights and costs of structural steel, which work is performed by the estimator, the business of selling steel is of the utmost importance. This is handled through the office of the sales manager, who is called on to supervise not only the estimating, but the soliciting and closing of contracts, the question of credits, and the making of collections, and is required to cooperate with the engineering department in matters dealing with design and detail.

As explained previously, the estimators are under the direct supervision of the sales manager, who in conjunction with the general manager or some officer of the company will arrange a program or schedule of prospective jobs which they have decided to figure.

After a bid has been made up and sent out, it is the business of the salesmen or contracting engineers, under the direction of the sales manager, to follow up and try to secure the contract. If unsuccessful, and the contract is awarded to another bidder, the estimate sheets are placed in a folder, and filed in the office for future reference. The plans and specifications should be returned promptly. If the concern is successful in securing the contract the job is given a contract number, different from the estimate number, and all papers and plans will, thereafter, have this mark, which should be used throughout the life of the contract.

Plans and specifications are then sent into the drafting room for detailing. A contract is drawn and signed by both parties, and deposited in the office. All other papers, estimate sheets, and correspondence will then be placed in a folder and kept in a file provided for "Active Contracts." This folder will remain in this file until the completion of the contract, when it will be removed to a "Completed Contract" file.

Time of delivery is sometimes the deciding factor in securing a contract for structural steel. The terms of sale should be very explicit on this, and a shipping schedule should be prepared which will make certain the arrival of steel at the job in advance of when it will actually be required.

Fabricated steel is sold subject to satisfactory terms of sale, which will depend in part on the arrangement of credit accommodations and specified payments to be made by the buyer to the seller. These payments are usually made for 85 per cent of the value of the steel erected, as the work progresses, and the balance or final should be paid within 30 days after the contract is completed, approved, and accepted.

SECTION 11

MATERIALS

CAST IRON

1. Kinds of Cast Iron.—Cast iron may be considered of several classes depending upon the composition and method of manufacture. Falling within the general term, there is the so-called *gray cast iron* and *white cast iron*; the latter is subsequently treated to produce the so-called *malleable iron*. While the term cast iron is not usually applied to the white and malleable irons, it rightfully should be under the general definition of this material.

2. Methods of Manufacture.—Cast iron has its source in the blast furnace where the ore is reduced to the metallic iron and cast into pigs, commonly known as *pig iron*. This metallic iron carries with it certain elements which have a marked effect upon the physical properties of the material—such elements as carbon and sulphur which the iron picks up from the coke with which the ore is smelted; silicon which is picked up from the silica present in the ore and ash of the coke; and manganese and phosphorus which are present in the ore. All of the above elements have some effect upon the physical properties of the material, therefore the foundryman is compelled to use discrimination in selecting his materials in order to get the properties desired. In view of this it is unwise for the engineer to specify the chemical properties of the cast iron. He should limit himself to the physical properties, permitting the foundry to supply what best meets the physical need.

Cast iron may be poured direct from the blast furnace or remelted from pig by any one of the following methods: Cupola furnace; air furnace; electric furnace; open-hearth furnace. Only foundries making a large tonnage of castings, and located adjacent to a blast furnace, can satisfactorily use the direct method; consequently, as a rule one of the other methods will be in use. The cupola furnace, using iron scrap and pig, is common in making gray iron castings and also to some extent in making small white and malleable iron castings. The air furnace is used to a limited extent only in making iron castings but is generally used in making white and malleable iron castings. The electric furnace is used in making both gray and white (and malleable) iron castings, while the open-hearth furnace is used only in making white and malleable castings where the tonnage is large.

Very little iron for construction purposes will be melted by any other method than in the cupola furnace, and while the air and electric furnaces produce better products, the cost is higher and they are therefore not in common use.

3. Gray Iron.—Gray iron castings made from gray iron, are usually known to the trade as “cast iron.” Gray iron is defined by the American Society for Testing Materials as “Iron containing so much carbon that, as cast, it is not usually malleable at any temperature.” Gray cast iron, or properly speaking, gray iron castings are produced as above stated, using metal directly from the

blast furnace or pig iron, the produce of the blast furnace, and scrap melted in the cupola, air or electric furnace.

Gray cast iron always contains an important percentage of carbon, ranging from 1.7 to 4.5 per cent, and an important percentage of silicon. The carbon present in gray iron is in two forms, called graphitic carbon and combined carbon, and the material is hard or soft depending upon the proportion of these two forms of carbon. In other words, the castings are hard when the combined carbon is high, and soft when the graphitic carbon is high. The combined carbon is in the form of a carbide of iron or alloy of iron and carbon which adds to the strength and hardness of the material. The graphitic carbon is graphite in the form of thin flakes, leaving a network or skeleton of the alloy surrounding it.

In general, gray iron may be considered a mass consisting of particles of graphite surrounded by a matrix of metallic alloy. The strength of iron is greatly affected by the condition of the carbon. The crystals of the graphite are brittle and show decided cleavages, hence they cannot be a factor in the strength of the iron. Thus by breaking up the continuity of the matrix the graphite causes weakness which will vary directly with the quantity.

The silicon plays an important part in the physical properties of gray iron, not directly, but in its effect on the condition of the carbon. The higher the silicon, the greater the amount of graphitic carbon, hence the less the amount of the combined carbon, and the softer the iron. The foundryman therefore regulates the physical properties of his material in regulating the amount of silicon by the proper mixing of his different irons.

Sulphur has the opposite effect of silicon and tends to harden the iron by increasing the combined carbon. Thus, sulphur is to be avoided in soft irons and only plays an important part in the so-called chilled irons, as in car wheels and like products where the surface is rendered hard.

Manganese tends to harden the iron and to offset the effect of the sulphur. It is sometimes referred to as a veil for the sulphur so that when high sulphur iron only is available some increase in the manganese will offset the difficulty to be expected with high sulphur.

Phosphorus in cast iron is not detrimental in percentages varying from 0.30 to 0.50 per cent. Where great fluidity is required, the amount may be as high as 1.00 per cent.

The above discussion of the effect of the chemical constituents upon the physical properties of gray iron is not given with a view of encouraging the engineer to write his own chemical specifications for what he thinks desirable, but to endeavor to show him the futility of such effort. The chemical constituents of gray iron should be determined by the foundry metallurgist and the engineer should only specify the physical properties he desires.

The physical properties of gray iron vary between somewhat wide limits depending upon the size and dimensions of the casting. The American Society for Testing Materials publishes a flexible specification which gives the physical properties to be expected in different casting thicknesses. This specification is perfectly rational and can be met by any foundryman without imposing upon him an undue burden. It is therefore wise to follow these specifications, care being taken that the one most recently revised be used. These specifications are changed from time to time as the art improves.

Gray iron possesses comparatively little strength in tension and no ductility. This therefore renders the use of gray iron castings in tension uncertain and they should not be so used unless the load is static and unit stress is low. Gray iron possesses its greatest value in compression where the ultimate strength is about four times that in tension. For construction purposes it is therefore wise to consider gray iron only in compression. It should be used for column bases, floor plates, columns under some conditions, etc.

4. White Iron.—White cast iron is used only in cases where a chilled surface is required to resist abrasion, but when there is no tensile stress or shock. In white iron the carbon is all in the combined form, therefore it cannot be machined except by grinding. Inserts of white iron ore are sometimes used when there is sliding contact.

5. Malleable Cast Iron.—Malleable cast iron, which is commercially known as malleable iron, is defined by the American Society for Testing Materials as "Iron, white as cast, which has been made malleable by a heat treatment which has converted substantially all of the combined carbon into nodules of graphite." Malleable cast iron is first cast in white iron using the air, cupola, electric or open-hearth furnace. Small castings are frequently produced by cupola melting but the majority of all castings are produced in the air furnace. After casting as white iron (all of the carbon in the combined form), the castings are inspected, after which they are packed in boxes with an oxidizing agent, in which they are heated for a period of from 5 to 7 days. In this treatment known as annealing, the combined carbon is changed to the form of graphite, known as *temper carbon*. At the same time the outside surface is decarbonized by the action of the oxidizing agent. The form of the graphitic carbon varies from that of gray iron inasmuch as the gray iron is in the form of flakes and therefore occupies the greater part of the cross-sectional area, while in malleable iron it is in the form of nodules occupying a lesser amount of the cross-sectional area, leaving a greater percentage of the matrix effective. Since the carbon is practically all graphitic, the matrix is soft and ductile.

The use of malleable iron is constantly growing and at some future day will find an extended use in construction work. It is now used principally for hardware, concrete insets, hanger straps, etc. It can be used in tension to some extent and for transverse loading. In compression malleable iron has no advantage over gray iron and is more expensive.

Malleable cast iron in tension has a value from 50,000 to 53,000 lb. per sq. in. and an elongation of from 10 to 18 per cent.

Specifications for malleable iron of the American Society for Testing Materials should be used when malleable castings are desired.

6. Design of Castings.—Care should be taken in the design of castings for whatever purposes intended, and sharp corners and angles should be avoided, using well rounded corners and large fillets. This is desirable owing to the fact that in all metals, upon solidifying, the crystals grow at right angles to the surface. This causes weakness along a line bisecting the angle of the surfaces, along which failures may occur.

The section of ribs, etc. should be kept as nearly uniform as possible. A large section immediately adjacent to a light section is apt to cause difficulty and internal troubles. The engineer should exercise great care and judgment in

the design of castings for any purpose whatever, since a little judgment shown at such a time will avoid failure which might be destructive to both life and property.

The defects in castings of all kinds are: (1) blow holes which occur near the surface and are usually indicated by surface porosity; (2) contraction cavities which are usually found below the surface at the intersection of large and small sections (usually referred to by the foundrymen as shrink holes); and (3) scabs, which are purely surface defects, and as a rule cause no trouble except where it is desired to make connection with some other member without machining.

WROUGHT IRON

7. Wrought Iron Defined.—Wrought iron is defined by the American Society for Testing Materials as "A ferrous material, aggregated from a solidifying mass of pasty particles of highly refined metallic iron, with which, without subsequent fusion, is incorporated a minutely and uniformly distributed quantity of slag."

8. Method of Manufacture.—Wrought iron is manufactured by the process of puddling or by the Aston process. The puddling process consists in the melting of pig iron and ore in a furnace and constantly stirring until practically all the carbon and other impurities are burned out. This leaves the iron in a plastic condition, saturated with slag. The material is gathered into a plastic lump and put in a "squeezer" where much of the slag is squeezed out. The remaining material is then rolled into billets known as "Muck Bar." Subsequent rollings refine the material by further eliminating the slag and it is called single and double refined iron, depending upon the number of times rolled.

In the Aston process, Bessemer pig iron is melted in a cupola and air is blown up through openings in the bottom of the cupola, burning out most of the impurities. The absorbed gases are driven off by pouring the iron into molten slag which is at a temperature below the freezing point of iron. The slag is then removed by squeezing the iron.

9. Structure of Wrought Iron.—The structure of wrought iron is commonly called fibrous due to the presence of a considerable amount of slag. This slag is found in alternate layers with the iron, which gives the appearance of fibers and which is referred to at times as "woody." The layers of slag serve as a protecting covering for the alternate layers of iron, thereby rendering the material somewhat immune to corrosive conditions. The carbon content is usually under 0.12 per cent and the slag content from 0.6 to 3.0 per cent.

10. Physical Properties.—The physical properties of wrought iron are fairly constant; the tensile strength from 48,000 to 54,000 lb. per sq. in., with the yield point about six-tenths of the tensile strength. Both the elongation and reduction of area are high, denoting excellent fatigue resisting properties.

11. Uses of Wrought Iron.—The greatest value of wrought iron is in its ability to resist corrosion and is in consequence used for sheets, both plain and corrugated, metal lath, pipe, etc. Some wrought iron is used for structural shapes. Probably the most important use of wrought iron is in pipe where its resistance to corrosion results in long life and good service. Wrought iron can be identified by the surface appearance of small hairline checks which represent the slag.

Wrought iron should be purchased under the specifications of the American Society for Testing Materials.

12. Ingot Iron and Copper Bearing Metal.—In the same general class with wrought iron in its resistance to corrosion are the so-called ingot iron and copper bearing metal.

Ingot iron is made in the open-hearth furnace, eliminating as far as possible the impurities usually found in steel, thereby obtaining as pure a product as possible. It is then cast in ingots and rolled into the form required. Owing to certain properties of this material it is hard to handle in forging operation, therefore any forgings required should be carefully made.

The value of this material lies largely in its capacity to resist corrosion due to the low percentage of impurities, and it is furnished in sheets both black and galvanized. There are no specifications under which this material is furnished. It is usually supplied under various trade names.

Copper bearing steel takes its name from a small percentage of copper, from 0.15 to 0.30 per cent. This contributes to its capacity to resist corrosion, probably by alloying with the iron. The other constituents are as low as is practical. This material is used for sheets for sheathing, metal lath, etc.

STEEL

13. In General.—Chemically, steel may be defined as an alloy of iron-carbon and other elements being present in varying amounts depending upon the properties desired. Where the steel is composed of an alloy of iron and carbon with other elements in small quantities, it is customary to refer to such material as carbon steel. Where small quantities of other elements (such as nickel, chromium, vanadium, etc.), are present in addition to the iron and carbon, it is customary to refer to the material as alloy steel.

Of the elements entering into the composition of steel, some are of value, while others are a detriment. The value of the steel is determined largely by these elements. Not only should their presence be considered, but the amount of each should be accurately determined. They will be taken up in the order in which they are usually regarded.

Carbon.—The general influence of carbon on steel is greater tenacity. It also renders the steel harder and stiffer. The tensile strength is increased about 600 to 800 lb. per sq. in. for each additional point of carbon, while the ductility is decreased about 0.5 per cent for each additional point of carbon (see Fig. 1). Steel with 0.20 per cent carbon begins to show appreciable hardening when cooled quickly, but does not show evidence of brittleness in the normal state, until the carbon has reached approximately 0.70 per cent.

Manganese.—Manganese adds to the toughness of steel and increases the tensile strength by about 100 lb. per sq. in. for each additional point. The ductility is decreased with the addition of manganese. For medium steel the manganese is very satisfactory at from 0.40 to 0.60 per cent. Higher or lower manganese may be specified for special purposes. Steel with manganese between 2 and 6 per cent should be avoided, due to increased hardness and a tendency to brittleness, while steel of over 6 per cent manganese, known as *manganese steel*, has certain definite properties of toughness and strength.

Phosphorus.—Phosphorus renders steel cold short, or brittle. It is therefore to be avoided as much as possible. The lower the phosphorus content, the better. Steel should be specified with phosphorus not to exceed 0.04 to 0.06 per cent.

Sulphur.—Sulphur has a tendency to render the steel hot short, and is therefore to be avoided in any steel that is to be forged, or otherwise worked hot. The sulphur, for good results, should not exceed 0.06 per cent. It is much better to keep the sulphur below 0.04 per cent.

Silicon.—Silicon is generally supposed to render steel cold short. High silicon should be avoided in steel for general purposes, and should not exceed 0.20 per cent except in castings.

Nickel.—Nickel in steel has a strengthening effect or tends to increase the value statically over the range above considered and in proportion to the amount present. Where the nickel content is 3.50 per cent (much of such steel is used) and in the annealed condition, its presence tends to increase the elastic limit from 25 to 50 per cent, depending upon the amount of carbon present.

Chromium.—Chromium in steel tends to make it intensely hard and give it a high elastic limit in the hardened or suddenly cooled state so that it is neither deformed permanently nor cracked by extremely violent shocks. It is stated that

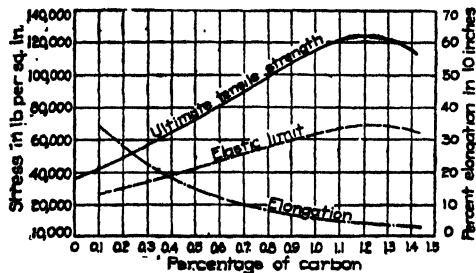

FIG. 1.—Effect of carbon upon the strength and ductility of carbon steel.

the hardness imparted by chromium in steel is not accompanied by as much brittleness as that induced by carbon.

14. Methods of Manufacture.—Steel is manufactured by one of several methods of which the following are important:

Bessemer.—Bessemer steel takes its name from the inventor of the process by which it is made. The process was patented by Sir Henry Bessemer in 1855 and, due to the low cost of manufacture, has contributed to the popularity of steel perhaps more than any other one factor. The converter which is used is a pot shaped vessel receiving the iron in the molten form, either direct from the blast furnace or from a cupola. Air is blown through the molten mass, thereby oxidizing the silicon, carbon and manganese. The heat of the reaction maintains the metal in a fluid condition until conversion is complete. Owing to the inability of this method to reduce materially the phosphorus or sulphur, two harmful elements, and loss due to some oxidation of the iron itself, it is rapidly being replaced by other methods which are more flexible. Bessemer steel may be identified by the high sulphur and phosphorus content.

Open-hearth.—Open-hearth steel takes its name from the character of the furnace in which it is manufactured. This is a furnace of the regenerative type originally introduced by Sir Wm. Siemens. The metal is melted on the hearth of the furnace, the hot gases passing over the surface, the heat being absorbed through the top of the bath. By a proper use of slags, phosphorus and sulphur can be reduced to any reasonable extent. Other conditions can be

controlled at will. This method is therefore much in favor and the bulk of the steel for structural material is now made by this process.

Electric.—Some steel is now made in the electric furnace and is known as *electric steel*. The steel is melted from cold materials and as such is known as *cold melt electric*; in connection with the Bessemer and open-hearth is known as *duplex electric*. Electric steel is largely alloy steel and has little use in building construction unless a high strength is required.

Crucible.—Crucible steel is produced by adding carbon or some other desired alloying element to wrought iron in a crucible of refractory material and supplying heat sufficient to melt the iron. It is used for making machine tools, axles and shafts.

15. Carbon Steel.—Carbon steel is defined by the International Association for Testing Materials as “Steel which owes its distinctive properties chiefly to the carbon as distinguished from the other elements which it contains.” It also can be defined as an alloy of iron, the carbon varying from 0.10 to 1.50 per cent.

A large part of the steel used for building construction is of this class and may be classified as soft, medium and hard. Soft steel is that with a carbon content of 0.30 per cent or under; medium steel is that of a carbon content from 0.30 to 0.60 per cent; and hard steel is that with a carbon content exceeding 0.60 per cent. Little steel with a carbon content exceeding 0.60 per cent is used in building construction since steels in the higher range of carbon are known as brittle and would have little use in an untreated condition. Springs and steels for metal and wood-working tools fall in this class.

Since the greater part of the steel used for building construction is carbon steel, the character of each kind should be carefully considered for different purposes.

Bessemer steel is used for little except rails, structural steel for buildings and concrete reinforcement bars, and much discrimination should be shown in regard to whether it should be used for any of these purposes. The high phosphorus present renders its use inadvisable when there is a condition of dynamic loading, so that in structures subject to heavy live load conditions, it should not be considered. The specifications of the American Society for Testing Materials provide for structural steel for buildings¹ for both Bessemer and open-hearth steel. The engineer should therefore be careful in making his selection to meet the need.

The use of open-hearth steel should be encouraged. Its use is constantly increasing and the prediction is freely made that in the course of a few years it will entirely replace Bessemer steel except for a few specialized uses. By far the greater part of the specifications of the American Society for Testing Materials as now written call for open-hearth steel.

16. Alloy Steel.—Alloy steel is defined by the International Association for Testing Materials as “Steel which owes its distinctive properties chiefly to some element or elements other than carbon or jointly to such other element and carbon.”

The simplest class of alloy steel is that having one alloying element in addition to iron and carbon. The best known of these steels are *nickel steel*, *chromium steel*, and *manganese steel*.

¹ See Appendix C.

Nickel steel has the most extensive use of all alloy steels for any purpose whatever. It is the general prediction that ultimately nickel structural steel will be used in practically all important structures. The strength of nickel steel is about 25 per cent higher than carbon steel for the same elongation and for the same purpose. Some use has already been made of nickel steel for structures and should be considered where physical conditions may limit the size of the members. Nickel steel is used in the normal (rolled) condition. The properties are considerably improved by heating treatment.

Chromium steel is used when extreme hardness is required. For such members as bearing plates that must resist crushing or wear or similar service, this material can be satisfactorily used. Chromium steel can be machined when annealed, but must be treated to be effective in use.

Manganese steel is a casting alloy possessing great resistance to abrasion and is used when a casting will apply. It cannot be finished except by grinding so cannot be used where other machining is necessary. It has found a use for switches and frog points, steam shovel bucket points and the lips of grab buckets. Its use is growing and the future will see a greatly extended use of this material.

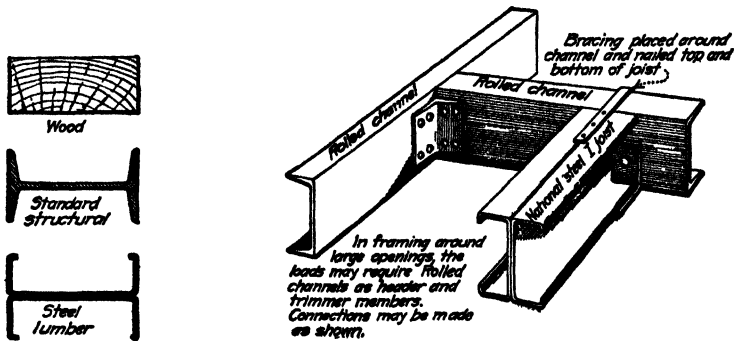

FIG. 2.

FIG. 2A.

The more highly developed alloy steels of the quaternary group have little application to building construction. Among these steels are the *chrome-nickel*, *chrome-vanadium*, *silico-manganese* and others carrying *tungsten*, *molybdenum* and *aluminum*. Consideration of these steels with their properties as affected by treatment, would be beyond the scope of this work.

If the reader feels sufficiently interested in the subject, it would be well to procure some well-known book on the subject, and study the same carefully, if to promote nothing more than an appreciation of this exceedingly important and far reaching subject.

17. Steel Castings.—For building construction, practically all steel castings are of carbon steel. This is usually of the medium grade (0.25 to 0.50 per cent) along the lower carbon range. While steel castings may be used in tension, such use is fraught with some danger and it is safe to consider such for compression or transverse loading only—the latter when the probability of contraction cavities will occur near the neutral axis or on the compression side.

The specifications of the American Society for Testing Materials should be used when steel castings are to be used.

The same imperfections that are found in iron castings are common to steel castings but in a more pronounced degree.

18. Rolled Shapes.—Rolled shapes—viz., beams, channels, angles, plates and bars—comprise the large part of steel used in building construction. This in a great measure is carbon steel of the soft and medium grades. The handbooks of the various steel manufacturers give full tables of the properties of the various sections rolled, also table of safe loads for different classes of loading. These tables use a factor of four, or a unit stress of 18,000 to 20,000 lb. The discriminating designer will consider the elastic limit rather than the ultimate strength and select an allowable unit stress that will be sufficient to cover the needs. It is manifestly necessary to allow a smaller unit stress where the conditions of loading are dynamic than where static. The specifications of the American Society for Testing Materials for steel for bridges and buildings should be used.

19. Forgings.—When rolled shapes are not available forgings can be made to suit the need and should be annealed before used to relieve the strain set up in the hammering operation. The specifications of the American Society for Testing Materials for carbon-steel and alloy-steel forgings should be used.

20. Uniform Specifications.—Uniform specifications have been realized in recent years through the efforts of the American Society for Testing Materials. The specifications of this Society should be used in every case where they apply. Time will be saved in drawing up general specifications by using the name, serial designation and latest revision of the particular specifications.

21. Examination of Structural Steel.—In the examination of structural steel the following flaws should be guarded against:

Pipes in structural steel appear as a small split, crack or fissure in the sheared or sawed end of the section. On sheared heavy sections the dragging may tend to hide it, but the practiced eye will detect the lip. In most sections the pipe in itself is not a dangerous defect as it is found in the center of the web, where the stresses are small or neutral, but presence of pipe indicates insufficient discard from the top of the ingot. This means that segregated, poor material is very apt to be present.

Scabs need very little description and are easily detected. They are not a dangerous defect but often interfere with fabrication and prevent the workmanlike finish desired. Scabs are the result of splashes on the side of the mold during the process of pouring.

Rooks are often mistaken for scabs as they draw out in the process of rolling. They are the result of transverse cracks formed by too heavy reduction in the early stages of rolling. They may be very deep and dangerous so should be carefully discarded.

Laps formed by rolling, an over-fill from the previous pass, are not generally dangerous unless they are unusually deep. Seams result from the drawing out of surface blow holes or other minor defects. They are not dangerous where the material is not to be forged or heat treated, but they, like laps, are unsightly and prevent workmanlike finish.

Guide marks and roll scratches are often taken for laps or seams. A bending test or pickling will generally reveal the true nature of such a defect.

22. Metal Lumber or Structural Pressed Steel.—Steel joists and metal lumber are synonymous terms for structural sections cold rolled from strip or sheet steel and assembled by electric spot welding or by riveting into shapes similar to structural I-beams and channels except that there are additional return flanges formed at right angles to the top and bottom flanges at their outer edges to further stiffen the member. These shapes are made up to 12 in. in depth.

There are two distinct types of sections now on the market known as *plate girder* and *double channel* section. In the plate girder section the web is made from a single thickness of heavy gage strip steel to which are welded four angles

to form a shape similar to a structural plate girder. The double channel section is formed from two uniform channels welded back to back.

The loading tables of all sections are standardized so that either section will support the same load over the same span for any given depth of joist. As the plate girder section has less metal at the neutral axis and approximately the same as the double channel section at the flanges, the former section weighs a trifle less per linear foot than the latter. The properties of these sections are calculated on the basis of the commonly accepted formulas for structural steel shapes.

When the sections are used as floor joists, they are placed not more than 24 in. apart on centers, being supported at the ends by masonry, concrete or structural steel. Usually they are bridged at intervals by tension bridging. On top of the joists, and attached firmly to them, is an expanded mesh usually of a ribbed type of such strength and mesh design that a dry concrete mix can be poured on top to form a solid slab without undue sag of the metal, and without undue loss of the essential concrete ingredients. This mesh acts as form and centering, and eliminates the usual form work required for concrete.

When a wood finish floor is desired, nailing screeds are attached to the joists parallel to them and over the center of the joist section. The wood floor is nailed directly to the screeds. This eliminates the necessity of a double wood flooring. Underneath the joists, either attached directly thereto or suspended from them, is placed a steel mesh to form the base for a plastered ceiling.

When steel joists or channels are used as studs in partition construction, they are attached at the top and bottom to cap and sill channels by means of bolts. An expanded metal lath is then attached to both sides of the studs and plastered. While steel joist stud partitions are excellent from the standpoint of resistance to fire and sound, and make a very light construction, they are not economical when used as bearing partitions.

Steel joist construction was first used in 1853 but did not come into general use until about 1905.

The advantages claimed for the construction are: economy of materials, due to the elimination of heavy floor dead loads and the resultant saving in size and strength of supporting members; economy of labor, due to the elimination of field fabrication, as all sections come from the shops fully fabricated; and the economy of materials due to the elimination of form work.

The construction is classed as fire-resistive because there are no combustible materials in it and the sections themselves, having no internal stress, need not be fireproofed as heavily as ordinary hot rolled structural shapes, and because the application of the materials is limited by the economical spans and loads to such types of buildings as are usually classified as "light occupancy" structures in which the fire hazard is small.

The construction is claimed to be permanent when used under normal conditions in floor or partition construction. There is no material that is proof against accidents, and yet there are no cases on record of failure of steel joists even under accidental loads. The steel is not subjected to conditions which would cause it to oxidize. As the steel itself is highly resistant to oxidation, due to its chemical and physical properties, and is thoroughly painted, examination of sections after fifteen to twenty years of use has proven the permanency of the construction.

The construction is claimed to be soundproof because of the fact that sound is transmitted most readily through substances of the same density, and materials comprising a steel joist floor have widely differing densities.

Some of the other advantages claimed for steel joist construction are: speed of construction, regardless of weather conditions; reliability because of the elimination of unknown factors; simplicity of design, which is an advantage to architects and engineers, both from the standpoint of the details of construction as well as from the standpoint of inspection and supervision, and is an advantage to both architects and contractors in providing a construction as simple as wood, and yet not having the disadvantages of warping, shrinking, sagging, combustibility and decay. Steel joists of the same or less depth of member also provide greater strength for longer spans than wood.

TIMBER

23. Names.—The following is a list of common names as applied to wood in commerce:

Ash (white, black, blue, green and red ash); *basswood* (linden, linn, lind or lime-tree); *beech* (red and white beech); *birch* (red, white, yellow and black birch); *buckeye* (wood from the horse-chestnut tree); *butternut* (butternut also known as white walnut); *cherry* (sweet, sour, red, black and wild cherry); *chestnut*; *cottonwood*; *cypress* (bald cypress, red, gulf, yellow and East Coast cypress); *elm*, *rock* (white, water, gray, red or slippery and winged elm); *elm, rock* (rock or cork elm); *Douglas fir* (yellow, red, Western, Washington, Oregon, Puget Sound fir or pine, West Coast fir); *gum* (red gum, sweet gum or satin walnut); *black gum*; *hemlock* (Eastern hemlock, *i.e.*, from all states east of and including Minnesota); *Western hemlock* (hemlock from the Pacific Coast); *hickory* (shellbark, kingnut, mockernut, pignut, black, shagbark and bitternut); *Western larch* (larch or tamarack from the Rocky Mountain and Pacific Coast regions); *maple, soft* (soft and white maple); *maple, hard* (hard, red, rock and sugar maple); *white oak* (white, burr or mossy cup, rock, post or iron, overcup, swamp, post, live, chestnut or tan bark, yellow and basket or cow oak); *red oak* (red, pin, black, water, willow, Spanish, scarlet, Turkey, black jack or barn, and shingle or laurel oak); *pecan*; *Southern pine* (all pines of the Southern States manufactured into lumber, including longleaf, shortleaf, loblolly and Cuban pine;¹ *white pine* (wood from tree of that name grown in Maine, Michigan, Wisconsin, Minnesota and Canada); *Norway pine* (Norway or red pine grown in Michigan, Wisconsin, Minnesota and Canada); *Idaho white pine* (varieties of white pine grown in Western Montana, Northern Idaho and Eastern Washington); *Western pine* (timber known as white pine grown in Arizona, California, New Mexico, Colorado, Oregon and Washington; sometimes known as Western yellow or ponderosa pine, or California white pine or Western white pine); *poplar* (wood from the tulip tree, otherwise known as white-wood, yellow poplar and canary wood); *redwood*; *spruce* (spruce timber from points east of and including Minnesota and Canada, covering white, red and black spruce); *Western spruce* (spruce timber from the Pacific Coast); *sycamore*; *tamarack* (tamarack or Eastern tamarack, grown in states east of and including Minnesota); *tupelo* (tupelo gum and bay poplar); *walnut* (black walnut).

¹ See p. 652 for definitions of "dense" and "close-grained" pine.

These names have been adopted by the Master Car Builders' Association, and in part by the American Railway Engineering Association and the American Society for Testing Materials, as far as they refer to woods used for structural purposes.

24. Definitions.—In describing timbers, various terms having special application are used. The following are some of the more important ones:

Axis.—The line connecting the centers of successive cross-sections of a stick.

Corner.—The line of intersection of the planes of two adjacent longitudinal surfaces.

Cross-section.—A section of a stick at right angles to the axis.

Edge.—Either of the two narrower longitudinal surfaces of a stick.

Face.—The surface of a stick which is exposed to view in the finished structure.

Full Length.—Long enough to "square" up to the length specified in the order.

Girth.—The perimeter of a cross-section.

Heartwood.—The older and central part of a log, usually darker in color than sapwood. It appears in strong contrast to the sapwood in some species, while in others it is but slightly different in color.

Out of Wind.—Having the longitudinal surface plane.

Side.—Either of the two wider longitudinal surfaces of a stick.

Solid.—Without cavities; free from loose heart, wind shakes, bad checks, splits or breaks, loose slivers and worm or insect holes.

Sound.—Free from decay.

Springwood.—The inner part of the annual ring formed in the earlier part of the season, not necessarily in the spring, and often containing vessels or pores.

Square-cornered.—Free from wane.

Straight.—Having a straight line of an axis.

Summerwood.—The outer part of the annual ring formed later in the season, not necessarily in the summer, being usually dense in structure and without conspicuous pores.

True.—Of uniform cross-section. Defects are caused by wavy or jagged sawing or consist of trapezoidal instead of rectangular cross-sections.

25. Hardwoods and Soft Woods.—These terms are applied commercially to signify a more or less artificial classification. Hardwoods usually are broad-leaf trees such as oak, maple, hickory, chestnut, beech, etc. Soft woods include pines, fir, cedar, spruce, etc. Note that the terms hard and soft do not specifically refer to actual hardness.

26. Grain.—A term used in reference to the arrangement or direction of the wood elements and to the relative width of the growth rings. The kinds of grain commonly described are fine, coarse, even, uneven, rough, smooth, straight, spiral, twisted, wavy, etc. Coarse grain means with wide rings; fine grain, narrow rings. Straight grain applies to boards or timber in which the wood elements are parallel to the axis.

27. Non-porous Woods.—Non-porous applied to woods of fairly uniform structure, in which no large vessels are visible even with a magnifying lens, includes pines and other coniferous woods. Diffuse porous applies to woods in which large vessels are distinctly visible scattered throughout the annual ring. This includes such woods as birch, maple, tupelo, cottonwood, etc.

28. Ring Porous Woods.—Ring porous is applied to woods in which large vessels are localized in distinct rings or bands in the early spring wood; includes such woods as oak, chestnut, elm, mulberry, ash, etc.

29. Defects.—The term defect or blemish as applied to wood usually implies the idea of imperfections. These are not always detrimental. They include knots, holes, checks, shakes, etc. The following is a list adopted by the American Railway Engineering Association:

29a. Knots.—A knot is the hard mass of wood formed in a trunk of a tree at a branch, with the grain distinct and separate from the grain of the trunk.

Knots shall be classified according to size, form and quality.

The average of the maximum and minimum diameters shall be used in measuring the size of knots unless otherwise stated.

In all grades of material all knots should be sound and tight unless otherwise specified.

Pin Knot.—One not over $\frac{3}{8}$ in. in diameter.

Small Knot.—One between $\frac{3}{8}$ and $\frac{3}{4}$ in. in diameter.

Standard Knot.—One between $\frac{3}{4}$ and $1\frac{1}{2}$ in. in diameter.

Large Knot.—One not over $1\frac{1}{2}$ in. in diameter.

Round Knot.—One whose maximum diameter is not over one and one-half times as great as its minimum diameter.

Oval Knot.—One having its maximum diameter one and one-half to three times as great as its minimum diameter.

Spike Knot.—One sawed in a lengthwise direction whose maximum diameter is over three times as great as its minimum diameter.

Sound Knot.—One which is solid across its face, and is as hard as the wood surrounding it and shows no indications of decay.

Unsound or Rotten Knot.—One not as hard as the wood surrounding it or one in which decay has started.

Tight Knot.—One so fixed by growth or position that it will firmly retain its place in the piece.

Loose Knot.—One not held firmly in place by growth or position.

Live Knot.—One whose growth rings are completely intergrown with those of the surrounding wood.

Encased Knot.—One whose growth rings are not intergrown and homogeneous with the growth rings of the surrounding wood. The encasement may be partial or complete.

Watertight Knot.—One whose growth rings are completely intergrown with those of the surrounding wood on one face of the piece, and which is sound on that face.

Pith Knot.—Sound knot except that it has a pith hole in the central growth ring. The hole rarely exceeds $\frac{1}{4}$ in. in diameter.

29b. Holes.—Holes in wood may extend partially or entirely through the piece. They are enumerated as knot, dog, picaroon, bird, insect (including pin, shot, spot, grub worms, etc.), metal and wooden rafting pin holes, through pitch pockets and the like.

When holes are permitted, the average of the maximum and minimum diameters at right angles to the direction of the hole shall be used in measuring the size, unless otherwise stated.

Wooden rafting pinholes sometimes appear on river timber which has been rafted when holes have been bored in the solid wood for securing the timber, and a solid plug or pin driven in the hole, completely filling it. These defects must be treated and considered the same as knot defects. Ordinary metal rafting pin, canthook or chain dog-hole is not considered a defect.

Grub worm holes are usually from about $\frac{1}{8}$ to $\frac{3}{16}$ in. in width, and vary in length from about 1 to $1\frac{1}{2}$ in. and are caused by grubs working in the wood.

Pin worm holes are very small holes caused by minute insects or worms. These holes are usually not over $\frac{1}{16}$ in. in diameter. The wood surrounding them is sound and does not show any evidence of the worm hole having any effect on the wood other than the opening.

Spot worm defects (also known as *flagworm defects*) are caused, like pinworm holes, by minute insects or worms working on the timber during the growth. The size of the hole

is about the same as pinworm holes, but the surrounding wood shows a colored spot as evidence of the blemish. This spot is usually sound and does not affect the strength of the piece.

29c. Checks.—A check is a separation of the wood cells along a radial plane of the tree due to unequal shrinkage during seasoning.

Surface check is a shallow check occurring on the surface of a piece.

End check is one occurring on an end of a piece.

Through check is one extending from one surface through the piece to the opposite face or to an adjoining face.

Heart check is one starting at the pith and extending toward but not to the surface of a log and is not necessarily due to seasoning.

Star check is the combination of several heart checks occurring together.

Honeycombing is checking occurring in the interior of a piece; often the checks are not visible on the surface. On a cross-section they usually appear as slits, or as open pockets whose width may appear very large in proportion to the radial length.

Ordinary season checks such as occur in lumber properly covered in yard, or *season checks* of equal size in kiln-dried lumber, shall not be considered defects.

29d. Shakes and Splits.—A shake is a cylindrical separation of the wood, following in general the annual layers (rings) of growth. Thus any shake is a ring shake.

Round shake is one completely encircling the pith.

Cup shake is one that does not completely encircle the pith.

Through shake is one extending from one surface through the piece to the opposite face or to an adjoining face.

Pitch Shake.—A clearly defined seam or opening between the grain of the wood which may or may not be filled with granulated pitch.

Split is a lengthwise separation of the wood due to tearing apart of the wood cells in rough handling, felling the tree or similar causes. It may run in any direction across the end of a piece.

Pith is the small soft core occurring in the center growth ring of a log. In some woods it is large enough to mar the surface of the piece on which it appears. The wood immediately surrounding the pith often contains small checks, shakes or numerous pin knots and is often discolored; any such combination of defects and blemishes is known as *heart center*.

29e. Pitch Pockets.—A pitch pocket is a well-defined opening between the annual layers of growth, usually containing more or less pitch, either solid or liquid. Bark may also be present in the pocket. On an edge-grain surface pitch pockets appear as narrow open seams, and on flat grain surface they vary in appearance from narrow open seams to oval cavities sometimes called *scab pitch pockets*. On either surface they are known as very small, small, medium or large, depending upon their size.

Very Small Pitch Pockets.—One not over $\frac{1}{8}$ in. in width and not over 2 in. in length.

Small Pitch Pocket.—One whose maximum width may vary from $\frac{1}{8}$ to $\frac{1}{4}$ in. provided a maximum limit of length of 4 in. decreases to 2 in. proportionately as the width increases.

Medium Pitch Pocket.—One whose maximum width may vary from $\frac{1}{8}$ to $\frac{3}{8}$ in. provided a maximum limit of length of 9 in. decreases to 3 in. proportionately as the width increases.

Large Pitch Pocket.—One whose width or length exceeds the sizes stated as permissible for a medium pitch pocket.

Bark pocket is a patch of bark partially or wholly enclosed in the wood. It may result from wood and bark forming over a place where the tree has been injured. As a defect it is measured in the same manner as a pitch pocket.

29f. Streaks and Discolorations. *Pitch Streak.*—A well-defined and conspicuous accumulation of pitch in the wood cells. It is usually not considered an important blemish unless both springwood and summerwood appear saturated. They are known as small, medium or large, depending upon their size with respect to the piece they are in.

Small Pitch Streak.—One whose area does not exceed the product of one-twelfth the width by one-sixth the length of the face on which it occurs.

Medium Pitch Streak.—One whose area does not exceed the product of one-sixth the width by one-third the length of the face on which it occurs.

Large Pitch Streak.—One whose area exceeds the product of one-sixth the width by one-third the length of the face on which it occurs.

Pith fleck is a narrow streak, usually brownish, up to several inches in length on the face of a piece resulting from the larva of an insect having burrowed in the growing tissue or cells of the tree.

Bird peck is a small hole or patch of distorted grain resulting from birds pecking through the growing cells in the tree. It usually resembles a carpet tack in shape with the point towards the bark and it is usually accompanied by a discoloration extending along the grain and usually to a smaller extent around the layers of growth. A section through the discoloration produced by the bird peck produces what is commonly known as *mineral streak*.

Gum spot or streak is an accumulation of gum-like substance occurring as a small patch or streak in the piece. It may occur in conjunction with a bird peck or other injuries to the growing wood.

Discolorations on or in lumber are enumerated as weather, sticker, water or fungus (such as blue stain, etc.) stain, brown stain, kiln burn and similar color changes due to a combination of temperature, moisture, chemicals, etc. Discoloration may follow insect attack, bird peck, etc. Well-defined discolorations are known as light, medium and heavy.

Light discoloration is paler than the medium discoloration and occurs in approximately one-fourth of the stained stock.

Medium discoloration is a shade most commonly found and which occurs in approximately one-half of the stained stock.

Heavy discoloration is darker than the medium discoloration and occurs in approximately one-fourth of the stained stock.

Decay is disintegration of the wood substance due to the action of certain kinds of fungi. A few of the rot-producing fungi which start in the standing tree do not seem to seriously develop after the tree is cut into lumber.

Red heart of the pines, spruces, Douglas fir and some other conifers, and peck of cypress and incense cedar are produced by fungi of this type. Decay may be classified as incipient and advanced decay.

Incipient decay is the early stages of decay, usually detected by a discoloration of the wood which seems to be firm and solid.

Advanced decay or rot is noticeable as a decided softening or breaking down of the wood.

Water stain, or what are sometimes called scalded or burnt spots, usually caused by timber lying in the water under certain conditions before it is sawed, and burnt spots where timber is improperly piled while green, are not considered defects, as they do not affect the strength of the piece.

"Sap."—*Sapwood* is the alburnum of the tree, the exterior part of the wood next to the bark. Sapwood is not considered a defect except where lasting power is involved.

Sound Heart.—The term "sound heart" is used whenever that part of the piece which was originally the central part or core of the tree is sound and solid, not decayed.

29g. Grain.—*Cross grained wood* is that in which the wood cells or fibers do not run parallel with the axis or sides of a piece. It may be classified as spiral, diagonal, wavy, dip, curly and interlocked grain. The slope of the grain can be determined by observing the direction of surface checks, resin ducts, pores of the wood, annual layers of growth, etc. A drop of stained liquid such as ink tends to elongate in the direction of the grain when placed on a smooth surface of the piece.

Spiral grained wood is that in which the fibers take a more or less winding or spiral course, such as occurs in a twisted tree. It may be detected on the flat grain (plain sawed or tangential) surface.

Diagonal grained wood is that in which the fibers extend at an angle (*i.e.*, diagonally) across a piece as a result of sawing at an angle across the annual layers of growth. It may appear on either the radial or tangential surface.

Wavy grained wood is that in which the fibers take the form of waves or undulations as indicated by the wavy surface of the split piece. It may appear on either the radial or tangential surface.

Dip grained wood is that which has one wave or undulation of the fibers such as occurs around knots, pitch pockets, etc.

Curly grained wood is that in which the fibers are distorted so that they take a curled direction as in "birdseye wood." These patches may vary up to several inches in diameter.

Interlocked grain is wood that shows spiral grain in one direction for a number of years and then the slope of the grain in the succeeding annual layers of growth turns in a reverse direction around the tree, then later reverses back, etc.

29h. Distortions and Crooks.—*Cross break* is a separation of the wood cells across the grain. It may be due to tension resulting from unequal longitudinal shrinkage or mechanical stresses.

Compression failure is a wrinkling or buckling of the wood cells extending in a more or less irregular plane across the grain. It is due to longitudinal crushing or compression.

Collapse is a caving in of the surface of a piece. It sometimes occurs in streaks giving the surface a corrugated appearance and is often due to the flattening of the cells when drying wet wood at high temperatures.

Warping is any variation from a true or plane surface. It includes crook, bow, twist or any combination of these.

Crook is a deviation edgewise from a straight line drawn from end to end of a piece and is measured at the point of greatest departure from a straight line. It is known as slight, small, medium and large. Unless otherwise specified, the different degrees of crook based on a piece 4 in. wide and 16 ft. long shall be as follows:

Slight crook, a departure of 1 in.

Small crook, a departure of $1\frac{1}{2}$ in.

Medium crook, a departure of 2 in.

Large crook, a departure of over 2 in.

For wider pieces it shall be $\frac{1}{8}$ in. less for each additional 2 in. of width.

Shorter or longer pieces shall have the same limits for curvature.

Bow is a deviation flatwise from a straight line drawn from end to end of a piece measured at the point of greatest distance from a straight line.

Cupping is the curvature of a piece across the grain or width of a piece.

Twisting is the turning or winding of the edges of a piece so that four corners of any face are no longer in the same plane (i.e., it is the twisting of an edge around the axis of the piece).

Wane is bark or the lack of wood, from any cause, on the edge of a piece.

30. Defects of Manufacture, Applicable to All Timber and Lumber.—Defects in rough stock caused by improper manufacture and drying will reduce grade, unless they can be removed in dressing such stock to standard sizes.

In structural timber defects of manufacture have usually been omitted, being of minor significance.

Imperfect manufacture in dressed stock, such as torn grain, loosened grain, slight skips in dressing, wane, broken knots, mismatched, insufficient tongue or groove for flooring, ceiling, drop siding, etc., shall be considered defects, and will reduce the grade according as they are slight or serious in their effects on the use of the stock.

Torn grain consists of a part of the wood having been torn out in dressing. It occurs around knots and curly places and is of four distinct characters: slight, medium, heavy and deep. Slight torn grain shall not exceed $\frac{1}{32}$ in. in depth; medium $\frac{1}{16}$ and heavy $\frac{1}{8}$ in. Any torn grain heavier than $\frac{1}{8}$ in. shall be termed deep.

Loosened grain consists in a point of one grain being torn loose from the next grain. It occurs on the heart side of the piece and is a serious defect, especially in flooring.

Chipped grain consists in a part of the surface being chipped or broken out in small particles below the line of cut and, as usually found, should not be classed as torn grain, and shall be considered a defect only when it unfits the piece for use intended.

Pieces of flooring, drop siding or partition with $\frac{3}{16}$ in. or more of tongue; and pieces of ceiling with $\frac{1}{8}$ in. or more of tongue; and pieces of ship lap with $\frac{5}{16}$ in. of lap will be admitted to any grade.

Pieces of flooring, drop siding, ceiling or partition having not less than $\frac{1}{16}$ -in. tongue will be admitted in No. 2 common. Pieces of ship lap having less than $\frac{5}{16}$ -in. and not less than $\frac{1}{8}$ -in. lap shall be admitted in No. 2 common.

31. Weight of Wood.—Wood varies in weight depending upon the kind of tree that it is cut from and the location in the tree. Weight also depends largely on the amount of water contained. Green wood will contain from 50 to 75 per cent water, air-dry wood from 10 to 20 per cent. The absolute weight of dry wood substance is 99.888 lb. per cu. ft. (specific gravity 1.6). The outer or sapwood is usually heavier than the inner heart or heartwood. In the same way the wood near the base of the tree is usually heavier than that near the top. Wood from trees of the same species will vary considerably in weight.

The following table gives shipping weights of lumber in pounds per thousand feet board measure:

TABLE 1.—SHIPPING WEIGHTS OF LUMBER
(Pounds per thousand feet board measure)

	Green from saw	Shipping dry	Well seasoned	Kiln dried
Ash, black.....	4,600	3,200	3,000
Ash, white.....	4,600	3,800	3,300
Basswood.....	4,200	2,800	2,500	2,100
Beech.....	5,750	4,000
Birch.....	5,500	4,000
Butternut.....	4,000	2,500
Chestnut.....	5,000	2,800	2,450
Cherry.....	5,000
Cottonwood.....	4,600	3,100	2,800	2,400
Elm, rock.....	5,400	4,300	4,000	3,500
Elm, soft.....	4,750	3,300	3,100	2,900
Gum.....	5,400	3,600	3,300	3,050
Gum, sap.....	5,000	3,300	3,000	2,750
Hickory.....	6,000	4,500
Mahogany.....	4,500	3,500
Maple, hard.....	5,400	4,150	3,900	3,400
Maple, soft.....	5,000	3,650	3,300	3,000
Oak, red.....	5,500	4,250	4,000	3,400
Oak, white.....	5,700	4,500	4,100	3,600
Poplar.....	3,900	3,000	2,800	2,400
Poplar bay (Tupelo).....	4,200	3,000
Sycamore.....	4,750	3,000
Walnut.....	4,900	4,000	3,800

32. Hardness.—Hardness refers both to resistance to abrasion or wear and resistance to indentation. According to Record hardness combined with tough-

ness is a measure of the wearing ability of wood when referring to abrasion and is an important consideration for the use of wood for floors, paving blocks, bearings and rollers. In use for floors some woods tend to compact and wear smooth, while others become splintery and rough. This factor is affected to some extent by the manner in which the wood is sawed; thus edge grain cypress, pine and fir flooring is much better than flat sawn for uniformity of wear. The following list gives woods in the order of hardness: Osage orange, honey locust, swamp white oak, white oak, post oak, black oak, red oak, white ash, beech, sugar maple, rock elm, hackberry, slippery elm, yellow birch, tupelo, red maple, sycamore, black ash, longleaf pine, white elm, Douglas fir, cypress, hemlock, tamarack, red pine, white fir, Western yellow pine, lodgepole pine, white pine, Engelmann spruce, Alpine fir and basswood.

33. Cleavability.—This is a term used with reference to the splitting qualities of woods. A general classification is as follows:

Difficult to split: black gum, elm, sycamore, dogwood, beech, holly, maple, birch, and hornbeam.

Medium: oak, ash, larch, cottonwood, linden, yellow poplar and hickory.

Easy to split: chestnut, pines, spruce, fir and cedar.

34. Calorific Value.—The heat or fuel value of wood depends on its weight and moisture content. According to Schenck one cord of green wood contains 250 gal. of water; wood with 45 per cent moisture gives only 50 per cent as much heat as dry wood; rosin increases the heating power by about 12 per cent. According to Roth, 100 lb. of wood as sold in wood yards contains 25 lb. of water, 74 lb. of dry wood and 1 lb. of ashes; 100 lb. of green wood (50 per cent moisture) will give 270,000 B.t.u., 100 lb. air-dry wood (10 per cent moisture) about 580,000 B.t.u. and 100 lb. kiln-dry wood (2 per cent moisture) 630,000 B.t.u. In rating woods for fuel value they have been listed as follows: Best, hickory, beech, hornbeam, locust and heart pine; good, oak, ash, birch and maple; moderate, spruce, fir, chestnut, hemlock and sap pine; poor, white pine, alder, linden and cottonwood.

35. Strength.—"The term strength in a strict sense means ability to resist stress or force of one kind, as strength in bending, strength in compression, etc. However, strength as applied to wood may have a variety of meanings, depending on the use in mind for the wood. In speaking of the strength of columns or posts in buildings, strength in compression is generally meant. In the case of beams, bending strength is thought of. In wood for axe handles, the toughness or shock-resisting ability and hardness are generally included in the term strength. It is evident that strength may include several properties or a single property, according to the use in mind, and that in comparing woods the property or properties must be specified for a clear understanding. Tests to determine the mechanical properties of wood, such as bending tests, compression tests, shearing tests, hardness tests, etc., to be strictly comparable must be made on straight-grained pieces free from defects, such as knots, shakes, etc., and in the same condition of seasoning. It would manifestly be misleading to compare the strength of oak containing defects with clear hemlock, or the strength of green ash with dry birch."¹

¹ From "Timber, Its Strength, Seasoning and Grading" by H. S. BERRS.

Wood cut from individual trees of the same species will vary considerably in strength, in view of the fact that trees are natural products. There is, therefore, no absolute strength value for any kind of wood. This should be clearly remembered in using tables of strength value. The latter represents average strength as obtained from tests of a large number of pieces from different trees. Results of strength tests by various authorities will frequently differ because different numbers of pieces have been tested, often from trees grown in different localities. The strength values given in Table 2 are the result of the collected timber test data of the United States Forest Service amounting to about 130,000 tests. Working stresses permissible for structural timbers are given in Table 1 on p. 632.

Moisture has a very material effect on the strength of wood. Above 35 per cent there is no change in strength, while if the moisture is reduced below this point the strength increases rapidly. The increased strength is more obvious for small pieces than for larger pieces.

The denser or heavier the wood the stronger it is. Sapwood is as strong as heart wood.

The strength of timber is materially affected by the kind, number and position of defects. This is more marked in larger than in smaller pieces.

The following quotation is taken from "Timber, Its Strength, Seasoning and Grading" by H. S. Betts:

(1) The density or dry weight of wood is a measure of its strength.

(2) Each annual growth ring is made up of a comparatively heavy band of summerwood and a lighter band of springwood. The greater the proportion of summerwood, the greater the weight and strength of the timber.

(3) No differences in mechanical properties due to a change from sap to heart have been found. As a general rule, in species which show a variation in the mechanical properties with position in cross-sections, there is a certain age when the best wood is produced. In such species the age and thrift of the tree determine whether heart or sap is the better. For example, in a young, thrifty hickory the sapwood is usually the better, while in a large, over-mature tree of the same species the heartwood is the better.

(4) Exceedingly rapid or slow growth in conifers has usually been found to be attended by lack of density and inferior mechanical properties.

(5) The effect of location of growth on the nature of the timber is very complex. Variations attributed to difference in locality of growth are frequently exaggerated. These variations are generally apparent in the difference in density of the wood.

(6) Trees growing close together and apparently under the same conditions occasionally show a difference in their mechanical properties that cannot be entirely accounted for by the difference in density. Whether this difference is due to the ancestry of the tree or some other cause, such as soil conditions, is not yet known.

(7) The strength of small, clear pieces is greatly increased by seasoning. In large timbers, the increased strength attending a loss of moisture is mostly offset by checks and other defects developed during the seasoning process, and therefore, under most conditions it is not considered advisable to anticipate any added strength due to seasoning.

The following definitions are taken from *Bull.* 556, United States Department of Agriculture, Mechanical Properties of Woods Grown in the United States, by J. A. Newlin:

Air-dry.—Air-dry is the condition with respect to moisture in wood exposed to the air for a sufficient period of time so that the moisture becomes more or less constant. This varies from 6 to 30 per cent, depending upon the timber.

Kiln-dry.—The condition of wood dried in a dry-kiln; moisture of kiln-dry wood 6 per cent or less.

TABLE 2.—RESULTS OF TESTS ON 126 SPECIES OF WOOD TESTED IN A GREEN CONDITION IN THE FORM OF SMALL CLEAR PIECES
 (Test specimens are 2 by 2 in. in section. Bending specimens are cut 30 in. long; others are shorter, depending on kind of test.)
 Reprinted from Bulletin 556, U. S. Dep't. of Agriculture "Mechanical Properties of Woods Grown in the United States" by J. A. Newlin.

Common and botanical name	Locality where grown	Number of trees	Number of rings per inch	Summerwood (per cent)	Moisture content (per cent)	Volume when green	Volume when oven-dry	Specific gravity, oven-dry, based on			Shrinkage from green to oven-dry condition			Static bending		Impact bending	Compression parallel to grain		Tension perpendicular to grain (lb. per sq. in.)	Bearing strength parallel to grain (lb. per sq. in.)	Compression perpendicular to grain—fiber stress at elastic limit (lb. per sq. in.)	24	25	26	27		
								Weight per cubic foot (green) (lb.)	In volume (per cent of dimensions when green)	Radial (per cent of dimensions when green)	Tangential (per cent of dimensions when green)	Fiber stress at elastic limit (lb. per sq. in.)	Modulus of rupture (lb. per sq. in.)	Modulus of elasticity (1,000 lb. per cu. in.)	To elastic limit (in-lb. per cu. in.)		To maximum load (in-lb. per cu. in.)	Work in bending to elastic limit (in-lb. per cu. in.)								Height of drop causing complete failure, 60-lb. hammer (in.)	Fiber stress at elastic limit (lb. per sq. in.)
Hardwoods																											
Alder, red (<i>Alnus cre-</i>																											
... gna)	Washington	6	11	..	98	0.370	0.43	46	12.6	4.4	7.3	3,800	6,500	1,170	0.70	8 0	8,000	2 6	22	2,650	2,960	310	770	390	550	440	
Ash, white (<i>Fraxi-</i>																											
... nus	Tennessee	5	17	49	42	0.510	0.58	45	12.6	4.2	6.9	5,500	9,300	1,340	1.31	11.6	11,900	4.9	30	3,560	3,980	880	1,230	540	950	850	
Ash, black (<i>Fraxinus</i>																											
... nigra)	Michigan, Wisconsin	15	24	53	83	0.460	0.53	53	15.2	5.0	7.8	2,600	6,000	1,020	0.42	12.4	7,200	2.5	32	1,620	2,290	430	870	490	530	550	
Ash, white (<i>Fraxinus</i>																											
... quadrangularis)	Kentucky	5	12	49	39	0.530	0.60	46	11.7	3.9	6.5	5,700	9,600	1,240	1.47	14.7	11,100	5 0	43	3,540	4,180	990	1,540	550	1,140	1,030	
Ash, green (<i>Fraxinus</i>																											
... lanceolata)	Missouri, Louisiana	10	18	58	48	0.520	0.61	48	12.5	4.6	7.1	5,300	9,500	1,400	1.14	11.8	11,400	5 0	34	3,560	4,200	910	1,260	590	960	870	
Ash, Oregon (<i>Fraxinus</i>																											
... oregona)	Oregon	3	12	63	48	0.500	0.58	40	13.2	4.1	8.1	4,200	7,600	1,130	0.92	12.2	8,900	3 0	39	2,740	3,510	650	1,190	490	850	790	

TABLE 2.—RESULTS OF TESTS ON 126 SPECIES OF WOOD TESTED IN A GREEN CONDITION IN THE FORM OF SMALL CLEAR PIECES (Continued)

Common and botanical name	Locality where grown	Number of trees	Number of rings per inch	Summerwood (per cent)	Moisture content (per cent)	Specific gravity, based on		Shrinkage from green to over-dry condition		Static bending		Impact bending		Compression parallel to grain		Shearing strength parallel to grain (lb. per sq. in.)	Tension perpendicular to grain (lb. per sq. in.)	End (lb.)	Hardness load required to embed a 0.444-in. ball to one-half its diameter												
						Volume when green	Volume when over-dry	Weight per cubic foot (green) (lb.)	In volume (per cent of dimensions when green)	Radial (per cent of dimensions when green)	Tangential (per cent of dimensions when green)	Fiber stress at elastic limit (lb. per sq. in.)	Modulus of rupture (lb. per sq. in.)	To elastic limit (in-lb. per cu. in.)	To maximum load (in-lb. per cu. in.)					Fiber stress at elastic limit (lb. per sq. in.)	Height of drop causing complete failure, 60-lb. hammer (in.)	Maximum crushing strength (lb. per sq. in.)	Compression perpendicular to grain—fiber stress at elastic limit (lb. per sq. in.)								
HARDWOODS—contd.																															
Ash, pumpkin (<i>Fraxinus pyramidalis</i>)	Missouri	3	21	46	51	0.48	0.55	46	12	0	3.7	6.3	4,500	7,600	1,040	1	08	9	4	8,800	3.7	31	2,830	3,360	990	1,210	570	880	750		
Ash, white (forest grown)	Arkansas, West Virginia	10	16	50	43	0.52	0.60	46	12	6	4.2	6.5	4,900	9,100	1,350	1	03	13	4	11,700	5	0	36	3,230	3,800	800	1,260	620	1,000	900	
Ash, white (second growth)	New York	5	9	63	40	0.58	0.71	51	14	0	5.3	8.7	6,100	10,800	1,640	1	30	16	3	13,800	5	9	47	3,820	4,610	790	1,900	790	1,140	1,080	
Aspen (<i>Populus tremuloides</i>)	Wisconsin	5	8	..	107	0.36	0.42	47	11	1	3.3	6.9	2,900	5,300	840	0	65	6	9	6,900	2	5	28	1,620	2,160	200	620	180	270	320	
Aspen, largetooth (<i>Populus grandidentata</i>)	Wisconsin	5	8	..	96	0.35	0.41	43	11	6	3.1	7.9	3,200	5,800	1,130	0	50	6	1	7,600	2	7	18	2,130	2,720	270	810	390	440	370	
Basswood (<i>Tilia americana</i>)	Pennsylvania, Wisconsin	8	19	29	103	0.33	0.40	41	15	8	6.1	9.3	2,700	5,000	1,030	0	42	5	2	6,200	2	0	17	1,710	2,210	210	610	280	280	250	
Beech (<i>Fagus americana</i>)	Indiana, Pennsylvania	10	19	30	62	0.54	0.66	55	16	2	4.8	10	6	4,500	8,200	1,240	0	99	12	5	10,400	4	2	40	2,550	3,280	610	1,210	760	950	830
Birch, paper (<i>Betula papyrifera</i>)	Wisconsin	5	6	36	73	0.47	0.60	51	16	3	6	8.8	2,900	5,800	1,010	0	48	15	0	7,800	2	7	45	1,650	3,210	300	790	380	400	490	

Black, sweet (Betula)	Pennsylvania	5	27	..	61	0.59	0.70	59	15.0	6.3	7.6	4,500	8,600	1,490	0.81	15.6	9,500	3.1	44	2,650	3,560	520	1,220	550	1,020	890
Black, yellow (Betula resinosa)	Pennsylvania, Wisconsin	10	19	26	68	0.54	0.66	68	16.8	7.4	9.0	4,600	8,600	1,940	0.80	16.6	11,700	4.5	40	2,760	3,460	450	1,110	490	820	740
Basswood (Fraxinus americana)	Tennessee	5	15	..	141	0.38	0.38	49	12.0	3.5	7.8	2,600	4,800	980	0.41	5.4	6,500	2.1	18	1,640	2,050	210	660	820	360	290
Buckhorn, eastern (Rhus copallina)	Oregon	5	17	..	61	0.60	0.55	50	7.6	3.2	4.6	3,400	6,300	630	1.04	13.4	8,700	3.6	58	1,880	3,270	670	1,150	510	680	730
Bursera (Lupinus chinensis)	Tennessee, Wisconsin	10	9	..	104	0.36	0.40	46	10.2	3.3	6.1	2,900	5,400	970	0.52	8.2	7,300	2.5	24	1,960	2,420	270	760	430	410	390
Cherry, black (Prunus serotina)	Pennsylvania	5	11	..	55	0.47	0.53	46	11.5	3.7	7.1	4,200	8,000	1,310	0.80	12.8	10,200	4.1	33	2,940	3,540	440	1,130	570	750	660
Cherry, wild red (Prunus pennsylvanica)	Tennessee	5	6	..	46	0.36	0.42	33	12.8	2.8	10.3	2,900	5,000	1,040	0.47	6.2	6,600	2.1	22	1,830	2,170	260	680	300	440	390
Chesnut (Castanea dentata)	Maryland, Tennessee	10	10	48	122	0.40	0.46	55	11.6	3.4	6.7	3,100	5,600	930	0.59	7.0	7,900	2.8	24	2,040	2,470	380	800	430	530	420
Chinquapin, western (Castanopsis caryocarpa)	Oregon	5	15	..	134	0.42	0.48	61	13.2	4.6	7.4	4,200	7,000	1,020	1.09	9.5	8,800	3.4	31	1,920	3,020	490	0,10	480	730	600
Cottonwood (Populus deltoides)	Missouri	5	6	..	111	0.37	0.43	49	14.1	3.9	9.2	2,900	5,300	1,010	0.49	7.3	7,200	2.3	21	1,770	2,280	246	680	410	380	340
Cottonwood, black (Populus trichocarpa)	Washington	5	6	..	132	0.32	0.37	46	12.4	3.6	8.6	2,900	4,800	1,070	0.44	5.0	6,800	2.2	20	1,770	2,160	200	600	270	230	250
Cucumber tree (Magnolia acuminata)	Tennessee	5	14	..	80	0.44	0.52	50	13.6	5.2	8.8	4,200	7,400	1,560	0.66	10.0	9,300	2.9	30	2,760	3,140	410	990	440	600	520
Dogwood (flowering) (Cornus florida)	Tennessee	5	24	..	62	0.64	0.80	65	19.9	7.1	11.3	4,800	8,800	1,180	1.11	21.0	7,100	3.5	58	3,640	1,080	1,520	1,410	1,410
Dogwood, western (Cornus nuttallii)	Oregon	5	21	..	52	0.58	0.70	55	17.2	6.4	9.6	4,200	8,200	1,090	0.92	17.0	9,800	3.6	56	2,280	3,640	870	1,300	740	1,140	980
Elder, pale (Sambucus racemosa)	Oregon	5	6	..	124	0.46	0.57	65	15.6	4.4	9.0	3,400	6,600	900	0.72	8.8	8,000	2.9	38	2,450	3,040	520	1,090	560	760	720
Elm, cork (Ulmus rostratus)	Wisconsin	10	28	50	50	0.58	0.66	54	14.1	4.8	8.1	4,600	9,500	1,190	1.20	19.8	11,000	4.1	50	2,870	3,760	750	1,270	660	980	990
Elm, slippery (Ulmus glaberrimus)	Indiana, Wisconsin	6	16	54	85	0.48	0.56	56	13.8	4.9	8.9	4,000	8,000	1,230	0.82	15.4	9,200	3.4	47	2,840	3,320	510	1,110	650	750	660
Elm, white (Ulmus americana)	Wisconsin, Pennsylvania	6	18	31	88	0.44	0.54	52	14.4	4.2	9.5	3,600	6,900	1,030	0.83	11.0	8,100	2.9	34	2,290	2,880	300	920	560	610	550
Gum, black (Nyssa sylvatica)	Tennessee	5	27	..	55	0.46	0.56	45	13.9	4.4	7.7	4,000	7,000	1,030	0.91	8.0	9,800	4.0	30	2,440	3,040	600	1,100	570	780	640
Gum, blue (Fraxinus globosa)	California	5	79	0.62	0.80	70	22.5	7.6	15.3	7,600	11,200	2,010	1.65	13.9	14,200	4.7	40	4,870	5,280	1,020	1,550	940	1,810	1,240
Gum, cotton (Nyssa aquatica)	Louisiana	6	10	26	97	0.46	0.52	56	12.5	4.2	7.6	4,200	7,300	1,050	0.98	8.3	9,000	3.3	30	2,760	3,370	560	1,190	600	800	710
Gum, red (Liquidambar styraciflua)	Missouri	10	16	..	81	0.44	0.53	50	15.0	5.2	9.9	3,700	6,800	1,150	0.81	9.4	10,000	3.9	33	2,360	2,840	460	1,070	510	630	520
Hackberry (Celtis occidentalis)	Indiana, Wisconsin	6	12	56	65	0.48	0.56	50	13.8	4.3	8.9	2,900	6,500	950	0.68	14.5	7,900	3.1	48	2,000	2,650	490	1,070	630	760	690
Haw, pear (Dyuglas acuminata)	Wisconsin	2	11	..	63	0.62	63	3,900	7,600	960	0.89	22.7	3,110	960	1,360	1,280	1,200
Hickory, big shellback (Hicoria lactescens)	Mississippi, Ohio	19	19	65	61	0.62	63	19.2	7.9	12.6	5,600	10,500	1,340	1.36	29.9	14,200	7.0	104	2,740	43,920	1,000	1,190

TABLE 2.—RESULTS OF TESTS ON 126 SPECIES OF WOOD TESTED IN A GREEN CONDITION IN THE FORM OF SMALL CLEAR PIECES (Continued)

Common and botanical names	Locality where grown	Number of trees	Number of rings per inch	Summerwood (per cent)	Moisture content (per cent)	Specific gravity, oven-dry, based on		Weight per cubic foot (green) (lb.)	Shrinkage from green to oven-dry condition			Fiber stress at elastic limit (lb. per sq. in.)	Modulus of rupture (lb. per sq. in.)	Modulus of elasticity (1,000 lb. per sq. in.)	Static bending		Impact bending		Compression parallel to grain		Shearing strength parallel to grain (lb. per sq. in.)	Tension perpendicular to grain (lb. per sq. in.)	End (lb.)	Side (lb.)
						Volume when green	Volume when oven-dry		In volume (per cent of dimensions when green)	Radial (per cent of dimensions when green)	Tangential (per cent of dimensions when green)				To elastic limit (in.-lb. per cu. in.)	To maximum load (in.-lb. per cu. in.)	Work in bending to elastic limit (lb. per sq. in.)	Work in bending to elastic limit (in.-lb. per cu. in.)	Height of drop causing complete failure, 50-lb. hammer (in.)	Fiber stress at elastic limit (lb. per sq. in.)				
Hamwood—contd.																								
Hickory, bitternut (Hicoria missill)	Ohio	11	11	70	66.0.60	63	5,500	10,300	1,400	1.22	20.0	15,900	8.5	66	4,330	4,570	990	1,240						
Hickory, mockernut (Hicoria alba)	West Virginia, Mississippi, Pennsylvania	20	18	63	59.0.64	64	6,300	11,100	1,570	1.38	26.1	15,100	6.7	88	3,900	4,490	1,000	1,290						
Hickory, white (Hicoria missill)	Mississippi	5	22	59	74.0.56	61	4,900	9,100	1,290	1.06	22.6	12,800	6.1	54	3,620	3,980	940	1,080						
Hickory, yellow (Hicoria missill)	Missouri	5	12	63	63.0.60	61	5,200	9,800	1,370	1.18	14.6	12,300	5.0	53	3,040	3,990	960	1,496						
Hickory, post (Hicoria missill)	Ohio, Mississippi, Pennsylvania	60	20	65	54.0.66	64	6,200	11,700	1,650	1.34	31.7	16,900	8.8	89	3,950	4,810	1,140	1,370						
Hickory, shagbark (Hicoria missill)	Ohio, Mississippi, Pennsylvania, West Virginia	24	19	66	60.0.64	64	5,900	11,000	1,570	1.28	23.7	14,400	6.4	74	3,430	4,580	1,000	1,320						
Hickory, water (Hicoria missill)	West Virginia, Mississippi	2	15	67	80.0.61	69	6,000	10,700	1,560	1.29	18.8	13,700	6.1	56	3,240	4,660	1,090	1,440						

1,270 1,310

TABLE 2.—RESULTS OF TESTS ON 126 SPECIES OF WOOD TESTED IN A GREEN CONDITION IN THE FORM OF SMALL CLEAR PIECES (Continued)

Common and botanical name	Locality where grown	Number of trees	Number of rings per inch	Summerwood (per cent)	Moisture content (per cent)	Specific gravity, oven-dry, based on		Weight per cubic foot (green) (lb.)	Shrinkage from green to oven-dry condition			Static bending			Impact bending			Compression parallel to grain		Shearing strength parallel to grain (lb. per sq. in.)	Tension perpendicular to grain (lb. per sq. in.)	End (lb.)	Hardness load required to indur to 0.444-in. ball to one-half the diameter				
						Volume when green	Volume when oven-dry		In volume (per cent of dimensions when green)	Radial (per cent of dimensions when green)	Tangential (per cent of dimensions when green)	Fiber stress at elastic limit (lb. per sq. in.)	Modulus of rupture (lb. per sq. in.)	Modulus of elasticity (1,000 lb. per sq. in.)	To elastic limit (in.-lb. per cu. in.)	To maximum load (in.-lb. per cu. in.)	Work in bending to elastic limit (lb. per sq. in.)	Work in bending to elastic limit (in.-lb. per cu. in.)	Height of drop causing complete failure, 50-lb. hammer (in.)					Fiber stress at elastic limit (lb. per sq. in.)	Maximum crushing strength (lb. per sq. in.)	Compression perpendicular to grain—fiber stress at elastic limit (lb. per sq. in.)	
HARDWOODS—contd.																											
Oak, willow (<i>Quercus pubula</i>)	Louisiana	2	14	56	94.0	56.0	0.49	67	18.9	5.0	9.6	4,400	7,400	1,200	0.88	8.8	9,200	2.9	35	2,480	3,000	750	1,180	760	1,020	980	
Oak, yellow (<i>Quercus velutina</i>)	Arkansas, Wisconsin	8	15	71	78.0	56.0	0.47	63	14.2	4.5	9.7	4,600	8,200	1,180	1.20	12.3	10,800	4.4	40	2,870	3,460	870	1,180	830	1,000	1,060	
Persimmon (<i>Diospyros virginiana</i>)	Missouri	5	14	..	58.0	64.0	0.78	63	18.3	7.5	10.8	5,600	10,000	1,370	1.35	13.0	12,100	4.5	41	3,080	4,170	1,110	1,470	770	1,240	1,260	
Poplar, yellow (<i>Liriodendron tulipifera</i>)	Tennessee	5	14	..	64.0	37.0	0.42	38	11.4	4.1	6.9	3,200	5,600	1,210	0.48	5.6	8,000	2.6	17	2,000	2,550	310	790	460	420	340	
Rhododendron, great (<i>Rhododendron macrocarpum</i>)	Tennessee	5	28	..	99.0	50.0	0.60	62	16.2	6.3	8.7	4,600	6,900	870	1.38	13.1	26	3,470	800	1,240	1,000	860
Sassafras (<i>Sassafras albidum</i>)	Tennessee	5	19	48	87.0	42.0	0.47	44	10.3	4.0	6.2	3,600	6,000	910	0.80	7.1	8,500	3.5	37	2,410	2,730	460	980	520	610	520	
Sourcherry (<i>Amelanchier canadensis</i>)	Tennessee	5	19	..	48.0	66.0	0.79	61	18.7	6.7	10.8	5,600	9,600	1,640	1.08	16.2	12,200	4.1	63	3,200	4,080	780	1,280	730	1,250	1,240	
Silverbell-tree (<i>Hibiscus densiflorus carolinianus</i>)	Tennessee	5	20	..	70.0	42.0	0.48	44	12.6	3.8	7.6	3,500	6,506	1,160	0.62	8.8	9,100	3.3	27	2,110	2,530	430	930	460	550	470	

5	24	..	69.0	50.0	59	53	15.2	6.3	8.9	4.4	7.700	1.320	0.82	9.9	10.800	4.1	38.2	2,720	3,250	680	1,100	710	960	730
5	9	61	45	0.45	..	41	3,000	810	0.67	10.9	2,680	480	590	
5	17	38	82	0.47	0.54	48	12.7	5.0	7.3	3.20	6,600	810	0.78	12.0	8.200	3.2	33	1,950	2,800	580	1,060	660	940	740
10	16	77	83	0.40	0.54	52	14.2	5.1	7.6	3,300	6,500	1,060	0.60	7.5	8.800	3.3	26	2,390	2,920	450	1,000	630	700	610
5	15	..	89	0.40	0.48	47	13.0	4.4	7.5	3,400	6,100	1,190	0.58	8.3	8,000	2.9	23	2,250	2,610	330	880	450	570	500
5	12	..	81	0.51	0.56	58	11.3	5.2	7.1	5,400	9,500	1,420	1.16	14.6	11.900	4.5	37	3,000	4,300	600	1,220	570	960	900
10	5	..	138	0.34	0.41	50	13.8	2.6	7.8	1,800	3,800	560	0.36	10.8	5.100	2.0	36	970	1,510	210	620	430	350	360
5	5	..	105	0.39	0.47	50	13.8	2.9	9.0	3,100	5,600	1,020	0.58	10.8	7,900	2.5	33	1,810	2,340	330	870	360	490	500
5	14	..	70	0.56	0.71	59	18.8	5,000	8,300	1,110	1.29	19.5	12.400	6.8	40	..	3,400	620	1,120	..	1,010	980
Conifers																								
8	16	30	108	0.35	0.36	45	7.6	3.3	5.7	3,900	6,200	840	0.94	6.4	7,300	2.4	17	2,870	3,150	460	830	280	570	390
5	24	25	62	0.41	0.47	39	10.7	5.2	8.1	3,900	6,800	1,500	0.59	7.8	9,300	2.7	25	2,970	3,280	380	880	240	560	480
10	20	36	39	0.31	0.34	27	8.1	2.5	5.1	3,300	5,200	950	0.64	5.0	7,10	2.4	17	2,500	2,940	310	720	210	430	260
5	23	36	55	0.29	0.32	28	7.0	2.1	4.9	2,600	4,200	640	0.60	5.7	5,300	2.0	15	1,420	1,990	290	620	240	320	280
10	16	31	87	0.41	0.47	48	10.7	3.8	6.0	4,000	6,900	1,190	0.86	6.4	8,000	2.6	24	3,100	3,490	470	820	260	470	380
5	31	..	40	0.40	0.44	35	7.9	1.9	5.0	3,600	6,200	960	0.77	9.5	8,000	3.2	27	2,960	3,890	410	820	260	520	410
18	13	35	36	0.45	0.52	38	12.6	5.0	7.9	6,000	7,800	1,580	0.86	6.7	9,400	2.9	25	3,400	3,940	530	910	200	510	470
10	22	27	38	0.40	0.44	34	10.6	3.6	6.2	3,600	6,400	1,180	0.65	6.8	9,100	3.0	20	2,520	3,000	450	880	350	450	400
5	15	14	47	0.31	0.32	28	9.0	2.5	7.1	2,400	4,400	860	0.39	4.4	5,300	1.6	9	1,660	2,060	310	610	..	280	220
20	8	26	102	0.37	0.42	47	14.1	4.5	10.0	3,900	6,300	1,300	0.60	6.0	7,800	2.2	21	2,380	2,930	320	670	240	360	310
5	12	26	117	0.34	0.41	45	10.8	2.8	6.6	3,000	4,900	960	0.52	4.7	6,900	2.3	16	2,220	2,400	210	610	180	290	280
10	18	30	94	0.37	0.42	44	10.6	3.2	7.2	3,600	6,100	1,300	0.58	5.6	8,100	2.6	22	2,680	3,010	340	760	230	420	360
5	22	17	41	0.35	0.41	31	13.6	4.9	9.1	3,400	5,700	1,280	0.53	6.2	7,900	2.6	20	2,370	2,700	310	700	180	300	250
5	10	30	156	0.35	0.44	56	10.2	3.4	7.0	3,900	6,000	1,130	0.77	5.2	7,200	2.2	18	2,610	2,900	440	730	260	380	330
5	23	45	70	0.42	0.48	45	10.8	4.4	7.1	3,500	6,000	940	0.78	9.4	8,900	3.6	36	2,590	2,990	400	880	360	580	460

Elastic Limit.—The elastic limit is that point where the distortion ceases to be in proportion to the load. A timber stressed beyond the elastic limit will not resume its original form immediately upon the removal of the load.

Elasticity.—Elasticity is the property of changing form with the application of force and recovery at once upon release from the force.

Fiber Stress at Elastic Limit.—Fiber stress at elastic limit is the stress obtained in the timber by loading it to its elastic limit. It is the greatest stress that timber will take under a given loading and immediately return to its former position.

Green.—Green is the condition of timber as taken from the living tree.

Modulus of Elasticity.—Modulus of elasticity is a measure of the stiffness and rigidity of a material. In the case of a beam modulus of elasticity is a measure of its resistance to deflection. Modulus of elasticity is of value in computing the deflection of joists, beams, stringers, etc., and in computing safe loads for columns.

Modulus of Rupture.—Modulus of rupture is the computed fiber stress in the outermost fibers of a beam at the maximum load and is a measure of the ability of a beam to support a slowly applied load for a very short time. Modulus of rupture should always be considered in the strength of beams to be used as stringers, floor joists, etc.

Shear.—Shear is the name of the stress which tends to keep two adjoining planes or surfaces of a body from sliding, one on the other, under the influence of two equal and parallel forces acting in opposite directions.

36. Strength of Treated Wood.¹—The results of timber tests made by the Forest Service and others on the effect of preservative treatments of timber warrant the following conclusions:

(1) Timber may be very materially weakened by preservative processes. (Attention is called to the fact that this weakening will occur only where timber is subjected to excessive temperatures during treatment.)

(2) Creosote in itself does not appear to weaken timber.

(3) A preservative process which will seriously injure one timber may have little or no effect on the strength of another.

(4) A comparison of the effect of a preservative process on the strength of different species should not be made, unless it is the common or best adapted process for all the species compared.

(5) The same treatment given to a timber of a particular species may have a different effect upon different pieces of that species, depending upon the form of the timber used, its size, and its condition when treated.

Referring specifically to zinc chloride, the conclusions of a committee of the American Wood-Preservers' Association indicate that:

(1) The treatment of wood with the usual strength of zinc chloride solution seems to have but little permanent effect upon the strength of wood in bending even five years after treatment, provided the temperature of the wood during that time is not excessively high.

(2) There seems to be a slight permanent decrease in the resistance of zinc-treated wood to shock even at the normal temperatures. This decrease seems to be greater with greater absorptions of zinc chloride.

(3) At temperatures somewhat higher than the normal there may be a considerable reduction in all strength values.

37. Length of Life of Wood.—Wood varies as to its length of life, depending upon the species and the conditions under which it is used. Absolute figures have little value. Woods may generally be classified as follows:

¹ See strength of wood as affected by zinc chloride, pp. 80-114, *Proceedings American Wood-Preservers' Association, 1921*, and Forest Service Publications.

Long Lived.—Cypress, redwood, red cedar, white cedar, Osage orange, catalpa and white pine.

Medium Lived.—White oak, slippery elm, black walnut, hickory, longleaf pine, tamarack and Douglas fir.

Short Lived.—Red oak, red gum, beech, elm, spruce, shortleaf and loblolly pine, and hemlock.

38. Decay of Wood.—Decay or rot of wood is due to fungi whose active growth in the fiber destroys it. Necessary conditions for decay are oxygen, water, heat and a certain amount of food. Fruiting bodies of the fungus appear on the outside of decayed wood, some of which are called punks, toadstools, conchs, etc. Wood will not decay when kept absolutely dry, completely submerged in water or in the ground at a point below the oxygen line, usually 4 to 10 ft. Posts, poles and foundation timbers decay most rapidly at or near the ground line due to favorable conditions of air and water. In buildings decay takes place where timbers come in contact with walls or with other timbers. Various forms of decay are recognized, such as dry-rot, wet-rot, etc. These terms have little practical significance. Sapwood of all timbers decays rapidly. The heartwood of most timbers is very much more resistant to decay than sapwood. Internal sap-rot is a term applied to decay of the inner sapwood which cannot be readily recognized from the outside. If timbers have been cut for some months sap-rot should always be suspected.

Winter cut wood, meaning wood cut between September and March, will dry and be free from decay very much more than timber cut during the spring and summer months. Blue stain is a defect causing grayish blue discoloration of the sapwood of pines and other coniferous woods. It is due to a minute fungus growing in the wood fiber. Blue stain wood does not suffer as to strength. The stain may be prevented by dipping freshly sawed lumber into 5 per cent solution of sodium bicarbonate at 140 deg. Fahr.

39. Destruction of Wood by Insects.—Various boring insects destroy wood. Chief among these are the white ants, or termites. (See Snyder's "Biology of the Termites of the Eastern United States, with Preventive and Remedial Measures," United States Department of Agriculture, Bureau of Entomology, Bulletin 94, 1915.) These insects live under ground and get into structures from the ground. They very rapidly destroy wood. Thorough creosoting is an absolute preventive. Other forms of boring insects occur now and then, notably the carpenter ant, and the powderpost beetle.

40. Destruction of Wood by Marine Animals.—All forms of wood immersed in salt or brackish water are destroyed by a number of marine wood borers, such as the species of teredo (shipworm) and bankia, limnoria (wood louse), martesia, sphaeroma and others. Marine borers are most active in warmer waters but they are found from Nova Scotia on the East Coast and up the Pacific Coast as far as Alaska. They usually live in waters having salinities above 1.0054, but some forms can live in almost fresh water. (Note attack of Teredo navalis, the Holland shipworm, in San Francisco Bay, *Proceedings American Wood-Preservers' Association*, 1921.) Active investigations were conducted and reported upon in 1924 by the National Research Council¹ toward determining distribution of

¹ See Report on "Marine Structures, Their Deterioration and Preservation," 1924, by W. G. Atwood and A. A. Johnson.

shipworms and methods for preventing attack. Creosoting with coal-tar creosote is the most effective method for prevention.

41. Seasoning of Timber.—As dry wood has a longer life than green wood, seasoning is usually resorted to. This may be either air seasoning or seasoning by means of dry-kilns. To prevent checking wedge-shaped S-irons are frequently used, or the ends of logs or timbers are coated with various kinds of paint. Timber is kiln-dried in various forms by dry-kilns. (For detailed description of kiln-drying see Tiemann's "The Kiln-Drying of Lumber," 1917.)

42. Preservation of Timber.—The processes for preserving wood are based on the injection of various antiseptic chemical compounds. The principal compounds used, named in the order of their efficiency, are: coal tar creosote, known also as creosote oil or dead oil of coal tar, creosote coal tar solution, mercuric chloride, sodium fluoride as an important ingredient in several proprietary or patented preservatives, and zinc chloride. Coal tar creosote is manufactured by a distillation of coal tar, either retort gas coal tar or by-product coke-oven coal tar. When coal tar is distilled, it is separated into the light oils, creosote oil and pitch. There is no true "creosote" in coal tar creosote. The chemical compound creosote is obtained from a distillation of hardwood tars. Coal tar creosote is a very variable substance depending upon the kind of coal from which the tar is made and the manner in which the latter is distilled. It weighs approximately 8.7 to 9 lb. per gal. and ranges in specific gravity at 100 deg. Fahr. from 1.03 to 1.12. At the present time refined coal tar is frequently added to coal tar creosote, 20 per cent coal tar and 80 per cent creosote, making a coal tar creosote solution. On account of variable coal and manufacturing processes, coal tar creosote oils are described by specifying the specific gravity, the per cent of the fractions obtained in making a distillation and testing the character of the residue. Slight variations from standard specifications are permissible provided definite assurance is obtained that the oil to be used is a strict coal tar product without adulteration.

Specifications for coal tar creosote oil have been adopted by the American Railway Engineering Association, American Society for Testing Materials, American Wood-Preservers' Association, U.S. Federal Specifications Board and others. The specification for A.W.P.A. No. 1 creosote oil for ties and structural timbers follows:

The oil shall be a distillate of coal-gas or coke-oven tar. It shall comply with the following requirements:

- (1) It shall contain not more than 3 per cent of water.
- (2) It shall contain not more than 0.5 per cent of matter insoluble in benzol.
- (3) The specific gravity of the oil at 38 deg./15.5 deg. Cent. shall be not less than 1.03.
- (4) The distillate, based on water-free oil, shall be within the following limits:
Up to 210 deg. Cent. not more than 5 per cent.
Up to 235 deg. Cent. not more than 25 per cent.
- (5) The specific gravity of the fraction between 235 and 315 deg. Cent. shall not be less than 1.03 at 38 deg./15.5 deg. Cent.
The specific gravity of the fraction between 315 and 355 deg. Cent. shall not be less than 1.10 at 38/15.5 deg. Cent.
- (6) The residue above 355 deg. Cent., if it exceeds 5 per cent, shall have a float test of not more than 50 seconds at 70 deg. Cent.
- (7) The oil shall yield not more than 2 per cent of coke residue.

The foregoing tests shall be made in accordance with the standard methods of the American Wood-Preservers' Association.

Creosote is bought by the gallon and injected usually by the pound. Its composition is determined by fractional distillation. (See *Proceedings A.R.E.A.* Vol. 20, pp. 126-132, 1919; also A.S.T.M. Standards 1939, *Standard D-38-33*, pp. 571-573.)

Wood-tar creosote is sometimes used but has very low antiseptic values. Water-gas-tar creosote is obtained from the distillation of water-gas tar but is generally regarded as inferior to coal-tar creosote.

Mercuric chloride is used in the form of corrosive sublimate, one part of sublimate to 150 parts of water.

Zinc chloride is used either in the form of fused zinc chloride, 94 per cent minimum strength, or in the form of 50 per cent concentrated solution. It is diluted to strengths varying from 3 to 5 per cent. depending upon the kind of timber to be treated.

Various salts of fluorine are being experimented with at the present time. None of them have yet proven commercially successful.

To obtain the best results creosote oil or water solutions of antiseptic salts should be injected so as to give the maximum possible penetration. *The sapwood should at all times be thoroughly penetrated with the preservative.* The heartwood of all trees is only slightly penetrable. It is particularly resistant in those woods which have marked distinction between heartwood and sapwood. Air seasoned timber only should be treated. All framing, adzing and boring should be carried out before the timber is treated, and after treatment all injuries to the treated wood should be avoided. Timber treated with water solutions should be air seasoned for three to six months before being used. Creosoted timbers should be air seasoned for a short time, sufficient to dry the outer surfaces. As timber is a variable material individual pieces will absorb different quantities. Where cross ties are treated with an average of 23 lb., some pieces absorb only 2 lb. and others as high as 90 lb.

42a. Brush Treatment.—This is a term applied to painting creosote or other preservatives on to the surface of timber with a brush. It is of value only as a temporary expedient and then only when the preservative is applied preferably hot, to the ends of timber or to surfaces in contact with other timbers, stone walls, earth, etc. As thorough protection can only be secured by complete impregnation brush treatment should be used sparingly, particularly when exposed to weather and water.

42b. Zinc-chloride Treatment or Burnettizing Process.—In this process a solution of zinc chloride at 140 deg. Fahr. is injected into timber under pressure, with preliminary steaming in the case of green timber. According to standard practice $\frac{1}{2}$ lb. of dry zinc chloride is injected per cubic foot of timber. For pine and other coniferous woods, the strength of the solution will vary from $2\frac{1}{2}$ to 4 per cent; for hardwood, such as red oak, it will usually be about 4 per cent; under no circumstances should it exceed 5 per cent. The strength of the solution should be controlled either by hydrometer readings, or preferably, by chemical titration. Zinc chloride may be purchased either in crystalline form or in the form of a 50 per cent solution. Care should be observed that the material does not contain excess free hydrochloric acid or basic chloride of zinc;

the former reducing the strength of the timber and the latter reducing the anti-septic properties. The material is soluble in water and consequently tends to be washed and leached out of timber in damp locations or where subjected to rain. Combinations of zinc chloride with creosote have been used to offset this characteristic, using the Card process.

42c. Kyanizing or Mercuric-chloride Treatment.—In this process the timber is soaked in a vat built entirely of wood and filled with a solution of corrosive sublimate, one part of sublimate to 150 parts of water. The strength of the solution decreases as it is used, and must therefore be renewed by adding more sublimate from time to time. The vat should be kept covered. The wood is left in the vat for from 5 to 10 days, according to the size of the timber, until a thorough absorption of the liquid has taken place. Corrosive sublimate is an excellent preservative particularly for fence posts, sticks, and for use where creosote, because of its odor and physical nature, cannot be used. Care should be exercised to prevent unnecessary handling of this very poisonous salt. (In case of poisoning, drink large quantities of milk or water in which well-beaten fresh eggs have been stirred.)

The Factory Mutual Insurance Companies of Boston recommend (1915) that longleaf pine used in mill construction be soaked for a week in a 1 per cent solution of corrosive sublimate, and state that the cost of treatment at the mills is about \$3 per thousand. They require that those portions of the wood which are exposed after treatment by cutting should be thoroughly swabbed with the solution.

42d. Creosoting Processes.—Creosoting, with its several modifications, is the best preservative for practically all purposes. There are several processes in use, distinguished as the Bethell or plain creosoting process, the Lowry process, the Rüping process, and the boiling process.

Bethell or Plain Creosoting Process.—In the Bethell process a preliminary vacuum is maintained, after which creosote is injected under pressure varying from 100 to 200 lb. per sq. in., which is continued until the desired absorption has been obtained. The amount of creosote injected will vary from 10 to 16 lb. per cu. ft. The plain Bethell or full-cell creosoting process is used largely for the treatment of piling, bridge materials, paving blocks, telegraph poles, etc. It is applied chiefly to timber of which long service is expected, and where mechanical or destructive processes, aside from decay, are of minor importance. In general, bridge materials, piling, poles, and similar timbers are treated with 10 to 15 lb. of creosote per cu. ft. for regions north of the Ohio River and with 15 to 20 lb. for regions south of the Ohio River. Exceptions to this rule are made for piling, for which the following standards may be used: for marine exposure on the Atlantic Coast north of Delaware Bay, 12 to 15 lb. per cu. ft.; on the Atlantic Coast south of Delaware Bay and on the Gulf and Pacific Coast, 20 to 25 lb. per cu. ft. (See *Proceedings*, American Railway Engineering Association, vol. 9, p. 352, 1908.)

Lowry Process.—This process aims to secure a good penetration with comparatively small quantities of creosote. Air-dry timber only is treated. Creosote oil is forced into the timber without a preliminary vacuum until a large quantity of creosote is absorbed, usually stated as "treatment to a refusal." A quick final vacuum is then applied and a considerable amount of the oil first

injected is withdrawn. According to standard practice in railway tie treatment, about $2\frac{1}{2}$ gal. of creosote remain in a 6-in. \times 8-in. \times 8-ft. tie.

Rüping Process.—This process likewise is intended to secure a good penetration with comparatively small quantities of oil. Compressed air is first forced into the wood up to a pressure of 60 to 90 lb. per sq. in., after which creosote oil is forced in at a higher pressure until treatment to refusal is obtained. A final vacuum aids the compressed air in driving out a considerable quantity of the oil originally injected. According to standard practice, from 1.8 to 2 gal. are left in a 6-in. \times 6-in. \times 8-ft. railway tie at the end of the treatment.

Boiling Process.—This process is used chiefly for the treatment of Douglas fir on the Pacific Coast. The green timber is placed in the creosoting cylinder, which is then filled with creosote and heated to a point slightly above the boiling point of water. This heating is maintained until practically no water comes out of the condenser. Pressure is then applied and the preservative is forced into the timber to the requisite amount.

42e. Card Process.—The preserving liquid used in this process is made up of 15 to 20 per cent of creosote and the remainder of a 3 to 5 per cent solution of zinc chloride. The creosote and zinc chloride are mixed in a centrifugal pump and the emulsion thus produced is forced into the timber under pressure.

42f. Open-tank Treatment.—Under this name a number of methods have been devised for treating timber, without pressure, with either zinc chloride or creosote. The timber to be treated is put into an open tank or vat and heated in a hot liquid for several hours. It is then quickly immersed in a cold liquid, either zinc chloride or creosote. During the heating process a partial vacuum is produced in the interstices of the wood, and when the hot wood is put in the cold bath, the atmospheric pressure is sufficient to bring about considerable absorption. This process is adapted particularly to the treatment of small quantities of timber in localities where larger treating plants are not available. (For details, see *Forest Service Circulars* Nos. 101, 104, 111 and 117.)

43. Dating Nails.—In many forms of construction dating nails are now applied to ties, bridge and building materials, for the purpose of keeping records of period of service obtained.

44. Protection of Timber against Fire.—Fire resistive processes in large numbers have been patented and described, most of which, however, have only slight or absolutely no value. Two methods are used, one of which is the painting of surfaces with a protective material so as to reduce ignition from sparks. Examples of materials for use for this purpose are sodium silicate, Pamak paint (lead, zinc, linseed oil, asbestine paint), various forms of high-boiling asphalt paints, etc. The second and far more effective method is to impregnate the wood with a chemical which will liberate non-combustible gases when heated. Various ammonia salts have proven most efficient, principally ammonium chloride, ammonium phosphate and ammonium sulphate. This process has been used somewhat, but owing to its high cost has made very little headway. Timbers treated with zinc chloride show slightly lower fire hazard than untreated timber. Thoroughly air-dried, creosoted timber may be considered as good a fire hazard as untreated wood and will show less tendency to ignition.¹ Freshly creosoted

¹ See *National Fire Protection Association Quarterly*, April, 1918.

timber, however, will ignite far more rapidly than untreated timber. The coating of one or the other of the asphaltic paints will give additional protection to creosoted timber.

45. Timber Specifications.—Structural timbers are made largely of species of dense long leaf or shortleaf Southern pine, Douglas fir, and Western hemlock. In order to avoid complications because of impossible botanical distinction, specifications have been adopted for grading structural timbers on the basis of density, as follows:

STANDARD SPECIFICATIONS

For

STRUCTURAL WOOD JOIST AND PLANK, BEAMS AND STRINGERS, AND POSTS AND TIMBERS¹

(See A.S.T.M. Designation D245-37)

GENERAL REQUIREMENTS

(Applying to All Stress-grades and Items²)

1. **Manufacture.**—All material shall be well manufactured.
2. **Quality of Wood.**—No piece of exceptionally light weight shall be permitted.
3. **Decay.**—Only pieces consisting of sound wood free from any form of decay shall be acceptable, unless otherwise specified.
4. **Slope of Grain.**—Slope of grain shall be measured over a distance sufficiently great to determine the general slope disregarding slight local deviations. Within the middle half of length of piece, slope of grain shall not be steeper than specified.
5. **Holes.**—Knot holes and holes from causes other than knots shall be measured and limited as provided for knots.
6. **Cluster Knots.**—Cluster knots and knots in groups shall not be permitted.
7. **Knots in Joist and Plank.**
 - a. **Knots on Narrow Faces.**—Size of knot on a narrow face shall be taken as the width between lines enclosing the knot and parallel to the edges of the piece. The only knots measured on narrow faces, except spike knots which cross the corners of side-cut pieces, shall be those that do not show on wide faces.
 - b. **Knots on Wide Faces.**—Size of knot on a wide face shall be the average of its largest and smallest diameters. A spike knot which crosses a corner of a side-cut piece and contains the intersection of the adjacent faces, or which extends entirely across a face of a piece, shall be measured only on its end or ends, between lines parallel to the edges of the piece.
 - c. **Permissible Increase in Knot Sizes.**—Size of knots on narrow faces and at edges of wide faces may increase proportionately from the size permitted in the middle third of the length to twice that size at ends of the piece. Size of knots on wide faces may increase proportionately from the size permitted at the edge to the size permitted along the center line.
 - d. **Sum of Knots.**—Sum of sizes of all knots within the middle half of the length of any face, measured as specified in paragraph *a* or *b* for the face under consideration, shall not exceed four and one-half times the size of the largest knot allowed on that face.
8. **Knots in Beams and Stringers.**
 - a. **Knots on Narrow Faces.**—Size of knot on a narrow face shall be taken as the width between the lines enclosing the knot and parallel to the edges of the piece except that when a knot on a narrow face extends into the adjacent one-fourth of the width of a wide face its least dimension shall be taken as its size.
 - b. **Knots on Wide Faces.**—Size of knot on a wide face shall be its smallest diameter. Knots at the edges of wide faces shall be limited to the same sizes as on narrow faces but are measured as specified in this paragraph.
 - c. **Permissible Increase in Knot Size.**—Size of knots on narrow faces and at the edges of wide faces may increase proportionately from the size permitted in the middle third of the length to twice that size at the ends of the piece, except that no knot shall exceed the size permitted along the center line of a wide face. Size of knots on wide faces may increase

¹ These specifications were prepared jointly by the American Railway Engineering Association and the American Society for Testing Materials.

proportionately from the size permitted at the edge to the size permitted along the center line.

d. Sum of Knots.—Sum of sizes of all knots within the middle half of the length of any face, measured as specified in paragraph *a* or *b* for the face under consideration, shall not exceed four times the size of the largest knot allowed on that face.

9. Knots in Posts and Timbers.—*a. Knots on Either Face.*—Size of a knot on either face shall be half the sum of its largest and smallest diameters. A spike knot which crosses a corner of a side-cut piece and contains the intersection of the adjacent faces, or which extends entirely across a face of a piece, shall be measured only on its end or ends, between lines parallel to the edges of the piece.

b. Sum of Knots.—Sum of sizes of all knots in any 6 in. of the length of piece, measured as specified in paragraph *a*, shall not be permitted to exceed twice the maximum permissible size of knot. Two knots of the maximum permissible size shall not be permitted in the same 6 in. of length on any face.

10. Shakes, Checks, Splits in Joist and Plank and Beams and Stringers.—*a. Shakes, checks, and splits, when permitted in the grade specified later in these specifications, shall be measured at the ends of the piece. Only those within the middle half of the height shall be considered. (The height equals the width of the wide face.) Size of shake is the distance between the lines enclosing the shake and parallel to the wide faces of the piece. Permissible size is determined by the width of the narrow face of the piece.*

b. Checks and splits shall be measured and limited in the same way as shakes. The following limitations apply to both ends but only within the middle half of the height of the piece and within three times the height from the end. (The height equals the width of the wide face.) Size of checks within this portion of the piece shall be taken as their estimated area, along the horizontal section showing maximum area, divided by three times the height of the piece. (Note) When checks on two parallel faces are opposite or approximately so, the sum of their sizes shall be taken. The sum of sizes of shakes, checks, and/or splits shall not exceed the permissible size of shake.

c. Checks extending entirely across the end within the middle half of the height shall not extend into the piece at the center of width of end a distance greater than the size of the allowable shake.

11. Shakes, Checks, Splits in Posts and Timbers.—*a. Shakes, checks, and splits, when permitted in the grade specified later in these specifications, shall be measured at the ends of the piece. Size of a shake is the distance between the lines enclosing the shake and parallel to a pair of opposite faces.*

b. Checks and splits shall be measured and limited in the same way as shakes. Size of checks within three times the width of the piece from either end shall be taken as their estimated area, along the longitudinal section showing maximum area, divided by three times the width of the piece. (Note) Sum of sizes of shakes, checks, and/or splits shall not exceed the permissible size of shake.

c. Checks extending entirely across the end shall not extend into the piece at the center of width of end, a distance greater than the size of allowable shake.

NOTE.—A practical method of inspection in the field to determine the size of checks and splits under the above specification is as follows:

The size of checks within the specified portion of the piece shall be taken as the sum of seven depth measurements, one on the end and three on each side, divided by three. Each measurement shall represent the greatest depth of *any* check within the center half of the height; the measurement on the end shall be taken at the center of the width, and the three measurements on each side shall be taken at distances of one, two, and three times the height of the piece from the end in joist, plank, beams and stringers, and the width of the piece from the end in posts and timbers. Each measurement shall be determined by the penetration into the piece of a probe $\frac{1}{6}$ in. in thickness and $\frac{1}{4}$ in. in width.

OPTIONAL AND ADDITIONAL REQUIREMENTS

Applying to Stress Grades When Heartwood or Wane, and When Density and Close Grain Are Required

12. Heartwood Requirements.—*a. When heartwood material is desired, it shall be specified in terms of the amount or percentage of heartwood on the girth, or on each face, side, or edge, measured at the point where the greatest amount of sapwood occurs.*

b. For all timber to be pressure treated there shall be no heartwood requirement and the amount of sapwood shall not be limited.

13. **Wane.**—When wane is not desired, the specifications should state "Square Edge."

14. **Density (When Required) of Dense Douglas Fir.**—*a.* Dense Douglas fir shall average on either one end or the other of each piece not less than six annual rings per inch, and, in addition, one-third or more summerwood (the darker, harder portion of the annual ring) measured over 3 in. on a line at right angles to the annual rings, located as described below. The contrast in color between summerwood and springwood shall be distinct.

b. Coarse-grained material excluded by this rule shall be accepted as dense if averaging one-half or more summerwood.

c. In boxed-heart pieces the line shall run from the pith to the corner farthest from the pith, except that when the line is not representative it shall be shifted sufficiently to present a fair average, but the distance from the pith to the beginning of the 3-in. portion of the line shall not be changed. When the least dimension is 6 in. or less, the 3-in. portion of the line shall begin at a distance of 1 in. from the pith. When the least dimension is more than 6 in., the 3-in. portion of the line shall begin at a distance from the pith equal to one-fourth the least dimension of the piece.

d. In side-cut pieces (pith not present) the center of the 3-in. portion of the line shall be at the center of the end of the piece; if a 3-in. portion of the line cannot be obtained, the measurement shall be made over as much of a 3-in. portion as is available.

e. In case of disagreement, two radial lines shall be chosen and the summerwood and number of rings shall be taken as the average on these lines.

15. **Density (When Required) of Dense Longleaf or Shortleaf Yellow Pine.**—*a.* Dense longleaf or shortleaf yellow pine shall average on either one end or the other of each piece not less than six annual rings per inch, and, in addition, one-third or more summerwood (the darker, harder portion of the annual ring), measured over the third, fourth, and fifth inches of a radial line from the pith. The contrast in color between summerwood and springwood shall be sharp and the summerwood shall be dark in color, except in pieces having considerably above the minimum requirement for summerwood.

b. Coarse-grained material excluded by this rule shall be accepted as dense if averaging one-half or more summerwood.

c. The radial line shall be representative of the average growth of the cross section. In case of disagreement, two radial lines shall be chosen, and the number of rings per inch and percentage of summerwood shall be taken as the average determined on these lines.

d. In boxed-heart pieces the measurement shall be made over the third, fourth, and fifth inches from the pith along the radial line.

e. In material containing the pith, but not a 5-in. radial line, which is less than 2 by 8 in. in section or less than 8 in. in width, that does not show over 16 sq. in. on the cross section, the inspection shall apply to the second inch from the pith. In larger material that does not show a 5-in. radial line, the inspection shall apply to the 3 in. farthest from the pith.

f. In cases where timbers do not contain the pith and it is impossible to locate it with any degree of accuracy, the same inspection shall be made over 3 in. on an approximate radial line beginning at the edge nearest the pith in timbers over 3 in. in thickness and on the second inch nearest the pith in timbers 3 in. or less in thickness.

16. **Close Grain (When Required) of Close-Grained Douglas Fir, or Redwood.**—*a.* Close-grained Douglas fir shall average on either one end or the other of each piece not less than 6 nor more than 20 annual rings per inch; close-grained redwood shall average on either one end or the other of each piece not less than 10 nor more than 35 annual rings per inch. The rings shall be measured over 3 in. on a line at right angles to the annual rings, located as described below.

b. In boxed-heart pieces the line shall run from the pith to the corner farthest from the pith except that when the line is not representative it shall be shifted sufficiently to present a fair average, but the distance from the pith to the beginning of the 3-in. portion of the line shall not be changed. When the least dimension is 6 in. or less, the 3-in. portion of the line shall begin at a distance of 1 in. from the pith. When the least dimension is more than 6 in., the 3-in. portion of the line shall begin at a distance from the pith equal to one-fourth the least dimension of the piece.

c. In side-cut pieces (pith not present) the center of the 3-in. portion of the line shall be at the center of the end of the piece. If a 3-in. portion of the line cannot be obtained, the measurement shall be made over as much of a 3-in. portion as is available.

d. In case of disagreement, two radial lines shall be chosen and the number of rings shall be taken as the average on these lines.

e. Pieces of Douglas fir averaging 5 rings, or more than 20, shall be accepted if they contain one-third or more summerwood.

STRESS-GRADES

I. Joist and Plank

f = Extreme fiber stress in bending in pounds per square inch for continuously dry locations
 1,800 LB. *f* STRUCTURAL JOIST AND PLANK

Dense Douglas Fir (Coast Region)

Dense Longleaf Southern Pine

Dense Douglas Fir (Inland)

Dense Shortleaf Southern Pine

Slope of Grain.—1 in 12.

Knots.—Maximum permissible size in inches:

Nominal width of face, in.	On narrow face, or at edge of wide face, middle third of length, in.	At center line of wide face, in.
2	$\left. \begin{array}{l} \frac{5}{8} \\ 1 \\ 1\frac{1}{4} \\ \frac{3}{4} \end{array} \right\} \begin{array}{l} \text{On} \\ \text{narrow} \\ \text{face} \end{array}$	$\left. \begin{array}{l} 1\frac{1}{4} \\ 1\frac{7}{8} \\ 2\frac{1}{2} \\ 3\frac{1}{4} \\ 3\frac{7}{8} \\ 4\frac{1}{8} \\ 4\frac{1}{2} \end{array} \right\}$
3		
4		
4		
6	$\left. \begin{array}{l} 1 \\ 1\frac{3}{8} \\ 1\frac{3}{4} \\ 2\frac{1}{8} \\ 2\frac{1}{4} \\ 2\frac{1}{2} \end{array} \right\} \begin{array}{l} \text{At} \\ \text{edge} \\ \text{of} \\ \text{wide} \\ \text{face} \end{array}$	$\left. \begin{array}{l} 1\frac{1}{4} \\ 1\frac{7}{8} \\ 2\frac{1}{2} \\ 3\frac{1}{4} \\ 3\frac{7}{8} \\ 4\frac{1}{8} \\ 4\frac{1}{2} \end{array} \right\}$
8		
10		
12		
14		
16		

	Width of narrow face	
	When green	When seasoned
Shakes, checks, splits:		
120 lb. shear grade (fir).....	$\frac{1}{8}$	$\frac{1}{4}$
120 lb. shear grade (pine).....	$\frac{3}{10}$	$\frac{3}{8}$
Wane.....	$\frac{1}{8}$ width of any face	

1,600 LB. *f* STRUCTURAL JOIST AND PLANK
Close-grained Douglas Fir (Coast Region)

Slope of Grain.—1 in 12.

Knots.—Maximum permissible size in inches:

Nominal width of face, in.	On narrow face, or at edge of wide face, middle third of length, in.	At center line of wide face, in.
2	$\frac{5}{8}$ } On 1 } narrow 1 $\frac{1}{4}$ } face	
3		
4	$\frac{3}{4}$ } 1 } At 1 $\frac{3}{8}$ } edge 1 $\frac{3}{4}$ } of 2 $\frac{1}{8}$ } wide 2 $\frac{1}{4}$ } face 2 $\frac{1}{2}$ } face	1 $\frac{1}{4}$
4		1 $\frac{7}{8}$
6		2 $\frac{1}{2}$
8		3 $\frac{1}{4}$
10		3 $\frac{7}{8}$
12		4 $\frac{1}{8}$
14		4 $\frac{1}{2}$
16		4 $\frac{1}{2}$

	Width of narrow face	
	When green	When seasoned
Shakes, checks, splits: 100 lb. shear grade Wane...	$\frac{1}{6}$	$\frac{1}{4}$
	$\frac{1}{6}$ width of any face	

Dense Longleaf Southern Pine
Dense Shortleaf Southern Pine

Slope of Grain.—1 in 12.

Knots.—Maximum permissible size in inches:

Nominal width of face, in.	On narrow face, or at edge of wide face, middle third of length, in.	At center line of wide face, in.
2	$\frac{3}{4}$ } On 1 $\frac{1}{8}$ } narrow 1 $\frac{1}{2}$ } face	
3		
4	$\frac{7}{8}$ } 1 $\frac{1}{4}$ } At 1 $\frac{1}{8}$ } edge 2 $\frac{1}{8}$ } of 2 $\frac{1}{2}$ } wide 2 $\frac{3}{4}$ } face 2 $\frac{7}{8}$ } face	1 $\frac{1}{2}$
4		2 $\frac{1}{4}$
6		3
8		3 $\frac{3}{4}$
10		4 $\frac{1}{2}$
12		4 $\frac{7}{8}$
14		5 $\frac{1}{8}$
16		5 $\frac{1}{8}$

	Width of narrow face	
	When green	When seasoned
Shakes, checks, splits: 120 lb. shear grade.....	$\frac{3}{10}$ $\frac{1}{5}$ width of any face	$\frac{3}{8}$
Wane.....		

Close-grained Redwood

Slope of Grain.—1 in 16.

Knots.—Maximum permissible size in inches:

Nominal width of face, in.	On narrow face, or at edge of wide face, middle third of length, in.	At center line of wide face, in.	
2	$\left. \begin{array}{l} \frac{3}{8} \\ \frac{5}{8} \\ \frac{7}{8} \\ \frac{3}{8} \\ \frac{5}{8} \\ \frac{7}{8} \\ 1\frac{1}{8} \\ 1\frac{1}{4} \\ 1\frac{3}{8} \\ 1\frac{1}{2} \end{array} \right\} \begin{array}{l} \text{On} \\ \text{narrow} \\ \text{face} \\ \text{At} \\ \text{edge} \\ \text{of} \\ \text{wide} \\ \text{face} \end{array} $		
3			
4			
4			
6			$\frac{7}{8}$
8			$1\frac{1}{4}$
10			$1\frac{3}{4}$
12			$2\frac{1}{8}$
14			$2\frac{1}{2}$
16			$2\frac{3}{4}$
		3	

	Width of narrow face	
	When green	When seasoned
Shakes, checks, splits: 80 lb. shear grade.....	$\frac{1}{4}$ $\frac{1}{8}$ width of any face	$\frac{2}{9}$
Wane.....		

1,400 LB. *f* STRUCTURAL JOIST AND PLANK
Tidewater Red Cypress

Slope of Grain.—1 in 14.

Knots and Peck.—Maximum permissible size in inches:

Nominal width of face, in.	On narrow face, or at edge of wide face, middle third of length, in.	At center line of wide face, in.
2	$\left. \begin{array}{l} \frac{5}{8} \\ \frac{7}{8} \\ 1\frac{1}{8} \end{array} \right\} \text{On narrow face}$	
3		
4		
4		
6	$\left. \begin{array}{l} 1 \\ 1\frac{1}{4} \\ 1\frac{3}{8} \\ 1\frac{7}{8} \\ 2 \\ 2\frac{1}{4} \end{array} \right\} \text{At edge of wide face}$	$1\frac{1}{8}$
8		$1\frac{3}{4}$
10		$2\frac{3}{8}$
12		$2\frac{7}{8}$
14		$3\frac{1}{2}$
16		$3\frac{3}{4}$ $4\frac{1}{8}$

	Width of narrow face	
	When green	When seasoned
Shakes, checks, splits: 120 lb. shear grade.....	$1\frac{1}{10}$	$\frac{1}{5}$
Wane.....	$\frac{1}{8}$ width of any face	

Oak

Slope of Grain.—1 in 12.

Knots.—Maximum permissible size in inches:

Nominal width of face, in.	On narrow face, or at edge of wide face, middle third of length, in.	At center line of wide face, in.
2	$\left. \begin{array}{l} \frac{5}{8} \\ 1 \end{array} \right\} \text{On narrow face}$	
3		
4		
4		
6	$\left. \begin{array}{l} 1\frac{3}{8} \\ \frac{3}{4} \\ 1\frac{1}{8} \\ 1\frac{1}{2} \\ 1\frac{7}{8} \\ 2\frac{1}{4} \\ 2\frac{3}{8} \\ 2\frac{1}{2} \end{array} \right\} \text{At edge of wide face}$	$1\frac{1}{4}$
8		2
10		$2\frac{5}{8}$
12		$3\frac{1}{4}$
14		4
16		$4\frac{1}{4}$ $4\frac{5}{8}$

	Width of narrow face	
	When green	When seasoned
Shakes, checks, splits: 120 lb. shear grade.....	$\frac{1}{4}$	$\frac{1}{8}$
Wane.....	$\frac{1}{8}$ width of any face	

Dense Longleaf Southern Pine

Slope of Grain.—1 in 10.

Knots.—Maximum permissible size in inches:

Nominal width of face, in.	On narrow face, or at edge of wide face, middle third of length, in.	At center line of wide face, in.
2	$\frac{7}{8}$ } On $1\frac{1}{4}$ } narrow $1\frac{3}{4}$ } face	
3		
4	1 } $1\frac{1}{2}$ } At 2 } edge $2\frac{1}{2}$ } of 3 } wide $3\frac{1}{4}$ } face $3\frac{5}{8}$ }	$1\frac{3}{4}$
4		
6		$2\frac{5}{8}$
8		$3\frac{1}{2}$
10		$4\frac{1}{4}$
12		$5\frac{1}{4}$
14		$5\frac{5}{8}$
16		6

	Width of narrow face	
	When green	When seasoned
Shakes, checks, splits: 100 lb. shear grade.....	$\frac{3}{10}$	$\frac{3}{8}$
Wane.....	$\frac{1}{4}$ width of any face	

Close-grained Redwood

Slope of Grain.—1 in 14.

Knots.—Maximum permissible size in inches:

Nominal width of face, in.	On narrow face, or at edge of wide face, middle third of length, in.	At center line of wide face, in.	
2	$\left. \begin{array}{l} \frac{1}{2} \\ \frac{3}{8} \\ 1\frac{1}{8} \\ \frac{5}{8} \\ \frac{7}{8} \\ 1\frac{1}{4} \\ 1\frac{1}{2} \\ 1\frac{7}{8} \\ 2 \\ 2\frac{1}{8} \end{array} \right\} \begin{array}{l} \text{On} \\ \text{narrow} \\ \text{face} \\ \\ \text{At} \\ \text{edge} \\ \text{of} \\ \text{wide} \\ \text{face} \end{array}$		
3			
4			
4			
6			$1\frac{1}{8}$
8			$1\frac{5}{8}$
10			$2\frac{1}{4}$
12			$2\frac{7}{8}$
14			$3\frac{1}{4}$
14			$3\frac{5}{8}$
16			$3\frac{7}{8}$

	Width of narrow face	
	When green	When seasoned
Shakes, checks, splits: 80 lb. shear grade.....	$\frac{1}{4}$	$\frac{3}{8}$
Wane.....	$\frac{1}{8}$ width of any face	

1,200 LB. *f* STRUCTURAL JOIST AND PLANK
Port Orford Cedar

Slope of Grain.—1 in 14.

Knots.—Maximum permissible size in inches:

Nominal width of face, in.	On narrow face, or at edge of wide face, middle third of length, in.	At center line of wide face, in.	
2	$\left. \begin{array}{l} \frac{1}{2} \\ \frac{3}{8} \\ 1\frac{1}{8} \\ \frac{5}{8} \\ \frac{7}{8} \\ 1\frac{1}{4} \\ 1\frac{1}{2} \\ 1\frac{7}{8} \\ 2 \\ 2\frac{1}{8} \end{array} \right\} \begin{array}{l} \text{On} \\ \text{narrow} \\ \text{face} \\ \\ \text{At} \\ \text{edge} \\ \text{of} \\ \text{wide} \\ \text{face} \end{array}$		
3			
4			
4			
6			$1\frac{1}{8}$
8			$1\frac{5}{8}$
10			$2\frac{1}{4}$
12			$2\frac{7}{8}$
14			$3\frac{1}{4}$
14			$3\frac{5}{8}$
16			$3\frac{7}{8}$

	Width of narrow face	
	When green	When seasoned
Shakes, checks, splits: 100 lb. shear grade.....	$\frac{1}{8}$	$\frac{1}{4}$
Wane.....	$\frac{1}{8}$ width of any face	

Douglas Fir (Coast Region)

Slope of Grain.—1 in 10.

Knots.—Maximum permissible size in inches:

Nominal width of face, in.	On narrow face, or at edge of wide face, middle third of length, in.	At center line of wide face, in.
2	$\frac{7}{8}$ } On narrow face $1\frac{1}{4}$ } $1\frac{3}{4}$ }	
3		
4		
4		
6	$1\frac{1}{2}$ } At edge of wide face 2 } $2\frac{1}{2}$ } 3 } $3\frac{1}{4}$ } $3\frac{3}{8}$ }	$1\frac{3}{4}$ $2\frac{3}{8}$ $3\frac{1}{2}$ $4\frac{1}{4}$ $5\frac{1}{4}$ $5\frac{5}{8}$ 6
8		
10		
12		
14		
16		

	Width of narrow face	
	When green	When seasoned
Shakes, checks, splits: 100 lb. shear grade.....	$\frac{1}{8}$	$\frac{1}{4}$
Wane.....	$\frac{1}{4}$ width of any face	

Dense Shortleaf Southern Pine

Slope of Grain.—1 in 8.

Knots.—Maximum permissible size in inches:

Nominal width of face, in.	On narrow face, or at edge of wide face, middle third of length, in.	At center line of wide face, in.
2	1	2
3	1½	
4	2	
4	1½	
6	1¾	
8	2¼	
10	2½	
12	3½	
14	3¾	
16	4	

	Width of narrow face	
	When green	When seasoned
Shakes, checks, splits: 100 lb. shear grade.....	1/10	1/8
Wane.....		
	1/4 width of any face	

Close-grained Redwood

Slope of Grain.—1 in 12.

Knots.—Maximum permissible size in inches:

Nominal width of face, in.	On narrow face, or at edge of wide face, middle third of length, in.	At center line of wide face, in.
2	3/4	1 3/8
3	1 1/8	
4	1 1/2	
4	7/8	
6	1 1/4	
8	1 5/8	
10	2	
12	2 3/8	
14	2 5/8	
16	2 3/4	

	Width of narrow face	
	When green	When seasoned
Shakes, checks, splits: 70 lb. shear grade.....	$\frac{1}{4}$	$\frac{1}{8}$
Wane.....	$\frac{1}{8}$ width of any face	

1,100 LB. *f* STRUCTURAL JOIST AND PLANK
Port Orford Cedar

Slope of Grain.—1 in 12.

Knots.—Maximum permissible size in inches:

Nominal width of face, in.	On narrow face, or at edge of wide face, middle third of length, in.	At center line of wide face, in.
2	$\frac{5}{8}$ } On 1 } narrow $1\frac{3}{8}$ } face $\frac{3}{4}$ } 1 } $1\frac{1}{2}$ } At $1\frac{1}{2}$ } edge $1\frac{7}{8}$ } of 2 } wide $2\frac{1}{4}$ } face $2\frac{3}{8}$ } 2 } $2\frac{1}{2}$ }	
3		
4		
4		
6		$1\frac{1}{4}$
8		2
10		$2\frac{5}{8}$
12		$3\frac{1}{4}$
14		4
16		$4\frac{1}{4}$
		$4\frac{5}{8}$

	Width of narrow face	
	When green	When seasoned
Shakes, checks, splits: 80 lb. shear grade.....	$\frac{1}{8}$	$\frac{1}{10}$
Wane.....	$\frac{1}{8}$ width of any face	

Tidewater Red Cypress

Slope of Grain.—1 in 10.

Knots and Peck.—Maximum permissible size in inches:

Nominal width of face, in.	On narrow face, or at edge of wide face, middle third of length, in.	At center line of wide face, in.
2	$\frac{3}{4}$ } On $1\frac{1}{4}$ } narrow $1\frac{5}{8}$ } face $\frac{7}{8}$ } $1\frac{3}{8}$ } At $1\frac{7}{8}$ } edge $2\frac{3}{8}$ } of $2\frac{3}{4}$ } wide 3 } face $3\frac{1}{4}$ }	
3		
4		
4		
6		$1\frac{5}{8}$
8		$2\frac{1}{2}$
10		$3\frac{1}{4}$
12		$4\frac{1}{8}$
14		5
16		$5\frac{3}{8}$
		$5\frac{3}{4}$

	Width of narrow face	
	When green	When seasoned
Shakes, checks, splits: 100 lb. shear grade.....		
Wane.....	$\frac{1}{4}$	$\frac{1}{8}$
	$\frac{1}{4}$ width of any face	

Oak

Slope of Grain.—1 in 10.

Knots.—Maximum permissible size in inches:

Nominal width of face, in.	On narrow face, or at edge of wide face, middle third of length, in.	At center line of wide face, in.
2	$\frac{7}{8}$ } On $1\frac{3}{8}$ } narrow $1\frac{3}{4}$ } face 1 } $1\frac{1}{2}$ } At 2 } edge $2\frac{1}{2}$ } of 3 } wide $3\frac{1}{4}$ } face $3\frac{1}{2}$ }	
3		
4		
4		
6		$1\frac{3}{4}$
8		$2\frac{5}{8}$
10		$3\frac{1}{2}$
12		$4\frac{3}{8}$
14		$5\frac{1}{4}$
16		$5\frac{3}{4}$
		$6\frac{1}{8}$

	Width of narrow face	
	When green	When seasoned
Shakes, checks, splits: 100 lb. shear grade.....	$\frac{1}{4}$ $\frac{1}{4}$ width of any face	$\frac{3}{8}$
Wane.....		

1,000 LB. *f* STRUCTURAL JOIST AND PLANK
Western Red Cedar

Slope of Grain.— 1 in 14.

Knots.—Maximum permissible size in inches:

Nominal width of face, in.	On narrow face, or at edge of wide face, middle third of length, in.	At center line of wide face, in.
2	$\frac{1}{2}$ } On $\frac{7}{8}$ } narrow $1\frac{1}{8}$ } face	
3		
4	$\frac{5}{8}$ } $\frac{7}{8}$ } At $1\frac{1}{4}$ } edge $1\frac{1}{2}$ } of $1\frac{3}{4}$ } wide 2 } face	$1\frac{1}{8}$
4		$1\frac{5}{8}$
6		$2\frac{1}{4}$
8		$2\frac{3}{4}$
10		$3\frac{3}{8}$
12		$3\frac{5}{8}$
14		$3\frac{7}{8}$
16		$3\frac{7}{8}$

	Width of narrow face	
	When green	When seasoned
Shakes, checks, splits: 100 lb. shear grade.....	$\frac{1}{8}$ $\frac{1}{8}$ width of any face	$\frac{1}{6}$
Wane.....		

II. Structural Beams and Stringers

f = Extreme fiber stress in bending in pounds per square inch for continuously dry locations

1,800 LB. *f* STRUCTURAL BEAMS AND STRINGERS

Dense Douglas Fir (Coast Region)

Dense Longleaf Southern Pine

Dense Douglas Fir (Inland)

Dense Shortleaf Southern Pine

Slope of Grain.—1 in 15.

Knots.—Maximum permissible size in inches:

Nominal width of face, in.	On narrow face, middle third of length, in.	At center line of wide face, in.
5	$1\frac{1}{8}$	
6	$1\frac{3}{8}$	
8	$1\frac{5}{8}$	$1\frac{7}{8}$
10	$1\frac{3}{4}$	$2\frac{1}{4}$
12	$1\frac{7}{8}$	$2\frac{5}{8}$
14	$2\frac{1}{8}$	$2\frac{7}{8}$
16	$2\frac{1}{4}$	$3\frac{1}{8}$
18	...	$3\frac{3}{8}$
20	...	$3\frac{1}{2}$

	Width of narrow face	
	When green	When seasoned
Shakes, checks, splits:		
120 lb. shear grade (fir).....	$\frac{1}{8}$	$\frac{1}{4}$
120 lb. shear grade (pine).....	$\frac{3}{10}$	$\frac{3}{8}$
Wane.....	$\frac{1}{8}$ width of any face	

1,600 LB. *f* STRUCTURAL BEAMS AND STRINGERS

Close-grained Douglas Fir (Coast Region)

Slope of Grain.—1 in 15.

Knots.—Maximum permissible size in inches:

Nominal width of face, in.	On narrow face, middle third of length, in.	At center line of wide face, in.
5	$1\frac{1}{8}$	
6	$1\frac{3}{8}$	
8	$1\frac{5}{8}$	$1\frac{7}{8}$
10	$1\frac{3}{4}$	$2\frac{1}{4}$
12	$1\frac{7}{8}$	$2\frac{5}{8}$
14	$2\frac{1}{8}$	$2\frac{7}{8}$
16	$2\frac{1}{4}$	$3\frac{1}{8}$
18	...	$3\frac{3}{8}$
20	...	$3\frac{1}{2}$

	Width of narrow face	
	When green	When seasoned
Shakes, checks, splits: 100 lb. shear grade.....	$\frac{1}{8}$	$\frac{1}{4}$
Wane.....	$\frac{1}{8}$ width of any face	

Dense Longleaf Southern Pine
Dense Shortleaf Southern Pine

Slope of Grain.—1 in 12.

Knots.—Maximum permissible size in inches.

Nominal width of face, in.	On narrow face, middle third of length, in.	At center line of wide face, in.
5	$1\frac{1}{2}$	
6	$1\frac{7}{8}$	
8	$2\frac{1}{8}$	$2\frac{1}{2}$
10	$2\frac{3}{8}$	$3\frac{1}{8}$
12	$2\frac{5}{8}$	$3\frac{3}{4}$
14	$2\frac{7}{8}$	4
16	3	$4\frac{3}{8}$
18	...	$4\frac{5}{8}$
20	...	$4\frac{7}{8}$

	Width of narrow face	
	When green	When seasoned
Shakes, checks, splits: 120 lb. shear grade.....	$\frac{3}{10}$	$\frac{3}{8}$
Wane.....	$\frac{1}{8}$ width of any face	

Close-grained Redwood

Slope of Grain.—1 in 20.

Knots.—Maximum permissible size in inches

Nominal width of face, in.	On narrow face, middle third of length, in	At center line of wide face, in
5	$\frac{3}{8}$	
6	$\frac{3}{8}$	
8	$\frac{1}{2}$	$\frac{1}{2}$
10	$\frac{1}{2}$	$\frac{5}{8}$
12	$\frac{5}{8}$	$\frac{3}{4}$
14	$\frac{7}{8}$	$\frac{7}{8}$
16	$\frac{3}{4}$	$\frac{7}{8}$
18		1
20		1

	Width of narrow face	
	When green	When seasoned
Shakes, checks, splits 80 lb shear grade Wane	$\frac{1}{4}$ $\frac{1}{10}$ width of any face	$\frac{3}{8}$ face

1,400 LB f STRUCTURAL BEAMS AND STRINGERS
Tidewater Red Cypress

Slope of Grain —1 in 16

Knots and Peck —Maximum permissible size in inches

Nominal width of face, in	On narrow face, middle third of length, in.	At center line of wide face, in.
5	1	
6	$1\frac{1}{8}$	
8	$1\frac{3}{8}$	$1\frac{1}{2}$
10	$1\frac{1}{2}$	$1\frac{7}{8}$
12	$1\frac{5}{8}$	$2\frac{1}{4}$
14	$1\frac{3}{4}$	$2\frac{1}{2}$
16	$1\frac{7}{8}$	$2\frac{5}{8}$
18		$2\frac{7}{8}$
20		3

	Width of narrow face	
	When green	When seasoned
Shakes, checks, splits: 120 lb. shear grade.....	$\frac{1}{10}$	$\frac{1}{8}$
Wane.....	$\frac{1}{8}$ width of any face	

Oak

Slope of Grain.—1 in 15.

Knots.—Maximum permissible size in inches

Nominal width of face, in.	On narrow face, middle third of length, in.	At center line of wide face, in.
5	$1\frac{1}{4}$	
6	$1\frac{1}{2}$	
8	$1\frac{3}{4}$	2
10	2	$2\frac{1}{2}$
12	$2\frac{1}{8}$	3
14	$2\frac{1}{4}$	$3\frac{1}{4}$
16	$2\frac{1}{2}$	$3\frac{1}{2}$
18	...	$3\frac{3}{4}$
20	..	$3\frac{7}{8}$

	Width of narrow face	
	When green	When seasoned
Shakes, checks, splits: 120 lb. shear grade.....	$\frac{1}{4}$	$\frac{1}{8}$
Wane.....	$\frac{1}{6}$ width of any face	

Dense Longleaf Southern Pine

Slope of Grain.—1 in 10.

Knots.—Maximum permissible size in inches:

Nominal width of face, in.	On narrow face, middle third of length, in.	At center line of wide face, in.
5	2	
6	2 $\frac{3}{8}$	
8	2 $\frac{3}{4}$	3 $\frac{1}{4}$
10	3 $\frac{1}{8}$	4
12	3 $\frac{3}{8}$	4 $\frac{7}{8}$
14	3 $\frac{5}{8}$	5 $\frac{1}{4}$
16	4	5 $\frac{5}{8}$
18	...	5 $\frac{7}{8}$
20	...	6 $\frac{1}{4}$

	Width of narrow face	
	When green	When seasoned
Shakes, checks, splits: 100 lb. shear grade.....	$\frac{1}{10}$	$\frac{1}{8}$
Wane.....	$\frac{1}{4}$ width of any face	

Close-grained Redwood

Slope of Grain.—1 in 18.

Knots.—Maximum permissible size in inches:

Nominal width of face, in.	On narrow face, middle third of length, in.	At center line of wide face, in.
5	$\frac{7}{8}$	
6	1 $\frac{1}{8}$	
8	1 $\frac{1}{4}$	1 $\frac{1}{2}$
10	1 $\frac{3}{8}$	1 $\frac{3}{4}$
12	1 $\frac{5}{8}$	2 $\frac{1}{4}$
14	1 $\frac{5}{8}$	2 $\frac{3}{8}$
16	1 $\frac{3}{4}$	2 $\frac{1}{2}$
18	...	2 $\frac{3}{4}$
20	...	2 $\frac{3}{4}$

	Width of narrow face	
	When green	When seasoned
Shakes, checks, splits: 80 lb. shear grade.....	$\frac{1}{4}$	$\frac{3}{8}$
Wane.....	$\frac{1}{8}$ width of any face	

1,200 LB. *f* STRUCTURAL BEAMS AND STRINGERS
Dense Shortleaf Southern Pine

Slope of Grain.—1 in 8.

Knots.—Maximum permissible size in inches:

Nominal width of face, in.	On narrow face, middle third of length, in.	At center line of wide face, in.
5	$2\frac{3}{8}$	
6	$2\frac{7}{8}$	
8	$3\frac{3}{8}$	$3\frac{7}{8}$
10	$3\frac{3}{4}$	$4\frac{7}{8}$
12	$4\frac{1}{8}$	$5\frac{3}{4}$
14	$4\frac{3}{8}$	$6\frac{1}{4}$
16	$4\frac{3}{4}$	$6\frac{3}{4}$
18	...	$7\frac{1}{8}$
20	...	$7\frac{1}{2}$

	Width of narrow face	
	When green	When seasoned
Shakes, checks, splits: 100 lb. shear grade.....	$\frac{3}{10}$	$\frac{1}{2}$
Wane.....	$\frac{1}{4}$ width of any face	

Close-grained Redwood

Slope of Grain.—1 in 14.

Knots.—Maximum permissible size in inches:

Nominal width of face, in.	On narrow face, middle third of length, in.	At center line of wide face, in.
5	1½	
6	1¾	
8	2⅛	2¾
10	2⅜	3
12	2⅝	3⅝
14	2¾	3⅞
16	3	4¼
18		4½
20		4¾

	Width of narrow face	
	When green	When seasoned
Shakes, checks, splits: 70 lb. shear grade	¼	⅓
Wane		⅙ width of any face

1,100 LB. *f* STRUCTURAL BEAMS AND STRINGERS
Port Orford Cedar

Slope of Grain.—1 in 15.

Knots.—Maximum permissible size in inches:

Nominal width of face, in.	On narrow face, middle third of length, in.	At center line of wide face, in.
5	1¼	
6	1½	
8	1¾	2
10	2	2½
12	2⅛	3
14	2¼	3¼
16	2½	3½
18	...	3¾
20	...	3⅞

	Width of narrow face	
	When green	When seasoned
Shakes, checks, splits: 80 lb. shear grade.....	$\frac{1}{3}$	$\frac{3}{10}$
Wane.....	$\frac{1}{8}$ width of any face	

Tidewater Red Cypress

Slope of Grain.—1 in 12.

Knots and Peck.—Maximum permissible size in inches:

Nominal width of face, in.	On narrow face, middle third of length, in.	At center line of wide face, in.
5	$1\frac{3}{4}$	
6	$2\frac{1}{8}$	
8	$2\frac{1}{2}$	$2\frac{7}{8}$
10	$2\frac{3}{4}$	$3\frac{5}{8}$
12	$3\frac{1}{8}$	$4\frac{3}{8}$
14	$3\frac{3}{8}$	$4\frac{3}{4}$
16	$3\frac{1}{2}$	5
18	...	$5\frac{3}{8}$
20	...	$5\frac{5}{8}$

	Width of narrow face	
	When green	When seasoned
Shakes, checks, splits: 100 lb. shear grade.....	$\frac{1}{4}$	$\frac{1}{8}$
Wane.....	$\frac{1}{8}$ width of any face	

Oak

Slope of Grain.—1 in 10.

Knots.—Maximum permissible size in inches:

Nominal width of face, in.	On narrow face, middle third of length, in.	At center line of wide face, in.
5	2	
6	2½	
8	2⅞	3¼
10	3¼	4⅞
12	3½	5
14	3¾	5⅞
16	4	5¾
18	...	6
20	...	6⅞

	Width of narrow face	
	When green	When seasoned
Shakes, checks, splits: 100 lb. shear grade.....	¼	⅙
Wane.....		
	¼ width of any face	

1,000 LB. *f* STRUCTURAL BEAMS AND STRINGERS
Western Red Cedar

Slope of Grain.—1 in 18.

Knots.—Maximum permissible size in inches:

Nominal width of face, in.	On narrow face, middle third of length, in.	At center line of wide face, in.
5	¾	
6	1	
8	1⅞	1⅞
10	1¾	1⅞
12	1⅞	2
14	1½	2⅞
16	1⅞	2¾
18	...	2⅞
20	...	2½

	Width of narrow face	
	When green	When seasoned
Shakes, checks, splits: 100 lb. shear grade.....	$\frac{1}{8}$	$\frac{1}{8}$
Wane.....	$\frac{1}{8}$ width of any face	

III. Structural Posts and Timbers

c = Compression stress parallel to grain in pounds per square inch for continuously dry locations

1,300 LB. c. STRUCTURAL POSTS AND TIMBERS

Dense Douglas Fir (Coast Region)

Dense Longleaf Southern Pine

Dense Douglas Fir (Inland)

Dense Shortleaf Southern Pine

Slope of Grain.—1 in 12.

Knots.—Maximum permissible size in inches:

Nominal Width of Face, In.	At Any Point on Any Face, In.
5.....	$1\frac{1}{4}$
6.....	$1\frac{1}{2}$
8.....	$1\frac{3}{8}$
10.....	$2\frac{3}{8}$
12.....	$2\frac{1}{2}$
14.....	$3\frac{1}{8}$
16.....	$3\frac{3}{8}$
18.....	$3\frac{1}{2}$
20.....	$3\frac{3}{4}$

	Width of narrow face	
	When green	When seasoned
Shakes, checks, splits.....	$\frac{1}{10}$	$\frac{1}{2}$
Wane.....	$\frac{1}{8}$ width of any face	

1,200 LB. c STRUCTURAL POSTS AND TIMBERS
Tidewater Red Cypress

Slope of Grain.—1 in 12.

Knots and Peck.—Maximum permissible size in inches:

Nominal Width of Face, In.	At Any Point on Any Face, In.
5.....	$\frac{7}{8}$
6.....	$1\frac{1}{8}$
8.....	$1\frac{1}{2}$
10.....	$1\frac{3}{4}$
12.....	$2\frac{1}{4}$
14.....	$2\frac{3}{8}$
16.....	$2\frac{1}{2}$
18.....	$2\frac{3}{4}$
20.....	$2\frac{3}{4}$

	Width of narrow face	
	When green	When seasoned
Shakes, checks, splits.....	$\frac{1}{8}$	$\frac{3}{8}$
Wane.....	$\frac{1}{8}$ width of any face	

Close-grained Douglas Fir (Coast Region)

Slope of Grain.—1 in 12.

Knots.—Maximum permissible size in inches:

Nominal Width of Face, In.	At Any Point on Any Face, In.
5.....	$1\frac{1}{8}$
6.....	$1\frac{3}{8}$
8.....	$1\frac{1}{2}$
10.....	$2\frac{3}{8}$
12.....	$2\frac{3}{4}$
14.....	3
16.....	$3\frac{1}{4}$
18.....	$3\frac{3}{8}$
20.....	$3\frac{5}{8}$

	Width of narrow face	
	When green	When seasoned
Shakes, checks, splits.....	$\frac{1}{10}$	$\frac{1}{2}$
Wane.....	$\frac{1}{8}$ width of any face	

Dense Longleaf Southern Pine
Dense Shortleaf Southern Pine

Slope of Grain.—1 in 10.

Knots.—Maximum permissible size in inches:

Nominal Width of Face, In.	At Any Point on Any Face, In.
5.....	1½
6.....	1¾
8.....	2¾
10.....	3
12.....	3½
14.....	3¾
16.....	4¼
18.....	4½
20.....	4¾

	Width of narrow face	
	When green	When seasoned
Shakes, checks, splits.....	¼	½
Wane.....	⅙ width of any face	

Close-grained Redwood

Slope of Grain.—1 in 14.

Knots.—Maximum permissible size in inches:

Nominal Width of Face, In.	At Any Point on Any Face, In.
5.....	¾
6.....	⅞
8.....	1¼
10.....	1½
12.....	1¾
14.....	2
16.....	2½
18.....	2¾
20.....	2¾

	Width of narrow face	
	When green	When seasoned
Shakes, checks, splits.....	⅓	¾
Wane.....	⅙ width of any face	

1,100 LB. c STRUCTURAL POSTS AND TIMBERS
Douglas Fir (Coast Region)

Slope of Grain.—1 in 10.

Knots.—Maximum permissible size in inches:

Nominal Width of Face, In.	At Any Point on Any Face, In.
5.....	1¼
6.....	1½
8.....	2
10.....	2½
12.....	3
14.....	3¼
16.....	3½
18.....	3¾
20.....	3⅞

	Width of narrow face	
	When green	When seasoned
Shakes, checks, splits.....	¼	½
Wane.....	⅙ width of any face	

Oak

Slope of Grain.—1 in 14.

Knots.—Maximum permissible size in inches:

Nominal Width of Face, In.	At Any Point on Any Face, In.
5.....	¾
6.....	1
8.....	1⅝
10.....	1¾
12.....	2⅝
14.....	2¾
16.....	3⅝
18.....	2½
20.....	2⅝

	Width of narrow face	
	When green	When seasoned
Shakes, checks, splits.....	⅓	¾
Wane.....	⅙ width of any face	

Close-grained Redwood

Slope of Grain.—1 in 12.

Knots.—Maximum permissible size in inches:

Nominal Width of Face, In.	At Any Point on Any Face, In.
5.....	1 $\frac{1}{8}$
6.....	1 $\frac{3}{8}$
8.....	1 $\frac{3}{4}$
10.....	2 $\frac{1}{4}$
12.....	2 $\frac{5}{8}$
14.....	2 $\frac{7}{8}$
16.....	3 $\frac{1}{8}$
18.....	3 $\frac{1}{4}$
20.....	3 $\frac{1}{2}$

	Width of narrow face	
	When green	When seasoned
Shakes, checks, splits.....	$\frac{3}{8}$	$\frac{1}{2}$
Wane.....	$\frac{1}{8}$ width of any face	

1,000 LB. c STRUCTURAL POSTS AND TIMBERS
Port Orford Cedar

Slope of Grain.—1 in 14.

Knots.—Maximum permissible size in inches:

Nominal Width of Face, In.	At Any Point on Any Face, In.
5.....	$\frac{7}{8}$
6.....	1
8.....	1 $\frac{3}{8}$
10.....	1 $\frac{5}{8}$
12.....	2
14.....	2 $\frac{1}{8}$
16.....	2 $\frac{1}{4}$
18.....	2 $\frac{3}{8}$
20.....	2 $\frac{1}{2}$

	Width of narrow face	
	When green	When seasoned
Shakes, checks, splits.....	$\frac{1}{8}$	$\frac{3}{4}$
Wane.....	$\frac{1}{8}$ width of any face	

Tidewater Red Cypress

Slope of Grain.—1 in 10.

Knots and Peck.—Maximum permissible size in inches:

Nominal Width of Face, In.	At Any Point on Any Face, In.
5.....	1 ⁵ / ₈
6.....	1 ⁷ / ₈
8.....	2 ¹ / ₂
10.....	3 ¹ / ₄
12.....	3 ³ / ₄
14.....	4
16.....	4 ³ / ₈
18.....	4 ³ / ₄
20.....	5

	Width of narrow face	
	When green	When seasoned
Shakes, checks, splits.....	⁴ / ₈	⁵ / ₈
Wane.....	¹ / ₈ width of any face	

Oak

Slope of Grain.—1 in 12.

Knots.—Maximum permissible size in inches:

Nominal Width of Face, In.	At Any Point on Any Face, In.
5.....	1 ¹ / ₄
6.....	1 ¹ / ₂
8.....	2
10.....	2 ¹ / ₂
12.....	3
14.....	3 ¹ / ₄
16.....	3 ¹ / ₂
18.....	3 ³ / ₄
20.....	3 ⁷ / ₈

	Width of narrow face	
	When green	When seasoned
Shakes, checks, splits.....	³ / ₁₀	¹ / ₂
Wane.....	¹ / ₈ width of any face	

Dense Longleaf Southern Pine

Slope of Grain.—1 in 8.

Knots.—Maximum permissible size in inches:

Nominal Width of Face, In.	At Any Point on Any Face, In
5.....	2 $\frac{1}{8}$
6.....	2 $\frac{1}{4}$
8.....	3 $\frac{3}{8}$
10.....	4 $\frac{1}{8}$
12.....	5
14.....	5 $\frac{3}{8}$
16.....	5 $\frac{3}{4}$
18.....	6 $\frac{1}{8}$
20.....	6 $\frac{3}{8}$

	Width of narrow face	
	When green	When seasoned
Shakes, checks, splits	$\frac{1}{2}$	$\frac{5}{8}$
Wane.....	$\frac{1}{4}$ width of any face	

Close-grained Redwood

Slope of Grain.—1 in 10.

Knots.—Maximum permissible size in inches:

Nominal Width of Face, In.	At Any Point on Any Face, In.
5.....	1 $\frac{1}{2}$
6.....	1 $\frac{3}{4}$
8.....	2 $\frac{3}{8}$
10.....	2 $\frac{7}{8}$
12.....	3 $\frac{1}{2}$
14.....	3 $\frac{3}{4}$
16.....	4 $\frac{1}{8}$
18.....	4 $\frac{3}{8}$
20.....	4 $\frac{5}{8}$

	Width of narrow face	
	When green	When seasoned
Shakes, checks, splits.....	$\frac{3}{4}$	$\frac{1}{2}$
Wane.....	$\frac{1}{6}$ width of any face	

900 LB. c STRUCTURAL POSTS AND TIMBERS
Port Orford Cedar

Slope of Grain.—1 in 12.

Knots.—Maximum permissible size in inches:

Nominal Width of Face, In.	At Any Point. on Any Face, In.
5.....	1 $\frac{1}{4}$
6.....	1 $\frac{1}{2}$
8.....	2
10.....	2 $\frac{1}{2}$
12.....	3
14.....	3 $\frac{1}{4}$
16.....	3 $\frac{1}{2}$
18.....	3 $\frac{3}{4}$
20.....	3 $\frac{7}{8}$

	Width of narrow face	
	When green	When seasoned
Shakes, checks, splits.....	$\frac{1}{10}$	$\frac{1}{2}$
Wane.....	$\frac{1}{6}$ width of any face	

Dense Shortleaf Southern Pine

Slope of Grain.—1 in 6.

Knots.—Maximum permissible size in inches:

Nominal Width of Face, In.	At Any Point on Any Face, In.
5.....	2 $\frac{3}{8}$
6.....	2 $\frac{7}{8}$
8.....	3 $\frac{3}{4}$
10.....	4 $\frac{3}{4}$
12.....	5 $\frac{5}{8}$
14.....	6 $\frac{1}{8}$
16.....	6 $\frac{1}{2}$
18.....	7
20.....	7 $\frac{1}{4}$

	Width of narrow face	
	When green	When seasoned
Shakes, checks, splits.....	$\frac{5}{6}$	$\frac{3}{8}$
Wane.....	$\frac{1}{4}$ width of any face	

800 LB. c POSTS AND TIMBERS
Western Red Cedar

Slope of Grain.—1 in 14.

Knots.—Maximum permissible size in inches:

Nominal Width of Face, In.	At Any Point on Any Face, In.
5.....	$\frac{3}{4}$
6.....	$\frac{3}{4}$
8.....	$1\frac{1}{8}$
10.....	$1\frac{3}{8}$
12.....	$1\frac{3}{4}$
14.....	$1\frac{7}{8}$
16.....	2
18.....	$2\frac{1}{8}$
20.....	$2\frac{1}{4}$

	Width of narrow face	
	When green	When seasoned
Shakes, checks, splits.....	$\frac{3}{16}$	$\frac{2}{8}$
Wane.....	$\frac{1}{8}$ width of any face	

46. Lumber.—Lumber is graded and sold under rules of various lumber manufacturers' associations, to whom apply for detailed grading rules. The basis of the rules is the presence or absence of defects and sizes. The standard of lumber measurement is the board foot, equal to a piece of lumber 1 ft. square and 1 in. thick; thus, a timber 12 in. by 12 in. by 20 ft. contains 240 ft. B.M. (board measure). Lumber is furthermore distinguished as rough lumber and finished lumber (S2S, surfaced on both sides, and S4S, surfaced on four sides). Most lumber is sold in even lengths.

Lumber is usually somewhat smaller than the dimensions under which it is sold would indicate. Rough lumber may be full size; surfaced lumber will vary $\frac{1}{4}$ in. for each surfaced side. This has been recognized by engineering societies and others, leading to the adoption of the following size rule for structural timbers: Rough sizes of structural timber shall not vary more than $\frac{1}{4}$ in. scant of specified size—dressed size may be $\frac{1}{2}$ in. scant after dressing.

Table 3 gives contents in feet, B.M. of joists, scantlings and timbers.

TABLE 3.—CONTENTS IN FEET (B.M.) OF JOISTS, SCANTLINGS AND TIMBERS

Size in inches	Length in feet									
	12	14	16	18	20	22	24	26	28	30
2 × 4	8	9	11	12	13	15	16	17	19	20
2 × 6	12	14	16	18	20	22	24	26	28	30
2 × 8	16	19	21	24	27	29	32	35	37	40
2 × 10	20	23	27	30	33	37	40	43	47	50
2 × 12	24	28	32	36	40	44	48	52	56	60
2 × 14	28	33	37	42	47	51	56	61	65	70
3 × 8	24	28	32	36	40	44	48	52	56	60
3 × 10	30	35	40	45	50	55	60	65	70	75
3 × 12	36	42	48	54	60	66	72	78	84	90
3 × 14	42	49	56	63	70	77	84	91	98	105
4 × 4	16	19	21	24	27	29	32	35	37	40
4 × 6	24	28	32	36	40	44	48	52	56	60
4 × 8	32	37	43	48	53	59	64	69	75	80
4 × 10	40	47	53	60	67	73	80	87	93	100
4 × 12	48	56	64	72	80	88	96	104	112	120
4 × 14	56	65	75	84	93	103	112	121	131	140
6 × 6	36	42	48	54	60	66	72	78	84	90
6 × 8	48	56	64	72	80	88	96	104	112	120
6 × 10	60	70	80	90	100	110	120	130	140	150
6 × 12	72	84	96	108	120	132	144	156	168	180
6 × 14	84	98	112	126	140	154	168	182	196	210
8 × 8	64	75	85	96	107	117	128	139	149	160
8 × 10	80	93	107	120	133	147	160	173	187	200
8 × 12	96	112	128	144	160	176	192	208	224	240
8 × 14	112	131	149	168	187	205	224	243	261	280
10 × 10	100	117	133	150	167	183	200	217	233	250
10 × 12	120	140	160	180	200	220	240	260	280	300
10 × 14	140	163	187	210	233	257	280	303	327	350
12 × 12	144	168	192	216	240	264	288	312	336	360
12 × 14	168	196	224	252	280	308	336	364	392	420
14 × 14	196	229	261	292	327	359	392	425	457	490

47. **Piling.**—The following woods are used chiefly for piling and poles: Oak, cypress, pine and Douglas fir.

The following specifications for round timber piles were adopted by the American Society for Testing Materials in 1937 as A.S.T.M. Designation: D25-37.

STANDARD SPECIFICATIONS

For

ROUND TIMBER PILES

(A.S.T.M. Designation D25-37)

1. Scope.—These specifications cover round timber piles to be used untreated, or treated by standard preservatives.

NOTE: Where sawed timber is used as piling, such as heavy sheet piles, appropriate specifications should be selected from the Standard Specifications for Structural Wood Joist and Plank, Beams and Stringers, and Posts and Timbers (A.S.T.M. Designation D 245) of the American Society for Testing Materials.

2. Kinds of Wood.—*a.* The purchaser shall specify the kind or kinds of wood he desires and shall designate the kinds he desires for preservative treatment.

NOTE: Commonly used species are cedars, chestnut, cypress, Douglas fir, larch, oaks, pines, spruces, and tamarack.

b. Piles of different kinds of wood shall be delivered in separate lots.

3. Use Classification.—Timber piles are classified in these specifications under three general divisions according to the use intended, as follows:

a. Class A.—Piles suitable for use in heavy railway bridges and trestles. The minimum diameter of butt assumes the use of load-bearing timber caps 14 in. in width.

b. Class B.—Piles suitable for use in docks, wharves, highway work, and general construction. The minimum diameter of butt assumes the use of load-bearing timber caps 12 in. in width. When timber caps are not used, as in the case of piles under masonry foundations, the sizes given for Class C piles are recommended.

c. Class C.—Piles suitable for use in foundations which will always be completely submerged, for cofferdams, falsework, and sundry temporary work.

CLASS A AND CLASS B PILES

4. General Quality.—Except as hereinafter provided, Class A and Class B piles shall be free from any defects which may impair their strength or durability as piling, such as decay, red heart, splits in piles to be treated, or splits longer than the measured butt diameter of piles not to be treated, twist of grain exceeding one-half of the circumference in any 20 ft. of length, unsound knots, numerous knots or holes, or shake more than one-third of the diameter of the pile. Piles which have been scored for turpentine shall be accepted, provided such scar does not exceed 36 in. and provided the scoring is of recent date showing the scar to be entirely sound and free from insect damage.

5. Knots.—Sound knots will be permitted in Class A and Class B piles, provided they are not in clusters. The diameter of a sound knot shall not be greater than one-third of the minimum diameter of the pile at the section where it occurs, and shall not exceed 4 in. for piles 50 ft. and under in length. For piles over 50 ft. in length, knots between the section at mid-length and the butt shall conform to the limitation prescribed for piling under 50 ft. Between mid-length and the tip, single knots up to 5 in. in diameter will be permitted, provided they do not exceed one-half the minimum diameter of the pile at the section where they occur. The diameter of a knot shall be measured at right angles to the length of the pile.

6. General Requirements.—*a. Sound Timber.*—Class A and Class B piles shall be cut from sound, live trees, except that fire-killed, blight-killed, or wind-felled timber may be used if not attacked by decay or insects. Piles shall be cut above the ground swell.

b. Tip.—The tip shall be sound.

c. Butt End.—The butt end shall be sound except in cedar piles, which may have a pipe or stump rot hole not more than $1\frac{1}{2}$ in. in diameter.

d. Taper.—Piles shall have a gradual taper from the point of butt measurement to the tip.

e. Surface Finish.—All knots and limbs shall be trimmed or smoothly cut flush with the surface of the pile. The butt and tip shall be sawed square with the axis of the pile, or the tip may be tapered to a point not less than 4 in. in diameter if directed by the engineer in charge.

7. Sapwood. *a. Piles for Use Untreated.*—Piles for use without preservative treatment shall have as little sapwood as possible; and when used in exposed work, the diameter of the heartwood shall not be less than eight-tenths of the actual diameter of the pile at the butt.

b. Piles for Treatment.—Piles for use with preservative treatment shall have no sapwood restrictions but preferably shall contain as much sapwood as possible. In southern pine the sapwood thickness shall not be less than $1\frac{1}{2}$ in. and in Douglas fir and larch not less than 1 in. on the butt end.

8. Peeled Piles.—*a.* Piles shall be peeled of bark, including the inner skin, soon after cutting so that the piles are smooth and clean. Care shall be taken to remove as little sapwood as possible while peeling the bark. The sapwood shall not be injured by unnecessary axe cuts. These piles shall be designated as piles for treatment.

DIAMETERS OF THREE CLASSES OF PILES

Length, ft.	Class A and Class B pile* (These differ in size only)						Class C Piles* (These differ from Classes A and B in size and quality)			
	Class A			Class B						
	Diameter 3 ft. from butt, in.		Mini- mum diam- eter of tip, in.	Diameter 3 ft. from butt, in.		Mini- mum diam- eter of tip, in.	Diameter 3 ft. from butt, in.		Mini- mum diam- eter of tip, in.	
	Mini- mum	Maxi- mum		Mini- mum	Maxi- mum		Mini- mum	Maxi- mum		
Douglas Fir and Southern Pine Piles†										
Under 40	14	18	10	12	20	8	12	20	8	
40 to 50, incl. . . .	14	18	9	12	20	7	12	20	6	
51 to 70, incl. . . .	14	18	8	13	20	7	12	20	6	
71 to 90, incl. . . .	14	20	7	13	20	6	12	20	6	
Over 90	14	20	6	13	20	5	12	20	5	
Black Oak, Chestnut, Cypress, Pin Oak, Post or Burr Oak, Red Oak, White Oak, or Willow Oak Piles										
Under 30	14	18	10	12	18	8	12	20	8	
30 to 40, incl. . . .	14	18	9	13	20	8	12	20	8	
Over 40	14	18	8	13	20	7	12	20	6	
Cedar Piles										
Under 30	14	22	10	12	22	8	12	22	8	
30 to 40, incl. . . .	14	22	9	13	22	8	12	22	8	
Over 40	14	22	8	13	22	7	12	22	7	

* In Class C piles, a minimum diameter (at cutoff) of 10 in. may be specified for lengths of 20 ft. and under.

† Where larch, lodgepole or Norway pine, spruce, or tamarack piles are specified, their dimensions shall correspond to the requirements shown for Douglas fir and southern pine.

b. No pile shall be considered as thoroughly peeled unless all of the rough bark and at least 80 per cent of the inner bark which remains on the pile shall have been removed. In no case shall any piece of inner bark be over $\frac{3}{4}$ in. in width or over 8 in. in length, and there shall be 1 in. of clean wood surface between any two strips of inner bark.

9. **Diameter.**—*a.* It is recommended that the diameters of piles measured under the bark shall conform to the requirements shown in the following table, subject to a permissible variation of minus $\frac{1}{2}$ in. in any diameter in not more than 25 per cent of the piles of that diameter.

b. The diameter of a pile in cases where the tree is not exactly round shall be determined either by measuring the circumference and dividing the number of inches by 3.14 or by taking the average of the maximum and minimum diameters at the location specified.

10. **Length.**—All piles shall be furnished cut to any of the following lengths, as specified: 16 to 40 ft. in multiples of 2 ft., and over 40 ft. in multiples of 5 ft. A variation of 6 in. in length shall be allowable, but the average length in any shipment shall be equal to, or greater than, the specified lengths. The length of each pile shall be legibly marked on the butt end with white or black paint.

11. **Straightness.**—Piles shall be free from short or reversed bends and free from crooks greater than one-half of the diameter of the pile at the middle of the bend. In short bends, the distance from the center of the pile to a line stretched from the center of the pile above the bend to the center of the pile below the bend shall not exceed 4 per cent of the length of the bend, or $2\frac{1}{2}$ in. A line drawn from the center of the butt end to the center of the tip shall lie within the body of the pile.

CLASS C PILES

12. **General Quality.**—Class *C* piles shall be of sound, live timber that will stand driving and need not be peeled if they are to be used without preservative treatment. They shall be free from decay and other imperfections such as bad knots and shakes which will materially affect their strength. Piles which have been scored for turpentine shall be accepted, provided such scar does not exceed 36 in. and provided the scoring is of recent date showing the scar to be entirely sound and free from insect damage.

13. **General Requirements.** *a. Tip.*—The tip shall be sound.

b. Taper.—Piles shall have a gradual taper from the point of butt measurement to the tip.

c. Surface Finish.—All knots and limbs shall be trimmed or smoothly cut flush with the surface of the pile. The butt and tip shall be sawed square with the axis of the pile, or the tip may be tapered to a point not less than 4 in. in diameter if directed by the engineer in charge.

14. **Sapwood.**—Sapwood requirements shall be identical with those for Class *A* and Class *B* piles as specified in Section 7.

15. **Peeled Piles.**—The requirements for peeled piles shall be identical with those for Class *A* and Class *B* piles as specified in Section 8.

16. **Diameter.**—The methods of measurement of diameter and the permissible variations in diameter shall be identical with those for Class *A* and Class *B* piles as specified in Section 9. The recommended sizes are given in the table.

17. **Length.**—The requirements for length shall be identical with those for Class *A* and Class *B* piles as specified in Section 10.

18. **Straightness.**—The requirements relating to straightness shall be identical with those for Class *A* and Class *B* piles as specified in Section 11.

APPENDICES

APPENDIX A

GENERAL SPECIFICATIONS FOR STEEL RAILWAY BRIDGES¹ (For Fixed Spans Less than 300 Ft. in Length)

AMERICAN RAILWAY ENGINEERING ASSOCIATION

1920

(1) PROPOSALS AND DRAWINGS

1. *Definitions of Terms.*—The term "Engineer" refers to the Chief Engineer of the Company or his subordinates in authority. The term "Inspector" refers to the inspector or inspectors representing the Company. The term "Company" refers to the Railway Company or Railroad Company party to the contract. The term "Contractor" refers to the manufacturing or fabricating contractor party to the contract.

2. *Proposals.*—Bidders shall submit proposals to conform with the terms in the letter of invitation. The proposals preferably shall be based upon plans and specifications furnished by the Company showing the general dimensions necessary for designing the structure, the stresses and the general or typical details. Invitations covering work to be designed or erected by the Contractor shall state the general conditions at the site, such as track spacing, character of foundations, old structures, traffic conditions, etc.

3. *Drawings to Govern.*—Where the drawings and the specifications differ, the drawings shall govern.

4. *Patented Devices.*—The Contractor shall protect the Company against claims on account of patented devices or parts proposed by him.

5. *Drawings.*—After the contract has been awarded and before any work is commenced, the Contractor shall submit to the Engineer for approval duplicate prints of stress sheets and shop drawings, unless such drawings shall have been prepared by the Company. The tracings of these drawings shall be the property of and be delivered to the Company after the completion of the contract. Shop drawings shall be made on the dull side of the tracing cloth, 24 by 36 in. in size, including margins. The margin at the left end shall be 1½ in. wide, and the others ½ in. The title shall be in the lower right-hand corner. No changes shall be made on any approved drawing without the consent, in writing, of the Engineer.

6. The Contractor shall be responsible for the correctness of his drawings, and for shop fits and field connections, although the drawings may have been approved by the Engineer.

7. Any material ordered by the Contractor prior to the approval of the drawings shall be at his risk.

(2) GENERAL FEATURES OF DESIGN

8. *Materials Used.*—Structures shall be made wholly of structural steel except where otherwise specified. Cast steel preferably shall be used for shoes and bearings. Cast iron may be used only where specifically authorized by the Engineer.

¹ Specifications for steel buildings should conform and be consistent with specifications for steel railway bridges. That is, the unit stresses and the specifications for materials should be identical in the two sets of specifications. The percentages allowed for impact, however, are not used on building work and the effect, of course, would be to have the buildings designed using a higher unit stress than for bridges.

9. *Types of Bridges.*—The different types of bridges may be used as follows:

Rolled beams for spans up to 35 ft.

Plate girders for spans from 30 ft. to 125 ft.

Riveted trusses for spans from 100 ft. to 300 ft.

Pin-connected trusses for spans from 150 ft. to 300 ft.

10. *Number of Trusses.*—Unless otherwise specified, double-track through bridges shall have only two trusses or girders, and four-track bridges three.

11. *Dimensions for Calculation.*—The dimensions for the calculation of stresses shall be as follows:

SPAN LENGTH

For trusses and girders, the distance center to center of end bearings.

For floor beams, the distance center to center of trusses or girders.

For stringers, the distance center to center of floor beams.

DEPTH

For riveted trusses, the distance between centers of gravity of chord sections.

For pin-connected trusses, the distance center to center of chord pins.

For plate girders, floor beams and stringers, the distance between centers of gravity of flanges, but not to exceed the distance back to back of the flange angles.

12. *Spacing of Trusses, Girders and Floor Beams.*—The width center to center of girders or trusses shall be not less than one-fifteenth of the effective span, and not less than is necessary to prevent overturning under the assumed lateral loading. Panel lengths shall not exceed $1\frac{1}{2}$ times the width center to center of trusses or girders.

13. *Clearances.*—If the alinement is straight, clearances shall be not less than shown on the diagram, Fig. 1. If the alinement is curved, the width of the diagram shall be increased so as to provide the same minimum clearances for a car 80 ft. long, 14 ft. high and 60 ft. center to center

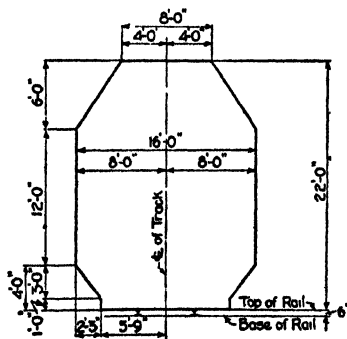

FIG. 1.

of trucks, allowance being made for curvature and superelevation of rails. The height of rail shall be assumed as 6 in.

14. *Deck Spans on Curves.*—Deck spans on curves shall have the center line of the span placed, usually, so as to bisect the middle ordinate of and be parallel with the chord of the curve.

15. *Skew Bridges.*—In skew bridges without ballasted floors, the ends of stringers or girders for each track shall be square with the track.

16. *Ambiguity of Stress.*—Structures shall be designed so as to avoid, as far as practicable, ambiguity in the determination of the stresses.

(3) LOADS

17. *Loads.*—The structures shall be proportioned for the following loads:

- (a) The dead load.
- (b) The live load.
- (c) The impact or dynamic effect of the live load.
- (d) The lateral loads and forces.
- (e) The centrifugal force, including impact.
- (f) The longitudinal force.

Stresses due to these loads and forces shall be shown separately on the stress sheets.

18. Members shall be proportioned for that combination of stresses which gives the maximum total stress, except as otherwise provided.

19. *Dead Load.*—The dead load shall consist of the estimated weight of the entire suspended structure. Timber shall be assumed to weigh $4\frac{1}{2}$ lb. per ft. B.M., ballast 120 lb. per cu. ft., reinforced concrete 150 lb. per cu. ft., waterproofing 150 lb. per cu. ft., and rails and fastenings 150 lb. per lin. ft. of track. If ballast is used, it shall be assumed level with the base of rail and the weight of the ties shall be neglected. Ballasted floors shall have at least 6 in. of ballast under the ties.

20. *Live Load.*—The minimum live load for each track shall be as shown in Figs. 2 and 3, except as modified in Art. 21.

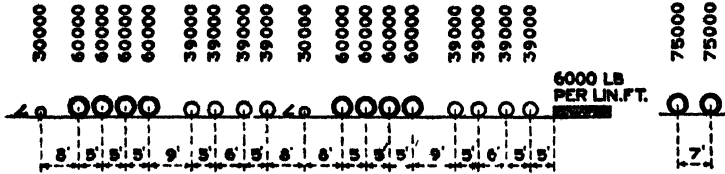

FIG. 2.

FIG. 3.

The loading that gives the larger stresses shall be used.

21. In special locations, where the conditions limit the loading to light engines, a lighter loading, as stipulated by the Engineer, may be used, but not in any case lighter than three-fourths of that specified in Art. 20.

22. Other live loadings shall be proportional to the loading specified in Art. 20 with the same wheel spacing.

23. *Multiple Tracks.*—In calculating the maximum stresses due to live load and centrifugal force when two, three or four tracks are simultaneously loaded, use the following percentages of the specified live load:

For two tracks, loaded, 90 per cent.

For three tracks, loaded, 80 per cent.

For four tracks, loaded, 75 per cent.

24. *Floors.*—Wooden ties shall be designed for the maximum wheel load specified distributed over three ties and with 100 per cent. impact added. The fiber stress shall not exceed 2,000 lb. per sq. in. The ties shall be not less than 10 ft. in length. They shall be placed with openings not to exceed 4 in. in width and shall be secured against bunching. The maximum gap of ties shall be $1\frac{1}{4}$ in.

25. Floors consisting of beams transverse to the axis of the structure shall be designed for a uniform live load of 15,000 lb. per lin. ft. for each track, when the minimum live load specified in Art. 20 is used. When heavier loadings are used, this uniform load shall be increased proportionately.

26. Floors consisting of longitudinal beams shall be designed for the wheel loads specified.

27. In ballasted floor bridges, the live load shall be considered as uniformly distributed laterally over a width of 10 ft.

28. *Impact.*—The dynamic increment of the live load shall be added to the maximum computed live load stresses and shall be determined by the formula

$$I = S \cdot \frac{300}{300 + \frac{L^2}{100}}$$

in which

I = impact or dynamic increment to be added to the live-load stress.

S = computed maximum live-load stress.

L = the length in feet of the portion of the span which is loaded to produce the maximum stress in the member.

29. For bridges designed exclusively for electric traction, the impact stresses shall be taken as one-half of those given by the formula in Art. 28.

30. Impact shall not be added to stresses produced by longitudinal or lateral forces.

31. *Eccentricity of Load on Curves.*—For bridges on curves, provision shall be made for the increased load carried by any truss, girder or stringer due to the eccentricity of the load.

32. *Lateral Forces.*—The lateral (or wind) force shall consist of a moving load equal to 30 lb. per sq. ft. on $1\frac{1}{2}$ times the vertical projection of the structure on a plane parallel with its axis (but never less than 200 lb. per lin. ft. at the loaded chord, and 150 lb. per lin. ft. at the unloaded chord), and a moving load of 700 lb. per lin. ft. applied 8 ft. above the base of rail.

33. If a moving load of 50 lb. per sq. ft. on $1\frac{1}{2}$ times the vertical projection of the unloaded structure on a plane parallel with its axis produces greater stresses than the lateral force defined in Art. 32, it shall be provided for.

34. In calculating the stresses in viaduct towers due to lateral force, the viaduct shall be considered as loaded on either one or both tracks, with empty cars weighing 1,200 lb. per lin. ft.

35. The lateral bracing between compression chords or flanges shall be capable of resisting a transverse shear in any panel equal to $2\frac{1}{2}$ per cent of the total axial stress in the chords in that panel.

36. *Centrifugal Force.*—On curves, the centrifugal force (assumed to act 6 ft. above the rail) shall be taken equal to a percentage of the live load including impact according to the following table:

	0°	0°	1°	2°	3°	4°	5°	6°	7°	8°	9°	10°	11°	12°
Degree of curve	20'	40'												
Percentage	2½	5	7½	10	10	10	10	10	10	10	10	10	10	10
Speed in miles per hour	80	80	80	65	53	46	41	38	35	33	31	29	28	27

37. *Longitudinal Force.*—Provision shall be made in the design for the effect of a longitudinal force of 20 per cent of the live load on one track only, applied 6 ft. above the top of the rail. In structures (such as ballasted deck bridges of only three or four spans) where, by reason of continuity of members or frictional resistance, the longitudinal force will be largely directed to the abutments, its effect on the superstructure shall be taken as one-half that specified above.

(4) UNIT STRESSES AND PROPORTIONING OF PARTS

38. The several parts of structures shall be so proportioned that the unit stresses will not exceed the following, except as modified in Arts. 46 and 47:

Axial tension, net section.....	LB. PER SQ. IN.	16,000
Axial compression, gross section.....	15,000—50 $\frac{l}{r}$	
but not to exceed.....	12,500	
l = the length of the member in inches.		
r = the least radius of gyration of the member in inches.		
Tension in extreme fibers of rolled shapes, built sections and girders, net section.....	16,000	
Tension in extreme fibers of pins.....	24,000	
Shear in plate girder webs, gross section.....	10,000	
Horizontal shear in flange angles of girders.....	4,000	
Shear in power-driven rivets and pins.....	12,000	
Bearing on power-driven rivets, pins, outstanding legs of stiffener angles, and other steel parts in contact.....	24,000	
The above-mentioned values for shear and bearing shall be reduced 25 per cent for countersunk rivets, hand-driven rivets, floor-connection rivets, and turned bolts.		
Bearing on expansion rollers, per linear inch.....	600d	
d = the diameter of rollers in inches.		
	LB. PER SQ. IN.	
Bearing on granite masonry.....	800	
Bearing on sandstone and limestone masonry.....	400	
Bearing on concrete masonry.....	600	

39. For cast steel in shoes and bearings, the above-mentioned unit stresses shall apply.

40. The diagonal tension in webs of girders and rolled beams at sections where maximum shear and bending occur simultaneously, shall not exceed 16,000 lb. per sq. in.

41. *Effective Bearing Area.*—The effective bearing area of a pin, a bolt or a rivet shall be its diameter multiplied by the thickness of the piece, except that for counter-sunk rivets, half the depth of the countersink shall be omitted.

42. *Effective Diameter of Rivets.*—In proportioning rivets, the nominal diameter of the rivet shall be used.

43. *Proportioning Web Members.*—In proportioning web members of trusses, use two-thirds of the dead load stress plus one and one-sixth times the live load stress, including impact, where this sum is greater than the sum of the dead load stress and the live load stress, including impact.

44. *Reversal of Stress.*—Members subject to reversal of stress under the passage of the live load shall be proportioned as follows:

Determine the resultant tensile stress and the resultant compressive stress and increase each by 50 per cent of the smaller; then proportion the member so that it will be capable of resisting either increased resultant stress. The connections shall be proportioned for the sum of the resultant stresses.

45. *Combined Stresses.*—Members subject to both axial and bending stresses (including bending due to floor beam deflection) shall be proportioned so that the combined fiber stresses will not exceed the allowed axial stress. In members continuous over panel points, only three-fourths of the bending stress computed as for simple beams shall be added to the axial stress.

46. Members subject to stresses produced by a combination of dead load, live load, impact and centrifugal force, with either lateral or longitudinal forces, or bending due to lateral action, may be proportioned for unit stresses 25 per cent greater than those specified in Art. 38; but the section shall not be less than that required for dead load, live load, impact and centrifugal force.

47. *Secondary Stresses.*—Designing and detailing shall be done so as to avoid secondary stresses as far as possible. In ordinary trusses without sub-panelling, no account usually need be taken of the secondary stresses in any member whose width measured in the plane of the truss is less than one-tenth of its length. Where this ratio is exceeded, or where subpanelling is used, secondary stress due to deflection of the truss shall be computed. The unit stresses specified in Art. 38 may be increased one-third for a combination of the secondary stresses with the other stresses, but the section shall not be less than that required when secondary stresses are not considered.

48. *Compression Flanges.*—The gross area of the compression flanges of plate girders and rolled beams shall not be less than the gross area of the tension flanges, but the stress per square inch of gross area shall not exceed

$$16,000 - 150 \frac{l}{b}$$

in which

l = the length of the unsupported flange, between lateral connections or knee braces

b = the flange width.

(5) DETAILS OF DESIGN

49. *Limiting Lengths of Members.*—The ratio of length to least radius of gyration shall not exceed 100 for main compression members nor 120 for wind and sway bracing.

50. The lengths of riveted tension members shall not exceed 200 times their least radius of gyration.

51. *Depth Ratios.*—The depth of trusses preferably shall be not less than one-tenth of the span. The depth of plate girders preferably shall be not less than one-twelfth of the span. The depth of rolled beams used as girders and the depth of solid floors preferably shall be not less than one-fifteenth of the span. If less depths than these are used, the section must be increased so that the maximum deflection will not be greater than if these limiting ratios had not been exceeded.

52. *Parts Accessible.*—Details shall be designed so that all parts will be accessible for inspection, cleaning and painting. Closed sections shall be avoided wherever possible.

53. *Pockets*.—Pockets or depressions which would hold water shall have efficient drain holes, or shall be filled with concrete.

54. *Eccentric Connections*.—Members shall be connected so that their gravity axes will intersect in a point. Eccentric connections shall be avoided if practicable, but, if unavoidable, the members shall be proportioned so that the combined fiber stress will not exceed the allowed axial stress.

55. *Effective Area of Angles*.—The effective area of single angles in tension shall be assumed as the net area of the connected leg plus 50 per cent of the area of the unconnected leg. Single angles connected by lug angles shall be considered as connected by one leg.

56. *Counters*.—If web members are subject to reversal of stress, their end connections preferably shall be riveted. Adjustable counters shall have open turnbuckles.

57. *Strength of Connections*.—Connections shall have a strength at least equal to that of the members connected, regardless of the computed stress. Connections shall be made, as nearly as practicable, symmetrical about the axis of the members.

58. *Limiting Thickness of Metal*.—Metal shall not be less than $\frac{3}{8}$ in. thick, except for fillers. Metal subject to marked corrosive influences shall be increased in thickness or protected against such influences.

59. *Sizes of Rivets*.—Rivets shall be $\frac{3}{4}$ in., $\frac{7}{8}$ in. or 1 in. in diameter as specified.

60. *Pitch of Rivets*.—The minimum distance between centers of rivet holes shall be three diameters of the rivet, but the distance preferably shall be not less than $3\frac{1}{2}$ in. for 1-in. rivets, 3 in. for $\frac{7}{8}$ -in. rivets and $2\frac{1}{2}$ in. for $\frac{3}{4}$ -in. rivets. The maximum pitch in the line of stress for members composed of plates and shapes shall be 7 in. for 1-in. rivets, 6 in. for $\frac{7}{8}$ -in. rivets and 5 in. for $\frac{3}{4}$ -in. rivets. For angles with two gage lines and rivets staggered, the maximum pitch in each line shall be twice the amounts given above. If two or more web plates are used in contact, stitch rivets shall be provided to make them act in unison. In compression members, the stitch rivets shall be spaced not more than 24 times the thickness of the thinnest plate in the direction perpendicular to the line of stress, and not more than 12 times the thickness of the thinnest plate in the line of stress. In tension members, the stitch rivets shall be not more than 24 times the thickness of the thinnest outer plate in either direction. In tension members composed of two angles in contact, a pitch of 12 in. may be used for riveting the angles together.

61. *Edge Distance*.—The minimum distance from the center of any rivet hole to a sheared edge shall be: $1\frac{3}{4}$ in. for 1-in. rivets, $1\frac{1}{2}$ in. for $\frac{7}{8}$ -in. rivets and $1\frac{1}{4}$ in. for $\frac{3}{4}$ -in. rivets; to a rolled edge $1\frac{1}{2}$ in., $1\frac{1}{4}$ in. and $1\frac{1}{8}$ in., respectively. The maximum distance from any edge shall be eight times the thickness of the plate, but shall not exceed 6 in.

62. *Size of Rivets in Angles*.—The diameter of the rivets in any angle whose size is determined by calculated stress shall not exceed one-fourth of the width of the leg in which they are driven. In angles whose size is not so determined 1-in. rivets may be used in $3\frac{1}{2}$ -in. legs, $\frac{7}{8}$ -in. rivets in 3-in. legs, and $\frac{3}{4}$ -in. rivets in $2\frac{1}{2}$ -in. legs.

63. *Long Rivets*.—Rivets which carry calculated stress and whose grip exceeds four and one-half diameters shall be increased in number at least one per cent for each additional $\frac{1}{16}$ in. of grip. If the grip exceeds six times the diameter of the rivet, specially designed rivets shall be used.

64. *Pitch of Rivets at Ends*.—The pitch of rivets at the ends of built compression members shall not exceed four diameters of the rivet for a distance equal to one and one-half times the maximum width of the member.

65. *Compression Members*.—In built compression members, the metal shall be concentrated in the webs and flanges. The thickness of each web shall be not less than one-thirtieth of the distance between the lines of rivets connecting it to the flanges. The thickness of cover plates shall be not less than one-fortieth of the distance between the nearest rivet lines.

66. *Outstanding Legs of Angles*.—The width of the outstanding legs of angles in compression (except when reinforced by plates) shall not exceed the following:

- (a) For stringer flange angles, ten times the thickness.
- (b) For main members carrying axial stress, twelve times the thickness.
- (c) For bracing and other secondary members, fourteen times the thickness.

67. *Stay Plates*.—The open sides of compression members shall be provided with lacing bars and shall have stay plates as near each end as practicable. Stay plates shall be provided at intermediate points where the lacing is interrupted. In main members, the length

of the stay plates shall be not less than $1\frac{1}{4}$ times the distance between the lines of rivets connecting them to the outer flanges, and the length of intermediate stay plates shall be not less than three-quarters of that distance. Their thickness shall be not less than one-fiftieth of the same distance.

68. Tension members composed of shapes shall have their separate segments stayed together. The stay plates shall have a length not less than two-thirds of the lengths specified for stay plates on compression members.

69. *Lacing*.—The lacing of compression members shall be proportioned to resist a shearing stress of $2\frac{1}{2}$ per cent of the direct stress. The minimum width of lacing bars shall be 3 in. for 1-in. rivets, $2\frac{3}{4}$ in. for $\frac{7}{8}$ -in. rivets, $2\frac{1}{2}$ in. for $\frac{3}{4}$ -in. rivets, and 2 in. for $\frac{5}{8}$ -in. rivets. The thickness shall be made as required by Art. 38, in which "l" shall be taken as the distance between connections to the main sections.

70. In members composed of side segments and a cover plate, with the open side laced, one-half the shear shall be considered as taken by the lacing. Where double lacing is used, the shear in the plane of the lacing shall be equally distributed between the two systems.

71. Lacing bars of compression members shall be so spaced that the $\frac{l}{r}$ of the portion of the flange included between their connections will be not greater than 40, and not greater than two-thirds of the $\frac{l}{r}$ of the member.

72. In connecting lacing bars to flanges, $\frac{5}{8}$ -in. rivets shall be used for flanges less than $2\frac{1}{2}$ in. wide, $\frac{3}{4}$ -in. rivets for flanges from $2\frac{1}{2}$ to $3\frac{1}{2}$ in. wide, and $\frac{7}{8}$ -in. rivets for flanges $3\frac{1}{2}$ or more inches wide. Lacing bars with at least two rivets in each end shall be used for flanges over 5 in. wide.

73. The angle of lacing bars with the axis of the member shall be not less than 45 degrees for double lacing, and 60 degrees for single lacing. If the distance between rivet lines in the flanges is more than 15 in. and a single-rivet bar is used, the lacing shall be double and riveted at the intersections.

74. *Splices*.—Abutting joints in compression members faced for bearing shall be spliced on four sides. The gross area of the splice material shall be not less than 50 per cent of the gross area of the smaller member.

75. Joints in riveted work not faced for bearing, whether in tension or compression, shall be fully spliced.

76. *Net Section at Pins*.—In pin connected riveted tension members, the net section across the pin hole shall be not less than 140 per cent and the net section back of the pin hole not less than 100 per cent of the net section of the body of the member, and there shall be sufficient rivets to make the material effective.

77. *Net Section Defined*.—The net section of riveted members shall be the least area which can be obtained by deducting from the gross sectional area the areas of holes cut by any plane perpendicular to the axis of the member and parts of the areas of other holes on one side of the plane within a distance of 4 in., which are on gage lines 1 in. or more from those of the holes cut by the plane, the parts being determined by the formula

$$A\left(1 - \frac{P}{4}\right)$$

in which

A = the area of the hole.

P = the distance in inches of the center of the hole from the plane.

78. In determining the net section, the diameter of the rivet hole shall be taken $\frac{3}{8}$ in. larger than the nominal diameter of the rivet.

79. *Pin Plates*.—Where necessary to give the required section or bearing area, pin holes shall be reinforced on each segment by plates, one of which on each side must be as wide as the outstanding flanges will permit. These plates shall contain enough rivets and be so connected as to transmit and distribute the bearing pressure uniformly over the full cross-section and to reduce the eccentricity of the segment to a minimum. At least one full-width plate on each segment shall extend to the far edge of the stay plate and the others not less than 6 in. beyond the near edge.

80. *Indirect Splices*.—If splice plates are not in direct contact with the parts which they connect, rivets shall be used on each side of the joint in excess of the number required in the case of direct contact to the extent of two extra lines for each intervening plate.

81. *Fillers*.—Where rivets carrying stress pass through fillers, the fillers shall be extended beyond the connected member and the extension secured by additional rivets sufficient to develop the value of the filler.

82. *Forked Ends*.—Forked ends on compression members will be permitted only where unavoidable. Where forked ends are used, a sufficient number of pin plates shall be provided to make the jaws of twice the sectional area of the member and they shall be extended as far as necessary in order to carry the stress of the main member into the jaws, but shall not be shorter than required by Art. 79.

83. *Pins*.—Pins shall be long enough to secure a full bearing of all parts connected upon the turned body of the pin. They shall be secured by chambered nuts or by solid nuts with washers. Where the pins are bored, through rods with cap washers may be used. The screw ends shall be long enough to admit of burring the threads.

84. Pin-connected members shall be held against lateral movement on the pins.

85. *Bolts*.—Where members are connected by bolts, the turned bodies of the bolts shall be long enough to extend through the metal. A washer at least $\frac{1}{4}$ in. thick shall be used under the nut. Bolts shall not be used except by special permission.

86. *Upset Ends*.—Bars with screw ends shall be upset so that the area at the root of the thread will be at least 15 per cent larger than in the body of the bar.

87. *Sleeve Nuts*.—Sleeve nuts shall not be used.

88. *Expansion*. Provision shall be made for expansion and contraction at the rate of one inch for every 100 ft. in length. The expansion ends shall be secured against lateral movement. In spans more than 250 ft. in length, provision shall be made for expansion in the floor.

89. *Expansion Bearings*.—Spans more than 70 ft. in length shall have rollers at one end. Spans of less length shall be arranged to slide on smooth surfaces.

90. *Fixed Bearings*.—Bearings and ends of spans shall be secured against lateral motion.

91. *Rollers*.—Expansion rollers shall be not less than 6 in. in diameter. They shall be coupled together with substantial side bars, which shall be so arranged that the rollers can be cleaned readily. Rollers shall be geared to the upper and lower plates.

92. *Pedestals and Shoes*.—Pedestals and shoes preferably shall be made of cast steel. The difference between the top and bottom bearing widths shall not exceed twice the depth. For hinged bearings, the depth shall be measured from the center of the pin. Where built pedestals and shoes are used, the web plates and the angles connecting them to the base plate shall be not less than $\frac{3}{4}$ in. thick. If the size of the pedestal permits, the webs shall be rigidly connected transversely. The minimum thickness of the metal in cast-steel pedestals shall be 1 in. Pedestals and shoes shall be so constructed that the load will be distributed uniformly over the entire bearing. Spans more than 70 ft. in length shall have hinged bearings at each end.

93. *Inclined Bearings*.—For spans on an inclined grade and without hinged bearings, the sole or masonry plates shall be beveled so that the masonry surfaces will be level.

94. *Name Plates*.—There shall be a name plate, showing in raised letters and figures the name of the manufacturer and the year of construction, bolted to the bridge near each end at a point convenient for inspection.

(6) FLOORS

95. *Types of Floors*.—Floors may consist of steel floor-beams and stringers, with timber cross-ties supporting the rails, or of one of the solid floor types.

96. *Floor Members*.—Floor members shall be designed with special reference to stiffness.

97. Specifications for plate girders shall apply to floor-beams and stringers.

98. *Spacing of Stringers*.—Stringers usually shall be spaced 6 ft. 6 in. c. to c. If four stringers are used under one track, each pair shall be spaced symmetrically about the rail.

99. *I-Beam Girders*.—Rolled beams supporting timber decks shall be arranged with not more than four, and preferably not less than two beams under each rail. The beams in each group shall be placed symmetrically about the rail, and shall be spaced sufficiently far apart to permit cleaning and painting. They shall be connected by solid web diaphragms near the ends and at intermediate points, spaced not over twelve times the flange width. Bearing plates shall be continuous under each group of beams. End stiffeners shall be used if required by the provisions of Art. 38.

100. *Floor-beam Connections.*—Floor-beams preferably shall be square to the girders or trusses. They shall be riveted directly to the girders or between the posts of through and deck truss spans.

101. *End Connection Angles.*—The legs of stringer connection angles shall be not less than 4 in. in width, and not less than $\frac{5}{8}$ in. in thickness before facing. Shelf angles shall be provided to support the stringers during erection, but the connection angles shall be sufficient to carry the whole load. Stringers in through spans shall be riveted between the floor-beams.

102. *Stringer Frames.*—Where two lines of stringers are used under each track in panels more than 20 ft. in length, they shall be connected by cross frames.

103. *Solid Floor Connections.*—Solid floors shall be connected to the girders or trusses by angles not less than $\frac{5}{8}$ in. thick if to be faced, or $\frac{1}{2}$ in. thick if not to be faced, one angle on each side of the web of I-beams and one on each of the vertical members of troughs. (223)

104. *Proportioning Solid Floors.*—Solid floors shall be proportioned by the moments of inertia of the sections, using the net sections including the compression side.

(7) BRACING

105. *Design of Bracing.*—Lateral, longitudinal and transverse bracing shall be composed of shapes with riveted connections. Lateral bracing shall have concentric connections to chords at end joints, and preferably throughout. The connections between the lateral bracing and the chords shall be designed to avoid, as far as practicable, any bending stress in the truss members.

106. When a double system of bracing is used, both systems may be considered simultaneously effective if the members meet the requirements, both as tension and compression members.

107. *Lateral Bracing.*—Bottom lateral bracing shall be provided in all bridges except deck plate girder spans less than 50 ft. long, from which it may be omitted. Continuous steel or concrete floors will be considered lateral bracing.

108. Top lateral bracing shall be provided in deck spans and in through spans having sufficient head room.

109. *Portal and Sway Bracing.*—Deck truss spans shall have vertical sway bracing at each panel point. They shall also have bracing in the planes of the end posts. The end reaction of the top lateral system shall be carried through the vertical end bent to the masonry.

110. Through truss spans shall have portal bracing, with knee braces, as deep as the specified clearance will allow.

111. Through truss spans shall have sway bracing at each intermediate panel point if the height of the trusses is such as to permit of a depth of 6 ft. or more for the bracing. When the height of the trusses will not permit of such depth, the top lateral struts shall be of the same depth as the chord and shall have knee braces.

112. *Cross-frames.*—Deck plate girder spans shall be provided with cross-frames at each end proportioned to resist centrifugal and lateral forces, and shall have intermediate cross-frames at intervals not exceeding 18 ft.

113. *Laterals.*—The smallest angle to be used in lateral bracing shall be $3\frac{1}{2} \times 3 \times \frac{5}{8}$ in. There shall be not less than three rivets at each end connection of the angles. Angles shall be connected at their intersections by plates.

114. *Clearance.*—Lateral bracing beneath the track shall be low enough to clear the ties.

(8) PLATE GIRDERS

115. *Spacing of Girders.*—The girders of deck bridges usually shall be spaced 6 ft. 6 in. between centers, except that:

(a) In single-track deck spans 75 or more ft. in length, the girders shall be spaced in accordance with paragraph 12, but not less than 7 ft. 6 in. between centers.

(b) In bridges on curves, the girders shall be spaced as shown on the plans.

116. *Design of Plate Girders.*—Plate girders shall be proportioned either by the moment of inertia of their net section including compression side; or by assuming that the flanges are concentrated at their centers of gravity. In the latter case, one-eighth of the gross section of the web, if properly spliced, may be used as flange section. For girders having unusual sections, the moment of inertia method shall be used.

117. *Flange Sections.*—The flange angles shall form as large a part of the area of the flange as practicable. Side plates shall not be used except when flange angles exceeding 1 in. in thickness otherwise would be required.

118. Flange plates shall be equal in thickness, or shall diminish in thickness from the flange angles outward. No plate shall have a thickness greater than that of the flange angles.

119. Where flange cover plates are used, one cover plate of the top flange shall extend the full length of the girder. Other flange plates shall extend at least 18 in. beyond the theoretical end.

120. *Thickness of Web Plates.*—The thickness of web plates shall be not less than $\frac{1}{20}\sqrt{D}$, where D represents the distance between flanges in inches.

121. *Flange Rivets.*—The flanges of plate girders shall be connected to the web with a sufficient number of rivets to transfer to the flange section the horizontal shear at any point combined with any load that is applied directly on the flange. One wheel load, where ties rest on the flange, shall be assumed to be distributed over 3 ft.

122. *Flange Splices.*—Splices in flange members shall not be used except by special permission of the Engineer. Two members shall not be spliced at the same cross-section and, if practicable, splices shall be located at points where there is an excess of section. The net section of the splice shall exceed by 10 per cent the net section of the member spliced. Flange angle splices shall consist of two angles, one on each side.

123. *Web Splices.*—Web plates shall be symmetrically spliced by plates on each side. The splice plates for shear shall be of the full depth of the girders between flanges. The splice shall be equal to the web in strength in both shear and moment. There shall be not less than two rows of rivets on each side of the joint.

124. *End Stiffeners.*—Plate girders, shall have stiffener angles over end bearings, the outstanding legs of which will extend as nearly as practicable to the outer edge of the flange angles. These end stiffeners shall be proportioned for bearing of the outstanding legs on the flange angles, and shall be arranged to transmit the end reaction to the pedestals or distribute it over the masonry bearings. They shall be connected to the web by enough rivets to transmit the reaction. End stiffeners shall not be crimped.

125. *Intermediate Stiffeners.*—The webs of plate girders shall be stiffened by angles at intervals not greater than:

(a) Six feet.

(b) The depth of the web.

(c) The distance given by the formula $d = \frac{t}{40}(12,000 - S)$.

d = the distance between rivet lines of stiffeners in inches.

t = the thickness of the web in inches.

S = web shear in pounds per square inch at the point considered.

126. If the depth of the web between the flange angles or side plates is less than 50 times the thickness of the web, intermediate stiffeners may be omitted.

127. Stiffener angles shall be placed at points of concentrated loading. Such angles shall not be crimped.

128. Intermediate stiffeners shall be riveted in pairs to the web of the girder. The outstanding leg of each angle shall not be less than 2 in. plus one-thirtieth of the depth of the girder, nor more than 16 times its thickness.

129. *Gusset Plates in Through Girders.*—In through plate girder spans, the top flanges shall be braced by means of gusset plates or knee-braces with solid webs connected to the floor-beams and extending usually to the clearance line. If the unsupported length of the inclined edge of the gusset plate exceeds 18 in., the gusset plate shall have one or two stiffening angles riveted along its edge. The gusset plate shall be riveted to a stiffener angle on the girder. Preferably it shall form no part of the floor-beam web.

130. In through plate girder spans with solid floors, there shall be knee-braces with $\frac{3}{8}$ -in. webs, extending usually to the clearance line, at intervals of about 12 ft. Each knee-brace shall be well riveted to the floor and the girder, especially at the top, and shall have its edge reinforced by one or two angles.

131. *Ends of Through Girders.*—If through plate girders project 2 ft. or more above the base of the rail, the upper corners shall be rounded. In multiple span bridges, usually

only the extreme ends shall be rounded. Exposed ends of through girders shall be neatly finished with end plates.

132. *Spans Shipped Riveted.*—Deck plate girder spans less than 50 ft. in length shall be shipped riveted complete, unless otherwise specified.

133. *Masonry Bearings.*—End bearings on masonry preferably shall be raised above the coping by metal pedestals.

134. Sole plates shall be not less than $\frac{3}{4}$ -in. thick and no less in thickness than the flange plus $\frac{1}{8}$ -in. Preferably they shall not be longer than 18 in.

135. *Anchor Bolts.*—Anchor bolts shall be $1\frac{1}{4}$ -in. in diameter and shall extend 12 in. into the masonry. There shall be washers under the nuts. Anchor bolt holes in pedestals and sole plates shall be $1\frac{1}{8}$ in. in diameter, except that at expansion points the holes in the sole plates shall be slotted.

(9) TRUSSES

136. *Type of Truss and Sections of Members.*—Trusses shall have single intersection web systems and, preferably, inclined end posts. The top chords and end posts shall be made usually of two side segments with one cover plate and with stay plates and lacing on the open side. The bottom chords of riveted trusses shall be symmetrically made, usually of vertical side plates with flange angles. Web members shall be made of symmetrical sections.

137. *Camber.*—The length of members of truss spans shall be such that the camber will be equal to the deflection produced by the combined dead and live loads without impact.

138. *Riveted Members in Pin-connected Trusses.*—In pin-connected trusses, hip verticals (and members performing similar functions) and, in single track spans, the two panels at each end of the bottom chords shall be riveted members.

139. *Eye bars.*—The cross-sectional area of the head through the center of the pin hole shall exceed that of the body of the eye bar by at least $37\frac{1}{2}$ per cent. The thickness of the bar shall be not less than one-eighth of the width nor less than 1 in., and not greater than 2 in. The form of the head shall be submitted to the Engineer for approval before the bars are made. The diameter of the pin shall be not less than seven-eighths of the width of the widest bar attached.

140. *Packing.*—The eye bars of a set shall be packed symmetrically about the plane of the truss and as nearly parallel as practicable, but in no case shall the inclination of any bar to the plane of the truss exceed $\frac{1}{16}$ in. per foot. They shall be packed as closely as practicable. They shall be held against lateral movement, and arranged so that adjacent bars in the same panel will not be in contact.

141. *Gusset Plates.*—The thickness of gusset plates connecting the chords and web members of the truss shall be proportionate to the stress to be transferred, but shall not be less than $\frac{1}{2}$ -in.

142. *Facilities for Lifting Span.*—Provision shall be made for lifting the span at the ends.

143. *Masonry Plates.*—Masonry plates shall not be less than 1 in. thick.

(10) VIADUCTS

144. *Type of Viaduct.*—Viaducts shall consist usually of alternate tower spans and free spans of plate girders or riveted trusses supported on bents. The tower spans usually shall be not less than 30 ft. long.

145. *Bents and Towers.*—Viaduct bents shall be composed preferably of two supporting columns, and the bents usually shall be united in pairs to form towers. Horizontal diagonal bracing shall be placed in all towers having more than two vertical panels at alternate intermediate panel points. In double track towers provision shall be made for the transmission of the longitudinal force to both sides.

146. *Single Bents.*—Where long spans are supported on short single bents, such bents shall have hinged ends, or else have their columns and anchorages proportioned to resist the bending stresses produced by changes in temperature.

147. *Bottom Struts.*—The bottom struts of viaduct towers shall be proportioned for the calculated stresses, but in no case for less than one-fourth of the dead load reaction on one pedestal, considered as compressive stress. Provision shall be made in the column bearings for expansion of the tower bracing.

148. *Batter*.—The columns usually shall have a batter transversely of one horizontal to six vertical for single track viaducts, or one horizontal to eight vertical for double track viaducts.

149. *Depth of Girders*.—The depths of girders in viaducts preferably shall be uniform.

150. *Spacing of Girders*.—In single track viaducts, the girder spacing usually shall be uniform throughout, and shall be determined by the spacing for the longest span in the viaduct, according to the rules specified for deck plate girder spans.

151. In double track viaducts, the girders under each track usually shall be spaced 6 ft. 6 in. between centers, and the inner lines of girders shall be supported by cross-girders framed between and riveted to the posts.

152. *Girder Connections and Bracing*.—Girders of tower spans shall be fastened at each end to the tops of the posts or cross-girders. Girders between towers shall have one end riveted, and shall be provided with an effective expansion joint at the other end. No bracing or sway frame shall be common to abutting spans.

153. If neither of the girders under a track rests directly over a tower post, bracing shall be provided to carry the longitudinal force into the tower bracing without producing lateral bending stress in the cross-girders or posts.

154. *Sole and Masonry Plates*.—Sole and masonry plates shall be not less than $\frac{3}{4}$ -in. thick.

155. *Anchorage for Towers*.—Anchor bolts for viaduct towers and similar structures shall be designed to engage a mass of masonry the weight of which is at least one and one-half times the uplift.

(11) MATERIALS¹

(a) STRUCTURAL AND RIVET STEEL

156. *Process*.—Structural and rivet steel shall be made by the open-hearth process.

157. *Properties*.—Test specimens of structural and rivet steel shall (except as modified in Arts. 160, 163 and 164) conform to the following requirements as to chemical and physical properties:

	STRUCTURAL STEEL	RIVET STEEL
Phosphorus, maximum		
Acid.....	0.06 per cent	0.04 per cent
Basic.....	0.04 per cent	0.04 per cent
Sulphur, maximum.....	0.05 per cent	0.045 per cent
Tensile strength, lb. per sq. in.....	55,000 to 65,000	46,000 to 56,000
Yield point, lb. per sq. in., minimum.....	30,000	25,000
Elongation in 8 in., minimum, per cent.	1,500,000	1,500,000
	Tens. Str.	Tens. Str.

158. *Ladle Analyses*.—An analysis of each melt of steel shall be made by the manufacturer to determine the percentages of carbon, manganese, phosphorus and sulphur. This analysis shall be made from a test ingot taken during the pouring of the melt. The chemical composition thus determined shall be reported to the Engineer.

159. *Check Analyses*.—Analyses may be made by the Engineer from finished material representing each melt. The phosphorus and sulphur content thus determined shall not exceed that specified in Art. 157 by more than 25 per cent.

160. *Specimen Tension Tests of Eye-bar Material*.—In order to meet the minimum tensile strength of full size annealed eye bars required in Art. 284, the Contractor may determine the tensile strength to be obtained in specimen tests, the range not to exceed 14,000 lb. per sq. in. and the maximum not to exceed 74,000 lb. per sq. in. The material shall conform to the requirements as to physical properties other than that of tensile strength as specified in Arts. 157, 163 and 166.

161. *Yield Point*.—The yield point shall be determined by the drop of the beam of the testing machine.

162. *Speed of Testing Machine*.—The cross-head speed of the testing machine shall be such that the beam of the machine can be kept balanced, but in no case shall the values given in the following table be exceeded:

¹ Specifications for materials conform to A. S. T. M. Standards, Serials A7-16, A27-16 and A-48-18 except as to the yield point requirements and Arts. 178 and 179, and the footnote to Table II.

Gage length of specimen	Maximum cross-head speed (inches per minute) in determining	
	Yield point	Tensile strength
2 in.	0.5	2.0
8 in.	2.0	6.0

163. *Modifications in Elongation.*—For structural steel over $\frac{3}{4}$ in. in thickness, a deduction of one from the percentage of elongation in 8 in. specified in Art. 157 shall be made for each increase of $\frac{1}{8}$ in. in thickness above $\frac{3}{4}$ in., to a minimum of 18 per cent.

164. For structural steel under $\frac{5}{16}$ in. in thickness, a deduction of 2.5 from the percentage of elongation in 8 in. specified in Art. 157 shall be made for each decrease of $\frac{1}{16}$ in. in thickness below $\frac{5}{16}$ in.

165. *Bend Tests.*—The test specimens for plates, shapes, and bars (except as specified in Arts 166, 167 and 168) shall bend cold through 180 degrees without cracking on the outside of the bent portion, as follows:

(a) For material $\frac{3}{4}$ in. or less in thickness, flat on itself.

(b) For material more than $\frac{3}{4}$ in. to and including $1\frac{1}{4}$ in. in thickness, around a pin the diameter of which is equal to the thickness of the specimen.

(c) For material more than $1\frac{1}{4}$ in. in thickness, around a pin the diameter of which is equal to twice the thickness of the specimen.

166. The test specimens for eye-bar flats shall bend cold through 180 degrees without cracking on the outside of the bent portion as follows:

(a) For material $\frac{3}{4}$ in. or less in thickness, around a pin the diameter of which is equal to the thickness of the specimen.

(b) For material more than $\frac{3}{4}$ in. to and including $1\frac{1}{4}$ in. in thickness, around a pin the diameter of which is equal to twice the thickness of the specimen.

(c) For material more than $1\frac{1}{4}$ in. in thickness, around a pin the diameter of which is equal to three times the thickness of the specimen.

167. The test specimens for pins, rollers and other bars, when prepared as specified in Art. 173, shall bend cold through 180 degrees around a 1-in. pin without cracking on the outside of the bent portion.

168. The test specimens for rivet steel shall bend cold through 180 degrees flat on themselves without cracking on the outside of the bent portion.

169. *Test Specimens.*—Tension and bend test specimens shall be taken from rolled steel in the condition in which it comes from the rolls, except as specified in Art. 170.

170. Tension and bend test specimens for pins and rollers shall be taken from the finished bars after annealing when annealing is specified.

171. Tension and bend test specimens for plates, shapes and bars (except as specified in Arts. 172, 173 and 174) shall be of the full thickness of material as rolled. They may be machined to the form and dimensions shown in Fig. 4, or with both edges parallel, except that bend test specimens for eye-bar flats may have three rolled sides.

172. Tension and bend test specimens for plates and tension test specimens for eye-bar flats more than $1\frac{1}{2}$ in. in thickness may be machined to a thickness or diameter of at least $\frac{3}{4}$ in. for a length of at least 9 in.

173. Tension test specimens for pins, rollers, and bars (except eye-bar flats) over $1\frac{1}{2}$ in. in thickness or diameter may conform to the dimensions shown in Fig. 5. In this case, the ends shall be of a form to fit the holders of the testing machine in such a way that the load will be axial. Bend test specimens may be $1 \times \frac{1}{2}$ in. in section. The axis of the specimen shall be located at any point midway between the center and surface and shall be parallel with the axis of the bar.

Note.—The gage length, parallel portions and fillets shall be as shown, but the ends may be of any form which will fit the holders of the testing machine.

174. Tension and bend test specimens for rivet steel shall be of the full-size section of the bars as rolled.

175. *Number of Tests.*—One tension and one bend test shall be made from each melt, except that if material from one melt differs $\frac{3}{8}$ in. or more in thickness, one tension and one bend test shall be made from both the thickest and the thinnest material rolled.

176. If any test specimen shows defective machining or develops flaws, it may be discarded and another specimen substituted.

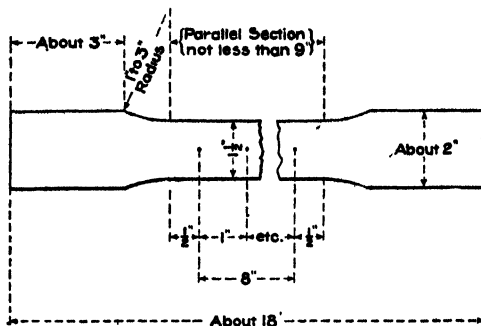

FIG. 4.

177. If the percentage of elongation of any tension test specimen is less than that specified in Art. 157, and any part of the fracture is more than $\frac{3}{4}$ in. from the center of the gage length of a 2-in. specimen or is outside the middle third of the gage length of an 8-in. specimen, as indicated by scribe scratches marked on the specimen before testing, a retest shall be allowed.

178. *Character of Fracture.*—Test specimens of structural or rivet steel shall show a fracture of uniform silky or bluish gray appearance, entirely free from visible slag inclusions or other foreign substances.

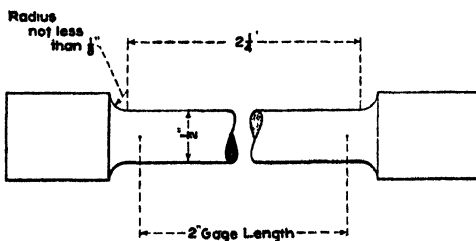

FIG. 5.

179. *Surface Defects.*—Finished rolled material shall be free from cracks, flaws, injurious seams, blisters, ragged and imperfect edges, and other surface defects. It shall have a smooth finish, and shall be straightened in the mill before shipment.

180. *Permissible Variations in Weight and Thickness.*—The cross-section or weight of each piece of steel shall not vary more than 2.5 per cent from that specified, except in the case of sheared plates, which shall be covered by the following permissible variations. One cubic inch of rolled steel is assumed to weigh 0.2833 lb.

(a) When ordered to weight per square foot, the weight of each lot in each shipment shall not vary from the weight ordered more than the amount given in Table I. The term "lot" as applied to Table I means all of the plates of each group width and group weight.

(b) When ordered to thickness, the thickness of each plate shall not vary more than 0.01 in. under that ordered. The overweight of each lot in each shipment shall not exceed the amount given in Table II. The term "lot" as applied to Table II means all of the plates of each group width and group thickness.

181. *Marking.*—The name or brand of the manufacturer and the melt number shall be legibly stamped or rolled on all finished material, except that rivet and lattice bars and other

small sections shall, when loaded for shipment, be separated properly and marked for identification. The identification marks shall be stamped legibly on the end of each pin and roller. The melt number shall be marked legibly by stamping if practicable, on each test specimen.

TABLE I.—PERMISSIBLE VARIATIONS OF PLATES ORDERED TO WEIGHT

Ordered weight (lb. per sq. ft.)	Permissible variations in average weights per square foot of plates for widths given, expressed in percentages of ordered weights																	
	Under 48 in.		48 to 60 in., excl.		60 to 72 in., excl.		72 to 84 in., excl.		84 to 96 in., excl.		96 to 108 in., excl.		108 to 120 in., excl.		120 to 132 in., excl.		132 in. or over	
	Over	Under	Over	Under	Over	Under	Over	Under	Over	Under	Over	Under	Over	Under	Over	Under	Over	Under
Under 5.....	5.0	3.0	5.5	3.0	6.0	3.0	7.0	3.0										
5.0 to 7.5, excl.....	4.5	3.0	5.0	3.0	5.5	3.0	6.0	3.0										
7.5 to 10.0, excl.....	4.0	3.0	4.5	3.0	5.0	3.0	5.5	3.0	6.0	3.0	7.0	3.0	8.0	3.0				
10.0 to 12.5, excl.....	3.5	2.5	4.0	3.0	4.5	3.0	5.0	3.0	5.5	3.0	6.0	3.0	7.0	3.0	8.0	3.0	9.0	3.0
12.5 to 15.0, excl.....	3.0	2.5	3.5	2.5	4.0	3.0	4.5	3.0	5.0	3.0	5.5	3.0	6.0	3.0	7.0	3.0	8.0	3.0
15.0 to 17.5, excl.....	2.5	2.5	3.0	2.5	3.5	2.5	4.0	3.0	4.5	3.0	5.0	3.0	5.5	3.0	6.0	3.0	7.0	3.0
17.5 to 20.0, excl.....	2.5	2.0	2.5	2.5	3.0	2.5	3.5	2.5	4.0	3.0	4.5	3.0	5.0	3.0	5.5	3.0	6.0	3.0
20.0 to 25.0, excl.....	2.0	2.0	2.5	2.0	2.5	2.5	3.0	2.5	3.5	2.5	4.0	3.0	4.5	3.0	5.0	3.0	5.5	3.0
25.0 to 30.0, excl.....	2.0	2.0	2.0	2.0	2.5	2.0	2.5	2.5	3.0	2.5	3.5	3.0	4.0	3.0	4.5	3.0	5.0	3.0
30.0 to 40.0, excl.....	2.0	2.0	2.0	2.0	2.0	2.0	2.5	2.0	2.5	2.5	3.0	2.5	3.5	3.0	4.0	3.0	4.5	3.0
40.0 or over.....	2.0	2.0	2.0	2.0	2.0	2.0	2.0	2.0	2.5	2.0	2.5	2.5	3.0	2.5	3.5	3.0	4.0	3.0

Note.—The weight per square foot of individual plates shall not vary from the ordered weight by more than 1½ times the amount given in this table.

TABLE II.—PERMISSIBLE OVERWEIGHTS OF PLATES ORDERED TO THICKNESS

Ordered thickness (in.)	Permissible excess in average weights per square foot of plates for widths given, expressed in percentages of nominal weights								
	Under 48 in.	48 to 60 in., excl.	60 to 72 in., excl.	72 to 84 in., excl.	84 to 96 in., excl.	96 to 108 in., excl.	108 to 120 in., excl.	120 to 132 in., excl.	132 in. or Over
Under ¼	9.0	10.0	12.0	14.0					
¼ to ⅜, excl.....	8.0	9.0	10.0	12.0					
⅜ to ½, excl.....	7.0	8.0	9.0	10.0	12.0				
½ to ⅝, excl.....	6.0	7.0	8.0	9.0	10.0	12.0	14	16	19
⅝ to ¾, excl.....	5.0	6.0	7.0	8.0	9.0	10.0	12	14	17
¾ to ⅞, excl.....	4.5	5.0	6.0	7.0	8.0	9.0	10	12	15
⅞ to 1, excl.....	4.0	4.5	5.0	6.0	7.0	8.0	9	10	13
1 to 1¼, excl.....	3.5	4.0	4.5	5.0	6.0	7.0	8	9	11
1¼ to 1½, excl.....	3.0	3.5	4.0	4.5	5.0	6.0	7	8	9
1½ to 1¾, excl.....	2.5	3.0	3.5	4.0	4.5	5.0	6	7	8
1¾ to 2, excl.....	2.5	2.5	3.0	3.5	4.0	4.5	5	6	7

Note.—The weight of individual plates ordered to thickness shall not exceed the nominal weight by more than 1½ times the amount given in this table.

(b) CAST STEEL

182. Process.—Cast steel shall be made by the open-hearth or the crucible process.

183. Heat Treatment.—Castings shall be annealed.

184. *Chemical and Physical Properties.*—Test specimens of cast steel shall conform to the following requirements as to chemical composition and tensile properties:

Elements considered	Min. ten. strength, (lb. per sq. in.)	Min. yield point (lb. per sq. in.)	Min. elongation in 2 in. (per cent)	Min. reduction of area (per cent)
Phosphorus not over 0.05 per cent.	60,000	30,000	22	30
Sulphur not over 0.05 per cent.				

185. *Ladle Analyses.*—An analysis of each melt of steel shall be made by the manufacturer to determine the percentages of carbon, manganese, phosphorus and sulphur. This analysis shall be made from drillings taken at least $\frac{1}{4}$ in. beneath the surface of a test ingot obtained during the pouring of the melt. The chemical composition thus determined shall be reported to the Engineer.

186. *Check Analyses.*—Check analyses may be made by the Engineer from a broken tension or bend test specimen. The phosphorus and sulphur content thus determined shall not exceed that specified in Art. 184 by more than 20 per cent. Drillings for analysis shall be taken not less than $\frac{1}{4}$ in. beneath the surface.

187. *Yield Point.*—The yield point shall be determined by the drop of the beam of the testing machine. The speed of the machine shall conform to the requirements of Art. 162.

188. *Bend Test.*—The test specimen shall bend cold through 120 deg. around a 1-in. pin without cracking on the outside of the bent portion.

189. *Test Specimens.*—Sufficient test bars from which the test specimens required by Art. 192 may be selected, shall be attached to castings weighing 500 lb. or more, when the design of the castings will permit. If the castings weigh less than 500 lb. or are of such a design that test bars cannot be attached, two test bars shall be cast to represent each melt. Test bars shall be annealed with the castings they represent.

190. Tension test specimens shall conform to the dimensions shown in Fig. 6.

191. Bend test specimens shall be machined to 1 in. \times $\frac{1}{2}$ in. in section with corners rounded to a radius not over $\frac{1}{16}$ in.

192. *Number of Tests.*—One tension and one bend test shall be made from each annealing charge. If more than one melt is represented in the annealing charge, one tension and one bend test shall be made from each melt.

193. If the percentage of elongation of any tension test specimen is less than that specified in Art. 184 and any part of the fracture is more than $\frac{3}{4}$ in. from the center of the gage length, as indicated by scribe scratches marked on the specimen before testing, a retest shall be allowed.

194. If the results of the physical tests of any test lot do not conform to the requirements specified, the manufacturer may re-anneal such lot not more than twice and retests shall be made as specified in Art. 184.

195. *Workmanship and Finish at Foundry.*—The castings shall conform substantially to the drawings and shall be made in a workmanlike manner. The castings shall be free from injurious defects.

196. *Inspection at Foundry.*—Tests and inspection shall be made at the place of manufacture prior to shipment, and shall be so conducted as not to interfere unnecessarily with the operation of the works.

197. *Rejection.*—Castings which show injurious defects subsequent to their acceptance at the manufacturer's works will be rejected, and the manufacturer shall be notified.

(c) CAST IRON

198. *Process.*—Cast iron shall be of tough gray iron, and shall be made by the cupola process.

199. *Finish.*—Castings shall be true to pattern and free from excessive shrinkage. They shall be free from cracks, cold shuts, blow holes and other flaws.

200. *Chemical Composition.*—The sulphur content of cast iron shall not exceed the following:

Light castings.....	0.10 per cent
Medium castings.....	0.10 per cent
Heavy castings.....	0.12 per cent

Drillings taken from the fractured ends of the transverse test bars shall be used for the sulphur determinations. One determination shall be made from each set of bars.

201. *Classification*.—Castings shall be classified as light, medium and heavy.

(a) Light castings are those having any section less than $\frac{1}{2}$ in. thick.

(b) Heavy castings are those having no section less than 2 in. thick.

(c) Medium castings are those not included in either of the two classes above.

202. *Test Bar*.—Tests shall be made on the "Arbitration Test Bar" of the American Society for Testing Materials, as shown by Fig. 1, Serial A 48-18.

203. *Tension Tests*.—Tension tests will be made only when specified by the Engineer and at the expense of the Company.

204. *Number of Tests*.—Two sets of two test bars each shall be cast from each melt in thoroughly dried green sand moulds, one set from the first iron poured and the other set from the last iron poured. Where the melt exceeds 20 tons, an additional set of two bars shall be cast from each additional 20 tons or fraction thereof.

205. *Transverse Tests*.—A transverse test of each bar cast shall be made. The load shall be applied at the middle, and the supports shall be spaced 12 in. apart. The load on the test bar at rupture shall be not less than the following:

Light castings	2,500 lb.
Medium castings	2,900 lb.
Heavy castings	3,300 lb.

The deflection at rupture shall in no case be less than 0.10 in. The rate of application of the load shall be such that a central deflection of 0.10 is produced in from 20 to 40 seconds.

(12) WORKMANSHIP

206. *Class of Work*.—The work shall be "Punched Work" or "Reamed Work" as stipulated.

207. *General*.—The workmanship and finish shall be equal to the best general practice in modern bridge shops. Material at the shops shall be kept clean and protected from the weather as far as practicable.

208. *Straightening Material*.—Rolled material, before being laid off or worked, must be straight. If straightening or flattening is necessary, it shall be done by methods that will not injure the material. Sharp kinks and bends may be cause for rejection.

209. *Finish*.—Shearing and chipping shall be neatly and accurately done and all portions of the work exposed to view shall be neatly finished.

210. *Punched Work*.—In punched work, holes in material whose thickness is not greater than the diameter of the rivets plus $\frac{1}{8}$ in., may be punched full size. Holes in material of greater thickness shall be drilled.

211. *Reamed Work*.—In reamed work, holes in material $\frac{7}{8}$ in. thick and less, used for lateral, longitudinal and sway bracing, lacing, stay plates and diaphragms, may be punched full size.

212. Holes in other material $\frac{3}{4}$ in. thick and less, shall be sub-punched and reamed.

213. Holes in material more than $\frac{3}{4}$ in. thick shall be drilled.

214. *Punched Holes*.—Full size punched holes shall be $\frac{1}{16}$ in. larger than the nominal diameter of the rivets. The diameter of the die shall not exceed the diameter of the punch by more than $\frac{3}{32}$ in. If any holes must be enlarged to admit the rivets, they shall be reamed. Holes must be clean cut, without torn or ragged edges. Poor matching of holes may be cause for rejection.

215. *Sub-Punched and Reamed Holes*.—In sub-punched and reamed work, the holes shall be punched $\frac{3}{16}$ in. smaller and, after assembling, reamed $\frac{1}{16}$ in. larger than the nominal diameter of the rivet. The diameter of the punch used shall be $\frac{3}{16}$ in. smaller than the nominal diameter of the rivet and the diameter of the die not more than $\frac{3}{32}$ in. larger than the diameter of the punch. Outside burrs shall be removed with a tool making a $\frac{1}{16}$ -in. fillet.

216. *Accuracy of Punching in Reamed Work.*—In sub-punched and reamed work, the punching shall be so accurately done that, after assembling and before reaming, a cylindrical pin $\frac{1}{16}$ in. smaller in diameter than the nominal size of the punched hole may be entered, perpendicular to the face of the member, without drifting, in at least 75 of any group of 100 contiguous holes in the same plane. If this requirement is not fulfilled, the badly punched pieces shall be rejected. If any hole will not pass a pin $\frac{3}{16}$ in. smaller in diameter than the nominal size of the punched hole, this shall be cause for rejection.

217. *Reaming After Assembling.*—Reaming shall be done after the pieces forming a built member are assembled and so firmly bolted together that the surfaces are in close contact. Before riveting, they shall be taken apart, if necessary, and any shavings removed. When it is necessary to take the members apart for shipping or handling, the respective pieces reamed together shall be so marked that they may be reassembled in the same position in the final setting up. No interchange of reamed parts will be permitted.

218. *Accuracy of Reaming and Drilling.*—When holes are reamed or drilled, 85 of any group of 100 contiguous holes in the same plane shall, after reaming or drilling, show no offset greater than $\frac{1}{32}$ in. between adjacent thicknesses of metal.

219. *Reamed Holes.*—Reamed holes shall be cylindrical, perpendicular to the member, and not more than $\frac{3}{32}$ in. larger than the nominal diameter of the rivets. Reamers preferably shall not be directed by hand. Outside burrs shall be removed with a tool making a $\frac{1}{16}$ -in. fillet.

220. *Drilled Holes.*—Drilled holes shall be $\frac{1}{16}$ in. larger than the nominal size of the rivet. Burrs on the outside surfaces shall be removed.

221. *Assembling for Drilling.*—Connecting parts requiring drilled holes shall be assembled and securely held together while being drilled.

222. *Shop Assembling.*—The parts of riveted members shall be well pinned and firmly drawn together with bolts before riveting is commenced. The drifting done during assembling shall be only such as to bring the parts into position, and not sufficient to enlarge the holes or distort the metal. Surfaces in contact shall be painted. Bolts in field connection holes shall be left in place.

223. *Field Connections.*—Solid floor sections shall be assembled to the girders or trusses, or to suitable frames, in the shop, and the end connections made to fit (103).

224. In reamed work, riveted trusses and skew portals shall be assembled in the shop, the parts adjusted to line and fit, and the holes for field connections drilled or reamed while so assembled. Holes for other field connections, except those in lateral, longitudinal and sway bracing, shall be drilled or reamed in the shop with the connecting parts assembled, or else drilled or reamed to a metal template.

225. In punched work, the field connections (except those in lateral, longitudinal and sway bracing) shall be reamed to metal templates.

226. *Match-marking.*—Connecting parts assembled in the shop for the purpose of reaming or drilling holes in field connections shall be match-marked, and a diagram showing such marks shall be furnished the Engineer.

227. *Rivets.*—The size of rivets called for on the plans shall be the size of the rivet before heating.

228. Rivet heads, when not countersunk or flattened, shall be of approved shape and of uniform size for the same diameter of rivet. Rivet heads shall be full, neatly made, concentric with the rivet holes, and in full contact with the surface of the member.

229. *Riveting.*—Rivets shall be heated uniformly to a light cherry red and driven while hot. Rivets, when heated and ready for driving, shall be free from slag, scale and carbon deposit. When driven, they shall completely fill the holes. Loose, burned or otherwise defective rivets shall be replaced. In removing rivets, care shall be taken not to injure the adjacent metal, and, if necessary, they shall be drilled out. Caulking or re-cupping will not be permitted.

230 Rivets shall be driven by direct-acting riveters where practicable. The riveters shall retain the pressure after the upsetting is completed.

231. When necessary to drive rivets with a pneumatic riveting hammer, a pneumatic bucker shall be used for holding up, when practicable.

232. *Field Rivets.*—Field rivets shall be furnished in excess of the nominal number required to the amount of 15 per cent plus ten rivets, for each size and length.

233. Field rivets shall be carefully selected, and shall be free from fins on the under side of the head.

234. *Turned Bolts*.—Where turned bolts are used to transmit shear, the holes shall be reamed parallel and the bolts shall make a tight fit with the threads entirely outside of the holes. A washer not less than $\frac{1}{4}$ in. thick shall be used under each nut.

235. *Planing Sheared Edges*.—Sheared edges of material more than $\frac{5}{8}$ in. in thickness and carrying calculated stress shall be planed to a depth of $\frac{1}{4}$ in. Re-entrant cuts shall be filleted before cutting.

236. *Lacing Bars*.—The ends of lacing bars shall be neatly rounded, unless otherwise called for.

237. *Fit of Stiffeners*.—Stiffeners under the top flanges of deck girders and at all bearing points shall be milled or ground to bear against the flange angles. Other stiffeners must fit sufficiently tight against the flange angles to exclude water after being painted. Fillers and splice plates shall fit within $\frac{1}{4}$ in. at each end.

238. *Web plates*.—Web plates of girders which have no cover plates may be $\frac{1}{8}$ in. above or below the backs of the top flange angles. Web plates of girders which have cover plates may be $\frac{1}{2}$ in. less in width than the distance back to back of flange angles.

239. When web plates are spliced, not more than $\frac{3}{8}$ -in. clearance between ends of plates will be allowed.

240. *Facing Floor Beams, Stringers and Girders*.—Floor beams, stringers and girders having end connection angles shall be made of exact length after the connection angles are riveted. If facing is necessary, the thickness of the angles shall not be reduced more than $\frac{1}{8}$ in. at any point.

241. *Finished Members*.—Finished members shall be true to line and free from twists, bends and open joints.

242. *Abutting Joints*.—Abutting joints in compression members, and girder flanges, and, where so specified on the drawings, in tension members, shall be faced and brought to an even bearing. Where joints are not faced, the opening shall not exceed $\frac{1}{4}$ in.

243. *Eye bars*.—Eye bars shall be straight, true to size, and free from twists, folds in, the neck or head, and other defects. The heads shall be made by upsetting, rolling or forging. Welding will not be allowed. The form of the heads will be determined by the dies in use at the works where the eye bars are made, if satisfactory to the Engineer. The thickness of the head and neck shall not overrun more than $\frac{1}{16}$ in. for bars 8 in. or less in width, $\frac{1}{8}$ in. for bars more than 8 in. and not more than 12 in. in width, and $\frac{3}{16}$ in. for bars more than 12 in. wide.

244. Eye bars which are to be placed side by side in the structure shall be bored so accurately that, upon being placed together, the pins will pass through the holes at both ends at the same time without driving. Eye bars shall have both ends bored at the same time.

245. *Annealing*.—Eye bars shall be annealed by heating uniformly to the proper temperature followed by slow and uniform cooling. Proper instruments shall be provided for determining at all times the temperature of the bars.

246. Other steel which has been partially heated shall be properly annealed except where used in minor parts.

247. *Boring Pin Holes*.—Pin holes shall be bored true to gage, smooth, straight, at right angles with the axis of the member and parallel with each other, unless otherwise required. The variation from the specified distance from outside to outside of pin holes in tension members, or from inside to inside of pin holes in compression members, shall not exceed $\frac{1}{32}$ in. In built-up members the boring shall be done after the member is riveted.

248. *Boring Pins*.—Pins larger than 9 in. in diameter shall have a hole bored longitudinally through the center of each not less than 2 in. in diameter.

249. *Pin Clearances*.—The difference in diameter between the pin and the pin hole shall be $\frac{1}{50}$ in. for pins up to 5 in. in diameter, and $\frac{1}{32}$ in. for larger pins.

250. *Pins and Rollers*.—Pins and rollers shall be accurately turned to gage and shall be straight, smooth and free from flaws.

251. *Screw Threads*.—Screw threads shall make close fits in the nuts and shall be U. S. Standard, except that for pin ends of diameters greater than $1\frac{3}{8}$ in., they shall be made with six threads to an inch.

252. *Welds*.—Welds in steel will not be allowed, except to remedy minor defects.

253. *Forging Pins*.—Pins larger than 7 in. in diameter shall be forged and annealed.

254. *Bearing Surfaces Planed*.—The top and the bottom surfaces of base and cap plates of columns and pedestals, except those in contact with masonry, shall be planed, or hot-straightened, and parts of members in contact with them shall be faced to fit. Connection angles for base plates and cap plates shall be riveted to compression members before the members are faced.

255. Sole plates of plate girders shall have full contact with the girder flanges. Sole plates and masonry plates shall be planed or hot-straightened. Cast pedestals shall be planed on the surfaces in contact with steel and shall have the bottom surfaces resting on masonry rough finished.

256. *Pilot Nuts*.—Two pilot nuts and two driving nuts shall be furnished for each size of pin, unless otherwise specified.

(13) WEIGHING AND SHIPPING

257. *Weight Paid For*.—The payment for pound price contracts shall be based on the scale weight of the metal in the fabricated structure, including field rivets shipped. The weight of the field paint and cement, if furnished, boxes and barrels used for packing, and material used for staying or supporting members on cars, shall be excluded.

258. *Variation in Weight*.—If the weight of any member is more than $2\frac{1}{2}$ per cent less than the computed weight, it may be cause for rejection.

259. The greatest allowable variation of the total scale weight of any structure from the weights computed from the approved shop drawings shall be $1\frac{1}{2}$ per cent. Any weight in excess of $1\frac{1}{2}$ per cent above the computed weight shall not be paid for by the Company.

260. *Computed Weight*.—The weight of steel shall be assumed at 0.2833 lb. per cu. in.

261. The weights of rolled shapes, and of plates, up to and including 36 in. in width, shall be computed on the basis of their nominal weights and dimensions, as shown on the approved shop drawings, deducting for copes, cuts and open holes.

262. The weights of plates wider than 36 in. shall be computed on the basis of their dimensions, as shown on the approved shop drawings, deducting for cuts and open holes. To this shall be added one-half of the allowed percentages of overrun in weight given in Art 180.

263. The weight of heads of shop driven rivets shall be included in the computed weight.

264. The weights of castings shall be computed from the dimensions shown on the approved shop drawings, with an addition of 10 per cent for fillets and overrun.

265. *Weighting of Members*.—Finished work shall be weighed in the presence of the Inspector, if practicable. The Contractor shall furnish satisfactory scales and do the handling of the material for weighing.

266. *Marking and Shipping*.—Members weighing more than 5 tons shall have the weight marked thereon. Bolts and rivets of one length and diameter, and loose nuts or washers of each size, shall be packed separately. Pins, other small parts, and small packages of bolts, rivets, washers and nuts shall be shipped in boxes, crates, kegs or barrels, but the gross weight of any package shall not exceed 300 lb. A list and description of the contained material shall be plainly marked on the outside of each package, box or crate.

267. Long girders shall be so loaded and marked that they may arrive at the bridge site in position for erection without turning.

268. Anchor bolts, washers and other anchorage or grillage materials shall be shipped in time for them to be built into the masonry.

(14) SHOP PAINTING

269. *Shop Cleaning and Painting*.—Unless otherwise specified, steel work, after it has been accepted by the Inspector and before leaving the shop, shall be thoroughly cleaned and given one coat of approved paint, applied in a workmanlike manner and well worked into joints and open spaces. Cleaning shall be done with steel brushes, hammers, scrapers and chisels, or by other equally effective means. Oil, paraffin and grease shall be removed by wiping with benzine or gasoline. Loose dirt shall be brushed off with a dry bristle brush before the paint is applied.

270. *Surfaces in Contact.*—Surfaces coming in contact shall be cleaned and given one coat of paint on each surface before assembling.

271. *Erection Marks.*—Erection marks shall be painted on painted surfaces.

272. *Painting in Damp or Freezing Weather.*—Painting shall not be done in damp or freezing weather except under cover, and the steel must be free from moisture or frost when the paint is applied. Material painted under cover in damp or freezing weather shall be kept under cover until the paint is dry.

273. *Mixing of Paint.*—Paint shall be thoroughly mixed before applying, and the pigments shall be kept in suspension.

274. *Machine Finished Surfaces.*—Machine finished surfaces of steel (except abutting joints and base plates) shall be coated with white lead and tallow, applied hot as soon as the surfaces are finished and accepted by the Inspector.

(15) MILL AND SHOP INSPECTION

275. *Facilities for Inspection.*—Facilities for inspection of material and workmanship in the mill and shop shall be furnished by the Contractor to the Inspectors, and the Inspectors shall be allowed free access to the necessary parts of the premises.

276. *Mill Orders and Shippi^{ng} Statements.*—The Contractor shall furnish the Engineer with as many copies of material orders and shipping statements as the Engineer may direct. The weights of the individual members shall be shown.

277. *Notice of Rolling.*—The Contractor shall give ample notice to the Engineer of the beginning of rolling at the mill, and of work at the shop, so that inspection may be provided. No material shall be rolled nor work done before the Engineer has been notified where the orders have been placed.

278. *Cost of Testing.*—The Contractor shall furnish, without charge, test specimens, as specified herein, and all labor, testing machines and tools necessary to make the specimen and full size tests.

279. *Inspector's Authority.*—The Inspector shall have the power to reject materials or workmanship which do not come up to the requirements of these specifications; but in cases of dispute, the Contractor may appeal to the Engineer, whose decision shall be final.

280. *Rejections.*—The acceptance of any material or finished members by the Inspector shall not be a bar to their subsequent rejection, if found defective.

281. Rejected material and workmanship shall be replaced promptly or made good by the Contractor.

(16) FULL-SIZE TESTS

282. *Full-size Tests of Eye bars.*—The number and size of the bars to be tested shall be stipulated by the Engineer before the mill order is placed. The number shall not exceed 5 per cent of the whole number of bars ordered, with a minimum of two bars on small orders.

283. The test bars shall be of the same section as the bars to be used in the structure and of the same length if within the capacity of the testing machine. They shall be selected by the Inspector from the finished bars preferably after annealing. Test bars representing bars too long for the testing machine shall be selected from the full length bar material after the heads on one end have been formed and shall have the second head formed upon them after being cut to the greatest length which can be tested.

284. Full-size tests of eye bars shall show a yield point of not less than 29,000 lb. per sq. in., an ultimate strength of not less than 54,000 lb. per sq. in., and an elongation of not less than 10 per cent in a length of 20 ft. measured in the body of the bar. The fracture shall show a silky or finely granular structure throughout.

285. If a bar fails to meet the requirements of Art. 284, two additional bars of the same size and from the same mill heat shall be tested. If the failure of the first test bar is on account of the character of the fracture only, the bars represented by the test may be reannealed before the additional bars are tested.

286. If two of the three bars tested fail, the bars of that size and mill heat shall be rejected.

287. A failure in the head of a bar shall not be cause for rejection if the other requirements are fulfilled.

288. A record of the annealing charges shall be furnished the Engineer showing the bars included in each charge and the treatment they receive.

289. Bars thus tested which meet the requirements of the specifications shall be paid for by the Company at the same unit prices as the structures. Bars which fail to meet the requirements of the specifications, and all bars rejected as a result of tests, shall be at the Contractor's expense.

APPENDIX B

SPECIFICATIONS FOR STEEL RAILWAY BRIDGES (For Fixed Spans Not Exceeding 400 Ft. in Length)

AMERICAN RAILWAY ENGINEERING ASSOCIATION

1941

NOTE: Only those articles to which reference is made in Section 3 are given in this Appendix. All other articles in the 1941 Specifications are either the same or similar to those of the 1920 specifications.

102. Types of Bridges.—The preferred types of bridges are as follows:

- Rolled beam for spans up to 50 ft.
- Plate girders for spans up to 125 ft.
- Riveted trusses for spans 100 ft. or longer.
- Pin-connected trusses for spans 300 ft. or longer.

104. Depth Ratios.—The depth of trusses preferably shall be not less than one-tenth of the span. The depth of plate girders preferably shall be not less than one-twelfth of the span. The depth of rolled beams used as girders and the depth of solid floors preferably shall be not less than one-fifteenth of the span.

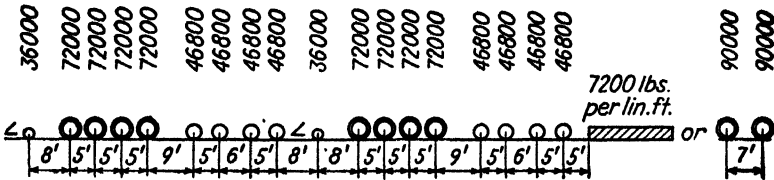

FIG. 1.

109. Floor.—Timber cross ties shall be not less than 10 ft. long, and spaced not more than 6 in. apart. They shall be secured against bunching.

102. Dead Load.—In estimating the weight for the purpose of computing dead load stresses, the following unit weights shall be used:

	Pounds per Cubic Foot
Steel.....	490
Concrete.....	150
Sand, gravel, and ballast.....	120
Asphalt-mastic and bituminous macadam.....	150
Granite.....	170
Paving bricks.....	150
Timber.....	60

The track rails, inside guard rails, and fastenings shall be assumed to weigh 200 lb. per lineal foot for each track.

103. Live Load.—The recommended live load for each track is the Cooper's E-72 load shown in Fig. 1.

The Engineer shall specify the live load to be used, such load to be proportional to the recommended load, with the same axle spacing.

For bridges on curves, provision shall be made for the increased proportion carried by any truss, girder, or stringer due to the eccentricity of the load.

For members receiving load from more than one track, the proportions of full live load on the tracks shall be as follows:

For two tracks, full live load.

For three tracks, full live load on two tracks and one-half on the other track.

For four tracks, full live load on two tracks, one-half on one track, and one-fourth on the remaining one.

The selection of the tracks for these proportions shall be such as will give the greatest live load stress.

204. Distribution of Live Load.—Floor beams that are spaced close enough to carry the track loads without stringers shall be designed for a proportion of the axle load equal to the ratio of the floor beam spacing to the axle spacing. The floor beams shall be connected by solid-web diaphragms at intervals not exceeding twelve times the flange width, with at least one diaphragm for each track.

206. Impact.—To the maximum computed static live load stresses, there shall be added the impact, consisting of:

a. The Rolling Effect.—The rolling effect is due to the rolling of the live load from side to side. It shall be taken as increasing the static live load on one rail by 20 per cent, with an equal decrease on the other rail. These loads shall be distributed to the supporting members.

b. The Direct Vertical Effect.—With steam locomotives (hammer blow, track irregularities, and car impact), a percentage of the static live load stress equal to:

$$\begin{aligned} \text{For } L \text{ less than 100 ft.} & \dots\dots\dots 100 - 0.60L \\ \text{For } L \text{ 100 ft. or more.} & \dots\dots\dots \frac{1800}{L - 40} + 10 \end{aligned}$$

With electric locomotives (track irregularities and car impact), a percentage of the static live load stress equal to $\frac{360}{L} + 12.5$.

L = length, in feet, center to center of supports for stringers, longitudinal girders, and trusses (chords and main members).

or, L = length of floor beams or transverse girders, in feet, for floor beams, floor beam hangers, subdiagonals of trusses, transverse girders, and supports for transverse girders.

207. For members receiving load from more than one track, the impact percentage shall be applied to the static live load on the number of tracks shown below:

Load received from:

Two tracks:

For L less than 175 ft. Full impact on two tracks.
 For L from 175 feet to 225 ft. Full impact on one track and a percentage of full impact on the other as given by the formula, $450 - 2L$.

For L greater than 225 ft. Full impact on one track and none on the other.

More than two tracks:

For all values of L Full impact on any two tracks.

208. Centrifugal Force.—On curves, the centrifugal force in percentage of the live load is $0.00117S^2D$.

S = speed in miles per hour.

D = degree of curve.

It shall be assumed to act 6 ft. above the rail and shall be taken without impact.

The table below gives the permissible speeds and the corresponding centrifugal force percentages for curves with the amounts of superelevation shown. It is based on a maxi-

mum speed of 100 miles per hour and a maximum superelevation of 7 in., resulting in a maximum centrifugal force of 17.5 per cent.

D	E	S	C	D	E	S	C
0°-10'		100	1.95	2°-30'	7	77	17.5
0°-20'		100	3.90	3°-00'	7	71	17.5
0°-30'	0.33	100	5.85	3°-30'	7	65	17.5
0°-40'	1.44	100	7.80	4°	7	61	17.5
0°-50'	2.56	100	9.75	5°	7	55	17.5
1°-00'	3.67	100	11.7	6°	7	50	17.5
1°-15'	5.33	100	14.6	8°	7	43	17.5
1°-30'	7	100	17.5	10°	7	39	17.5
1°-45'	7	93	17.5	15°	7	32	17.5
2°-00'	7	87	17.5	20°	7	27	17.5
2°-15'	7	82	17.5				

D = degree of curve.

$$C = 0.00117S^2D = 1.755(E + 3)$$

E = superelevation in inches.

$$E = \frac{2}{3} \cdot \frac{S^2D}{1,000} - 3 = \frac{C - 5.265}{1.755}$$

S = permissible speed in miles per hour.

C = centrifugal force in percentage of the live load.

$$S^2 = \frac{1,500}{D} (E + 3)$$

If the conditions at the site restrict the permissible speeds to less than those shown in the table, the centrifugal force percentage shall be taken for the greatest speed expected.

209. Wind on Loaded Bridge.—The wind force shall be considered as a moving load acting in any horizontal direction. On the train it shall be taken at 300 lb. per linear foot on one track, applied 8 ft. above the top of rail. On the bridge it shall be taken at 30 lb. per square foot of the following surfaces:

- (a) For girder spans, one and one-half times the vertical projection of the span.
- (b) For truss spans, the vertical projection of the span plus any portion of the leeward trusses not shielded by the floor system.
- (c) For viaduct towers and bents, the vertical projections of all columns and tower bracing.

The wind force on girder spans and truss spans, however, shall not be taken at less than 200 lb. per linear foot for the loaded chord or flange, and 150 lb. per linear foot for the unloaded chord or flange.

210. Wind on Unloaded Bridge.—If a wind force on the unloaded bridge of 50 lb. per square foot of surface as defined in Art. 209, combined with the dead load, produces greater stresses than those produced by the wind forces specified in Art. 209 combined with the stresses from dead load, live load, impact, and centrifugal force, the members wherein such greater stresses occur shall be designed therefor.

214. Longitudinal Force.—The longitudinal force resulting from the starting and stopping of trains shall be the larger of

- (a) Force due to braking: 15 per cent of the live load without impact.
- (b) Force due to traction: 25 per cent of the weight on the driving wheels, without impact.

The longitudinal force shall be taken on one track only and shall be assumed to act 6 ft. above the top of the rail.

For bridges where, by reason of continuity of members or frictional resistance, much of the longitudinal force will be carried directly to the abutments (such as ballasted deck bridges of only 3 or 4 spans), only ½ of the longitudinal force shall be considered effective.

215. Reversal of Stress.—Members subject to reversal of stress (whether axial, bending, or shearing) during the passage of the live load shall be proportioned as follows:

Determine the maximum stress of one sign and the maximum stress of the opposite sign and increase each by 50 per cent of the smaller. Proportion the member so that it will be capable of resisting either stress so increased. The connections shall be proportioned for the sum of the maximum stresses.

218. Secondary Stresses.—The design and details shall be such that secondary stresses will be as small as practicable. Secondary stresses due to truss distortion or floor beam deflection usually need not be considered in any member the width of which, measured parallel to the plane of distortion, is less than one-tenth of its length. If the secondary stress exceeds 4,000 lb. per square inch for tension members and 3,000 lb. per square inch for compression members, the excess shall be treated as a primary stress.

III. UNIT STRESSES

301. Unit Stresses.—The allowable unit stresses to be used in proportioning the parts of a bridge shall be as follows:

	Pounds per Square Inch
(a) Structural and rivet steel:	
Axial tension, structural steel, net section	18,000
Tension in extreme fibers of rolled shapes, girders, and built sections, subject to bending	18,000
Axial compression, gross section:	
For stiffeners of plate girders	18,000
For compression members centrally loaded and with values of $\frac{l}{r}$ not greater than 140:	
Riveted ends	15,000 - $\frac{1}{4} \frac{l^2}{r^2}$
Pin ends	15,000 - $\frac{1}{3} \frac{l^2}{r^2}$
l = length of member, in inches. r = least radius of gyration of member, in inches.	
For compression members with values of $\frac{l}{r}$ greater than 140 and for compression members of known eccentricity, see Appendix A.	
Compression in extreme fibers of rolled shapes, girders, and built sections, subject to bending (for values of $\frac{l}{b}$ not greater than 40)	18,000 - $5 \frac{l^2}{b^2}$
l = length, in inches, of unsupported flange between lateral connections or knee braces. b = flange width, in inches.	
Diagonal tension in webs of girders and rolled beams at sections where maximum shear and bending occur simultaneously	18,000
Stress in extreme fibers of pins	27,000
Shear in plate girder webs, gross section	11,000
Shear in power-driven rivets and pins	13,500
Shear in turned bolts and hand-driven rivets	11,000
Bearing on pins	24,000
Bearing on power-driven rivets, milled stiffeners, and other steel parts in contact	27,000
Rivets driven by pneumatically or electrically operated hammers are considered power-driven.	
Bearing between rockers and rocker pins	12,000
Bearing on turned bolts and hand-driven rivets	20,000
Bearing on expansion rollers and rockers, pounds per lineal inch:	

For diameters up to 25 inches... $\frac{p - 13,000}{20,000} 600d$
 For diameters from 25 inches
 to 125 inches..... $\frac{p - 13,000}{20,000} 3000 \sqrt{d}$
 d = diameter of roller or rocker, in inches.
 p = yield point in tension of the steel in the roller
 or the base, whichever is the lesser.

(b) Cast steel:

For cast steel, the allowable unit stresses in compression and bearing shall be the same as those for structural steel. Other allowable unit stresses shall be $\frac{3}{4}$ of those for structural steel.

(c) Masonry:

Bearing pressure:

Granite.....	800
Concrete.....	600
Sandstone and limestone.....	400

(d) Timber cross ties:

Extreme fiber stress in bending:

Yellow pine, dense structural grade.....	1,500
Douglas fir, close grain structural grade....	1,400
White oak.....	1,200
White pine, Norway pine, and spruce.....	800

In computing the stress in timber cross ties, the wheel load shall be considered as distributed over three ties and as applied without impact.

405. Compression Members.—Compression members shall be so designed that the main elements of the section will be connected directly to the gusset plates, pins, or other members.

Built-up sections shall be so arranged that the center of gravity will coincide as nearly as practicable with the center line of the section. Preferably the segments shall be connected by solid webs.

In members consisting of segments connected by cover plates or lacing, or segments connected by webs, and which members receive their full allowable unit stress, the thickness of the webs of the segments shall be not less than $\frac{1}{32}$ of the unsupported distance between the nearest lines of their connecting rivets or the roots of their rolled flanges. The thickness of the cover plates or of the webs connecting the segments shall be not less than $\frac{1}{40}$ of the unsupported distance between the nearest lines of their connecting rivets or the roots of their rolled flanges. For such members in which the stress is less than that allowable, the denominators 32 and 40 may be multiplied by the factor $\sqrt{p/f}$.

p = the allowable unit stress.

f = the unit stress in the member.

409. Net Section.—The net section of a riveted tension member is the sum of the net sections of its component parts. The net section of a part is the product of the thickness of the part multiplied by its least net width.

The net width for any chain of holes extending progressively across the part shall be obtained by deducting from the gross width the sum of the diameters of all the holes in the chain and adding, for each gage space in the chain, the quantity,

s = pitch of any two successive holes in the chain.

g = gage of the same holes.

The net section of the part is obtained from that chain which gives the least net width.

For angles, the gross width shall be the sum of the widths of the legs less the thickness.

The gage for holes in opposite legs shall be the sum of the gages from back of angle less the thickness.

For splice members, the thickness shall be only that part of the thickness of the member which has been developed by rivets beyond the section considered.

The diameter of the hole shall be taken as $\frac{1}{8}$ inch greater than the nominal diameter of the rivet.

412. Pitch of Rivets.—The pitch in the direction of stress for members composed of plates and shapes shall not exceed seven times the diameter of the rivets except for web stitch rivets.

At the ends of built compression members, the pitch in the direction of stress shall not exceed four times the diameter of the rivets for a distance one and one-half times the width of the member.

420. Lacing.—Lacing bars of compression members shall be so spaced that the slenderness ratio of the portion of the flange included between the lacing bar connections will be not more than 40 nor more than $\frac{2}{3}$ of the slenderness ratio of the member.

In compression members, the shearing stress normal to the member in the plane of the lacing shall be that obtained by the following formula,

$$V = \frac{P}{100} \left(\frac{100}{\frac{l}{r} + 10} + \frac{l}{100} \right)$$

V = normal shearing stress.

P = allowable compressive axial load on member.

l = length of member, in inches.

r = radius of gyration of section about the axis perpendicular to plane of lacing in inches.

To the shear so determined shall be added any shear due to the weight of the member or to other forces, and the lacing proportioned for the combined shear.

The shear shall be considered as divided equally among all parallel planes in which there are shear-resisting elements, whether continuous plates or lacing. The section of the lacing bars shall be determined by the formula for axial compression in which l is taken as the distance along the bar between its connections to the main segments for single lacing, and as 70 per cent of that distance for double lacing.

If the distance across the member between rivet lines in the flanges is more than 15 in. and a bar with a single rivet in the connection is used, the lacing shall be double and riveted at the intersections.

The angle between the lacing bars and the axis of the member shall be approximately 45 deg. for double lacing and 60 deg. for single lacing.

Lacing bars may be shapes or flat bars. For main members the minimum thickness of flat bars shall be $\frac{1}{40}$ of the distance along the bar between its connections for single lacing, and $\frac{1}{60}$ for double lacing. For bracing members, the limits shall be $\frac{1}{60}$ for single lacing and $\frac{1}{75}$ for double lacing.

The diameter of the rivets in lacing bars shall not exceed $\frac{1}{3}$ of the width of the bar. There shall be at least two rivets in each end of lacing bars riveted to flanges more than 5 in. in width.

425. End-connection Angles.—The connection angles for stringers, floor beams, and beams in solid floor sections shall be not less than 4 in. in width and $\frac{1}{2}$ in. in finished thickness.

For stringers, the gage of the outstanding legs of the connection angles over the top one-third of the stringer depth shall be not less than the quantity $\sqrt{\frac{l}{8}}$.

l = length of stringer span, in inches.

t = thickness of angle, in inches.

426. Proportioning Plate Girders.—Plate girders, I-beams, and other members subject to bending that produces tension on one face, shall be proportioned by the moment-of-inertia method. The neutral axis shall be taken along the center of gravity of the gross section. The tensile stress shall be computed from the moment of inertia of the entire net section and the compressive stress from the moment of inertia of the entire gross section.

427. Flange Section.—In order to offset the effects of corrosion and the possible crookedness of the compression flange of a plate girder or a rolled beam, the gross section of the compression flange shall not be less than the gross section of the tension flange.

Flanges of plate girders preferably shall be made without cover plates or side plates unless angles of greater section than 6 by 6 by $\frac{7}{8}$ in. would otherwise be required.

Cover plates shall be equal in thickness or shall diminish in thickness from the flange angles outward. No plate shall be thicker than the flange angles. When cover plates are used, at least one plate on each flange shall extend the full length of the girder. Other flange plates shall extend far enough to allow two rows of rivets at each end of the plate, beyond the theoretical end, and there shall be enough rivets to develop the plate between its end and the theoretical end of the next plate outside.

In through bridges, there shall be end and corner cover plates.

431. Thickness of Web Plates.—The thickness of the webs of plate girders shall be not less than $\frac{1}{70}$ of the clear distance between the flanges, except that if the extreme fiber stress in the compression flange is less than that allowable, the denominator 170 may be multiplied by the factor $\sqrt{\frac{p}{f}}$.

p = the allowable extreme fiber stress.

f = the extreme fiber stress in the compression flange.

433. Intermediate Stiffeners.—If the depth of the web between the flanges of side plates of a plate girder exceeds sixty times its thickness, it shall be stiffened by pairs of angles riveted to the web. The clear distance between stiffeners shall not exceed 72 in. or that given by the formula:

$$d = \frac{255000t}{S} \sqrt[3]{\frac{St}{a}}$$

d = clear distance between stiffeners, in inches.

t = thickness of web, in inches.

a = clear depth of web between flanges or side plates, in inches.

S = unit shearing stress, gross section, in web at point considered.

The width of the outstanding leg of each angle shall be not more than sixteen times its thickness and not less than 2 in. plus $\frac{1}{50}$ of the depth of the girder.

434. Bracing of Top Flanges of Through Girders.—The top flanges of through plate girders shall be braced at the panel points by brackets with web plates. The brackets shall extend to the top flange of the main girder and be as wide as the clearance will allow. They shall be attached securely to a stiffener angle on the girder and to the top flange of the floor beam. On solid floor bridges the brackets shall be not more than 12 ft. apart.

435. Lateral Bracing.—There shall be bottom lateral bracing in all spans except deck spans less than 50 ft. long. There shall be top lateral bracing in all deck spans and in through spans that have enough headroom.

If the construction of the floor is such as to afford the specified lateral resistance, the floor shall be taken as the lateral bracing required in its plane.

436. Portal and Sway Bracing.—In through truss spans there shall be portal bracing, with knee braces, as deep as the clearance will allow. There shall be sway bracing at the intermediate panel points if the trusses are high enough to allow a depth of 6 ft. or more for such bracing. If they are not high enough to allow that depth, the top lateral struts shall be of the same depth as the chord, and there shall be knee braces as deep as the clearance will allow.

In deck truss spans there shall be sway bracing at the panel points. The top lateral forces shall be carried to the supports by means of a complete system of bracing in the planes of the top chords and the main end posts.

437. Rigid Bracing.—Lateral bracing shall be rigid, and there shall be not less than three rivets in each end connection.

If the bracing is a double system and the members meet the requirements for both tension and compression members, both systems may be considered effective simultaneously.

438. Cross Frames.—In deck plate girder spans there shall be cross frames at the ends and at intervals not exceeding 18 ft. The end frames shall be proportioned for the centrifugal and lateral forces.

If there are two lines of stringers under each track in panels more than 20 ft. in length, they shall be connected by cross frames.

440. Eyebars.—The thickness of eyebars shall be not less than 1 in. or more than 2 in. The section of the head through the center of the pinhole shall exceed that of the body of the bar by at least 35 per cent. The form of the head shall be submitted to the Engineer for approval before the bars are made. The diameter of the pin shall be not less than $\frac{3}{10}$ of the width of the widest bar attached.

444. Rollers.—Expansion rollers may be either cylindrical or segmental and shall be not less than 6 in. in diameter. They shall be coupled together with substantial side bars and geared to the upper and lower plates. The roller nest shall be so designed that the parts may be cleaned readily.

APPENDIX C

STANDARD SPECIFICATIONS FOR STEEL FOR BRIDGES AND BUILDINGS AMERICAN SOCIETY FOR TESTING MATERIALS

(A.S.T.M. Designation A7-3F)

1. Scope.—These specifications cover carbon-steel of structural quality for use in the construction of bridges and buildings and for general structural purposes.

2. Castings, Rivet Steel, Forgings.—For use with steel purchased under these specifications, the following standards of the American Society for Testing Materials shall apply:

a. Steel Castings.—The Standard Specifications for Carbon-Steel Castings for Miscellaneous Industrial Uses (A.S.T.M. Designation: A27)¹ shall govern the purchase of steel castings for bridges and buildings. Unless otherwise specified, grade B-1 castings, fully annealed, shall be used.

b. Structural Rivet Steel.—Unless otherwise specified, the Standard Specifications for Structural Rivet Steel (A.S.T.M. Designation: A141)² shall govern the purchase of rivets.

c. Forgings.—The Standard Specifications for Carbon-Steel and Alloy-Steel Forgings (A.S.T.M. Designation: A18)³ may also be used for forgings.

3. Structural Bolts.—Unless otherwise specified, bolts to be employed in permanent connections between parts fabricated of steel purchased under these specifications shall be subject to the requirements of Section 9a for minimum tensile strength (to be taken on the area at root of thread) and to the requirements of Section 10 for cold bend (to be taken on the unthreaded portion of the bolt), and shall be exempt from further requirements.

4. Rolled Base Plates.—Rolled base plates over 2 in. in thickness for bearing purposes shall be open-hearth or electric-furnace steel containing 0.20 to 0.35 per cent carbon. The chemical composition shall also conform to the requirements specified in Section 6. A sufficient discard shall be made from each ingot to secure sound plates. Physical tests shall not be required for this material.

5. Process.—*a.* The steel, except as may be specified in Paragraph *b*, shall be made by either or both of the following processes: open-hearth or electric-furnace.

b. Steel for plates and sections $\frac{7}{16}$ in. and under in thickness, intended for use in buildings and other structures subject to static loads only, may be made by the acid-bessemer process, unless otherwise specified.

6. Chemical Composition.—The steel shall conform to the following requirements as to chemical composition:

Phosphorus, max., per cent:

Open-hearth or electric-furnace:	
Acid.....	0.06
Basic.....	0.04
Acid-bessemer.....	0.10
Sulfur, max., per cent (open-hearth or electric-furnace).....	0.05
Copper, when copper steel is specified, min., per cent.....	0.20

7. Ladle Analysis.—*a.* An analysis of each melt of open-hearth or electric-furnace steel shall be made to determine the percentages of carbon, manganese, phosphorus, and sulfur; also copper when copper steel is specified.

¹ 1939 Book of A.S.T.M. Standards, Part I, p. 218.

² *Ibid.*, p. 35.

³ *Ibid.*, p. 184.

b. A carbon determination, and a copper determination when copper steel is specified, shall be made of each melt of bessemer steel, and determinations for manganese, phosphorus, and sulfur representing the average of the melts applied for each 8-hr. period.

c. The analyses prescribed in Paragraphs *a* and *b* shall be made by the manufacturer from test ingots taken during the pouring of the melts. The chemical composition thus determined shall be reported to the purchaser or his representative, and the percentages of phosphorus and sulfur, also copper when copper steel is specified, shall conform to the requirements specified in Section 6.

8. **Check Analysis.**—An analysis may be made by the purchaser from finished material representing each melt. The phosphorus and sulfur content thus determined shall not exceed that specified in Section 6 by more than 25 per cent.

9. **Tensile Properties.**—*a.* The material, except as specified in Sections 3 and 4 and Paragraphs *b* and *d* of this section, shall conform to the following requirements as to tensile properties:

	Plates, sections, and bars	Eyebar flats, unannealed*
Tensile strength, p.s.i.	60,000 to 72,000	67,000 to 82,000
Yield point, min., p.s.i.	0.5 tens. str. 33,000	0.5 tens. str. 36,000
but in no case less than	1,500,000†	1,500,000†
Elongation in 8 in., min., per cent.	tens. str. 22	tens. str. 20
Elongation in 2 in., min., per cent.		

* These requirements apply when full-size tests of annealed eyebars are not specified. See Paragraph (*b*).

† See Paragraphs (*f*) and (*g*).

b. When finished eyebars are subject to full-size tests, the physical properties required for specimen tests of the eyebar flats unannealed shall be determined by the manufacturer of the eyebars.

c. When full-size tests are specified for finished, annealed eyebars, they shall conform to the following requirements as to tensile properties:

Tensile strength, min., p.s.i.	60,000
Yield point, min., p.s.i.	33,000
Elongation in 18 ft., min., per cent.	12

The elongation shall be measured in the body of the bar including the fracture. The fracture shall show a silky or finely granular structure throughout.

d. Flat-rolled steel $\frac{3}{16}$ in. and under in thickness, shapes less than 1 sq. in. in cross-section, and bars, other than flats, less than $\frac{1}{2}$ in. in thickness or diameter need not be subjected to tension tests.

e. The yield point shall be determined by the drop of the beam or halt in the gage of the testing machine.

f. For material under $\frac{3}{4}$ in. in thickness or diameter, a deduction from the percentage of elongation in 8 in. specified in Paragraph *a* of 0.25 per cent shall be made for each increase of $\frac{1}{32}$ in. of the specified thickness or diameter above $\frac{3}{4}$ in., to a minimum of 18 per cent for plates, shapes, and bars and a minimum of 14 per cent for eyebar flats unannealed.

g. For material under $\frac{5}{16}$ in. in thickness or diameter, a deduction from the percentage of elongation in 8 in. specified in Paragraph *a* of 1.25 per cent shall be made for each decrease of $\frac{1}{32}$ in. of the specified thickness or diameter below $\frac{5}{16}$ in.

10. **Bending Properties.**—The bend test specimen shall stand being bent cold through 180 deg. without cracking on the outside of the bent portion around a pin the diameter of which shall have the following relation to the thickness of the specimen:

Thickness of material	Ratio of pin diameter to thickness of specimen	
	Plates, sections, and bars	Eyebar flats unannealed
3/4 in. and under.....	1 1/2	1 1/2
Over 3/4 to 1 in., incl.....	1	2 1/2
Over 1 to 1 1/2 in., incl.....	1 1/2	3
Over 1 1/2 to 2 in., incl.....	2 1/2	4
Over 2 in.....	3	4 1/2

11. Test Specimens.—a. Test specimens shall be prepared for testing from the material in its rolled or forged condition, except as specified in Paragraph b.

b. Test specimens for annealed material, except eyebars, shall be prepared from the material as annealed for use or from a short length of a full section from the same melt similarly treated.

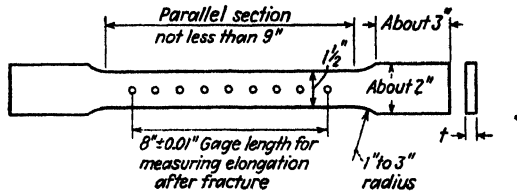
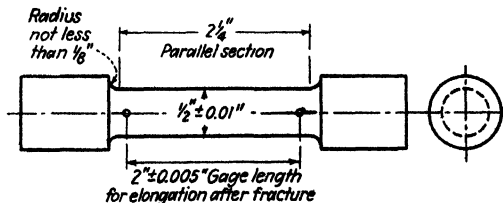

FIG. 1. Standard 8-in. gage length test specimen.



NOTE: The gage length, parallel section, and fillets shall be as shown, but the ends may be of any shape to fit the holders of the testing machine in such a way that the load shall be axial.

FIG. 2. - Standard 2-in. gage length tension test specimen.

c. Test specimens shall be taken longitudinally and, except as specified in Paragraphs e, f, and g, shall be the full thickness or section of material as rolled.

d. Test specimens for plates, shapes, and flats may be machined to the form and dimensions shown in Fig. 1, or with both edges parallel.

e. Tension test specimens for material over 1 1/2 in. in thickness or diameter, except pins and rollers, may be machined to a thickness or diameter of at least 3/4 in. for a length of at least 9 in., or they may conform to the dimensions shown in Fig. 2.

f. Bend test specimens for material over 1 1/2 in. in thickness or diameter, except pins and rollers, may be machined to a thickness or diameter of at least 3/4 in. or to 1 by 1/2 in. in section.

g. Tension test specimens for pins and rollers shall conform to the dimensions shown in Fig. 2, and bend test specimens shall be 1 by 1/2 in. in section.

h. Test specimens for pins and rollers shall be taken so that the axis is 1 in. from the surface.

TABLE I.—PERMISSIBLE OVERWEIGHTS OF PLATES ORDERED TO THICKNESS

Specified thickness, in.	Permissible excess in average weight of lots for widths given, in., expressed in percentage of nominal weights										
	48 or under	Over 48 to 60, excl.	60 to 72, excl.	72 to 84, excl.	84 to 96, excl.	96 to 108, excl.	108 to 120, excl.	120 to 132, excl.	132 to 144, excl.	144 to 168, excl.	168 or over
$\frac{3}{16}$ to $\frac{1}{4}$, excl.	8	9	10	12	14					
$\frac{1}{4}$ to $\frac{5}{16}$, excl.	6	7	8	9	10	12	14	16	19		
$\frac{5}{16}$ to $\frac{3}{8}$, excl.	5	6	7	8	9	10	12	14	17	18	
$\frac{3}{8}$ to $\frac{7}{16}$, excl.	4.5	5	6	7	8	9	10	12	15	16	18
$\frac{7}{16}$ to $\frac{1}{2}$, excl.	4	4.5	5	6	7	8	9	10	13	14	16
$\frac{1}{2}$ to $\frac{5}{8}$, excl.	3.5	4	4.5	5	6	7	8	9	11	12	14
$\frac{5}{8}$ to $\frac{3}{4}$, excl.	3	3.5	4	4.5	5	6	7	8	9	10	12
$\frac{3}{4}$ to 1, excl.	2.5	3	3.5	4	4.5	5	6	7	8	9	11
1 to 2, incl.	2.5	2.5	3	3.5	4	4.5	5	6	7	8	9

NOTE.—Permissible variations in weight for individual plates shall be one and one-third times the amounts prescribed in this table.

TABLE II.—PERMISSIBLE VARIATIONS OF PLATES ORDERED TO WEIGHT

Specified weight, lb. per sq. ft.	Permissible variations in average weight of lots for widths given, in., expressed in percentage of ordered weights (weight per sq. ft.)																					
	48 or under		Over 48 to 60, excl.		60 to 72, excl.		72 to 84, excl.		84 to 96, excl.		96 to 108, excl.		108 to 120, excl.		120 to 132, excl.		132 to 144, excl.		144 to 168, excl.		168 or over	
	Over	Under	Over	Under	Over	Under	Over	Under	Over	Under	Over	Under	Over	Under	Over	Under	Over	Under	Over	Under	Over	Under
7.65 to 10, excl.			4.5	3	5	3	5.5	3	6	3												
10 to 12.5, excl.	3.5	2.5	4	3	4.5	3	5	3	5.5	3	6	3	7	3	8	3	9	3				
12.5 to 15, excl.	3	2.5	3	2.5	4	3	4.5	3	5	3	5.5	3	6	3	7	3	8	3				
15 to 17.5, excl.	2.5	2.5	3	2.5	3.5	2.5	4	3	4.5	3	5	3	5.5	3	6	3	7	3	9	3	10	3
17.5 to 20, excl.	2.5	2	2.5	2.5	3	2.5	3.5	2.5	4	3	4.5	3	5	3	5.5	3	6	3	8	3	9	3
20 to 25, excl.	2	2	2.5	2	2.5	2.5	3	2.5	3.5	2.5	4	3	4.5	3	5	3	5.5	3	7	3	8	3
25 to 30, excl.	2	2	2	2	2.5	2	2.5	2.5	3	2.5	3.5	3	4	3	4.5	3	5	3	6.5	3	7	3
30 to 40, excl.	2	2	2	2	2	2	2.5	2	2.5	2.5	3	2.5	3.5	3	4	3	4.5	3	6	3	6.5	3
40 to 81.6, incl.	2	2	2	2	2	2	2.5	2	2.5	2.5	3	2.5	3.5	3	4	3	4.5	3	6	3	6.5	3

NOTE.—Permissible variations in weight for individual plates shall be one and one-third times the amounts prescribed in this table.

i. The sides of the bend test specimens may have the corners rounded to a radius not over $\frac{1}{16}$ in.

12. Number of Tests.—a. Two tension and two bend tests shall be made from each melt, unless the finished material from a melt is less than 30 tons, when one tension test and one bend test will be sufficient. If, however, material from one melt differs $\frac{3}{8}$ in. or more in thickness, one tension test and one bend test shall be made from both the thickest and the thinnest material rolled regardless of the weight represented.

b. If any test specimen shows defective machining or develops flaws, it may be discarded and another specimen substituted.

c. If the percentage of elongation of any tension test specimen is less than that specified in Section 9 and any part of the fracture is more than $\frac{3}{4}$ in. from the center of the gage length of a 2-in. specimen or is outside the middle third of the gage length of an 8-in. specimen, as indicated by scribe scratches marked on the specimen before testing, a retest shall be allowed.

13. Permissible Variations in Weight and Thickness.—*a.* One cubic inch of rolled steel is assumed to weigh 0.2833 lb. The cross-sectional area or weight of each structural-size shape and of each universal mill plate up to and including 36 in. in width and 2 in. in thickness shall not vary more than 2.5 per cent from the theoretical or specified amounts. The thickness or weights of rectangular sheared mill plates and of rectangular universal mill plates over 36 in. in width or over 2 in. in thickness shall conform to the requirements of Paragraphs *b, c, d, or e.*

b. Plates, When Ordered to Thickness.—No plate shall vary more than 0.01 in. under the thickness specified.

c. The overweight of each lot¹ of plates in each shipment shall not exceed the amounts prescribed in Table I.

d. Plates, When Ordered to Weight per Square Foot. The weight of each lot¹ of plates in each shipment shall not vary from the weight ordered more than the amounts prescribed in Table II.

e. Plates over 2 In. in Thickness.—Each plate over 2 in. in thickness shall conform to the permissible variations over ordered thickness prescribed in Table III.

14. Finish.—*a.* The material shall be free from injurious defects and shall have a workmanlike finish.

b. Surface imperfections that do not affect the full utility of the pieces shall not be considered as injurious defects in structural shapes $\frac{3}{8}$ in. or more in thickness. Such pieces may be processed by the following methods in order to give them a workmanlike finish:

(1) When the surface imperfections are less than $\frac{1}{16}$ in. in depth, they may be removed by grinding.

(2) When the surface imperfections are $\frac{1}{16}$ in. or more in depth, the pieces may be subjected to chipping and welding under limiting conditions as follows:

The cross-sectional area of any piece shall not be reduced more than 1.5 per cent at any point, nor shall the total area of the chipped surface of any piece exceed 2 per cent of the total surface area of that piece.

TABLE III.—PERMISSIBLE VARIATIONS OVER ORDERED THICKNESS OF PLATES OVER 2 IN. IN THICKNESS

Specified thickness, in.	Variations over specified thickness for widths given					
	Up to 36, excl.	36 to 60, excl.	60 to 84, excl.	84 to 120, excl.	120 to 132, excl.	132 or over
Over 2 to 3, excl.	$\frac{1}{16}$	$\frac{3}{32}$	$\frac{7}{64}$	$\frac{1}{8}$	$\frac{1}{8}$	$\frac{9}{64}$
3 to 4, excl.	$\frac{3}{64}$	$\frac{3}{32}$	$\frac{7}{64}$	$\frac{1}{8}$	$\frac{1}{8}$	$\frac{9}{64}$
4 to 6, excl.	$\frac{3}{32}$	$\frac{1}{8}$	$\frac{9}{64}$	$\frac{9}{64}$	$\frac{5}{32}$	$1\frac{1}{64}$
6 to 8, excl.	$\frac{7}{64}$	$\frac{1}{8}$	$\frac{5}{32}$	$\frac{5}{32}$	$1\frac{1}{64}$	
8 to 10, excl.		$1\frac{1}{64}$	$\frac{3}{16}$	$\frac{3}{16}$		
10 to 12, excl.		$\frac{3}{16}$	$1\frac{5}{64}$	$1\frac{5}{64}$		
12 to 15, incl.		$\frac{7}{32}$	$\frac{1}{4}$			

After any imperfection has been completely removed, the maximum depth of depression shall not exceed the following:

¹ The term "lot" as applied to Table I means all the plates of each group width and group thickness; as applied to Table II, it means all the plates of each group width and group weight.

Thickness of Material, In.	Depth of De- pression, Max.,
	In.
$\frac{3}{8}$ up to $\frac{1}{2}$	$\frac{1}{16}$
$\frac{1}{2}$ up to 1.....	$\frac{1}{8}$
1 up to $1\frac{1}{4}$	$\frac{3}{16}$
$1\frac{1}{4}$ up to $2\frac{1}{4}$	$\frac{1}{4}$
$2\frac{1}{4}$ up to $3\frac{1}{2}$	$\frac{3}{8}$

An experienced mill inspector shall inspect the work after the chipping operation to see that the defects have been completely removed and that the limitations specified above have not been exceeded. The inspector representing the purchaser shall be given full opportunity to make this same inspection. All welding shall be done by qualified welders using suitable coated welding rods. The welds shall be sound; the weld metal being thoroughly fused on all surfaces and edges without undercutting or overlap. Weld metal shall project at least $\frac{1}{16}$ in. above the rolled surface after welding, and the projecting metal shall be removed by chipping or grinding to make it flush with the rolled surface and produce a workmanlike finish.

15. Marking.—The name or brand of the manufacturer and the melt number shall be legibly stamped or rolled on all finished material, except that lattice bars and other small sections shall, when loaded for shipment, be properly separated and marked for identification. The identification marks shall be legibly stamped on the end of each pin and roller. The melt number shall be legibly marked, by stamping if practicable, on each test specimen.

16. Inspection.—The inspector representing the purchaser shall have free entry, at all times while work on the contract of the purchaser is being performed, to all parts of the manufacturer's works which concern the manufacture of the material ordered. The manufacturer shall afford the inspector, without charge, all reasonable facilities to satisfy him that the material is being furnished in accordance with these specifications. All tests (except check analysis) and inspection shall be made at the place of manufacture prior to shipment, unless otherwise specified, and shall be so conducted as not to interfere unnecessarily with the operation of the works.

17. Rejection.—*a.* Unless otherwise specified, any rejection based on tests made in accordance with Section 8 shall be reported to the manufacturer within five working days from the receipt of samples by the purchaser.

b. Material which shows injurious defects subsequent to its acceptance at the manufacturer's works will be rejected, and the manufacturer shall be notified.

18. Rehearing.—Samples tested in accordance with Section 8 that represent rejected material shall be preserved for two weeks from the date of the test report. In case of dissatisfaction with the results of the tests, the manufacturer may make claim for a rehearing within that time.

APPENDIX D

STANDARD SPECIFICATIONS FOR STRUCTURAL RIVET STEEL AMERICAN SOCIETY FOR TESTING MATERIALS

(A S T M Designation A14 -39)

1. Scope.— These specifications cover soft-carbon steel for rivets for structural purposes

2. Process.— The steel shall be made by either or both of the following processes open-hearth or electric furnace

3. Chemical Composition The steel shall conform to the following requirements as to chemical composition

Phosphorus	Acid		0 06
max per cent	Basic		0 04
Sulfur, max per cent			0 05
Copper, when copper steel is specified		min per cent	0 20

4. Ladle Analysis— An analysis of each melt of steel shall be made by the manufacturer to determine the percentages of carbon manganese phosphorus and sulfur also copper when copper steel is specified This analysis shall be made from a test ingot taken during the pouring of the melt The chemical composition thus determined shall be reported to the purchaser or his representative and the percentages of phosphorus and sulfur and copper when copper steel is specified shall conform to the requirements specified in Section 3

5. Check Analysis An analysis may be made by the purchaser from finished material representing each melt The phosphorus and sulfur content thus determined shall not exceed that specified in Section 3 by more than 25 per cent

6. Tensile Properties. *a* The material shall conform to the following requirements as to tensile properties

Tensile strength p s i	52,000 to 62,000
Yield point, min p s i	0 5 tens str
but in no case less than	28,000
	1,500,000
Elongation in 8 in min per cent	tens sti

b The yield point shall be determined by the drop of the beam or halt in the gage of the testing machine

7. Bending Properties.—The bend test specimen shall stand being bent cold through 180 deg flat on itself without cracking on the outside of the bent portion

8. Test Specimens.—*a* Test specimens shall be of the full diameter of the bars as rolled

b Tension and bend test specimens for rivet bars which have been cold drawn shall be normalized before testing

9. Number of Tests.—*a* One tension test and one bend test shall be made from each melt, except that if bars from one melt differ $\frac{3}{8}$ in or more in diameter, one tension and one bend test shall be made from both the greatest and least diameters rolled

b If any test specimen develops flaws, it may be discarded and another specimen substituted

c If the percentage of elongation of any tension test specimen is less than that specified in Section 6*a* and any part of the fracture is outside the middle third of the gage length, as indicated by scribe scratches marked on the specimen before testing, a retest shall be allowed.

10. Permissible Variations in Diameter.—The diameter of rivet bars shall not vary from the size specified by more than the amounts prescribed in the following table.

PERMISSIBLE VARIATIONS IN THE SIZE OF HOT-ROLLED ROUNDS AND SQUARES

Specified size, in.	Variations from size, in.		Out-of-round or square, in.
	Over	Under	
$\frac{5}{16}$ and under.....	0.005	0.005	0.008
Over $\frac{5}{16}$ to $\frac{7}{16}$, incl.....	0.006	0.006	0.009
Over $\frac{7}{16}$ to $\frac{5}{8}$, incl.....	0.007	0.007	0.010
Over $\frac{5}{8}$ to $\frac{7}{8}$, incl.....	0.008	0.008	0.012
Over $\frac{7}{8}$ to 1, incl.....	0.009	0.009	0.013
Over 1 to $1\frac{1}{8}$, incl.....	0.010	0.010	0.015
Over $1\frac{1}{8}$ to $1\frac{1}{4}$, incl.....	0.011	0.011	0.016
Over $1\frac{1}{4}$ to $1\frac{3}{8}$, incl.....	0.012	0.012	0.018
Over $1\frac{3}{8}$ to $1\frac{1}{2}$, incl.....	0.014	0.014	0.021
Over $1\frac{1}{2}$ to 2, incl.....	$\frac{1}{64}$	$\frac{1}{64}$	0.023

NOTE.—Out-of-round is the difference between the maximum and minimum diameters of the bar, measured at the same cross section. Out-of-square is the difference in the two dimensions at the same cross section of a square bar.

11. Finish.—The bars shall be free from injurious defects and shall have a workmanlike finish.

12. Marking.—Rivet bars shall, when loaded for shipment, be properly separated and marked with the name or brand of the manufacturer and the melt number for identification. The melt number shall be legibly marked on each test specimen.

13. Inspection.—The inspector representing the purchaser shall have free entry, at all times while work on the contract of the purchaser is being performed, to all parts of the manufacturer's works which concern the manufacture of the material ordered. The manufacturer shall afford the inspector, without charge, all reasonable facilities to satisfy him that the material is being furnished in accordance with these specifications. All tests (except check analysis) and inspection shall be made at the place of manufacture prior to shipment, unless otherwise specified, and shall be so conducted as not to interfere unnecessarily with the operation of the works.

14. Rejection.—*a.* Unless otherwise specified, any rejection based on tests made in accordance with Section 5 shall be reported to the manufacturer within five working days from the receipt of samples by the purchaser.

b. Material which shows injurious defects subsequent to its acceptance at the manufacturer's works will be rejected, and the manufacturer shall be notified.

15. Rehearing.—Samples tested in accordance with Section 5 that represent rejected material shall be preserved for two weeks from the date of the test report. In case of dissatisfaction with the results of the tests, the manufacturer may make claim for a rehearing within that time.

INDEX

A

- Allen Corporation, 75
- American Association of State Highway Officials, highway bridges, specifications of, 368
- American Bridge Co., beam sketches, 508
 - details of wooden doors, 82
 - truss sections used by, 142
 - wooden sash, details, 90
- American Institute of Steel Construction, stiffener beam seats, 19
 - unit stresses, for structural timber, 380
 - for structural timber columns, 381
- American Railway Engineering Assoc., coal tar creosote, specifications, 646
 - railway bridges, requirements for, 286
 - steel railway bridges, specifications, 687-716
 - structural wood, specifications for, 650-681
 - working stresses for timber, 162, 635
- American Society for Testing Materials, elevated tower and tank design, specifications for, 435
 - structural wood, specifications for, 650-681
 - timber piles, specifications for, 682
 - uniform specifications, 624
- American Wood-Preservers' Association, coal tar creosote oil, specifications for, 646
- Arched roof trusses, 243-271
 - in braced and ribbed arches, 256
 - bracing, 271
 - form of arch truss, 243
 - hingeless, 244
 - loading conditions, 259
 - members and joints for typical three-hinged arch, 266-271
 - reactions and stresses, 247-259
 - spacing, 245
 - stresses in a typical three-hinged arch truss, 260-266
 - three-hinged, 244

- Arched roof trusses, two-hinged, 244
- Arex Co., 74

B

- Babcock and Wilcox Co., 447, 448, 451
- Baker, Sir B., quoted on wind loads, 148
- Balcony construction, 38-40
- Barber Asphalt Corp., 80
- Barrett Co., 80
- Basements and sub-basements, 11
- Bases, cast-iron column, 9
- Beams, standard shaped vs. wide-flange, 12
 - Bearing capacity of soils, 6
- Berlin system of roof covering, 76
- Betts, H. S. quoted, 633, 634
- Bolts, tensile strength, 481
- Bracing, of roofs and buildings, 140
 - of a steel mill building, 59
- Bracing trusses, in roof design, 103
- Bridge machinery, simplified shop work, 562
- Bridges, steel, highway, 359-371
 - methods of erection, 583
 - railway, 286-358
 - specifications, 687-716
 - specifications for structural steel, 717-722
- Bridges, timber, 372-405
- Bridging, in floor construction, 94
- Building materials, weights of, 145
 - terms, 121-129
- Buildings, 1-129
 - classification, 1
 - definitions of terms, 121-129
 - specifications for structural steel, 717-722
 - steel mill, 44-93
 - office, 1-44
 - timber framed floors and roofs, 94-106
 - mill construction, 106-121
- Burnettizing process of preserving timber, 647

Burt Manufacturing Co., 75
 Busch, John D., and Sons, 92

C

Caissons, 7
 Cantilever foundations, 8
 Carnegie-Illinois Steel Corp., 10
 Cast iron, 616-619
 bases, 9
 design of castings, 618
 gray iron, 616
 kinds, 616
 malleable, 618
 manufacture, methods of, 616
 white iron, 618
 Cement tile roof covering, 37, 78
 Century Fan & Ventilating Corp., 75
 Chicago Bridge and Iron Works, 458, 478, 480, 489
 Chicago Pneumatic Tool Co., 581
 Chimneys, 443-501
 available draft, 443
 blast furnace gas, 453
 correction of sizes for altitude, 448
 draft and size, 443-453
 formulas for height and diameter, 449-452
 guyed steel stacks, 460-475
 losses of draft, 444
 oil fuel chimneys, 452
 rates of combustion of fuels, 447
 required draft for fuels, 447
 self-supporting steel, 475-501
 steel stacks, 453-475
 theory of draft, 443
 Clinch rivets, 67
 Clips for corrugated steel, 68
 Closing rivets for corrugated steel, 68
 Column formulas, 21, 22
 Columns, in steel mill buildings, 52-55
 bases, 53
 crane girder seats, 54
 truss connections to columns, 54
 types, 52
 in steel office buildings, 21-27
 comparison of types, 25
 formulas, 21
 Lally, 25
 requirements in column design, 21
 splices, 27
 types, 21
 wide-flange, 23-26

Columns, in timber mill construction, 120
 Combined trusses, analysis of, 283
 Conklin, C. D., Jr., 502
 Connectors, 386
 Cooper loading system, 290
 Cornices, 35, 36
 Corrugated steel roof covering, 37, 76
 Corrugated steel sheets, fastenings for, 64-70
 flashing for, 66
 in mill buildings, 64
 Costs of steel fabrication and erection, 611
 Crane girder seats, 54
 girders, 56
 rails, fastenings and stops, 57-59
 Creosoting processes for wood, 648
 Cross frames on steel railway bridges, 314
 Curtain walls for steel mill buildings, 70

D

Deck plate girder bridges, 295-323
 Definitions of building terms, 121-129
 Detroit Steel Products Co., 85, 91
 Dickinson, Paul, Inc., 75
 Doors for steel mill buildings, 82-85
 Downspouts for mill buildings, 75
 Duchemin formula for wind loads, 148

E

Elevated tanks, 423-441
 accessories, 434
 balcony girder, 426
 stress, 441
 bottom, 424
 capacity, 423
 designing practice, 434
 erection, 434
 foundations, 431
 height, 423
 lap joint efficiency table, 436
 number of plates in sheet rings, 428
 painting, 434
 post connection, 429
 riser pipe, 431
 riveted butt joint, table, 438
 roof, 428
 shape, 423
 standard size and shape, 424
 stresses in circular girder, table, 442

Elevated tanks, struts, 430
 tower and tank stresses, table, 440
 tower columns, 429
 rods, 431
 water heaters, 433
 legs, 434
 wind stresses, table, 440

Erection of steel, 564-569

Estimating steelwork, 595-616
 cost data, 610
 from plans, 596
 procedure, 593
 selling steel, 614
 sheet and forms, 600
 taking off, 600

F

Fabrication of structural steel, 516-563
 assembling of trusses, 543
 bidding on contracts, 517
 bridge machinery, 562
 burning, 535
 caulking plates, 536
 chamfering, 536
 cleaning, 546
 coping, 535
 costs, 611
 counterboring, 537
 finishing, 541
 fitting, 537
 forge shop, 547
 galvanizing, 547
 inspection, 544
 laying out, 525
 machine shop, 550-557
 organization of structural companies,
 516
 painting, 546
 planing, 536
 preparation of shop drawings, 518
 punching, reaming and drilling, 525
 receiving material, 523
 riveting, 538
 sand blasting, 546
 sawing, 535
 scarfing, 537
 shearing, 534
 shipping, 557
 shop organization, 520
 simplified shop work, 558-562
 templet shop, 522

Falsework, 565

Fastenings for corrugated steel, 67-70
 clinch rivets, 67
 clips, 68
 closing rivets, 68
 finish at doors and windows, 69
 heavy crane rails, 58
 nails, 69
 straps, 68
 wood nailers, 68

Federal Cement Tile Co., 78

Flashing for corrugated steel, 66

Flat roof coverings, 37

Fleming, R., 152

Floating foundations, 7

Floor construction, 93-102
 arrangement of girders, 95
 bridging, 94
 connections, to columns, 95
 to walls, 95
 spacing of joists, 93
 stud partitions, 99
 thickness of sheathing, 93
 typical floor bay design, 97

Floor loads for buildings, 3

Floors and floor construction, 12-21
 beam framing, 16
 requirements, 12
 standard vs. wide-flange shaped beams,
 12
 for steel mill buildings, 80
 timber framed, 93-113
 in timber mill construction, 118
 types, 14

Flynn, Michael, Manufacturing Co., 85,
 92

Footings, 8

Foundations for steel office buildings, 6-9

G

Girts in steel mill buildings, 59, 60

Glass for windows in mill buildings, 85

Gray columns, 24, 27

Grillage beams, 8

Gutters on steel mill buildings, 75

Guyed steel stacks, 460-475
 design of, 461-471
 pull on guy wires, 463
 thickness of plates, 461
 unit stress in plates due to wind
 moments, 470
 weight per foot, 461
 wind moments and reactions, 465-469

- H**
- Hammer-beam truss, stresses in, 281-283
 Heights of office buildings, 1
 Highway bridges, steel, 359-371
 dead load, 359
 impact, 359
 lateral forces, 361
 live load, 359
 loadings, 359, 360
 plate girder span, 361-368
 riveted low truss, 368-371
 Hingeless arches, 244-256
- I**
- Impact on steel railway bridges, 291
 Ingot iron, 620
 Interior steel stacks, 42-44
- J**
- Johns-Manville Co., 80
- K**
- Kellogg, M. W., Co., 451
 Ketchum formula, 225
 Kinnear Mfg. Co., 85
 Knee-braced trusses, 217-243
 bracing, design of, 239
 conditions of design, 225
 form, 217
 girts, design of, 237
 joints, design of, 236
 members and columns, design of, 229-236
 stress determination, methods of, 218-225
 stresses in members, 226-229
 Kyanizing process for preserving timber, 648
- L**
- Ladders in steel mill buildings, 60
 Lally columns, 25
 Lateral bracing on steel railway bridges, 312
 forces, 292
 Lintels, 34-35
 Loads, for buildings, 3
 on roofs, 145-152
- M**
- Loads, on steel highway bridges, 359, 360
 railway bridges, 289-292
 Locomotive boiler shop, assembling plant, 46-52
 Lumber, 681
- M**
- Marvin's formula for wind loads, 147
 Materials, 616-685
 cast iron, 616-619
 steel, 620-626
 timber, 626-685
 wrought iron, 619-620
 Metal lumber or structural pressed steel, 624
 Mill buildings, erection of, 591
 steel, 44-93
 Mill construction, timber, 106-113
 beams and girders, 109
 columns, 108
 details given by National Board of Fire Underwriters, 107
 floors, 109
 partitions, 110
 roofs, 109
 slow-burning, 113-121
 Mingle, J. G., 454
 Minneapolis system of roof covering, 77
 Monitor ventilators, 70-75
- N**
- Nails for corrugated steel, 69
 National Board of Fire Underwriters, building code, 107
 Lumber Manufacturers Assoc., 107-110
 Newlin, J. A., quoted, 634
 Nonpareil Skylight Co., 93
- O**
- Office buildings, erection of, 589
 steel, 1-44
 Ornamental roof trusses, 271-285
 architectural timber work, 271-274
 combined trusses, analysis of, 283
 hammer-beam truss, stresses in, 281-283
 joint details, 284
 scissors truss, stresses in, 274-281

P

- Party piers, 8
 - walls, 28-29
- Philip Carey Co., 80
- Pile foundations, 7
- Piling, specifications for, 682-685
- Pin-connected truss bridges, 342-358
- Pintle construction, 113
- Pitched roof coverings, 37
- Plate-and-angle column, 22-26
- Plate-and-channel column, 22-26
- Plate girder span for steel highway bridge, 361-368
- Platforms in steel mill buildings, 60
- Pond continuous sash, 92
- Prepared roofings, 79
- Preservatives for wood, 646-649
- Purlins, for sloping roofs, 152-161
 - conditions of design, 153
 - design for flexible roof covering, 155
 - for rigid roof covering, 153
 - lateral support for, 157
 - load carried by, 152
 - unsymmetrical bending, 152
- in steel mill buildings, 59
 - (See also Roof trusses)

R

- Rail clips, 57
- Railings in steel mill buildings, 60
- Rails, crane, for mill buildings, 57
- Railway bridges, steel, 286-358
 - choice of type, 286
 - cover plates, length of, 304-306
 - cross frames, 314
 - dead load, 289
 - deck plate girder, 295-323
 - economical span length, 287
 - end bearings, 321
 - I-beam bridges, 292-294
 - impact, 291
 - lateral bracing, 312
 - forces, 292
 - live load, 290
 - pin-connected truss, 342-358
 - rivet spacing in flanges, 306-310
 - riveted truss, 328-342
 - specifications, 687-716
 - splices for flange elements, 320
 - stiffeners, design of, 310
 - through plate girder, 323-328
 - web splices, 315-320
- Reactions in arched roof trusses, 247-259
- Repach and McGregor, 489
- Retaining walls, 9-12
- Ridge roll, in steel mill buildings, 67
- Rivet spacing in flanges, on steel railway bridge, 306-310
- Riveted low truss highway bridge, 368-371
- Riveted truss bridges, 328-342
- Robertson, H. H., Co., 93
- Roof construction, 102-106
 - arrangement of girders or trusses, 102
 - bracing trusses, 103
 - saw-tooth roof framing, 105
 - spacing of roof construction, 102
 - thickness of sheathing, 102
- Roof coverings for steel mill buildings, 76-80
 - cement tile, 78
 - corrugated steel, 76
 - prepared roofings, 79
 - slate, 78
 - tar and gravel, 77
- Roof trusses, 130-285
 - arched, 243-271
 - bracing of roofs and buildings, 140
 - choice of sections, 142
 - combinations of loads, 150
 - connections between purlins and roof coverings, 140
 - form, 131
 - of members, 143
 - general design, 130-152
 - girts, spacing of, 137
 - joint details, 144
 - joints, design of, for steel trusses, 201-209
 - for wooden roofs, 169-190
 - knee-braced trusses, design of, 217-243
 - loadings for, 145
 - ornamental, 271-285
 - pitch, 133
 - purlin and girt details and connections, 137
 - purlins, design of, 152-161
 - spacings of, 135
 - snow loads, 149
 - spacing, 134
 - steel, design of, 191-216
 - in steel mill buildings, 55
 - weight of, 146
 - wind loads, 147
 - wooden, design of, 161-191

- Roofing, corrugated steel, 66
 Roofing manufacturers, 80
 Roofs, 36-38
 Roofs, coverings, 37, 38
 design of 36
 drainage, 36
 timber framed, 93-113
 of timber mills, 119
 Royal Ventilator Company, 75
 Ruberoid Co., 80
- S
- Safety requirements in mill buildings, 45
 Sash, steel, 44
 Saw-tooth roof framing, 105
 Scissors truss, stress in, 274-281
 Self-supporting steel chimneys, 475-501
 base plate, design of, 482
 conical section at base, 477
 design, 477-487, 489-501
 erection, 487
 foundation bolts, design of, 479
 foundations, design of, 484-487
 Jerome, Ariz., chimney, 489
 weights, 475-477
 Short span steel bridges, 286-371
 highway bridges, 359-371
 railway bridges, 286-358
 Siding of corrugated steel, 66
 Skylight construction, 40
 Skylights, in steel mill buildings, 91
 Slabs used in foundations, 9
 Slate roof covering, 78
 Slow-burning timber mill construction, 113-121
 anchoring of steel beams, 119
 basement floors, 120
 beam arrangements, special, 117
 columns and walls, 120
 floor details, 118
 location of beams, 117
 pintles over columns, 113
 rigidity of connection, 116
 roofs, 119
 Snow loads, 149
 Soils, bearing capacity, 6
 Spandrels, 33, 34
 architectural requirements, 33
 kinds of beams, 34
 Splices for flange elements in steel rail-
 way bridges, 320
 Spouts for mill buildings, 75
- Stacks, interior steel, 42-44
 lining, breeching, etc., 44
 self-supporting, 42
 supported by floors, 43
 Stacks, steel, 453-475
 allowable unit stresses, 456
 baffle plates, 456
 breech opening, 455
 corrosion, 456
 effect of earthquake shocks, 454
 forces acting on, 453
 guyed, 460-475
 lap joints, 458
 lining, 455
 rivets and rivet spacing, 457
 wind pressure, 453
 in steel mill buildings, 63
 Stairs in steel mill buildings, 60
 Steel, 620-626
 alloy, 622
 carbon-steel, 622
 castings, 623
 elements, 620
 examination of structural, 624
 forgings, 624
 manufacturing methods, 621, 622
 metal lumber, 624
 rivet, 723
 rolled shapes, 624
 specification of bridge and building,
 717-722
 Steel bridges, highway, 359-371
 railway, 286-358
 short span, 286-371
 Steel doors, for mill buildings, 84
 Steel erection, 564-595
 blocks, 572
 bolting, 579
 cantilever erection, 587
 chains, 576
 costs, 611
 derricks, 569
 details to facilitate, 591
 equipment, 566
 falsework, 565
 floating spans into position, 587
 gin poles, 571
 ginny winks, 571
 girder spans, 583
 hoists, 572
 hooks, 576
 locomotive erecting cranes, 568
 methods, 583

- Steel erection, mill buildings, 591
 - miscellaneous tools, 576
 - office buildings, 589
 - organization of forces, 564
 - pin truss spans, 585
 - pinning, 579
 - riveted truss spans, 584
 - riveting, 579
 - rope, 574
 - shear legs, 572
 - steel derrick car, 568
 - travelers, 566
 - viaducts, 589
- Steel mill buildings, 44-93
 - bracing, 59
 - columns, 52-55
 - construction, 44
 - corrugated steel sheets, 64
 - crane girders, 56
 - rails, fastenings and stops, 57-59
 - curtain walls, 70
 - doors, 81-85
 - fastenings for corrugated steel, 67-70
 - flashing for corrugated steel, 66
 - floors, 80-81
 - gutters and downspouts, 75
 - ladders, 60
 - locomotive boiler shop, 46-52
 - platforms, 60
 - purlins and girts, 59, 60
 - railings, 60
 - ridge roll, 67
 - roof coverings, 76-80
 - trusses, 55, 56
 - roofing of corrugated steel, 66
 - safety requirements, 45
 - siding of corrugated steel, 66
 - stacks, 63
 - stairs, 60
 - steel sash, 44
 - types of buildings, 45
 - ventilators, 70-75
 - windows and skylights, 85-93
- Steel office buildings, 1-44
 - balcony construction, 38-40
 - bearing capacity of soils, 6
 - caissons, 7
 - cantilever foundations, 8
 - cast-iron bases, 9
 - columns, 21-28
 - cornices, 35, 36
 - design, 2
 - erection, 589
 - Steel office buildings, floating foundations, 7
 - floors and floor construction, 12-21
 - footings, 8
 - foundations, 6-9
 - grillage beams, 8
 - interior steel stacks, 42-44
 - legal heights, 1
 - lintels, 34, 35
 - minimum floor loads, 3
 - party pier, 8
 - walls, 28, 29
 - pile foundations, 7
 - retaining walls, 9-12
 - roofs, 36-38
 - skylight construction, 40
 - slabs used in foundations, 9
 - spandrels, 33, 34
 - sub-basement construction, 11
 - towers, 41, 42
 - unit stresses, 3, 5
 - wind bracing, 29-33
- Steel railway bridges, short span, 286-358
 - specifications, 687-716
- Steel roof trusses, 191-216
 - bracing, design of, 215
 - conditions for design, 191
 - joints, design of, 201-209
 - loadings, 193
 - members, design of, 198
 - minor details, 209
 - purlins, design of, 195
 - sheathing, 193
 - stresses in members, 195
 - top chord, design of, 210
 - type and form, 192
 - weight, 210
- Steel sash, 44
 - in mill buildings, 91
- Steel stacks, 453-475
 - guyed, 460-475
- Steel tanks, 406-442
 - elevated tanks and towers, 423-442
 - vertical cylindrical, 406-423
- Steelwork, estimating, 596-615
- Steinman, D. B., set of loadings, 290
- Stiffeners on steel railway bridges, 310
- Stops, crane, 58
- Straps for corrugated steel, 68
- Stress on steel, 3, 5
- Stresses, in arched roof trusses, 247-259, 260-266
 - in a hammer-beam truss, 281-283

- Stresses, on knee-braced roof trusses, 218-229
 in members of steel roof trusses, 195
 permissible, for timbers, 380-381
 in a scissors truss, 274-281
- Structural steel detailing, 502-515
 assembling marks, 507
 drafting room organization and procedure, 502
 layouts, 504
 ordering material, 503
 shop detail drawings, 505
 typical detail drawings, 508
- Structural steel fabrication, 516-563
 specifications for bridges, 687, 709, 717
 for buildings, 717-722
- Sub-basement construction, 11
- T
- Tanks, elevated, 423-442
 steel, 406-442
 vertical cylindrical, 406-423
- Tar and gravel roofing, 37, 77
- Three-hinged arches, 244
 members and joints, 266-271
 reactions, determination of, 247-253
 stresses, determination of, 260-266
- Through plate girder bridges, 323-328
- Timber, 626-685
 brush treatment, 647
 Burnettizing process, 647
 calorific value, 633
 card process, 633
 cleavability, 633
 columns, unit stresses, 381
 connector joints, 388
 connectors, 386, 387
 creosoting processes, 648
 decay of wood, 645
 defects, natural, 628-631
 of manufacture, 631
 definitions, 627
 destruction by insects and marine animals, 645
 hardness, 632
 kyanizing or mercuric-chloride treatment, 648
 length of life of wood, 644
 lumber, 681
 names, 626
 open-tank treatment, 649
 piling, 683
- Timber, preservation, 646-649
 protection against fire, 649
 records by dating nails, 649
 seasoning, 646
 specifications for grading, 650-681
 strength, tables, 633-644
 treated wood, strength of, 644
 unit stresses, 380
 weight, 632
 zinc chloride treatment, 647
- Timber bridges and trestles, 372-405
 design of, 382-396
 details, 396-405
 deteriorating conditions, 379
 erection equipment, 378
 factors affecting design and construction, 373-381
 floor systems, 396
 floors, 382
 general considerations, 372
 length of life, 376
 loads, 376
 materials, 376
 method of erection, 378
 permissible stresses for timbers, 380, 381
 trestles, design of, 384
 details of, 399
 truss bridges, design of, 387-396
 trusses, 401-404
- Timber Engineering Co., 386
- Timber framed floors and roofs, 93-113
 floor construction, 93-102
 roof construction, 102-106
- Timber mill construction, 106-121
- Towers, 41, 42
 water (*see* Elevated tanks)
- Trestles, timber, 372-405
- Truscon Steel Co., 91
- Trusses on timber bridges, 401-405
 roof, 103
 in steel mill buildings, 55
- Two-hinged arches, 244, 253
- U
- Unit stress, on steel, 3, 5
 on timber, 380
 on timber columns, 381
- United States Steel Corp., rules for stairs, etc., 60
 safety requirements, 45
- United Verde Copper Co., 489

V

- Ventilators in steel mill buildings, 70-75
 - circular, 74
 - monitors, 70
- Vertical cylindrical tanks, 406-423
 - accessories, 422
 - anchor bolt connections, 416
 - bottom plates, 414
 - caulking at bottom angle, 414
 - erection, 418
 - foundations, 420
 - horizontal joints. design of, 413
 - manhole, 417
 - overturning due to wind, 416
 - pipe connections, 417
 - plates, size of, 407
 - thickness of, 407
 - rivets, 420
 - roof, 419
 - scarfing, 420
 - size, 406
 - standard, 416

W

- Waddell, Dr., analysis of span length for railway bridge, 288
- Web splices, on steel railway bridges, 315-320
- Weights of building materials, 145
- Weymouth, C. R., 452

- Wide-flange beams vs. columns, 23, 26
 - vs. standard shapes, 12
- Wind bracing, 29-33
 - resistance to wind stresses, 29
 - types of girders, 31
 - wind load requirements, 29, 30
- Wind loads on roofs, 147
- Windows and skylights in steel mill buildings, 85-93
 - glass, 85
 - steel sash, 91
 - wooden sash, 89
- Wood (*see* Timber)
- Wood nailers for corrugated steel, 68
- Wooden doors, 82
- Wooden roof trusses, 161-191
 - conditions assumed for design, 161
 - joints, design of, 169-190
 - members, design of, 166
 - sheathing, rafters, and purlins, 164
 - stresses in members, 165
 - weight, 190
- Wooden sash in steel mill buildings, 89
- Wrought iron, 619, 620
 - ingot iron and copper bearing metal, 620
 - manufacture, method of, 619
 - physical properties of, 619
 - structure of, 619
 - uses of, 619

