

BIRLA CENTRAL LIBRARY
PILANI [RAJASTHAN]

Class No. 940.2

Book No. L 82 C

Accession No. 59253

Presented by ;—
Shri Motilall Lath.
of
MANDRELLA.

In Eight Volumes. Crown 8vo. With Maps, etc.
Six Shillings net each Volume.
The Complete Set £2, 8s. net.

PERIODS OF EUROPEAN HISTORY

General Editor—ARTHUR HASSALL, M.A.,
Student of Christ Church, Oxford.

THE object of this series is to present in separate Volumes a comprehensive and trustworthy account of the general development of European History, and to deal fully and carefully with the more prominent events in each century.

The Volumes embody the results of the latest investigations, and contain references to and notes upon original and other sources of information.

No such attempt to place the History of Europe in a comprehensive, detailed, and readable form before the English Public has previously been made, and the Series forms a valuable continuous History of Mediæval and Modern Europe.

Period I.—The Dark Ages. 476-918.

By C. W. C. OMAN, M.A., Chichele Professor of Modern History in the University of Oxford. *6s. net.*

Period II.—The Empire and the Papacy. 918-1273.

By T. F. TOFT, M.A., Professor of Mediæval and Modern History in the University of Manchester. *6s. net.*

Period III.—The Close of the Middle Ages. 1273-1494.

By R. LODGE, M.A., LL.D., Professor of History at the University of Edinburgh. *6s. net.*

Period IV.—Europe in the 16th Century. 1494-1598.

By A. H. JOHNSON, M.A., Historical Lecturer to Merton, Trinity, and University Colleges, Oxford. *6s. net.*

Period V.—The Ascendancy of France. 1598-1715.

By H. O. WAKEMAN, M.A., late Fellow of All Souls' College, Oxford. *6s. net.*

Period VI.—The Balance of Power. 1715-1789.

By A. HASSALL, M.A., Student of Christ Church, Oxford. *6s. net.*

Period VII.—Revolutionary Europe. 1789-1815.

By H. MORSE STEPHENS, M.A., Professor of History at the University of California, Berkeley, California, U.S.A. *6s. net.*

Period VIII.—Modern Europe. 1815-1899.

By W. ALISON PHILLIPS, M.A., formerly Senior Scholar of St. John's College, Oxford. *6s. net.*

THE DARK AGES, 476-918

By C. W. C. OMAN, M.A., Chichele Professor of Modern History in the University of Oxford.

Forming Volume I. of PERIODS OF EUROPEAN HISTORY.

'A thorough master of his subject, and possessed of a gift for clear expositions, he has supplied the student with a most valuable and helpful book.'—*Spectator*.

'No better exponent of this era, so full of difficulties and complications, could have been chosen.'—*Journal of Education*.

'Mr. Oman has done his work well. His narrative is clear and interesting, and takes full account of recent research.'—*English Historical Review*.

'This volume will be valued by all historical students as supplying a real want in our historical literature, and supplying it well. . . . His touch is sure and his insight keen. For the accuracy of his facts his historical reputation is a sufficient guarantee.'—*Times*.

THE EMPIRE AND THE PAPACY, 918-1273

By T. F. TOUT, M.A., Professor of Mediæval and Modern History in the University of Manchester.

Forming Volume II. of PERIODS OF EUROPEAN HISTORY.

'This admirable and impartial work. . . . A more trustworthy historical treatise on the period and subject has not hitherto appeared.'—*Morning Post*.

'One of the best of the many good historical textbooks which have come out of our universities in recent years.'—*Times*.

'Altogether Professor Tout has given us a most trustworthy adjunct to the study of mediæval times, which all who may be called upon to interpret those times to others may safely recommend and themselves profit by.'—*English Historical Review*.

THE CLOSE OF THE MIDDLE AGES, 1273-1494

By R. LODGE, M.A., LL.D., Professor of History at the University of Edinburgh.

Forming Volume III. of PERIODS OF EUROPEAN HISTORY.

'The book is admirably written, it contains maps and genealogical tables, an exhaustive index, and a bibliography which students will value as an aid to the interpretation of the whole period as well as a clue to any part of it.'—*Standard*.

'We are exceedingly thankful for the Series, and as we have already said, to Prof. Lodge. There is no longer any excuse for English-speaking teachers to be wholly ignorant of the history of Europe. The obligation lies on them to purchase these volumes, and then read, mark, learn, and inwardly digest them, so that they can supplement their teaching with intelligible comment.'—*School World*.

'The book must be regarded as quite indispensable to all English students of the late Middle Ages.'—*University Correspondent*.

'Professor Lodge's book has the supreme merit of clearness, not less than that of conciseness.'—*Pall Mall Gazette*.

'A work of great value on one of the most difficult and at the same time one of the most important periods of European history. The book is a monument of skill and labour.'—*Aberdeen Journal*.

EUROPE IN THE 16TH CENTURY, 1494-1598

By A. H. JOHNSON, M.A., Historical Lecturer at Merton, Trinity,
and University Colleges, Oxford.

Forming Volume IV. of PERIODS OF EUROPEAN HISTORY.

'A singularly clear, thorough, and consistent account of the great movements and great events of the time, and the volume may be accepted as one of the best extant handbooks to a period as complex as it is important.'—*Times*.

'In the present volume Mr. A. H. Johnson has made a useful and unpretentious contribution to a Series of which it can be said more truly than of most series that it supplies a real want. Mr. Johnson is well known as one of the most experienced and successful teachers of history at Oxford, and the book has all the merits which the fact of being written by a good teacher can give it. It is clear, sensible, and accurate, and commendably free from fads or bias.'—*Manchester Guardian*.

'There is certainly no other single book in English which covers the ground so adequately.'—*University Correspondent*.

'Mr. Johnson's narrative is clear and accurate, and his grasp of the history of his period wonderfully strong and comprehensive.'—*Journal of Education*.

THE ASCENDANCY OF FRANCE, 1598-1715

By H. O. WAKEMAN, M.A., Late Fellow of All Souls College, Oxford.

Forming Volume V. of PERIODS OF EUROPEAN HISTORY.

'His story is no dry compendium, but a drama, each act and scene of which has its individual interest.'—*Guardian*.

'Mr. Wakeman has produced an excellent sketch, both clear and concise.'—*Oxford Magazine*.

'Mr. Wakeman's book is a sound, able, and useful one, which will alike give help to the student, and attract the cultivated general reader.'—*Manchester Guardian*.

'A thoroughly scholarly and satisfactory monograph.'—*Leeds Mercury*.

THE BALANCE OF POWER, 1715-1789

By A. HASSALL, M.A., Student of Christ Church, Oxford.

Forming Volume VI. of PERIODS OF EUROPEAN HISTORY.

'Although it contains more than 400 pages, we felt as we read its last page that it was too short. It is not, however, too short to prevent its author dealing adequately with his subject according to the scheme of the whole Series. There is little detail in it, and but little theorising, and what it contains are clear statements of masterly summaries. . . . We may cordially recommend this interesting and well-written volume.'—*Birmingham Daily Gazette*.

'Treated with much accuracy, patience, and vigour.'—*Educational Times*.

'The author has struggled manfully with the difficulties of his subject, and not without a distinct measure of success. He has availed himself of the latest researches on the period, and his narrative is well ordered and illustrated by excellent maps and some useful appendices.'—*Manchester Guardian*.

REVOLUTIONARY EUROPE, 1789-1815

By H. MORSE STEPHENS, M.A., Professor of History at the University of California, U.S.A.

Forming Volume VII. of PERIODS OF EUROPEAN HISTORY.

'As a piece of literary workmanship can hardly be surpassed. . . . The result is a boon to students, and a serviceable book of reference for the general reader.'—*Daily News*.

'Mr. Stephens has written a very valuable and meritorious book, which ought to be widely used.'—*Manchester Guardian*.

'An admirable, nay, a masterly work.'—*Academy*.

'To say that Mr. Morse Stephens has compiled the best English textbook, on the subject would be faint praise.'—*Journal of Education*.

'We are happy to extend a hearty welcome to this much-needed Series, which, if it throughout keeps on the same high level of this volume, will fill up a painful gap in our accessible historical literature.'—*Educational Times*.

'The volume contains one of the clearest accounts of the French Revolution and the rise of the First Napoleon ever written. In fact, it is the work of a real historian. The style of the book is strong and picturesque.'—*Western Morning News*.

MODERN EUROPE, 1815-1899

By W. ALISON PHILLIPS, M.A., formerly Senior Scholar of St. John's College, Oxford.

Forming Volume VIII. of PERIODS OF EUROPEAN HISTORY.

'An exceedingly difficult task has been accomplished, we may say without hesitation, to admiration. We have read the book with the keenest and quite unflagging enjoyment, and we welcome it as one of the very best histories that have been written within the last few years.'—*Guardian*.

'It has achieved, with a remarkable success, the difficult task of compressing into a compact space the long history of a time of extraordinary complications and entanglements; but—much more important—it has never lost vigour and interest throughout the whole survey. . . . The completeness of the book is really extraordinary. . . . The book is by far the best and handiest account of the international politics of the nineteenth century that we possess. . . . Should give Mr. Alison Phillips distinct rank among historians of the day.'—*Literature*.

'Altogether, the book offers a most luminous and quite adequate treatment of its subject, and makes a worthy conclusion of a Series that well deserves to be popular.'—*Glasgow Herald*.

'He presents his materials with model clearness and arrangement, and with a sound literary style, which will make the book attractive to the general reader as well as useful to the student.'—*Scotsman*.

'Mr. Phillips shows decided literary power in the handling of a not too manageable period, and few readers with any appreciation of the march of history, having once commenced the book, will be content to lay it aside until the last page is reached.'—*Manchester Guardian*.

'This thoughtful volume will give the intelligent reader both profit and pleasure.'—*Spectator*.

THE CLOSE OF
THE MIDDLE AGES

1272-1494

BY

R. LODGE, M.A., LL.D.

PROFESSOR OF HISTORY IN THE UNIVERSITY OF EDINBURGH

PERIOD III

RIVINGTONS
34 KING STREET, COVENT GARDEN
LONDON

1910

Fourth Edition

All Rights Reserved

P R E F A C E

THE period treated in this volume is one of unique interest and significance in the history of Europe. Within these two centuries the political and social conditions of the so-called Middle Ages came to an end, and the states system of Modern Europe took its rise. But the importance of the period is more than equalled by the almost superhuman difficulty of narrating its events in anything like orderly and intelligible sequence. Such unity as had been given to Western Europe by the mediæval Empire and Papacy disappeared with the Great Interregnum in the middle of the thirteenth century; and such unity as was afterwards supplied by the growth of formal international relations cannot be said to begin before the invasion of Naples by Charles VIII. of France at the end of the fifteenth century. In the interval between these two dates there is apparent chaos, and only the closest attention can detect the germs of future order in the midst of the struggle of dying and nascent forces. It is easy to find evidence of astounding intellectual activity and instances of brilliant political and military achievement, but the dominant characteristic of the age is its diversity, and it is hard to

find any principle of co-ordination. A cursory glance over some of the most striking episodes of the period will serve to illustrate the multiplicity of its interests. The hundred years' war between England and France ; the rise and fall of the House of Burgundy ; the struggle of old and new conceptions of ecclesiastical polity in the Papal schism, in the Councils of Constance and Basel, and in the Hussite movement ; the marvellous achievements of the republic of Venice, and of Florence under both republican and Medicean rule ; the revival of art and letters, not only in one or two great centres, but in numerous petty states which would otherwise be wholly obscure ; the growth and decline of unique corporations, such as the Hanseatic League and the Teutonic Order ; the extension and gradual union of the Christian states of Spain at the expense of Mohammedanism, and at the same time the gloomy story of the conquest of the Eastern Empire by the Turks ;—all these episodes might well be treated in a volume apiece, but it is difficult to arrange them within the compass of a book which should deal with the general development of Europe. No doubt it may be held that some of these events are of more permanent importance than others, and that the essential fact to grasp in the period is the rise of great and coherent states like France, Spain, and England. But it is equally true that the important events are unintelligible without some knowledge of the less important events with which they are connected ; that in this period Germany and Italy are

more prominent than Spain and England, or even than France; and that Germany and Italy are not coherent states at all. The former is a bundle of states, and the latter can hardly be said to be as much. And it may be urged with some force that German history in the fourteenth century cannot be studied without some attention being paid to Poland, Hungary, and Denmark; that the history of Venice and Florence cannot be isolated from that of Genoa and Pisa; and that even in tracing the growth of states which achieved some measure of unity it is necessary to note the absorption of the formerly distinct and independent provinces.

I have stated the difficulty, which is indeed sufficiently obvious, but I cannot claim to have found a thoroughly satisfactory solution. My endeavour has been to make the narrative as clear and intelligible as the conflicting needs of conciseness and of frequent transitions will admit. I may perhaps point out to my readers that in an age in which dynastic interests and claims become of greater and greater importance, in which royal marriages are a prominent factor in international politics and vitally affect the growth of the greatest states, a careful study of genealogy is imperatively necessary. This will explain and justify the insertion of a number of genealogical tables in the Appendix, which the student of the period may find not the least useful part of the volume.

R. LODGE.

EDINBURGH, *April 1901.*

CONTENTS

CHAPTER	PAGE
BIBLIOGRAPHICAL NOTE,	x
CHRONOLOGICAL TABLE,	xii
I. GERMANY AND THE EMPIRE AFTER THE INTERREGNUM,	
1273-1313,	1
II. ITALY AND THE PAPACY, 1273-1313,	20
III. FRANCE UNDER THE LATER CAPETS, 1270-1328,	43
IV. FRANCE UNDER THE EARLY VALOIS, 1328-1380,	66
V. LEWIS THE BAVARIAN AND THE AVIGNON POPES,	
1314-1347,	98
VI. CHARLES IV. AND THE GOLDEN BULL,	109
VII. RISE OF THE SWISS CONFEDERATION,	124
VIII. ITALY IN THE FOURTEENTH CENTURY, 1313-1402,	139
IX. THE SCHISMS IN THE PAPACY AND EMPIRE, 1378-1414,	182
X. THE HUSSITE MOVEMENT AND THE COUNCIL OF	
CONSTANCE, 1409-1418,	206
XI. THE HUSSITE WARS AND THE COUNCIL OF BASEL,	
1419-1449,	222
XII. MILAN AND VENICE IN THE FIFTEENTH CENTURY,	
1402-1494,	243
XIII. NAPLES AND THE PAPAL STATES IN THE FIFTEENTH	
CENTURY,	265
XIV. FLORENCE UNDER THE MEDICI,	288
XV. BURGUNDIANS AND ARMAGNACS IN FRANCE, 1380-1435,	315
XVI. REVIVAL OF THE FRENCH MONARCHY, 1435-1494,	349
XVII. GERMANY AND THE HAPSBURG EMPERORS, 1437-1493,	394
XVIII. THE HANSEATIC LEAGUE AND THE SCANDINAVIAN	
KINGDOM	419

Contents

ix

CHAPTER	PAGE
XIX. THE TEUTONIC ORDER AND POLAND,	451
XX. THE CHRISTIAN STATES OF SPAIN,	468
XXI. THE GREEK EMPIRE AND THE OTTOMAN TURKS,	494
XXII. THE RENAISSANCE IN ITALY,	515
APPENDIX—GENEALOGICAL TABLES—	
A—The Succession in Bohemia,	535
B—The Succession in Tyrol,	535
C—The House of Hapsburg,	536
D—The House of Wittelsbach,	537
E—The House of Luxemburg,	538
F—The Later Capets in France,	539
G—The House of Valois,	540
H—The Duchy and County of Burgundy,	541
I—The First House of Anjou in Naples and Hungary,	542
K—The Second House of Anjou in Naples	543
L—The House of Aragon in Sicily and Naples,	544
M—The Houses of Visconti and Sforza in Milan,	545
N—The Medici in Florence,	546
O—The Union of Kalmar,	546
P—The Palæologi,	547
Q—Castile,	548
R—Aragon,	549
S—Navarre,	550
T—Some European Connections of the House of Portugal,	551
INDEX,	553

LIST OF MAPS

At end of Book

1. FRANCE, TO SHOW THE ADDITIONS TO THE MONARCHY BETWEEN 1273 AND 1494.
2. POSSESSIONS AND CLAIMS OF CHARLES THE BOLD, DUKE OF BURGUNDY, 1467-1477.
3. ITALY IN THE FIFTEENTH CENTURY.
4. THE SWISS CONFEDERATION.

BIBLIOGRAPHICAL NOTE

[The following list has no pretensions to be an exhaustive bibliography of the period, nor does it profess to include all the authorities consulted by the author. It is merely compiled with the object of offering suggestions to any student who wishes to read more widely, either on the whole period, or on any part of it. Those books which cannot be classed under any of the great European states are placed under the head of 'General.']

GENERAL—

- Lavisse et Rambaud, *Histoire Générale du IV^e. Siècle à nos jours*,
Tome III.
Creighton, *History of the Papacy during the Reformation*, Vols. I.-III.
Froissart, *Chroniques*. [A popular and useful selection from the translation of Lord Berners has been published by Messrs. Macmillan and Co. in the 'Globe' Series. The most complete edition is that by Kervyn de Lettenhove.]
Leroux, *Recherches Critiques sur les relations politiques de la France avec l'Allemagne*.
Fournier, *Le Royaume d'Arles*.
Oman, *History of War in the Middle Ages*.
H. C. Lea, *History of the Inquisition in the Middle Ages*.
R. L. Poole, *Illustrations of Medieval Thought*.

GERMANY—

- Nitzsch, *Geschichte des Deutschen Volkes*.
Lorenz, *Deutsche Geschichte im 13-14 Jahrhundert*.
Zeller, *Histoire de l'Allemagne*.
Droysen, *Geschichte der preussischen Politik*, Vols. I. and II.
Dierauer, *Geschichte der schweizerischen Eidgenossenschaft*.
Palacky, *Geschichte von Böhmen*.
Loserth, *Hus und Wiclif* (translated).
Sartorius, *Geschichte des Ursprunges der Deutschen Hanse*.
Schäfer, *die Hansestädte und König Waldemar von Dänemark*.
Treitschke, *Das Deutsche Ordenland Preussen*,
Historische und politische Aufsätze, Vol. II.

ITALY—

- Villani, *Croniche*.
Sismondi, *Histoire des Républiques italiennes au moyen âge*.

- Cipolla, *Storia delle Signorie Italiane, dal 1313 al 1530*.
 Gregorovius, *Geschichte der Stadt Rom im Mittelalter* (translated).
 Romanin, *Storia documentata di Venezia*.
 H. F. Brown, *Venice, an Historical Sketch*.
 Machiavelli, *Storia Fiorentina*.
 Perrens, *Histoire de Florence*.
 Guido Capponi, *Storia della repubblica di Firenze*.
 Napier, *Florentine History*.
 Villari, *Machiavelli* (translated), *Vol. 1*.
 Von Reumont, *Lorenzo de' Medici* (translated).
 Armstrong, *Lorenzo de' Medici*.
 J. A. Symonds, *Renaissance in Italy*.

FRANCE AND THE NETHERLANDS—

- Martin, *Histoire de France*.
 Michelet, *Histoire de France*.
 Langlois, *Le règne de Philippe le Hardi*.
 Boutaric, *La France sous Philippe le Bel*.
 Perrens, *Étienne Marcel*.
 S. Luce, *Histoire de la Jacquerie*.
 Vanderkindere, *Le siècle des Arteveldes*.
 Vallet de Viriville, *Histoire de Charles VII*.
 Beaucourt, *Histoire de Charles VII*.
 Cosneau, *Le Connétable de Richemont*.
 P. Clément, *Jacques Cœur et Charles VII*.
 Philippe de Commines, *Mémoires*.
 Barante, *Histoire des Ducs de Bourgogne*.
 Kirk, *History of Charles the Bold*.
 Clamageran, *Histoire de l'Impôt en France*.
 Gasquet, *Précis des Institutions Politiques et Sociales de l'ancienne France*.

SPAIN—

- Lafuente, *Historia general de España*.
 Burke, *History of Spain*, 2 vols.
 Schäfer und Schirmacher, *Geschichte von Spanien*.
 Prescott, *Ferdinand and Isabella*.

FALL OF THE GREEK EMPIRE—

- Gibbon, *Decline and Fall*.
 Finlay, *Byzantine and Greek Empires*.
 La Jonquière, *Histoire de l'Empire Ottoman*.

CHRONOLOGICAL TABLE

[This table has been drawn up in order to bring together in their chronological sequence those events in different parts of Europe which are necessarily treated in the text under the head of different states. The chief events in English History are inserted to serve as guide-posts, even though in some cases no direct reference may be made to them in the following pages.]

A. D.		
1273.	Election of Rudolf of Hapsburg as King of the Romans. Crowned at Aachen, October 24,	8
1274.	Death of Henry, King of Navarre and Count of Champagne and Brie. Philip III. of France annexes Champagne and Brie, and assumes the government of Navarre,	48
1276.	First war between Rudolf I. and Ottokar of Bohemia,	9
„	Death of Pope Gregory X.,	27
„	Death of James I. (the Conqueror) of Aragon. Accession of Peter III.,	479
1277.	Election of Pope Nicolas III.,	27
„	Archbishop Otto Visconti obtains the lordship of Milan,	36
1278.	Ottokar of Bohemia killed in the battle of Marchfeld (August 26). Accession of Wenzel II.,	10
1280.	The Teutonic Knights complete the conquest of Prussia,	456
„	Death of Pope Nicolas III.,	27
1281.	Election of Pope Martin IV.,	28
1282.	The Sicilian Vespers (March 30) lead to the transfer of Sicily from the house of Anjou to Peter III. of Aragon,	25
„	Constitutional changes in Florence,	32
„	Austria, Styria, and Carniola acquired by house of Haps- burg, and Carinthia given to Meinhard of Tyrol,	10
„	Death of the Greek Emperor Michael VIII., and accession of Andronicus II.,	497
„	Edward I. of England conquers Wales,	155
1283.	Peter III. of Aragon issues the 'General Privilege,'	481

Chronological Table

xiii

A.D.		PAGE
1284.	Battle of Meloria. The Pisans, defeated by the Genoese, lose their maritime importance,	31
„	Death of Alfonso X. (the Wise) of Castile. Accession of Sancho IV.,	48, 470
„	Charles of Valois accepts the crown of Aragon from the Pope. War between France and Aragon,	49
1285.	Death of Charles I., King of Naples (January 7). Accession of Charles II.,	25
„	Death of Pope Martin IV. (March 12). Election of Honorius IV.,	28
„	Death of Philip III. of France (October 5). Accession of Philip IV.,	49
„	Death of Peter III. of Aragon (November 11). Accession of Alfonso III. in Aragon and of James in Sicily,	25, 480
1286.	Accession of Eric Menved in Denmark,	430
„	Death of Alexander III. of Scotland,	157
1287.	Alfonso III. of Aragon issues the 'Privilege of Union,'	481
1288.	Death of Pope Honorius IV. Election of Nicolas IV.,	28
1291.	Death of Rudolf I. (July 15),	11
• „	Formation of League between Uri, Schwyz, and Unterwalden (origin of Swiss Confederation),	127
„	Fall of Acre puts an end to Christian dominion in the East,	456
„	Death of Alfonso III. of Aragon. Succeeded by his brother, James II.,	26, 480
1292.	Election of Adolf of Nassau as King of the Romans (May 5),	11
„	Death of Nicolas IV., followed by two years' interregnum in the Papacy,	28
„	Edward I. awards the Scottish crown to John Balliol,	157
1293.	'Ordinances of Justice' in Florence,	32
1294.	Election of Pope Celestine IV.,	28
„	Abdication of Celestine. Election of Boniface VIII.,	28
„	Outbreak of war between England and France,	51
1295.	John Balliol joins France against Edward I.,	52
„	Death of Archbishop Otto Visconti. Succeeded by his nephew Matteo,	36
„	Death of Sancho IV. of Castile. Accession of Ferdinand IV.,	470
1296.	Edward I. deposes John Balliol and conquers Scotland,	52
„	Boniface VIII. issues the bull <i>Clericis laicos</i> ,	29, 52
1297.	Rising in Scotland under Wallace,	160
„	Closing of the Great Council in Venice,	38
1298.	Peace between England and France negotiated by Boniface VIII.,	52

A.D.		PAGE
1298.	Death of Adolf of Nassau. Election of Albert I., . . .	13
1302.	Settlement of the long Sicilian wars. Frederick, brother of James II. of Aragon, recognised as King of Sicily, . . .	26
„	Defeat of French army by the Flemings at Courtrai (July 11),	53
„	First meeting of the States-General in France, . . .	60
„	Matteo Visconti driven from Milan, . . .	36
1303.	Outrage at Anagni, and death of Boniface VIII., . . .	29
„	Andronicus II. invites the 'Grand Company of the Catalans' into Greece, . . .	497
1304.	Election (February 25) and death (July 27) of Benedict XI.,	29
1305.	Election of Clement VII., who remains in France, . . .	30
„	Death of Wenzel II. of Bohemia. Election of Wenzel III.,	15
1306.	Death of Wenzel III. of Bohemia. Albert I. procures the crown for his son Rudolf, . . .	15
1307.	Death of Rudolf of Bohemia. Accession of Henry of Carinthia, . . .	16
„	Break-up of Seljuk Empire on death of Aladdin III., . . .	299
1308.	Murder of Albert I. Election of Henry VII. (of Luxemburg),	17
1309.	Charles Robert, grandson of Charles II. of Naples, recog- nised as King of Hungary, . . .	15
„	Headquarters of the Teutonic Order transferred from Venice to Marienburg, . . .	457
„	Clement v. fixes his residence in Avignon, . . .	30
„	Death of Charles II. of Naples. Accession of Robert, . . .	26
1310.	Origin of the Council of Ten in Venice, . . .	39
„	Henry VII. sets out on an expedition to Italy, . . .	17, 39
„	Henry of Carinthia driven from Bohemia, and the crown given to Henry VII.'s son John, . . .	18
1311.	Henry VII. restores Matteo Visconti in Milan, and appoints him imperial vicar, . . .	40
„	The Teutonic Knights acquire Pomerellen, . . .	458
1312.	Suppression of the Templars, . . .	55
„	Annexation of Lyons by Philip IV. of France, . . .	56
„	Henry VII. crowned Emperor in St. John Lateran, . . .	41
„	Death of Ferdinand IV. of Castile. Accession of Alfonso XI.,	470
1313.	Death of Henry VII. near Siena, . . .	18, 42
1314.	Battle of Bannockburn (June 24), . . .	168
„	Double election in Germany of Lewis the Bavarian and Frederick of Hapsburg, . . .	98
„	Death of Philip IV. of France (November 29). Accession of Louis X., . . .	62
„	Death of Clement v., and papal interregnum for two years,	98

Chronological Table

xv

A. D.	PAGE
1315. Swiss victory at the battle of Morgarten,	129
1316. Election of Pope John xxii.,	99
„ Death of Louis x. of France. Exclusion of his daughter Jeanne in favour of her uncle, Philip v. (so-called Salic Law),	64
1319. Death of Eric Menved, and accession of Christopher II. in Denmark,	431
1322. Defeat and capture of Frederick of Hapsburg at Mühldorf, .	99
„ Death of Philip v. of France. Accession of Charles iv., .	65
„ Galeazzo Visconti succeeds his father Matteo in Milan, .	174
1323. Lewis the Bavarian protests against the intervention of John xxii. Beginning of quarrel between Empire and Papacy,	99
„ Death of Waldemar, the last Ascanian Margrave of Branden- burg. Lewis the Bavarian gives Brandenburg to his eldest son Lewis,	107
1326. Orchan succeeds Othman as leader of the Ottoman Turks, .	499
1327. Lewis the Bavarian enters Italy and is crowned in Milan, .	105
1328. Lewis crowned Emperor in Rome,	105
„ Deposition of John xxii., and election of anti-pope, . . .	105
„ Scottish independence recognised by treaty of Northampton,	68
„ Death of Charles iv. of France. Accession of Philip vi. (of Valois),	65
„ Separation of France and Navarre: the latter goes to Jeanne, daughter of Louis x.,	66
„ Philip vi. defeats the Flemings at Cassel,	70
„ Andronicus II. deposed in favour of his grandson, Androni- cus III.,	498
„ Death of Castruccio Castracani, Lord of Lucca,	105, 143
„ Death of Galeazzo Visconti,	174
1329. Orchan defeats the forces of Andronicus III. at Pelekanon, .	499
„ Mastino della Scala succeeds Cangrande in Verona, . . .	143
„ Azzo Visconti becomes imperial vicar in Milan,	143, 174
1330. Death of Frederick of Hapsburg,	105
„ Lewis the Bavarian returns to Germany,	105
„ Luzern joins the league of the Swiss cantons,	130
„ John of Bohemia enters Italy and occupies Brescia,	144
1332. League of Italian states against John of Bohemia,	145
„ Edward Balliol obtains the Scottish crown, and does homage to Edward III.,	68
„ Death of Christopher II. followed by eight years' interreg- num in Denmark,	432

A.D.	PAGE
1333. John of Bohemia abandons Italy,	146
" Edward III. wins battle of Halidon Hill, takes Berwick, and restores Edward Balliol,	68
" David Bruce escapes to France, and French intervention in Scotland,	68
1334. Death of John XXII., and election of Benedict XII.,	102
1335. Death of Henry, Duke of Carinthia and Count of Tyrol, . . .	106
" Carinthia acquired by Hapsburgs, while Tyrol goes to Margaret Maultasch, wife of John Henry of Moravia,	107
1336. Rudolf Brun effects a revolution in Zürich,	131
" Rising in Ghent under Jacob van Artevelde,	71
" Death of James III. of Aragon, and accession of Peter IV., . .	481
1337. Edward III. claims the French crown and seeks allies in Flanders and Germany,	71
1338. Electoral meeting at Rense, and diet at Frankfurt to protest against papal pretensions in Germany,	102
" Meeting of Lewis the Bavarian and Edward III. at Coblenz, . . .	72
" League against Mastino della Scala. Verona loses its ascendancy in northern Italy,	147
1339. Edward III. invades France from Flanders. Beginning of Hundred Years' War. Unsuccessful campaign in Picardy,	72
" Death of Azzo Visconti. Succeeded by his uncle Lucchino,	175
1340. Naval victory of the English at Sluys,	72
" Edward repulsed from Tournay, concludes truce with Philip VI.,	72
" Succession dispute in Brittany on death of John III.,	73
" Alfonso XI. of Castile defeats the Moors in battle of the Salado,	471
" Waldemar III. restores monarchical power in Denmark,	433
1341. Lewis the Bavarian divorces Margaret of Maultasch from John Henry of Moravia, and marries her to his son, Lewis of Brandenburg,	107
" Death of Andronicus III., and accession of John V.,	500
1342. Edward III. supports John de Montfort in Brittany,	73
" Death of Carobert of Hungary, and accession of Lewis the Great,	152
" Death of Benedict XII., and election of Clement VI.,	106
1343. Death of Robert of Naples, and accession of Joanna I.,	152
" Expulsion of Walter de Brienne, and constitutional changes in Florence,	148
" Treaty of Kalisch between Poland and the Teutonic Order,	458
1345. Murder of Andrew of Hungary, husband of Joanna of Naples, . .	152

Chronological Table

xvii

A.D.	PAGE
1345. Assassination of Jacob van Artevelde,	74
„ Death of William IV. of Holland, Hainault, and Zealand. His territories pass to a son of Lewis the Bavarian,	75, 108
1346. Opposition in Germany to Lewis the Bavarian. Election of Charles IV. as King of the Romans,	108
„ Battle of Crecy,	76
„ Death of John of Bohemia,	108
„ Defeat of the Scots at Nevill's Cross,	77
„ Esthonia handed over by Denmark to the Teutonic Order,	458
1347. Lewis the Great of Hungary attacks Naples. Joanna flies to Provence,	153
„ Triumph of Rienzi in Rome,	157
„ Edward III. takes Calais (August 4),	77
„ Death of Lewis the Bavarian (October 11),	108
„ Abdication of Rienzi (December 15),	159
„ John Cantacuzenos recognised as joint emperor in Constantinople,	501
1348. Outbreak of the Black Death in Europe,	78
„ Battle of Epila. Peter IV. of Aragon revokes the 'Privilege of Union,'	482
„ Lewis de Mâle recovers his authority as Count of Flanders,	78
„ Foundation of the University of Prague by Charles IV.,	113
„ Joanna of Naples sells Avignon to Pope Clement VI.,	153
1349. Death of Lucchino Visconti. Succeeded by Giovanni, Archbishop of Milan,	175
„ Annexation of Dauphiné to France,	78
„ Death of Jeanne of Navarre, and accession of Charles the Bad,	79
„ Charles IV. succeeds in overcoming opposition in Germany,	111
1350. Death of Philip VI. of France (August 22), and accession of John,	79
„ Death of Eudes IV., Duke and Count of Burgundy. Succeeded by Philip de Rouvre,	79
„ Death of Alfonso XI. of Castile, and accession of Peter the Cruel,	471
„ Giovanni Visconti obtains Bologna,	160, 175
„ Outbreak of war between Venice and Genoa,	170
1351. Zürich joins the Swiss League,	132
„ Peace between Lewis of Hungary and Joanna of Naples,	153
1352. Albert II. of Austria attacks Zürich. Glarus and Zug join the Confederation,	134
„ Death of Pope Clement VI., and election of Innocent VI.,	160

A. D.		PAGE
1353.	The accession of Bern completes the eight old cantons of the Swiss Confederation,	135
„	Innocent VI. sends Cardinal Albornoz to recover the Papal States, almost lost during the residence in Avignon,	160
„	Genoa, defeated in naval war with Venice, submits to Milan,	170
1354.	Rienzi's return to Rome and his death,	161
„	Genoese victory in the battle of Sapienza,	171
„	Death of Giovanni Visconti. Milanese dominions divided between his three nephews,	175
„	John Cantacuzenos compelled to abdicate,	502
„	Turks seize Gallipoli, their first possession on European soil,	502
1355.	Renewal of English invasion of France,	80
„	Charles IV. crowned Emperor in Rome,	114
„	Important meeting of States-General in France,	81
„	Conspiracy and death of Marin Falier in Venice,	169
„	Peace between Venice and Genoa,	171
„	Assassination of Matteo Visconti. Partition of Milanese territories between Bernabo and Galeazzo,	176
„	Death of Stephen Dushan, King of Serbia,	501
1356.	Battle of Poitiers, and capture of John of France,	81
„	States-General under the guidance of Etienne Marcel,	83
„	Charles IV. issues the Golden Bull,	115
„	Genoa repudiates Milanese suzerainty,	171, 176
1358.	Rising of the Jacquerie in France,	87
„	Assassination of Marcel, and restoration of order and royal authority by Charles, Duke of Normandy, acting as regent during his father's captivity,	88
„	Death of Albert II. of Austria, leaving his territories to the joint rule of four sons,	136
1359.	Death of Orchan. Succeeded by Amurath or Murad I.,	502
1360.	Treaty of Bretigni (May 8) ends first period of the Hundred Years' War,	89
„	Cardinal Albornoz recovers Bologna from the Visconti,	161, 177
1361.	Death of Philip de Rouvre. Duchy of Burgundy granted by John of France to his fourth son, Philip,	90
„	Sack of Wisby by Waldemar III. Beginning of war between Denmark and the Hanseatic League,	433
„	Amurath I. seizes Adrianople, which becomes the European capital of the Turks till 1453,	502
1362.	Death of Pope Innocent VI., and election of Urban V.,	161
„	Defeat of the Hanseatic League by Danish fleet,	434

Chronological Table

xix

A.D.	PAGE
1363. Death of Meinhard, Duke of Upper Bavaria and Count of Tyrol. Upper Bavaria united with Lower Bavaria: Tyrol acquired by the Hapsburgs,	120
„ Marriage of Margaret of Denmark to Hakon of Norway,	435
1364. John of France returns to England and dies there. Accession of Charles v.,	188
„ Treaty of mutual inheritance between the houses of Luxembourg and Hapsburg,	120
„ Charles of Blois killed at battle of Aurai,	92
„ Deposition of Magnus of Sweden in favour of Albert of Mecklenburg,	436
1365. Death of Rudolf of Hapsburg,	137
„ Settlement of Breton war by the recognition of John de Montfort,	92
„ Treaty of Wordingborg between Waldemar III. and Hanse towns,	436
1366. Peter the Cruel, driven from Castile by Henry of Trastamara, flies to the Black Prince at Bordeaux,	93, 473
1367. The Black Prince wins the battle of Najara, and restores Peter the Cruel in Castile,	93, 473
„ Urban v. returns from Avignon to Rome,	162
„ Meeting of Hanseatic League at Cologne declares war against Denmark,	437
1368. Charles IV. visits Urban v. in Rome,	162
„ Death of Cardinal Albornoz,	162, 177
„ Triumph of the Hanseatic fleet: capture of Copenhagen,	438
1369. Battle of Montiel. Death of Peter the Cruel. Accession of Henry of Trastamara (Henry II.) in Castile,	94, 474
„ Renewal of war between France and England,	94
„ The eastern Emperor John v. visits Rome, and agrees to a union between the Greek and Latin Churches,	503
1370. Partition of Hapsburg territories between Albert III. and Leopold,	137, 398
„ Massacre at Limoges by order of the Black Prince,	95
„ Urban v. returns from Rome to Avignon,	162
„ Treaty of Stralsund. Hanseatic League at the zenith of its power,	438
„ Death of Casimir the Great of Poland. Succeeded by Lewis of Hungary,	459
1372. Defeat of the English fleet by Spaniards and French off La Rochelle,	95
1373. Disastrous expedition of John of Gaunt to France,	95
„ The Emperor Charles IV. acquires Brandenburg,	441

A.D.	PAGE
1375. Truce between England and France, leaving England in occupation of Calais, Bordeaux, and Bayonne, . . .	96
,, Death of Waldemar III. of Denmark. Accession of Olaf, . . .	442
1376. Death of the Black Prince (June 8),	96
,, Election of Wenzel as King of the Romans,	121
1377. Death of Edward III. of England. Accession of Richard II., . . .	96
,, Gregory XI. leaves Avignon for Rome,	162, 185
1378. Death of Gregory XI. in Rome. Election of Urban VI.,	162, 185
,, Rising of the ' Ciompi ' in Florence,	164
,, Outbreak of war between Venice and Genoa,	172
,, Galeazzo Visconti dies and is succeeded by Gian Galeazzo,	177
,, Election of anti-pope Clement VII. (Sept. 20). Beginning of the great schism,	122, 162, 186
,, Death of the Emperor Charles IV. (Nov. 29). Partition of his dominions,	123
1379. The Genoese seize Chioggia and blockade Venice,	172
,, Death of Henry II. of Castile, and accession of John I.,	474
1380. Death of Charles V. of France, and accession of Charles VI.,	97, 315
,, Death of Hakon of Norway. Union of Norway and Denmark under Olaf,	442
,, The Genoese are forced to capitulate at Chioggia. Triumph of Venice,	173
,, Death of Lewis the Great, King of Hungary and Poland,	190, 459
1381. Rising of the lower classes in England,	316
1382. Counter-revolution in Florence establishes oligarchy,	166
,, Rising of the <i>Maillotins</i> in Paris,	317
,, Rising of the Flemings under Philip van Artevelde,	317
,, French defeat of the Flemings at Roosebek,	318
,, Suppression of the <i>Maillotins</i> in Paris,	318
,, Death of Joanna I. of Naples. Accession of Charles III.,	154
1383. Death of Lewis de Mâle. His son-in-law, Philip of Burgundy, acquires Flanders, Artois, Nevers, Rethel, and Franche-Comté,	320
1385. Gian Galeazzo Visconti imprisons his uncle, Bernabo, and reunites the Milanese dominions,	177
,, Charles III. of Naples claims crown of Hungary,	191
,, Portuguese victory at Aljubarrota over Castilians,	474
,, Death of Louis of Anjou, who had obtained Provence but had been defeated by Charles III. as a claimant to Naples,	154
1386. Jagello of Lithuania marries Hedwig, younger daughter of Lewis the Great, becomes a Christian, and is crowned King of Poland,	191, 459

Chronological Table

xxi

A. D.	PAGE
1386. Valentina Visconti married to Louis of Orleans, . . .	178, 321
„ Charles III. of Naples assassinated in Hungary, . . .	155, 191
„ Swiss victory at Sempach. Defeat and death of Leopold of Hapsburg,	138
„ John of Gaunt advances the claim of his wife, Constance, in Castile,	474
„ Schleswig ceded by Denmark to Count of Holstein, . . .	442
1387. Sigismund of Luxemburg crowned King of Hungary, . . .	192
„ Outbreak of town-war in Germany,	189
„ Death of Peter IV. of Aragon. Accession of John I., . . .	482
„ John of Gaunt withdraws his wife's claim and makes peace with John I. of Castile,	475
„ Gian Galeazzo seizes Verona and Vicenza, and ruins the house of Scala,	179
„ Death of Olaf of Denmark and Norway. Succeeded by his mother, Margaret,	443
1388. Padua subjected by Gian Galeazzo Visconti,	179
„ Albert of Sweden deposed; crown offered to Margaret of Denmark and Norway,	443
1389. Peace of Eger closes the town-war in Germany,	190
„ Hapsburgs recognise by treaty the independence of the Swiss Confederation,	138
„ Turkish victory at Kossova,	503
„ Amurath I. succeeded by Bajazet I.,	503
„ Death of Urban VI. Election of Boniface IX.,	187
1390. Death of John I. of Castile, and accession of Henry III., . .	475
1391. Mary of Sicily marries Martin the Younger, son of Martin I. of Aragon,	482
„ Death of Greek emperor, John V., and accession of Manuel II.,	504
1392. Charles VI. becomes insane. The Dukes of Burgundy and Orleans dispute for the government of France,	319
1394. Death of Avignon Pope, Clement VII. Election of Bene- dict XIII.,	187
1395. Wenzel creates Gian Galeazzo Duke of Milan,	178
1396. Genoa submits to France through fear of Milan,	180
„ Battle of Nicopolis,	193, 322, 504
1397. The three Scandinavian kingdoms accept the Union of Kalmar,	443
1398. Meeting of Wenzel and Charles VI. of France at Rheims, . .	194
1399. Gian Galeazzo obtains rule in Pisa and Siena,	181
„ Ladislas, son of Charles III., finally secures crown of Naples against Louis II. of Anjou,	155, 266

A. D.	PAGE
1399. Revolution in England. Accession of Henry IV. (of Lancaster),	325
1400. A party of German princes depose Wenzel and elect a rival King of the Romans, Rupert III.,	181, 195
1401. Battle of Brescia (Oct. 24): Milanese troops rout the forces of Rupert III.,	181, 196
1402. Death of Gian Galeazzo Visconti (Sept. 3),	181, 241
„ Battle of Angora: Timour defeats the Turks and captures Bajazet I. Constantinople saved for the time,	505
1404. Death of Philip the Bold of Burgundy. Succeeded by John the Fearless,	322
„ Death of Boniface IX. Election of Innocent VII.,	187
„ Venice allied with Milan against Francesco Carrara,	245
1405. Death of Innocent VII. Election of Gregory XII.,	187
„ Venice acquires Verona and Padua,	245
„ Death of Timour or Tamerlane, the Tartar leader,	505
1406. Pisa subjected to Florence (Oct. 9),	244
„ Death of Henry III. of Castile, and accession of John II.,	475
1407. Assassination of Louis of Orleans in Paris,	322
1408. Ladislas of Naples occupies Rome,	266
1409. Council of Pisa. Election of a third Pope, Alexander V.,	199
„ Exodus of Germans from Prague,	210
„ Death of Martin the Younger. Sicily passes to his father, Martin I. of Aragon,	482
1410. Outbreak of civil war between Burgundians and Armagnacs in France,	326
„ Death of Pope Alexander V. Election of John XXIII.,	201
„ Death of Rupert III., King of the Romans,	201
„ Double election of Sigismund (Sept.) and Jobst (Oct.),	203
„ Recovery of Rome from Ladislas of Naples,	267
„ Battle of Tannenberg: defeat of the Teutonic knights by the Poles,	460
„ Death of Martin I., King of Aragon and Sicily. Disputed succession,	483
1411. Death of Jobst of Moravia (Jan. 12),	203
„ Sigismund again elected King of the Romans,	204
„ The <i>Cabochiens</i> supreme in Paris,	327
„ Ladislas defeated by papal and Angevin forces at Rocca-Secca,	267
„ Peace of Thorn between Poland and the Teutonic Order,	461
1412. Assassination of Gian Maria Visconti. Filippo Maria rules in Milan,	246

Chronological Table

xxiii

A.D.	PAGE
1412. Death of Margaret, 'the Union Queen.' Accession of Eric of Pomerania, in the Scandinavian kingdoms,	444
,, Crowns of Aragon and Sicily given to Ferdinand I. (of Castilian house of Trastámara),	483
1413. The Armagnacs seize Paris and put down the <i>Cabochiens</i> ,	327
,, Ladislas of Naples drives John XXIII. from Rome,	267
,, Mohammed I. reunites the Ottoman dominions,	505
1414. Defeat of the Burgundians. Treaty of Arras,	327
,, Death of Ladislas of Naples. Accession of Joanna II.,	205, 267
,, Meeting of the Council of Constance,	205, 211
1415. Henry v. invades France. Capture of Harfleur (Sept. 22). Battle of Agincourt,	328
,, Deposition of John XXIII. at Constance (May 29),	216
,, Sigismund gives Brandenburg to Frederick of Hohenzollern,	216
,, John Hus put to death at Constance (July 6),	217
,, Sigismund leaves Constance to travel through Europe,	217
,, Spanish kings abandon Benedict XIII. and adhere to the Council of Constance,	218
1416. Death of Ferdinand I. of Aragon and Sicily. Succeeded by Alfonso v.,	484
1417. Sigismund returns to Constance,	219
,, Election of Pope Martin v. ends the schism,	220
,, Death of Louis II. of Anjou, unsuccessful claimant to Naples,	269
,, Death of Maso degli Albizzi, leader of the Florentine oligarchs,	289
,, Henry v. renews the invasion of Normandy,	331
1418. Dissolution of the Council of Constance,	220
,, Burgundians seize Paris from the Armagnacs,	331
1419. Death of Wenzel. Vacancy of Bohemian throne,	224
,, Fall of Rouen completes the English conquest of Normandy,	331
,, Assassination of John the Fearless at Montereau (Sept. 10),	332
,, Philip the Good, who succeeds to the Burgundian dominions, allies himself closely with England,	332
1420. Martin v. publishes a crusade against the Hussites,	225
,, Treaty of Troyes (May 21) gives the regency and the succession in France to Henry v.,	332
,, The Hussites in Bohemia formulate the 'four articles of Prag,'	223
1421. Martin v. re-enters Rome with the help of the Colonnas,	221
,, Battle of Baugé: defeat and death of Thomas of Clarence,	333
,, Death of Mohammed I. Succeeded by Amurath II.,	506

A.D.	PAGE
1422.	Death of Albert III., the last Ascanian Elector of Saxony, 226
„	Establishment of the house of Wettin in Saxony, 226
„	Death of Henry v. of England (Aug. 31), and accession of Henry VI., 333
„	Death of Charles VI. of France. Succeeded in the north by Henry VI., in the south by Charles VII., 333
„	Attempted reform of military and financial system in Germany, 227
1423.	English and Burgundian victory at Crevant, 337
„	Francesco Foscari becomes Doge of Venice, 249
1424.	John, Duke of Bedford, defeats French and Scots at Verneuil, 337
„	Gloucester marries Jacqueline of Hainault and quarrels with Philip of Burgundy, 337
„	Death of the Hussite leader, John Ziska, 225
1425.	Death of Manuel II., and accession of John VI. in Constantinople, 506
„	Bedford recalled to England by quarrel of Gloucester and Beaufort, 338
„	League of Florence and Venice against Filippo Maria Visconti, 249*
1426.	Venice acquires Brescia from Milan, 249
1427.	Defeat of fourth crusade against the Hussites. Proposed constitutional reforms in Germany, 227
1428.	Siege of Orleans by English and Burgundians, 340
„	Venice acquires Bergamo from Milan, 249
1429.	Jeanne Darc raises siege of Orleans (April 19), 341
„	Charles VI. crowned at Rheims, 341
1430.	Jeanne Darc captured at Compiègne, 344
1431.	Trial and execution (May 28) of Jeanne Darc, 345
„	Death of Martin v., and election of Eugenius IV., 229
„	Meeting of the Council of Basel, 229
„	Utter failure of the fifth crusade against the Hussites, 228
„	Venetian reverses in the war with Milan, 250
1432.	Death of Bedford's wife, Anne of Burgundy, 346
„	Trial and execution of Carmagnola, 250
„	Bedford marries Jacquetta of Luxemburg, 346
„	Quarrel between Eugenius IV. and Council of Basel, 230
„	Sigismund crowned Emperor in Rome, 230
1433.	Eugenius IV., driven from Rome to Florence, is compelled to recognise the Council of Basel, 231
„	The <i>Compactata</i> arranged between the Hussites and the Council, 231

Chronological Table

XXV

A. D.	PAGE
1433. Exile of Cosimo de' Medici from Florence,	293
1434. Defeat of the Taborites at the battle of Lipan,	233
,, Fall of the Albizzi in Florence. Recall of Cosimo de' Medici, and establishment of Medicean ascendancy,	294
1435. Treaty of Arras between Philip the Good and Charles VII.,	347
,, Death of Bedford,	348
,, Death of Joanna II. of Naples. Disputed succession be- tween Alfonso v. of Aragon and René of Provence,	271
1436. Loss of Paris by the English,	350
,, Sigismund at last obtains the Bohemian crown,	233
1437. Renewed quarrel between Eugenius IV. and the Council of Basel,	235
,, Death of Sigismund. Albert v. of Austria succeeds in Hungary and Bohemia,	398
1438. Pragmatic Sanction of Bourges,	237
,, Election of Albert II. (Albert v. of Austria) as King of the Romans,	399
,, Council at Ferrara, transferred to Florence,	236
1439. States-General of Orleans issue the <i>Ordonnance sur la</i> <i>Gendarmerie</i> ,	352
,, Pragmatic Sanction of Mainz,	237
,, Death of Albert II. (Oct. 27),	401
,, Union of Greek and Latin Churches agreed to at Florence,	236
,, Deposition of Eugenius IV. by the Council of Basel,	238
,, Election of anti-pope Felix V.,	238
1440. The <i>Praguerie</i> in France,	354
,, Election of Frederick III. as King of the Romans,	402
,, Ladislas Postumus becomes Duke of Austria and King of Bohemia,	409
,, The Hungarians elect Ladislas III. of Poland,	409
,, 'Prussian League' formed in opposition to the Teutonic Order,	463
1441. Peace between Milan and Venice. Venice keeps Brescia and Bergamo,	251
,, Venice acquires possession of Ravenna,	251
1442. Alfonso v. of Aragon finally secures the crown of Naples,	271
,, Death of Blanche of Navarre. Her husband, John of Aragon, keeps the crown, excluding his son, Charles of Viana,	485
1443. Eugenius IV. returns to Rome,	239
1444. Battle of Varna. Death of Ladislas of Poland and Hungary,	410, 508

A.Ds	PAGE
1445. Organisation of standing army in France,	354
,, Ladislas Postumus accepted as King of Hungary,	410
,, Æneas Sylvius arranges terms between Frederick III. and Eugenius IV.,	240
,, Marriage of Henry VI. of England with Margaret of Anjou,	356
1446. Banishment of the dauphin Louis to Dauphiné,	358
1447. Death of Eugenius IV. (Feb. 23), and election of Nicolas V., 241,	272
,, Death of Filippo Maria Visconti. Republic in Milan,	252
1448. Nicolas V. approves concordat with Germany,	241, 273
,, Death of John VI. Succeeded by Constantine Palæologus,	509
,, Death of Christopher vacates the three Scandinavian crowns,	446
,, Swedes elect Karl Knudson,	446
,, Christian I. (of Oldenburg) becomes King of Denmark,	446
1449. Dissolution of the Council of Basel,	241
,, Renewal of war in France. Invasion of Normandy by the French,	357
1450. Grand jubilee in Rome,	242, 273
,, Francesco Sforza makes himself master of Milan,	253
,, Disorder in England. Rising of Jack Cade,	357
,, Loss of Normandy by the English,	357
,, Christian I. of Denmark obtains crown of Norway,	446
1451. French conquest of Guienne,	357
,, Death of Amurath II. Succeeded by Mohammed II.,	508
1452. Frederick III. crowned Emperor in Rome,	411
,, Ladislas Postumus released from tutelage by Frederick III.,	411
1453. Capture of Constantinople by Mohammed II. (May 29),	509
,, Battle of Castillon (July 17). The English retain only Calais,	358
,, Civil war in Prussia leads to Polish invasion,	464
1454. Peace of Lodi between Venice and Milan,	253
,, Venice concludes a treaty with the Turks,	254
,, Death of John II. of Castile. Succeeded by Henry IV. (‘The Impotent’)	476
1455. Death of Nicolas V. Election of Calixtus III.,	274
,, Beginning of the Wars of the Roses in England,	238
1456. Mohammed II. repulsed from Belgrade,	411
,, Death of Hungarian leader, John Hunyadi,	411
,, The dauphin Louis, driven from Dauphiné by his father, takes refuge in the Burgundian dominions,	359
1457. Compulsory abdication of Francesco Foscari in Venice,	254
,, Death of Ladislas Postumus. Austria passes to the Styrian branch of the Hapsburgs,	414

Chronological Table

xxvii

A.D.	PAGE
1457. Karl Knudson driven from Sweden. Coronation of Christian I. reunites the three Scandinavian kingdoms, . . .	447
1458. Death of Alfonso v. Aragon, Sicily, and Sardinia pass to his brother, John II. ; Naples to his natural son, Ferrante, 275,	484
„ Election of Mathias Corvinus in Hungary,	414
„ Election of George Podiebrad in Bohemia,	414
„ Death of Calixtus III. Election of Pius II.,	276
„ Servia conquered by the Turks,	511
1459. Futile congress at Mantua to arrange a crusade against the Turks,	276
„ Death of Adolf, Count of Holstein and Duke of Schleswig,	447
1460. John of Calabria revives the Angevin claim to Naples,	277
„ Pius II. issues the bull <i>Execrabilis</i> ,	277, 407
„ Turkish conquest of the Morea,	511
„ Death of Prince Henry the Navigator,	491
„ Christian I., King of Denmark, etc., obtains Schleswig and Holstein,	447
1461. Death of Charles VII. of France, and accession of Louis XI.,	361
„ Death of Charles of Viana. Rising in Catalonia against John II. of Aragon,	486
„ Mohammed II. subdues the empire of Trebizond,	513
„ Yorkist victory at Towton, and accession of Edward IV. in England,	244
1462. John II. of Aragon, hard pressed by Catalans, cedes Roussillon and Cerdagne to Louis XI.,	389, 486
„ Conquest of Wallachia by the Turks,	511
„ Turkish conquests in the Ægean,	512
1463. Venice decides to go to war with the Turks,	255, 512
1464. Genoa subjected to Milan,	260
„ John of Calabria leaves Naples,	278
„ Death of Pius II. at Ancona. Election of Paul II.,	280
„ Death of Cosimo de' Medici,	299
„ Conquest of Bosnia by the Turks,	511
1465. War of the Public Weal in France,	365
„ Louis XI. enters Paris after the battle of Montlhéri,	366
„ Conclusion of the Treaty of Conflans,	367
1466. Death of Francesco Sforza. Succeeded by Galeazzo Maria,	261
„ Conspiracy in Florence against Piero de' Medici,	300
„ Treaty of Thorn : West Prussia ceded to Poland, and East Prussia retained by Teutonic Order as a Polish fief,	465
1467. Death of Scanderbeg, the defender of Albania against the Turks,	256

A.D.	PAGE
1467. Death of Philip the Good, and accession of Charles the Bold,	369
1468. Interview at Péronne between Louis XI. and Charles the Bold,	370
„ Rebellion in Liége forces Louis to make treaty of Péronne,	371
„ War between Hungary and Bohemia,	415
1469. Death of Piero de' Medici. Lorenzo becomes practically lord of Florence,	302
„ Charles the Bold acquires Alsace and the Breisgau from Sigismund of Tyrol,	377
„ Death of John of Calabria,	486
„ Marriage of Isabella of Castile to Ferdinand of Aragon,	477
„ Margaret, daughter of Christian I., marries James III. of Scotland,	448
1470. Warwick and Clarence driven from England to France. Reconciliation of Warwick with Margaret of Anjou,	372
„ Renewed war between Louis XI. and Charles the Bold,	374
1471. Edward IV. of England defeats his opponents at Barnet (April 14) and Tewkesbury (May),	373
„ Death of George Podiebrad. Bohemians elect Ladislas, son of Casimir IV. of Poland,	416, 465
„ Death of Paul II. Election of Sixtus IV.,	281
„ Constitutional changes in Florence strengthen the Medici,	303
1472. Death of Charles of Guienne (May 24),	376
„ Truce between Louis XI. and Charles the Bold,	376
„ Altered policy of Charles the Bold,	376
„ John II. takes Barcelona and puts down the Catalan rebellion,	486
1473. Death of Nicolas of Calabria. Charles the Bold's aggressions in Lorraine,	378
„ Interview at Trier between Charles the Bold and Frederick III.,	378, 404
1474. Charles the Bold lays siege to Neuss,	378
„ The Swiss stirred into hostility to Charles the Bold,	379
„ Death of Henry IV. of Castile. Accession of Isabella,	477
1475. Edward IV. invades France. Treaty of Pecquigni,	381
„ Charles the Bold overruns Lorraine,	381
„ Execution of the Constable St. Pol,	383
1476. Charles the Bold undertakes to chastise the Swiss. Battles of Granson (March 2) and Morat (June 22),	384
„ Murder of Gian Galeazzo Sforza in Milan,	261
1477. Death of Charles the Bold before Nanci (Jan. 5),	386
„ Louis XI. occupies Burgundy, Franche-Comté and Artois,	387

Chronological Table

xxix

A.D.	PAGE
1477. Mary of Burgundy married to Maximilian,	388
1478. Conspiracy of the Pazzi in Florence,	282, 305
" Florence at war with Naples and the Papacy,	282, 307
1479. Death of John II. of Aragon. Succeeded by Ferdinand the Catholic, but Navarre passes to his daughter Eleanor,	487
" Florentine reverses. Lorenzo de' Medici goes to Naples,	308
" Regency of Bona of Savoy in Milan overthrown by Ludovico Sforza,	262
" Treaty of Constantinople ends the long war between Venice and the Turks,	256, 513
1480. Occupation of Otranto by the Turks,	283, 310, 513
" Florence makes peace with Naples and Sixtus IV.,	309
" Important constitutional changes in Florence,	310
" Death of René le Bon, succeeded by Charles of Maine,	389
1481. Death of Mohammed II.. Evacuation of Otranto. Tem- porary decline of Turkish power,	513
" Death of Charles of Maine enables Louis XI. to acquire Anjou, Maine, and Provence,	389
1482. Death of Mary of Burgundy,	388
" Treaty of Arras settles the Burgundian succession,	388
" Venetian attack upon Ferrara,	257, 283
" Coalition of Milan, Naples, and Florence against Venice and the Papacy,	257, 283
1483. Death of Edward IV. of England,	388
" Death of Louis XI. Accession of Charles VIII. Regency of Anne of Beaujeu,	390
" Sixtus IV. deserts Venice and joins the hostile league,	284
1484. Meeting of States-General at Tours,	391
" Treaty of Bagnolo ends the Ferrarese war,	257, 284
" Death of Sixtus IV., and election of Innocent VIII.,	284
" War between Mathias Corvinus and Frederick III.,	416
1485. Henry VII. establishes the Tudor dynasty in England,	391
" Rising of Neapolitan barons against Ferrante. Offer of the crown to René of Lorraine,	286
" Mathias Corvinus seizes Vienna,	417
1486. Bartholomew Diaz rounds the Cape of Good Hope,	492
" Maximilian elected King of the Romans in his father's life- time,	417
1488. Death of Francis II. of Brittany. Succeeded by daughter Anne,	391
1490. Death of Mathias Corvinus. Succeeded by Ladislas of Bohemia,	417

A. D.	PAGE
1491.	Anne of Brittany compelled to marry Charles VIII., . . . 392
„	Treaty of Pressburg, by which Maximilian recovered the Austrian territories which had been conquered by Mathias Corvinus, 417
„	End of the regency of Anne of Beaujeu, 392
1492.	Columbus discovers the new world of America, 492
„	Annexation of Moorish kingdom of Granada to Spain, 490
„	Death of Innocent VIII., and election of Alexander VI., 287
„	Death of Lorenzo de' Medici. Succeeded by Piero II., 312
„	Henry VII. invades France, but is bought off by treaty of Étapes, 392
1493.	Bull of Alexander VI. dividing the new world between Spain and Portugal, 493
„	Treaty of Barcelona restores Roussillon and Cerdagne to Aragon, 392
„	Treaty of Senlis cedes Artois and Franche-Comté, 393
„	Neapolitan exiles, advised by Venice, and supported by Ludovico Sforza, urge Charles VIII. to claim Naples as representing the house of Anjou, 263, 286, 392
„	Death of Frederick III. Maximilian unites all Hapsburg dominions, 417
1494.	Death of Ferrante of Naples. Succeeded by Alfonso II., 287
„	Treaty of Tordesillas between Spain and Portugal, 493
„	Charles VIII. sets out to assert his claim to Naples, 393
„	Expulsion of Piero de' Medici, and restoration of republican government in Florence, 314

CHAPTER I

GERMANY AND THE EMPIRE AFTER THE INTERREGNUM, 1273-1313

The Empire—German divisions—The Interregnum—Rudolf of Hapsburg—His War with Ottokar—Adolf of Nassau—His relations with France—His fall—Albert I.—The Succession in Hungary and Bohemia—The Election of Henry VII.—His Italian Expedition—His Concessions to the Princes—His son John and the Bohemian Crown—The French seizure of Lyons—The importance of the Period 1273-1313 in German History.

EVER since A.D. 962 the German monarchy had been combined with the Roman Empire, and the union proved harmful to both offices. The universal authority of the Emperor could hardly fail to become shadowy and unreal, but it was rendered more distasteful to non-German princes and peoples by the immediate association of the Empire with a distinct kingdom, with which they might have causes of quarrel. And as the Empire became more and more localised, so the German kingship became steadily weaker. The shadowy character of the higher dignity tended to produce the same impression as to the more real and practical office. The princes who held their lands of the German king aimed more and more at the independence of the external kings and rulers, who, in feudal theory, held of the Emperor. The imperial claims brought the Empire into collision with the Papacy, and the German monarchy suffered from the blows which the Emperor's power received in the great Contest of Investitures. Moreover, the Empire carried with it the crown of Italy; and the constant waste of money and men in the vain attempt to establish a

The Empire
and the
German
monarchy.

real dominion in the southern peninsula, not only weakened individual German rulers, but also led to constant absences from Germany which gave occasion to their northern vassals to acquire independence. Above all the Empire was, by tradition and by the very conception of the office, elective. Thus the German kings were deprived of all the advantages which normal hereditary succession gave to the rulers of England and France. Not only did disputed elections give rise to civil war with all its evils, but the constant change from one family to another rendered impossible any consistent policy of strengthening the central power. When at last the Hapsburgs obtained quasi-hereditary possession of the imperial dignity, disunion had made such progress that it was too late to apply a remedy.

The decline of the central power and the consequent rise of a large number of semi-independent political units, each with a separate existence of its own, though held together by certain common duties and interests, make German history in this period peculiarly difficult and complicated. And the number of these units was far greater in the thirteenth century than would have seemed likely at an earlier date. The great duchies formed by the Karolings had, by the policy of subsequent rulers, been broken up or allowed to become extinct. The great duchy of Swabia, for instance, came to an end with the Hohenstaufen, and was never revived. But the extinction of each duchy brought with it an immense increase of the number of tenants-in-chief. Every noble, town, and even village which had previously held of the duke, now claimed to hold directly of the Emperor; and though many of the weaker units fell victims to the greed of powerful neighbours, yet some, like the original members of the Swiss Confederation, succeeded in retaining the coveted position. In Germany, too, primogeniture was in those days a rare exception, and the practice of equal partition among brothers necessarily led to a great increase in the number of princely tenants of the Emperor.

It is, of course, impossible in this volume to attempt to trace the separate history of the various principalities and states which fill the rather ill-defined territory known as Germany. But it is necessary at starting to have a clear conception of some of the chief families which play so important a part in subsequent history. The four most prominent princely houses in the middle of the thirteenth century were those of Ascania, Welf, Wittelsbach, and Wettin. The first was sub-divided into two lines, descended from the two sons of Albert the Bear. The elder son had held the marks of Brandenburg in the north, which, since 1267, were split up among several brothers. The younger son, Bernard, had in 1180 received from Frederick Barbarossa the diminished duchy of Saxony, which was now held by his grandson, Albert II. (1261-1298). The great family of Welf, so powerful in the previous century, was now confined to the duchy of Brunswick, afterwards sub-divided into Lüneburg (Hanover) and Wolfenbüttel (Brunswick). The House of Wittelsbach was represented by two brothers, Lewis II., who combined the duchy of Upper Bavaria with the Palatine county (*Pfalzgrafschaft*) of the Rhine, and Henry, who held the duchy of Lower Bavaria. Henry of Wettin, whose descendants acquired Saxony in the fifteenth century and retain it to the present day, was at this time Margrave of Meissen and Landgrave of Thuringia. But the most powerful individual prince at this time was Ottokar, ruler of the Slav kingdom of Bohemia, which was brought by geography and history into close connection with Germany. To Bohemia, which he inherited in 1253 from his father, Wenzel I., Ottokar had added by marriage and diplomacy Austria, Styria, Carinthia, and Carniola, and thus held a secure predominance in south-eastern Germany. There were also three lesser families, as yet insignificant, and not regarded as belonging to the princely class, which were destined within this period to rise to importance in Germany, while two of them have taken a position among the greatest dynasties

Europe has ever seen. The House of Luxemburg, in the thirteenth century the lords of a petty county near the western frontier, produced in the next century four Emperors, and founded a territorial power which survived the family which had created it. The Hapsburgs, hitherto known only as active and successful nobles in Swabia, within this period built up a considerable state in south-eastern Germany, and succeeded to the position which the Luxemburgs had founded. Finally, the Hohenzollerns, who in the thirteenth century combined scattered territories in Franconia with the office of Burggraf of Nürnberg, acquired the electorate of Brandenburg in the fifteenth century, and though their power grew more slowly than that of the Luxemburgs and Hapsburgs, yet it rested on a surer foundation, owed more to ability and policy than to fortune, and may prove in the end both more brilliant and more durable.

Among the great territorial princes of Germany must be reckoned the very numerous ecclesiastical tenants-in-chief of the Empire. A large area of German soil, especially along the valleys of the Rhine and the Main, was held by bishops and monasteries. Of these clerical princes the most powerful and prominent were the Rhenish archbishops of Mainz, Köln, and Trier. In former times the bishops had been severed from the secular princes by class interests and traditions, and the separation had been encouraged by many of the Emperors, whose policy was to exalt themselves by playing one off against the other. But after the middle of the thirteenth century this distinction tends to become obscured. The rivalry between Emperors and Popes, though it does not disappear, ceases to be the dominant factor in German relations; and during the papal residence in Avignon (1305-1376) the German bishops become to some extent alienated from the Papacy. The result is that the German princes, both clerical and secular, come to form a fairly united class; and the most obvious interest which binds them together is the desire to strengthen their

own independence, their 'liberty,' as they call it, by weakening the central power. On the other hand, the lesser tenants-in-chief below the princely rank, known in later history as the *Ritterschaft*, or knights, are impelled to cling to the monarchy for support against the constant danger of princely encroachments.

Besides the princes and knights, there is a very important body of tenants-in-chief—the *Reichstädte*, or imperial cities. These had risen to importance, partly through the economic conditions which gave them wealth, and ^{The imperial cities.} partly through the policy of several of the Emperors, who had encouraged the growth of municipal life as a source of revenue and as a check upon the power of the princes. German cities may be divided roughly into two great groups: those in the south, like Augsburg, Nürnberg, Ratisbon, etc., which obtained importance from their position on the great commercial routes leading from Venice and Genoa to different parts of Europe; and those in the north, on the Baltic and the German Ocean, whose function was to carry on the trade between the east and the west of Northern Europe, and to exchange at Bruges the products of the north for the commodities brought by the southern merchants (see p. 422). The strength of the towns lay in their wealth and their walls; their weakness in their isolation and mutual jealousy. This weakness the southern cities never overcame; their leagues for common objects were never durable, and therefore never effectual. But the northern towns were left more to themselves: they came into contact with less developed states, and they were subject to the pressure of more constant and more immediate political interests. The necessity of securing trade privileges in the countries lying to the east and west of the Baltic, and the duty of defending their commercial routes against the aggressive Scandinavian state of Denmark, which commanded the outlets from the Baltic, forced the northern towns into a semi-federal union, and the Hanseatic League became for a time a great political power in the north. In

the end the northern cities also succumbed, owing mainly to a great change in trade routes, and partly to the growing predominance of the princes. But at the beginning of this period the future destiny of the German towns was unknown, and to contemporaries it seemed quite possible that cities like Nürnberg and Augsburg, or Lübeck and Hamburg, might obtain an independence and a power not markedly inferior to that which was actually acquired at this time by Venice and Florence, which were in theory equally tenants-in-chief of the Empire, though further removed from the exercise of imperial authority.

The decline of the German kingship had begun in the eleventh century, but a partial revival had been effected by the great Hohenstaufen Emperors, Frederick Barbarossa, Henry VI., and Frederick II. With the fall of the Hohenstaufen both Empire and monarchy sank lower than they had ever done before. During the Great Interregnum (1256-1273), two rival kings, the Englishman Richard of Cornwall, and the Castilian king, Alfonso X., had secured the nominal adherence of conflicting parties in Germany, but neither had attempted to rule the country. In these years not only did the tenants-in-chief enjoy complete independence of any external authority, but the imperial domains were either annexed by the princes, or squandered by the two royal claimants in the attempt to purchase adherents. This rendered it impossible to revive the old monarchy, and produced changes which seemed to render German unity for ever hopeless. Hitherto the elected Emperor had resigned his hereditary dominions, and had supported himself on the domain-lands, travelling about from one estate to another. This was no longer possible. The only way in which a future king could hope to secure any respect or obedience was to acquire such a territorial power as would make him formidable. Such a policy, consistently pursued by a line of hereditary kings, might have resulted in the gradual formation of a territorial monarchy like that of

The Inter-
regnum and
its results.

France. But the princes made use of their right of election, at first to prevent the kingship passing to successive members of the same family, and always to impose conditions which should secure their own independence. The evil results became abundantly plain in the century which followed the Interregnum. Each successive Emperor set himself, not so much to strengthen the monarchy, as to aggrandise his own family; and the more successful he was, the more dangerous and objectionable did that family become to his successor. The same conditions which produced nepotism in the Papacy, led to the adoption of a consistent policy of dynastic aggrandisement by all the Emperors from Rudolf of Hapsburg onwards.

In 1272 the death of Richard of Cornwall forced his adherents to consider the question of a new election, and at the same time Pope Gregory x., alarmed by the Election of Rudolf I. excessive power of the House of Anjou in Italy, and afraid lest German disunion might give occasion for French aggression north of the Alps, used all his influence to urge on the unanimous choice of a new king in Germany. For a long time the right of election had tended to fall into fewer hands. The early German kings were selected by the chief men and approved by the acclamations of a mass meeting of all freemen. Gradually the form of popular approval disappeared, and the princely tenants-in-chief assumed an absolute power of nomination. Since then the practice had grown up of a preliminary choice by some of the chief princes, to be ratified by the rest. But in the thirteenth century the idea arose that certain princes could elect without any further ceremony. Superstition and custom seem to have combined to suggest the number seven for these electors, as they came to be called. But there were several contending claimants for the right to be included in the favoured seven, and it was not till the next century that these disputes were finally settled. On the present occasion the lead was taken by the great Rhenish princes, the Count Palatine with the

three Archbishops. The only chance of securing a general adhesion of the princes was to choose a king who was not so strong as to excite either fear or jealousy. Mainly through the exertions of Frederick III. of Hohenzollern, Burggraf of Nürnberg, the choice of the electors fell upon his cousin Rudolf, Count of Hapsburg, who was crowned at Aachen on October 24, 1273. It is not a little curious that the election of the first Hapsburg was brought about by the influence of a Hohenzollern.

Rudolf's position was no easy one when, at the age of fifty-five, he was called from his successful career in the petty politics of Swabia¹ to assume the German kingship. He had a large family of daughters, whose marriages served to gain him adherents. At the coronation ceremony one had been married to Lewis of Wittelsbach, and another to Albert of Saxony. But such a tie was insufficient to secure the docile obedience of his sons-in-law if he endeavoured to exercise any real authority over them. Alfonso of Castile retained the title of king of the Romans, and though for the time he was powerless, his pretensions might easily serve as a pretext for malcontents. A more formidable opponent was Ottokar of Bohemia, whose claim to a voice in the election had been disregarded, and who refused to acknowledge the 'pauper count' of Hapsburg. In these circumstances Rudolf showed all the prudence and foresight that had already won him a reputation. He realised that it was no longer possible to revive the pretensions of the Hohenstaufen. He could not afford to alienate the Pope or to aim at the recovery of an Italian kingdom. He must content himself with obtaining what reality he could for the royal power in Germany, and must find a territorial basis for that power. The most obvious method of doing this was the restoration of the duchy of Swabia in his own family, which would enable him to achieve the aims which he had hitherto pursued. But such a step would involve a quarrel with Lewis

¹ For Rudolf's position in Swabia see below, chap. vii.

of Wittelsbach, who claimed to be regarded the heir of the Hohenstaufen. Rudolf could not venture on such a risk, and he fell back on the plan of wresting from Ottokar the German fiefs in the south-east, which the latter had seized during the Interregnum. Before attempting this, Rudolf had to gain over the Pope, the close ally of the Bohemian king. Through the agency of Frederick of Hohenzollern he concluded a concordat with Gregory x., by which he confirmed all previous concessions of Italian territory to the Papacy, and recognised the Angevin kingdom of Naples and Sicily. These promises were subsequently confirmed in a personal interview with Gregory at Lausanne (October, 1275). In March 1280 Rudolf made a direct treaty with Charles of Anjou, by which he confirmed his possession of Provence, and agreed to marry his daughter Clementia to Charles's grandson. Thus the policy of Frederick II. was finally abandoned. To secure undisturbed freedom of action in Germany, Rudolf resigned Italy to the Pope and the House of Anjou.

Rudolf's alliance with the Pope made him strong enough to take active measures against Ottokar, whose refusal to recognise the election on the ground that his vote had been rejected irritated the German princes.

War with
Ottokar.

At successive diets, in 1274 and 1275, he was summoned to justify his occupation of Austria, Styria, Carinthia, and Carniola, and on his refusal was called upon to resign these fiefs. In 1276 Rudolf collected an imperial army and advanced into Austria, where he was welcomed by a general rising of the German nobles against Slav rule. Vienna capitulated, and Ottokar, finding resistance hopeless, made peace on November 21. On condition that Bohemia and Moravia should be secured to him, he resigned the German provinces. The treaty was to be confirmed by a double marriage of his daughter to Rudolf's son Hartmann, and of his son Wenzel to one of Rudolf's numerous daughters. Rudolf was so confident in the results of his victory, that he hastened to disband his army. But Ottokar had no intention of carrying

out the treaty of Vienna, and he succeeded in gaining over many of the chief German princes by representing the danger of allowing a strong Hapsburg power to be established on the Danube. The result was a renewal of the struggle in 1278 under widely altered conditions. The death of Gregory x. (1276) had deprived Rudolf of much of the advantage gained by his concordat with the Papacy. The Archbishops of Mainz and Köln turned against him. Lewis of Wittelsbach remained obstinately neutral. Henry of Lower Bavaria, whom Rudolf had gained over in 1276 by a politic marriage, openly supported Ottokar, who was also aided by the Ascanian margraves of Brandenburg. In place of the imposing army of 1276, the only German princes who sent active aid to Rudolf were Frederick of Hohenzollern and the Bishop of Basel. But the balance was turned in his favour by the alliance of Ladislaus iv. of Hungary and by the support of the Austrian and Styrian nobles, whom Ottokar had failed to conciliate. In a great battle on the Marchfeld, the victory was decided by a charge of the heavy-armed cavalry under Frederick of Hohenzollern, and Ottokar himself perished on the field (August 26, 1278). His death made Rudolf's victory decisive. Otto of Brandenburg, who undertook the guardianship of the young king of Bohemia, Wenzel II., negotiated a treaty in October which renewed the stipulations of 1276 as to the cession of the Austrian provinces and the double marriage between the Hapsburg and Bohemian families. In December 1282 Rudolf formally invested his sons, Albert and Rudolf, with the imperial fiefs of Austria, Styria, and Carniola. The duchy of Carinthia was given to Meinhard, Count of Tyrol, whose daughter was married to Albert of Austria.

The establishment of the Hapsburg dynasty in Austria is an important event in German history. It was the great achievement of Rudolf's reign, and it was his last notable success. His later attempts to strengthen the central monarchy in Germany were, in the main, fruitless.

Rudolf in
later years.

A series of edicts to secure the public peace by restricting the practice of private war, gained the grateful approval of the towns and the lesser nobles, but were rendered ineffectual by the absence in Germany of an efficient system of jurisdiction and police. An ordinance prohibiting the creation of any new county (*Grafschaft*) without royal consent illustrates the general aim of Rudolf's government, but proved little more than a dead letter. The recovery of the lost imperial domains, which Rudolf had pledged himself to undertake at his election, was a task beyond his strength. Even the towns, on whose support he reckoned, were alienated by his attempt to raise an imperial revenue by their taxation; and the appearance of a number of pretenders claiming to be Frederick II. showed a tendency to contrast Rudolf's government with that of his predecessor, who had been enabled to spare his German subjects by the wealth which he extracted from Italy. A still more serious difficulty was the obstinate refusal of the electors to choose his son Albert as his successor during his own lifetime. This was the most pressing object of Rudolf's last years, and it was unfulfilled when he died on July 15, 1291, at the age of seventy-three. If he had lived two centuries earlier, he might have ranked among the greatest of German kings; as it is, he will always be remembered as the founder of the greatest of German dynasties.

The objection to Albert of Austria rested on the considerable territories, both in the east and in Swabia, Adolf of Nassau. which he inherited from his father. The same motives which had induced the electors in 1273 to choose Rudolf, led them to look for a successor whose position should be still more humble than Rudolf's had been. The influence of the Archbishop of Mainz, Gerhard von Eppenstein, secured the election of another 'poor count,' Adolf of Nassau (May 5, 1292). He had purchased votes by promises, which he could only fulfil by pawning the scanty remnants of the imperial domains. But Adolf's ambition was greater

than his material power, and he had no intention of reigning as the submissive puppet of the electors. No sooner had he received the crown at Aachen (June 24) than he led an army against Albert, and forced him to do homage and to surrender the royal insignia which he had retained on his father's death. To repress the great princes, Adolf set himself to conciliate the towns and the lesser nobles. Taking advantage of the death of Frederick of Meissen and Thuringia, he claimed those territories as vacant imperial fiefs, and prepared to found there a hereditary principality as his predecessor had done on the Danube.

Still more noteworthy was the attitude which he assumed towards France. The kingdom of Arles or Burgundy, Relations with France. founded by Rudolf I. (888-912) and enlarged by Rudolf II. (912-937) had, after the death of Rudolf III. (1032), fallen to the German king, Conrad II. Since then the crown of Arles had been regarded, with those of Germany and Italy, as one of the three crowns which passed on election to successive kings of the Romans. But as the German monarchy declined, the supremacy in Burgundy became more and more nominal, and many Emperors neglected the ceremony of coronation at Arles altogether. The kingdom split up into a number of quasi-independent provinces, of which the chief were the free county of Burgundy (Franche-comté), Savoy, Dauphiné, the Lyonnais, and Provence. These provinces, though in theory they were held as fiefs of the Empire, were gradually subjected to systematic aggressions from the side of France, and Philip IV. (1285-1314) pursued this policy of absorption more boldly and openly than any of his predecessors. Adolf sought to strengthen himself by posing as the champion of the unity of the Empire, and in 1294 concluded a treaty with Edward I. of England by which the two princes pledged themselves not to lay down their arms until Philip had withdrawn from the territories he was trying to wrest from both of them. But the war which followed only brought out clearly the disunion

and military impotence of Germany. The German princes cared nothing for the border provinces as compared with their own interests and independence. It was easy for Philip IV. to stir up opposition to Adolf, and when peace was negotiated by Boniface VIII. in 1298, no satisfaction was given to the imperial claims.

Meanwhile the electors and princes had been seriously alarmed by Adolf's alliance with the lesser nobles and towns, and by his temporary successes in Thuringia. To put down the prince whom they had chosen, they ^{Adolf's fall.} turned to Albert of Austria whom they had rejected. Albert, who had already formed a close alliance with Wenzel II. of Bohemia, and had been in communication with the French king, was eager to strike a blow for his father's crown. The Archbishop of Mainz summoned a meeting of princes to Frankfort on May 1, 1298, and Albert set out to attend it with an army at his back. Adolf, however, collected troops from his supporters among the lesser nobles, and prepared to dispute his passage. By superior strategy Albert marched round his opponent to the south, and succeeded in reaching Mainz, whither the meeting was transferred. Here the electors formally declared Adolf's deposition (June 23), but the irregular proposal of Albert of Saxony to elect Albert of Austria on the spot met with no support. The army of the princes now advanced against the king, and after a desperate struggle near Göllheim, Adolf was slain—struck from his horse, it was said, by the hand of his rival (July 2). He had made a brief but creditable attempt to rule as a German king, but was too weak to face the hostile coalition of the princes. His schemes in Thuringia and Meissen perished with him, and the House of Wettin recovered its territories.

After Albert's victory as champion of the electors, the latter could no longer avoid choosing him to fill the vacant throne; but they soon had ample reason to recognise the wisdom of their previous refusal. Albert ^{Albert I.} inherited his father's policy, with more restless energy and

greater military capacity. What he might have done for the Hapsburg dynasty and the German monarchy if his career had not been prematurely cut short by assassination it is impossible to say, but the ten years of his reign are full of great enterprises, most of which promised successful results. The reputation for cruelty which he bears in history is mainly due to the sternness of his manner and appearance, increased by the loss of an eye, and to the fables which have grown up round him in the more than dubious traditions of the Swiss.

To coerce Pope Boniface VIII., who refused to acknowledge his election, Albert concluded a treaty with Philip IV. of France, who had a quarrel of his own with the Papacy, and thus abandoned the attempt of Adolf to defend the Burgundian frontiers. In December, 1299, he had a personal interview with Philip, and arranged a marriage between the French princess Blanche and his eldest son Rudolf. In German politics he set himself to favour the towns against the princes, and infuriated the latter by an edict abolishing all tolls on the Rhine imposed since the death of Frederick II. in 1250. The death of the Count of Holland and Zeeland (October, 1299) gave him an opportunity to claim these provinces as vacant imperial fiefs in opposition to John of Hainault, who claimed the inheritance through his mother. This scheme, however, proved a failure, and the House of Avesnes succeeded in adding Holland and Zeeland to Hainault. Encouraged by Albert's check in the north-west, the Rhenish archbishops and the Elector Palatine, furious at the threatened loss of their tolls, formed a league against the king whom they had voted for two years before. But Albert was not so powerless as Adolf had been. Backed by the enthusiastic support of the cities and aided by French auxiliaries, he took the aggressive against his opponents, and compelled them not only to abolish the tolls, but to recognise the right of the towns to receive burghers of the pale (*Pfahlbürger*)—that is, to confer the privileges and immunities of citizenship on residents in the suburbs outside the

walls. Few German kings since Henry III. had been so successful in coercing their powerful vassals as was Albert in these campaigns of 1301 and 1302.

For the next few years Albert's attention was mainly absorbed in eastern affairs. The death of Andrew III., the last male of the Arpad dynasty in Hungary, left that kingdom without any obvious heir. There were two candidates, who were descended from the royal family through females—Otto of Lower Bavaria, and Charles Robert or Carobert, the grandson of Charles II., the Angevin king of Naples. But the Magyar nobles passed over both, and offered the crown to Wenzel II. of Bohemia, who accepted it for his son Wenzel III. Such an accession of power to the Premyslides was entirely opposed to Albert's interests, both as King of Germany and as Duke of Austria. As he had no love for the Wittelsbachs in Lower Bavaria, he did not hesitate to espouse the cause of Carobert, the son of his sister Clementia, and the candidate supported by Boniface VIII., with whom Albert had reconciled himself in 1302. For a time the Bohemian power proved too strong, but the death of Wenzel II. (June, 1305) and the growing discontent in Hungary with the conduct of the young king, enabled Carobert to secure the crown, though his title was disputed for a time by Otto of Wittelsbach.

In the next year (August, 1306) the murder of the young Wenzel III. left the Bohemian crown itself vacant. The sister of the late king had married Henry of Carinthia and Tyrol, the brother of Albert's wife.¹ In spite of this relationship Albert claimed the kingdom as a vacant fief, and conferred it upon his eldest son Rudolf. The consent of the Bohemian nobles was extorted or purchased, and an agreement that Rudolf's brothers should succeed if he himself died childless, seemed to secure to the Hapsburgs the permanent possession of a kingdom which, added to their Austrian territories, would make them all-powerful on the

¹ See Genealogical Table A, in Appendix.

eastern frontier of Germany. This was the greatest of Albert's achievements, and, if the acquisition had been permanent, would have made his reign as important in Hapsburg history as his father's had been. But his last years were clouded with disappointment. An attempt to renew his predecessor's claims upon Meissen and Thuringia was repulsed by Frederick of Wettin, who defeated the royal army, under Frederick of Hohenzollern, near Altenburg (May 31, 1307). This defeat was followed by the sudden death, on July 4, of the youthful Rudolf of Bohemia. The Bohemians had tired of Hapsburg rule, and in spite of the agreement made at Rudolf's election, they now offered the crown to Henry of Carinthia. Albert had already made one incursion into Bohemia, and was preparing another, when he was treacherously murdered by his nephew, John (May 1, 1308).

John was the son of Albert's brother Rudolf and Agnes, daughter of Ottokar, and seems to have resented his uncle's refusal either to support his candidature for the Bohemian crown, or to give him any share of the Hapsburg territories. The assassination, therefore, was the result of mere personal pique, but it was as important as if it had arisen from a deep-laid political scheme. If Albert had lived longer he would very probably have established his son Frederick in Bohemia, and rendered his election to the German kingship inevitable. In that case the Hapsburgs might have founded a territorial monarchy in Germany, and the House of Luxemburg would never have risen from obscurity. The complaint that Albert neglected to enforce imperial pretensions in Italy is well founded, but should rather be set to the credit of his political capacity. The Italian connection was fatal to the best interests of Germany. A far more serious criticism is his failure to resist the aggressions of France. He aided the House of Anjou to acquire the crown of Hungary in addition to that of Naples, and although for the moment Charles Robert's candidature was opposed by Philip IV., it was certain

that in the long-run the Angevin and Capet interests would combine the two families. He made no opposition to the transference of the papal residence from Rome to Avignon, though the disadvantage to Germany was obvious when Clement v. filled the Rhenish archbishoprics with partisans of France.

It resulted from these changes that French influence was very prominent in the election of 1308, and was strong enough to secure the exclusion of Albert's heir, Frederick the Handsome. Philip iv.'s brother, Charles of Valois, came forward as a candidate and was openly supported by the Pope. But the secular princes were strong enough to resist such a sacrifice of German interests to ecclesiastical pressure, although their own interests prevented them from supporting the Hapsburg. At this juncture, the Archbishop Baldwin of Trier (appointed in 1307) suggested as a compromise the choice of his brother, Henry of Luxemburg. He was the descendant of the counts of Limburg and Arlon, who had acquired Luxemburg by marriage in 1214. His territorial power was too small to inspire jealousy in Germany, while he was connected with France by education and by military service in the war against Edward I. As no other candidate had any chance of election, Henry VII. was chosen without opposition on October 28, 1308. The Hapsburgs found it necessary to acknowledge the new king on condition of receiving confirmation of their fiefs.

The personal career of Henry VII. belongs rather to the history of Italy than that of Germany, and will be considered in the following chapter. From the first he seems to have looked on Germany as a foreigner, and abandoned the policy of his predecessor for the wild dream of reviving the imperial power of the Hohenstaufen in Italy at the head of the Ghibelline party. In 1310 he set out on his southern expedition, which resulted in little beyond his coronation in Rome (June 29, 1312). He never returned to Germany. But before his departure he took some steps

which were fraught with future consequence. To conciliate the princes he withdrew the concessions by which Albert had purchased the support of the towns. In 1310 **Concessions to the princes.** he prohibited the creation of *pfahlbürger*, and restored their tolls to the Rhenish princes. In the same year he seized the opportunity to obtain a great acquisition for his family. The Bohemians were in rebellion against Henry of Carinthia, and offered the crown to Henry VII.'s son, **John of Bohemia.** John, on condition that he should marry Elizabeth, daughter of Wenzel II. The offer was accepted; but so little did Henry care even for his family interests in comparison with his chimerical schemes, that he did not delay his advance into Italy, and left the securing of his son's throne to the Archbishop of Mainz, Peter von Aspelt. Fortunately, the enterprise did not require his presence. Henry of Carinthia was expelled, and John of Luxemburg was firmly seated on the Bohemian throne.

During the Italian expedition, which ended in Henry VII.'s death near Siena (August 24, 1313), the interests of the **France seizes Lyons.** German monarchy were neglected, the princes were left in complete independence, and Philip IV. was enabled to carry on his aggressions with impunity. In 1310 he took advantage of a dispute between the archbishop and the citizens of Lyons to send French troops into the city, and in 1312 the former was compelled to make a treaty by which he acknowledged the suzerainty of France.

Forty years had now elapsed since the close of the Great Interregnum. The kingly office had been revived, and had been held by four princes, each of whom had **Importance of period 1273-1313 in German history.** shown considerable vigour and capacity. But the absence of hereditary succession had rendered impossible the pursuit of any efficient scheme for the enforcement of central authority and the repression of princely independence. The greatest successes in this direction had been gained by Albert I., but they had been rendered nugatory by his untimely death and by his

successor's absorption in dreams of reviving the universal empire. Germany in 1313, as in 1273, was a mere bundle of states under a nominal head, while its neighbours England and France had been receiving a strong national organisation under the capable rule of Edward I. and Philip IV. That Germany escaped for a century from the worst consequences of her disunion was mainly due to the jarring interests of the neighbouring states which led to the Hundred Years' War.

But it is misleading to regard the history of these forty years as a mere chronicle of heroic efforts ending in hopeless failure. The very divisions of Germany, while they weakened its nationality, gave greater scope and variety to local development. From this period we date the rise to greatness of the two vigorous dynasties of Luxemburg and Hapsburg. To it we have also to look for the first origins of the Swiss Confederation [see chap. vii.], for the rise of the Hanseatic League [see chap. xviii.], and for the establishment of a great territorial power in Prussia by the Teutonic Order [see chap. xix.]. It is necessary to follow the fortunes of the monarchy in order to understand why German development was so different from that of other contemporary states, but the real interest of German history is to be found in the vigorous growth of these political organisations on the extremities rather than in the declining vitality of the central power.

CHAPTER II

ITALY AND THE PAPACY, 1273-1313

Italy in the Fourteenth and Fifteenth Centuries—Causes of Italian disunion—The Guelfs and Ghibellines—The Italian towns—The House of Anjou in Naples—The Sicilian Vespers—The Popes and their States—Celestine v. is succeeded by Boniface VIII.—The last of the Mediæval Popes—The difficulties of Benedict XI. and Clement v.—The retirement of Clement v. to Avignon and beginning of the 'Babylonish Captivity'—The condition of Tuscany—The Florentine Constitution—Genoa and Milan—The Venetian Constitution—Henry VII. makes an Expedition into Italy—Its failure—Death of Henry VII.

THE two centuries which are treated in this volume constitute the most brilliant period in Italian history since the age of Augustus. The absence of any central authority, which disappeared even more completely in Italy than in Germany, opened the way for the growth of a number of political organisations, whose history is as fascinating as their variety is bewildering. In addition to the great dynasties of Anjou, Visconti, and Medici, we have to watch the fortunes of the great republics of Venice, Florence, and Genoa, of the temporal states of the Church, and of a number of lesser families, such as the House of Este in Ferrara, the della Scalas in Verona, the Gonzagas in Mantua, the Montefeltri in Urbino, whose kaleidoscopic changes are narrated with such wealth of detail in the volumes of Sismondi. But what gives its special importance to the history of this period is that in it Italy becomes the teacher of Europe. It is to Italy that we trace that great movement, known as the Renaissance, which began with the revival of classical learning, but led on to the growth of

Italy in the
fourteenth
and fifteenth
centuries.

national literatures, to the rise of a new spirit in the arts of painting and sculpture, and to the enfranchisement of human thought from the fetters of superstition, routine, and the formulas of scholasticism. In the fifteenth century, Italy originated the art of writing history as distinguished from the compilation of mediæval chronicles. And finally, Italy instructed Europe in politics as well as in letters and art. The foremost European rulers of the sixteenth century learnt the maxims of government from Italian princes and Italian writers: the great states of modern times learnt from Italy the practices of diplomacy and the theory of the balance of power. Political science, which had made no progress since the days of Aristotle, was revived by the writings of Machiavelli and Guicciardini.

Yet Italy profited less than any other state from the lessons which she taught. France, England, and Spain, all of them the pupils of Italy, became strong, united, and wealthy states, while Italy herself, in the very middle of an intellectual and artistic activity which has remained the wonder of the world, subsided into political insignificance, and only finds a place in subsequent history as the stage on which other nations fight out their quarrels. The solution of this crucial problem, the combination of intellectual progress with political decadence, can only be found in a careful study of the conditions which prevented the people of Italy from following the normal tendencies of the period, and becoming a nation. The causes of disunion are too numerous and deep-seated to be summed up in a few sentences. But it may be instructive to form a clear conception, at starting, of some of the most notable conditions which influenced the course of Italian history in the period which we have to consider. In the first place, geography in Italy, as in Greece, tended to disunion. The Apennines cut off the Lombard plain from the rest of Italy, and divided the latter into two unequal parts which were again split up by the lateral offshoots into

Causes of
Italian dis-
union.

divisions, not quite so small as those of Greece, but almost equally marked off. The nominal subjection to an elective emperor, who was also king of Germany, rendered impossible the rise of any strong native power which could weld together the separate political units. The influence of the Papacy, which in the thirteenth century combined the sovereignty of an Italian state with the spiritual headship of Latin Christendom, proved almost as great an obstacle as the Empire to national union. The great length of Italy, by increasing isolation, hindered the growth of common interests. The leagues occasionally founded for common aims, such as the Lombard league against Frederick Barbarossa and the league of Venice against Charles VIII., were never more than temporary alliances, and fell to pieces as soon as their immediate object was gained.

The long quarrel between the Popes and the Hohenstaufen Emperors bequeathed a fatal heritage to Italy in the party feuds of Guelfs and Ghibellines. These famous factions not only set one state against another, but also gave rise to violent discord within each state. And the parties lasted long after the original cause of quarrel had come to an end. When the Hohenstaufen had perished with Manfred and Conradin, when Rudolf of Hapsburg had abandoned all imperial claims over central and southern Italy, when the Papacy itself had quitted Italy to find a home on the further boundary of Provence, it seemed as if party feuds must inevitably die out for want of the fuel which had originally kindled them. But the blaze of mutual hatred continued to rage as fiercely as ever. The famous strife of the *Bianchi* and *Neri* in Florence, which drove Dante into exile from his native city, was fought out when Albert I. and Boniface VIII. were in close alliance. These stereotyped and quasi-hereditary feuds were not only destructive of all sense of nationality, but they were strong enough to overpower the far stronger and more local sentiment of common citizenship.

Perhaps the strongest of all the disruptive forces in Italy was the development, in the northern and central provinces, of the municipality or commune as the normal unit of political life. This applies not only to the republics proper, but also to those cities whose liberties were overthrown by the rise of some dominant family. The subjection of lesser cities by more powerful neighbours did not create a state in which all subjects stood in an equal relation of submission to a despotic government, but one in which subject communes were enslaved by a dominant commune, and were excluded by it from all voice in the government. The citizens of Pavia and Cremona were not the direct subjects of the Visconti on a level with the Milanese themselves. They were the subjects of Milan, and were ruled by Milanese governors, just as Pisa and Pistoia were ruled by Florentines. The absorption of the lesser cities continued, until in the fifteenth century Italy practically consisted of five dominant states—Naples, Milan, Venice, Florence, and the Papacy. The result was the creation of a large subject population, deprived of that share in politics which Italian citizens had learnt in earlier times to consider their dearest right, and constituting a permanent and dangerous element of discontent. It was from this population that the condottieri recruited those mercenary armies to which Italian writers agree in attributing the disasters that befel their country, and it was this population which welcomed foreign invasion as a chance of escaping from domestic oppressions. Commines tells us that the Italians 'welcomed as saints' the French army that followed Charles VIII. to Naples, and the phrase is significant of the unsoundness of the political condition of Italy and of the utter absence of any sense of nationality.

The quarrel between Frederick II. and the Popes had been embittered by the former's possession of Naples and Sicily, which brought him into threatening proximity to the territories in central Italy which the Popes claimed to rule.

To drive the Hohenstaufen from Italian soil the Popes did not hesitate to call in foreign assistance. After a vain attempt to draw England into the quarrel, the crown of Sicily was offered as a papal fief to Charles of Anjou, the brother of Louis ix., and Count of Provence through his wife Beatrix. At the battle of Grandella near Benevento (February 26, 1266) Manfred, the illegitimate son of Frederick II., was slain; and the still more famous battle of Tagliacozzo (August 23, 1268) was followed by the capture and execution of Conradin, the last male representative of the House of Hohenstaufen. These two victories secured Charles's possession of Naples and Sicily, though the marriage of Manfred's daughter, Constance, to Peter III. of Aragon created a rival claim which proved a source of subsequent danger.

As the acknowledged head of the Guelf party, which was for the moment supreme, Charles of Anjou seemed likely to establish his ascendancy over the greater part of Italy. The Pope, claiming supremacy during the Interregnum, appointed him imperial vicar and senator of Rome, while a number of cities in Tuscany and Lombardy acknowledged his lordship. But his ambitious schemes were suddenly checked by the very power of which he posed as the champion. The Papacy discovered that it had called in a protector who might prove as dangerous a neighbour as the Hohenstaufen. Gregory X. and Nicolas III., secured in their position by the concessions of Rudolf of Hapsburg, did not hesitate to oppose the further progress of the Neapolitan kings by a policy of mediation between the Guelfs and Ghibellines. The election of Martin IV. (February 24, 1281), a creature of Charles, seemed to offer a new opportunity for Angevin aggression. The ascendancy of the Guelf faction was revived, and Charles was planning an enterprise against Constantinople, when he was arrested by the news of a great disaster. The Sicilians had long resented the harshness of French rule, and John of Procida, an old partisan of the

**The House
of Anjou
in Naples.**

**Sicilian
Vespers, 1282.**

Hohenstaufen, had returned from his refuge in Aragon to encourage the malcontents and to secure for them foreign assistance. His plans were still incomplete, when a sudden rising at Palermo was provoked by a brutal insult offered to a woman by a French soldier during a procession on Easter Monday (March 30, 1282). The people rose with shouts of 'Death to the French!' and more than four thousand men, women, and children were massacred that evening. The whole of Sicily joined in the rebellion, and offered the crown to Peter III. of Aragon. When Peter arrived in August he found that Charles, thirsting for vengeance, had already laid siege to Messina. But the Catalan fleet under Roger di Loria, the most distinguished naval commander of his time, was too formidable to be faced by the mere transport vessels with which Charles was provided. Sicily was perforce evacuated, and was never recovered by the House of Anjou. The Sicilian Vespers gave rise to a twenty years' struggle, which concerns the history of France and Spain as well as Italy. The Pope decreed Peter's deposition, both in Sicily and in Aragon, and offered the latter crown to Charles of Valois, the second son of Philip the Fair. But papal bulls failed to overcome Aragonese obstinacy and Sicilian devotion. In 1283 Charles's son of the same name was captured in a naval battle by Roger di Loria, and remained a prisoner for the next five years. In 1285 Charles I. of Anjou died (January 7), after a career which had known no failure till towards its close. The same year witnessed the successive deaths of Pope Martin IV. (March 12) and of Peter III. (November 11). The latter was succeeded in Aragon by his eldest son Alfonso, and in Sicily by his second son James. In 1288 the mediation of Edward I. of England resulted in the conclusion of a treaty by which Charles II. of Anjou was released to take possession of the Neapolitan crown, and Sicily was confirmed to the House of Aragon. But the treaty was never observed. No sooner was Charles II. free than Nicolas IV. absolved him from his obliga-

House of
Aragon in
Sicily.

tions, recognised him as king of the Two Sicilies on the same terms as his father, and renewed the excommunication against James. The war continued without a break. In 1291 Alfonso died, and James succeeded to the crown of Aragon. Wearied of the long struggle, and anxious to free his Spanish kingdom from the attacks of Charles of Valois, James agreed to renounce the crown of Sicily. But the Sicilians refused to return to French rule, and raised to the throne Frederick, the youngest son of Peter III., who continued the struggle even in opposition to his own brother. At last, in 1302, after an unsuccessful attack on Sicily by Charles of Valois, peace was concluded. Frederick was to marry Charles II.'s sister Eleanor, and to retain the kingdom of Sicily during his lifetime, but on his death it was to revert to the House of Anjou. This last stipulation was never fulfilled, and Sicily and Naples remained under separate rulers till 1435, when they were reunited under an Aragonese king. The only other notable event in the reign of Charles II. of Naples was the acquisition of the Hungarian crown by his grandson, Carobert, which has been already narrated (see p. 15). In 1309 Charles II. died, and the crown of Naples passed to his second son, Robert, the superior hereditary claims of Carobert of Hungary being passed over. For the next thirty-four years Robert was the acknowledged head of the Guelf party in Italy.

To the north of the kingdom of Naples lay the temporal dominions which the Popes claimed by virtue of real or pretended donations from Emperors and others. **The Papal States.** These territories had by this time reached the boundaries which they retained to the present century. They included the whole of Romagna, the Pentapolis, the March of Ancona, and the Patrimony of St. Peter, with the city of Rome and the Campagna. The concordat with Rudolf of Hapsburg abolished all imperial suzerainty over these districts, and thus secured to the Papacy a territorial principality which Frederick II. had threatened to annihilate. But the victory, great as it appeared, was in reality deceptive.

It had been won with the aid of the House of Anjou, whose protection might easily be converted into an oppressive patronage. And the difficulties of temporal rule were a serious addition to those of the spiritual oversight of Christendom, especially as the Popes were usually elected in advanced years, and their tenure of office was necessarily brief. More than two centuries elapsed before papal suzerainty in central Italy developed into direct papal government; and during that period the absorption in secular interests not only diverted the attention of the Popes from their higher duties, but also tended to lower their estimation in the eyes of Europe. The localisation of the Papacy in central Italy, while it gave some appearance of security to the papal power, really degraded it, just as the identification with the German monarchy degraded the dignity of the Empire.

There is little reason to linger over the history of the individuals who fill the papal chair from the end of the Interregnum till the departure to Avignon. **The Popes,** Gregory X. (1271-1276), elected after a vacancy ^{1272-1290.} of nearly three years, was a man of high character and ability, but he did not rule long enough to accomplish any great ends. He set himself to restore order in Germany, to put an end to party strife in Italy, and to check the arrogant ambition of Charles of Naples. The council which he held at Lyons in 1274 is chiefly notable for the regulations drawn up to prevent delays and external intervention in papal elections. Ten days after the death of a Pope, the cardinals present on the spot were to be shut up in conclave, and were to remain excluded from intercourse with the outside world until they had agreed on the choice of a successor. Gregory's short-lived successors were mainly occupied with their relations with Naples, with party struggles in Italy, and with the growth of the noble families in Rome. Temporal dominion, in which hereditary succession was impossible, brought with it the vice of nepotism, the desire to make the most of a short tenure of office for the aggrandisement of relatives. Nicolas III. (1277-1280) bestowed

lavish grants on the great House of Orsini, to which he belonged; Martin IV. (1281-1285) was a mere puppet of Charles of Anjou, and resided in his company at Viterbo; Honorius IV. (1285-1287) was a Savelli, and exalted his family at the expense of the Orsini; while Nicolas IV. (1288-1292) raised the Colonna as a counterpoise to the other two families. From this time the history of Rome was filled with the feuds of these great baronial houses, and they exercised a most disastrous influence on the spiritual as well as on the temporal position of the Popes.

On the death of Nicolas IV. these baronial factions were so predominant and so evenly balanced in the conclave that no Celestine V., election could take place for two years. At last, ¹²⁹⁴ in 1294, a sudden impulse induced the cardinals to throw aside all secular considerations and to offer the highest ecclesiastical dignity to a man whose only claim was his reputation for sanctity. Celestine V. had for years lived a hermit's life in a cave near Sulmona. His election was a unique experiment in papal history, and it was unsuccessful. Personal piety was no sufficient substitute for the worldly wisdom and experience required for the occupant of the papal chair. After five months he was persuaded to abdicate, and he ultimately died (May, 1296) in a prison to which he was consigned by his successor, Boniface VIII.

The pontificate of Boniface VIII. is by far the most important of this period. He has been called the last of the mediæval Popes. He was certainly the last who ^{Boniface VIII., 1294-1303} attempted to exercise that general authority over Christendom which Gregory VII. had claimed and Innocent III. had acquired. His complete failure proved how little the Papacy really profited by its victory over the Empire. In order to weaken the authority of the Emperors, the Popes had encouraged the growing nationality of the outlying kingdoms, forgetful that they were forging a weapon which might be used against themselves. Honorius III. and Innocent IV. had waged a desperate struggle against Frederick II.

But the defeat of the Hohenstaufen did not, as they expected, leave the Papacy supreme. Boniface VIII. found equally formidable opponents in Edward I. of England and Philip IV. of France. The Papacy might defeat the Empire, because the latter was opposed to all the tendencies of the age, but it was powerless against the force of national development. To coerce the French and English kings, who refused to submit to his arbitration, Boniface issued the bull *Clericis laicos* which forbade the clergy to pay taxes to the secular power. Edward I. replied by outlawing the clergy, and forced them to acknowledge their membership of the state and to contribute to its support. Philip IV. retaliated by prohibiting the export of money from France, and thus cut off French contributions to Rome. When the Pope claimed Scotland as a papal fief and forbade any further English invasions, Edward I. brought the bull before a parliament at Lincoln (1301), which decreed that the king should not answer before the Pope on any question concerning his temporal rights. Philip IV. met the exorbitant papal pretensions by a similar protest from the national representatives at a meeting of the States-General (1302). And the French king did not content himself with verbal protests. Taking advantage of the discontent of the Colonnas, French troops entered Anagni, where Boniface was residing, and for a few days kept him a prisoner. This insult was a terrible blow to the proud Pope, and a few weeks later he died (October, 1303).

Benedict XI., the new Pope, had a difficult task to avoid either a degrading submission to France or a new quarrel with Philip IV. and the Colonnas. To escape **Benedict XI.,** intimidation he withdrew to Perugia, and for a **1303-1304.** time succeeded in maintaining a conciliatory but not dishonourable attitude. At last he found it necessary to issue a bull against the chief authors of the outrage at Anagni (June 29, 1304). Four weeks later the Pope was dead, and contemporaries were almost unanimous in attributing his

death to poison. The posthumous reputation of Boniface VIII. was now the vital question at issue, and the cardinals were almost evenly divided into a French party which condemned him, and an Italian party which anathematised his assailants. So irreconcilable were the two parties that the cardinals, though shut up in the palace at Perugia in accordance with the constitution of Gregory X., spent ten months in the vain attempt to choose a new Pope. At last the deadlock was terminated by a strange compromise. The supporters of Boniface were to name three non-Italian prelates, and the hostile party was to choose one of them. One of the three was the Archbishop of Bordeaux, whose diocese lay within the dominions of Edward I. His selection was due to the belief that he was the bitter enemy of Clement V., the French king. But tradition maintained that 1305-1313. Philip IV. contrived to buy him over to his side, and he was chosen Pope as Clement V. The coronation ceremony took place at Lyons, and the new Pope never ventured into Italy. His pontificate was one long struggle to avoid or to moderate the concessions which Philip expected from him. The charges against Boniface were ultimately referred to a council at Vienna, which exonerated his memory. But on most points Clement had to follow the wishes of the French king, especially in the condemnation of the Templars. In 1309 Clement V. fixed his residence at Avignon, which was not then a French town, and was probably chosen partly for that reason, and partly for its neighbourhood to the Venaissin, already a papal possession. But Avignon was in Provence, which was held by the House of Anjou, and it was only separated from France by the Rhone. As long as the Popes continued to live there, they were exposed to overwhelming French influence, and could hardly escape the charge, made both from England and Germany, that they were mere vassals of the king of France. It says much for the vitality of the papal system that the 'Babylonish captivity,' as the next seventy years have been called, did not result in the

complete loss, not only of the Italian provinces, but of all spiritual authority in Europe.

The district of Tuscany, which lies to the north-west of the Papal States, had been split up since the death of the Countess Matilda into a number of city states, mostly republics, but which from time to time ^{Tuscany.} were subject to native or foreign despots. Siena, which became in the fifteenth century mistress of southern Tuscany, had not yet risen into prominence and never ranked among the great states of Italy. Pisa, hitherto the most powerful of the Tuscan communes and one of the greatest of Italian ports, began to decline when the restoration of the Eastern Empire (1261) established the ascendancy of Genoa in the Levant. In the naval struggle which followed, the two republics were fairly evenly balanced; but a great Genoese victory off the island of Meloria (1284) inflicted a blow from which Pisa never recovered, though she retained her independence for another century. Lucca rose to some importance under Castruccio Castracani, and from time to time successfully resisted the aggressions of Florence, but has no continuous history that attracts attention. By far the most important of the Tuscan cities was Florence, destined to be for a brilliant period the chief home of Italian ^{Florence.} art and literature, to acquire the supremacy over the whole of Tuscany, and to become for a few years in the present century the capital of an Italian kingdom. It is at the end of the thirteenth century that the foundation was laid of the Florentine constitution, which has always attracted special attention on account both of its own peculiarities and of the greatness of the city in which it grew up.

No city in Italy had been more convulsed than Florence by the struggle between Guelfs and Ghibellines, and these factions were the more embittered against each other by their coincidence with class distinctions. ^{Constitution of Florence.} The feudal nobles, although by no means united, were preponderantly Ghibelline, while the wealthy burghers were

inclined to the cause of the Papacy and Charles of Anjou. After the defeat of Manfred in 1266 the supremacy of the Guelfs was established, and was never overthrown from that date. For some years the government was moderate and pacific, but the news of the Sicilian Vespers in 1282 frightened the Guelfs into an attempt to secure their power by constitutional changes. The existing magistrates were superseded by the 'Priori delle Arti,' at first three and afterwards six in number. These constituted the signory and held the chief executive power. They were chosen from the seven greater guilds (*arti maggiori*) and held office for two months at a time, re-election being forbidden (*divieto*) until after an interval of two years. The greater guilds, which had long existed as trade corporations before their rise to political importance, consisted of the *Calimala*, or cloth merchants, the wool-weavers, the bankers, the silk manufacturers, physicians, furriers and lawyers. About the same time a number of lesser guilds (*arti minori*) were organised, and their number increased within the next sixteen years to fourteen. Henceforth we can trace the existence of four main divisions of the people of Florence: (1) the *grandi*, or nobles; (2) the *popolo grasso*, the members of the seven greater guilds; (3) the *popolo minuto*, or members of the fourteen lesser guilds; (4) the *ciompi*, though this name is of later origin, including those citizens who had no guild organisation, and therefore no machinery either for self-government or for influencing the conduct of public business.

By the constitution of 1282 the nobles were not excluded from office, but if they wished to qualify themselves for it they had to enter a guild. Many of them fulfilled this condition, and several nobles held the office of prior during the next ten years. But class jealousies continued to create domestic Ordinances of quarrels, and in 1293 Giano della Bella, himself Justice, 1293. of noble origin, proposed and carried the famous 'Ordinances of Justice.' To qualify for office a man must really practise the trade or craft to which he belonged. The

grandi were not only to be excluded from any share in the government, but they were subjected to serious social disqualifications. In time of disorder they were confined to their houses on penalty of exile. A noble could not accuse a citizen or bear witness against him without the consent of the signory, and the severest penalties were imposed on a noble who wounded or killed a citizen. The duty of enforcing these ordinances was intrusted to a specially ^{The Gon-} created official, the gonfalonier of justice, who ^{falonier.} was to be appointed every two months and was to be a member of the signory. The gonfalonier, who was intrusted with the command of a large force of infantry, became the most dignified officer of the state, though his actual powers were not greater than those of the priors. From this time one of the harshest penalties was to confer nobility upon a political offender, and the greatest reward that could be conferred upon a deserving *grande* was to degrade him to the rank of a citizen. To protect the signory from attack a fortified *Palazzo Pubblico* was built for their reception, a building which is now famous as the *Palazzo Vecchio*.

Although the actual government of Florence from 1293 may be considered to be a plutocracy, in that the actual conduct of affairs was monopolised by the wealthy ^{The Parlia-} burghers, yet the constitution possessed a real ^{ment.} democratic basis. The ultimate power of making any constitutional change rested with the *parlamento*, a mass meeting of all citizens in the great piazza. Such a meeting could at any time appoint a *balia*, i.e. a committee with full powers to alter the laws; and it was by this method that most of the revolutions in Florentine history were accomplished.

Early in the fourteenth century the Florentine constitution assumed the main features which it retained till the fall of the republic. In 1321 a disastrous war with ^{The 'Buon-} Castruccio Castracani discredited the signory, and ^{uomini.} displayed the weakness of a government which changed every two months. To remedy this, a council of twelve

buonuomini was created, two from each *sesto* or district. They were to hold office for six months instead of two, and the signory was to take no important step without consulting them. Two years later a far more important change was made, when the system of filling offices by lot was introduced. Hitherto the members of the outgoing administration had elected their successors. But the city was disquieted by factious quarrels at each election, and there was no security for that equality which was rapidly becoming a passion among the Florentines. In 1323 it was determined to hold a *squittinio*, or scrutiny, every two years in place of the elections every two months. A committee was formed of the signory for the time being with the councils of the greater guilds and other influential citizens. A list was drawn up of all citizens qualified for office by age and by being clear of debt to the state (*netti di specchio*). Their names were then put up to ballot in the committee. The voting was by black and white beans, the former being in favour of the candidate. All the names which received not less than two-thirds of the black beans were placed in bags (*imborsare*), and from these bags they were drawn to fill vacancies as they arose. When the bags were empty a new *squittinio* became necessary. It resulted from this system that qualified citizens had a fairly equal chance of selection, but there was no security that offices would go to the most capable, and the arrangement was liable to serious abuses. The party which could obtain a majority in the selecting committee (*balia*), was certain to secure most of the offices for its own partisans for at least two years.

By 1323 the Florentine constitution had assumed a fairly definite shape. At its head stood the gonfalonier of justice and the six priors, who had the chief conduct of affairs and the right of initiating legislation. Then came the twelve *buonuomini*, who were a sort of privy council to the signory, and served as a check on its power. Next in rank were the *capitano del popolo*, once the chief magistrate of the city, and

the sixteen gonfaloniers of companies, who were responsible for police and military arrangements. These were known as the three greater offices (*i tre maggiori*). In critical times special magistracies were sometimes created for a limited time, such as the eight of war (*otto di guerra*), or the ten of the sea (*dieci del mare*). There were two legislative councils: the *consiglio del popolo*, three hundred in number, containing only *popolani*; and the *consiglio del commune*, numbering two hundred and fifty, to which nobles were also admitted. Besides the regular municipal magistracies, there was an important body, the *parte guelfa*, which exercised very great political influence. This corporation, which had its own captains and council, had been formed after the great Guelf victory of 1267 to administer the confiscated property of the exiled Ghibellines. Its great wealth and efficient organisation were employed for the assiduous maintenance of Guelf ascendancy, and in later times for resisting the claims of the lower classes to a voice in the government.

Of the northern states only three deserve special mention at this time. Genoa, isolated in the north-western corner and surrounded by mountains, plays a very slight part in the general history of Italy, though it has some considerable importance as commanding the direct route from Provence to the peninsula. The energies of its citizens were mainly absorbed in the acquisition of wealth by eastern trade, in maintaining wars with Pisa and Venice, and in the incessant feuds of the great families of Doria and Spinola. Milan, which had long held a predominant position among the Lombard towns, was already beginning to lose its republican independence. There, as in Florence, class divisions were mixed up with the quarrels of factions. In 1259 the Guelf leader, Martino della Torre, headed the citizens in a successful struggle against the Ghibelline nobles, and took advantage of his victory to assume the lordship of the city. The neighbouring towns of Lodi, Como, Vercelli, and Bergamo fell one after another under the rule of the

The 'Parte
Guelfa.'

Genoa.

Milan.

Della Torre. But in 1277 a revolution was effected by the Ghibellines under the Archbishop of Milan, Otto Visconti, to whom the lordship of the city was transferred, and from whom it passed on his death in 1295 to his nephew Matteo Visconti, the ancestor of the later dukes of Milan. But the Visconti dynasty was not yet permanently established, and in 1302 a Guelf league was formed among the chief Lombard towns which forced Matteo to withdraw, and Guido della Torre became the ruler of Milan.

Venice, the last of the important northern states, was even more isolated from Italy than Genoa, both by geography and by its absorbing interests in the Levant. The overthrow of the Greek Empire in 1204 had given Venice a commanding position in the east, but the restoration of 1261 had raised a very formidable rival in Genoa, and for more than a century the two republics were engaged in a series of costly and exhausting wars. But the main interest of Venetian history at this time lies in the building up of that oligarchical constitution which gave to Venice a vigour and consistency of political action quite unique in Italy, and enabled her in the fifteenth century to establish a very formidable power on the mainland.

The institutions of Venice, though sufficiently alien from modern usages, were simplicity itself as compared with those of Florence. This simplicity is due primarily to the entire absence in Venice of a landed nobility, whose power had to be overthrown in other Italian cities by a series of revolts on the part of the citizens, and also to the fact that Venice remained completely untouched by the faction fights of Guelfs and Ghibellines. At the head of the state stood the doge, elected for life, and in early times possessed of almost autocratic power. But his authority had been gradually limited by the compulsory association of councillors, by the exaction of a solemn oath on election (*promissione ducale*), and by the creation of new institutions. By the fourteenth century the doge had

become an ornamental sovereign, surrounded by great pomp and ceremonial, presiding in all assemblies, but possessed of no power of initiation and of no means of exerting more than personal influence. A doge of strong character might still mould the destinies of Venice, but it was by persuading his colleagues, not by the exercise of any regal authority. The election of the doge rested originally with the whole people. In 1172 a council, which grew into the *Maggior Consiglio*, was intrusted with the task, which was gradually delegated to small committees chosen in various ways. At last, in 1268, the elaborate system was adopted which lasted till the fall of the republic. All members of the Grand Council over thirty years of age drew balls from an urn, and thirty of these balls were gilt. The thirty who drew the gilt balls were reduced to nine by a second drawing of lots. The nine elected forty, seven votes being a necessary minimum. The forty were reduced by lot to twelve, who elected twenty-five, each receiving at least nine votes. The twenty-five were reduced by lot to nine, who elected forty-five, who must each receive seven votes. The forty-five were reduced to eleven, who chose forty-one, each to receive nine votes. The forty-one then took an oath and proceeded to vote for the vacant office. The voting was repeated until some candidate had received at least twenty-five votes, and he became doge. The form of demanding popular approval of the election did not become obsolete until the election of Francesco Foscari in 1423.

With the doge were associated six ducal councillors, who were necessarily consulted on every subject and without whom the doge could do nothing. In fact, the ducal functions were really discharged, not by the doge, but by a committee of seven of whom the doge was one. The *Collegio* or cabinet of ministers (*savii*), conducted the routine work of administration, and prepared all business for the other public bodies. The business of every department passed through the *Collegio*, in which the six *savii grandi* presided in weekly

terms. The *Quarantia*, or Forty, was originally created in the twelfth century to act as a permanent senate, but it was gradually limited to judicial functions, and became the great law-court of Venice. The functions of the senate fell to the *Pregadi*, a body of a hundred and sixty members, whose name was derived from the originally voluntary consultation of prominent citizens by the doge. The *Pregadi* became a permanent part of the constitution in 1229. Their chief business was the first consideration of all legislative proposals, the appointment of ambassadors, and the general supervision of foreign affairs.

At the basis of the constitution was the *Maggior Consiglio*, which had gradually taken the place of the primary assembly of all citizens. The council was originally elective, and its rise was a natural result of the growth of Venetian population. But in 1297 a law was carried which finally changed the government of Venice from a democracy to a close oligarchy. A list was drawn up of all who had sat in the Great Council for the last four years, and their names were put up to ballot in the *Quarantia*. All who received twelve votes were to be members of the council. Three electors were to be appointed every year to make a list of any other candidates, and their names, if approved by the doge and his councillors, were to be balloted by the *Quarantia*. For a few years the addition of names was frequent, though few candidates were successful unless their ancestors had at some time or other had a seat in the council. But in 1315 the names of all eligible candidates were drawn up once for all and placed in a book, and in 1319 the three annual electors were abolished. Henceforth membership of the Great Council became a hereditary privilege, and the admission of a member's son as soon as he had reached the age of twenty-five was regarded as a matter of course. The *serrata del Maggior Consiglio*, or closing of the Great Council, divided the Venetian population into two sharply defined classes: the nobles, who had the privilege of membership,

and the lower classes, who were for ever excluded from any voice in the government.

Although the abolition of popular election in 1297 was a change to which things had long been tending, it could hardly take place without exciting considerable discontent. Several conspiracies were formed against the new oligarchy, and after the failure of a formidable plot under Bajamonte Tiepolo in 1310, it was determined to devise some new machinery for the detection and repression of future revolts. Council of Ten, 1310. Ten members were chosen by the Great Council to act as a sort of committee of public safety. So useful did they prove that they were renewed year after year, and in 1335 they were made a permanent part of the constitution. The Council really consisted of seventeen, as the doge and his six councillors were associated with the Ten. The latter were elected yearly, and could not hold office again till a year had elapsed. The proper function of the Ten was to act as a court of exceptional jurisdiction, somewhat like the Star Chamber in England. In this capacity they served as the efficient bulwark of the Venetian aristocracy, and coerced the inferior citizens into passive acquiescence in the rule of their superiors. As time went on, the Ten became more and more powerful, and began to interfere in the general conduct of affairs. So great became the passion for secrecy in the Venetian government, that in the sixteenth century the Ten began to delegate their functions to a sub-committee, the three Inquisitors of State.

For sixty years Italy had been allowed to take its own course without any attempt at interference on the part of its nominal suzerain in Germany. The news that Henry of Luxemburg, elected in 1308, was preparing to visit Italy and to revive the imperial power, Henry VII. in Italy, 1310-1313. made a profound impression in the peninsula, where the Gulf and Ghibelline parties were as active and bellicose as ever. These party names had by this time ceased to express

any essential difference of principle. The imperial suzerainty in the north, and the papal suzerainty in the south were equally shadowy, and neither seemed substantial enough to fight for. The idea that the Guelfs were the champions of republican liberty as against aggressive despots, had ceased to have any real foundation in facts. A Della Torre was just as dangerous to the liberties of Milan as a Visconti. Since the Popes had called in the House of Anjou, and especially since a Pope had fixed his residence in Avignon, it was impossible to contend that the Guelfs were the champions of Italian independence against foreign domination. The anomalous relations of Italian parties were reflected in the equally anomalous position of Henry VII. A German prince elected by German princes to the throne of the Hohenstaufen, he seemed destined to revive the principles of Ghibellinism and to assume the headship of a revived Ghibelline faction. On the other hand, Henry was French by education and sympathies, he owed his election to the clerical partisans of France acting under papal influence, and he was accompanied in his march by legates whom the Pope had authorised to confer upon him the imperial crown in Rome. It was no empty pretence of moderation, but the expression of a real policy, when Henry professed that he belonged to neither faction and intended to act as a mediator between them. And his actions corresponded with his professions. As he passed through the Lombard cities he insisted on the return of all political exiles, whichever party they belonged to. In Milan, where he received the iron crown of Lombardy (January 6, 1311), he recalled Matteo Visconti without overthrowing the rule of Guido della Torre. But the Italians themselves had no sympathy with his impartiality. Henry VII., like most of his German predecessors, was in need of money, and the attempt to levy a contribution of 100,000 ducats provoked a rising in Milan. The rising was suppressed, but it resulted in an inevitable alliance between the Emperor and the

Ghibellines. Guido della Torre and his family were driven into exile, and an attempted rebellion in the Guelf cities was suppressed. Brescia alone made any lengthy resistance to the German army. Before leaving Lombardy, Henry appointed imperial vicars in the chief cities, and in Milan he intrusted the office to Matteo Visconti, thus finally establishing the dynasty which ruled Milan for a century and a half, and at one time seemed likely to unite the whole of northern Italy under its sway.

From this time the difficulties of Henry VII. rapidly increased. The force of circumstances had compelled him to become a Ghibelline against his will. The hopes which that party built upon his arrival are expressed in the *De Monarchia* of Dante. Peace could only be bestowed upon Italy by a strong monarchy, and such a monarchy could only be established by a German king with the traditions of the Empire at his back. But the more enthusiastic the Ghibellines became, the more resolute was the opposition of the Guelfs. Robert of Naples, the close ally of Clement V., did not venture to embark on open hostilities, but he was rendered both jealous and uneasy by Henry's progress, and did not hesitate to intrigue against him. Henry VII. succeeded in obtaining the lordship of Genoa and Pisa, the latter of which was always on the Ghibelline side. But Florence, the leading Guelf city in Tuscany, obstinately refused to admit the German king or his troops, and he was compelled to pass on one side on his journey to Rome. There he found the greater part of the city occupied by the Guelf family of Orsini, assisted by a Neapolitan force. A battle would have been necessary to obtain possession of St. Peter's, and the coronation ceremony had to take place in the church of St. John Lateran (June 29, 1312). Henry VII. was now convinced that the reduction of Italy to obedience could only be accomplished by force of arms. King Robert had as yet avoided any declaration of war, and it would have been dangerous to attack Naples while the

Guelfs in the north were strong enough to cut off communications with Germany. It was decided to strike terror into the Guelfs by the reduction of Florence. The German troops advanced to the city walls in September, 1312, but they found them too strong and too well garrisoned to venture on an attack. Henry retreated to Pisa to await reinforcement. Against Robert of Naples, who was preparing to give active assistance to Florence, he issued the imperial ban, and concluded an alliance with the Aragonese king of Sicily.

Death of Henry VII., 1313. Henry had commenced his march to meet the Neapolitan troops, when he suddenly died of fever at Buonconvento, twelve miles from Siena (August 24, 1313). The Ghibellines believed that he had been poisoned by a Dominican monk in administering the sacrament. The schemes of Henry VII. were entirely out of date: the Holy Roman Empire, as Dante understood it, was already an anachronism: and the Emperor's death is only important as marking the failure of the last serious attempt to reduce Italy to obedience to a German king. The forces of disunion were strong enough to break up any monarchy; it was only an added weakness that the monarchy was claimed by a foreigner.

CHAPTER III

FRANCE UNDER THE LATER CAPETS, 1270-1328

Progress of the French Monarchy—Its difficulties—Philip III.—The inheritance to Toulouse, Champagne, and Navarre—Wars with Castile and Aragon—Accession of Philip IV. and the importance of his reign—His War with England and Flanders—His relations with the Papacy—The suppression of the Templars—His policy of annexation—His domestic government—The King's Court and its departments: the *conseil du roi*, the *chambre des comptes*, and the *Parlement* of Paris—The States-General—Financial maladministration—Death of Philip IV.—Louis X.—His death and the succession question—The Salic Law—The short reigns of

- Philip V. and Charles IV.

THE history of the modern kingdom of France begins with the break-up of the great Karoling Empire in the treaty of Verdun (843). Western Francia, split off from the other dominions of Charles the Great, continued for a century to be ruled by his degenerate descendants. But the decentralising movement did not stop with the division of the Frankish Empire into three fairly well-defined units. The dukes and counts, who had been provincial governors under Charles the Great, took advantage of the growing weakness of the central power to make their position hereditary and practically independent. Superficial unity was only maintained by the necessity of making head against the attacks of the Northmen. The successful resistance of Paris to these invaders gave to the dukes of Paris, the lords of the Isle de France, the royal title which the Karolings at Laon were too feeble to defend. But the early kings of the House of Capet were as powerless as their predecessors. They themselves belonged to the feudal nobles, they owed the crown to the support of their

fellows, they were avowedly only *primi inter pares*. Hugh Capet himself acknowledged this when he undertook to do nothing of importance without consulting the tenants-in-chief. During the eleventh century France was little more than a geographical expression: its political unity was a mere shadow: its ecclesiastical unity was independent of the crown. But in the twelfth century two movements began

Progress of the French monarchy. which were destined to exert the most decisive influence on the fortunes of France: the rise of the communes, and the growth of the royal power.

There was no formal alliance between the crown and the bourgeoisie, but they had obvious common interests in opposition to the feudal nobles, and they rendered the most vital assistance to each other. Feudalism, attacked both from above and from below, seemed destined to perish. The three kings who dealt the most fatal blows to aristocratic isolation were Philip Augustus (1180-1223), Louis IX. (1226-1270), and Philip IV. (1285-1314). The third estate rendered its greatest service to the monarchy by giving birth to the class of lawyers. To their superior training and their persistent advocacy of the principles of Roman Law was due the gradual break-down of feudal jurisdiction. The *cour du roy*, at first either the court of the royal domain or the court of peers for the trial of cases concerning tenants-in-chief, became, as the Parliament of Paris, the supreme judicial court for the whole of France.

Side by side with the advance of the central judicial power, another great change was going on—the extension of the royal domain. In the great fiefs female succession was admitted in default of male heirs, and this proved fatal to the permanence of many of the old families. With regard to the crown there was no acknowledged rule of succession, because no occasion for dispute arose. From the accession of Hugh Capet in 987, to the death of Louis X. in 1316, there was never wanting a son to succeed to his father. This uninterrupted male succession for so many generations, almost unparalleled among the reigning families of Europe, was an

invaluable element of strength to the crown in its struggle with feudalism. One by one the great fiefs fell in, were conquered, or were acquired by marriage with heiresses. The most notable successes were the acquisition of Normandy by Philip Augustus, and of Languedoc after the Albigensian crusade. By the time of Philip the Fair the only provinces which retained their feudal independence were the county of Flanders in the north, the duchy of Brittany in the west, the duchy of Burgundy in the east, and the duchy of Aquitaine in the south. The royal power and the territorial unity of France had advanced *pari passu*, and Philip iv. found himself strong enough to attempt acquisitions beyond the traditional frontiers of France.

So far—during the twelfth and thirteenth centuries—the tendency towards centralisation, in spite of temporary obstacles and checks, had achieved that success which usually attends directness and persistence of aim, and a politic, if sometimes unscrupulous, choice of means. But at the death of Philip iv. this progress was suddenly arrested, and during the next two centuries a struggle had to be carried on, differing in many respects from that which had gone before, but still involving many of the same problems and ultimately terminating in a victory for the same side. One essential factor in this struggle was the tenure of the duchy of Aquitaine by a foreign prince—the king of England. Obvious interest impelled English kings, like Edward III. and Henry v., to ally themselves with all the forces of disunion in France, and their efforts were aided and stimulated by the chance which gave them a colourable claim to the French crown. But the difficulties of the French kings of the House of Valois were not due merely to English intervention. There were two fatal flaws in their own policy and that of their predecessors. (1) While taking every advantage of the movement of the lower classes, the kings had done little or nothing to satisfy their legitimate aspirations. They gave the lawyers a distinguished position in the service of the

Difficulties of the monarchy in the fourteenth and fifteenth centuries.

crown, and that was all. Before long, the third estate was sure to weary of an alliance in which all the substantial advantages were on one side; and if the commons were able or willing to form a coalition with the nobles against the crown, they might impose checks upon the royal power similar to those which were enforced by the English parliament. That this danger was a real one will be seen when we come to consider the attitude adopted by the States-General at the time of the battle of Poitiers.¹ (2) While destroying the old feudal nobility, the French kings had created a new one. As the great fiefs fell in, many of them were granted out again as appanages to members of the royal family. Doubtless it was considered that blood-relationship would be sufficient to unite their interests with those of the monarchy. But this proved a complete miscalculation. Relationship counts for very little in politics as against the impulse given by selfish interests. Edward III. tried a similar policy in England, and it led to the Wars of the Roses. In France it led to the long contest of the Burgundians and Armagnacs, to the *Praguerie* of 1440, and to the League of the Public Weal of 1465. The *féodalité apanagée*, as French writers call these nobles of royal birth in contradistinction to the old *féodalité territoriale*, did not long delay to assume the same attitude as their predecessors, and became the opponents of the monarchy which had created them. Their overthrow tasked the devotion of the capable servants of Charles VII., and gave full employment to the mingled craft and resolution of Louis XI.

The futile expedition to Tunis, the expiring effort of that crusading impulse which had urged mediæval Europe to heroic deeds, cost France the life of the noblest Philip III., of her long line of kings. Louis IX. was almost the only French ruler who combined the highest moral virtues with eminent political capacity. His son and successor, Philip III., could claim neither of his father's characteristics. He was illiterate, and the rashness which earned him the

¹ See below, chap. iv., pp. 81-88.

name of *le Hardi* was not redeemed by any clear insight or any signs of ability. He was only in name the head of the House of Capet: the real master of French policy was his uncle, Charles of Anjou. Paris looked for guidance to Naples, rather than Naples to Paris. That the French monarchy continued to advance, in spite of the incapacity of the king, is a signal proof of its inherent strength and of the ability of the trained lawyers who served it. The reign of Philip III., obscure as it appears at first sight, was marked by the acquisition of three important provinces, of which two remained permanently subject to the crown.

Among the numerous victims who perished on the return journey from Tunis were Alfonso of Poitiers (August 21, 1271), brother of St. Louis, and his wife Jeanne ^{The Toulouse} of Toulouse, the last descendant of the famous ^{inheritance.} House of St. Gilles. They left no children, and their vast inheritance, including the counties of Toulouse, Poitou, Auvergne, and the marquisate of Provence,¹ fell to the French crown. The only exceptions were the district of Agenais, which was claimed by the English king, and the Venaissin, near Avignon, which was ceded to the Papacy in accordance with the treaty of Meaux in 1229. Thus France completed the absorption of Languedoc, which had been begun in the crusade against the Albigenses. It is true that Philip undertook to rule his new territories as count, and not as king, and that he created a special parliament and law-court at Toulouse, but these concessions to local independence were only temporary and illusory.

In 1274 occurred another important death, that of Henry, King of Navarre and Count of Champagne and Brie, leaving

¹ Since 1125 Provence had been divided into two parts: (1) the county, south of the Durance, which was given to the family of Bérenger, and passed, with the hand of their heiress Beatrice, to Charles I. of Anjou and Naples; (2) the marquisate, between the Durance, the Isère, the Alps, and the Rhone, which was held by the counts of Toulouse, and was brought by Jeanne to her husband, Alfonso of Poitiers.

an only daughter, Jeanne, aged three years. The widow, Blanche of Artois, carried the infant heiress to France and Champagne threw herself on the protection of the king. Philip and Navarre. at once occupied Champagne and Brie, which were henceforth united to the crown. At the same time he procured a dispensation from Pope Gregory x. for the future marriage of Jeanne to his own second son Philip, who soon afterwards became heir to the throne by the death of his elder brother. The people of Navarre revolted against this high-handed settlement of their fate by a foreign prince, but their resistance was crushed by a French army, and Philip assumed the government of the kingdom as guardian for his future daughter-in-law.

These territorial gains were the only notable successes of Philip III.'s reign, and his remaining years were mainly occupied with two futile wars in Spain. Alfonso x., Wars with Castile and Aragon. formerly the claimant of the throne of the Cæsars, was still reigning in Castile, but the actual conduct of affairs fell in his old age to his sons, Ferdinand de la Cerda and Sancho. The elder, who had married Philip III.'s sister Blanche, died in 1275, leaving two sons. The Castilian Cortes, in regulating the succession, passed over these children, and secured the crown on Alfonso's death to Sancho, who had earned the name of 'the Brave' for his exploits against the Moors. Philip was indignant at the exclusion of his nephews, and took up arms to support their claims. But his invasion of Castile was so reckless and ill-planned as to gain him the name of *le Hardi*, and he was unable to force a passage through the mountains. His intervention was naturally fruitless, and Sancho succeeded to Castile on his father's death.

The second war was more prolonged. The Sicilian Vespers in 1282 (*v. p. 25*), which resulted in the transfer of Sicily to Peter III. of Aragon, made a profound impression in France, and many nobles hurried to offer their services to Charles of Anjou. The Pope excommunicated Peter III., and offered

the crown of Aragon to Philip III.'s second surviving son, Charles of Valois, on condition that it should never be united to France. The offer was accepted in 1284, and in the next year Philip himself headed a great expedition against Aragon, which was dignified by the name of a crusade. The capture of the fortresses of Elna and Girona, both after an obstinate resistance, were the only successes of the campaign. Roger di Loria with his Catalan sailors destroyed the French fleet, and cut off the possibility of receiving supplies by sea. At the same time disease broke out in the French army. Philip found it necessary to retreat, and died at Perpignan on October 5, 1285. He left three sons: Philip, who in 1284 had married Jeanne, heiress of Navarre; Charles, Count of Valois and Alençon, and titular King of Aragon; and Louis, Count of Evreux, whose descendants afterwards ruled in Navarre.

Philip IV. was seventeen years old when he succeeded his father, and he died at the age of forty-seven. In the course of these thirty years he set a mark upon French life and government which has never been completely effaced, not even by the floods of successive revolutions. Yet our knowledge of his reign, and especially of his person and character, is singularly scanty. That he was good-looking we know from his being called *le Bel*, but we are not informed whether he was tall or short. His character we have to infer from his actions, and we are forced to conclude that it was far less attractive than his face. This dearth of contemporary records is the more notable when it is contrasted with the striking picture which we possess of his grandfather, and with the wealth of narrative on the subject of the fourteenth century wars. Philip was not the man to be the hero of a Joinville or a Froissart, and no Philippe de Commines had yet arisen. There is little that is heroic or picturesque about his reign. The most striking scene, the humiliation of Boniface VIII., is repulsive in itself and is discreditable to Philip's memory. It may even be said that

Death of
Philip III.,
1285

Philip IV.,
1285-1314.

there was little result to show for his restless activity. The two enterprises which he had most at heart—the annexation of Aquitaine and Flanders—ended in failure. His only territorial acquisition of importance was Lyons. The suppression of the Templars was not an achievement to be proud of. A notable victory was gained over the Papacy, but it was gained by discreditable methods; and, after all, the residence at Avignon brought no permanent advantages to France. Philip's great work lay in the comparatively obscure details of domestic government, in the improvement and completion of administrative machinery, and in the removal of all obstacles in the way of an efficient despotism. These are achievements which escape the notice of historians who are attracted by the heroes of chivalry, but they produce far more definite and deep-seated results than the most brilliant exploits on the battlefield. It must be admitted that Philip iv. was cruel and cold-blooded; that his regard for the letter of the law was a mere disguise for unscrupulousness; that this unscrupulousness was the more repulsive for the hypocrisy which could always find pretexts to justify it; it may even be admitted that his failures in external politics outweighed his successes,—yet he must be always memorable as the real founder of that administrative centralisation which has ever since been the dominant characteristic of the government of France, and has been a prominent cause of the subsequent greatness, if also of the subsequent disasters, of that country.

If this estimate of the reign be correct, it is obvious that we need not linger long over Philip's foreign relations, and that our attention will be better devoted to his domestic measures. The war with Aragon, which he inherited, never interested him, as the only possible gainers by it were his brother and his cousin. After lasting for nearly twenty years, it ended in the final loss of Sicily by the House of Anjou, and the abandonment by Charles of Valois of his claims on Aragon on condition that his cousin, Charles II. of Naples, should

give up to him his appanages of Anjou and Maine. Before this settlement had been arrived at, Philip had turned his attention to a far more exciting enterprise—the attempt to wrest Guienne and Gascony from Edward I. of England. These provinces had been united to the English crown since the marriage of Henry II. with Eleanor of Aquitaine, and on the whole they were fairly satisfied to remain subject to their distant ruler, whose island kingdom gave them a convenient market for the produce of their vineyards. But Edward I. had his hands full with the suppression of discontent in his recent conquests in Wales, and with enforcing his lately acknowledged suzerainty over Scotland. This gave Philip IV. an opportunity which he was not slow to seize. Taking advantage of a naval quarrel between some Norman sailors and the mariners of the Cinque Ports, and of the refusal of the Gascons to acknowledge the judicial authority of the French courts, Philip summoned Edward I. to appear before him to answer for the breach of his obligations as a vassal (November, 1293). Edward was aware that a contumacious attitude towards his suzerain would set a dangerous example to John Balliol in Scotland, and did all in his power to avoid a rupture. Unable to go to France in person he sent as a proxy his brother Edmund, who had married Philip's mother-in-law, Blanche of Artois. On this docile envoy Philip played what can only be described as 'the confidence trick.' He assured him of his perfect friendliness to England, offered the hand of his sister Margaret to Edward, who was now a widower, and in return he demanded that, as a mere sign of trust and submission, Gascony should be ceded to him for a period of forty days. Edmund consented; but on the expiration of the time, Philip declared the English king to be contumacious for not having appeared in person, and his troops remained in occupation of the Gascon fortresses. After this there was no alternative but war. Edward was at an immense disadvantage. He had a war with Scotland and Wales on his hands,

his subjects, especially the clergy, were discontented at his exactions, and the enemy was already in possession of a large part of his territories. His only ally of importance, Adolf of Nassau, was too impotent in Germany to effect any diversion. On the other hand, Philip offered aid to John Balliol, and thus laid the foundation of that permanent alliance between France and Scotland which lasted till the reign of Mary Stuart.

The actual hostilities were unimportant, but the balance of success was decidedly against the English. It was at this time that Boniface VIII.'s attempt to interfere led to his first quarrel with Philip IV., and to the issue of the bull *Clericis laicos* (v. p. 29). In 1297 the war assumed a new phase. Edward I. had succeeded in deposing John Balliol and in conquering Scotland, so that he was now free to take part in the continental war. At the same time he found an ally in Count Guy of Flanders, who had hitherto been kept passive by Philip's detention of his daughter as a hostage. But Edward was again hampered by quarrels with the clergy and the barons, and the latter refused to serve in Gascony if the king persisted in going in person to Flanders. The result was that Guienne and Gascony were left defenceless, while Edward and his Flemish ally were unable to make head against the French. This check and the outbreak of a Scotch rebellion under Wallace forced Edward to make overtures for peace, and Philip determined to postpone the annexation of Aquitaine until he had completed the reduction of Flanders. Boniface VIII. had been compelled by difficulties in Italy to draw closer to the French king, and he had published a modified interpretation of his bull against clerical contributions to secular rulers. He was now allowed to act as mediator, though Philip protested that he accepted his mediation as a private person and not as Pope. It was arranged that both parties should retain their possessions as they stood until the conclusion of a final settlement. As a security for future peace, Edward I. was to marry Philip's sister, Margaret, and the young Edward of Wales

was betrothed to Philip's daughter, Isabella. Both kings abandoned their allies (June 30, 1298).

While Edward I. returned to defeat Wallace at the battle of Falkirk, Flanders was left at Philip's mercy. The Flemish citizens had no love for their count, and would render him no assistance. In this hopeless position, Guy War in Flanders. was induced by the treacherous promises of Charles of Valois to trust to the clemency of his suzerain. He was at once thrown into prison, and his fief was declared forfeited to the crown (1300). On his first visit to his new province, Philip's cupidity was excited by the wealth which he found there. His wife, Jeanne of Navarre, exclaimed, when she saw the jewellery of the ladies of Bruges: 'I thought I was the only queen in France, but I find that here there are six hundred.' The attempt to gratify the greed thus aroused was certain to lead to discontent. The Flemings were as fond of their wealth as they were jealous of their independence. They soon discovered that it was better to be oppressed by their count than to be both oppressed and pillaged by their French governor, Jacques de Chatillon. The signal for a general rebellion was given in Bruges, as twenty years before in Palermo, by a massacre of the French. Philip despatched a large feudal army under Robert of Artois to crush the insurgents. The French nobles reckoned on an easy victory over unwarlike and ill-armed citizens, but they were undone by their own confidence and recklessness, and were utterly routed in the famous battle of Courtrai (July 11, 1302). This was the first of a great series of battles which taught Europe that an infantry force, if properly led and handled, could more than hold their own against mounted and heavily accoutred men-at-arms. It was some time before the lesson was thoroughly learned; but when it was mastered, the military system of the Middle Ages collapsed, and with it perished the social organisation which rested on the invincibility of the knightly force. Philip IV. advanced in person to recover the lost honour and power of France,

but the approach of winter compelled him to retire without having done anything towards the suppression of the rebellion. The great disaster of 1302, the first which Philip had yet experienced, came at the crisis of his quarrel with the Papacy, and forced him to moderate his ambition. In 1303 he concluded a final peace with Edward I. and resigned his acquisitions in Aquitaine. In 1304, Boniface VIII. being dead, a great effort was made for the reduction of Flanders. At Mons-en-Puelle (August 18), by carefully avoiding the ruinous mistakes at Courtrai, Philip succeeded in defeating the Flemings; but his victory was hardly won, and was by no means so decisive as that of his opponents had been. Within three weeks the rebels had re-formed their army and were as formidable and undaunted as ever. Philip found himself compelled to recognise that he had undertaken a task beyond his strength, and he hastened to escape from it by concluding a treaty (June, 1305). Robert of Béthune, the eldest son of Count Guy, who had died in prison in 1303, was invested with the fiefs of Flanders, Nevers, and Rethel; the Flemings undertook to pay 200,000 livres to the French king, and to hand over as security for the payment Douai, Lille, and other towns on the southern frontier. It was long since a French king had suffered such a humiliating check. In 1300, Philip seemed to have secured the whole of Flanders and the greater part of Aquitaine. Four years later he had lost both provinces.

Philip's relations with the Papacy have been already alluded to (*v. p.* 29). In his quarrel with Boniface VIII. he had substantial justice on his side, and the national development of France necessitated an energetic resistance to the exorbitant pretensions of the mediæval Papacy. But these considerations do not justify the brutality of the French soldiery at Anagni, nor the vindictiveness with which Philip persisted in blackening the character of Boniface after the latter's death. Equally inexcusable was his treatment of the ill-fated Benedict XI., though there is no reasonable ground

for believing the charge that Philip's agents poisoned the Pope in consequence of his excommunication of Boniface's assailants. In Clement v. the king was face to face with a Pope upon whose subservience he had reasonable claims, and who was fully his match in diplomatic subtlety and in the want of scruples. The hold which Philip obtained upon the Papacy at this time enabled him to effect the blackest action of his reign, the destruction of the Templars. The crusades in the East had come to an end with the fall of Acre in 1291, and the Orders which had been formed for the defence or conquest of Palestine must inevitably fall victims to the jealousy which their wealth and independence excited in Europe, or they must undertake some new task which would justify their existence and give them a renewed hold on the public opinion of Europe. The Knights of St. John and of the German Order of St. Mary chose the latter course, and secured a prolongation of their corporate existence—the one in Prussia, and the other in the island of Rhodes. The Templars, who had been the most prominent in the wars of Palestine, were the least prepared to find a new occupation, and their inaction impaled them on the other horn of the dilemma. It is needless to go through the long catalogue of charges, some horrible and some absurd, which were brought by the king's agents against the Order. It was inevitable that a celibate society of warriors should give occasion for the belief that the vow of chastity was not always observed. It is credible that in their intercourse with the Saracens many of the knights may have been led into unbelief, or even to adopt a contemptuous and irreverent attitude towards Christianity. But it is not credible that the whole Order was guilty of the obscenity, blasphemy, and irreligion that were charged against its members. Confessions extorted under horrible tortures and recanted when health and sanity were restored, do not constitute evidence from which any reasonable conclusions can be drawn. But Philip iv. was deaf to all considerations

Suppression
of the
Templars.

of justice or of clemency, and his iron will extorted a condemnation from judicial tribunals and from the Pope. In 1310, after the trial had lasted for two years, fifty-four knights were burned in Paris, and many other executions followed. In 1312 the Order was formally suppressed, and its possessions transferred to the Knights of St. John. This last provision was only imperfectly fulfilled, and much of the Templars' hoarded wealth never passed from the hands of the king. In 1314 the last grand master, Jacques de Molai, after a solemn retraction of all extorted confessions, and a denial of the truth of all charges against the Order, perished at the stake on an island in the Seine.

Philip's last success was an encroachment on those border territories between France and Germany which constituted the obsolete kingdom of Arles. The first step towards their annexation to France had been taken when Philip III. inherited the marquisate of Provence (see above, p. 47). In 1291 Philip IV. had arranged a marriage between his second son, Philip, and Jeanne, daughter and heiress of Otto IV., Count of Burgundy. This marriage brought Franche-Comté under French influence, but did not result in the final annexation of the province, which was not accomplished till the treaty of Nimeguen in 1678. For a long time the city of Lyons and the adjacent territory had been objects of French covetousness, and constant quarrels between the archbishop and the citizens offered frequent pretexts for intervention. At last, in 1312, taking advantage of the Emperor Henry VII.'s absence in Italy, Philip IV. ventured to take the final step, and Lyons was incorporated with France.

We must now turn to Philip IV.'s domestic government, which constitutes his sole claim to a place among the great kings of history. His aims were those of his predecessors—those, in fact, of all kings in the later Middle Ages who wished to extend their power. He had to destroy feudalism as a basis of government, or, in the

words of a great historian, to 'eliminate the doctrine of tenure from political life.' The essential vice of the feudal system was that every man was directly bound only to the immediate lord of whom he held his land; the connection with that lord's suzerain was purely indirect. Hence came an inevitable tendency to disruption; the tie between vassal and lord was stronger than the indirect tie between the sub-tenant and the king; if a great noble rebelled he could compel his tenants to follow him even against his suzerain. For this system, which had many merits, but was inconsistent with either national unity or a strong government, Philip desired to substitute an organisation in which all Frenchmen, whether tenants-in-chief or sub-tenants, should stand in equal subjection to the law and to the king as the source and guardian of the law.

To accomplish this end, an efficient administrative machinery was necessary, and of this the foundations had been laid by Philip's predecessors. The country was divided into *bailliages* in the north and *sénéchaussées* in the south. Philip iv. regulated and extended the functions of the bailiffs and seneschals, and employed them not only to carry out his edicts in the provinces, but also to supply him with that accurate local information without which centralisation is useless and incompetent. Besides these local officials, he had the *cour du roi* which attended his person. The King's Court. This body, the earliest institution of Capetian

France, was originally merely the court of the king's domain, and consisted of the household officers and the immediate domain tenants. From time to time, however, the king must have had to decide questions concerning the great tenants-in-chief, and by the essential principle of feudalism such questions must be referred to their equals. Hence arose the court of peers, the creation of which is assigned by tradition to Philip Augustus when he summoned John of England to answer for the murder of Arthur of Brittany. Whether this court ever had a separate existence from the domain court is

difficult to decide, but if it had, it soon lost it. In the reign of Louis ix. the domain court was transformed, when necessary, into a court of peers by the addition to it of some of the great vassals. At the same time, the court was made more efficient by the introduction of trained lawyers. Under Philip iv. these lawyers became the real managers of the work of justice and administration; and the nobles, though retaining the right of attendance, preferred as a rule to absent themselves from business in which their want of legal training placed them at a conspicuous disadvantage. The work of the court included all departments of government: the advising of the king, the management of finance, and the administration of justice. And the judicial work was enormously increased, partly by the compulsion of the nobles to allow appeals from their local courts to that of the suzerain, and partly by the reservation of an increasing number of *cas royaux*—i.e. cases which had to be brought in the first instance before the king. It was impossible for one body of men to discharge such a vast mass of business, and the court was gradually split up into three great departments, which continued, with modifications in detail, to conduct the routine administration of France till the Revolution.

(1) The first of these divisions was the *conseil du roi*, which corresponds roughly to the Privy Council in England. It consisted of the great officers of the household with fifteen councillors of state and two or more secretaries. Its chief business was to advise the king in all affairs of government. Ordinary jurisdiction was delegated to the Parliament, but the council continued to exercise judicial power. Appeals could in the last instance be made to the king in council, and he could evoke cases to it from other courts.

(2) The *chambre des comptes* was the financial division of the royal court, and resembles the English Exchequer. It received and audited the accounts of the bailiffs and seneschals; it had jurisdiction in all financial suits, and it registered all edicts and deeds which concerned the domain.

(3) The most famous of the three bodies was the great law-court of France, the Parliament of Paris. Its functions correspond to those of the courts of King's Bench and Common Pleas in England, but its peculiar history arises from the maintenance of a corporate unity and authority which the English judges never possessed. Philip iv. not only gave to the Parliament a separate existence, he also fixed its sessions in Paris, and organised its three earliest sub-divisions. The *chambre des requêtes* decided the lesser cases of first instance brought directly before the Parliament. The *chambre des enquêtes* received and prepared for further consideration all appeals from lower courts. The *grande chambre* was the largest and most important of the sub-divisions, and is often called the Parliament by itself. In it the peers retained the right of sitting down to the Revolution, but they only appeared on formal occasions. The *grande chambre* decided all important appeals, and cases of first instance concerning the peers, the royal officers, and the members of the sovereign courts. At first the Parliament only met twice a year, at Easter and All Saints. But the two sessions proved insufficient to discharge the growing business of the court, and, later in the century, it was made a permanent court, and its members were appointed for life or during the royal pleasure. In addition to its judicial work, the Parliament had to register all royal edicts, treaties of peace, and other formal documents. This was originally a duty rather than a right; and it was not till much later that the Parliament based upon this practice a claim to remonstrate against, or even to veto, the edicts of the king.

The organisation of this administrative machinery is the greatest achievement of Philip iv.'s domestic government. But his reign is also noteworthy for the origin of the States-General, which at one time promised to become the basis of a constitutional system of government such as was our Parliament established in England, but was ultimately crushed into insignificance by

the crown which had created it as a mere instrument to serve its own ends. The first meeting was held in 1302, when Philip wished to parade the unanimity of his subjects in opposing the pretensions of Boniface VIII. They were summoned again in 1308 to condemn the Templars, and in 1314 to support the king in a renewed war with Flanders. Philip may have found a model for these assemblies either in the provincial estates of Languedoc and Brittany, or in the Cortes of Castile and Aragon, but it is more than probable that he was inspired by the example of his great contemporary, Edward I. of England, who in 1295 had summoned the famous 'model parliament,' and had himself in 1301 obtained a protest against the papal claims from a parliament at Lincoln.

The States-General under Philip IV. are especially remarkable for their numbers. All tenants-in-chief, whether clerical or lay, were invited to attend in person, and those who were prevented by any unavoidable cause might send proxies. The cathedral chapters and monasteries sent representatives; and so did all the towns of any size in the kingdom. There was no attempt to determine the condition which entitled a man either to vote or to be elected. The only class which was unrepresented was the peasantry. When the States met, they were divided into three estates: clergy, nobles, and citizens. The meeting only lasted a day, and there was no general discussion. The royal spokesman explained the object for which they were summoned, and then each estate separately drew up a document in accordance with the wishes of the king.

It is obvious that the summons of the States-General was not in any way forced upon the king by external pressure, but was a mere expedient to strengthen his hands. The assembly never got rid of this taint on their origin. If a French king thought his end could be best attained by summoning the States-General, he summoned them: but if, on the contrary, he thought it advisable to treat separately with the various

provinces, he did so. Later in the century an attempt was made to secure regular assemblies with definite authority, but the attempt was a failure, and parliamentary government was never established in France until the nineteenth century.

The whole of Philip's rule is marked by the steady encroachments upon feudal independence and privilege of an unscrupulous but efficient despotism. He claimed for the crown the right of creating peers, which he exercised in favour of Charles II. of Naples and of Robert of Artois. He raised to the rank of nobles men who had no qualification either by descent or by tenure, and was thus enabled to reward those ministers who borrowed from Roman Law the phrase, *quod principi placuit legis habet vigorem*, and coined from it a French legal adage, which the monarchy might have taken for its motto: *que veut le roi, si veut la loi*. But there was one glaring defect in Philip IV.'s government, which he also bequeathed to his successors. His financial administration was as incompetent as it was tyrannical and oppressive. He strained to the utmost the normal sources of revenue, the income from the domain and the feudal incidents. When these were exhausted, he imposed *gabelles* or taxes on the sale of commodities. But these taxes he was foolish enough to farm out to his creditors in order to obtain large sums of ready money. Such an expedient, especially in early times, always results in loss to the state and oppression to the taxpayer. More ruinous, because more dishonest, was the constant debasement of the coinage, which Philip carried to such lengths that contemporaries called him the 'false coiner.' Thus the founder of the French monarchy was also responsible for the defect which ultimately ruined his creation. It is an extraordinary thing that France, one of the richest countries in Europe, and in some ways one of the most efficiently governed, never had a sound financial system under the old monarchy. Philip's successors imitated the defects as well as the merits of his rule. To his devices of

Financial
maladmini-
stration.

farming the taxes and of debasing the currency they added the disastrous practice of selling offices, and of increasing their value by granting their holders exemption from taxation. Many Frenchmen saw and deplored the evil results of this system, but no one was strong enough to apply a drastic remedy. The deficit which resulted was the immediate occasion, though not the cause, of the great revolution. It may be fanciful, but it is not preposterous, to contend that, if Philip iv. had been a capable and honest financier, the Bourbons might still be seated on the throne of France.

Such a harsh government as that of Philip iv. could not possibly be popular. His direct attack upon their interests exasperated the *noblesse*, and his financial extortions alienated the *bourgeoisie*. In 1314 a new war broke out with Flanders, and Philip attempted to defray its expense by a heavy tax upon all commodities, to be levied on their sale, from both seller and purchaser. This caused an explosion, and for the first and only time nobles and third estate were leagued together against the king. Such an alliance threatened to ruin the monarchy, and Philip was forced to yield. He abolished the tax, and promised to redress the grievances of his subjects as regards the coinage. Soon after this humiliation he died (November 29, 1314).

During the next fourteen years Philip's three sons ruled in rapid succession, and their reigns are chiefly notable for the establishment of the all-important rule of succession which excluded females from the succession to the French throne. The eldest, Louis x., was only twenty-four years old at his father's death, and took no interest in the work of government. The conduct of affairs was allowed to fall into the hands of his uncle, Charles of Valois, who had always sympathised with the feudal opposition to Philip iv. The triumph of the reactionary party was seen in the trial and execution of Enguerrand de Marigny,

Death of
Philip IV.

Louis X.,
1314-16.

one of the chief advisers of the late king. But the nobles, freed for the moment from royal domination, were shortsighted enough to throw over their recent alliance with the bourgeoisie, and thus lost an excellent chance of imposing permanent restrictions upon the power of the crown. The concessions which they obtained were solely in the interests of their own class, and even they were not national concessions but were embodied in a series of provincial charters. The absence of national unity, to which these events testified, was a cause of the ultimate victory of the monarchy, which had never again to face such a hostile union of classes as had been formed for the moment in 1314.

Apart from this momentary victory of the feudal nobles, the reign of Louis x. is absolutely uneventful. He got rid of his first wife, Margaret of Burgundy, in order that he might marry Clementia, sister of Carobert of Hungary. He also undertook an expedition to Flanders in order to force the Count to observe his treaty obligations; but the campaign was wholly unsuccessful, and soon afterwards the young king died, on June 5, 1316. His death was more important than his life, as it gave rise to the first doubtful succession since the reign of Hugh ^{Succession question in 1316.} Capet. For the first time for more than three centuries there was no male heir to the crown, as Louis only left a daughter, Jeanne, the offspring of his first marriage. As the question of female succession had never arisen before, there was no rule to decide either way. But the problem in this case was further complicated by the fact that Clementia, Louis's second wife, was expecting a child to be born five months after her husband's death. Until this event took place nothing could be settled, and during the necessary interregnum the regency was naturally intrusted to Philip, the elder brother of the late king. Meanwhile the interests of Jeanne were maintained by her maternal uncle, Eudes iv. of Burgundy, with whom Philip concluded a treaty. This provided that if Clementia gave birth to a son he should succeed to the whole inheritance,

but if the posthumous child were a daughter, then Jeanne was to have Navarre, Champagne, and Brie until she was of marriageable age, when she was to choose whether to renounce the crown of France or to demand a formal consideration of her claims.

In November, 1316, Louis x.'s widow gave birth to a son, who is reckoned in the list of French kings as John I. The so-called child was born on a Sunday, and died on the following Friday. Thus the claims of Jeanne were left in full force, but they were seriously prejudiced by the fact that during the previous five months her uncle had obtained a firm hold of the reins of government, which he was by no means prepared to resign. The Duke of Burgundy was bribed to abandon the cause of Jeanne by a marriage with Philip's daughter, and by the gift of Franche-Comté and 500,000 crowns as his bride's dowry. The French lawyers, sharing the general prejudice against female rule, which resulted from so long a period of male succession, hunted out a clause in the laws of the Salian Franks which forbade the inheritance by women of *terra Salica*. This clause they arbitrarily applied to the crown, and thus coined the famous expression, the Salic Law. But it must never be forgotten that the exclusion of women from the throne of France rests, not upon any ancient rule, but upon the precedent of Jeanne's exclusion in 1316, followed and confirmed by further exclusions in 1322 and 1328.

Once securely established on the throne, Philip v. showed himself a resolute and able ruler. The reaction in favour of feudal independence was checked; the lawyers recovered their ascendancy in the royal counsels; and the administrative machinery of Philip iv. was once more set in working order. Numerous assemblies were held, in which the third estate was fully represented; and a vigorous attempt was made to improve trade, and to check provincial isolation by establishing uniformity in coinage, weights, and measures. But Philip did not live long enough to carry out

designs which, if successful, might have given him a place among the great administrators of France. He died in 1322 leaving only daughters, and his brother Charles IV. Charles IV., 1322-28. had little difficulty in seizing, not only the throne, but also Navarre, Champagne, and Brie, which ought to have been left in the hands of Jeanne. The reign of Charles is of little importance except in connection with England, where Edward II. was deposed and murdered by a conspiracy headed by his faithless wife and Charles's sister, Isabella of France. To his nephew, the young Edward III., Charles handed over Guienne, but retained the district of Agen, to be the source of future disputes. With Charles IV.'s death (January 31, 1328) the main line of the House of Capet came to an end. There was still one doubt as to the rule or custom of succession. That women could not themselves hold the crown had been settled by three successive precedents within twelve years. But could they transmit a claim to their male descendants? There were in 1328 two possible claimants on this ground—Philip, the son of Eudes IV. of Burgundy by a daughter of Philip V., and Edward III. of England, whose mother was a sister of the three last kings. But France was not likely to adopt a rule of succession which might at any moment give the crown to a foreign prince. And so the crown passed to the nearest male heir, Philip of Valois.

CHAPTER IV

FRANCE UNDER THE EARLY VALOIS, 1328-1380

The accession of Philip of Valois—His relations with Navarre and England—Robert of Artois—Philip's action in Gascony, Scotland, and Flanders brings on War with England—Edward III. and Jacob van Artevelde—Edward III. claims the French Crown—Beginning of the Hundred Years' War—English Expedition into Picardy—The succession in Brittany followed by a war—The Murder of Artevelde—The battle of Crecy and siege of Calais—Annexation of Dauphiné to France—Accession of King John and renewal of the war with England—Battle of Poitiers—Etienne Marcel and the States-General of 1355 and 1357—The Ordinance of March 3, 1357—Anarchy in France—The Murder of the Marsha'—Royalist reaction—The Jacquerie—The Murder of Marcel and the capture of Paris—English Invasion of 1359 followed by the Treaty of Bretigni—The succession to Burgundy—Charles v.'s Government—Success of his policy in Brittany and Spain—The reconquest of the English Provinces—Last years of Charles v.—Du Guesclin and de Clisson.

THE first result of the accession of Philip VI. was the severance of the crowns of France and Navarre, which had been united since the marriage of Philip the Fair (see p. 48). Navarre was now given up to Jeanne, the daughter of Louis X., and her husband, Philip of Evreux. In return Jeanne abandoned all other claims, either to the French crown or to the provinces of Champagne and Brie. By this bargain Philip secured his throne against one possible claimant, and confirmed the exclusion of female succession in France. Another rival, Edward III. of England, who could contend that females might transmit a claim to a male heir, was not at the moment very formidable. He was very young, he had obtained the throne through his father's

Accession of Philip of Valois, 1328.

deposition in 1327, and for the time he was under the tutelage of his mother Isabella and her paramour Mortimer. So far from putting forward a claim to the French crown, Edward III. came over to Amiens in 1329, and recognised Philip VI. by doing homage to him for his inherited possessions in Aquitaine.

So confident was Philip in the strength of his position that he did not hesitate to provoke enemies both at home and abroad, and this recklessness ultimately led to a quarrel with England, and to the outbreak of a war which lasted more than a hundred years, and exercised the most decisive influence upon the development of both nations. Robert of Artois. Among the nobles who had contributed most to bring about Philip VI.'s accession was his brother-in-law, Robert of Artois. He was a grandson of Count Robert of Artois, who had fallen in the battle of Courtrai in 1302. In spite of the normal preference for male succession, the grandson had been excluded in favour of his aunt Matilda, whose daughter Jeanne had married Philip V. Robert had made several efforts to vindicate his claim to Artois, but without success. On the accession of Philip VI., however, he was confident of obtaining justice, and at once commenced a suit for the purpose of proving that the inheritance had been unlawfully withheld from him. Matilda and Jeanne came to Paris to defend their rights, and both of them died within a short interval of each other, not without strong suspicions of foul play. Their claims now passed to Margaret, the daughter of Jeanne and Philip V. Robert of Artois found himself accused, not only of employing poison to rid himself of his rivals, but also of forging documents in support of his claims, and of employing magic arts against the king himself. His supposed accomplices were tortured into some sort of confession, and Robert, finding that he had lost the royal favour on which he had reckoned, fled from the court. The suit was decided against him (1332), and he himself sentenced to banishment. He found a refuge in England, and in his

eagerness for revenge set himself to urge Edward III. to claim the French throne on the ground of his mother's descent from Philip IV.

Edward III. might have paid little attention to such obviously interested advice had not events elsewhere brought him into hostile relations with France. Philip VI. was suspected, with some justice, of desiring to imitate his uncle's policy in Gascony, and to bring that province directly under his rule. More serious still was his conduct in regard to Scotland. The treaty of Northampton in 1328, by which the independence of Scotland had been recognised, **War in Scotland.** had stipulated for the restoration of their lands to those nobles who had supported England in the war. Robert Bruce died in 1329 without carrying out this part of the treaty, and the nobles who ruled during the minority of his son David were not likely to give up possessions which had fallen into their own hands. The dispossessed nobles determined to maintain their own cause in arms, and a successful battle at Dupplin Moor enabled them to place Edward Balliol upon the Scottish throne. Edward III. had given no aid to this expedition, but now that the revolution was accomplished, he was willing to profit by it and to receive Edward Balliol's homage. But the partisans of David Bruce rallied from their first defeat and drove Balliol from the throne. Edward III. now led an army into Scotland, won the battle of Halidon Hill (1333), captured Berwick, and restored Balliol. The result was a renewal of the Scottish war, and the party of independence appealed for aid to France. Philip VI. did not hesitate to secure such a useful ally in case of future difficulties with England. French troops were despatched to Scotland, and the safety of the young Scottish king was secured by sending him to France. From this time may be dated the permanent alliance between France and Scotland, which was at once a grievance and a source of serious embarrassment to English rulers.

English and French troops were now fighting each other as

auxiliaries on Scottish soil, and it was obvious that the two countries must soon be involved in open strife. The final impulse was supplied by events in Flanders. In the fourteenth century Flanders was the most important trading and manufacturing country in western Europe. Flanders.

Ghent was the Manchester, and Bruges the Liverpool, of that day. In Bruges we are told that merchants from seventeen kingdoms had settled homes, while strangers journeyed thither from all parts of the known world. It was the great centre-point of mediæval commerce, where the products of north, south, and east were brought together and exchanged against each other. Still more important to the Flemings themselves and to their relations with England was the manufacture of wool. England produced the longest and finest wool, which was woven into cloth and worsted on the looms of Ghent and Ypres. With France, on the other hand, the relations of the Flemings were purely political. The Count of Flanders, who found his subjects very difficult to govern, was the vassal of the French king, and his authority could hardly be maintained without the aid of his suzerain. To the material interests of the Flemings France was almost wholly alien. France, as contrasted with the other states of Europe, was little affected by the commercial spirit of the age. While Edward III. and the Black Prince, who appear in the pages of Froissart as mirrors of chivalry, were yet sufficiently practical to encourage the industrial interests of their subjects, the Valois kings pursued a totally different policy. They crushed industry by excessive and ill-judged imposts. They maintained no police to give safety to the foreign merchant, and foreign wares were kept out of France by the insecurity of the roads and the heavy duties upon imports. This difference is paralleled by the difference in the military system of the two countries. The English king, supported by the growing wealth of his subjects, was able to leave the majority of his people at home, and to make war with a well-paid and equipped mercenary army. The King of France, after extort-

ing all he could wring from the pockets of his subjects, compelled them to serve in the old feudal array, and led them to be butchered by opponents who were numerically inferior, but had been trained to war, and were not distracted from the work before them by the sense that they were neglecting their material interests at home.

Philip VI. had been involved in a Flemish war at the very beginning of his reign. The citizens of West Flanders, headed by Bruges and Ypres, rose in revolt against their Count, Lewis, who appealed for aid to the French king. A feudal army was led to his assistance, and the citizens, weakened by the abstention of Ghent, were crushed at the battle of Cassel (1328). The Flemings had to suffer, not only for their unsuccessful rebellion, but also for their previous victory at Courtrai, which had now been so ruinously reversed. Their leaders were mercilessly hunted to death, the town charters were confiscated, and their fortifications razed to the ground. The authority of the count was restored, but he was more than ever the dependent vassal of the French king. In 1336, at the command of Philip VI., he ordered the imprisonment of all Englishmen in Flanders. Edward III. promptly retaliated by prohibiting the exportation of English wool and the import of foreign cloth. Flemish artisans were induced to emigrate to England, and to lay the foundations of a prosperous woollen manufacture in Norfolk.

These events, which may be taken as the actual origin of the hundred years' war, illustrate the folly and recklessness of Philip VI. So far his quarrel with Edward III. in Aquitaine and in Scotland had been a personal quarrel; and the English people, though reluctant to lose the profitable trade with Bordeaux, were by no means enthusiastic either for the continental dominions of their king, or even for the establishment of his suzerainty over Scotland. But to strike at English trade with Flanders was to inflict a mortal blow at the most sensitive of English interests. From this time the quarrel with France became a national as well

**Alliance of
England with
the Flemings.**

as a royal quarrel, and Edward could count upon the unanimous support of his subjects. Still more serious was the effect of Philip's action in Flanders. In the fourteenth century, as in the Napoleonic wars at the beginning of the nineteenth century, England had the stronger position in a trade dispute with the Continent. The Flemish market was important to England, but English wool was indispensable to Flanders. The reprisals of Edward III., forced upon him by the action of the French king, threatened the Flemings with the ruin of their most important industry. A new rising, more formidable than that of 1328, was at once planned. Ghent, which had then held aloof, was now prepared to play its part; and in Ghent arose a leader, Jacob van Artevelde, whose eloquence and decision made him for a time practically omnipotent, while his guidance gave to the movement a unity and consistency which previous rebellions had too often lacked. His avowed object was to restore the supply of wool to the Flemish looms, and for this purpose to establish friendly relations with England. He assembled at Ghent the men of the chief cities, and 'showed them that they could not live without the King of England; for all Flanders was supported by cloth-making, and without wool one could not make cloth; therefore he urged them to keep the English king their friend.' At the same time he was anxious to avoid any needless infraction of feudal law, and therefore suggested that Edward should claim the French crown, pointing out that the Flemings could not lawfully serve the King of England against the King of France, but that they could serve the lawful King of France against the usurper.

Edward III. saw that war was inevitable; and the arguments of Artevelde convinced him, if any conviction were needed, that by putting forward a claim to the crown he would gain powerful supporters, and in the end more substantial advantages. In 1337 he published his claim before a parliament, and set to work to form continental alliances. The Emperor, Lewis

Edward III
claims the
French
crown.

the Bavarian, indignant at Philip's dictation to the Pope, Benedict XII., was willing to support the English king. In September, 1338, he met Edward at Coblenz, and formally invested him with the office of imperial vicar in the provinces on the left bank of the Rhine. The Duke of Brabant and several other princes of the Netherlands were persuaded or bribed to promise contingents to the English army. Edward's position seemed to be of overwhelming strength. He could attack France on both sides, from Flanders and Artois on the north-east, and from Guienne and Gascony on the south-west.

But the English successes were by no means so great as had been confidently expected. Edward's first expedition into Picardy in 1339 was a complete failure. Opening of hostilities. Emperor, vacillating as ever, would give no effective aid, the Flemings were content with the recovery of the wool supply, and it was only the sluggishness of Philip VI. which enabled the English forces to retire without serious loss. In 1340 the enterprise was renewed. A French and Genoese fleet had been collected off Sluys to dispute the landing. The Genoese commander refused to fight in a position which made it impossible to manœuvre, and left the French vessels to be utterly destroyed in the first important encounter of the war. But this naval victory was the solitary triumph of the campaign. Although the Flemings, under the influence of Artevelde, gave more active assistance than in the previous year, Edward was repulsed from the walls of St. Omer and Tournai. In September he concluded a truce for nine months with Philip VI. The only gainers by the war were the Flemings, who had practically abrogated the authority of their count, and had organised an independent federation of communes.

It seemed for the moment as if the war might collapse altogether in 1340. Edward's allies had either deserted him or were obviously lukewarm in his cause. He had spent vast sums of money without having any substantial result to show

for it. His subjects were discontented, and Edward chose this moment for a violent quarrel with his chief minister, Archbishop Stratford, who was backed up by the English parliament. But the dwindling flames of the war were re-kindled into a blaze by a quarrel about the suc-
 cession in Brittany. Duke John III. died in 1340, leaving no children. Of his two brothers, the elder was dead, but had left a daughter, Jeanne, who was married to Charles of Blois, a nephew of Philip VI. The younger brother was John de Montfort, who claimed the vacant duchy as the nearest male heir. The Count of Blois appealed, on behalf of his wife, to the Parliament of Paris, and that court decided in her favour. The result was a civil war between the French and the Celtic population of Brittany, the Celts supporting de Montfort and rejecting the rule of Charles of Blois as an alien. Philip VI. determined to support the cause of his nephew and the decision of his parliament. De Montfort crossed over to England and recognised Edward III. by doing homage to him for Brittany. Thus in the case of Brittany, as in that of Artois, the two kings were committed to principles which ran counter to their own claims. The French king, who owed his crown to the so-called Salic law,¹ appeared as the champion of female succession; while Edward III., who claimed to be King of France through his mother, contended for the exclusive right of the male heir.

The war in Brittany offered to Edward III. 'the finest possible entry for the conquest of the kingdom of France,' but his intervention served rather to prolong than to decide the struggle. Charles of Blois, with the aid of John of Normandy, the heir to the French crown, began by gaining important successes. Nantes was captured, and John de Montfort sent prisoner to Paris. But the heroic Countess of Montfort, a sister of the Count of Flanders, supported her husband's cause with masculine energy and courage, and the arrival of English succour restored the

Succession
quarrel in
Brittany.

War in
Brittany.

¹ See above, p. 64.

balance of forces in Brittany. But Edward III. still found himself confronted by superior numbers, and in 1343 papal mediation succeeded in arranging a general truce for three years. The truce, however, was not allowed to run its full term. John de Montfort escaped from his prison, and the severity with which Philip VI. punished some nobles in Brittany and Normandy for suspected treason led to a renewal of hostilities in 1345. Edward III. determined to make greater efforts than ever, and to attack France on three sides—from Guienne, Brittany, and Flanders. In Guienne Henry of Lancaster gained a considerable victory at Aube-roche, and captured several fortresses which were held by the French. In Brittany John de Montfort died, leaving his claims to his son, and his death prevented any important operations from being undertaken. Meanwhile Edward himself prepared to co-operate with the Flemings on the north-east. But his plans were interrupted by what appeared to be a great disaster to his cause. **Murder of Artevelde.** Jacob van Artevelde had incurred the distrust of his fellow-citizens. He had found it increasingly difficult to reconcile the jarring pretensions of the rival cities, or to compose the jealous divisions of the fullers and weavers of Ghent. In his alliance with England he had gone further than the majority of the Flemings desired. They would have been content to impose conditions upon their count, whereas Artevelde had schemed to depose him altogether, and to transfer the direct government of Flanders to the Prince of Wales. But the final accusation against the once popular leader was that he had placed the great treasure of Flanders at the disposal of the English king. In a rising of the infuriated mob, Artevelde's house was stormed and he himself slain. For the moment Edward feared that he might lose his hold upon Flanders. But Artevelde's policy survived him. The Flemings were not prepared to make unconditional submission to their count, and to extort conditions the alliance with England must be maintained. They hastened to excuse their conduct to the

English king, and to assure him of the continuance of their support. But Edward had received the news of another loss, which checked his advance in 1345. This was the death of his brother-in-law, William IV. of Holland, Hainault, and Zealand. As he left no children, his territories were seized by Lewis the Bavarian and conferred upon one of his younger sons (see p. 108). The Emperor had already deserted the English alliance, and the establishment of the House of Wittelsbach in the dominions of William IV. broke up the coalition which Edward III. had formed on the borders of France.

These checks induced Edward, not to relax his efforts, but to alter his plans. The military interest of 1346 seemed likely to be concentrated in the south-west. A large French ^{Campaign} army under Philip's eldest son, John of Normandy, ^{of 1346.} entered Guienne, recovered many of the places lost in the previous year, and besieged the inferior English troops in Aiguillon. Edward III. collected a large army at Southampton, and set sail on July 2. His intention was to land at Bordeaux, and march to the relief of Aiguillon. But his voyage was hindered by storms, and the advice of some of his French followers induced him to make for the coast of Normandy. The province was wholly unprepared for attack, and the English met with little resistance on their devastating march. Along the valley of the Seine they advanced as far as Poissi, where the flames of the burning houses were seen from the walls of Paris. Meanwhile, Philip VI. had strained every nerve to collect a second army for the defence of his capital. Among the allies who came to his aid were John of Bohemia and the newly elected King of the Romans, Charles IV. But Edward declined to assault Paris, or to face an army which was now larger than his own. Misleading Philip by a feint in the direction of Tours, he crossed the Seine at Poissi, and marched at full speed towards Picardy, in order to effect a junction with the Flemings. Philip followed with his enormous force, and the destruction of the bridges over the Somme seemed to shut the English in a

trap. But a captured peasant guided Edward to a comparatively unguarded ford at Blanche Taque, and the French arrived just as the last of the enemy had crossed. The battle, however, was only postponed, though the crossing of the river enabled Edward to choose his own ground, instead of fighting at a disadvantage with an impassable river behind him. To continue the retreat with an exhausted army pursued by superior numbers must have ended in disaster, and Edward drew up his troops at Crecy, near Abbeville, to try the hazard of the first pitched battle of the war. The result was to teach the world a lesson in the art of warfare which had only been imperfectly suggested by the battles of Stirling Bridge, Bannockburn, and Courtrai. It was a combat of infantry against cavalry, of missile weapons against heavy armour and lances, of trained professional soldiers against a combination of foreign mercenaries with disorderly feudal levies. And the inevitable result was made the more decisive by the utter want of generalship on the part of the French king. Obeying a momentary impulse of rage, he ordered his troops to engage when they were exhausted by a long march. The Genoese crossbows were wetted by rain, and their bolts fell harmless, while they were exposed to a hail of arrows from the English longbows. Then the men-at-arms charged over the unfortunate Genoese, and were already in disorder before they could reach the enemy. There was individual prowess in plenty, but no organisation or discipline, and the bravest of the assailants only rushed upon a certain fate. Philip fled in despair, but the King of Bohemia, the Counts of Flanders and Alençon, and many lesser princes and nobles, were left dead upon the field. Edward III. made no attempt to turn back upon France. It would have been difficult for him to feed his soldiers in a district which had been already swept bare by the requisitions and the pillage of two great armies. After allowing three days for rest and the burying of the dead, he continued his march northwards, and laid siege to Calais.

His victory had decisive results both in the west and the south. The siege of Aiguillon was raised, and the retirement of the Duke of Normandy left Guienne at the mercy of the English. Henry of Lancaster recovered the places lost at the beginning of the year, and, entering Poitou, took and sacked Poitiers. In Brittany the French cause met with almost equal disasters. Charles of Blois was captured and carried a prisoner to England, and, though his wife continued the struggle, the party of de Montfort had for a time a secure predominance. To complete the list of failures, an attempted diversion by David of Scotland, who invaded England in the autumn of 1346, ended in the king's defeat and capture at the battle of Nevill's Cross.

Meanwhile Edward III. was engaged in the blockade of Calais, where Jean de Vienne held out with heroic obstinacy for nearly a whole year. The death of Lewis of Flanders at Crecy seemed to open the prospect of a reconciliation of the Flemings with France, and if this could have been effected, the siege would probably have ended in failure. The young Count, Lewis de Mâle, had done nothing to incur the enmity of his subjects, and they welcomed his return with enthusiasm. But in their treaty with Edward III. the Flemings had agreed that their new ruler should marry an English princess. This stipulation Lewis refused to fulfil, and when the citizens tried to coerce him, he escaped from subjects who had become his gaolers and returned to the French court. His departure left the Flemings bound to the English alliance, and to Philip VI.'s lavish offers of bribes they turned a deaf ear. The siege could only be raised by force, and Philip collected an army for that purpose. But when he approached he found the English too strongly entrenched, and retired without risking a battle. Thus deprived of all hope of succour from outside, the defenders were forced to accept Edward's terms, and to hand over the town, with six of the principal burghers, to his mercy. The burghers were spared on the entreaty of Queen Philippa, but

the whole population of Calais was expelled to make room for English settlers. Gradually, as Edward's wrath at the prolonged resistance died away, some of the original inhabitants were allowed to return, but the population of Calais continued to be preponderantly English during the two centuries that it remained subject to England.

The fall of Calais was the last military disaster of Philip vi.'s reign. Both England and France were exhausted by the strain of the contest, and the outbreak of the terrible Black Death, which ravaged western Europe in 1348 and 1349, diverted men's minds from international quarrels. A truce, originally concluded for ten months, was prolonged by mutual consent for several years. Philip concluded his reign in

Dauphiné
annexed to
France.

peace, and before his death (August 22, 1350) he was able to add an important province to France, and thus to gain some consolation for the losses of the English war. Among the largest fragments of the old kingdoms of Arles was Dauphiné, ruled as a fief of the Empire by the Dauphins of Vienne. The last of these princes, Humbert, had supported Lewis the Bavarian in his struggles against France and the Avignon Popes. But like so many of the Emperor's allies, he was alienated by Lewis's weakness and selfishness, and pecuniary troubles forced him to change his policy and to draw closer to France. In 1343 he concluded a treaty with Philip vi. by which Dauphiné, in default of lawful issue to himself, was to fall to a younger son of the French king. In the next year this treaty was modified to secure the inheritance to the heirs to the French crown; and finally in 1349 Humbert's life-interest in the province was bought out by payment of a large sum, and Dauphiné was handed over to the House of Valois, and in the course of the next generation became the regular appanage of the eldest son of the reigning king. About the same time, France acquired another advantage on the side of Flanders. In 1348 Lewis de Mâle recovered his county, and by encouraging internal quarrels among his subjects, he not only evaded the

hated obligation of an English marriage, but also restored some measure of authority over the turbulent Flemings. As long as his power could be maintained, it might be hoped that France would escape the dangers of Flemish co-operation with the English.

John the Good, as he is called by the caprice of historical nomenclature, was no better a ruler than his father, and was even more unfortunate. He had already been active both in military and civil affairs, but had profited little by his experience. War, in his eyes, was nothing but a tournament on a large scale. Of orderly finance he had no conception; and as to the welfare of his subjects he had neither interest nor insight. He was a reckless spendthrift, imbued with the chivalrous ideals of the day, and subject to sudden gusts of passion, alternating with fitful and uncalculating acts of generosity. His accession marks the appearance on the scene of a new generation of actors. The Black Death had been most fatal to the lower classes, but it had by no means spared those of higher rank. In a single year John had lost his mother, Jeanne of Burgundy; his first wife, the sister of Charles iv.; his uncle Eudes iv., who had added Franche-Comté to the duchy of Burgundy, and now left both Burgundies to an infant grandson, Philip de Rouvre; and his cousin, Jeanne of Navarre, whose kingdom and possessions in France passed to her son, deservedly known in history as Charles the Bad, and destined to be the evil genius of France in the hour of her worst misfortunes. In England there had been a similar clearance of prominent personages. Edward iii. still lived, but he played little further part in the French war, where his place was taken by the Black Prince.

The truce with England expired in 1351, but for some years the revived hostilities were only local and unimportant. So great was the mutual exhaustion of the two states, that the new Pope, Innocent vi., elected in 1352, almost succeeded in negotiating a general peace. But, as before, it was internal

disturbances in France which led to a renewal of the war. Charles of Navarre had been invested with the county of Evreux and with the large possessions of his mother in Normandy and the Ile-de-France. He had also received in 1352 the hand of the king's daughter, Jeanne. But his ambition was still unsatisfied, and John took no further pains to conciliate a prince who could advance claims to Champagne and Brie, and might, under favourable circumstances, become a rival candidate for the crown. In 1354 the king's favourite, Charles of Spain, was assassinated by the emissaries of the King of Navarre. John was induced to pardon his son-in-law; but the reconciliation was only hollow, and Charles was impelled by real or imaginary grievances to open negotiations with Edward III. The English king could not resist the temptation of invading France with the aid of so powerful an ally, and prepared to enter Normandy through Calais in 1355. This danger compelled John once more to make overtures to his rebellious son-in-law, and Edward found himself deprived of the promised aid. He landed at Calais, ravaged the neighbouring districts, and then withdrew to repel a Scottish invasion. The Black Prince was more successful. Starting from Bordeaux, he marched through Languedoc, treating that province as Edward III. had treated Normandy in 1346. But the French king was as reckless as ever. Early in 1356 he surprised Charles of Navarre as he was banqueting with the Dauphin at Rouen, put his chief supporters to death, and carried the king a prisoner to Paris. The result of this violent act was to excite general disaffection. Charles's brother, Philip of Navarre, promptly took up arms, and appealed for English support. The Black Prince was not slow to respond. His plan was to march northward through the most fertile districts of France, cross the Loire, and advance through Maine to join the rebels in Normandy. But his force was insufficient for such an enterprise. John hastily collected an army, the Loire valley was blocked, and Prince Edward had to retire before vastly superior numbers.

**Renewed war
with the
English.**

John hurried eagerly in pursuit, and actually reached Poitiers before the enemy. A battle was now inevitable. So hopeless were the odds that the Black Prince was willing to accept any honourable terms, but John declined to let the enemy escape. All the advantages, however, of superior numbers were thrown away by the egregious folly of the French king. He sent a small detachment of men-at-arms to attack the English position on the hill, while he ordered the bulk of his army to dismount on the plain. The men-at-arms, who had to advance by a narrow lane under the arrows of the English archers, were speedily routed, and the English cavalry followed up this success by butchering the dismounted host, who could neither stand their charge nor fly. The king, after fighting bravely to the last, was taken prisoner with his youngest son Philip, and the flower of the French nobility either shared his captivity or escaped it only by death on the field. As at Crecy, the English made no attempt to profit by their victory. The Black Prince was content to carry his illustrious prisoner to Bordeaux, whence he subsequently despatched him to London.

The crushing defeat at Poitiers and the captivity of the king marked the climax of a long series of disasters, of which the cause was to be sought in the continued mal-administration of French kings and ministers. No country could be brought into such a plight as that to which France was reduced without giving rise to serious and dangerous discontent, and this discontent had already found expression before the campaign of 1356. From 1350 to 1355 frequent assemblies of local estates had been held for the raising of supplies, and these had not been voted without ominous grumbling and demands for redress of grievances. At last, in November 1355, King John had found it necessary to convoke the States-General of Languedoil, in order to deliberate on the best mode of resisting the national foes. The 'deputies of the three estates'—for nobles and clergy could only attend when

elected by their order—met in Paris on November 30. The orator of the third estate, in the formal reply to the chancellor's opening speech, was Etienne Marcel, provost of the merchants in Paris, and for the next four years one of the most important men in France. After deliberating on the matters submitted to them, the States drew up the great ordinance of December 28, 1355. They granted to the king a *gabelle* upon salt, and a tax of eight deniers the pound on the sale of all commodities. These were to be levied upon all classes—clergy, nobles, non-nobles, and even the members of the royal family. The collection of the taxes was to be superintended by delegates chosen by the estates, and the expenditure was to be controlled by a council of nine, three from each estate. Purveyance and the arbitrary alteration of the money-standard were forbidden. Finally, the dates were fixed for two subsequent sessions—one in March and the other in November of the next year.

It is obvious that the States-General acted, whether consciously or unconsciously, in imitation of the English Parliament, and took advantage of the financial difficulties of the crown to impose constitutional checks upon the royal power. But, unfortunately, the financial skill of the estates was by no means equal to the importance of their objects, or to their energy in striving after them. The *gabelle* on salt has in all ages been the most unpopular tax in France, and the tax upon sales breaks all the canons of taxation which modern economists have agreed to accept. Great disaffection was excited by the attempt to collect the tax, and in some provinces serious disturbances took place. When the States-General met in March they yielded at once to the expression of public opinion, repealed the obnoxious taxes, and imposed in their place an extraordinary income-tax, which was so adjusted that the percentage increased as the income diminished. After taking steps to control the collection and expenditure of the revenue, the estates adjourned till May 6. They then discovered that

Financial
blunders of
the States.

the amount raised was wholly insufficient to defray the necessary expenditure, and in their ignorance and perplexity they reimposed the unpopular taxes on salt and sales, and ordered the levy in June and August of two extra charges upon incomes.

After the battle of Poitiers matters seemed more hopeless than ever. The king's eldest son, Charles,¹ assumed the government on his father's imprisonment, but he displayed little of the wisdom or capacity for which he was afterwards renowned. His first act was to convene the States-General on October 17. The assembly was unusually large, the third estate being represented by exceptional numbers. Of the nobles, however, the attendance was very small. Large numbers of them had perished at Poitiers, and the survivors were discredited. Thus the balance of classes, so necessary for the success of constitutional changes, was overthrown. The third estate became preponderant in the assembly, and its leader, Marcel, obtained considerable support from the clergy through his ally Robert Lecoq, Bishop of Laon. The demands of the estates were far more extreme than those of the earlier assemblies. They were no longer content to impose checks upon the government, but determined to take it into their own hands. The royal ministers were to be dismissed, and thirty-six delegates—twelve from each estate—were to be appointed to manage the affairs of the kingdom. At the same time, outspoken complaints were made of the failure to carry out promised reforms, especially in the matter of the coinage, and the release of the King of Navarre was demanded. But the Dauphin, encouraged by the grant of a considerable subsidy from the estates of Languedoc, was not prepared to hand over his authority to the States-General. He prorogued the assembly, endeavoured to raise money

States-
General of
Oct. 1356.

¹ Charles had been created by his father Duke of Normandy as well as Dauphin of Vienne. It is shorter and simpler to call him the Dauphin, though to contemporaries he was known by his higher title.

from the provincial estates, and even ventured on a new debasement of the currency. The reforming party was driven by this obstinacy to revolutionary methods. The mob rose in Paris, and Marcel ordered the royal officials to cease minting the inferior coins. The Dauphin, who had gone to Metz to demand the mediation of Charles IV. with England, returned to find his capital in open revolt. Unable to resist the popular demands, he was forced to hold a new meeting of the States-General on February 5, and to accept the ordinance of March 3, 1357, which they drew up of March 3, 1357. In this the policy which had been proposed in the earlier session was carried out, and the royal power was subordinated to that of the States. The commission of thirty-six was definitely appointed to superintend every branch of the administration. An aid was granted for the maintenance of 3000 men-at-arms, but it was to be collected and spent, not by royal officials, but by nominees of the States. The predominance of the third estate is conspicuous in the articles directed against the nobles. They were forbidden to carry on private wars, and if they disregarded the prohibition, the local authorities or the people might arrest them and compel them to desist by fines or imprisonment. Not only was purveyance forbidden, but it was permitted to the people to assemble at the ringing of a bell, and to oppose its collectors by force.

King John, who was about to start from Bordeaux to London, sent a message to Paris to annul an ordinance which dealt so shrewd a blow at the royal authority. But the Parisians were not prepared to submit to a distant and captive king, the Dauphin was forced to promulgate the ordinance, and the revolution in the government of France was completed. The thirty-six showed their power by purging the royal council and the magistracy of all who were suspected of hostility to the popular party. But any hopes that the change of rulers would bring prosperity to France were doomed to disappointment. The revolutionary government was no more successful than that which it had

**Anarchy in
France.**

superseded. The provinces were not prepared to submit to the dictation of Paris, and their discontent encouraged the Dauphin to wait for an opportunity of recovering power. The nobles became more and more indignant at the predominance of the bourgeois. The English, still exulting in their triumph of the previous year, were content to accept a truce for two years; but the mercenary troops, deprived of their legitimate occupation, wandered about the country pillaging or levying blackmail on the people. Conscious that their position was insecure, and that the Dauphin might at any moment become actively hostile, Marcel and his associates endeavoured to secure a powerful ally by releasing Charles of Navarre (November, 1357). The only result was to kindle a civil war. The Dauphin had been compelled to promise the restoration of all his cousin's possessions, but his lieutenants would not give up the strong places, and Charles the Bad took up arms. For the moment he was the ally of the bourgeois, but he had no real sympathy with the cause of reform, and sought to fish in troubled waters for his own gain. The disasters of the ruling dynasty seemed to offer him a fair chance of establishing a right to the throne. In his speeches to the people he was careful to point out that his own claim was much stronger than that of Edward III.

As the reforming movement became weaker and more discredited, it began to adopt more violent and revolutionary methods. The career of Marcel is marked by **Murder of** increasing narrowness and selfishness. He had **the marshal** begun by advocating measures for the regeneration of France, then he had become the champion of the third estate; within that estate he was driven to maintain the preponderance of Paris and its mob; and at last he had to fight in Paris for his own personal ascendancy. At the beginning of 1358 his adherents adopted as their ensign a red and blue cap. The Dauphin was raising an army against the King of Navarre, and had recalled many of his former ministers. A new exhibition of mob violence was necessary to intimidate him

into submission. Marcel forced his way into the Louvre, where the marshals of Normandy and Champagne were murdered in their master's presence. The unfortunate prince fell on his knees to beg for his own life, and had to submit to the indignity of wearing the parti-coloured cap, which was placed on his head by Marcel himself. For the moment this deplorable act seemed to have achieved its end. The Dauphin was cowed into submission; his unpopular advisers were dismissed, and Charles of Navarre was admitted to Paris and formally reconciled with his cousin.

But the murder of the marshals was really as impolitic as it was criminal. The open dictation of the mob, and the failure of the bourgeois government to remedy the misfortunes of France, provoked a violent reaction in favour of the monarchy which had been so insultingly defied. With fatal self-confidence Marcel allowed the Dauphin, who now assumed the title of regent, to leave Paris and to throw himself upon the loyalty of the provinces. Charles summoned the States-General to meet in May 1358, at Compiègne instead of in Paris. The meeting was not very numerous, but it expressed the prevalent sentiment of France in favour of royalty. Marcel endeavoured to strengthen himself by forming a league of towns for the maintenance of common interests, but it was only joined by the towns in the immediate neighbourhood of Paris. Civil war was inevitable, and the new fortifications which Marcel had built to protect the capital against English attack were now to be employed for the defence of the citizens against their fellow-countrymen.

At this critical moment the evils of France were suddenly multiplied by the rising of a class for which neither king, nobles, nor citizens had done anything. The serfs or villeins of France had suffered terrible hardships within the last decade. Their numbers had been decimated by the Black Death, and the survivors had to add to their own tasks the work of those who had perished. Their hard-won savings had been wrung from them to pay

the ransom of their lords, who had fallen into the hands of the English at Poitiers or elsewhere. The lands from which they extracted a scanty living were devastated by the mercenary soldiers in peace as well as in war. Despairing of redress, they determined, at any rate, to avenge their sufferings. The story of their revolt is one of almost unredeemed horror. It began in the district of Beauvais, and rapidly spread over Champagne, Picardy, and the Ile-de-France. Castles were burned; men, women, and even children were tortured and put to death. But the nobles soon recovered from the first panic, and took arms against enemies whom they now loathed as much as they had previously despised them. The ill-armed peasants were unable to face the trained men-at-arms, and the suppression of the revolt was as murderous and destructive as its outbreak.

There was little real sympathy between peasants and bourgeois. They had, it is true, a common enemy in the nobles, and Marcel had tried to use the Jacquerie as a diversion in his own favour. But he gave no efficient aid to his allies, and his half-hearted connection only brought upon himself the discredit and disaster of their ruinous defeat. From the victorious troops of the nobles the regent was able to form an army for the reduction of his rebellious capital. The citizens were bellicose, but they were not warlike, ^{Siege} and it was necessary to bring trained troops to ^{of Paris.} the aid of their undisciplined valour. Charles of Navarre was appointed captain-general of Paris, and brought a mercenary army for its defence. But his aims were as purely selfish as ever. While professing to defend the city he was negotiating with the regent for its surrender. Such proceedings excited serious mistrust, which was increased by quarrels between the citizens and the soldiers of Navarre. At last Charles left Paris for St. Denis, and further resistance seemed almost hopeless. The citizens were willing to make terms, but the Dauphin would not negotiate with the murderer of the marshals. Marcel felt that in such a dilemma he could

no longer trust his followers. A party was already formed within the city which was hostile to his continued ascendancy, and in favour of restoring the royal authority. If the citizens had to choose between their own safety and the interests of their provost, their choice could not be long delayed. There was only one apparent means of escape, and **Murder of Marcel.** Marcel clutched at it. He offered to surrender Paris to Charles of Navarre, and to proclaim him King of France. But on the very night when this treacherous design was to be carried out, Marcel was assassinated by one of his own followers (July 31, 1358). It is easy to see and condemn the errors of his later career, but his name will always be memorable in French history as the leader of the most notable attempt, before 1789, to give to France a constitutional form of government.

Two days after the death of Marcel the regent Charles entered Paris, and the restoration of the royal authority was signalled by the severe punishment of its chief opponents. In the next year Charles bought off the King of Navarre, who had lost all hopes of gaining the crown with the collapse of the bourgeois revolution. There still remained the war with England. During the truce John had been negotiating for his release, and in 1359 he agreed to the cession of nearly the whole of northern and western France. But the Dauphin was of opinion that the mutilation of his inheritance was too high a price to pay for his father's liberty. He convened the States-General, now the docile instrument of the prince whose authority had been so recently defied by its predecessors. The so-called treaty of London was unanimously rejected, and Edward III. had no alternative but to renew the war. He collected an enormous army for the invasion of France in October, 1359. But the Dauphin had learned a lesson from experience, and would fight no more battles like Crecy and Poitiers. The English army advanced to Rheims, but found the city too strongly defended. An attack upon Burgundy was repelled, not by arms, but by

the payment of a large sum of money. Edward marched against Paris, but the Dauphin refused to quit the shelter of the walls, and the invaders had to turn westwards to Chartres. The country had been so desolated by war and pestilence that it was difficult to feed the army, the season was wet and unfavourable, and Edward III., finding that his army was wasting away without gaining any success, agreed to negotiate. By the treaty of Bretigni (May 8, 1360) he re-
Treaty of
Bretigni.
nounced his claims to the French throne and to the Norman and Plantagenet provinces north of the Loire. In return he was to enjoy full sovereignty, without any homage to the French king, in his own conquest of Calais, and in the possessions which Eleanor had brought to Henry II., viz. Guienne, Gascony, Poitou, Saintonge, and a number of smaller territories. France was to renounce the Scottish, and England the Flemish alliance. The ransom of King John was fixed at three million crowns, to be paid in six yearly instalments. On receipt of the first instalment the king was to be released, but hostages were to be given for the payment of the remainder. It was not easy to raise the ransom from exhausted France; but Galeazzo Visconti was opportunely willing to pay six hundred thousand gold florins to gain for his son the hand of a French princess, and this bargain with the Milanese despot enabled John to return to his kingdom. He seems, however, to have found the cares of government a disagreeable burden after the comparative gaiety of his imprisonment in London. In 1363 his second son, Louis of Anjou, escaped from Calais, whither he had gone as one of his father's hostages. John seized the opportunity to parade a chivalrous regard for his plighted word, and at the same time to abandon duties which had become difficult and distasteful. Leaving the regency once more to his eldest son, he sailed to England in January 1364, and died in London three months later. Before his departure he had done one act which is of cardinal importance in the history of France. In 1361 a return of the plague had carried off Philip de Rouvre, the childless

ruler of Burgundy, Franche-Comté, and Artois. The two latter provinces, which had come to Philip through the female line, passed to Margaret of Flanders, but the duchy of Burgundy escheated to the crown. A prudent king would have retained the direct rule of so valuable a possession; but John, with reckless generosity, gave it away to his fourth son Philip, who had fought boldly by his side at Poitiers, and had shared his captivity. This Philip the Bold is the founder of the great line of the Valois Dukes of Burgundy.

The new king, Charles v., had been the practical ruler of France since the battle of Poitiers. During those eight years he had learned from harsh experience many lessons which stood him in good stead when circumstances enabled him to gain some success. The very weakness of his bodily health, which contemporaries attributed to poison administered by Charles of Navarre during their early friendship, debarred him from the active exercises of chivalry, and impelled him to cultivate his mental faculties. Fragile, timid, a stranger to the joys of the tournament and the battle-field, he seems strangely out of place in the days of the Black Prince and Bertrand du Guesclin, of John Chandos and the Captal de Buch. Yet Charles v. is the greatest of the Valois kings before Louis xi., and must be reckoned among the founders of modern France. His chief task was to restore the despotic power of the crown, which had been so rudely shaken between 1355 and 1358. Arbitrary taxation was to supersede the grant of supplies by the estates; military and civil officials were to be royal nominees; even the local assessors and collectors of taxes were to be under the supervision and control of the crown. Only once did the States-General meet during the reign, and then they were summoned merely to strengthen the king's hands. But the despotism of Charles v. was a capable and orderly government, wholly different from that of his predecessors. It is curious to note how this absolute king adopts and turns to his own advantage the expedients of his enemies. He reimposed the *gabelle*

on salt, and the *aides* or taxes on the sale of commodities, the two financial expedients of the States of 1355. He retained the *élus*, the local collectors whom the States had nominated to levy these charges, though he was careful to take their appointment into his own hands. He gave tardy expression to the will of the estates by putting an end to the debasement of the currency, the worst of all grievances, and by imposing strict limitations on the right of purveyance. When his brother, Louis of Anjou, provoked discontent by his brutal administration in Languedoc, Charles did not hesitate to dismiss him from the governorship, and to grant redress to the complainants. Such a government was a great and a novel boon in the fourteenth century, and it is only on its financial side that it is open to hostile criticism. The expenses, both civil and military, were enormous, and the people were subjected to a heavier burden of taxation than they had ever experienced before. And the taxes were not only excessive in amount and arbitrary in their imposition, they were also oppressive and unequal. To increase the receipts from the *gabelle*, Charles v. introduced the practice of requiring every family to purchase at least a fixed amount of salt from the royal granaries; and the principle of equality, which is enjoined in his ordinances, was infringed by the frequent grant or sale of exemptions, sometimes to a class, sometimes to a district or a corporation. It is these exemptions, multiplied as time goes on, which make the financial system of France, down to the Revolution, so unjust, so disorderly, and so inefficient. And Charles v. was also responsible for a disastrous innovation. His predecessors had received a revenue from customs duties levied on the frontiers of their kingdom. Charles was the first to hamper domestic trade by imposing customs on the transit from one province to another.

But in spite of these drawbacks the administration of Charles v. was eminently successful, and it was this success which led his subjects to approve, or even to welcome, the

arbitrary character of his rule. A people which had suffered from every kind of misfortune, from foreign invasion, pestilence, and civil strife, as the French had done in the middle of the fourteenth century, is never very eager to limit the power of a capable ruler. What it needs is a government which will maintain order at home, and retrieve the national honour by victories over foreign foes ; and to such a government much will be forgiven. If the English had reason to approve the personal rule of the Tudor sovereigns, the French a century earlier had infinitely more reason to support a king who gratified their most imperious desires. For not only did Charles v. remedy the most glaring defects of his predecessors' administration, but this most unmilitary of kings was able to gain triumphs over the hated English which a few years before must have seemed impossible.

The first opportunity for an indirect renewal of the strife with England was offered by affairs in Brittany. The treaty of Bretigni had left unsettled the long struggle between John de Montfort and Charles of Blois, and England and France were not pledged to abandon the cause of their respective candidates. In the very year of his accession Charles v. determined to strike a vigorous blow in favour of the House of Blois, and sent Bertrand du Guesclin, whose military genius he had already detected, to lead a considerable force into Brittany. But this first enterprise was not crowned with success. The superior discipline of the English mercenaries enabled them to gain a decisive victory in the hard-fought battle of Aurai (September 29, 1364). Charles of Blois was slain, and Bertrand du Guesclin was left a prisoner in the hands of John Chandos. To prevent a complete transfer of the allegiance of Brittany to the English king Charles v. found it necessary to negotiate, and in April, 1365, John de Montfort was recognised as duke, with the proviso that if he died without male issue the duchy should pass to the eldest son of Charles of Blois.

More important in its ultimate results was French intervention in Castile. The government of Peter the Cruel had excited the bitter enmity of his subjects, who found a champion in the king's bastard half-brother, Henry of Trastamara. Henry appealed for aid to France, and Charles v. welcomed the opportunity to rid his country of the hated free companies. Bertrand du Guesclin, who had been ransomed from his captors, raised an army among these professional soldiers, and crossed the Pyrenees at the end of 1365. The task of the invaders was facilitated by a general revolt of the Castilians. Henry of Trastamara was crowned king, and Peter fled to Bordeaux to implore English assistance. The Black Prince was conscious that French ascendancy in the Spanish peninsula threatened his duchy of Aquitaine, and chivalrous motives impelled him to support a legitimate king against a usurper. Peter made the most lavish promises of pay to his auxiliaries, and the Black Prince became surety for the good faith of his guest. In 1367 all preparations were complete, and the treacherous Charles of Navarre gave a passage through his kingdom to the invaders. Between Najara and Navarrette, not far from the later battle-field of Vittoria, a complete victory was won over the French and Castilian forces. Du Guesclin was once more a captive, Peter the Cruel recovered his crown, and Henry of Trastamara had to seek safety in exile. But Peter proved to be as faithless as he was cruel. He declined to fulfil his promises to allies who seemed to be no longer necessary, and the English prince was in great straits to satisfy the soldiers who had trusted in his surety. To make matters worse the troops were wasted with disease, and the Black Prince himself contracted a fever which remained in his blood and led to his early death. With his temper embittered and his health broken, he led the remnants of his army back to Gascony. His departure was followed by a new revolution in Castile. Henry of Trastamara returned to reclaim the crown, and du Guesclin, whom the Black

Prince imprudently allowed to pay a second ransom, once more entered his service. In 1369 the French troops won the battle of Montiel, and in a personal interview which followed Peter was stabbed to the heart by his half-brother. Thus all the fruits of the battle of Najara were lost, and a king was seated in Castile who was pledged to the French alliance.

These events in Castile encouraged Charles v. to carry out a long-cherished design for the reconquest of the English provinces. A pretext for a rupture was found in the discontent which was excited in Aquitaine by the heavy taxes levied by the Black Prince to defray the expenses of his Spanish expedition. In 1368 several of the Gascon nobles, regardless of the treaty of Bretigni, appealed to Charles v., as their suzerain, to redress their grievances. Charles delayed a final rupture until he had made his preparations, and had heard of the triumph of his ally in Castile. In 1369 he summoned the Black Prince to appear in Paris to answer the complaints of his subjects before the court of peers. Edward replied grimly that he would willingly go to Paris, but with sixty thousand men in his company. It was easier, however, to utter the threat than to carry it out. The conditions which had enabled the English to gain some conspicuous successes in the earlier war were now altered, and to some extent reversed. The wise government of Charles v. had already removed many of the administrative evils which had crippled France under his grandfather and his father. Thanks to du Guesclin, the French king could now put into the field a professional army under capable leaders, in place of the disorderly feudal levies which had been cut to pieces at Crecy and Poitiers. The Black Prince was no longer the active and resolute commander that he had shown himself before his illness, and he lost some of his most capable lieutenants, notably Chandos, who died in 1370. The provinces ceded at Bretigni had had some years' experience of English rule, and their discontent was stimulated by a

growing sense of national sympathy with the rest of France. Another very prominent cause of the reversal of military success in the years following 1369 is to be found in the cautious tactics deliberately adopted and enforced by Charles v. himself. For an invading army victory is imperatively necessary; for the defenders it is enough not to be defeated. Charles forbade his generals, no matter what provocation they received, to risk an engagement in the open field. They were to shut their troops in the strong towns, and to leave the English armies to be wasted by disease, by want of provisions, and by the difficulty of coercing a ^{English} hostile population. As the invaders departed, the ^{disasters.} French could harass their march, cut off stragglers and supplies, and occupy the territory which the enemy was compelled to evacuate. These tactics were eminently successful, and they were immensely aided by the support of the Castilian fleet, which enabled the French to gain a temporary naval ascendancy. This deprived the English of direct communication with the coast of Aquitaine, and forced them to carry on military operations at a disastrous distance from their ultimate base of supplies. Almost the only English success was the capture of Limoges in 1370 by the Black Prince, who blackened his own reputation by ordering an indiscriminate massacre of the inhabitants. Soon afterwards he was compelled by illness to return to England, and to resign his duchy of Aquitaine, which he never revisited. In 1372 the English fleet, which was carrying an army under the Earl of Pembroke to Bordeaux, was destroyed off La Rochelle by the combined naval forces of France and Castile. A new and larger force was prepared in 1373 under John of Gaunt, but in consequence of this maritime disaster it was necessary to land the troops at Calais. Thence John of Gaunt marched right across France, but he found no enemy to beat in the field, and he could not take a single fortress. Meanwhile his troops melted away through desertion, disease, and famine. A defeated army could hardly have been in a more lament-

able condition than that of which a scanty and impoverished remnant succeeded in reaching Bordeaux. The failure of this great effort on the part of England was decisive. Already several provinces had been practically lost, and by 1374, of all the vast possessions which had been gained at Bretigni, there remained only Calais in the north, and the strip of land stretching from Bordeaux to Bayonne. In 1375 the Pope succeeded in negotiating a truce for two years, and before its expiry both the Black Prince and Edward III. had died, and England, bitterly chagrined at such complete and unexpected disasters, had passed under the rule of a child.

In 1378 hostilities were resumed, though the English wished to prolong the truce, and it seemed almost inevitable **Last years of Charles V.** that Charles V. would complete his task of expelling the foreigner from French soil. The English had no longer any allies in France. John de Montfort, who had clung to his old protectors ever since the outbreak of war in 1369, had been expelled from Brittany, which was now almost wholly occupied by royal troops. Charles of Navarre, who had been a traitor to both sides in turn, discovered his mistake in allowing the English power to be so completely depressed, and opened negotiations with John of Gaunt for a joint effort to recover the lost provinces. But between France and Castile the King of Navarre found himself powerless. The royal troops seized the strong places which he possessed in France, while the Castilians entered Navarre and laid siege to Pampeluna. Charles the Bad was deserted even by his own son, and was forced to make a humiliating peace in 1378. If the French forces had now been concentrated on the reduction of Bordeaux and Bayonne, and if the Castilian fleet had been employed to cut off reinforcements by sea, the English must have lost their last strongholds in Aquitaine. But Charles V. was tempted by his successes to undertake a more ambitious project—the annexation of the duchy of Brittany to the royal domain. Such a plan at once raised the whole of Brittany against him. The supporters of the

House of Blois, who had fought for the king against de Montfort, were resolute to defend the independence of their province. The great soldiers of France, Bertrand du Guesclin and Olivier de Clisson, were Bretons by birth, and though they obeyed the royal orders, their action in Brittany was reluctant and inefficient. The rebellion was wholly successful; John de Montfort was restored to his duchy, and was even welcomed by the widowed Countess of Blois, who had so long championed the cause of her husband against him. This failure in Brittany was a bitter disappointment to Charles v., and his chagrin was increased by the death of Bertrand du Guesclin. The king himself did not long survive his most brilliant and faithful servant, and at the time of his death (September 16, 1380), the English still possessed a foothold in the north and south of France, which enabled them to make disastrous use of the disorders of the next reign.

CHAPTER V

LEWIS THE BAVARIAN AND THE AVIGNON POPES, 1314-1347

Disputed election to the Empire—Quarrel between Lewis IV. and John XXII.—The Franciscans and the Pope—The Heresy of the Beatific Vision—National feeling in Germany—Causes of the failure of Lewis as Emperor—The Expedition of the Emperor to Italy—Lewis supports the Anti-Pope—His retirement from Italy—His position in 1338—The Succession question in the Tyrol—Election of Charles IV.—Death of Lewis.

THE death of the Emperor Henry VII. (1313) gave occasion for one of those disputed elections which were almost inevitable as long as there was no central power strong enough to control German factions, and as long as the rules or custom of election were uncertain and ill-defined. The Hapsburgs eagerly grasped at the opportunity of recovering the power they had lost by the death of Albert I. Their opponents, headed as before by Baldwin of Trier, passed over John of Bohemia on account of his youth, and put forward as their candidate Lewis, Duke of Upper Bavaria. The rival forces were not ill-balanced. On October 19, 1314, Frederick the Handsome, son of Albert I., was chosen at Sachsenhausen by the Archbishop of Köln, Henry of Carinthia, still claiming the crown of Bohemia (see p. 18), the Elector Palatine, and the Duke of Saxe-Wittenberg. On the following day five electors—the Archbishops of Mainz and Trier, John of Bohemia, Margrave Waldemar of Brandenburg, and the Duke of Saxe-Lauenburg—gave their votes at Frankfurt in favour of Lewis the Bavarian. Thus two votes—those of Saxony and Bohemia—were cast by rival claimants upon both sides. On November 25, a double coronation took

Disputed
election in
the Empire.

place: Frederick being crowned at Bonn, and Lewis at Aachen. The dispute could only be settled by arms; and a desultory war, lasting for seven years, was closed in 1322 by the battle of Mühldorf, where the capture of his rival seemed to secure the final victory of Lewis.

But the very completeness of Lewis's triumph only served to provoke a far more formidable enemy than the Hapsburg duke. As long as the war lasted in Germany, the Pope had been content to pursue his policy of strengthening the Guelt party in Italy, confident that his Ghibelline opponents could receive no assistance from beyond the Alps. Clement v., on hearing of the death of Henry VII., had seized the opportunity to claim the administration, and to grant the office of imperial vicar during the vacancy to his patron and ally, Robert of Naples. John XXII., who succeeded Clement in 1316, after an interregnum of over two years, continued his predecessor's policy. But Robert of Naples could only just hold his own against the Visconti and other Ghibelline leaders; and the battle of Mühldorf seemed likely to turn the scale decisively against the Guelfs. In his partisanship for the Angevin cause, John XXII. determined to revive the most extreme claims of the mediæval Papacy. On the pretext that he had the right to decide the disputed election, and that neither claimant could assume the imperial office without his sanction, he called upon Lewis to plead his cause before the Roman Curia (1323), and, when he failed to appear, pronounced him contumacious and finally proceeded to issue a bull of excommunication against him. Thus commenced a struggle between the Empire and Papacy which was continued under the pontificates of Benedict XII. (1334-1342) and Clement VI., and was hardly terminated by the death of Lewis in 1347.

Quarrel of
Lewis IV.
and John
XXII.

In many ways this struggle looks like a revival of past struggles between Emperors and Popes, and to raise the old questions as to the relations of Church and State. But if it

is examined a little closer, it will be found to differ in several important respects from its predecessors, and to present peculiarities peculiar characteristics of its own. In the first place, the dispute arises from more petty causes, and the combatants are of lesser mould than the protagonists of earlier times. There is no Hildebrand or Innocent III. among the Avignon Popes, and Lewis the Bavarian lacks both the courage and the imposing personality of Frederick Barbarossa or Frederick II. The pretensions of the rival powers are less far-reaching and exalted; and if at times we find the language of the past reproduced in the papal bulls, it sounds unreal and almost ridiculous. No more conclusive illustration of the decline of both Papacy and Empire can be presented than the impression of unreality and insignificance produced on the mind by the records of this long and obstinate contest.

Yet it is hardly probable that this impression was shared by contemporary spectators. To them the struggle must have seemed to involve questions of vital importance. No previous contest between the rival heads of Christendom had produced so much literature, or literature of such merit and significance. Michael of Cesena, the general of the Franciscan Order, John of Jandun, and William of Ockham, 'The Invincible Doctor,' exhausted the subtleties of the scholastic philosophy in their championship of the imperial position against papal pretensions. Above all, Marsiglio of Padua, in his great work the *Defensor Pacis*, examined with equal acuteness and insight the fundamental relations of the spiritual and secular powers, and laid down principles which were destined to find at any rate partial expression in the Reformation.¹

This outburst of literary and philosophical activity was due in great part to the fact that for the first time in the

¹ See on this subject Riezler, *Die Literarischen Widersacher der Päpste zur Zeit Ludwigs des Baiers*, and Creighton, *History of the Papacy during the Reformation*, i. pp. 35-41.

long strife between Papacy and Empire, the struggle involved doctrinal differences. Hitherto the contest had been between Church and State, and the Church had been for the most part united. But, on the present occasion, the Church was profoundly divided. The great Franciscan Order had been founded by the professed advocate of clerical poverty. In course of time this original principle had been departed from, and the Order had amassed considerable wealth, though it had been found desirable to conceal the change by making the Pope the trustee, and giving the Order the mere usufruct of its property. This lapse from the strictness of the original rules had given rise to a schism within the Order. The Spiritual Franciscans, or Fraticelli, maintained that Christ and the Apostles held no individual or corporate property, and that the Church was bound to copy the examples of its founders. This doctrine, which was accepted by a chapter of the Order in 1322, was not likely to find favour with a Pope who was accused, with good reason, of avarice. John XXII., urged on by the Dominicans, denounced the doctrine as heretical, and thereby alienated the Franciscans, who could plead in their favour a bull of Nicolas III., and appealed from the authority of the Pope to a General Council of the Church. In common hostility to John XXII., the Franciscans espoused the cause of Lewis the Bavarian, and it was among them that he found his most enthusiastic champions, and his most influential advisers.

The Franciscans and the Pope.

This antagonism of a section of the Church to its own head seemed likely to be increased in John XXII.'s later years, when he was induced to favour the dogma that the dead are not admitted to the divine presence until after the final day of judgment. This contention struck at the root of the prevalent custom of invoking the mediation of the saints, and provoked a storm of opposition throughout Europe. Even the French king threatened to abandon the cause of so heterodox a Pope,

Heresy of the Beatific Vision.

and on his death-bed John found it prudent or necessary to retract his too hasty opinion.

It is obvious that these doctrinal disputes weakened the Papacy, and so far tended to give the Emperor an advantage. But this gain to Lewis was as nothing compared with the strength which he derived from the most noteworthy peculiarity of the struggle. In all previous contests with the Empire, the Popes had been able to command the services of an anti-imperial party within Germany, and this party had included not only the great ecclesiastics, but many of the lay princes. But in the great critical moments of the struggle with Lewis, this was found to be impossible. For the first time in history the German ruler found himself backed up by a vigorous national sentiment among his subjects, a sentiment quite as strong as that which had supported Philip iv. of France against Boniface viii. The primary cause of this unwonted union among German princes and people was undoubtedly the residence at Avignon and the subservience of the Popes to France. The national revolt against a spiritual authority which allowed itself to become the tool of a hostile state, led in England to the issue of the great statutes of Provisors and Præmunire, and found equally resolute expression in Germany in the famous decrees of 1338. Benedict xii., more moderate and placable than his predecessor, had been on the verge of a reconciliation with the Emperor, but was actually forbidden to put an end to the quarrel by the imperious Philip vi. This open dictation on the part of the French king drove the Germans to fury. In July, 1338, all the electors with the exception of the King of Bohemia met at Rense on the Rhine, and formally resolved that the imperial authority proceeds directly from God, and that the prince who is legally chosen by the electors becomes king and emperor without any further ceremony or confirmation. This meeting is noteworthy in the constitutional history of Germany as the first occasion on which the electors assumed corporate

**National
sentiment
in Germany.**

functions other than the filling of a vacancy in the throne. In the following month, a numerously attended diet at Frankfort endorsed the declaration of Rense, and proceeded to draw up laws which should strengthen the central power. The punishment of death is decreed against all breakers of the public peace: the feudal tenant who takes arms against his imperial overlord is declared to forfeit both life and property: whoever refuses to take up arms at the summons of the Emperor is pronounced guilty of felony. The decrees of Frankfort seemed to promise a revival of the German monarchy.

In spite of all these advantages on the side of the Emperor, the quarrel ended, not exactly in a papal triumph, yet in the complete and humiliating discomfiture of Lewis. Causes of Lewis's failure. Doubtless the personal character of the Emperor contributed essentially to this result. Lewis was well-meaning but vacillating: he could take strenuous measures under the influence of a stronger will, but when he lost his adviser his habitual irresolution and his superstitious dread of the terrors of excommunication returned upon him. To carry through the contest he required the firmness, the intellectual craft, and the want of reverence of a Philip the Fair; and he had none of these qualities. On more than one critical occasion, when success seemed within his grasp, he alienated and disgusted his supporters by grovelling offers to purchase absolution by surrendering all the principles which were at stake in the quarrel. Moreover, the doctrinal disputes in which he became involved, although a source of weakness to the Pope, were not an equal source of strength to the Emperor. The Franciscans had many powerful opponents, especially in the great rival Order of St. Dominic, and these were alienated from the Emperor by his alliance with a faction in the Church. The Franciscan cause rested upon an unpractical enthusiasm which could not command the lasting support of the clergy, accustomed as they were to wealth and to the influence which it confers. And in the end, the strong

corporate spirit of the Church was inevitably aroused and alienated by the spectacle of a secular ruler interfering in questions of dogma, and claiming a right of interpretation and decision.

There was, too, in the Emperor's position a fundamental weakness which, unless detected and remedied, was inevitably fatal to his success. Neither Lewis nor the Franciscan advisers who in the early years of the struggle dictated his conduct, could realise that the conditions of the Middle Ages were passing away. They could not see that the old imperial pretensions were obsolete; that intervention in Italy had always brought ruin to German kings; that even in Italy the Guelfs had the stronger, because the less anti-national, position; and that the Ghibellines, the professed champions of imperial ascendancy, only pursued this policy for their own ends, and had no real desire to weaken their independence by the foundation of a strong Italian monarchy. Lewis had an almost unique opportunity of building up such a monarchy in Germany, not on the lines of the mediæval Empire, but on the basis of the newly awakened national sentiment and sympathy. This opportunity he threw away because he had no conception of the conditions under which alone such success could be attained. Instead of endeavouring to rule as an Edward I. or a Philip IV., he set himself to imitate the Ottos of the tenth century.

In 1325 Germany was astounded by the news that Lewis had been formally reconciled with his imprisoned rival. It is true that the treaty was not carried out, and Frederick, unable to fulfil his promises in face of the opposition of his brothers, returned to captivity. But in the following year the death of Leopold, the most resolute and active of the Hapsburg princes, removed all danger to Lewis from this quarter, and enabled him to follow the advice of his Franciscan counsellors and to take aggressive measures against the Pope. In 1327 the Emperor appeared at Trent, where he was welcomed by the Ghibelline leaders,

Lewis in
Italy.

eager to have his assistance against Robert of Naples. At Milan he received the iron crown of Lombardy, and thence, accompanied by Castruccio Castracani, Lord of Lucca, he set out for Rome. The Guelf cause seemed to be ruined in northern and central Italy, and the partisans of the Pope and Naples fled from the city. In January, 1328, Lewis was crowned Emperor by two bishops, whose chief qualification was that they shared with their patron the penalties of excommunication. Three months were spent in planning further proceedings, and in April John xxii. was formally declared uncanonically elected and guilty of heresy. In May, Peter di Corvara, a Franciscan friar, nominated by the Emperor and accepted by the acclamations of the citizens, assumed the papal title as Nicolas v.

This initiation of a schism in the interests of the Franciscan party marks the limit of the Emperor's success in Italy. He had committed himself to an enterprise which he had neither the moral nor the material force to carry through. His immediate enemy, Robert of Naples, had not yet been even attacked. When the imperial troops advanced southwards in June, they were speedily compelled to retreat, and Lewis thought it advisable to evacuate Rome and retire to the Ghibelline strongholds in the north. The Emperor was accompanied by his Antipope, and the Roman populace, with characteristic inconstancy, expelled the imperial partisans and opened their gates to the Orsini and the Neapolitan troops. To make matters worse, death carried off two of Lewis's chief advisers, Castruccio Castracani and Marsiglio of Padua. From this time his career in Italy was one long catalogue of blunders, and he eagerly seized the excuse for returning to Germany on the news of the death of his former rival, Frederick the Handsome (January, 1330). The unfortunate Nicolas v., deserted by his patron, was compelled to resign his dignity and to make the most humiliating submission to John xxii. He ended his life a prisoner in the palace of Avignon.

After such a complete and disastrous failure it might have been thought that the cause of Lewis was ruined, and that he too would have to submit to the triumphant Pope. But the open alliance of the Papacy with France, and the consequent alienation of Germany, enabled him to recover much of the lost ground, and by 1338 his position appeared **Position of Lewis in 1338** to be firmer than ever. At the head of a national movement, which had expressed its sentiments unmistakably in the decrees of Rense and Frankfort, and closely allied with Edward III. of England, who was now committed to his great war with France, Lewis seemed able to dictate his own terms both to Benedict XII. and Philip VI.

But Lewis was as incapable as ever of pursuing a resolute and consistent course of policy, and at the very moment when success seemed assured he began to vacillate and draw back. In 1340 he suddenly abandoned the English alliance and made terms with Philip VI., in the hope that the French king would use his influence to secure for him the papal absolution. Philip, delighted to be freed from a very pressing danger, did endeavour to intercede with the Pope, but even the gentle Benedict fired up at this attempt to command what the king had previously forbidden; and the Pope died in April 1342, without having granted the Emperor the pardon for which he craved. The Germans were naturally disgusted by Lewis's pusillanimity, but this feeling was as nothing compared to the storm of indignation excited by the Emperor's conduct in the question of Tyrol. The final cause of Lewis's failure is to be found in his reckless pursuit of that policy of family aggrandisement which had been almost forced upon the holders of the imperial dignity since the Great Interregnum. In his insatiable greed for territory, he did not hesitate to alienate the chief German princes at a time when their support was absolutely indispensable.

In 1335 Henry, Duke of Carinthia and Count of Tyrol, had died leaving an only daughter, Margaret Maultasch, who

was married to John Henry of Moravia, a son of King John of Bohemia. The claim of Margaret to succeed to her father's territories was contested by the dukes of Austria, whose father, Albert I., had married the sister of Henry of Carinthia. The struggle for the succession between the Houses of Hapsburg and Luxemburg ended in a partition, the Hapsburg dukes taking Carinthia, while Tyrol was ceded to their niece Margaret. But the marriage relations of Margaret and John

Succession
question in
Tyrol.

Henry proved extremely inharmonious, and in 1341 the former discarded her husband and threw herself upon the protection of the Emperor. The temptation to acquire a new province for his House was more than Lewis could resist. He had already in 1323, on the death of Waldemar of Brandenburg, conferred the vacant provinces and electorate on his eldest son Lewis. On the death of his cousins, the sons of Henry of Lower Bavaria, he had seized their land and had thus united the whole of Bavaria under his own rule. To these acquisitions he would now add the county of Tyrol. In reckless defiance of ecclesiastical prejudice, he usurped rights which had hitherto been exercised by the Church. By solemn decree he granted Margaret a divorce from her husband, and a dispensation to marry his own son, Lewis of Brandenburg.

The consequences of this reckless action might have been foreseen. The clergy were alienated by the assumption of clerical powers by a layman, while the lay princes, headed by John of Bohemia, were jealously indignant at such an addition to the already immense possessions of the Bavarian House. The new Pope, Clement VI., found himself at last in a position to raise an anti-imperial party in Germany, and to bring about the election of a rival king. But for the fact that Philip VI. was now engaged in the war with England, Clement, who was a thorough Frenchman, would probably have used all his influence to secure the election of the French king. As it

Election of
Charles IV.,
1346.

was, it was natural to find a candidate in the House of Luxemburg, which had most cause for exasperation with Lewis, and was also closely allied with France. John of Bohemia himself was disqualified by blindness, having lost his eyesight in a campaign against the heathen Wends of Prussia, but his eldest son, Charles, was put forward in his place. The only electors who supported Lewis were his own son, Lewis of Brandenburg, and the Archbishop of Mainz, Henry of Virneburg. The Pope, to secure another vote, deposed the archbishop, and awarded his see to Gerlach of Nassau. On June 11, 1346, the three Archbishops, with John of Bohemia and Rudolf of Saxony, formally elected Charles as king of the Romans. With characteristic quixotism the blind king, instead of asserting his son's title with arms, hurried the new king off to France to aid his ally, Philip VI. On the field of Crecy John of Bohemia fell in heroic despair, but Charles IV., whose share in the battle is wrapped in some obscurity, escaped to Germany to maintain his title.

Meanwhile Lewis had made the last great addition to the territories of his family. His second wife, Margaret, was a sister of William IV. of Holland and Hainault, and **Death of Lewis, 1347.** on the death of that prince in 1345 his possessions fell to William V., a son of Lewis by this second marriage. The House of Wittelsbach seemed for the moment so powerful that it need fear no rival, and the injudicious absence of the Luxemburg princes had enabled Lewis to strengthen himself still further by an alliance with Albert of Austria. Charles found his position almost hopeless. An attack upon Tyrol was repulsed, and he was forced to retire to Bohemia. Lewis, confident of an easy triumph, left the prosecution of the campaign to the Margrave of Brandenburg and returned to Bavaria, where he died suddenly on October 11, 1347, while engaged in a boar-hunt near Munich.

CHAPTER VI

CHARLES IV. AND THE GOLDEN BULL.

Charles IV. secures the German Crown—His rule in Bohemia—His coronation in Italy—Difficulties in Germany—The Golden Bull—The Papacy and the Golden Bull—The results of the Golden Bull—The intentions of Charles IV.—The Territorial Policy of Charles IV.—The Succession question in Upper Bavaria—The election and coronation of Wenzel—The Swabian League—The Great Schism—Death of Charles IV.—Partition of the Luxemburg territories.

WHEN Charles IV. returned from the campaign in France, which had cost his father's life, he seemed to have very little chance of gaining the imperial throne, to which he had been elected by the opponents of Lewis the Bavarian. It is true that Bohemia was rich in mineral wealth, but in territorial power the House of Luxemburg was no match for the House of Wittelsbach, whose various members ruled over the Palatinate, the whole of Bavaria, the marks of Brandenburg, Tyrol, and the border districts of Hainault, Holland, Zeeland, Friesland, and Utrecht. The second son of Lewis, Stephen, was head of the powerful Swabian League, and the imperial towns were all on the side of the Bavarian Emperor. The electors who had given Charles their votes were not prepared to make any sacrifices in his cause, and Albert of Austria, the most powerful of the non-electoral princes, was committed to the cause of Lewis. The chief ally to whom Charles might have looked for support was the French king; but Philip VI. was fully occupied in the war with Edward III., and was thus unable to take any part in the affairs of Germany.

And Charles had another great disadvantage in his relations

to the Papacy. In return for the support of Clement vi. he had made very extreme concessions in a treaty arranged at Avignon in April 1346. He had admitted that the imperial coronation must follow confirmation of the election by the Pope; he had promised that he would only go to Rome with the Pope's consent, and would only stay there a single day; the Pope was to be arbiter in the disputes between the Empire and France. It is true that this treaty had not been published: and it is also true that Lewis had more than once offered even greater concessions as the price of absolution. Still, it was patent to all that Charles was the Papal candidate; and the injudicious boast of Clement that he held the imperial throne in his gift was not likely to conciliate German princes and people who had so energetically protested against spiritual dictation from Avignon. The imperial cities refused to open their gates to the *Pfaffen-Kaiser*, or 'parson's emperor,' as they called him in derision.

While affairs were in this almost hopeless condition, three events occurred which greatly improved Charles's prospects.

**Charles
secures the
German
crown.**

The first was the sudden death of his rival, Lewis the Bavarian. Another was the outbreak in 1348 of the Great Plague or Black Death, which diverted men's attention from political disputes, and led them to look for the checking of anarchy and disorder to the prince who possessed at any rate the title of king. The third event was the appearance in Brandenburg of a pretender claiming to be Waldemar, the last margrave of the House of Ascania, who was supposed to have died in 1319, when the electorate had been conferred upon the eldest son of the late Emperor. The 'false Waldemar,' as he is called, declared that he had never died, but had been driven by the stings of conscience to undertake a prolonged pilgrimage, from which he now returned to claim his rights. In order to weaken his Wittelsbach opponent, Charles gave his countenance to the pretender, who speedily secured a large part of Brandenburg.

It was an additional advantage to Charles that the party of the late Emperor had great difficulty in finding a successor to put in his place. In 1348 four electors—Henry of Virneburg, who still held the see of Mainz in defiance of the papal authority, the Elector Palatine Rupert, Lewis of Brandenburg, and Eric of Saxe-Lauenburg, who claimed to exercise the electoral vote of Saxony—sent proxies to Ober-Lahnstein to proceed to a new election. The vacant crown was offered in the first place to Edward III. of England, who had indirectly rendered a service to the Bavarian party by preventing French aid being sent to Charles IV. But Edward could neither neglect the French war nor face the resolute opposition of the English Parliament. On his refusal, the crown was offered to Lewis of Brandenburg, who had enough to do to cope with the false Waldemar, and then to Frederick of Meissen, who declined to risk anything in a losing cause. At last, in despair, the electors chose Gunther of Schwartzburg, a military leader of some reputation, but below the highest princely rank. Gunther, who had little to lose and everything to gain, accepted the proffered dignity, but he died in 1349, before he had time to test his ability to hold it.

Charles IV. set himself, with rare diplomatic ability, to make the most of his own advantages and of the difficulties of his opponents. The imperial cities, discontented by the death of their patron, Lewis the Bavarian, and involved in difficulties and disorders by the Plague, were gained over by the concession of privileges, and one by one opened their gates to Charles. Albert of Austria was detached from the Wittelsbach alliance by a politic marriage between his eldest son Rudolf and Charles's second daughter Catharine. Charles, himself a widower, sued for the hand of a daughter of the Elector Palatine, and thus gained to his side the head of the House of Wittelsbach. Finally, by disowning the cause of the false Waldemar, he achieved the reconciliation of his most resolute opponent, Lewis of Brandenburg. The death

of Gunther of Schwartzburg removed all difficulties in the way of Charles's recognition, and by 1350 his title was acknowledged throughout the whole of Germany.

Charles IV. is incontestably the greatest ruler whom Europe produced in the fourteenth century, yet his merits have met with singularly little appreciation except from Bohemian historians. To most English readers he is chiefly known from the saying of Maximilian I. that he was 'the father of Bohemia but the stepfather of the Empire,' or by the more recent epigram of Mr. Bryce who says that 'he legalised anarchy and called it a constitution.' Of the two sayings, the latter is by far the more unjust and ill-founded. Charles is a unique figure in the family of Luxemburg which rose to such sudden and short-lived eminence in the fourteenth century. His grandfather, Henry VII., threw away his life in a chimerical effort to revive an imperial authority which was no longer either possible or desirable. His father, John of Bohemia, was the representative knight-errant of his time, perhaps the noblest type of fourteenth century chivalry—now crusading in Poland, now trying to found a new territorial power in Italy, and in the end deserting his own interests to fight and fall in the service of an ally. Of Charles's sons, the eldest, Wenzel, was a good-natured hedonist, who had few desires beyond the pleasures of the table; and the second, Sigismund, was a schemer who always imagined more than he could achieve. In the midst of this remarkable family, which can boast of three emperors and a king who twice narrowly missed election to the same dignity, Charles IV. stands in complete contrast both to his predecessors and his successors. He had none of the romantic enthusiasm of his father or his grandfather, but he had what was far better—a strong sense of the practical duties of government, and a strenuous business capacity which enabled him to carry them out. It is true that he failed to maintain the Ghibelline cause in Italy, but he preferred the more solid and substantial aim of building up a territorial monarchy in Germany. He was distinguished

among contemporary monarchs for his preference of diplomacy to force, for his strong legal sense, and his love of order. Like Edward I. of England and Philip IV. of France, he marks the transition from mediæval to modern ideals and methods of government.

The merits of Charles IV.'s government in Bohemia have never been contested. One of the first-fruits of his good understanding with Clement VI. was the procuring of a papal bull to erect Prague into a metropolitan see, whereas it had previously been dependent on the Archbishop of Mainz. In 1348, while his affairs in Germany were in their most critical condition, Charles laid the foundations of the University of Prague, with a constitution modelled upon that of the University of Paris, where the king himself had studied. To Charles the Bohemian capital owes not only its university and its archbishopric, but also its famous bridge over the Moldau, and many of its most notable buildings. Much of his attention was given to the promotion of commerce. He established a uniform coinage, provided for the protection of highways, and lowered the tolls upon roads and rivers. He projected a canal from the Moldau to the Danube, which was to carry through Bohemia the traffic between Venice and the Hanseatic League. Many of his measures were protective in the extreme. Every foreign trader who crossed the Bohemian frontier was compelled to expose his wares for sale in Prague; no foreigner could conclude a bargain except through a native merchant; and all goods had to be sold by Bohemian weight and measure. Short-sighted as such regulations may appear in the present day, they were in accordance with the ideas of the time, and they were not unsuccessful in attaining their end. From German and Slavonic countries nobles, merchants, teachers and scholars flocked to the capital of Bohemia; the members of the university were to be counted by thousands before Charles's death.

Under this beneficent rule Prague promised to become the

chief city of Germany, and the balance of power and of civilisation was transferred from the west to the east. Charles, undoubtedly, looked forward to securing for the House of Luxemburg a position almost exactly similar to that afterwards attained by the House of Hapsburg; and he trusted that his descendants would enjoy, as the Hapsburgs did in later times, an unbroken and quasi-hereditary succession to the imperial throne. And his more sanguine schemes did not stop at this point. He founded in Prague a cloister of Slavonic monks, collected from Bosnia, Servia, and Croatia, whose task was to draw closer the bonds between Bohemia and the eastern Slavs, and ultimately to pave the way for a union between the Latin and Greek Churches. If this dream had been fulfilled, the Luxemburg House might have founded a power greater than that of any Emperor, and Bohemia, which has always been a triangular wedge thrust from the east into the west, might have become a rivet between the two great divisions of the Continent.

In 1354 Charles IV. set out for Italy to receive the Lombard crown at Milan, and the imperial crown in Rome.

Charles IV. From the Ghibelline point of view his journey in Italy. was ignominious, but as throwing light upon Charles's policy it was of great significance. He refused to be drawn into the vortex of Italian politics, or to break his treaty with the Pope. To the representations of the Ghibelline leaders, as to the eloquent appeals of Petrarch, Charles turned a deaf ear. He entered Rome to be crowned, paraded the streets in his imperial robes, and then retired outside the walls to San Lorenzo. With as little delay as possible, he hastened on his return journey. It was a deliberate renunciation of the claim of the mediæval Emperors to rule in Italy. Charles saw clearly that Germany had been ruined by the attempts of its rulers to make their monarchy in Italy a practical force, and in the interests of Germany he refused to imitate the folly of his predecessors. His main object was the reconstruction of an orderly and

efficient authority in Germany, and that object could only be achieved by resolutely cutting himself free from the entanglement of Italian ambitions.

It was to the task of reform in Germany that Charles devoted himself immediately on his return to Germany, and his conferences with the diets at Nürnberg in 1355 and 1356 resulted in the issue of the great enactment with which his name will always be connected—the Golden Bull. There were two great and pressing problems which required solution. One very obvious cause of recent disorders in Germany had been the disputed elections to the Empire, and these were intimately associated with the uncertainty as to the rules of election. It is true that tradition had decided that there should be seven electors, and that certain sees and certain families had claims to the right of voting. But the German practice of subdividing lands among male heirs had given rise to great uncertainty as to which member of a family should exercise this right. Thus the House of Wittelsbach was split into two main branches, the one holding the Palatinate of the Rhine, the other the duchy of Bavaria. By family agreement the Wittelsbach vote was to be given alternately by the heads of the two branches, but such an arrangement was certain to give rise to quarrels. In 1314 the Saxon vote had been given on opposite sides by two rival claimants, and the same thing had taken place in the elections of 1346 and 1348. The prevention of similar disputes in the future was a primary condition of peace and order in Germany, and was one of the main objects of the Golden Bull.

The second great and pressing difficulty in Germany was the danger of the complete disruption of all political unity. There were innumerable tenants-in-chief, electors, princes, knights and cities, held together by nothing but common allegiance to a monarchy which had lost all efficient authority. If no remedy could be devised, Germany must become a mere geographical expression like Italy. The cities would

become independent republics, and desolating wars between them and their princely neighbours would lead to incurable anarchy. In that case, the border provinces must inevitably fall to the growing power of France. Lyons was already gone; Dauphiné was practically lost. Provence and Franche-Comté, though acknowledging imperial suzerainty, were subject to French influence and destined to fall, with the Netherlands, under the rule of a French dynasty. German ascendancy would disappear, first in the valley of the Rhone and then in that of the Rhine.

Charles IV. was fully alive to these dangers. He had accompanied his father to Italy in 1330, had acted for a time as his vicegerent, and had then acquired an insight into Italian politics which profoundly influenced his subsequent policy. It is hardly too much to say that his guiding motive was to preserve Germany from the fate which nominal subjection to imperial rule had brought upon Italy. And though he was connected by relationship, education, and past alliances with the Valois House of France, he was by no means blind to the dangers of French aggression in the west. It was in the vain hope of checking the constant falling away of border lands that in 1365 he went through the ceremony of being crowned King of Arles, disused by his predecessors since Frederick Barbarossa.

On the subject of imperial elections, the provisions of the Golden Bull are clear and precise, and they remained a fundamental law until the Holy Roman Empire The Golden Bull, 1356. ended its shadowy existence in 1806. The number of electors is fixed at seven—viz. three ecclesiastics, the Archbishops of Mainz, Köln, and Trier, and four lay princes, the King of Bohemia, the Count Palatine of the Rhine, the Duke of Saxony, and the Margrave of Brandenburg. The three ecclesiastical electors are to be arch-chancellors of the three kingdoms: the Archbishop of Mainz in Germany, the Archbishop of Köln in Italy, and the Archbishop of Trier in Arles. The four secular electors

are to hold the great household offices: the King of Bohemia is chief cup-bearer, the Count Palatine grand-seneschal, the Duke of Saxony grand-marshal, and the Margrave of Brandenburg grand-chamberlain. The election of the Kings of the Romans and future Emperors is to be held in Frankfort, and decided by a majority of votes. The elected prince is to be crowned at Aachen, and to hold his first diet at Nürnberg. The territories to which the electoral dignity is attached are never to be divided, and the succession is to be regulated by the rules of primogeniture among male agnates. During a minority, the electoral vote and the administration of the electoral provinces are to be intrusted to the nearest male relative on the father's side. The electors are to take rank before all other princes; they are to have the royal rights of coining money and of final jurisdiction without appeal. All confederations of subjects without the leave of their territorial lord are prohibited, and the towns are forbidden to grant their citizenship to *pfahlbürger*, or burghers outside the walls, or to receive fugitive serfs to the shelter of their walls and franchises.

There is one omission in the Golden Bull which is as significant and important as any of its direct provisions. The papal claims to confirm or veto an election, and to administer the Empire during a vacancy, were passed over in complete silence. The great electoral resolutions of Rense were practically but silently erected into an imperial law, and the election of future Emperors was to be treated as a private affair of the German nation. Innocent VI. did not hesitate to show his displeasure at the promulgation of such a law by a prince who was regarded as the docile creature of the Holy See. But Charles IV. showed a firmness worthy of Edward I. or of Philip the Fair. When the papal nuncio tried to levy a tenth of clerical revenues, Charles replied by demanding a reform of ecclesiastical abuses and by threatening to confiscate Church property. The Pope was forced to give way, and to abandon his opposition to the Golden Bull.

The Papacy
and the
Golden Bull.

With regard to the practical results of the Golden Bull, historians are unanimous. It erected an aristocratic federation **Results of the Golden Bull.** in Germany in place of the older monarchy, and the German constitution never lost the impress which it received in the fourteenth century. The powers and privileges which the Bull conferred upon the electors were inconsistent with the exercise of efficient monarchical authority. And though the secular electors in 1356 were not, with the exception of Charles himself, very powerful princes, yet it was certain that the establishment of primogeniture and of indivisibility of territories would before long give them a territorial power proportionate to their elevated rank.

But historians have misjudged Charles IV., partly because they have fallen into the common error of confusing the **Motives of Charles IV.** results of the Golden Bull with the intentions of its author, and partly because they have paid insufficient attention to the precise circumstances of the time in which he lived. Charles was profoundly convinced—and it is difficult to maintain that he was wrong—that the mediæval Empire was at an end, and that any attempt to revive it would result in the ruin of Germany. The forces which he most dreaded were the rising cities in the north and south, and the greater territorial princes, such as the Hapsburgs and the Bavarian Wittelsbachs. Both of these were weakened by the Golden Bull—the cities by its actual provisions, and the princes by their definite exclusion from the electoral vote, and by the virtual lowering of their rank which was effected by the elevation of the electors. It is true that the electors themselves received powers and privileges which might prove the foundation of independence, but at the same time their interests were enlisted on the side of unity. The Golden Bull gave them a grander position as joint rulers of Germany than they could look forward to as mere rulers in their own provinces. Thus it might reasonably be hoped that they would resist the further progress of that disruption which had already done so much harm to Germany.

And while he provided this check upon growing disunion, Charles IV. had no desire or expectation that the state of things recognised and confirmed in the Golden Bull should be permanent. His intention was to obtain for the House of Luxemburg such an overwhelming territorial strength that he would secure to his successors a practically hereditary claim to the imperial office, and also such a predominance in the electoral college as would enable them to rule Germany through that body. By gradually adding province after province to the family domain, it might be possible in the end to build up a territorial monarchy like that which existed in England and was in process of construction in France. It is true that such a monarchy might be less imposing than the wide-reaching claims of imperial suzerainty, but it would be infinitely stronger and more advantageous to Germany. No single lifetime could be long enough to effect such a work, and Charles's direct heirs only lasted for a single generation, and were themselves incapable of following in their father's footsteps. But such territorial power as was afterwards gained in Germany by the Hapsburgs was, for the most part, acquired by following the lines laid down by Charles IV., and in more than one way the Hapsburgs may be regarded as the heirs of the House of Luxemburg.

It is this definite policy which gives to Charles's territorial ambitions an interest and a dignity which are lacking to the purely selfish and aimless acquisitiveness of his predecessor. In 1356 John, Duke of Brabant and Limburg died, and his territories passed to his daughter and her husband Wenzel, Duke of Luxemburg, Charles's youngest brother. The Emperor supported his brother against the rival claims of the Count of Flanders, and obtained from the duchess and the estates of Brabant an agreement that, in default of heirs, the provinces should fall to the main line of Luxemburg. In 1363 occurred a very important crisis in the family relationships of Germany through the death of Meinhard, the only son of Margaret

Territorial
acquisitions
of Charles IV

Maultasch and of Lewis of Bavaria, the eldest son of the late Emperor (see p. 107). Meinhard's death left vacant both Tyrol and the duchy of Upper Bavaria. The Hapsburg claim to Tyrol, which had failed in 1335, was promptly renewed by Rudolf of Austria. Rudolf was one of the princes who were most indignant at the increased rank given to the electors by the Golden Bull, and he had shown his irritation by assuming the title of 'archduke,' which in the next century was permanently adopted by the House of Hapsburg. Charles iv. seized the opportunity to gain over so powerful a malcontent. He confirmed Rudolf in possession of Tyrol, and at the same time concluded with him a treaty of mutual inheritance by which, on the extinction of either House, the other was to inherit all its lands. At the time, the House of Hapsburg seemed nearer to extinction than that of Luxemburg; and, as a matter of fact, the treaty was never actually carried out. But it is not a little curious that within a century after the male line of Luxemburg had come to an end, almost all the territories which it held in 1364 had passed, in one way or another, into the hands of the Hapsburgs.

Meanwhile a struggle had broken out as to the succession in Upper Bavaria. By a treaty made in 1349 between the sons of Lewis the Bavarian, that duchy ought now to have gone to Lewis the Roman and Otto, in whose favour their elder brother Lewis had renounced the possession of Brandenburg. But the second brother, Stephen of Lower Bavaria, anticipated their claim and obtained his own recognition from the estates of Upper Bavaria. The two margraves applied for assistance to Charles iv., and promised him the succession to Brandenburg if they died without heirs. This agreement ultimately took effect in 1373, when Otto, the surviving margrave, was induced or compelled to cede Brandenburg to the Emperor, who pledged himself to the estates that the union of Brandenburg with Bohemia should be perpetual. Thus Charles acquired a second electoral vote and a very notable increase of his territorial power in northern Germany.

About the same time he betrothed his second son, Sigismund, to the daughter of Lewis the Great, King of Hungary and Poland, and thus opened a prospect of adding these states to the now enormous possessions of the Luxemburg House.

These actual or prospective acquisitions could be of little permanent value unless Charles could secure to his House the continued occupation of the imperial office, and in 1374 he began to sound the electors on the subject of the election of his son Wenzel, a boy of fifteen years old. But there were many difficulties in the way. The Golden Bull made no provision for an election during the lifetime of any occupant of the throne. The spirit, if not the letter, of the law was against such a thing. There were also serious objections to the election of a minor, and many princes were jealous of the predominance already gained by the Luxemburgers. Charles, however, was not very scrupulous in such a critical matter, even about the observance of his own laws. He gained over the electors, but by the old objectionable method of bribing them. He did not hesitate to appeal for papal approval, thus reviving the pretensions which the Golden Bull had practically abrogated. But his policy was successful in its immediate aim. Wenzel was elected at Frankfort on June 16, and crowned at Aachen on July 6, 1376.

The election of Wenzel as King of the Romans was the last triumph of Charles IV. His repressive attitude towards the cities had met with only partial success. The great northern Hansa had conducted a successful war against Waldemar III., one of the strongest of Danish kings, and in 1370 had forced him to conclude a humiliating treaty at Stralsund (see p. 437). And in 1376 a new danger arose in the south. The Swabian towns were disgusted at the sacrifice of the last imperial domains in their province to purchase electoral votes. They renewed an old league under the leadership of Ulm, and refused to recognise Wenzel's election. At Reutlingen (May 14, 1377) the forces of the league won

a complete victory over their hated enemy, the Count of Württemberg. This was followed by a rapid extension of the confederation, and Charles was too old and too weak to attempt its suppression. In August, 1378, he authorised his son Wenzel to conclude a peace between the towns and the princes, and to concede the right of union to the former. Thus one of the provisions of the Golden Bull was abandoned during Charles's own lifetime.

Nor was this the only blow which Charles experienced in his later years. He had long struggled to put an end to the papal residence at Avignon, which was a scandal to Europe and a serious injury in many ways to German and imperial interests. He had succeeded in persuading Urban v. to return to Rome in 1367, and had himself visited the Pope in the Eternal City. But Urban was alienated by Charles's refusal to take active measures against the Ghibelline Visconti, and was easily induced by his French cardinals to return to Avignon. The whole work had to be begun again. At last, **The Great Schism.** in 1377, Gregory xi. was persuaded to quit the banks of the Rhone and to take up his residence in Rome. But he was meditating a second withdrawal from the city when he was overtaken by death. The new election had to take place in Rome, and the choice of the cardinals fell upon an Italian, Urban vi. This seemed for the moment a conspicuous triumph for Charles iv. But Urban's violence alienated the French cardinals, who seceded from Rome and elected a rival Pope, Clement vii. Clement naturally threw himself upon French support, and fixed his residence at Avignon. Thus the return to Rome, instead of putting an end to scandal, gave rise to the famous schism in the Church which lasted for forty years. Charles iv. was bitterly chagrined, and appealed to all the European princes to recognise Urban and to resist the excessive and dictatorial power of France. And there was some reasonable ground for such an appeal. A brother of Charles v. of France was Duke of Burgundy, and the Duke's wife was the heiress of Flanders, Artois, and Franche

Comté. Another brother claimed the succession in Naples, and the King of Hungary and Poland was a member of the older House of Anjou. The prince who was naturally expected to resist this threatening danger to the balance of states was Charles IV., who might have found it necessary to lead an army against the French king and the Antipope. But on November 29, 1378, just two months after the outbreak of the schism, death removed him from the scene of strife.

Before his death, Charles IV.'s weakness for his children had led him into an act which was ruinous to his most cherished schemes. The Golden Bull had shown how clearly he appreciated the advantages to a state of indivisibility and a strict rule of primogeniture. These advantages he deliberately threw away in his own case. He even broke the solemn pledge which he had given never to separate the marks of Brandenburg from Bohemia. He left Bohemia and Silesia to his eldest son, Wenzel, while he transferred Brandenburg to his second son, Sigismund, and formed a duchy in Lausitz for the third son, John of Görlitz. Moravia was already in the hands of Jobst and Prokop, the sons of Charles's second brother, John Henry; while Luxemburg was still held by the surviving brother, Wenzel, the husband of the Duchess of Brabant and Limburg. The family possessions had increased enormously since the days of Henry VII., but they were of comparatively little value when scattered among so many hands. The House of Luxemburg was never destined to hold the position imagined for it by the greatest ruler it produced, Charles IV.

Death of
Charles IV.

Partition of
Luxemburg
territories.

CHAPTER VII

RISE OF THE SWISS CONFEDERATION

The origin of Swiss independence—The Hapsburgs in Swabia—The Forest Cantons—The League of 1291—Its Character—The Battle of Morgarten—Luzern joins the League—Zurich under Brun joins the League—Accession of Glarus—The League conquers Zug—Bern joins the League—The Eight Cantons—Continued danger from Austria—Rudolf IV. in Swabia—Leopold II., his brother, renews the war with the Swiss—Battle of Sempach—Treaty of 1389.

THE Swiss Confederation has played a part in European history wholly out of proportion either to the area which it covers, or to the population which it includes. It is placed in the midst of the western peoples of the Continent, on the border where the Romance and German elements touch each other at the most decisive political and strategic points. This geographical position has made the continuance of Switzerland an international necessity. At the same time, Swiss history offers to the contemplation of the scientific historian the most perfect, as it has been the most durable, of federal constitutions. And this confederation is the more unique and important because it shows how common interests and dangers can hold together communities, not only of different origin and institutions, but also of differing race and language. The story of its origin is one of the most fascinating episodes in the history of the fourteenth century.

The beginnings of Swiss history have been obscured in two ways: by the poetical myths which have gradually grown up, and by the theories which have been spun in the imagination

of patriotic antiquaries. The myths as to the origin of Swiss independence have long enjoyed a world-wide fame, and it was reserved for the harsh criticism of the nineteenth century to show that they had no real historical basis. The story of William Tell shooting the apple on his child's head has been proved to be an ancient legend of the heroic sagas. The hoisting of the bailiff's hat in the market-place of Altdorf is an addition of quite recent origin. No bailiff of the name of Gessler ever existed in the district; and if there was a William Tell, which cannot be proved, he was of no political importance whatever. Even the more probable and important story of Fürst, Melchthal, and Stauffacher, and of their oath on the field of Rütli, has also been ruthlessly demolished. If these men ever lived and did the deeds for which they are renowned, it must have been in some other place and in quite another relation.

Legends as to origin of Swiss independence.

The antiquarian theories as to the origin of the Swiss people are quite as baseless as the legends, and not nearly so interesting. They have varied sometimes in their form, but their object has always been to show that the Forest Cantons, the earliest members of the league, had some special race origin and some peculiar independence, apart from the rest of Germany. They were founded, it is said, by settlers from Norway and Sweden, who left their homes for fear of losing their liberties, and swore to maintain them in a foreign land. All such stories are absolutely without foundation. Modern researches have proved, not only that the Forest Cantons were members of the Empire like their neighbours, but that various lords, spiritual and temporal, held different rights over them at various times. Their constant effort was to get rid of the authority of these feudal lords, and to vindicate a position of direct dependence upon the Empire alone. It was this effort which led to the first formation of a league.

The Lake of Luzern, on the shores of which the original Swiss cantons are situated, lies within the limits of the old duchy of Swabia. The extinction of the line of dukes left a

number of individuals and corporations in Swabia without any intermediate lord between them and the Emperor. But as the imperial authority declined, and especially during the Great Interregnum, the chief families in Swabia set themselves to reduce their weaker neighbours to subjection. The most successful of these families was that of Hapsburg, whose original estates were in the district of Brugg, at the junction of the Aar and the Reuss. By the middle of the thirteenth century the family had vastly extended their possessions. In addition to their lands in the Aargau, they had large territories in the Breisgau and in Elsass. Rudolf III., born in 1218, set himself to extend his power by every possible means—by war, negotiation, and purchase. His avowed object was to restore the territorial unity of Swabia under Hapsburg rule. And if the old duchy had been revived, it would have been difficult to entrust it to any other family.

But against this aggressive policy was arrayed the desire for local independence, of which the most successful champions were the villages of Uri, Schwyz, and Unterwalden. Uri had been granted in 853 by Lewis the German to the abbey of nuns in Zürich, but in 1231 the inhabitants had obtained from Frederick II. an acknowledgment of their independence of any power except the Emperor. The other two cantons, without such explicit proofs, had claims which were generally acknowledged to a similar position. The endeavour to maintain this independence of direct rule must have brought the villagers into collision with their powerful neighbour, the Count of Hapsburg. For the moment the struggle was postponed by the news that Rudolf III. had been elected King of the Romans in 1273. Thus he obtained in his new capacity a suzerainty over the cantons, which they were prepared to deny him as Lord of Swabia. The contest must have seemed hopelessly unequal now that the Hapsburg Count could use his imperial authority to support his dynastic ambition. But Rudolf's attention

was diverted from local affairs by his struggle with Ottokar, by the acquisition of Austria, and by the establishment of his family in this new eastern possession. He never relinquished his original aims in Swabia, but he was no longer able to concentrate his attention on their achievement. The Hapsburg conquest of Austria was the first foundation of Swiss independence.

But the peasants by the Lake of Luzern showed a clear appreciation of the danger that threatened them. In August, 1291, immediately after the death of Rudolf, they drew up the first league of which any record has been preserved. The document itself is worth quoting:—‘Know all men that we, the people of the valley of Uri, the community of the valley of Schwyz, and the mountaineers of the lower valley, seeing the malice of the times, have solemnly agreed and bound ourselves by oath to aid and defend each other with all our might and main, with our lives and property, both within and without our boundaries, each at his own expense, against every enemy whatever who shall attempt to molest us, either singly or collectively. This is our ancient covenant. Whoever hath a lord let him obey him according to his bounden duty. We have decreed that we will accept no magistrate in our valleys who shall have obtained his office for a price, or who is not a native and resident among us. Every difference among us shall be decided by our wisest men; and whoever shall reject their award shall be compelled by the other confederates. Whoever shall wilfully commit a murder shall suffer death, and he who shall attempt to screen the murderer from justice shall be banished from our valleys. An incendiary shall lose his privileges as a free member of the community, and whoever harbours him shall make good the damage. Whoever robs or molests another shall make full restitution out of the property he possesses among us. Every one shall acknowledge the authority of a chief magistrate in either of the valleys. If internal quarrels arise, and one of the parties

The Original
League of
1291.

shall refuse fair satisfaction, the confederates shall support the other party. This covenant, for our common weal, shall, God willing, endure for ever.'

It is obvious from this simple document that the league, at its first origin, is something more than a mere defensive alliance. It regulates to a certain extent the **Character of the League.** punishment for crime, probably because endless confusion would arise if different penalties were enforced in each canton, and a criminal could fly from one to the other. At the same time, there is no complete federal government formed all at once. There is no mention of a joint assembly to consider matters of common interest; nor is there any provision for a common taxation for federal purposes. Each canton is to carry on war at its own expense, and is to furnish, not a fixed contingent, but the whole male population capable of bearing arms. The league was not the work either of theorists or of experienced politicians, but was drawn up by three village communities in the face of present danger, and future difficulties were left to settle themselves. And the provision about obedience to a lord proves that the object of the league was to guard against oppression rather than to claim independence. But experience soon proved that independence was the only safeguard against oppression.

Limited as its aims were, the league could hardly have maintained itself if Rudolf's eldest son Albert had succeeded **The League confirmed.** his father on the imperial throne. And here we may notice the good fortune that attended the infant confederacy. If the Hapsburgs had continued to be a mere Swabian family there is little doubt that they would have been successful in enforcing their immediate sovereignty. The election of Rudolf, and his acquisition of Austria, gave the cantons a breathing space in which they could agree upon joint action for their defence. The failure of the Hapsburgs to maintain the imperial dignity was another piece of luck for the allies. It gave them powerful allies and a pretext for adhering to their claim of direct dependence upon the Empire.

They reaped an immediate advantage from the election of Adolf of Nassau on the death of Rudolf. Adolf, eager to weaken his rival, Albert of Austria, at once confirmed the league of 1291, and promised it imperial protection. But the fall of Adolf and the election of Albert again put the confederates in a very dangerous position. It is to Albert's reign that the tyranny of bailiffs, like Gessler, is attributed. But these stories have no contemporary authority. Albert certainly appointed bailiffs by virtue of his imperial authority, but we have no record that he appointed aliens, or that his bailiffs were tyrannical. In fact, Albert, like his father, had his hands full with imperial affairs, and had no time to devote himself to his interests in Swabia. The league remained passive during his reign, and wisely gave him no pretext for hostile interference. Had Albert's son succeeded to the Empire, the Forest Cantons would probably have been gradually absorbed in the Hapsburg dominions. But here again their good fortune came to their aid. After Albert's death the imperial crown was withheld from his House for several generations. The Luxemburg and Bavarian Emperors were for the most part hostile to the Austrian dukes, and were not unwilling to strengthen the opposition to them in Swabia.

One of the first acts of Henry VII. was to grant to the league the most ample confirmation of their sole dependence upon the Empire and complete exemption from all foreign jurisdiction. In return for this they sent three hundred soldiers to accompany the Emperor on his Italian campaign—the first occasion on which Swiss troops served outside their own country. In the struggle between Lewis the Bavarian and Frederick of Austria the confederates naturally adopted the side of the former. Leopold, Frederick's brother, determined to punish the rebellious and audacious peasants, as he called them. There is a legendary account of the great battle between the opposing forces; but all that is known is that Leopold's men-at-arms allowed themselves to be attacked in a narrow valley at

Battle of
Morgarten,
1315.

Morgarten, where they had no room for evolution, and the Swiss, having first thrown them into confusion by a shower of stones and other missiles, routed them at the first down-hill charge. This is the first of the great fights which showed the Swiss to be invincible on their own ground, and trained them to become for a time the finest infantry in Europe. The victory was celebrated by the formal renewal of the league at the village of Brunnen; Lewis the Bavarian recognised the value of the service to his cause by confirming the edict of Henry VII.; and by a treaty in 1318 the Hapsburgs withdrew all claims to administrative authority within the limits of the Forest Cantons. The league was now a recognised and successful body to which its neighbours could look for aid in an emergency.

The nearest, and for that reason the most important, of these neighbours was the town of Luzern, which had grown up in the territory and under the protection of the **Luzern joins the League, 1330.** abbey of Murbach. As the town grew in power and wealth, the direct ownership of the abbey was broken off, but the monks retained in their hands the appointment of chief magistrate until it was purchased from them by Rudolf of Hapsburg. The buying up of similar rights was one of the chief methods by which he sought to extend his ascendancy in Swabia. From that time Luzern had acknowledged some measure of subjection to the Hapsburgs, and had aided them with men and money in their struggle with Lewis the Bavarian. But the demands of their overlords became more and more onerous, and growing discontent seems to have impelled the citizens to seek the support of the neighbouring villages. On December 7, 1330, Luzern was formally admitted to the league, and this completed the union of the four Forest Cantons.

There was in this no express defiance of the Hapsburgs, whose rights, jurisdiction, and feudal prerogatives were expressly reserved in the treaty, nor was any change made in the oligarchical government of Luzern. But in time it

was inevitable that the citizens should be influenced by the independence and the democratic constitution of their allies. The burgher nobles formed a conspiracy in 1343 to break off the compact with the three original cantons. The legend tells that the plot was overheard by a boy, who was discovered and pledged to secrecy. He kept the letter of his promise by telling the secret to a stove in a room where the butchers' guild was holding a meeting. The citizens were alarmed, and the conspirators arrested; and the result was that not only did Luzern remain a member of the league, but a new executive council was created of 300 members, while the power of levying taxes, making war and concluding peace, was vested in the whole community. Thus the exclusive oligarchy was overthrown.

Two other cities, Zürich and Bern, though farther distant than Luzern, were destined to play a more prominent part in the history of the league. Zürich was in the fourteenth century a free imperial city, and owed no obedience to any intermediate lord. The government was a close oligarchy, as the council consisted of thirty-six members, all of whom belonged to the old burgher families. As long as their power remained unshaken, there was little likelihood of any close connection with the peasants of the original cantons. But Zürich, like so many other towns at the time, underwent a revolution. The artisans, organised in their own guilds, were stirred up to dispute the exclusive rule of the old burghers. The leader of the revolution was Rudolf Brun, one of the most remarkable demagogues of a century which produced Rienzi, Marcel, and the Arteveldes. Brun was himself a member of the ruling class, but sought to gratify his own ambition by turning against it. In 1336 the political change was accomplished. The members of the council were intimidated into flight, and a mass meeting decreed that the government should be reformed, and that in the meantime Brun should hold supreme power. Before

long the new constitution was promulgated. Brun was appointed burgomaster for life with the assistance of a council of twenty-six. Thirteen of these were to be nominees of the burgomaster—six nobles and seven plebeians; the other thirteen were the tribunes of the guilds. For the next fifteen years Rudolf Brun was practically despot in Zürich, but it was not until his authority was seriously threatened that he had any inducement to ally himself with such sturdy opponents of personal rule as the inhabitants of the Forest Cantons.

The undisguised despotism of Brun not unnaturally provoked a reaction in Zürich, and the members of the dis-
 Zürich joins
 the League,
 1351.
 possessed oligarchy were encouraged to intrigue for his overthrow. They found zealous supporters among the nobles outside the walls, especially in John of Hapsburg, Count of Rapperschwyl, a cousin of the Austrian dukes. The story of the discovery of the plot is strangely reminiscent of the similar incident in the history of Luzern. A baker's boy overheard the incautious conspirators, and informed his master. Brun was warned, and the rising was ruthlessly suppressed. All citizens suspected of disaffection were put to death, John of Hapsburg was imprisoned, and his town of Rapperschwyl was razed to the ground. But this act provoked the anger of the Austrian Hapsburgs, and to protect himself against their threatened vengeance, Brun found himself compelled to secure the alliance of the Forest Cantons. The agreement of May 2, 1351, is of great importance, as showing a marked progress towards federation, and also because its provisions gave rise to many subsequent difficulties. 'We, the cantons of Zürich, Luzern, Uri, Schwyz, and Unterwalden, do hereby enter into a firm and perpetual union: we engage to assist each other with our lives and fortunes against all who shall in any ways attempt to injure us in our honour, property, or freedom: this we bind ourselves to perform at all times and in all places within the Aar, the Thur, the Rhine, and Mount St. Gothard.

Whenever the council or community that calls for aid shall declare upon oath that the case is urgent, each canton shall, without evasion or delay, and at its own cost, send the demanded aid. In great emergencies, such as a distant march or a long campaign, the cantons shall hold a congress at Einsiedeln and there deliberate on the measures to be pursued. We, the confederate cantons, solemnly reserve all the rights of the Holy Roman Empire and its sovereign, and each of us his previous alliances. Each canton may form new alliances, but not to the prejudice of the league. We will jointly preserve the burgomaster and the constitution of Zürich. Should (*quod Deus avortat*) any dissension arise between Zürich and the Forest Cantons, the city shall send two good and wise men, and the cantons two others, to Einsiedeln, and these four shall, on oath, decide the difference: if their votes are equal, they shall chose a fifth associate from any canton, and he shall give the casting vote.' The progress towards federalism is shown in the provisions for conference and arbitration; while the diplomacy of Rudolf Brun is evident in the clauses by which a canton is enabled to form separate alliances, and the Forest Cantons are pledged to uphold the existing constitution of Zürich.

Meanwhile Albert the Lame of Austria, the last survivor of the numerous sons of Albert I.,¹ was arming to avenge the injury done to his kinsman and to vindicate Hapsburg rights in Swabia. In 1352 his troops advanced to the siege of Zürich, and the neighbouring towns and villages were called upon to send aid to the invaders. The people of Glarus, not far from Zürich, were dependent upon the abbey of Seckingen, and the administration was in the hands of a steward appointed by the abess. The Counts of Hapsburg had acquired, more than a century before, the position of advocate, or military champion, of the abbey, and this gave them a claim to the feudal service of the people of Glarus. But to the demands of Albert II. they replied that

¹ See Genealogical Table C, in Appendix.

they were only bound to serve in the interests of the abbey of Seckingen, and refused to fight in a private quarrel of the duke. Albert at once sent a body of troops to coerce Glarus, but the inhabitants obtained the assistance of the Forest Cantons and repulsed them. The result was the conclusion of a permanent league between Glarus and its allies. The rights and revenues of both duke and abbeſs were expreſſly reſerved in the treaty, and the people of Glarus promiſed to make no new alliances without the concurrence of the confederates.

About the ſame time the league made its firſt conqueſt. Hitherto the various members had joined of their own accord; but now the league took the offensive, and to ſecure their own ſafety compelled the little town of Zug to join them. Zug lies between Zürich and the Lake of Luzern, and was occupied by an Auſtrian gariſon. The inhabitants of Schwyz marched to the walls and demanded its ſurrender, declaring that they had no intention to diminifh the authority of the Duke of Auſtria or to change the conſtitution of Zug. As no aid came from Albert II., the townſmen found it neceſſary to ſubmit, and were formally admitted to the league.

The expedition of Albert was thus a complete failure, and the campaign of 1352 was cloſed by a hollow treaty. All prisoners were to be reſealed, and all hoſtages and plunder returned. Zug and Glarus were to pay the duke their accuſtomed allegiance. The confederates were pledged in the future to conclude no alliance with Auſtrian vaſſals: nor were Luzern and Zürich to admit ſuch vaſſals to their citizenship. But all former alliances, immunities, and eſtabliſhed regulations were to remain in force. The terms were perhaps intentionally ambiguous. The Auſtrian duke contended that they involved the ſeparation of Zug and Glarus from the league, while the confederates held that the laſt clause entitled them to maintain the alliance. But though the treaty itſelf was but a doubtful

gain, it was followed by a very great accession of strength to the league. A successful embassy was sent to invite the adhesion of the powerful city of Bern, and a treaty was arranged at the beginning of 1353. Bern joins the League, 1353. The direct alliance is made with the three original cantons; Zürich and Luzern being only indirectly involved, while Glarus and Zug are not mentioned at all. 'The Swiss of the three Forest Cantons shall be assisted by Bern, whenever they shall be in need: and the cantons in return undertake to defend the city of Bern, its burghers, and all its property. . . . We, the Bernese, promise to assist Zürich and Luzern, when required by our Swiss confederates: we, of Zürich and Luzern, promise that whenever Bern shall be attacked and its council shall send to the Forest Cantons for aid, we will at our own expense immediately march to its assistance.'

The accession of Bern completes the number of the eight old cantons; and the league had grown to these dimensions in just over sixty years, from 1291 to 1353. The eight old Cantons. But it is obvious that as yet there were little more than the elements of a federation. There was no central government, and no supreme court of justice. The allies stood on various and unequal terms with each other, and some were not connected at all. Bern was not directly allied with Zürich or Luzern, and not allied at all with Glarus and Zug. Glarus and Zug had no connection with each other, and the former had made more submissive terms than any other canton. Moreover, differences in constitution prevented the various members of the league from regarding political questions in the same light. Bern maintained its exclusive aristocracy, Zürich and Luzern had adopted a mixed constitution, while the three original cantons, with Zug and Glarus, were pure democracies, in which every adult male had a share in political power.

If all danger from the Austrian dukes had come to an end in 1353, it is probable that this ill-cemented league would

have fallen to pieces. But as long as the Hapsburgs remained great landholders in Swabia, their weaker neighbours were in danger of absorption, and it was this which ultimately hardened the league into a lasting federation. Albert II. was resolute to enforce his interpretation of the treaty of 1352. In 1354 he demanded that Glarus and Zug should renounce their alliance with the other cantons. The league appealed to the Emperor, but Charles IV. was pledged to the policy of discountenancing such associations, and he gave his support to the Hapsburg claims. And Albert had another advantage in the self-seeking policy pursued by Rudolf Brun, who was still supreme in Zürich, and who was quite ready to make terms with Austria if he could thereby strengthen his own position. The influence of Zürich nearly induced the Forest Cantons to accept a treaty which would have involved a surrender of the most vital points at issue, and it was only at the last minute that the apparent treachery was discovered. The result was a coolness between Zürich and the confederates, and the former went so far as to conclude a separate treaty with the Austrian duke. Fortunately Albert II. was too old and worn out to profit by this disunion, and just before his death he concluded a truce for eleven years with the league, leaving matters *in statu quo* for the time.

Albert the Lame died in 1358 leaving behind him four sons, who were born after he had been married for nineteen years without issue, and when the extinction of Rudolf IV. in Swabia. the main line of his House seemed imminent. Before his death he made an arrangement that his territories should pass undivided to the joint rule of his four sons. The second son, Frederick, died soon after his father, and the third son, Albert, preferred the study of philosophy to the cares of politics. The two active members of the family were the eldest son, Rudolf, and the youngest, Leopold. Rudolf married the daughter of Charles IV., quarrelled with his father-in-law about the elevation of the electors, and was

only reconciled on being allowed to annex the province of Tyrol (see p. 120). In his Swabian dominions he showed himself an active and capable ruler. He retained the support of Rudolf Brun, to whom he granted a pension and the title of privy councillor. He bought up the territory of Rapperschwyl, thus thrusting in a wedge between the lake of Zürich and the Forest Cantons. On pretence of aiding the pilgrims to Einsiedeln, he built a magnificent wooden bridge over the lake, which was regarded by contemporaries as one of the wonders of the world. His real object was to get into his hands the control of the chief highway between Italy and Germany. His restless activity would certainly have brought him, sooner or later, into collision with the Swiss, but in the midst of his schemes he died suddenly in 1365, when he was only twenty-six years old.

Of the two surviving brothers, Albert III. and Leopold, the latter had been the confidant of Rudolf's ambitious schemes, and was eager to carry them out. With this Leopold II. object he induced his brother to revive the in Swabia. practice of partition, and to content himself with the duchy of Austria. Leopold received as his share Styria, Carinthia, Tyrol, and the Swabian lands. It was to Swabia that he devoted most of his attention. On every side he purchased territorial and other rights. His aim was that of his great-grandfather: the formation of a strong and united Swabian principality in Hapsburg hands. In the pursuit of such an aim he was inevitably brought into collision with the Swiss.

One of Leopold's most conspicuous successes was the obtaining from Wenzel, the feeble successor of Charles IV., the office of imperial advocate in Upper and Lower Renewal Swabia. He soon found himself involved in grave of war. difficulties. To make head against the Swabian league of towns, the princes and knights were forced to form confederations among themselves. In such a state of things local collisions were frequent, and there seemed the possibility of a great war of classes. The Swiss naturally supported the Swabian League,

and Leopold, after a vain struggle to act as arbiter between the hostile forces, found himself forced by Swiss aggression to throw himself on the opposite side. The forces of the neighbouring nobles flocked to his banner at Baden in Aargau, and as the Swabian League failed to send any assistance to the Swiss, Leopold seemed to have good reason to expect a complete and easy victory. But the Swiss, who had defiantly broken the treaty of 1352, were conscious that the struggle was one for liberty or subjection. Rudolf Brun was dead, and Zürich had returned to complete harmony with the confederates. No effort was spared to collect forces, and the Swiss victory at Sempach, July 9, 1386, was even more decisive, if more hardly won, than that of Morgarten. Leopold himself, fighting with reckless ardour to redeem the fortunes of the day, fell upon the field. His death virtually decided the war. It is true that the Swiss had to fight and win another battle at Näfels, before they could force their opponents to terms. But the treaty of 1389 was as complete as any Swiss patriot of those days could desire. The sons of Leopold renounced all feudal claims, direct or indirect, over Luzern, Glarus, or Zug. Thus within a hundred years from the formation of the league of 1291, the Swiss had succeeded in obtaining for the whole territory comprised in the extended confederacy that position of dependence upon the Empire alone, which had been the first aim of the Forest Cantons.

**Battle of
Sempach,
1386.**

**Treaty of
1389.**

CHAPTER VIII

ITALY IN THE FOURTEENTH CENTURY, 1313-1402

Guelfs and Ghibellines—Equality of parties leads to foreign intervention—Lewis the Bavarian—John of Bohemia—League against Mastino della Scala—Walter de Brienne in Florence—Rise of mercenaries—Foreign and native Condottieri—Joanna I. of Naples—Succession disputes in Naples—Rome and the Papal States—Career of Rienzi—Cardinal Albornoz recovers the Papal States—Return of the Popes to Rome and outbreak of the Great Schism—Strife of classes and families in Florence—Rising of the *Ciompi*—Revolution of 1382 and triumph of the oligarchy in Florence—Rivalry of Venice and Genoa—War of Chioggia—The Visconti in Milan—Successes of Gian Galeazzo Visconti—His death.

THE death of Henry VII. marks the failure of the last serious effort on the part of a German king to carry out the ideal of Dante's *De Monarchia* by establishing an efficient monarchy in Italy. A few years earlier the Papacy, which had done more than any other power to thwart the imperial pretensions, had almost deliberately weakened its authority by transferring its residence to the banks of the Rhone. It seemed as if Italy might for a time be freed from the rivalry of the two claimants to universal rule, whose quarrel had done so much to cause discord and anarchy in the peninsula. But it is one of the numerous anomalies of Italian history that the factions of Guelfs and Ghibellines continue their feuds with the same vigour and animosity as in the days when each had a substantial cause to fight for. Yet beneath these feuds we can trace a growing undercurrent of political interests and of selfish aggrandisement, which gradually led to the absorption of the lesser states by their more powerful neighbours, and ultimately to

the formation of the five greater powers whose rivalry fills the history of the next century. The example was set by Venice, whose geographical position removed her from the main current of party strife, while her interests were more strictly defined than those of any other state. In the east she had to maintain and extend her trade and her influence against the rivalry of Genoa; and she had also to face the serious problems raised by the steady decline of the Eastern Empire and the constant aggressions of the Turks. In the west she had not yet acquired any territory on the mainland, but two pressing interests compelled her to keep a watchful eye on the politics of Lombardy. She could not with safety allow any continental power to obtain complete control of the Alpine passes through which Venetian merchandise found its way to the markets of Central Europe. Still less could she neglect the imperative need of securing supplies of food. Built upon the small islands of the lagoons, she could not possibly raise enough produce to feed her citizens, and was necessarily dependent upon importations from eastern Lombardy or Dalmatia. If a hostile power could cut off these supplies, Venice must be speedily starved into surrender. This double interest forced Venice to play a more prominent part in Italian politics than her isolated position seemed to warrant, and in the end impelled her to join in the scramble for territory on the mainland.

With the exception of Venice, all the Italian states were more or less involved in the strife of factions. In the south Robert of Naples, relying upon Papal and French support, still held the Guelf leadership, and still aimed, like his grandfather, at converting this leadership into a kingdom of Italy. But the Angevin power was no longer what it had been in the days of Charles I. The Sicilian Vespers had given Sicily to a hostile dynasty, and the Popes in Avignon were less valuable allies than their predecessors in Rome. In the north lay the main strength of the Ghibelline party. Despots, like Matteo Visconti in Milan and

Cangrande della Scala in Verona, were rapidly overthrowing the republican independence of the Lombard cities, and these men had no legal basis for their authority save their appointment as imperial vicars. Between Naples and Lombardy lay the Papal States and Tuscany. In the former, the Popes continued to employ what authority they could wield through their legates on the Guelf and Angevin side. But the decline of their direct authority led to the rise of petty despots in cities which were nominally papal fiefs, and these despots, desiring the maximum of independence for themselves, naturally leaned towards Ghibellinism. In Tuscany there was also a marked division. Florence was the head of a group of communes which retained republican institutions and were ardently Guelf in sympathy. But Pisa, also a republic, was equally resolute on the Ghibelline side.

On the whole the two parties were so evenly matched in strength, that it was difficult for either to resist the temptation of trying to turn the balance in its own favour by ^{Foreign inter-}calling in foreign assistance. It is true that a ^{vention in} number of writers, including Sismondi, have re-^{Italy.}presented the Guelfs as the national and the Ghibellines as the anti-national party. But this view involves both a misconception of the mediæval empire, and also the anachronism of assuming a sense of nationality to exist in Italy at a time when no such idea was possible. The only sentiment which could vie with devotion to party was patriotism; but patriotism beyond the bounds of his own city was as unknown to a citizen of Florence or Milan as it was to an Athenian or a Spartan in the days of Greek independence. Robert of Naples was as much a foreigner to a native of Lombardy or Tuscany as Lewis the Bavarian, and the king of France was much more so. As long as party spirit was the strongest force in Italy, we can trace a succession of appeals for foreign intervention: and when party spirit finally gave way to the rivalry of state with state, this intervention grew into conquest and occupation.

Henry VII. in the last struggle before his death had clearly and correctly perceived that the key to the situation was in Tuscany, that if the Ghibelline cause could triumph in that province the overthrow of the Guelfs might be confidently expected. And not long after his death the desired state of things seemed not unlikely to be realised. One of the most famous adventurers of the age, Castruccio Castracani, who had risen to prominence by his military ability, made himself lord of Lucca and there became a formidable neighbour to Florence. In 1325 he reduced the intermediate town of Pistoia, and defeated the Florentine forces at Altopascio. So terrified were the Florentines that they resolved to sacrifice their independence as the price of safety and the victory of their party. They offered the lordship of the city to Robert of Naples, who accepted it for his only son, Charles of Calabria. The progress of Castruccio was checked, and the appearance of Neapolitan forces in Tuscany impelled the Ghibelline leaders to call in the assistance of Lewis of Bavaria (*vide* p. 104). Lewis the Bavarian entered Italy in 1327, but his coming brought little real gain to his allies. In Milan he imprisoned his host, Galeazzo Visconti, and restored to the citizens a mockery of republican independence. Pisa, in spite of her Ghibelline traditions, stood a month's siege before she would open her gates to a prince who might hand her over as a reward to his chief supporter Castruccio Castracani. No attempt was made to attack the Duke of Calabria in Florence, and Lewis hurried on to Rome. There he was crowned emperor. John XXII. was deposed as a heretic, and an Antipope was elected. Castruccio was formally created Duke of Lucca, Pistoia, and Volterra. But the news came that the Florentines had captured Pistoia by stratagem, and Castruccio had to hurry north for the defence of his duchy. He was indignant that Lewis had given the lordship of Pisa to the empress, and in defiance of imperial authority he took measures to secure his own rule in the city. From Pisa he

advanced to a successful siege of Pistoia, but he died almost immediately after (September 3, 1328) of a fever contracted in the trenches.

The death of Castruccio and the humiliating failure of Lewis the Bavarian, who was forced to evacuate Rome in the autumn of 1328, deprived the Ghibellines of the advantages which they had secured in the early part of the year. Lucca, which had threatened to subdue both Florence and Pisa, became a prize for which many states and adventurers contended. But the Guelfs did not profit as much as might have been expected from the disasters of their opponents. Charles of Calabria, having served the purpose of the Florentines by saving them from Castruccio, died on November 9, 1328, and Florence recovered her independence. Robert of Naples, profoundly discouraged by the death of his only son, abandoned most of his ambitious projects and ceased to interfere in the politics of northern Italy. Soon afterwards the emperor found it necessary to leave Italy in order to look after his interests in Germany. Before his departure he restored Milan to the rule of Azzo Visconti, the son of the deposed Galeazzo, who had perished, like Castruccio, of a disease contracted during the siege of Pistoia.

The departure of Lewis and the inactivity of the Neapolitan king left the parties in northern Italy to fight out their quarrels without foreign aid. The Ghibellines had lost their short-lived ascendancy in Tuscany, but they were still omnipotent on the Lombard plain.

Power of
Mastino
della Scala.

By far the most powerful Ghibelline prince at this time was Mastino della Scala, who in 1329 had succeeded his uncle Cangrande in the government of Verona. Cangrande, a typical Italian despot in his combination of relentless cruelty with the patronage of letters, had established a strong territorial power in eastern Lombardy. He had forced Marsilio Carrara to govern Padua as his lieutenant, while he had brought into direct submission the towns of Vicenza, Feltre, Belluno, and Treviso, and was thus enabled to control the

most important eastern passes through the Alps. Mastino inherited his uncle's ambition with his territories, and on receiving an appeal for aid from the Ghibelline exiles of Brescia, he eagerly seized the pretext for laying siege to that city. This aggression led to the most interesting and unique instance of foreign intervention in Italy. John of Bohemia (*vide p. 18*) happened to be at the moment on the Italian borders at Trent, negotiating the marriage of his second son with the heiress of Tyrol, Margaret Maultasch (*vide p. 107*). He had never taken part in Italian politics, but he enjoyed a brilliant reputation in Europe, and there was much in his position to attract the attention of the Italians. He was known to be on the most intimate terms with the Pope and the French king, both patrons of the Guelf cause. At the same time, as the son of Henry VII., he had strong claims on the allegiance of the Ghibellines. If any man could act as a mediator in the party feuds of Italy, it was the head of the house of Luxemburg.

To King John the besieged Brescians appealed for assistance, and offered in return the sovereignty over the city. The prospect of a new field for adventure was more than John could resist. He ordered levies to be collected in Bohemia, and warned Mastino della Scala to desist from attacking a city which owned his lordship. Mastino obeyed on condition that the Ghibelline exiles should be restored; and this promise, to the great chagrin of the dominant party in Brescia, the king fulfilled. On his entry into the city (December 31, 1330) John announced that he would belong to no party, that his one aim was to restore peace and justice, and that he hoped that before long there would be no more Guelfs and Ghibellines. The immediate effect of such unprecedented language was almost magical. The Italians, exhausted with continual party warfare, welcomed as a protecting angel the prince who promised impartiality. One after another the cities of northern Italy, Bergamo, Cremona, Pavia, Vercelli,

Successes of
John in
Italy.

and Novara, placed themselves under the rule of John of Bohemia. Even Azzo Visconti, the powerful lord of Milan, found it advisable to acknowledge the suzerainty of the king, and to accept the title of royal vicar. Soon afterwards John's dominions were extended southwards by the submission of Parma, Reggio, Modena, and the unfortunate Lucca, which had been tossed from hand to hand since the death of Castruccio Castracani. In every case the exiles, of either faction, were allowed to return, and the government was established without any regard to party divisions. For a moment it seemed that the spontaneous action of the Italians themselves might create the monarchy that had so long seemed an impossible dream.

But John's success was too sudden to be lasting. Party enmities were too deeply rooted to be torn up at the first effort. Men began to ask in whose name had he come; did he represent the Emperor or the Pope? An appeal to these potentates produced only negative answers. John XXII. was indignant with the king for restoring the Ghibelline exiles in Guelf strongholds; Lewis was jealous that a rival should succeed where he had failed. And John had enemies both in Italy and outside. Mastino della Scala felt himself threatened by the rise of a conterminous principality in Lombardy, and Florence was afraid lest a power which extended so far as Lucca might endanger her own independence. In the north the dukes of Austria and the kings of Poland and Hungary formed a league against him, and John had to cross the Alps for the defence of Bohemia. His absence only hastened the destruction of a dominion that rested on too shallow a foundation to endure. If he had succeeded for a moment in uniting Guelfs and Ghibellines under his rule, a still more wonderful union was brought about for his overthrow. In 1332 the strange spectacle was seen of a close league of Florence and Naples with Azzo Visconti, Mastino della Scala, and other Ghibelline princes of the north. Mastino

had already succeeded in capturing Brescia, and Azzo had seized upon Bergamo and Vercelli. The rest of John's possessions were to be partitioned among the allies. Cremona was to go to Visconti, Parma to Mastino, Modena to the house of Este, Reggio to the Gonzagas of Mantua, and Lucca to the Florentines.

John of Bohemia had succeeded in dividing the northern league, and had proceeded to France and Avignon in order to secure the support of Philip vi. and the Pope. **Collapse of his power.** He now hurried back to the aid of his son Charles, whom he had left in charge of his Italian dominions. But he found that he had no sufficient native support to enable him to face the hostile coalition. The two parties whom he had tried to conciliate were now united in opposition. He had few real interests at stake in Italy, whither he had been mainly attracted by the love of adventure. Instead of prosecuting the struggle, he sold his prerogatives in each town to the highest bidder he could find, and quitted Italy with his son in 1333. The episode is interesting as throwing light on the character of John, and on the impulsive character of the Italians, but in an indirect way it was of unforeseen importance. The future emperor, Charles iv., never forgot the experience of Italian politics which he had obtained during the two years in which he acted as his father's deputy, and one of the dominant influences which shaped his subsequent policy in Germany (see chapter vi.), was a desire to save that country from falling into the same condition as Italy.

The chief gainers by the overthrow of John of Bohemia were the Ghibelline leaders of the confederacy against him, and especially Mastino della Scala, who not only took his own share of the plunder, but refused to give up Lucca, which should have fallen to Florence. **League against Mastino della Scala.** It was reckoned by contemporaries that only one European prince, the king of France, drew a larger revenue from his subjects than the lord of Verona.

But the rapid growth of his power only served to excite the enmity of his neighbours. Venice was impelled by self-interest to attack a potentate who not only dominated the district from which the republic drew its most available supplies of food, but also commanded the all-important Alpine passes. Florence was eager to punish the ill-faith which withheld from her the coveted possession of Lucca. Marsilio Carrara was tempted by the prospect of recovering the independent lordship of Padua, while Azzo Visconti and the other Lombard despots welcomed the opportunity of destroying the ascendancy in Lombardy which for the last decade had been enjoyed by the Scaligers. The result was the formation of a powerful league which Mastino was unable to resist. In 1338 he was forced to conclude a treaty which put an end to the preponderance of Verona in the north. Venice received Treviso, with the adjacent territory, Castelbaldo and Bassano, thus securing a land fertile in corn and cattle, and at the same time access to the foot of the Alps. The Carrara dynasty was established in Padua as a buffer between Venice and the growing power of the Visconti, who seized Brescia and Bergamo. Only Verona and Vicenza remained to the house of Scala.

But the unfortunate Florentines were again duped of the reward which should have attended their alliance with the Ghibelline princes. Lucca was indeed ceded by Mastino for a money payment, but the Pisans intervened to prevent such an addition to the dominions of their rivals. In 1341 the Pisans defeated the forces of Florence, and in the next year they obtained the surrender of Lucca. This disappointment was the last of a series of disasters which weakened and discredited the government of the *popolo grasso* in Florence (*vide p. 32*). In their chagrin the citizens resorted to the expedient, so familiar in the mediæval history of Italy, of intrusting a temporary dictatorship to a foreigner. Their choice fell upon Walter de Brienne, who had previously been active in Florence as

Walter de
Brienne in
Florence,
1343.

a follower of Charles of Calabria. His ancestors had gained the duchy of Athens at the time when the Fourth Crusade had given to western princes the dominion of the eastern empire, and though his father had been forced to resign in 1312, Walter still called himself Duke of Athens. The temporary military and judicial authority intrusted to the duke failed to satisfy his ambition, and he set himself to establish a permanent despotism in Florence. It was not difficult for him to gain over the *grandi* and the lower classes, who were jealous of the monopoly of power claimed by the wealthy burgesses. With their aid a parliament was convoked which insisted on voting the signory to the duke for his life. But ten months of arbitrary rule sufficed to disgust the most liberty-loving people in Italy, and the nobles and lesser guilds combined with the greater guilds to overthrow the despotism which had risen through the jealousy of classes. Walter de Brienne ordered his hired horsemen to 'course the city,' *i.e.* to gallop along the principal streets and disperse the insurgents. But the citizens had erected barricades to bar the progress of the cavalry, and the duke, besieged in the Palazzo Vecchio, was compelled to abdicate. His fall was followed by con-

Constitu-
tional
changes.

cessions to the *grandi* who had taken an active part in the struggle. The Ordinances of Justice (*vide* p. 32) were repealed, and the office of gonfalonier, whose original function was to enforce the ordinances, was abolished. The government was to be intrusted to twelve priors, three from each quarter of the city; and of these three, one was to be a noble and two burghers. Other offices were also thrown open to the nobles. But the old jealousy of the *grandi* was too deeply seated to allow this arrangement to be permanent. A rising of the mob forced the four noble priors to quit the *palazzo*. The nobles took up arms to defend their cause, but the civil strife was fatal to the power of their whole class. The ordinances, and with them the office of gonfalonier, were

revived, and the only permanent result of the crisis was the extension of political privileges to the *popolo minuto*, or members of the lesser guilds. The number of priors was fixed at eight, two from each quarter, and half the number were to belong to the lesser guilds. The gonfalonier was to be chosen alternately from the two classes of citizens. But while the exclusion of the noble class from office was rendered permanent, some five hundred members of that class were freed from its disabilities by being disennobled and 'raised' to the rank of ordinary burghers.

The martial spirit which enabled the Florentines to defeat the schemes of the Duke of Athens, was by no means common in Italy at the time, and did not endure long even in Florence. The fourteenth century witnessed a change in the military system of

Rise of
Mercenaries
in Italy.

Italy which was destined to exercise the most vital and lasting effects upon the history of the peninsula. In the twelfth and thirteenth centuries the military force of each state had consisted of the male population of the state organised as a militia. The central rallying-point of the army was the *carroccio* or city standard, and the regiments were arranged according to local divisions, or sometimes according to the guild organisation of the city. Such a force was the firmest security for the maintenance of political liberty. But when despots began to overthrow republican independence in most of the communes, their first aim was to disarm their subjects, and to procure troops who had no natural sympathy with the native population. The example was set by Frederick II., whose government of his southern kingdom furnished in many ways a model for the imitation of later rulers. In his struggle with the Popes he incurred great odium by taking Saracens into his pay. The northern despots tried to secure their power by enlisting foreign soldiers under their standard. Each of the successive invasions of Henry VII., Lewis the Bavarian, and John of Bohemia, left behind a number of German adventurers who

were willing to take Italian pay. These men were formed into body-guards by the Visconti and other Italian despots, who were thus enabled to disarm their subjects, and to trample on their liberties. And the republics which retained their independence soon found it necessary to follow the example of the princes. The mercenary troops were for the most part heavy-armed cavalry, and the civic infantry were no match for them in the open field. The republics would only have courted destruction by continuing to employ a force which was inadequate for their defence. Moreover, under the altered conditions of warfare, campaigns were much longer than when the struggle was decided by a single contest between the armed populace of two rival cities. The ordinary citizen could no longer afford to sacrifice his time and his business to do work which he might pay others to do for him. It was cheaper to be heavily taxed for the maintenance of a hired force, than to leave the shop or the counting-house for a protracted campaign. The Florentines soon adopted the custom of employing mercenaries, and in 1351 commuted personal service for a money payment. The Venetians, though they employed native crews and native commanders in their fleet, always hired foreigners to fight their battles on land. One result of the change was that infantry was wholly superseded by heavy-armed cavalry, until the general use of gunpowder, and the intervention of the great powers in Italy, brought about another great change in the art of war.

At first the mercenary troops in Italy were employed as the body-guard of a tyrant, or as the standing army of a republic. **Foreign** But as the leaders of these forces became con-
Condottierl. scious of their power, they began to form independent armies, which might live at the expense of the unwarlike natives, or might acquire wealth by letting out their services to the highest bidder. The first notable instance of such an army was in 1343, when a German, Werner, or, as the Italians called him, Guarnieri, formed the

Great Company. He levied contributions on the states which he entered with his forces, and only occasionally took part in the Italian wars. The same company, or another with the same name, appears in 1353 under the command of Fra Moreale, who was afterwards put to death by Rienzi. When the treaty of Bretigny put an end for a time to the English wars in France, a new flood of foreign adventurers poured into Italy, where they formed the White Company under the famous Englishman, John Hawkwood or Giovanni Acuto. He was distinguished among *condottieri* for the fidelity with which he performed his contracts, and the Florentines expressed their sense of his services by giving him a tomb and a monument in the *Duomo*.

In the earlier part of the fourteenth century the majority of the mercenary soldiers and their commanders were foreigners; in the later part of the century their place was to a large extent taken by native troops and *condottieri*. As the smaller communes were gradually deprived of liberty and of an independent political life by the extension of the larger states, the more energetic and ambitious citizens were only too glad to find an opening for their activity in the career of arms. In 1379 the Company of St. George, into which none but Italians were admitted, was founded by Alberigo da Barbiano, a noble of Romagna. In this company were trained Braccio and Sforza, the founders of the two great schools of Italian commanders in the fifteenth century. That the native troops could be as efficient as the foreigners whom they superseded was proved in 1401, when a German army in the service of the Emperor Rupert was routed by an Italian force which had been hired by the Duke of Milan.

Whatever semblance of unity had been given to Italian history by the continuance of party feuds disappeared altogether in the later part of the fourteenth century, when party allegiance was finally subordinated to the desire of each state for territorial aggrandisement. Chronological

arrangement becomes impossible, and all that can be done is to briefly point out the most notable incidents in the history of the greater states. It will be convenient to begin this survey with the south of the peninsula, and to proceed northwards.

The ambition of Robert of Naples had been moderated by the death of his only son in 1328, and though he continued

Naples. to support the Popes in their quarrel with Lewis the Bavarian, he took very little part in Italian

politics in his later years. The subsequent history of Naples turns for the most part upon dynastic rivalry, and demands an accurate knowledge of genealogy.¹ Robert himself had succeeded his father in 1309 to the exclusion of the stronger hereditary claim of his nephew, Carobert of Hungary. Carobert died in 1342, leaving two sons, Lewis, king of Hungary and afterwards of Poland, and Andrew. Robert, who died in the following year, had no direct descendants except two granddaughters, Joanna and Maria, the children of Charles of Calabria. In the hope of averting strife with the Hungarian branch Robert, before his death, arranged a

Joanna I. and Andrew. marriage between Joanna and her cousin Andrew. But this expedient failed to produce the desired result. Joanna claimed the right of succession to her grandfather, and wished to treat her husband as a mere prince-consort. Andrew, however, insisted on the priority of his own claim as the male representative of the eldest line. The quarrel was complicated by the action of two descendants of Robert's younger brothers, Lewis of Taranto, who was suspected of being Joanna's lover, and Charles of Durazzo, who had married Maria, the queen's younger sister. Both were aspirants for the succession, and while Lewis sided with Joanna, Charles encouraged the Hungarian prince to assert his claims. At last, in 1345, Europe was scandalised by the news that Andrew had been murdered. Suspicion rested from the first upon Joanna and Lewis of Taranto, whom she

¹ See Genealogical Table I, in Appendix.

subsequently married, though it is as difficult to furnish absolute proof of their guilt as in the superficially similar case of Mary Stuart and Bothwell. Lewis of Hungary, however, considered himself justified in accusing Joanna of his brother's murder, and took measures to exact vengeance and, at the same time, to assert his own claim. His expedition was delayed for two years by the intrigues of Pope Clement vi., by the struggle in Germany between Lewis the Bavarian and Charles iv., and by the opposition of the Venetians, always quarrelling with Hungary for the possession of Dalmatia. It was not till the end of 1347 that Lewis was able to make his way overland to Naples. Many of the nobles, including Charles of Durazzo, rallied to his cause, and Joanna was forced to fly to Provence. Lewis was crowned king of Naples, and one of his first acts was to put to death Charles of Durazzo, nominally on a charge of complicity in Andrew's death, but probably because he might prove a dangerous candidate for the throne. The outbreak of the Black Death and difficulties in Hungary compelled Lewis to return northwards, and Joanna seized the opportunity to attempt the recovery of her kingdom. To raise money she sold Avignon to Clement vi., and it remained a papal possession till its annexation to France in 1791. Joanna's return to Naples was followed by a desultory war with the Hungarian party. Lewis returned to uphold his cause in 1350, but he found it practically impossible to hold a kingdom so distant from Hungary, and in 1351 he agreed to a treaty. The question of Joanna's guilt was referred to the Pope, and on his decision in her favour Lewis resigned the Neapolitan crown, magnanimously refusing the money compensation which was offered him by the papal award.

Lewis of
Hungary
invades
Naples.

For the next thirty years the history of Naples was comparatively uneventful. Joanna married two more husbands after the death of Lewis of Taranto, but had no children to survive her. As she grew old the question of the succession became of pressing importance.

Succession to
Joanna I.

Her nearest relative was her niece, Margaret, the daughter of her sister Maria and the Charles of Durazzo who had been put to death in 1348. The latter's brother, Lewis, had left a son, another Charles of Durazzo, who, in 1370, married his cousin Margaret, and was afterwards treated by Joanna as her heir. But in 1378 the Great Schism in the Papacy began, and the queen and her nephew took opposite sides. Joanna was the first and most ardent supporter of Clement VII., whereas Charles of Durazzo, who had been trained and employed by his kinsman, Lewis of Hungary, espoused the cause of Urban VI. The result was a violent quarrel, and Urban encouraged Charles, in 1381, to take up arms against Joanna instead of waiting for the succession. Determined to disinherit her undutiful kinsman, and, at the same time, to gain the support of France, Joanna offered to adopt as her heir Louis of Anjou, brother of Charles V. of France. Louis could trace descent from the Neapolitan house, as his great-grandfather, Charles of Valois, had married a daughter of Charles II. of Naples. The offer was accepted, and from it arose the claim to Naples of the second house of Anjou—a claim which distracted southern Italy for a century, and ultimately passing to the French king, became the pretext for the famous invasion of Charles VIII. in 1494. But for the moment Joanna's action brought her little good. Before aid could come from France she was taken prisoner by Charles, and died in captivity (May 22, 1382). The successful prince was crowned as Charles III. of Naples. His rival, Louis of Anjou, seized one of Joanna's dominions, the county of Provence, which remained in the hands of his descendants. He also led a formidable army to enforce his claim upon Naples, but he was not successful, and died in 1385 without gaining more than the mere title of king.

Charles III. was now firmly established in Naples, but the disturbances in Hungary after the death of Lewis the Great induced him to assert a claim to that kingdom. A momentary

success was followed by his assassination (February 24, 1386). Hungary fell into the hands of Sigismund, and civil war broke out in Naples between the supporters of Ladislas, ^{Ladislas} Charles III.'s son, and Louis II. of Anjou, who ^{and Louis II.} inherited the claims of his father. There is no need to trace the details of the struggle, which after many fluctuations of success ended in the victory of Ladislas. For a few years in the next century Ladislas was one of the most influential and active princes of Italy. On his premature death in 1414, the crown of Naples passed to his sister Joanna II., in whom the direct line of the original Angevin house of Naples came to an end.

It would be tedious, and perhaps impossible, to narrate in detail the history of the Papal States during the residence of the Popes at Avignon and the subsequent schism. ^{Rome and the Papal States.} Under the strongest of the preceding Popes, there had never been any organised central government in the territories which owned their sway. The Popes had been the suzerains rather than the rulers of the States of the Church. Every considerable city was either a republic with its own municipal government, or was subject to a despot who had succeeded in undermining the communal institutions. Even in Rome itself the bishop could exercise little direct authority. Over and over again, the turbulence of the citizens had driven successive Popes to seek a refuge in some smaller town. In fact, the Romans might easily have shaken off papal rule altogether but for two considerations. The Popes drew so much wealth from Latin Christendom that they could afford to levy very light taxes upon their immediate subjects. And the Romans gained enormous indirect profit from the crowds of pilgrims and wealthy suitors who were constantly drawn to the papal court. It is true that this profit was diverted to Avignon in the fourteenth century, but though this was a great grievance to the Romans, it was a reason for demanding the return of the Popes rather than for making the separation permanent. The government of Rome was in

theory republican, but nothing survived from the ancient republic except its memory and its disorder. A Senate had been revived in the twelfth century only to prove a complete failure, and the name of Senator had come to be applied to a temporary magistrate, who was sometimes elected by the citizens but more often nominated by the Pope. A central board of thirteen officers, one from each *rione* or district of the city, was intrusted with the municipal administration, but it had little real authority. Every other commune in Italy had found it necessary to restrict or abolish the privileges of the feudal nobles. But in Rome the Colonnas, the Orsini, and other noble families enjoyed the most lawless independence and treated the citizens with the utmost contempt. The brawls of their retainers filled the streets with disorder, and it was dangerous for the townspeople to resist any outrage either on person or on property. The Popes had rarely been successful in checking the lawlessness of the barons, and now that the Pope was at a distance from Rome all restraint upon their licence seemed to be removed.

It was in these circumstances that a momentary revival of order and liberty was effected by the most extraordinary adventurer of an age that was prolific in adventurers.

Rienzi. Cola di Rienzi was born of humble parents, though he afterwards tried to gratify his own vanity and to gain the ear of Charles IV. by claiming to be the bastard son of Henry VII. A wrong which he could not venture to avenge excited his bitter hostility against the baronage, while the study of Livy and other classical writers inspired him with regretful admiration for the glories of ancient Rome. He succeeded in attracting notice by his personal beauty and by the rather turgid eloquence which was his chief talent. In 1342 he took the most prominent part in an embassy from the citizens to Clement VI., and though he failed to induce the Pope to return to Rome, which at that time he seems to have regarded as the panacea for the evils of the time, he gained sufficient favour at Avignon to be appointed papal

notary. From this time he deliberately set himself to raise the people to open resistance against their oppressors, while he disarmed the suspicions of the nobles by intentional buffoonery and extravagance of conduct. On May 20, 1347, the first blow was struck. Rienzi with a chosen band of conspirators, and accompanied by the papal vicar, who had every interest in weakening the baronage, proceeded to the Capitol, and, amidst the applause of the mob, promulgated the laws of the *buono stato*. He himself took the title of Tribune in order to emphasise his championship of the lower classes. The most important of his laws were for the maintenance of order. Private garrisons and fortified houses were forbidden. Each of the thirteen districts was to maintain an armed force of a hundred infantry and twenty-five horsemen. Every port was provided with a cruiser for the protection of merchandise, and the trade on the Tiber was to be secured by a river police.

The nobles watched the progress of this astonishing revolution with impotent surprise. Stefano Colonna, who was absent on the eventful day, expressed his scorn of the mob and their leader. But a popular attack on his palace convinced him of his error, and forced him to fly from the city. Within fifteen days the triumph of Rienzi seemed to be complete, when the proudest nobles of Rome submitted and took an oath to support the new constitution. But the suddenness of his success was enough to turn a head which was never of the strongest. The Tribune began to dream of restoring to the Roman Republic its old supremacy. And for a moment even this dream seemed hardly chimerical. Europe was really dazzled by the revival of its ancient capital. Lewis of Hungary and Joanna of Naples submitted their quarrel to Rienzi's arbitration. Thus encouraged, he set no bounds to his ambition. He called upon the Pope and cardinals to return at once to Rome. He summoned Lewis and Charles, the two claimants to the imperial dignity, to appear before

The 'good estate.'

Rienzi's triumph and fall.

his throne and submit to his tribunal. His arrogance was shown in the pretentious titles which he assumed, and in the gorgeous pomp with which he was accompanied on public and even on private occasions. On August 15, after bathing in the porphyry font in which the Emperor Constantine had been baptized, he was crowned with seven crowns representing the seven gifts of the Holy Ghost. His most loyal admirer prophesied disaster when the Tribune ventured on this occasion to blasphemously compare himself with Christ. And Rienzi's government deteriorated with his personal character. It had at first been liberal and just; it became arbitrary and even treacherous. His personal timidity made him at once harsh and vacillating. The heads of the great families, whom he had invited to a banquet, were seized and condemned to death on a charge of conspiracy. But a sudden terror of the possible consequences of his action caused him to relent, and he released his victims just as they were preparing for execution. His leniency was as ill-timed as his previous severity. The nobles could no longer trust him, and their fear was diminished by the weakness which they despised while they profited by it. They retired from Rome and concerted measures for the overthrow of their enemy. The first attack, which was led by Stefano Colonna, was repulsed almost by accident; but Rienzi, who had shown more cowardice than generalship, disgusted his supporters by his indecent exultation over the bodies of the slain. And there was one fatal ambiguity in Rienzi's position. He had begun by announcing himself as the ally and champion of the Papacy, and Clement VI. had been willing enough to stand by and watch the destruction of the baronage. But the growing independence and the arrogant pretensions of the Tribune exasperated the Pope. A new legate was despatched to Italy to denounce and excommunicate Rienzi as a heretic. The latter had no longer any support to lean upon. When a new attack was threatened, the people sullenly refused to obey the call to arms. Rienzi had not sufficient courage to

risk a final struggle. On December 15 he abdicated and retired in disguise from Rome. His rise to power, his dazzling triumph, and his downfall were all comprised within the brief period of seven months.

For the next few years Rienzi disappeared from view. According to his own account he was concealed in a cave in the Apennines, where he associated with some of the wilder members of the sect of the Fraticelli, and probably imbibed some of their tenets. Rome relapsed into anarchy, and men's minds were distracted from politics by the ravages of the Black Death. The great jubilee held in Rome in 1350 became a kind of thanksgiving service of those whom the plague had spared. It is said that Rienzi himself visited the scene of his exploits without detection among the crowds of pilgrims. But he was destined to reappear in a more public and disastrous manner. In his solitude his courage and his ambition revived, and he meditated new plans for restoring freedom to Rome and to Italy. The allegiance to the Church, which he had professed in 1347, was weakened by the conduct of Clement VI. and by the influence of the Fraticelli, and he resolved in the future to ally himself with the secular rather than with the ecclesiastical power, with the Empire rather than with the Papacy. In August 1351 he appeared in disguise in Prague and demanded an audience of Charles IV. To him he proposed the far-reaching scheme which he had formed during his exile. The Pope and the whole body of clergy were to be deprived of their temporal power; the petty tyrants of Italy were to be driven out; and the emperor was to fix his residence in Rome as the supreme ruler of Christendom. All this was to be accomplished by Rienzi himself at his own cost and trouble. Charles IV. listened with some curiosity to a man whose career had excited such universal interest, but he was the last man to be carried away by such chimerical suggestions. The introduction into the political proposals of some of the religious and communistic ideas of the Fraticelli gave the king a pretext for committing Rienzi to the Archbishop of

Prague for correction and instruction. The archbishop communicated with the Pope, and on the demand of Clement vi. Charles agreed to hand Rienzi over to the papal court on condition that his life should be spared. In 1352 Rienzi was conveyed to Avignon and thrust into prison. He owed his life perhaps less to the king's request than to the opportune death of Clement vi. in this year.

The new Pope, Innocent vi., was more independent of French control than his immediate predecessors. The French king was fully occupied with internal disorders, and with the English war. Thus the Pope was able to give more attention to Italian politics, which were sufficiently pressing. The independence and anarchy of the Papal States constituted a serious problem, but the danger of their subjection to a foreign power was still more serious. In 1350 the important city of Bologna had been seized by the Visconti of Milan, and the progress of this powerful family threatened to absorb the whole of the Romagna. Innocent determined to resist their encroachments, and at the same time to restore the papal authority, and in 1353 he intrusted this double task to Cardinal Albornoz. Albornoz, equally distinguished as a diplomatist and as a military commander, resolved to ally the cause of the Papacy with that of liberty. His programme was to overthrow the tyrants as the enemies both of the people and of the Popes, and to restore municipal self-government under papal protection. His attention was first directed to the city of Rome, which, after many vicissitudes since 1347, had fallen under the influence of a demagogue named Baroncelli. Baroncelli had revived to some extent the schemes of Rienzi, but had declared openly against papal rule. To oppose this new

Albornoz in Italy. **tribune, Albornoz conceived the project of using the influence of Rienzi, whose rule was now regretted by the populace that had previously deserted him. The Pope was persuaded to release Rienzi from prison and to send him to Rome, where the**

Rienzi's return and death, 1354.

effect of his presence was almost magical. The Romans flocked to welcome their former liberator, and he was re-installed in power with the title of Senator, conferred upon him by the Pope. But his character was not improved by adversity, and his rule was more arbitrary and selfish than it had been before. The execution of the *condottiere*, Fra Moreale, was an act of ingratitude as well as of treachery. Popular favour was soon alienated from a ruler who could no longer command either affection or respect, and in a mob rising Rienzi was put to death (October 8, 1354). But his return had served the purpose of Albornoz. Rome was preserved to the Papacy, and the cardinal could proceed in safety with his task of sub-
Recovery
of the Papal
States.
duing the independent tyrants of Romagna.

Central Italy had not yet witnessed the general introduction of mercenaries, and the native populations still fought their own battles. The policy of exciting revolts among the subject citizens was completely successful, and by 1360 almost the whole of Romagna had submitted to the papal legate. His triumph was crowned in this year, when, by skilful use of quarrels among the Visconti princes, he succeeded in recovering Bologna.

But the successes of Albornoz appeared more like the conquests of a foreign power than the restoration of a legitimate authority. The long residence in
Return of
the Popes
to Rome.
Avignon had alienated Italian sympathies from the Papacy. The Visconti embarked in open war with the Popes after the fall of Bologna, and they had many advantages on their side. The ecclesiastical thunders which had frightened Lewis the Bavarian into submission had no terrors for Italian princes. When Bernabo Visconti received a bull of excommunication from the Pope, he forced the legates to eat the parchment and the leaden seal. It was evident that nothing but a return to Italy could render permanent the restored secular authority of the Popes. Urban v., who succeeded Innocent vi. in 1362, was induced

by the arguments of Albornoz and the personal influence of Charles iv. to disregard the prejudices of the cardinals, and in 1368 he entered Rome, where he was joined by the emperor. But Urban was soon discouraged by the death of Albornoz, and the obvious weakness of imperial support. He had no natural interests in Italy, which was a foreign country to him, and he found Rome quite as uncomfortable a place of residence as it had been represented. In 1370 he embarked for Marseilles, and returned to Avignon. His departure had the most disastrous results. Papal authority was repudiated by the cities of Romagna, and the Visconti hastened to take advantage of the altered conditions. Even Gregory xi., who had been chosen by the cardinals as the least likely candidate to quit Avignon, found it necessary to follow his predecessor's example and return to Italy. But his experience in Rome convinced him that the enterprise was hopeless, and his departure was only prevented by his death (March, 1378). The choice of an Italian, Urban vi., as his successor was a partial concession to the violence of the Roman mob. On the first pretext the French cardinals deserted their nominee, and the election of a rival Pope, Clement vii., inaugurated the Great Schism which lasted for forty years. During this period the temporal authority of the Papacy was again annihilated, and it was not till the Council of Constance had restored unity in 1418 that its revival could once more be seriously undertaken.

The history of Florence in the fourteenth century is filled with a continuous struggle of classes and families for political ascendancy. Though the details of the struggle are complicated and wearisome, it is necessary to pay some attention to its general character in order to understand the conditions under which the later authority of the Medici grew up. The expulsion of the Duke of Athens had been followed by a settlement by which the *grandi* were excluded from political power, which was to be shared

between the members of the greater and the lesser guilds. But as time went on, and the memory of previous disasters was effaced, the *popolo grasso* began to aim at the ^{Class} recovery of their former preponderance in the ^{jealousies.} city. To propose a direct change of the constitution might provoke a rising of the artisans, so it was decided to obtain the desired end by indirect methods. A law of 1301, of which it was forbidden to propose the revocation under heavy penalties, decreed that a Ghibelline, or any man suspected of not being a true Guelf, was to be incapable of holding office. For the carrying out of this law there grew up the practice of *ammonizio*, which has been called the ostracism of Florence. If a charge of Ghibellinism were brought against a man, and supported by six witnesses, who swore to public report, the priors were bound to admonish the accused, and any person thus admonished (*ammonito*) was excluded from office. His name was not placed in the bags, or if it were already included, it was put on one side when drawn out and another name drawn in its place. This party device was now employed by the wealthy burghers to recover a monopoly of power for their class. By systematically bringing a charge of Ghibellinism against the members of the lesser guilds who were likely to obtain office, their exclusion could be effected without any open assertion of disqualification. In carrying out this policy the plutocrats were aided by the organisation of the *parte Guelfa* (*vide p. 35*), which was the stronghold of oligarchical interests within the republic. The accusations were managed by the captains of the *parte*, and they could always find the necessary six witnesses. The pretext for so strict an enforcement of the law against Ghibellinism was found in the two Italian visits of Charles IV. in 1353 and 1368, though the emperor did nothing whatever to excite the alarm of the Guelfs.

No sooner had the wealthy burghers won their victory by the abuse of what should have been a legal proceeding, than they were divided by the family quarrel of the Albizzi and

the Ricci. Both families belonged to the *popolo grasso*, and their feud had at first none of the political significance which came to be associated with it. In fact, **The Albizzi and Ricci.** the Ricci were the first to urge the harsh enforcement of the anti-Ghibelline laws, hoping to discredit their opponents, who came originally from the Ghibelline town of Arezzo. But the Albizzi succeeded in gaining the support of the *parte Guelfa*, and were thus enabled to turn the tables on their rivals. The *ammonizio* was as useful a weapon against the Ricci faction as against the *popolo minuto*. By 1374 the Albizzi and their supporters had got the government into their hands. But the indiscreet violence of their proceedings provoked serious opposition. The *ammoniti*, constantly increasing in number, became more and more formidable. The desire for office, such a passion among the Florentines, was due not merely to ordinary ambition, but also to the fact that the taxes were assessed by the arbitrary will of the state officials. The dominant faction, however, failed to appreciate the dangers that confronted them, and in seven months of 1377 more than eighty persons were admonished. This recklessness brought about their ruin. In May 1378, Salvestro de' Medici, who belonged to the Ricci party, was drawn as gonfalonier. The bags were so depleted that the possibility of his selection was foreseen, but his attachment to Guelf principles was so well known that it was considered unsafe to accuse him. In his second month of office he proposed a law to lessen the power of the *parte Guelfa*, and to facilitate the recovery of civic rights by the *ammoniti*. As the scheme was opposed in the council, one of Salvestro's supporters, Benedetto Alberti, called the people to arms, and the law was carried under the pressure of mob violence.

The result was an unforeseen revolution. The Ricci **Rising of the Ciompi, 1378.** had been driven by common grievances into an alliance with the lesser guilds, but the demand for redress was taken up by the *Ciompi*, the lowest class of all. They were influenced, not so much by the wish

to obtain political power as by the desire to extort better terms from their employers. Their movement was half revolution and half strike. The rising of the mob, which speedily passed beyond the control of those who had called in its aid, might have destroyed the foundations of the state but for the action of a poor wool-comber, Michel Lando, who was raised to the office of gonfalonier by the accident of popular caprice. He succeeded in suppressing disorder, while he satisfied the more rational demands of his own class. A number of new guilds were formed of artisans who had hitherto been unorganised. Of the eight priors, three were to be taken from the *arti maggiori*, three from the *arti minori*, and two from the new guilds. After effecting this settlement, Lando, with a modesty as rare as the untaught statesmanship he had displayed, resigned his office. His retirement left the chief power in the hands of the party which had started the movement, but had been unable to control its course. Salvestro de' Medici had disappeared from public life. Though he was only a distant relative of the later Medici, his career served to associate the family name with the popular cause, and to give them a cue for the policy they afterwards pursued. The leadership of his party fell into the hands of a triumvirate, consisting of Benedetto Alberti, Tommaso Strozzi, and Giorgio Scali. Alberti was a fairly moderate politician, but his two associates were ambitious demagogues, who imitated the abuses of the Albizzi, and employed the *ammonizio* to rid themselves of their personal enemies. The inevitable reaction set in in 1382. A hostile *signoria* came into office, and a servant of Giorgio Scali was arrested on a charge of bearing false witness. Strozzi fled from the city, but Scali, trusting in the favour of the mob, determined to resist. His attempt to rescue his servant was a failure, and he himself was seized by the priors. The populace would not rise on his behalf, and he was put to death. A counter-revolution undid all the

Counter-
revolution
in 1382.

changes of 1378. A *balia* constituted by a parliament abolished the new guilds, and decreed that the priors should be chosen, four from the greater, and four from the lesser guilds. The gonfalonier was always to belong to the former, who thus secured a majority in the signory. The Albizzi and other exiles were recalled to the city.

For the next fifty years after 1382, Florence was ruled by an ever-narrowing oligarchy. First, the greater guilds recovered a practical monopoly of office. Later, certain members of these guilds obtained such complete ascendancy that the government almost ceased to be a republic, and thus the way was prepared for the absolutism of the Medici. In 1387 Benedetto Alberti, the most blameless of the leaders in 1378, was driven into exile. A new *squittinio* filled the bags with the names of partisans of the dominant faction. A separate bag was formed for the chief leaders of the faction, and two priors were to be drawn from among them (*Priori del Borsellino*). Six of the priors were to belong to the greater guilds, and only two to the lesser. In 1393 Maso Albizzi, the leader of the oligarchy, held the office of gonfalonier, and further measures were taken to strengthen its supremacy. If a gonfalonier were drawn who was displeasing to the rulers, another was to be drawn in his place, though the former was to remain one of the priors. Three priors instead of two were to be taken from the *borsellino*, or special bag. The signory was allowed to raise troops, and to levy taxes for their payment, without having to obtain the consent of the councils. These measures provoked a rising among the artisans. The rioters repaired to the house of Vieri de Medici, and invited him to lead them against the Albizzi. Vieri, who was a kinsman of Salvestro de' Medici, refused the offer of the mob, and the movement was suppressed. In 1397 another rebellion, in which two members of the Medici family were concerned, was also put down, and the rule of the dominant oligarchy was more firmly established than ever.

Oligarchical
rule in
Florence.

The great characteristic of this period of oligarchical government is the activity and aggressiveness of the republic in its external relations. Before 1342 Florence had acquired the rule of considerable territories beyond the limits of its own *contado*, but most of these dominions were lost in the disturbances which accompanied the expulsion of the Duke of Athens. The great service which the oligarchy rendered to Florence was the recovery of its ascendancy in northern Tuscany. Prato, Pistoia, Volterra, San Miniato, and several lesser towns were acquired between 1350 and 1368. In 1387 the important town of Arezzo was sold to the Florentines by Enguerrand de Coucy, who had held it as the lieutenant of Louis of Anjou. For some years after this the growth of Florence was checked by a desperate war against the encroachments of Gian Galeazzo Visconti, who threatened to unite Tuscany and Lombardy under his rule. It was in this war that Sir John Hawkwood commanded for Florence against the Milanese *condottiere*, Jacopo del Verme. After Hawkwood's death in 1394, the republic was for a time in serious danger. To save their independence, the Florentines took the unusual step of appealing for German assistance, and urged the Elector Palatine, Rupert, who had been elected king of the Romans in opposition to Wenzel of Bohemia, to make war against the lord of Milan. The defeat of the German army at the battle of Brescia left Florence in greater straits than ever, when the sudden death of Gian Galeazzo in 1402 not only saved the Florentines from Milanese aggression, but enabled them to resume their policy of expansion. Within the next twenty years Pisa, Cortona, and Livorno had been added to the dominions of Florence.

In northern Italy the fourteenth century witnessed the final struggle between the two great maritime republics, Venice and Genoa. Ever since the beginning of the Crusades they had been rivals for commercial and political ascendancy in the Levant. At first the

Growth of
Florentine
dominions.

Venice and
Genoa.

advantage had been on the side of the Venetians, and the diversion of the Fourth Crusade in 1204 to attack the Eastern Empire had given them a dominant position in the islands and coasts of the Ægean. But the Genoese had their revenge in 1261, when they aided to overthrow the Latin Empire, and to establish Michael Palæologus in Constantinople. As a reward for their services they received the suburb of Pera with the fortress of Galata, whence they could dictate to the occupants of the imperial throne. The control of the straits enabled them to assume a virtual monopoly of the trade of the Black Sea, and their port of Kaffa in the Crimea became one of the most flourishing cities in the east. Pisa, which had once been the equal or even the superior of Genoa, lost all maritime importance after the battle of Meloria (1284).

For the next century Venice and Genoa contended on fairly equal terms. In wealth and maritime power they were evenly matched. Genoa had most of the northern trade that passed through the Black Sea and Constantinople; but Venice, which held Negropont, Crete, and other islands, had the advantage in the other two channels of eastern trade, through Asia Minor and Egypt. Genoa, however, was ready to seize any opportunity of contesting this southern trade with her rival. The occupation of Chios gave her a valuable port in the Ægean. Cyprus, which became an important commercial centre after the fall of Acre (1291), was the scene of many conflicts between the two republics. The people and the ruling house of Lusignan favoured Venice, but the Genoese went to war to secure their interests, and the seizure of Famagusta in 1373 gave them for some time the upper hand in Cyprus. On the African coast they also succeeded in establishing trade settlements. Farther west, the Genoese had several things in their favour. The occupation of Corsica gave them a great addition of maritime strength, though their dispute with Aragon for the possession of Sardinia exposed them to the enmity of the Catalans, who ranked

after Venice and Genoa as the third naval power in the Mediterranean. On the mainland the mountains which confined Genoa to a narrow strip of coast, and prohibited territorial expansion, served also to protect her from continental enemies. Venice, on the other hand, ever since the war with Mastino della Scala had given her territories on the mainland, was exposed to the hostility of her neighbours, especially the kings of Hungary and the lords of Padua. If these states were allied with Genoa, Venice ran the risk of being cut off from supplies both by sea and land. As against this balance of strength in east and west, there was one important difference between the two states which ultimately turned the scales decisively in favour of Venice. By the beginning of the century she had built up a constitution which, whatever its narrowness and other defects, had the supreme merit of stability. The so-called conspiracy of Marin Falier, which led to the execution of the Doge in 1355, only served to prove the strength of the edifice which he proposed to attack, and the impotence of the chief magistrate to resist the Council of Ten. Genoa, on the other hand, was one of the most turbulent and factious of Italian cities. For a long time the leaders of these domestic feuds were the four noble houses of Doria, Fieschi, Spinola, and Grimaldi, who disguised their family jealousies under the names of Ghibelline and Guelf. In 1339 the Genoese, weary of their factions, adopted for their chief magistracy the title of Doge, and conferred it by acclamation upon an eminent citizen, Simone Boccanegra. After the fashion of Florence and other Tuscan communes, the nobles were disqualified from holding political office. But in Genoa the remedy proved wholly illusory. The nobles continued to command the military and naval forces of the republic, and were thus enabled to retain their predominance in the state. The offices, which they could not hold themselves, were conferred upon their plebeian adherents, as the Adorni and Fregosi, who for a long time succeeded each other in the dogeship according to the

fluctuations of power among their noble patrons. As Commynes tells us, 'the nobles in Genoa could appoint a doge, though they could not hold the office themselves.' Thus Genoa continued to be distracted by factions, and when the citizens sought a brief interval of repose, the only method by which they could secure it was to sacrifice their liberty to a foreign ruler—sometimes to Milan, and sometimes to France.

The attempt of the Genoese merchants at Kassa to exclude the Venetians from the lucrative free trade with the Tartars led to numerous quarrels in the Black Sea, and ultimately to open warfare between the two states. Venice secured the support of John Cantacuzenos, the Greek Emperor, who disliked Genoese dictation at Pera, and of Peter of Aragon, who was contending with Genoa for the possession of Sardinia. In 1352 Niccolo Pisani, with a powerful fleet of Venetian, Greek, and Catalan vessels, sailed to attack Pera, which was defended by the Genoese admiral, Paganino Doria. In the narrow waters of the Bosphorus the allies were unable to make full use of their numbers, and a furious storm threw their vessels into such disorder that they did more harm to each other than to the enemy. Pisani was forced to retire, but Doria, though victorious, had suffered such losses that he was superseded by Antonio Grimaldi. In 1353 the Aragonese, who had fewer interests in the Levant than their allies, insisted upon transferring hostilities to the coast of Sardinia. In the open water off Cagliari the Venetians and Catalans gained a complete victory, and Grimaldi with difficulty escaped to carry the news of this crushing disaster to Genoa. Pisani was too weakened by the encounter to venture a direct attack upon Genoa, but the Genoese were so panic-stricken that they offered the lordship of the city to Giovanni Visconti, in order to gain the aid of Milan. Venice replied to this move by an alliance with the opponents of Milan on the mainland, but the struggle continued to be fought out at sea. Paganino

War of
Venice and
Genoa, 1350-5.

Doria, restored to the command after Grimaldi's defeat, once more carried the war into eastern waters. Pisani, after an uneventful campaign in 1354, had retired into winter quarters at Portolungo on the coast of the Morea, under the shelter of the island of Sapienza. There the Venetians were surprised by Doria, and their fleet was completely annihilated (November 4, 1354). The battle of Sapienza was the most decisive engagement of the struggle. It was followed by the conspiracy and death of Marin Falier, and the Venetians were so discouraged by the combination of external defeat and domestic treason that they concluded peace with Genoa in 1355. All demands for concessions in the Black Sea were abandoned, and Genoa retained its superiority in the northern trade.

For the next twenty years the two republics remained at peace with each other. Genoa succeeded in throwing off the Milanese yoke in 1356, with the result that the factions resumed their quarrels. Venice became involved in a war with Lewis the Great of Hungary (1356-8), in which Dalmatia was lost and Treviso was only retained with difficulty. This was followed by a revolt in Crete which was put down (1364), and by almost continuous quarrels with Francesco Carrara of Padua. These events forced the Venetians to maintain a policy of peace in the east. Even the war of 1373 in Cyprus, which subjected that island to the suzerainty of Genoa, failed to provoke more than a verbal protest from Venice. But events in the Eastern Empire at last drove the two republics to resume hostilities. John Palæologus had promised to Venice the rocky island of Tenedos, which commanded the entrance to the Hellespont. The Genoese, regarding this as threatening their security in Pera, organised a palace revolution in Constantinople, and seated Andronicus on the throne in place of his father. In return for this aid the usurper ceded Tenedos to his allies. But the governor of the island refused to recognise the authority of Andronicus, and handed his charge over to the Venetians. This was the immediate

occasion for war. Vettor Pisani, in 1378, defeated the Genoese fleet off Cape Antium, and cleared the Adriatic of the pirates who plundered Venetian commerce. The winter he spent in the harbour of Pola, and was still there when he was confronted by Luciano Doria in command of another Genoese force (May 7, 1379). In the battle which followed Pisani was completely defeated, and was sentenced by the indignant Venetians to six months' imprisonment and exclusion from any command for five years. Pietro Doria, the successor of Luciano who had been killed in the engagement, led the victorious fleet to the lagoons of Venice. The town of Chioggia, which commanded one of the main entrances from the open sea, was taken after an obstinate defence, and the way was opened to Venice itself. A prompt attack would probably have been successful, but Doria preferred the slower and surer method of a blockade. In this he reckoned upon the aid of Francesco Carrara, who eagerly welcomed the opportunity of humbling the formidable republic, and undertook to prevent the transit of supplies from the mainland.

Never had the Venetians been in such a strait, but the courage of the citizens rose to meet the danger. Every vessel in Venetian waters was equipped and manned, and Vettor Pisani, the idol of the sailors, was released from prison to assume the chief command. Messengers were sent eastwards to recall Carlo Zeno, who had been despatched to the Levant at the beginning of the war with the second Venetian fleet. Meanwhile Pisani undertook the defence of Venice and gradually drove the Genoese back to their stronghold of Chioggia. There he determined to shut them in by blocking the main outlets to the sea. Ships full of stones were sunk in the channels of Brondolo, Chioggia, and Malamocco, and thus the blockaders were in their turn blockaded. But Pisani's force was hardly strong enough to maintain the blockade during the storms of winter. If reinforcements came from Genoa he would be forced to retire, and Venice would once more be in imminent

War of
Chioggia,
1378-81.

danger. So conscious were the Venetian leaders of the risk of ultimate defeat that they even discussed the possible abandonment of their islands and the transference of the republic to Crete. On the 1st of January 1380 sails were seen in the distance, but as they approached they proved to be the long-expected fleet of Zeno. This sealed the fate of the Genoese in Chioggia. Every effort to force a passage, or to cut a canal through the low-lying barrier between them and the sea, was foiled by the vigilance of the besiegers, and on June 24 the whole of the Genoese force was compelled to capitulate.

By the fall of Chioggia Venice secured a magnificent and permanent triumph over her great Italian rival. The naval power of Genoa never recovered from the blow which it then received, and commercial superiority could only be maintained by maritime ascendancy. Chagrined at such a sudden change from anticipated triumph to humiliating defeat, distracted by domestic feuds, and perpetually endangered by the aggressive policy of Milan, the Genoese sought to escape from their troubles by accepting the suzerainty of Charles vi. of France, and admitting a French governor into the city (1396). For the next century Genoa enters into history mainly as an object of contention between France and Milan, and the greatness of the republic perished with its independence.

But Venice had to pay more than one heavy penalty for her success. In the east the war of the two republics had been suicidal. In their mutual jealousy they had completely lost sight of their common interest in upholding the Eastern Empire against the Turks. The struggle between Venice and Genoa was among the chief causes of the rapid growth of the Ottoman power, which was destined to be fatal to both the contending states. The more Venice gained in the east by the decline of Genoa the more she stood to lose to the advancing Turks; and nearer home the struggle was costly to Venice. By the peace of

*Decline of
Genoa.*

*Venice after
the War.*

Turin, in 1381, she had to confirm the cession of Dalmatia to Hungary, to resign the island of Tenedos, which had been the occasion of the war, and to give up Treviso and all other possessions on the mainland of Italy. All that she had gained in the contest with the Scaligers was lost again. It is true that Treviso was ceded to Leopold of Hapsburg in order to disappoint Francesco Carrara, whose aggrandisement would be much more dangerous to Venice. But Leopold had too much to engage his attention in Germany to be keenly interested in Italian territories. Five years later he sold Treviso, with Feltre and Ceneda, to Carrara, who thus obtained that control over the approaches to the Alpine passes which had driven Venice to make war on Mastino della Scala. For the second time Venice was forced by the same danger to take an active part in the politics of northern Italy. There was one obvious method of humbling the house of Carrara, and that was to invite the intervention of Gian Galeazzo Visconti, who required the annexation of Padua to complete his supremacy in Lombardy. On the other hand, such a policy involved the equally obvious danger that the lord of Milan would prove a far more formidable neighbour than the lord of Padua. To understand the course of action adopted by Venice in this dilemma it is necessary to turn to the history of Milan.

At the beginning of the fourteenth century the lordship of Milan was disputed by two families, the della Torre and the The Visconti in Milan. Visconti. The supremacy of the latter was established in 1312 when Henry VII. conferred the title of imperial vicar upon Matteo Visconti. Of Matteo's numerous family four sons deserve mention: Galeazzo, Lucchino, and Giovanni, who all ruled in Milan, and Stefano, who died in 1327 without obtaining power, but whose children subsequently came to govern. Galeazzo, the eldest son, who succeeded his father in 1322, was deposed by Lewis the Bavarian in 1327, and died in the following year at the siege of Pistoia. His son Azzo recovered, in 1329, the sovereignty

of Milan, and the title of imperial vicar. He proved a successful ruler, and by joining in the successive leagues against John of Bohemia and Mastino della Scala, he extended his authority over the greater part of central Lombardy. On his early death in 1339 his uncle Lucchino succeeded to the lordship over Milan, Bergamo, Brescia, Cremona, Lodi, Piacenza, Vercelli, Novara, and a less complete sovereignty over Pavia. To these dominions Lucchino added Parma in 1346, and Tortona, Alessandria, and Asti in 1347. On the west these territories were bounded by the dominions of the Marquis of Montferrat and the Count of Savoy; while on the east they were separated from Venice and the States of the Church by the possessions of four tyrants of lesser power—the Gonzagas in Mantua, the house of Este in Ferrara, the della Scala in Verona and Vicenza, and the Carrara in Padua. On the death of Lucchino in 1349 his dominions passed to his younger brother Giovanni, who had entered the Church, and had received from Benedict XII. the archbishopric of Milan. In spite of his ecclesiastical position Giovanni did not scruple to aggrandise himself at the expense of the Papacy. In 1350 he induced the Pepoli, who had made themselves lords of Bologna, to cede that city to him. This advance from Lombardy into central Italy made a profound impression on contemporaries, and completely altered the position of the Visconti. It marked the beginning of a prolonged quarrel with the Papacy, and it alarmed Florence and the Tuscan communes for their independence. In 1353 the defeat of Genoa in her naval war with Venice led to the temporary submission of the Ligurian republic to Milanese rule. This was the last great triumph of the militant archbishop, who died suddenly in 1354.

The house of Visconti was now represented by the three sons of Stefano: Matteo, Bernabo, and Galeazzo. They agreed to divide their uncle's dominions between them, but to keep the two chief cities of Milan and Genoa under their joint rule. Matteo, who was vicious and debauched even

beyond the standard of the Visconti, was assassinated by order of his brothers in 1355, and Bernabo and Galeazzo divided his share between them. On the whole their joint rule was wonderfully harmonious, though in later life they fell rather apart and adopted different residences—Bernabo in Milan and Galeazzo in Pavia. Few pictures are more repulsive than that which has been handed down of the domestic government of the two brothers. In the midst of lavish profusion and ostentatious patronage of men of letters, they ruled their subjects with a rod of iron. State criminals, instead of immediate execution, were publicly tortured for forty days according to a fixed daily programme. The game laws were enforced with atrocious severity even for those days. A peasant who had killed a hare was given to Bernabo's hounds to be devoured by them. Yet these bloodthirsty despots, belonging to an upstart family and without any recognised or legal title in their dominions, were allowed to ally themselves by intermarriage with the greatest dynasties in Europe. They were the richest rulers of their time, and their wealth induced even kings to shut their eyes both to the cruelty of their rule and to their ignoble origin. Bernabo married his daughter Verde or Virida to the Leopold of Hapsburg who afterwards fell in the battle of Sempach. Galeazzo obtained for his son, Gian Galeazzo, the hand of Isabella, daughter of John of France, with the county of Vertus in Champagne; and his daughter Violante was married to Lionel of Clarence, the second son of Edward III. of England.

In spite of these alliances, which gave to the Visconti a unique position among the despots of northern Italy, the rule of the two brothers was by no means uninterruptedly successful. Genoa revolted in 1356 and recovered its freedom. Cardinal Albornoz, who was engaged in restoring papal authority in the Papal States, organised a league among the northern despots, the Gonzagas, the della Scala, the Marquis of Montferrat, and all who

**Bernabo and
Galeazzo
Visconti.**

**Milanese
reverses.**

were jealous of Visconti ascendancy. Pavia recovered its independence for two years under the encouragement of a republican monk, Jacopo Bussolari, but was compelled to surrender to Galeazzo in 1359. Asti, Novara, Como, and other western towns were for a time wrested from Visconti rule by the Marquis of Montferrat. A more serious loss was that of Bologna. Giovanni d'Oleggio, who had been appointed governor of the city by Giovanni Visconti, refused to acknowledge the authority of the latter's nephews. When Bernabo endeavoured to compel his submission in 1360, Oleggio balked him by surrendering Bologna to Albornoz. The successes of the papal legate and the return of Urban v. to Rome seemed for a moment to render hopeless any extension of the rule of the Visconti beyond the limits of Lombardy. But Albornoz died in 1368, Urban returned to Avignon in 1370, and a general revolt in Romagna against papal rule restored to the Visconti the advantages which for a moment they had lost. It was not, however, Bernabo Visconti who profited by these changes, but a new and more famous member of the family.

In 1378—an eventful year in Italian history—Galeazzo Visconti died, leaving his share of the family dominions to his only son, Gian Galeazzo. Fearing the ambition of Bernabo, who might well desire to provide for his numerous children at his nephew's expense, the young prince ruled in Pavia with such ostentation of piety and moderation that his uncle deemed him a harmless simpleton. Having thus disarmed all suspicion, Gian Galeazzo decoyed his uncle from Milan to a friendly interview, consigned him to a prison which he never left alive, and reunited the territories of Bernabo with his own (1385). To the cruelty and unscrupulousness of his predecessors, Gian Galeazzo added a dogged resolution and a capacity for intrigue which enabled him to attain a height of power beyond their most sanguine dreams. Personally he was so timid that a sudden sound excited a terror which he could

not conceal. But his lack of courage—an unusual defect among Italian tyrants—proved no bar to his ambition. His wealth enabled him to attract to his service most of the ablest *condottieri* of the age, and to purchase from them a fidelity which was quite uncommon. Himself the husband of a French princess, he drew closer the connection with France by marrying his daughter, Valentina, to Charles vi.'s brother, Louis of Orleans (1389). The bride brought to the Orleans family not only the town of Asti as her dowry, but also an eventual claim to the succession in Milan which was fraught with most momentous consequences to Europe. A few years later Gian Galeazzo succeeded in removing one great defect in the dignity of the Visconti by obtaining from Wenzel, king of the Romans, the formal creation in his favour of a hereditary duchy of Milan (1395).

The great ambition of Gian Galeazzo Visconti was to found a kingdom of northern Italy, and circumstances were His schemes. so extraordinarily favourable that he very nearly succeeded in gaining his object. The two great Guelf powers, Naples and the Papacy, might naturally be expected to oppose such a design. But the Papacy was in the throes of the Schism, and Naples was the scene of civil strife between the two houses of Anjou. Of the three leading republics whose independence was directly threatened, Genoa was powerless. Florence was hampered by the jealousy of Siena, Perugia, and other communes in Tuscany and Romagna, while Venice had for the moment more immediate enemies than Milan, and might be bribed to aid in their destruction. The empire was in the feeble hands of Wenzel, France in the equally feeble hands of Charles vi., and both princes were allied with the Visconti. There seemed to be hardly any danger either of foreign intervention or of efficient resistance in Italy.

The first task which Gian Galeazzo undertook was the reduction of eastern Lombardy. A quarrel between Francesco Carrara and Antonio della Scala gave him his opportunity.

He offered his aid to both princes, but ultimately concluded a treaty with Carrara in 1387 by which Verona was to go to himself and Vicenza to Padua. Both cities were easily taken by Gian Galeazzo's troops, and the once famous house of della Scala was ruined.

Conquest of
Verona and
Padua.

But the lord of Milan kept Vicenza as well as Verona, and Carrara perceived too late that he had only hastened his own downfall. Venice was eager to punish the neighbour who had done all he could for her destruction in the wars both with Hungary and with Genoa. In spite of the obvious danger of aggrandising Milan, Venice agreed to a partition of the territories of Carrara. Resistance to such a combination was hopeless; Padua was compelled to surrender to Milanese rule, and Treviso and the marches were handed over to Venice (1388). The supremacy of Gian Galeazzo in Lombardy was now uncontested. The remaining princes of Savoy, Montferrat, Mantua, and Ferrara, were all, for one reason or another, his humble vassals.

In 1389 Gian Galeazzo was free to turn his attention to Tuscany and Romagna, where his ambition seemed to be equally favoured by internal dissensions. Siena, Perugia, and a number of petty lords in Romagna joined in a league against Florence, whose fall would have assured the supremacy of Milan. But the Florentine oligarchy served the republic faithfully in this hour of danger. Sir John Hawkwood was taken into the service of Florence, and the Count of Armagnac was bribed to bring a body of French troops to aid the republic. Visconti had engaged the most eminent Italian leaders, Jacopo dal Verme, Facino Cane, and others, and the numerical superiority of their troops might have gained an ultimate victory. Armagnac was defeated and slain, and this disaster compelled Hawkwood, who had invaded Lombardy as far as the Adda, to conduct a difficult and hazardous retreat. But the balance was turned against Milan by a wholly unexpected reverse in the north. The younger Francesco Carrara, who

War with
Florence,
1390-2.

had been imprisoned with his father after the fall of Padua, succeeded in escaping. After hairbreadth escapes and the most romantic wanderings over Europe, he succeeded in getting supplies of money from Florence and of men from Bavaria. With a small body of followers he entered Padua by the bed of the Brenta in June 1390. The citizens welcomed his return, and the rule of Milan was overthrown. This revolution in Padua was a great blow to Gian Galeazzo. It compelled him to withdraw part of his forces from Tuscany, and in 1392 he decided to postpone his southern enterprise and to conclude a treaty. Padua was left in the hands of Francesco Carrara on condition of paying tribute to Milan; Florence was to abstain from intervention in Lombardy, and Gian Galeazzo from intervention in Tuscany.

The treaty of 1392 was followed by a few years of troubled peace, broken by only a brief renewal of hostilities in 1397, which was ended by another treaty in 1398. During these years Gian Galeazzo continued to prosecute his schemes by diplomacy and intrigue.

In 1394 a revolution was effected in Pisa and the lordship of the city acquired by Jacopo d'Appiano, who was notoriously in the pay of Milan. Five years later, Appiano's son completed the bargain by handing over Pisa to Gian Galeazzo in return for the principality of Piombino. Genoa only escaped a similar fate by a voluntary submission to France in 1396. Siena in 1399, Perugia and Assisi in 1400, sought to escape the disorders of faction by accepting the rule of Milan. Everywhere republican liberties seemed destined to give way to the advance of despotism. Paolo Guinigi, with the help of Milanese gold, made himself lord of Lucca in 1400, and in the next year Giovanni Bentivoglio became the master of Bologna. Slowly but surely the toils were being drawn round Florence, and the league which she had formed for the defence of liberty was wholly broken up. Hawkwood had died in 1394, and no leader of equal merit could be found except in the service of Milan. A momentary prospect of relief was offered

Successes
of Gian
Galeazzo.

when the princes of Germany in 1400 deposed the incapable Wenzel and gave the kingship of the Romans to the Elector Palatine, Rupert III. Rupert undertook to invade Italy and to crush the upstart ruler of Milan whom his rival had raised to the rank of duke. But the German troops were no match either in skill or in discipline for the mercenaries of Italy, and were utterly routed at Brescia by Jacopo dal Verme (October 24, 1401). The last hope of Florence disappeared when Giovanni Bentivoglio, who had turned against Milan, was compelled to surrender, and the Bolognese welcomed the substitution of a foreign for a native despot His death (July, 1402). But death intervened to thwart an in 1402. ambition which human opposition had failed to check. On September 3, 1402, Gian Galeazzo was carried off by the plague at the age of fifty-five. The kingdom of northern Italy perished with the man who had practically created it.

CHAPTER IX

THE SCHISMS IN THE PAPACY AND EMPIRE, 1378-1414

Decline of German Monarchy—Dangers to Germany—Policy of Charles IV. —Return of the Papacy to Rome and election of Urban VI.—Election of Clement VII. and beginning of the Schism—The German towns and their hostility to the nobles—Weakness of Wenzel—The town-war—Peace of Eger—The Succession to Hungary and Poland—The Jagellon House is established in Poland, and Sigismund in Hungary—Opposition to Wenzel in Germany—Troubles in Bohemia—France and the Schism—Meeting of Wenzel and Charles VI.—A Schism is created in the Empire—The idea of a General Council—Negotiations between the rival Popes—Europe and the Schism—The Council of Pisa—The Triple Schism—Alexander V. and his successor John XXIII.—Death of Rupert of the Pale—Election of Sigismund—Jobst—Death of Jobst—Second election of Sigismund—Sigismund and Pope John XXIII.—Summons of the Council of Constance.

WITH the year 1378 begins a period of anarchy and confusion characteristic of the decay of an old organisation, and the inevitable precursor of a new system. In that year died Gregory XI. and Charles IV., the representatives of secular and ecclesiastical authority as conceived in the Middle Ages. Of the two claimants to universal rule, the Papacy and the Empire, the former was immeasurably the stronger. It possessed a large revenue and an admirable administrative system. The Empire had neither. Its claims to rule over Christendom were no longer acknowledged. Even in Italy its suzerainty was recognised as a legal form, but in actual politics little regard was paid to it. And the German monarchy had fallen with the grandiose and unreal dignity to which it was attached. The imperial domains had been seized or squandered. The central administration and

jurisdiction were hardly existent. Such authority as the king possessed rested upon the territorial powers which he held independently of his kingship. His nominal vassals—ecclesiastics, lay princes, knights and cities—enjoyed practical independence. If they quarrelled with each other, they fought the quarrel out as if they had been independent states. If the Emperor intervened, it was as a partisan rather than as an arbiter. There was no parliamentary organisation, as in England, where the interests of the various estates could find effective expression. There was no overwhelming national sentiment, such as was created by the Hundred Years' War in France, to enable the monarchy to gain ascendancy and to crush rival pretensions.

The dangers of this growing disunion were sufficiently obvious in the fourteenth and fifteenth centuries. It seemed almost inevitable that Germany would lose all semblance of a state, and that as it fell to pieces foreign powers would seize upon the fragments. In the south-east the Turks were gradually establishing themselves on the ruins of the Byzantine Empire, and threatened to advance up the valley of the Danube into the heart of southern Germany. Further north a powerful Slav kingdom was erected in Poland under the House of Jagellon, whose mission seemed to be to annihilate the progress which German influences had effected by means of the Teutonic knights. The Slav kingdom of Bohemia, which under the House of Luxemburg had become almost the capital of Germany, revolted against the rule and the religion of its kings, and the Hussite victories revealed more clearly than any other single event the rottenness and impotence of the existing system in Germany. In the north, the Union of Kalmar brought the three Scandinavian states under a single ruler, and threatened to deprive the German Hansa of the ascendancy in northern waters which Lübeck and its associates had gained by their victory over Waldemar III. of Denmark. In the south, the Swiss Confederation was tending to free itself from

Decline of
German
monarchy.

Dangers to
Germany.

even nominal dependence on the Empire, and there were other leagues in Swabia and on the Rhine which were not unlikely to follow its example. In the west, German weakness had already allowed France to swallow a great part of the old kingdom of Arles, and though France was for a time crippled by the war with England and by internal dissensions, a new and more pressing danger was created by the rapid growth of the Valois dukes of Burgundy, who absorbed one imperial fief after another, and at one time almost succeeded in building up a middle kingdom along the Rhine, which would have excluded Germany from all real influence on the development of western Europe.

Charles iv., the greatest ruler of the fourteenth century, had clearly grasped both the dangers of the situation and the only remedies which could be applied.

Policy of Charles IV. Either Germany must be organised as a federation which should combine some measure of local independence with joint action for common interests, or a single family must collect such an aggregate of territories in its hands as might become the nucleus of a new territorial monarchy. Charles had kept both expedients before him. He had laid the foundations of a federal organisation by conferring corporate powers and privileges upon the electors. At the same time he had made the Luxemburg family the strongest in Germany, and had placed it in a position to do for Germany what the Capets had done for France. It is a common error to maintain that Charles iv.'s policy was a complete failure; that what he meant to be a temporary expedient proved permanent, while his ultimate aims were never achieved. It is true that a territorial monarchy was not established, and that such unity as Germany has since possessed has been federal rather than monarchical. But what really held Germany together from the fifteenth to the eighteenth century was not the federal system, but the territorial power of the house of Hapsburg. And that territorial power was, in the main, founded by Charles iv. It is as

the heirs of the Luxemburg family that the Hapsburgs assumed their unique position in Germany. Charles iv. achieved more lasting results than he has been credited with, but the fruits of his policy were gathered by others than his own descendants.

One very obvious source of weakness to Charles iv. had been his failure to control the ecclesiastical system, owing to the residence of the Popes at Avignon. Charles himself had gained the German monarchy to some extent as the papal nominee; but he had found it necessary to resist papal intervention in Germany as long as that intervention was dictated by a foreign power. It was obviously Charles's duty and interest to restore the Papacy to Rome, where alone it could exercise impartial authority. He had induced Urban v. to transfer his residence to Rome, but his hopes had been disappointed by the Pope's speedy return to the banks of the Rhône. Once again his influence had been successful, and in 1377 Gregory xi. had left Avignon for the Eternal City. But both Pope and cardinals found Rome too turbulent to be an agreeable abode, and they were preparing for another flitting when the death of Gregory compelled the conclave to meet for a new election within the Vatican. The mob surrounded the palace and demanded the choice of a Roman Pope. The majority of the cardinals were Frenchmen, but they were divided among themselves, and they were afraid of the violence of the citizens. As a compromise, they chose a Neapolitan, the archbishop of Bari, who took the name of Urban vi. So little confidence had the cardinals that their decision would please the people, that they escaped in disguise and left the news of the election to become known gradually. This fact is sufficient to prove that the election was not altogether compulsory, and as soon as the mob had shown itself acquiescent, the cardinals were unanimous in acknowledging Urban.

But this unanimity was very short-lived. Urban vi. had never

Return of
the Papacy
to Rome.

Election of
Urban VI.,
1378.

been a cardinal, and was personally unknown to most of his electors. He proved to be a man of violent temper and rough manners, eager to exercise his unexpected authority, and reckless of opposition or advice. The cardinals, who had hoped for a pliant and grateful tool, found themselves confronted with a master who announced that he would begin the reform of the Church with its chief dignitaries. He silenced remonstrances by the rudest sarcasms, and declared that he would never return to Avignon. Disappointed and indignant, many of the cardinals quitted Rome for Anagni. Encouraged by the support of France and Naples, they declared that Urban's election was invalid on account of the intimidation of the mob, and on September 20, 1378, proceeded to elect Robert of Geneva, a militant ecclesiastic who had succeeded Cardinal Albornoz as commander of the papal troops in Italy. The Antipope assumed the name of Clement VII., and his election commenced a schism in the Church which lasted for forty years.

Charles IV. had watched these events in Italy with the greatest chagrin. He gave unhesitating support to Urban VI., and urged the European princes to resist the revival of French dictation in the Church. But his death on November 29 removed the one statesman who might possibly have checked the progress of the schism. His son and successor, Wenzel, pursued his father's policy, but he was too young, and, as it proved, too incapable, to exercise the same influence. He threatened Joanna I. of Naples with the imperial ban if she did not give up the cause of Clement; and this threat was the more formidable because the Neapolitans themselves favoured their fellow-countryman Urban. But the only result was to aggravate the schism. Finding that residence on Neapolitan soil was no longer safe, Clement VII. and his

cardinals left Italy for Avignon. There Clement VII. was secure of French support, and before long he was also recognised by the Spanish kingdoms, Castile, Aragon, and Navarre. Germany, England, and most

The schism in
the Church,
1378-1417.

of the northern kingdoms gave their allegiance to Urban VI., and after his death to his successors, Boniface IX. (1389-1404), Innocent VII. (1404-5), and Gregory XII., elected in 1405. Clement VII. lived till 1394, when he was succeeded by a Spaniard, Peter de Luna, who took the name of Benedict XIII.

The schism in the Church was by no means the only difficulty which Wenzel had to face. In Germany, as in other countries, the feudal system, in which social and political relations depended upon the tenure of land, had been modified by the growth of towns, whose interests lay in industry rather than in agriculture, while their desire to maintain peace conflicted with the military habits and traditions of the noble landholders. In England and in France the monarchy had advanced its own interests by taking the rising towns under its patronage and by aiding the growth of municipal self-government. At one time, under Lewis the Bavarian, a similar policy had seemed possible in Germany. At the diet of Frankfort in 1344 the speaker of the town deputies had used the memorable words: *civitates non possunt stare nisi cum imperio: imperii lesio earum est destructio*. But Charles IV., guided by his experiences in Italy, had distrusted the towns: he had suspected them of aiming at independence rather than the strengthening of the monarchy: and in the Golden Bull he had deliberately opposed the development of the towns while he had conceded great powers to the electors. But his policy in this respect had not been altogether successful even during his own lifetime. The Hanse towns in the north had risen to the zenith of their power in 1370, and Charles had found it politic to conciliate them by a personal visit to Lübeck. In the south the Swabian League had been formed under the leadership of Ulm, had defeated the warlike Count of Würtemberg, and had compelled the old emperor to allow them the right of union, of which they had been deprived by the Golden Bull.

The death of Charles iv. and the accession of the feeble and self-indulgent Wenzel enabled the towns to take bolder measures. In 1381 an alliance was concluded at Speier between the Swabian League and the towns on the Rhine; and its object was not merely mutual defence, but 'to scourge and punish their mutual enemies.' The league thus formed contained seventy-two towns, and could supply a military force of ten thousand men-at-arms. And this force was by no means their only or their most effective weapon. By granting a modified form of citizenship (*Pfahlbürgerthum*), they annexed whole villages in their neighbourhood, thus depriving the lords at once of subjects, revenue, and territory. If the landholder tried to recover his loss, he only devastated his own property, while the offending citizens were safe within walls that until the general use of gunpowder were almost impregnable. It was no wonder that the princes resented the growth of a power which seemed likely to rival their own. But the class which was most immediately threatened by the towns was that of the knights or lesser tenants-in-chief. Their chief occupations were warfare and pillage, and the towns were resolute in putting a stop to practices which ruined their trade. Single-handed the knights were powerless against the civic forces, and they were driven to form leagues, such as the famous League of the Lion, for their own defence. There was little love lost between the knights and the princes, but class prejudices and associations tended to draw them together against a foe whom they both detested and contemned. The materials were prepared for a great war of classes in Germany.

Wenzel had neither the ability nor the experience to enable him to deal successfully with such a problem, and his attention was also occupied by family affairs in the east and by the quarrel in the Church. His only expedient was to form associations for the maintenance of the peace in which both princes and cities should be included. By this means he

Hostility of
towns and
nobles.

succeeded in postponing but not in preventing a war. The quarrel of Leopold of Hapsburg with the Swiss precipitated matters. The Swiss confederation differed from the Swabian and Rhenish leagues in that it included village communities of peasants as well as towns. When in 1385 an alliance with the Swabian League was proposed, the original forest cantons refused to take any part in the matter, and only the towns, Bern, Zürich, Zug and Luzern, were parties to the compact. The battle of Sempach was won mainly by the peasants, and the Swabian towns sent no assistance. But the fall of Leopold of Hapsburg, the champion of princely interests, was hailed as a triumph by the towns, and had the natural effect of increasing their pride and pretensions. In ^{The town} 1387 the war which had been on the verge of ^{war, 1387-9.} outbreak since 1379 at last began. There was little that was notable in the actual hostilities, except their extent. The war was merely a simultaneous explosion of the numerous feuds which had often been waged before between a noble and a too powerful town. As long as the citizens stood on the defensive, they were successful, and the armies of the princes and knights were repulsed from their walls. Emboldened by these successes, they determined to leave their walls and to invade the territories of their old enemy, Eberhard of Württemberg. But the German towns had no such soldiers as the peasants of the Alps, and no such geographical advantages as the Swiss had. In the open field their forces were cut to pieces by the feudal cavalry. On August 24, 1388, the united troops of the Swabian League suffered a severe defeat at Döfingen. The weakness of their position was now apparent. They could resist aggression, but they could not themselves take the offensive. The Rhenish towns were defeated with great loss at Worms, and Nürnberg, the latest and the most important recruit of the Swabian League, was reduced to submission by the Burggraf.

But the triumph of the nobles was incomplete. Though they had been victorious in the field they were as unable as

before to carry on siege operations. Their defensive strength enabled the towns to negotiate the peace of Eger (1389) on fairly equal terms. By this treaty all leagues and unions were to be abrogated on both sides. All future disputes between the towns and the nobles were to be settled by arbitration. For this purpose four commissions were appointed in Swabia, Franconia, Bavaria, and the Rhenish provinces. Each commission was to consist of four nobles, four citizens, and a president to be appointed by the Emperor. It is obvious that the towns, though defeated, had not been wholly unsuccessful, and had secured a position of equality with their opponents. But the real importance of the war is the discredit which it cast upon the monarchy. Wenzel had been unable either to prevent the war or to influence its course. And the organisation created for the maintenance of the peace was a local and representative organisation, in which the central authority had little more than a nominal share.

While Germany was convulsed with the town war, the House of Luxemburg had made an important territorial acquisition in the east. Lewis the Great, king of Hungary and Poland, the head of the original House of Anjou in Naples, had died in 1380. He left a widow, Elizabeth, and two daughters, Maria and Hedwig. In spite of the natural prejudices against female rule, he had induced his subjects to recognise his daughters' claim to the succession. If they were passed over, the nearest male heir was Charles of Durazzo,¹ who was engaged in a struggle for the crown of Naples with Louis of Anjou, brother of Charles v. of France. Maria, the elder of the two daughters, was betrothed to Sigismund, the second son of Charles iv. She was accepted by the Hungarians, and Sigismund was eager that his future wife should also gain the crown of Poland. But the Poles, influenced by the growing Slav sentiment, were unwilling to continue the connection with Hungary or

**Succession
in Hungary
and Poland.**

¹ See Genealogical Table I, in Appendix, p. 542.

to accept a German ruler. They insisted upon electing the younger sister Hedwig, and upon choosing a husband for her. Hedwig was sent to Poland in 1385, and in the next year was married to Jagello, prince of Lithuania, who was baptized as a Christian under the name of Ladislas. The union of Poland and Lithuania under the Jagellon house founded a powerful Slav state to the north-east of Germany, and led to the downfall of the Teutonic Knights, who could no longer claim to conduct a crusade when their foes had accepted Christianity (see p. 459)

Meanwhile Sigismund, disappointed in Poland, came near to losing Hungary as well. Elizabeth, the late king's widow, unwilling to surrender authority to an ambitious son-in-law, tried to break off Maria's engagement, and to bring about a marriage with a French prince. But her schemes were suddenly checkmated by a revolt of the Hungarian nobles, who offered the crown to Charles of Durazzo, now established on the throne of Naples. Charles accepted the offer, and landed in Dalmatia in 1385. This unexpected danger forced Elizabeth to appeal for assistance to Sigismund, whose long-delayed marriage was hastily solemnised in October 1385. The bridegroom hurried off to raise troops for the defence of his wife's crown, and among his expedients for gaining money he pawned a great part of Brandenburg to his cousin Jobst of Moravia. Meanwhile events in Hungary moved with kaleidoscopic rapidity. Charles of Naples, after having apparently secured his kingdom, was assassinated by the emissaries of Elizabeth in February 1386. Elizabeth recovered authority in her daughter's name, and at once quarrelled with her son-in-law, whose assistance seemed to be no longer needed. But the nobles of Croatia determined to avenge the death of Charles. They seized Elizabeth and Maria, and carried them off to the fortress of Novigrad. When the fortress was besieged, the former was put to death, and Maria was threatened with the same fate. In the general

Sigismund's
accession in
Hungary,
1387.

anarchy, the Hungarian nobles determined to offer the crown to Sigismund, who was crowned in 1387, and soon afterwards succeeded in effecting his wife's release. His accession added a new province to the Luxemburg possessions, and at the same time founded the dynastic connection between Hungary and Bohemia which still exists.

The acquisition of Hungary did nothing to strengthen the position of the House of Luxemburg in Germany, while it increased the jealousy with which its overgrown territories were regarded. The western princes, representing the original German duchies of Bavaria, Franconia, and Swabia, resented the transference of power to a dynasty whose possessions lay mostly in the east, and some of them outside Germany altogether. The House of Wittelsbach, from whose hands Charles iv. had snatched the imperial dignity, were the foremost in raising this outcry of the west against the east. And the malcontents were not without more serious grounds of complaint. Wenzel had done nothing to terminate the ecclesiastical schism. His feeble and vacillating conduct during the town war had disgusted the princes; and after the peace of Eger he had practically withdrawn from German politics, and had left the kingdom in a state of anarchy. Even in the east he incurred difficulties and humiliations which brought discredit upon his person and his office.

Charles iv. had had two sources of strength which his successor entirely lacked. He could rely upon the enthusiastic loyalty of the Bohemians, and he was the undisputed head of the Luxemburg family. Neither of his brothers had ever ventured to oppose his will. But under Wenzel Bohemia enjoyed neither the prestige nor the good government which had endeared Charles to his subjects, while there was a growing feeling that it was degrading to a Slav people to be ruled by a German prince and by German methods. The sentiment of race which had led Poland to unite with Lithuania under Jagello was beginning

Opposition to
Wenzel in
Germany.

Troubles in
Bohemia.

to be powerful in Bohemia, in spite of its long and intimate association with Germany. Wenzel himself was not personally unpopular. The very coarseness of his character and manners, which degenerated in time into brutish gluttony and drunkenness, seems to have evoked a rude sympathy, at any rate among the lower classes. But his reckless passion led him into gross political blunders, his unconcealed contempt alienated the clergy, while his patronage of unworthy favourites exasperated the nobles. A series of disorderly revolts began in 1387, and followed each other in rapid succession. And Wenzel's kinsmen, instead of assisting the head of their house, rather added to his embarrassments. The evil genius of the family was his cousin, Jobst of Moravia, a man who anticipated the Italians of the next century in his selfish cunning and his complete disregard of moral rules. Jobst had already gained Brandenburg by trading on the pecuniary difficulties of Sigismund, and he hoped by discrediting Wenzel to obtain for himself the Bohemian and the imperial crowns. In 1394 he was at the head of a baronial revolt, in which Wenzel was seized and imprisoned by the rebels. The most loyal member of the family, John of Görlitz, who succeeded in releasing his brother, was treated by Wenzel with gross ingratitude, and died in 1396, not without grave suspicions of poison. Sigismund, though absorbed in the pursuit of his own ends, was less cynically selfish than Jobst, and showed some regard for the dignity and interests of his house. But he was prevented from giving Wenzel any real assistance or guidance by the necessity of defending his own kingdom of Hungary against the Turks. In 1396 he led a large crusading army to be cut to pieces by the forces of Bajazet I. on the field of Nicopolis. But for the advance of the Tartars under Timour, eastern Europe would have been at the mercy of the victorious sultan.

The scandals in Bohemia and the quarrels among the Luxemburg princes seem to have convinced the western princes that Wenzel was as little to be feared as respected.

He had given them a new grievance in 1395 by granting the title of Duke of Milan and thus raising to princely rank the aggressive Ghibelline leader in northern Italy, Gian Galeazzo Visconti. And three years later he gave them a pretext for throwing off their allegiance by his action with regard to the schism in the Church. From the first the University of Paris, then by far the most influential university in Europe, had set itself against a schism which the French government had done much to bring about. At first the king had silenced the university, but gradually he had come to share its views. France found it extremely expensive to support a schismatic Pope who had little but French contributions to look to for the maintenance of himself and his court. Popular sympathy was cooled when a Spaniard, Peter de Luna, was chosen to succeed the French Pope Clement VII. Under the guidance of the university leaders, Pierre d'Ailly and Jean Gerson, Charles VI. and his ministers determined to end the schism by 'the way of neutrality,' *i.e.* by withdrawing allegiance from the two rival Popes, and thus forcing them to abdicate, when a new election could restore unity to Christendom. To give effect to this scheme, it was necessary to secure simultaneous action on the part of the supporters of the Roman Pope Boniface IX., and of these the most exalted was the King of the Romans. Wenzel seems to have inherited some of the traditional attachment to France of the Luxemburg dynasty, and he had quarrelled with Boniface about the appointment of an Archbishop of Mainz. The two kings, the one a confirmed drunkard and the other subject to fits of insanity, met at Rheims in 1398 to discuss the most pressing problem of the age. Their personal intercourse cannot have been very edifying. On one occasion Wenzel was invited to a banquet with the French king, and when the Dukes of Burgundy and Berri came to escort the guest, they found that he had already dined, and was lying under the table in a drunken sleep. But the interview resulted in a more or less formal agreement that France should

France and
the schism.
Meeting of
Wenzel and
Charles VI.

extort the resignation of Benedict, while Wenzel was to do the same by Boniface.

The Elector Palatine had already warned Wenzel that if he withdrew his allegiance from the Pope who had confirmed his title, his subjects would no longer be bound to him. The interview at Rheims had the effect of hurrying the execution of a plan which had been for some time in contemplation. Boniface IX., though careful to avoid committing himself to the conspiring princes, was not unwilling to checkmate Wenzel by encouraging his opponents in Germany. Of the seven electors, two, representing Bohemia and Brandenburg, belonged to the Luxemburg house, while the Duke of Saxony held aloof. The other four, whose territories bordered on the Rhine, met in 1400 at Lahnstein, decreed the deposition of Wenzel, and elected one of their own number, the Count Palatine, Rupert III. But the Rhenish electors, like the recalcitrant cardinals in 1378, had no power to enforce their decree of deposition, and the only result of their action was to create a schism in the Empire side by side with the schism in the Church.

Rupert was a far wiser ruler and a far better man than his rival, and if to his other virtues he had added the slightest military capacity, he might have gained a complete triumph. Wenzel continued to quarrel with his brother and his cousins, and during a revolt in Hungary Sigismund was for five months a prisoner in the hands of his barons. If Ladislas of Naples had not been occupied in his contest with Louis II. of Anjou, he might have enforced the claims of the House of Durazzo to the Hungarian crown, as his father had done in 1385. But the difficulties of the Luxemburg princes were not enough to enable Rupert to profit by them. He invaded Bohemia, and actually reached Prague, where Jobst and the malcontent nobles offered him their support. But at the first slight reverse he withdrew, and his opportunity was lost when Sigismund escaped from captivity and came to govern Bohemia for

The rival
Kings of the
Romans.

his incompetent brother. Then Rupert tried to obtain an indirect triumph by crushing Wenzel's *protégé*, Gian Galeazzo Visconti. He hoped thus to restore German influence in Italy, which the two last Luxemburg rulers had allowed to decay, and also to receive the imperial crown from the gratitude of Boniface IX. Florence and all the opponents of the Milanese despot promised to aid him with men and money. But his Italian expedition was even more unsuccessful than his invasion of Bohemia. His army was utterly routed by the mercenary forces of Gian Galeazzo under the walls of Brescia (October 21, 1401), and he returned to Germany the laughing-stock of Europe. His failure encouraged Wenzel to plan a journey to Italy to obtain his long-delayed coronation, and Sigismund undertook to escort him. Boniface IX., who was now committed to the cause of Rupert, sought to foil the scheme by urging Ladislas of Naples to an invasion of Hungary, which proved unsuccessful. But the project was perforce abandoned on the news of the death of Gian Galeazzo (September 3, 1402). From this time the rival Kings of the Romans abstained from direct attacks on each other, and contented themselves with their respective obedience, the one in the west and the other in the east. Germany was so accustomed to dispense with any active exercise of the royal authority that the schism created little excitement and less inconvenience.

The schism in the Church was far more important to Europe, though the chief actors were hardly more imposing than the rival emperors. The position of the Papacy was necessarily shaken by the contentions of two old men, each claiming to exercise divine authority, and each cursing the other with human petulance. The religious were shocked by such a spectacle: the irreligious laughed and mocked. A contemporary remarks that for a long time Christians had had an earthly god who forgave their sins, but now they have two such gods, and if one will not forgive their sins, they go to the other. The prolonged

The idea of
a General
Council.

scandal forced men to change their conception of papal power, and to contend that such power does not exist for its own ends, but for the sake of the whole Church. If therefore that power is grossly abused, it is the right and even the duty of the Church to interfere on behalf of its suffering members. Hence arose the conciliar idea, which dominates all other ecclesiastical conceptions in the first half of the fifteenth century. The Church, as represented by a General Council, is superior to the head, as the whole body is superior to any member. This idea found its main support in the Universities, especially in Paris, Oxford, and Prague. The schism in the Empire and the prominence of the University of Paris enabled France to take the foremost place in urging the summons of a Council to put an end to ecclesiastical anarchy. France had already adopted a policy of neutrality in 1398, and had gone so far as to besiege Avignon and to make Benedict. xiii. a prisoner. But a reaction had set in when no other power followed the example of France, and the Orleanist party, in opposition to the Duke of Burgundy, had espoused the cause of Benedict. In 1402, to the great chagrin of the University of Paris, France returned to its allegiance, and Benedict, released from his captivity, journeyed to the coast of Provence and opened negotiations with his rival in Rome.

The last two Roman Popes, Innocent vii. and Gregory xii., had only been elected on the express condition that they would resign as soon as their opponent did the same. Gregory xii. went so far as to make an agreement with Benedict, by which the two Popes pledged themselves to create no new cardinals, and to meet together at Savona in 1407. The agreement was probably insincere on Gregory's part, and at any rate there were powerful influences at work to prevent its execution. Gregory xii. might be old and unambitious, but his relatives were eager to profit by his elevation, and he was too feeble to disregard their wishes. And Ladislas of Naples, who had become almost supreme at Rome under

Negotiations
between the
two Popes.

Innocent VII., had his own interest in prolonging the schism. A Roman Pope with a rival at Avignon was bound to support him against the Angevin claimant to Naples: but a new Pope, chosen at Savona under French influence, would be sure to espouse the cause of Louis of Anjou. None of the princes of Europe wished France to recover the ascendancy in Church matters which it had enjoyed from 1305 to 1378, yet this would probably be the result if France were allowed to take the lead in terminating the schism. So the negotiations between the two Popes remained ludicrously futile. Gregory came as far north as Lucca, and Benedict as far south as Spezzia, yet they could not agree to meet. 'The one,' said Leonardo Bruni, 'like a land animal, refused to approach the sea; the other, like a water-beast, refused to leave the shore.'

But Europe was not prepared to allow its interests to be any longer sacrificed by the selfish procrastination of two aged priests. In France Benedict's chief supporter, the Duke of Orleans, had been removed by assassination in 1407, and Charles VI. was induced by the University to withdraw his allegiance once more. Benedict replied by a bull of excommunication against the French bishops, but the bull was burned, on the proposal of the University. This boldness convinced Benedict that he could no longer trust in France, and he fled to Perpignan, in his native state of Roussillon. But meanwhile an important event had taken place in Italy. The cardinals who had supported the respective Popes shared the general disgust at the obstinate refusal of their masters to fulfil their oft-repeated pledges. Though the Popes had never met, they had come near enough to allow their cardinals to confer together. The result was that most of them abandoned the Popes, put themselves under Florentine protection, and summoned a General Council to meet at Pisa.

The European states were invited to approve the action of the cardinals by sending delegates to Pisa. The support of

The
Cardinals
desert the
Popes.

France was assured, and England readily agreed to acknowledge the Council. The Spanish kingdoms, on the other hand, remained passively loyal to Benedict XIII., The attitude of Europe. and Germany was divided. Wenzel, who had never done anything to carry out the policy of neutrality which he had promised France to adopt in 1398, agreed to support the Council on condition that his title as King of the Romans was formally recognised. But Rupert, although many of his chief supporters were inclined to favour the cause of the cardinals, remained obstinate in his allegiance to the Roman Pope. Within Italy, Ladislas of Naples showed his determination to enforce his own interests by occupying Rome with his troops. The two Popes, threatened with general desertion, made a tardy effort to conciliate public opinion by each summoning a council of his own. But very few prelates could be induced to attend, and the Council of Pisa only gained in importance by comparison with these *concliiabula*.

At Pisa the Council was opened on March 25, 1409. The delegates present may be divided into two parties. The majority, including the cardinals who had summoned the assembly, desired merely to end the The Council of Pisa, 1409. schism and to restore the old organisation in the Church. But some of the more enlightened ecclesiastics, such as d'Ailly and Gerson, wished to take advantage of an exceptional opportunity, and to effect such reforms in the Church as would render similar scandals impossible in the future. Thus the programme of the Council came to be divided into the *causa unionis* and the *causa reformationis*. It was agreed to take the more pressing question of unity first, but to conciliate the reformers it was given to be understood that the Council should not separate until it had considered the reformation of the Church, both in its head and its members. After this matters proceeded without any hurry, but without any conflict of opinion. Charges against the two Popes were drawn up and publicly read. Gregory and Benedict were cited to appear and answer before the Council. After the

third summons they were declared contumacious, and deprived of their usurped office and dignity. It is noteworthy that the Popes were not deposed simply on the ground of public advantage, or because they were not canonically elected; but distinct charges were brought against them, and the Council claimed the right to impose the punishment of deposition. It was a novel spectacle for Europe to see the principles of constitutional government applied in the Church as they had been enforced in the English state in the cases of Edward II. and Richard II. With the ground cleared by the decree of deposition, the cardinals proceeded to a new election, and after eleven days' deliberation, their choice fell upon the Archbishop of Milan, who took the name of Alexander V. (June 26, 1409). The question of reform was adroitly postponed for the consideration of a new council which was to meet in 1412, and the Council of Pisa was dissolved on August 7, 1409.

The Council broke up under the impression that it had accomplished at any rate the most important part of its programme. But it was soon evident that the schism was as far from an end as ever. Neither Gregory nor Benedict would acknowledge the legality of the Council and its proceedings: and indeed it was not hard to question the legality of proceedings that were undoubtedly revolutionary and without precedent. The Council had no coercive power to enforce its edicts, and as long as the Popes could find any princes interested in supporting them, so long they would cling to their titles. The only difference that the Council had made was that, whereas before there had been two rival Popes, there were now three. The pontificate of Alexander V. only lasted ten months. During that period he succeeded in recovering Rome from Ladislas, but only by reviving civil war by the recognition of Louis of Anjou's claim to Naples. His only ecclesiastical measure was a bull which endeavoured to settle an old quarrel in favour of the mendicant orders. Alexander himself was a

Franciscan, and he recognised the full rights of the friars to receive confession and to administer the sacraments. The bull provoked a storm of opposition from the parish clergy, whose rights were infringed by the intruding friars, and from the University of Paris, always at war with the Franciscans. The University, which had so recently welcomed the Pope's election, now expelled all mendicants, and demanded that they should renounce the privileges conferred upon them by the bull. In the midst of this general disapproval, Alexander v. died (May 8, 1410), and the cardinals elected as his successor the clerical *condottiere*, Baldassare Election of Cossa, who took the name of John XXIII. John XXIII. The new Pope had rendered great services in the protection of the Council and the recovery of Rome, and he seemed to be the only man who could be trusted to resist the threatening power of Ladislas of Naples. But he had no pretensions to piety, or even to respectability, and the elevation of a licentious soldier to the highest ecclesiastical dignity was in itself a scandal to Christendom almost as great as the schism itself.

The apparent failure of the Council of Pisa seemed to bring discredit upon its supporters and to justify the action of those who had held aloof. But Rupert was Death of not able to profit by any improvement this might Rupert. have made in his position, as he died on May 18, 1410, a few days after Alexander v. His death forced upon the western electors the problem of a new election, and ten years' experience had so fully convinced them of the difficulty of overthrowing the House of Luxemburg, that no candidate outside that house seems to have been considered. There were now three surviving Luxemburg princes: Wenzel, who still claimed to be King of the Romans; Sigismund, who had gained a considerable reputation by the success of his recent rule in Hungary; and the ambitious Jobst, who had added Brandenburg and Lausitz to his inheritance in Moravia, and was now the chief adviser of his cousin in Bohemia. On

the great question of the Church these princes had taken opposite sides: Wenzel and Jobst had acknowledged the Council, while Sigismund had never withdrawn his allegiance from Gregory XII. The four Rhenish electors, who alone had voted in the election of Rupert, were equally divided on the same question. The Archbishop of Trier and the Elector Palatine were adherents of the Roman Pope, while the Archbishops of Mainz and Köln supported Alexander V. and his successor. As none of them were inclined to stultify their action in 1400 by recognising Wenzel, the ecclesiastical differences decided their votes. The electors of Mainz and Köln were in favour of Jobst, and the other two were inclined to support Sigismund.

Sigismund was the first to bring forward his claims, and he had much to recommend him. He had compelled Bosnia to submit to his rule: the Servians acknowledged the suzerainty of Hungary; and he had reduced the greater part of Dalmatia, always inclined to set up a Neapolitan prince. Thus he could offer Germany the most efficient protection against the Turks, while as heir to Bohemia he seemed the only man who could mediate in the growing hostility of Germans and Slavs. As he could not come to Germany in person, he intrusted his cause to Frederick of Hohenzollern, Burggraf of Nürnberg, who had saved his life at the battle of Nicopolis, and had since become his most intimate adviser. But in spite of Sigismund's distinguished reputation, his chances of election seemed small if he could only secure two votes, and if Jobst gave the Brandenburg vote in his own favour. To get rid of this difficulty Sigismund determined to repudiate the bargain by which Brandenburg had been pledged to his cousin, and to claim and exercise the vote himself. He appointed Frederick of Hohenzollern to act as his proxy: and on September 1, 1410, the latter appeared with the four Rhenish electors at Frankfurt. This last move on Sigismund's part found his opponents unprepared. Jobst had made up his mind to stand by the

cause of Wenzel and to secure his own election on his cousin's death. He and Rudolf of Saxony had declined to attend the meeting on the ground that there was no vacancy. The electors of Mainz and Köln did all they could to delay matters, but on September 20 the Elector Palatine and the Archbishop of Trier refused to wait any longer. Punctiliously fulfilling all the customary forms, they examined and approved the powers of the Burggraf of Nürnberg, and declared Sigismund to be unanimously elected. By the letter of the Golden Bull the election was incontestably valid, and even the doubtfulness of his claim to Brandenburg could hardly be urged against it.

But Sigismund's opponents had numbers on their side, and were eager to atone for the blunder they had made in allowing a march to be stolen upon them. Jobst induced Election of Wenzel to make an agreement by which the latter Jobst.

was to be recognised as Roman Emperor, and in return confirmed Jobst in the possession of Brandenburg and promised to give the Bohemian vote in favour of his election as King of the Romans. In October Frankfort witnessed a new election. Five electors, either in person or by proxy, gave their votes in favour of Jobst of Moravia. Thus for the second time events in the Empire copied the example of those in the Church. The first schism between two rival Popes had been followed by a schism between two rival Kings of the Romans. In 1409 a third Pope was added, and the next year witnessed the unique spectacle of three princes of the same family each claiming the highest temporal dignity on earth. There could be no clearer proof of the unsuitability of mediæval conceptions to the conditions of Europe in the fifteenth century.

The triple schism in the Empire was, however, of short duration. Sigismund was preparing to attack his rival, when Jobst suddenly died on January 12, 1411. His Death of removal rendered possible an agreement between Jobst. the two brothers. Sigismund recovered his inherited fief of Brandenburg, and intrusted its administration to Frederick

of Nürnberg. Moravia was annexed to the Bohemian crown, and has never since been severed from it. As regards the imperial dignity, Wenzel agreed to give his own vote for Sigismund, as he had given it the previous year to Jobst, on condition that his own title should be recognised and that he should have a prior claim to be made emperor. The support of the Archbishops of Mainz and Köln Sigismund purchased by changing his attitude on the Church question and abandoning the cause of Gregory XII. On July 21, 1411, a third election took place at Frankfort, when the five votes which had been given for Jobst were unanimously registered in favour of Sigismund. The Elector Palatine and the Archbishop of Trier took no part in the matter, as they refused to cast a slur on the legality of their previous election.

Sigismund was now to all intents and purposes the only King of the Romans, as Wenzel made no attempt to busy himself with anything but Bohemian affairs. In his new capacity Sigismund displayed the bustling activity and the readiness to turn from one great scheme to another which had always characterised him. He began by making war on the Venetians, who had encroached upon Dalmatia. When this war was ended by a truce in 1413, he entered Italy to reconquer Lombardy from the Visconti. But he found the power of Filippo Maria too strongly established to be easily overthrown, and he was about to retire when fortune threw another and more distinguished enterprise in his way. John XXIII. had succeeded to his predecessor's alliance with Louis II. of Anjou and to the war with Ladislas of Naples. The defeat of the Neapolitan king at Rocca-Secca (May 19, 1411) induced him to conclude a treaty by which he was to abandon Gregory XII. and John was to desert the Angevin cause. But Ladislas had more ambitious aims than merely to secure his position in Naples. He desired to build up a kingdom of Italy, and for this purpose to seize upon the States of the Church which lay

**Second
election of
Sigismund.**

**Sigismund
and John
XXIII.**

between him and the northern principalities and republics. No sooner had John XXIII. disbanded his mercenary forces than Ladislas resumed hostilities, occupied Rome, and drove the Pope to find refuge in Florence. In this strait John looked eagerly round for support, and the most obvious ally was Sigismund, who had his own reasons for checking the aggrandisement of Ladislas. But Sigismund would only give his assistance on condition that the Pope should summon a new Council to some German city in order to put an end to the schism. John saw clearly the danger of such a proceeding to his own position, and strove to alter the place of meeting to some town south of the Alps. Sigismund, however, stood firm, the Pope's difficulties were pressing, and at last a formal summons was issued for a Council to meet at Constance on November 1, 1414. Summons of the Council of Constance. Before the dreaded date arrived, the death of Ladislas (August 6) freed the Pope from his most immediate difficulties and caused him to repent of his too hasty acquiescence. Sigismund had apparently gained a signal triumph. He had ousted the French monarchy from the lead of the reforming movement in Europe, and if he could conduct the Council to a successful issue, he would have done much to restore the prestige both of the imperial dignity and of the German kingship. Men were reminded of the days when the early emperors, Otto the Great and Henry III., had dominated the Church as well as the State.

CHAPTER X

THE HUSSITE MOVEMENT AND THE COUNCIL OF CONSTANCE, 1409-1418

Questions before the Council of Constance—The Hussite Movement—Its Political Aspect—Exodus of Germans from Prague—Hus at the Council of Constance—Parties at Constance—Hus imprisoned—Attacks on John XXIII.—His flight—Triumph of Sigismund—Deposition of John XXIII.—The Council during Sigismund's absence—Sigismund's journey—Dissensions in the Council—Election of Martin V.—Dissolution of the Council.

THE Council of Constance, like that of Pisa, had two very obvious questions to consider: (1) the restoration of unity; and (2), if the reforming party could have its way, the reform of the Church in its head and members. But circumstances forced the Council to consider a third question, which had never been even touched in the discussions at Pisa. This was reformation in its widest sense: not merely a constitutional change in the relations of Pope and hierarchy, but a vital change in dogma and ritual. This question was brought to the front by the so-called Hussite movement in Bohemia. The fundamental issues involved were those which have been at the bottom of most subsequent disputes in the Christian Church. How far was the Christianity of the day unlike the Christianity to be found in the record of Christ and His Apostles? And the difference, if any, was it a real and necessary difference consequent on the development of society, or was it the result of abuses and innovations introduced by fallible men? The orthodox took their stand upon the unity and authority of the Church. The Church was the true foundation of Christ and

Questions
before the
Council of
Constance.

the inheritor of His spirit. Therefore what the Church believed and taught, that alone was the true Christian doctrine: and the forms and ceremonies of the Church were the necessary aids to faith. The reformers, on the other hand, looked to Scripture for the fundamental rules of life and conduct. Any deviation from these rules, no matter on what authority, must be superfluous, and might very probably be harmful.

The Hussite movement was older than Hus, and it was partly native and partly foreign in its origin. The first impulse to religious reform is to be found, in The Hussite movement. Bohemia as in England, in the dissensions between the parish clergy and the mendicant orders. The latter, being in immediate dependence upon the Papacy, were not subject to the ordinary authority of the bishops, and soon learned to consider themselves superior to the parish clergy. The bishops usually supported their own dependants, while the friars often found a powerful ally in the Pope. One result of this long-standing quarrel was that the people learned to question the authority of their ecclesiastical superiors. Wherever it is necessary or possible to take one of two sides, a certain amount of thought and independence is called into exercise by the choice. This first questioning spirit among the Bohemians was taken advantage of by a series of reforming teachers in the fourteenth century, of whom the best known are Konrad Waldhäuser, Milecz of Kremsier, and Mathias of Janow. These men attacked the degradation of the Church, the vices of monks and friars, the wealth and worldliness of the higher clergy. But it was not until the rise of Hus that there was any system in the demand for reform, or any cohesion among the reformers. And the systematic teaching of Hus was for the most part derived from the great English teacher, John Wyclif. It was a rule in the University of Prague that Bachelors of Arts might not deliver their own lectures, but must expound the teaching of distinguished professors either of Prague, Paris, or Oxford.

The marriage of Anne of Bohemia, Wenzel's sister, with Richard II. led to considerable intercourse between England and Bohemia. Many Bohemian students, notably the friend and disciple of Hus, Jerome of Prague, completed part of their course in Oxford, and returned to their native land carrying with them Wyclif's treatises, or the record and recollection of his oral teaching. Wyclif, like the Bohemian reformers, had begun by quarrelling with the friars and denouncing the vices of the clergy. The disputes with the Avignon Popes had led him on to attack the extreme claims of papal authority: and gradually he had come to question some of the most prominent dogmas of the Church, notably that of transubstantiation. Hus was at first reluctant to accept all the conclusions of Wyclif, but he advanced step by step in the same direction, and in the end it was as the avowed disciple of the English reformer that he became the leader of a religious party in Bohemia.

But it is important to remember that the Hussite movement had a secular as well as an ecclesiastical side. Bohemia was a Slav state, and for centuries there had been a conflict between Slavs and Germans. At one time the Slavs had advanced along the southern shores of the Baltic almost as far as the North Sea. But, harassed by the attacks of the Magyars, they had been unable to hold their own, and had gradually been subdued or driven eastwards by German influences, represented by the Dukes of Saxony, the Margraves of Brandenburg, the Hanseatic League, and finally the crusading order of the Teutonic Knights. At the end of the fourteenth century this steady eastward advance of the Germans met with a severe, and to some extent a permanent, check. No doubt the chief agency in effecting this was the success of the Jagellon kings of Poland in their war with the Teutonic Order. But the Hussite movement belongs to the same Slav reaction, and for a time contributed almost as directly as Polish victories to assure the successful resistance of the Slavs. Hus himself, born of humble parentage

Political
aspect of the
Hussite
movement.

in the village of Husinec, was profoundly imbued with popular sympathies, and lost no opportunity of identifying himself and his teaching with the national cause. And in this aim he was served by events in the University of Prague, where he early rose to a distinguished position. Founded in the days of Bohemian ascendancy under Charles iv., the University had from the first attracted a large number of German teachers and students, and had become far larger and more distinguished than any purely German university. Like the Paris University, on which it had been modelled, it was divided into four nations—Bohemians, Poles, Bavarians, and Saxons. After the foundation of a Polish university at Cracow, the Polish nation at Prague had come to be composed mainly of Germans from Silesia, Pomerania, and Prussia. Thus to all intents and purposes the University was composed of two nations, Germans and Bohemians, of whom the former had three times as much power as the latter. In all questions which were decided by the vote of the nations, the Germans had three votes to one, and as offices went in rotation to the four nations, they had three turns to the Bohemian one. As the divergent interests of Slavs and Germans became accentuated by political and religious differences, the inferiority of the Bohemians in their own University became more and more of a grievance. It was on religious questions that the quarrel was most embittered. The majority of the orthodox party in the University consisted of Germans, and they denounced the growth of Wycliffite heresy. A German teacher brought forward a number of propositions which had been attributed to Wyclif and condemned by a Synod in London. In spite of the opposition of Hus and his Bohemian supporters, the majority in the University voted that the doctrines were heretical, and prohibited their teaching. Wenzel, who was at this time supporting the rebellious cardinals, was anxious that his intervention should not be weakened by the charge of the prevalence of heresy in his dominions, and was at first inclined to support the majority.

But when he applied to the University for their approval of the Council of Pisa, he found the Bohemians ready to acquiesce, while the Germans were mostly on the side of the Roman Pope. At this moment the so-called 'contest of the three votes' was at its height, and Hus had adroitly come forward as the champion of the cause of his fellow-countrymen. In the hope of forwarding his ecclesiastical policy, Wenzel was induced to intervene in the University quarrel. In January 1409 he issued an edict that henceforth the Bohemians should have three votes and three turns in office, while the foreign nations were only to have one between them. The Germans protested vigorously, and as they failed to obtain redress, determined to leave Prague. The roads were crowded with the emigrants, and it was reckoned that on one day two thousand Germans took their departure.

The exodus of the Germans from Prague is an important historical event. For sixty years Prague had been the capital of Germany, partly as the residence of the Emperor, and partly as the seat of the leading University. With the students had come German traders, who had made Prague a commercial as well as an intellectual centre. All this came to a sudden end in 1409. Prague lost its prominence among German towns. Other universities were strengthened by the addition of the exiles from Bohemia; and a large number of them founded a new university at Leipzig. Germany received a great intellectual impulse, which was strengthened rather than weakened by the loss of a general centre. And for Bohemia the consequences were no less important. The German element in the country received a blow which was fatal to its further development for two centuries. At the same time the great dam which had hitherto impeded the spread of the new religious doctrines was removed. The rapidity with which the people received the Wycliffite or Hussite teaching shows not only that the soil was already well prepared for the seed, but also the strength of the national antipathy to foreigners.

With the departure of the Germans, all opposition to the recognition of the Council of Pisa by Bohemia came to an end. But the religious dispute was as far from a settlement as ever. Although the people were inclined to regard Hus as the champion of the national cause, there was still a large orthodox party among the upper classes, and the clergy were resolutely opposed to doctrinal reform. Alexander v. issued a bull ordering the Archbishop of Prague to put down heresy, and Wyclif's writings were publicly burned. Hus appealed from the Pope ill-informed to the Pope when he should be better informed. In 1412 the quarrel was envenomed. John xxiii. had proclaimed a crusade against Ladislas of Naples, and endeavoured to raise money by the sale of indulgences. Hus protested against such an iniquity as vigorously as did Luther a century later, and the papal bull was burned in the public square. Riots broke out in Prague, and Bohemia seemed to be on the verge of civil war. Wenzel could only obtain a temporary truce by persuading Hus to retire for a time into the country. Meanwhile Sigismund had succeeded in inducing John xxiii. to summon a General Council, and anxious to pacify his future kingdom, he invited Hus to attend. The reformer's friends warned him of the danger he would run in accepting the invitation, but Hus was eager to state his opinions before an assembly of Christendom, and on receiving a promise of a personal safe-conduct from Sigismund, he arrived in Constance on November 3, 1414.

The Council of Constance is one of the most notable assemblies in the history of the world. In the number and fame of its members, in the importance of its objects, and above all, in the dramatic interest of its records, it has few rivals. It is like the meeting of two worlds, the old and the new, the mediæval and the modern. We find there represented views which have hardly yet been fully accepted, which have occupied the best minds of succeeding centuries: at the same time, the Council itself and its

ceremonial carry us back to the times of the Roman Empire, when Church and State were scarcely yet dual, and when Christianity was co-extensive with one united Empire. At Constance all the ideas, religious and political, of the Middle Ages seem to be put upon their trial. If that trial had ended in condemnation, there could be no fitter point to mark the division between mediæval and modern history. But the verdict was acquittal, or at least a partial acquittal; and the old system was allowed, under modified conditions, a lease of life for another century. It must not be forgotten that there were great secular as well as ecclesiastical interests involved in the Council. Princes and nobles were present as well as cardinals and prelates. The Council may be regarded not only as a great assembly of the Church, but also as a great diet of the mediæval empire.

The man who had done more than any one to procure the summons of the Council, and whose interests were most closely bound up in its success, was Sigismund, King of the Romans and potential Emperor. He was eager to terminate the schism, and to bring about such a reform in the Church as would prevent the recurrence of similar scandals. But his motive in this was not merely disinterested devotion to the interests of the Church. He wished to revive the prestige of the Holy Roman Empire, and to gratify his own personal vanity, by posing as the secular head of Christendom and the arbiter of its disputes. More especially he wished to restore the authority of the monarchy in Germany, and to put an end to that anarchic independence of the princes, of which the recent schism was both the illustration and the result. In pursuing this aim he was confronted by the champions of 'liberty' and princely interests, who were represented at Constance by the Archbishop of Mainz and Frederick of Hapsburg, Count of Tyrol. The archbishop, John of Nassau, had been prominent in effecting and prolonging the schism in the Empire. He was a firm supporter of John XXIII., and had no interest in attending the

Council except to thwart the designs of the king, whom he had been the last to accept. Frederick of Tyrol was the youngest son of that Duke Leopold who had fallen at Sem-pach in the war with the Swiss. Of his father's possessions Frederick had inherited Tyrol and the Swabian lands, and the propinquity of his territories made him a powerful personage at Constance. His family was the chief rival of the House of Luxemburg for ascendancy in eastern Germany, and he himself seems to have cherished a personal grudge against Sigismund. To these enemies Sigismund could oppose two loyal allies, the Elector Palatine Lewis, who had completely abandoned the anti-Luxemburg policy pursued by his father Rupert, and Frederick of Hohenzollern, the most prominent representative of national sentiment in Germany, who had already given in Brandenburg an example of that restoration of order which he wished Sigismund to effect throughout his dominions.

Of the clerical members of the Council the most prominent at the commencement was the Pope John XXIII. He had been forced by his difficulties in Italy to issue the summons, but as the time for the meeting approached he felt more and more misgiving. His one object was to maintain himself in office; but he was conscious that neither Sigismund nor the cardinals would hesitate to throw him over if he stood in the way of the restoration of unity. He therefore allied himself with Sigismund's opponents, the Elector of Mainz and Frederick of Tyrol, and spared no pains to bring about dissension between Sigismund and the Council.

The assembled clergy may be divided roughly into two parties: the reformers, and the conservative or ultramontane party. The reformers were not in favour of any radical change in the Church. They were if any-
Clerical parties.
thing more vehemently opposed than their antagonists to the doctrines of Wyclif and Hus. Such reform as they desired was aristocratic rather than democratic. They had no intention of weakening the authority of the Church; but within

the Church they desired to remove gross abuses, and to strengthen the hierarchy as against the Papacy. Their chief contention was that a General Council has supreme authority, even over the Pope, and they wished such councils to meet at regular intervals. By this means papal absolutism would be limited by a sort of oligarchical parliament within the Church. The conservatives, on the other hand, consisting chiefly of the cardinals and Italian prelates, had no wish to alter a system under which they enjoyed material advantages. Their object, as it had been at Pisa, was to restore the union of the Church, but to defeat, or at any rate postpone, any schemes of reform.

The Council was opened on November 5, but the meeting was only formal, and no real business was transacted for a **Hus** month. Meanwhile Hus had been followed to **imprisoned.** Constance by the representatives of the orthodox party in Bohemia, who brought a formidable list of charges against the reformer. **John XXIII.** at once saw in this an opportunity for embroiling the Council with Sigismund. Adroitly keeping himself in the background, he allowed the cardinals to take the lead in the matter. They summoned Hus to appear before them, and in spite of his protest that he was only answerable to the whole Council, they committed him to prison. The news that his safe-conduct had been so insultingly disregarded reached Sigismund as he was starting for Constance after the coronation ceremony at Aachen. He arrived on Christmas day, and at once demanded that Hus should be released. The Pope excused himself, and threw the blame on the cardinals. To the king's right to protect his subject the cardinals opposed their duty to suppress heresy. In high dudgeon, Sigismund declared that he would leave the Council to its fate, and actually set out on his return journey. The Pope was jubilant at the success of his wiles. But Sigismund's friends, and especially Frederick of Hohenzollern, urged him not to sacrifice the interests of Germany and of Christendom for the sake of a heretic. This

advice, and the feeling that his personal reputation was staked on the success of the Council, triumphed. Sigismund returned to Constance, and Hus remained a prisoner. From this moment John XXIII. began to despair.

The Pope's position became worse when the Council, copying the procedure of the universities, began to discuss matters, not in a general assembly, but each nation separately. This deprived John of the advantage which he hoped to gain from the numerical majority of Italian prelates attending the Council. Four nations organised themselves: Italians, French, Germans, and English. Over the last three John XXIII. had no hold whatever. To his disgust they treated him, not as the legitimate Pope, whose authority was to be vindicated against his rivals, but as one of three schismatic Popes, whose retirement was a necessary condition of the restoration of unity. When he tried to evade their demand, they brought unanswerable charges against his personal character, and threatened to depose him. He tried to disarm hostility by declaring his readiness to resign if the other Popes would do the same. His promise was welcomed with enthusiasm, but neither Sigismund nor his supporters were softened by it. In spite of the vehement protests of the Elector of Mainz that he would obey no Pope but John XXIII., the proposal was made to proceed to a new election. John had to fall back upon his last expedient. If he departed from Constance he might throw the Council into fatal confusion: at the worst he could maintain himself

as an Antipope, as Gregory and Benedict had done against the Council of Pisa. His ally Frederick of Tyrol was prepared to assist him. Frederick arranged a tournament outside the walls, and while this absorbed public interest, the Pope escaped from Constance in the disguise of a groom, and made his way to Schaffhausen, a strong castle of the Hapsburg count.

For the moment John XXIII. seemed not unlikely to gain his end. Constance was thrown into confusion by the news of

his flight. The mob rushed to pillage the papal residence. The Italian and Austrian prelates prepared to leave the city, and the Council was on the verge of dissolution. But Sigismund's zeal and energy succeeded in averting such a disaster. He restored order in the city, persuaded the prelates to remain, and took prompt measures to punish his rebellious vassal. An armed force under Frederick of Hohenzollern succeeded in capturing not only John XXIII. but also Frederick of Tyrol. The latter was compelled to undergo public humiliation, and to hand over his territories to his suzerain on condition that his life should be spared. No such exercise of imperial power had been witnessed in Germany since the days of the Hohenstaufen, and Sigismund chose this auspicious moment to secure a powerful supporter within the electoral college by handing over the electorate of Brandenburg to Frederick of Nürnberg (April 30, 1415). He thus established a dynasty which was destined to play a great part in German history, and ultimately to create a new German Empire.

The unsuccessful flight of John XXIII. not only enabled Sigismund to assume a more authoritative position in the Council and in Germany: it also sealed his own fate. The Council had no longer any hesitation in proceeding to the formal deposition of the Pope (May 29, 1415). As the two Popes who had been deposed at Pisa had never been recognised at Constance, the Church was now without a head. But instead of hastening to fill the vacancy, the Council turned aside to the suppression of heresy and the trial of Hus. On three occasions, the 5th, 7th, and 8th of June, Hus was heard before a general session. No point in his teaching excited greater animadversion than his contention that a priest, whether Pope or prelate, forfeited his office by the commission of mortal sin. With great cunning his accusers drew him on to extend this doctrine to temporal princes. This was enough to complete the alienation of Sigismund, and

after the third day's trial he was the first to pronounce in favour of condemnation. The last obstacle in the way of the prosecution was thus removed, and Hus was burned in a meadow outside the city walls on July 6, 1415.

With the death of Hus ends the first and most eventful period of the Council of Constance. Within these seven or eight months Sigismund and the reforming party, thanks to the division of the Council into nations, seemed to have gained a signal success. Sigismund had purchased his triumph by breaking his pledge to Hus, and for this he was to pay a heavy penalty in the subsequent disturbances in Bohemia. But for the moment these were not foreseen, and Sigismund was jubilantly eager to prosecute his scheme.

Warned by the experience of its predecessor at Pisa, the Council of Constance was careful not to put too much trust in paper decrees. John XXIII. was not only deposed, but a prisoner.

The Council during Sigismund's absence.

Gregory XII. had given a conditional promise of resignation, and had so few supporters as to be of slight importance. But Benedict XIII. was still strong in the allegiance of the Spanish kingdoms, and unless they could be detached from his cause there was little prospect of ending the schism. This task Sigismund volunteered to undertake, and he also proposed to avert the impending war between England and France, to reconcile the Burgundian and Armagnac parties in the latter country, and to negotiate peace between the King of Poland and the Teutonic Knights. It would indeed be a revival of the imperial idea if its representative could thus act as a general mediator in European quarrels. The Council welcomed the offer with enthusiasm, and showed their loyalty to Sigismund by deciding to postpone all important questions till his return. And this decision was actually adhered to. During the sixteen months of Sigismund's absence (July 15, 1415, to January 27, 1417) only two prominent subjects were considered by the Council. One was the trial of Jerome of Prague, which was a mere corollary

of that of Hus, and ended in a similar sentence. The other was the thorny question raised by the proposed condemnation of the writings of Jean Petit, a Burgundian partisan who had defended the murder of the Duke of Orleans. The leader of the attack upon Jean Petit was Gerson, the learned and eloquent chancellor of the University of Paris. But so completely had the matter become a party question, and so great was the influence of the Duke of Burgundy, that the Council could not be induced to go further than a general condemnation of the doctrine of lawful tyrannicide; and Gerson's activity in the matter provoked such ill-will that after the close of the Council he could not venture to return to France, which was then completely under Burgundian and English domination.

It is impossible to narrate here the story of Sigismund's journey, though it abounds with illustrations of his impulsive **Sigismund's** character and of the attitude of the western states **journey.** towards the imperial pretensions. It furnished conclusive proofs, if any were needed, that however the Council, for its own ends, might welcome the authority of a secular head, national sentiment was far too strongly developed to give any chance of success to a projected revival of the mediæval empire. As regards his immediate object, Sigismund was able to achieve some results. He failed to induce Benedict XIII. to abdicate, but the quibbles of the veteran intriguer exhausted the patience of his supporters, and at a conference at Narbonne the Spanish kings agreed to desert him and to adhere to the Council of Constance (December 1415). But Sigismund's more ambitious schemes came to nothing. So far from preventing a war between England and France, he only forwarded an alliance between Henry V. and the Duke of Burgundy, and though he may have done this in the hope of forcing peace upon France, the result was to make the war more disastrous and prolonged.

When Sigismund reappeared in Constance (January 27,

1417), he found that the state of affairs both in Germany and in the Council had altered for the worse. Frederick of Tyrol had returned to his dominions and had been welcomed by his subjects. The Archbishop of Mainz had renewed his intrigues, and an attempt had even been made to release John XXIII. With the Elector Palatine, formerly his loyal supporter, Sigismund had quarrelled on money matters, and it seemed possible that the four Rhenish electors would form a league against Sigismund as they had done against Wenzel in 1400. Still more galling was his loss of influence in the Council. The adhesion of the Spanish kingdoms Dissensions in the Council. had been followed by the arrival of Spanish prelates, who formed a fifth nation and strengthened the party opposed to reform. The war between England and France had created a quarrel between the two nations at Constance, and the French deserted the cause they had once championed rather than vote with their enemies. Sigismund could only rely upon the English and the Germans: and the question which agitated the Council was one of vital importance. Which was to come first, the election of a new Pope, or the adoption of a scheme of ecclesiastical reform? The conservatives contended that the Church could hardly be said to exist without its head; that no reform would be valid until the normal constitution of the Church was restored. On the other hand, it was urged that no reform was possible unless the supremacy of a General Council was fully recognised; that certain questions could be more easily discussed and settled during a vacancy; that if the reforms were agreed upon, a new Pope could be pledged to accept them, whereas a Pope elected at once could prevent all reform. Party spirit ran extremely high, and it seemed almost impossible to effect an agreement. Sigismund was openly denounced as a heretic, while he in turn threatened to imprison the cardinals for contumacy. But gradually the balance turned against the reformers. Some of the leading German bishops were bribed to change their votes. The head of the English

representatives, Robert Hallam, Bishop of Salisbury, died at the critical moment, and the influence of Henry Beaufort, the future cardinal, induced the English nation to support an immediate election. It was agreed that a new Pope should be chosen at once, and that the Council should then proceed to the work of reform. But the only preliminary concession that Sigismund and his party could obtain was the issue of a decree in October 1417, that another Council should meet within five years, a second within seven years, and that afterwards a Council should be regularly held every ten years.

For the new election it was decided that the twenty-three cardinals should be joined by thirty delegates of the Council, six from each nation. The conclave met on **Election of Martin V.,** November 8, and three days later their choice **Nov. 11, 1417.** fell upon Cardinal Oddo Colonna, who took the name of Martin v. Even the defeated party could not refrain from sharing in the general enthusiasm at the restoration of unity after forty years of schism. But their fears as to the ultimate fate of the cause of reform were fully justified. Soon after his election Martin declared that it was impious to appeal to a Council against a papal decision. Such a declaration, as Gerson said, nullified the acts of the Councils of Pisa and Constance, including the election of the Pope himself. In their indignation the members made a strong appeal to the Pope to fulfil the conditions agreed upon before his election. But Martin had a weapon to hand which had been furnished by the Council itself. It was the division into nations that had led to the fall of John xxiii., and it was the same division into nations that had ruined the prospects of reform. The Pope now drew up a few scanty articles of reform, which he offered as separate concordats to the French, Germans, and English. It was a dangerous expedient for a Pope to adopt, because it seemed to imply the separate existence of national churches; but it answered its immediate purpose. Martin could contend that there was no longer any work for the Council to do, and he dissolved it in May 1418. He set out

for Italy, where a difficult task awaited him. Papal authority in Rome had ceased with the flight of John XXIII. in 1414. Sigismund offered the Pope a residence in some German city, but Martin wisely refused. The support of his own family, the Colonnas, enabled him to re-enter Rome in 1421. By that time almost all traces of the schism had disappeared. Gregory XII. was dead: John XXIII. had recently died in Florence: Benedict XIII. still held out in his fortress of Peniscola, but was impotent in his isolation.

CHAPTER XI

THE HUSSITE WARS AND THE COUNCIL OF BASEL,

1419-1449

Sigismund and Germany—Hussite parties in Bohemia—Crusades against the Hussites—Bohemian victories—Bohemia and Poland—Attempted reforms in Germany—The Crusade of 1427—Reforms of 1427—The Crusade of 1431—Summons of the Council of Basel—Its procedure—Its quarrel with Eugenius IV.—His submission—The Compacts with Bohemia—Civil war in Bohemia—Battle of Lipan—Sigismund acknowledged king of Bohemia—The Council of Basel and reforms—Divisions within the Council—Negotiations with the Greeks—Quarrel of the Pope and Council—Council of Ferrara or Florence—Attitude of France and Germany—The Pragmatic Sanction—Deposition of Eugenius IV.—Election of Felix V.—The Council's prestige declines—Triumph of Eugenius IV.—Reconciliation of Germany to Eugenius IV.—Close of the Council of Basel—Failure of the Conciliar Movement.

THE ultimate failure of the reforming party at Constance had ruined all Sigismund's schemes for the restoration of monarchi-
Sigismund cal authority in Germany. Ready as he was to
and Germany. form magnificent projects, he was equally easily discouraged and turned aside. After quitting the Council he devoted himself to personal and dynastic interests, to the defence of Hungary against the Turks, and to the enforcement of his claim to succeed in Bohemia. Germany and German interests he abandoned almost as completely as his brother had done. The result was a gradual rupture of the friendship that had hitherto existed between himself and Frederick of Brandenburg. The latter had made it his life's task to restore unity to Germany, in order to save that country from internal dissolution and foreign attack. The desertion of Sigismund from what had been a common cause forced

him to change his means, but not his end. Hitherto he had striven to unite Germany under the monarchy, but that was impossible when the king would not undertake to govern. Frederick was forced to scheme for a federal union of Germany which should be independent of, and perhaps hostile to, the monarchy. And the necessity of some such union was made more and more manifest by events in Bohemia.

In Bohemia the news of Hus's death had provoked a storm of indignation, and had intensified the national sentiment of hostility to Germany. Sigismund was regarded with special loathing as a perjured traitor as well as a party to a murder. Even the sluggish Hussite parties in Bohemia. Wenzel shared the sentiments of his subjects. He bitterly reviled his brother for breaking his safe-conduct, ordered that no Bohemian should henceforth appear before a foreign tribunal, and showed special favour to the party which demanded vengeance for Hus's death. Under the leadership of Nicolas of Husinec, lord of the village where Hus had been born, and of John Ziska, already known as a capable military leader, the Hussites made great strides towards ascendancy in Bohemia. The chief doctrine which they advanced was the communion in both kinds. They held that laymen were entitled to receive the cup in the sacrament as well as the priests, and hence, as a religious party, they received the name of Utraquists. But though they were united in this contention, and also in common hostility to Germany and German influences, there were important divisions among the Hussites. The moderate party, or Calixtines, were in favour of a gradual reform, and wished to separate political from religious questions. They were also called Pragers, because they were strongest in the capital and in the University of Prague. In 1420 their demands were formulated in the 'four articles of Prague,' which became the avowed creed of the party. These were: (1) complete liberty of preaching; (2) the communion in both kinds for all Christians; (3) the exclusion of priests from temporal affairs and the holding of

property; (4) the subjection of clergy to secular penalties for crimes and misdemeanours. But side by side with the Calixtines was a radical and democratic party, known as the Taborites. Like the Lollards in England, they mixed up social and religious questions, and advocated republican and even communistic theories.

The death of Wenzel in 1419 added a new element of bitterness to the quarrel between the Hussites and the champions of orthodoxy. The obvious heir to the crown was Sigismund, the only surviving male of the Luxemburg house. But Sigismund was regarded as peculiarly responsible for Hus's death, and as the representative of all that was foreign and anti-Bohemian. It was inevitable that his claim should be resisted, or only accepted on very stringent conditions. At the moment Sigismund was engaged in a Turkish war, and left the government in the hands of Wenzel's widow. But as soon as possible he patched up a truce with the Turks, and prepared to take possession of his new kingdom. Frederick of Brandenburg urged him to adopt a conciliatory policy, to play off one party against the other, and to gain over the moderates by a few concessions in religious matters. But Sigismund was eager to secure the support of the Pope, who was resolutely opposed to any tampering with heresy; and most of his German advisers urged that any concessions to his subjects would make them haughty and disobedient in the future. The counsel of Frederick of Brandenburg was rejected, and in March 1420 Martin v. published a crusade against the Hussites. A German army was to be raised to prosecute the religious war. No decision could have been more disastrous. Party divisions in Bohemia were at once reconciled, and all classes joined in maintaining a national resistance against a common foe. And this resistance was completely successful. Ziska proved to be a general of the first rank. Not only did he give to his troops the cohesion and discipline of a standing

**Crusades
against the
Hussites.**

**Bohemian
victories,
1420-22.**

army, but he introduced innovations which mark an epoch in the history of mediæval warfare. Especially prominent is the excellence of his artillery, and the use which he made of his baggage-waggons. These were formed into a sort of movable fortress, equally formidable both for defence and aggression. The German armies opposed to him were the feudal levies, collected from various states, bound together by no common interests or enthusiasms, and recognising no common discipline or authority. In three successive campaigns—1420, 1421, and 1422—the Germans were routed and driven from Bohemia, until at last the mere rumour of Ziska's approach was sufficient to drive his enemies into disorderly and panic-stricken flight. A contemporary says that the Germans were inspired with such a loathing for heretics that they could not bring themselves to strike them, or even to look them in the face.

After the failure of the third crusade in 1422, Bohemia was left to herself for five years. Nicolas of Husinec had died in 1421, Ziska was carried off by the plague in 1424, Bohemia and the leadership of the militant party passed to and Poland. a general of hardly less ability, Prokop. With the removal of external danger, the bond which had held parties together was broken, the old divisions and quarrels reappeared, and the country was a prey to the horrors of civil war. An attempt was made to identify the common interests of the Slav race in opposition to Germany by offering the crown to Ladislav of Poland. But Ladislav was afraid of compromising his position by an alliance with heretics, and though his nephew Korybut was for a time sent into Bohemia, the opportunity of forming a powerful Slav monarchy on the frontier of Germany was allowed to slip.

Meanwhile the humiliation of successive and crushing defeats had made a profound impression in Germany. The battle of Brescia (*v. p.* 196) had already shown the weakness of German arms; but the failure to crush the Hussites proved that the military and political systems of Germany were equally

rotten. The more patriotic of the princes, like Frederick of Brandenburg, were driven to consider the necessity of some drastic reform. The restoration of monarchical authority was the most obvious remedy for disorder, but the general distrust of Sigismund put that out of the question. The old alliance of the Hohenzollerns with the Luxemburg kings had now come to an end. In 1422 Albert III., the last of the Ascanian electors of Saxony, died, leaving no obvious heir. His only daughter was married to the eldest son of the Elector of Brandenburg. A few years earlier Sigismund would have welcomed the opportunity of increasing the territorial and political influence of his chief supporter in Germany. But things had changed since the Council of Constance, the Hohenzollern claims were disregarded, and the vacant electorate was conferred by Sigismund upon Frederick of Meissen, the founder of the Wettin line in Saxony, which rules there in the present day. This marks the final rupture between Sigismund and the Elector of Brandenburg; and in attempting to reform the constitution of Germany the latter found himself in opposition to his former patron. In 1422 it had been proposed at a diet at Nürnberg to raise a mercenary army in place of the feudal troops, and to defray the expense by levying a general imperial tax of one per cent., 'the hundredth penny,' as it was called. But this project was foiled by the opposition of the towns, who feared that they would have to pay the money while the princes would pocket it. In 1424 the electors formed a close league among themselves, and practically assumed to act as if they were the joint heads of a federation. Sigismund was furious at this open disregard of his authority, and prepared to go to war against Frederick of Brandenburg and his associates. Hostilities had actually broken out, when the news arrived that the Hussites, who had hitherto been content with standing on the defensive, were invading the neighbouring German provinces. The Pope was roused by this to make new efforts for the success of a crusade, and he

Attempted reforms in Germany.

appointed Cardinal Beaufort, the uncle of Henry vi. of England, to act as papal legate. At the same time another attempt was made to strengthen the military organisation of Germany. At a diet at Frankfort (April 1427) the old mode of levying troops was abandoned, and it was agreed that one out of every twenty adult males should be chosen by lot. In this way it was hoped to eradicate the provincial jealousies, which had hitherto been a fatal source of discord. Frederick of Brandenburg was to act as commander-in-chief. But the financial difficulty was still in the way. None of the proposed taxes could be carried, and at last they had to fall back upon the tenths granted by the Pope and a poll-tax on the Jews. The army collected was the largest The fourth that had yet been employed in the war; but the crusade, 1427. result was all the more ignominious. On the news that Prokop and his dreaded Taborites were at hand, the crusaders fled in headlong confusion. On the frontier they were met by Cardinal Beaufort, who implored them to return, and in his rage tore the imperial standard to pieces, and trampled it underfoot. But it was all in vain, and the legate was swept away with the panic-stricken mob.

This was the most ignominious reverse yet experienced, and under the impression which it produced a new diet at Frankfort hastened to adopt the most far-reaching Reforms of reforms. A regular income-tax was imposed, and 1427. a general poll-tax graduated according to rank. The revenue thus derived was to be collected by local delegates, and paid to the central power. But this central power was not the German monarchy. The two commanders-in-chief, Cardinal Beaufort and Frederick of Brandenburg, were to be aided by a council of nine, consisting of one nominee of each of the six electors, and three representatives of the imperial towns. This body was authorised to raise fresh troops, or to levy additional taxes. Such an arrangement amounted to a practical deposition of Sigismund, whose authority was transferred to this new federal council. But the reform was little more

than a paper scheme. The forces of disunion were too strong to be readily overcome. Much of the money remained unpaid, and in consequence the troops could neither be raised nor equipped. Frederick of Brandenburg was forced to fall back upon the policy of negotiation which he had always favoured. He saw clearly that every invasion of Bohemia strengthened the extreme party, and that the only prospect of settlement lay in gaining over the moderates to the German side. But the negotiations were foiled by the irresolution of Sigismund, the discord among the German princes, and the obstinacy of the Pope. Cardinal Beaufort was ordered to lead a new crusade in 1429, but he found it necessary to disarm domestic opponents by sending the troops he had raised to serve in France. Martin v. was furious but impotent. In 1430 he appointed a new legate, Cardinal Cesarini, in Fifth place of Beaufort, and in 1431 a German army crusade, 1431. was at last collected on the principles laid down in 1427. In August it crossed the frontier, and encamped under the walls of Tauss. But on the news of Prokop's approach, the old panic set in, and the troops fled in confusion. With the so-called battle of Tauss the fifth crusade, the last effort to crush the Hussite by force of arms, came to an end. The war had lasted twelve years, and had given convincing proofs of the evils of provincial disunion, but it had come two centuries too late to inspire the Germans with a sense of national duties and interests. From this time the only hope of restoring peace in eastern Europe lay in the proceedings of the General Council, which had already been summoned to meet at Basel.

One of the most important decrees of the Council of Constance had provided for the sequence of future councils; and though Martin v. looked upon the arrangement with profound mistrust, he dared not wholly disregard it. The first of these assemblies met in 1423, first at Pavia and then at Siena. It was attended only by Italian prelates, who were easily manageable, and it was

Summons of
the Council of
Basel, 1431.

dissolved without passing any important enactments except that its successor was to meet in 1431 at Basel. As the time approached Martin began to be filled with dread of another Council beyond the Alps. But the condition of Europe was too disturbed, and the danger too great of allowing Bohemian heresy to spread, for him to run the risk of alienating Germany by changing the place of meeting. On February 1 he ordered the Council to meet on March 4, and appointed Cardinal Cesarini to preside as his representative. On February 20 Martin v. died, leaving his successor Eugenius IV. to face the dangers and difficulties which he foresaw.

Very few prelates appeared in Basel at the appointed date; but the defeat of the Germans at Tausss suddenly gave great importance to the Council, as offering the only prospect of the conclusion of peace. In September Cesarini arrived from Bohemia, and from this time numbers rapidly increased. The first matter for consideration was the method of procedure. It was decided to abandon the division into nations, which had been tried at Constance, on the ground that national jealousy weakened the unity of the Council. Instead, the Council was to be divided into four deputations, composed of representatives from each nation. Each deputation was to consider a separate subject: (1) the restoration of peace; (2) matters of doctrine and faith; (3) the reform of the Church; (4) the general business of the Council. When a matter had been discussed in a deputation, it was to be brought before the whole Council, and votes were to be taken by deputations. If they were equally divided, the deputations were to be re-formed, and the question debated afresh. A committee of twelve was formed to arrange the division into deputations, and to decide on the right of any individual to take part in the Council. From the first this committee took a very broad view in this matter, and the result was that the Council soon began to assume a democratic character. At Constance the great prelates and university dignitaries had been the dominant

force: at Basel power tended to fall into the hands of the mass of the clergy.

The most pressing business of the Council was to negotiate with the victorious Hussites, and under the influence of Cesarini it was decided to invite the Bohemians to send delegates to Basel. This gave the greatest umbrage in Rome, where the dangers from Bohemia were less keenly felt, and the prejudice against any dealings with excommunicated heretics was strongest. Eugenius IV., who was much less prudent and statesmanlike than his predecessor, determined to check such dangerous proceedings at the outset. On December 18, 1431, he issued a bull dissolving the Council, and summoning another to meet in eighteen months at Bologna. The bull dropped like a bomb-shell in the peaceful deliberations of Basel, where no thought of the possible displeasure of the Pope had been entertained. But after the first feeling of dismay, it was resolved to resist. Cesarini was profoundly convinced that the dissolution of the Council would result in the complete alienation of Germany and the triumph of the Hussite heresy, and he wrote an earnest letter to explain his views. Sigismund and all the princes whose interests demanded peace were inclined to support the Council, which was thus emboldened to make a firm stand against the Pope. In February 1432 it was decided that a General Council could not be dissolved without its own consent; and in April the Pope and cardinals were ordered to present themselves at Basel within three months. A new schism seemed likely to break out, not as before between rival heads of the Church, but between the Church itself and its head. The contest was between parliamentary and despotic authority, and it was as difficult in the Church as in the State to reconcile their rival pretensions.

In the end the Pope was forced to give way, partly by the pressure of secular interests, and partly by the difficulties in which he was involved in Italy. In 1432 Sigismund came to Rome to receive the imperial crown from the Pope, and

refused to abandon the cause of the Council, which he hoped might secure his tardy recognition in Bohemia. In 1433 the partiality of Eugenius for his native city of Venice involved him in a quarrel with Filippo Maria Visconti. The mercenary troops of Milan, aided by the Colonnas, whom Eugenius sought to abase from the position Martin v. had given them, laid siege to Rome, and the Pope could only save himself from imprisonment by an ignominious flight to Florence. In these circumstances he could hardly hope for a victory over the recalcitrant Council, and in December 1433 he abandoned the unequal contest. He declared the Council of Basel to be a lawful œcumenical council, and confirmed its decrees.

The papal recognition came in time to give increased importance and authority to the Council's negotiations with the Bohemians, which had been carried on without interruption during the quarrel with Eugenius. Bohemian deputies, including Prokop himself—as redoubtable a theologian as he was a general—had been admitted to Basel at the end of 1432, and had carried on for three months a disputation with the speakers of the Council. The basis of discussion was supplied by the four articles of Prague, and, thanks to the conciliatory temper of Cesarini, the controversy had rarely gone beyond the decencies of orderly debate. No definite agreement was arrived at at Basel, but it was agreed that delegates from the Council should in their turn proceed to negotiate with the diet at Prague. There, after infinite labour, a rudimentary compromise was arranged in what are called the *Compactata*. On the great question of the cup the Council had to give way, and the Bohemians and Moravians were to be allowed to receive the communion in both kinds. Liberty of preaching was nominally conceded, but it was added that priests must be ordained by their ecclesiastical superiors, and that the authority of bishops must be obeyed. Clergy were to be punished for crimes 'according to the law of God and the ordinances

Submission
of the Pope.

The
Compacts
with
Bohemia.

of the fathers.' On the question of clerical property the Council gained the day. The right of the Church to possess and administer heritable property was fully recognised, and it was declared sacrilege for a layman to interfere with it.

The *Compactata* were very far from being an authoritative treaty, but their importance lies in the fact that they secured the approval of the nobles and moderate party in Bohemia. Bohemia, who had long desired the restoration of peace and order. The Taborites and the army, on the other hand, were resolute in condemning the proposed terms, and the quarrel developed into open war. At Lipan, in April 1434, the Taborites found themselves confronted by men who had learned tactics in the same school as themselves. They were enticed from their waggon-fortress by a feigned flight, while a troop of cavalry cut off their retreat. Prokop himself was slain, and the army, which had been so long the terror of Europe, was almost wholly cut to pieces. With the downfall of the extreme party the chief difficulty in the way of the restoration of the monarchy was removed. But the nobles were not prepared for an unconditional submission to Sigismund. They demanded, among other things, a complete amnesty and the exclusion from office of all who refused to receive the communion in both kinds. Sigismund found it necessary to at any rate feign compliance, and in August 1436 he made his formal entry into Prague. As a European question the Hussite movement may be regarded as having come to an end. Not that Bohemia was really pacified, or that the doctrines of Hus had been abandoned, but all danger of any general adoption of these doctrines in central Europe had disappeared. As long as the Hussites were supported by the forces of national enthusiasm they had been irresistible: their defeat was due to their own dissensions.

In 1434 the Council of Basel was at the height of its power and reputation. Eugenius IV. had been forced to recognise its authority. Its negotiations with the Bohemians had not

indeed produced a definite treaty, but they had resulted in dividing the moderate from the extreme party, and the defeat of the latter had brought a peaceful settlement within measurable distance. Encouraged by these successes, the Council undertook with energy the task of reforming the Church. A series of decrees show how strong was the dislike of the despotic rule of the Papacy.

Reforming
activity of
the Council.

Papal reservations, by which the right of patrons to appoint to benefices was evaded, were declared illegal. The establishment of diocesan and provincial synods was recommended. Appeals from the decision of a bishop to Rome were forbidden. But these measures were surpassed in boldness by an edict of June 1435, which forbade the payment of annates, or the first year's revenue of a bishopric or benefice. This threatened to deprive the Pope of his chief source of revenue, and provoked a violent outcry from the cardinals and officials of the Curia. But Eugenius IV., still an exile from Rome, did not feel strong enough to resist. He accepted the decree, only asking that some compensation in the way of national contributions should be given him. This pusillanimity encouraged the Council to further attacks on the papal power. The unrestricted right of the chapters to elect bishops was confirmed: all papal commendations were done away with: appeals from a General Council to the Pope were declared to be heretical.

The extreme measures of the Council were fatal to its unity. It was felt that many of the decrees were inspired by French and German antipathy to Italian preponderance in the Church. At the same time the numerical majority of the lower clergy was regarded with growing mistrust by the bishops and other dignitaries. Reforms might begin with the Papacy, but were not likely to stop there. Cesarini and other moderate men, who had supported the Council as long as the Bohemian negotiations were at a critical stage, were now inclined to rally to the cause of the Pope. This growing papal party found an active and unscrupulous leader in the Bishop of Taranto, whose aim was

Divisions in
the Council.

to bring about an irreconcilable quarrel between the Pope and the Council. On the other side, the reforming and anti-Italian party was headed by the Cardinal Archbishop of Arles, a prelate of unquestioned piety and learning, but a resolute antagonist of the Papacy and perhaps a personal enemy of Eugenius iv. On the same side was a man destined to play an important part in the history of the Council and of Christendom, Æneas Sylvius Piccolomini. He was a native of Siena who had come to Basel in the suite of the Bishop of Fermo, and had since acted as secretary to various prelates. He had made a name for himself by his oratorical powers, the purity of his Latin style, and his diplomatic ability. He had attached himself to the reforming party, but no one suspected him of having any firm convictions, and those who knew his easy and pleasure-loving nature can have had little expectation that he would one day rise to the headship of the Church. Between the two extreme parties at the Council was a moderate section, headed by a Spaniard, John of Segovia, but it was neither numerous nor important.

The quarrel within the Council and the growing hostility between the Council and the Pope were both brought to a head by the negotiations with the Greeks. The eastern Emperor, John vi., though not actually at war with the Ottoman Turks, felt that they were closing round him on every side, and that an attack on Constantinople was before long inevitable. In his despair he appealed for the assistance of western Europe, and was prepared to purchase it by sacrificing the independence of the Greek Church. The idea of uniting the Eastern and Western Churches had long been cherished by the Popes, and Eugenius iv. was the more eager to take the matter up as it offered the prospect of a triumph over the hated Council of Basel. But the Greeks were fully aware of the divisions in the Western Church, and sent envoys to the Council as well as to the Pope. Hence arose an eager competition as to which should gain control of the negotiations. The Council

**Negotiations
with the
Greeks.**

offered to send a fleet to bring the Greek prelates to the coast, and to pay all the expenses of their stay at Basel. To raise the money necessary for the fulfilment of these promises, the Council usurped a papal prerogative and issued indulgences to those who would contribute to the union of the Churches. Eugenius, on his side, issued a memorial to the princes of Europe, in which he enumerated the misdeeds of the Council, and promised to undertake the reform of the Church with the aid of another Council, which for the sake of the Greeks would be held in some Italian city.

Meanwhile the Greek question had provoked violent disputes in Basel. The papal legates proposed that for the convenience of the Greeks they should adjourn either to Florence or to Udine in the territories of Venice. The moderate party suggested Pavia, as being less dependent upon the Pope, and this received the support of Æneas Sylvius, who was beginning to veer round to the papal side. But the extreme party would not hear of either proposal. The Archbishop of Arles moved that the Council should remain at Basel or, if the Greeks preferred it, should adjourn to Avignon. The debates were marked by the most unseemly behaviour, and it was with difficulty that the reverend fathers could be restrained from laying violent hands upon each other. The motion of the anti-papal party was carried by more than three-fifths of the Council; but the next morning it was discovered that this had been abstracted, and that the decree of the papal minority, duly signed and sealed, had been put in its place. This audacious piece of trickery was attributed to the Archbishop of Taranto, and so great was the indignation against him that he found it advisable to flee to Italy, where he was rewarded by Eugenius with the cardinal's hat. And the anger of the majority was not diminished when they learned that the Greeks had been persuaded to accept the papal invitation to attend a Council in Italy. The Council was driven to the most extreme measures to try and discredit the Papacy.

Open quarrel
between
Pope and
Council.

In July 1437 the Pope and cardinals were summoned to appear at Basel within sixty days to answer the charges brought against them. On October 1 Eugenius was pronounced contumacious for not having obeyed the summons. The Pope, on his side, had issued a bull (September 18) dissolving the Council at Basel, and summoning an assembly to meet at Ferrara in order to effect the union of the Churches. There was no longer any room in Basel for partisans of the Papacy, and by the beginning of 1438 Cesarini and all who were frightened by the extreme measures of the Council had crossed the Alps.

Eugenius presided at the Council which met at Ferrara in 1438 and on the outbreak of the plague was transferred to Florence. Months were spent in futile debates on the differences between the two Churches. By far the most prominent subject of discussion was the great *filioque* controversy. The Latin Church had added these words to the original wording of the creed as fixed at the Council of Nicæa, while the Greek Church had never adopted them. The other differences which gave rise to debate were the use of leavened or unleavened bread in the sacrament, the doctrine of purgatory, and the papal supremacy. The Greek Church, as the petitioning body, was ultimately forced to accept, without being convinced, the Roman views on all four questions. A decree for the union of the two Churches was drawn up, and Eugenius thought he was celebrating the crowning triumph of the Papacy (July 6, 1439). But, as far as actual results went, the triumph was premature. The Greeks at home refused to accept the decision of their representatives, and clamoured that they had been betrayed. Nor did John VI. gain any aid to make up for the unpopularity he had incurred. Western Europe was fatally divided against itself, and paid little heed to the safety of Constantinople. The union of the Greek and Latin Churches remained a mere document.

The quarrel between the Pope and the Council of Basel

Council of
Ferrara or
Florence,
1438-9.

had become irreconcilable when the latter was deserted by all the adherents of Eugenius, and when Cesarini was succeeded as president by the Archbishop of Arles. The result of the quarrel could only be decided by the adhesion of the secular states to one side or the other. The two states to which the Council chiefly looked for support were Germany and France, the countries from which most of the remaining members were drawn. But these two states, instead of warmly espousing the cause of the Council, seemed rather inclined to take advantage of the schism to establish their own ecclesiastical independence. In 1438 a synod of French clergy accepted the famous Pragmatic Sanction of Bourges, the foundation of the liberties of the Gallican Church. This measure adopted, in the special interests of France, most of the decrees against the papal power which had been carried in the Council as applying to the whole Church. France was beginning to recover from the prolonged wars with Burgundy and England, and the Pragmatic Sanction offered the supreme advantage of checking the drain of French wealth to fill the coffers of the Pope. In Germany Sigismund had died in 1437, and the electors and leading princes began by adopting a policy of strict neutrality between the Council and the Papacy. But the policy adopted by France offered temptations both to lay and clerical princes, and a diet at Mainz drew up what was practically the German equivalent of the Pragmatic Sanction of Bourges. Annates were to be abolished, papal reservations and provisions forbidden, provincial and diocesan synods organised. The conception of national churches, which had been encouraged by Martin v.'s concordats at Constance, seemed in 1439 to be strong enough to rend the Church in pieces.

Attitude of
France and
Germany.

Pragmatic
Sanction of
Bourges, 1438.

Pragmatic
Sanction of
Mainz, 1439.

The loss of temporal support and the apparent success of the rival assembly in Italy did not soothe the temper of the councillors at Basel. In spite of the vigorous opposition of

the moderate party, they proceeded to accuse Eugenius IV. of heresy and schism, and by a decree of June 25, 1439, he was formally deposed. It was now determined to proceed to a new election. As the Archbishop of Arles was the only cardinal at Basel, it was decided that he should be aided by thirty-two delegates from the Council. The task of election was a difficult one, as the poverty of the Council made it necessary to choose a Pope who could afford to defray his own expenses. At the fifth scrutiny it was found that twenty-six votes had been given for the Duke of Savoy, who was declared Pope, with the name of Felix V. From the first he disappointed the hopes of his electors. Although he had been living in retirement since the death of his wife and had amassed a considerable treasure, he had no intention of maintaining himself and the Council from his private funds. He demanded that he should receive a revenue as Pope, and the Council was forced to go back on its own decrees and to grant him a fifth of ecclesiastical revenues for a year. This measure was certain to alienate all who had supported the Council in the hope of diminishing clerical taxes, and as a matter of fact the tax was only paid within the territories of Savoy. From all points of view the election was a very disadvantageous step. It disgusted those who had hoped for a substantial measure of reform from the Council of Basel. As long as the dispute was between a General Council and the Pope, there were certain principles at stake which might induce men to give energetic support to one side or the other. But by its last act the Council had merely revived a personal schism, of which Europe was already profoundly weary. The Council of Basel continued to exist for nine years after the election of Felix V., but every year its numbers and its influence steadily declined. Even the Antipope quarrelled with the assembly to which he owed his appointment. In 1444 Felix quitted Basel and took up his residence at Lausanne.

Deposition of Eugenius IV., 1439

Election of Felix V.

Declining prestige of the Council.

The ultimate victory of Eugenius IV. was assured by the mistakes of his opponents. It only remained for him to complete his triumph by securing the support of the temporal powers of Europe. While he resided in Florence his legates succeeded in restoring the papal supremacy in Rome, and in 1443 he was able once more to return to his capital city. He was careful to avoid the mistakes in Italian politics which had cost him so dear in 1433. Even his arch-opponent, Filippo Maria Visconti, was gained over to his side. The recognition of France was purchased by the countenance which the Pope gave to the Angevin cause in Naples. But when the Neapolitan war ended in the victory of Alfonso of Aragon, Eugenius adroitly changed sides without forfeiting the French allegiance. He had thus put an end to all serious opposition in Italy. England and the Spanish kingdoms took little interest in the schism, and had no motive for supporting Felix V. There remained Germany, which had openly declared for a policy of neutrality. Until the German king and princes could be gained over, the revival of papal authority was incomplete. The task of effecting the reconciliation of Germany was undertaken and accomplished by one man, Æneas Sylvius Piccolomini.

The kingship of the Romans was transferred on the death of Sigismund to his son-in-law, Albert of Austria. But Albert died within two years of his elevation, and in 1440 the choice of the electors fell upon another Hapsburg, Frederick III., Duke of Styria and Carinthia, and guardian in Austria of Albert's infant son, Ladislas Postumus. As soon as Frederick had settled family affairs in the east, he came to Germany in 1442 to receive the crown at Aachen and to consider the question of the schism. Envoys from Basel and from Eugenius IV. had already appeared before the German diet, but their exhaustive arguments had not led to any decision, and the neutrality was still observed. In 1442 Frederick III. visited Basel, and there took into his service Æneas Sylvius. The

Reconciliation of Germany to the Roman Pope.

latter was convinced that the cause of Council and Antipope was hopeless, and determined to win his own pardon and advancement by rendering some conspicuous service to Eugenius iv. His diplomacy was as successful as it was unscrupulous. By 1445 he had succeeded in arranging terms between his master and the Pope. Frederick undertook to restore Germany to its obedience to Rome; and Eugenius in return promised to give him the imperial crown, to allow him the nomination to certain bishoprics and benefices, and to grant him a substantial bribe from the ecclesiastical revenues. It was a disgraceful treaty, and in spite of the secrecy with which it was negotiated, it became known that some such agreement was being made. The German princes were indignant at what they considered a betrayal, and were resolute to vindicate their own independence of their elected king. The electors of Trier and Köln, together with a number of electoral princes, determined, as a protest against Frederick's conduct, to adhere to Felix v. Thus the policy of neutrality was abandoned, and Germany was split into parties on the question of the schism. To make matters worse, Eugenius iv., emboldened by his treaty with the King of the Romans, issued a bull in February 1446 declaring the Archbishops of Köln and Trier to be deprived of their sees as heretics and traitors. This rash act seemed to make reconciliation impossible. But Æneas Sylvius was equal to the occasion. The electors issued the most extreme demands: that the Pope should withdraw his bull against the two archbishops, that he should confirm the Pragmatic Sanction of 1439, acknowledge the supremacy of General Councils, and summon a new council to meet in Germany in 1447. Æneas Sylvius journeyed to Rome, where he persuaded Eugenius to restore the two archbishops, and to return a moderate answer to the electoral demands. Then he proceeded to Germany as papal envoy, bribed the Archbishop of Mainz to desert the electoral league, and did not hesitate to alter the wording of the papal answer in order to conciliate German pride. By

these means he avoided an open rupture, and induced the diet at Frankfort to agree to terms, in spite of the protests of the Archbishops of Köln and Trier. Then Æneas Sylvius hurried back to Rome, with envoys from the diet, in order to explain and justify his conduct to the Pope. He found Eugenius iv. on his death-bed, and it was necessary to hasten matters in order to avoid the complications that might arise with a new election. A provisional concordat was patched up. A new council was to meet in some German town, but only if the German princes were agreed. The supremacy of a council was recognised, but in the most general terms, so as to avoid any reference to the assembly at Basel. The Pragmatic Sanction and the suspension of annates were temporarily confirmed, until some final arrangement could be agreed upon. These terms were accepted by Eugenius on February 23, 1447, and four days later he died. His successor was the famous scholar and collector, Thomas of Sarzana, who took the name of Nicolas v. He was wise enough to follow the recent policy of his predecessor in German affairs. Æneas Sylvius returned to Germany to complete his work. The malcontent princes were gained over by separate negotiations. When the obstinate Archbishop of Trier was induced to acknowledge Nicolas v., opposition in Germany was at an end. The final concordat was arranged in 1448, and was based upon the provisional terms of the previous year. The clauses about the Council were accepted as they stood, but on the other points the Pope gained substantial advantages. Annates were restored, and the restrictions which had been placed upon papal patronage by the Pragmatic Sanction were for the most part repealed.

It only remained to get rid of the moribund Council of Basel. A few bishops from Savoy and some clergy of humble rank were the only members left. Frederick III. sent an order for the dissolution of the Council to the civic magistrates. The exiled members proceeded to Lausanne, and there, by the mediation of

End of the
Council of
Basel, 1449.

France, made terms with the Papacy. Felix v., who had never received the homage of a temporal sovereign, resigned the papal title in exchange for the cardinal's hat. The Archbishop of Arles returned to his see, where he was universally beloved. He died in 1450, and in the next century was canonised by Clement VII.

With the Council of Basel ended the conciliar movement for reform, which had resulted from the scandal of the great schism. It had failed, not from any lack of honest purpose, or from the blunders of its adherents, but because it was out of harmony with the conditions of the age. A few centuries earlier it might have been possible to reform the Church, and at the same time to retain its unity. But by the fifteenth century such a scheme was too late. Political division had advanced so far as to bring with it ecclesiastical divisions. The sentiment that was recognised in the concordats of Martin v. and asserted in the Pragmatic Sanctions of Bourges and Mainz, was stronger than the theory of the supremacy of a general council over the Pope. The Reformation of the sixteenth century was a series of national revolts against papal domination, and it owed its success to its harmony with political conditions and interests.

The failure of the conciliar movement brought with it a revival of papal authority. The reaction which had commenced under Martin v. seemed to be complete under Nicolas v. The great jubilee which was held in Rome in 1450 was a fitting celebration of the papal triumph. But it proved to be only a Pyrrhic victory. The Papacy learned neither wisdom nor toleration from the trials through which it had passed. While continuing to trample on the spirit of individual freedom, the Popes, in their greed for temporal dominion, gave rise to scandals far more glaring from the moral point of view than the senile bickerings of the schism. The Protestant revolution more than avenged the defeat of the Councils of Constance and Basel.

CHAPTER XII

MILAN AND VENICE IN THE FIFTEENTH CENTURY,

1402-1494

Disruption of the duchy of Milan after the death of Gian Galeazzo Visconti— Venice acquires Eastern Lombardy as far as the Adige—Wars between Venice and Sigismund—Filippo Maria Visconti restores the duchy of Milan—Wars between Venice and Milan—Venetian frontier extended to the Adda—Death of Filippo Maria—Venice and Francesco Sforza—Peace of Lodi—Deposition and death of Francesco Foscari—Venice and the Turks—Treaty of Constantinople—War with Ferrara—Acquisition of Cyprus—Decline of Venice—Francesco Sforza in Milan—His relations with France—Galeazzo Maria Sforza—His assassination—Regency of Bona of Savoy—Ludovico il Moro—His relations with Naples—Calls in Charles VIII. of France.

THE anarchy in the duchy of Milan, which followed the death of Gian Galeazzo Visconti in 1402, illustrates at once the ability of its founder and the difficulties which he had succeeded in overcoming. He left his dominions to his two legitimate sons, Gian Maria and Filippo Maria, who were to rule in Milan and Pavia respectively under the guardianship of their mother. But the widowed duchess, Caterina, proved wholly unable to wield the power which her husband left in her hands. The *condottieri*, who had shown such unwonted loyalty to Gian Galeazzo, seized the opportunity to carve out principalities for themselves. In nearly every city of Lombardy the lordship was seized by some adventurer, who sought to make himself independent. In Milan itself the cruelties with which Caterina sought to put down disorder provoked an insurrection. The duchess was imprisoned and poisoned

(1404), and Gian Maria was intrusted with the government under the guidance of a council of citizens. But Gian Maria carried the cruelty and debauchery of his predecessors to the verge of insanity. The only use which he made of his power was to gratify his monstrous passions by the torture of his fellow-creatures. At last some semblance of order was restored by Facino Cane, one of the most eminent generals in the service of Gian Galeazzo. On the death of his employer he had made himself master of Alessandria, Tortona, and other western towns. Later he had assumed the regency for Filippo Maria in Pavia, and he now reduced Gian Maria to similar submission. This authority he held till his death, when the Milanese nobles, rather than allow Gian Maria to recover the government, assassinated that youthful monster in 1412.

These disorders in Lombardy naturally led to the loss of the southern acquisitions of Gian Galeazzo. The hostility of Pope Boniface ix. had to be bought off by the restoration of Romagna and Perugia to the papal states (1403). Siena recovered its republican liberties in 1404, and Paolo Guinigi maintained his rule in Lucca as an independent prince. Pisa, the most important of the Milanese conquests, had been bequeathed by Gian Galeazzo to a bastard son, Gabriele Maria. But Gabriele, finding himself unable to face the double danger of Pisan rebellion and Florentine attack, became the vassal of France in order to gain the aid of Marshal Boucicault, the French governor in Genoa. Within a year, however, he had quarrelled with his suzerain: the policy of France ceased to be hostile to Florence: and so the strange spectacle was seen of Boucicault and Gabriele, in mutual enmity, selling their sovereign rights to Florence, while the Pisans repudiated the authority of both and reclaimed their old independence (1405). The Florentine oligarchy was prompt to seize the opportunity that had long been looked for, and a strict blockade forced Pisa to surrender after an obstinate resistance of many months (October 9, 1406). By the reduction

of the rival republic, Florence took the first great stride towards the formation of the later grand duchy of Tuscany.

But the most notable result of the temporary decline of Milan was the permanent establishment of Venetian dominion in Eastern Lombardy, an event fraught with the most momentous consequences both for Venice and for Italy. Francesco Carrara, who had recovered Padua in 1390, and had been allowed to retain it under tribute to Milan (see p. 180), was one of the first princes to take advantage of Gian Galeazzo's death to obtain both freedom and aggrandisement. In alliance with the surviving members of the house of della Scala he seized Verona, and then got rid of his allies in order to keep his conquest to himself (1404). From Verona he advanced to the siege of Vicenza, but the citizens offered the lordship to Venice, while the duchess Caterina, beset with difficulties in Milan, also appealed for aid to the maritime republic. This double invitation, together with the traditional enmity to the Carrara family, overcame any reluctance on the part of the Venetians. They agreed to aid the duchess on condition that all Milanese territory to the east of the Adige should be ceded to them. Caterina accepted the terms, hard as they were, and in June 1404 Venice declared war against the lord of Padua. Vicenza opened its gates to the Venetians, and in the course of 1405 both Verona and Padua were compelled to surrender to superior forces. Francesco Carrara was carried off to die in a Venetian prison.

Venice had now recovered and enormously extended the territories she had lost in the war of Chioggia. Not only Treviso, Feltre, and Belluno, but Bassano, Verona, Vicenza, and Padua acknowledged her sway. And before long she was in possession of another province, Dalmatia, which she had gained from Hungary, and lost again in the previous century. Pope Boniface ix., engaged in a quarrel with Sigismund of Hungary, had stirred up Ladislas of Naples to revive his father's claim to the

Venice acquires Verona and Padua.

Venice at war with Sigismund.

Hungarian crown (see pp. 154 and 191). In 1402 Ladislas had landed at Zara in Dalmatia, and was crowned king by the papal legate. But his early success was followed by reverses, and, discouraged by the memory of his father's fate, Ladislas returned to Naples. But he was not unwilling to cause annoyance to his successful rival, and in 1409 he sold his rights in Dalmatia to Venice. This led to a prolonged war with Sigismund, who in 1411 was recognised as king of the Romans, and desired to gain distinction and authority in Italy. In 1411 his troops occupied Feltre and Belluno, but they were defeated in the open field by Carlo Malatesta in the service of Venice. In 1413 a truce put an end to hostilities for a time, and Sigismund was enabled to concentrate his attention on ecclesiastical questions and the council of Constance. But the possession of Dalmatia was still a subject of dispute, and war was renewed in 1418. Sigismund, however, was occupied with the difficulties which the execution of Hus had excited in Bohemia, and Venice met with little efficient opposition. By 1421 the province of Friuli and almost the whole of the Dalmatian coast were subject to Venetian rule.

Meanwhile important events had taken place in Milan. On the murder of his elder brother, Filippo Maria Visconti Filippo Maria had emerged from the obscurity in which he had Visconti. previously lived, and showed himself not unfitted to fill his father's place. With even greater personal cowardice, which induced him to conceal himself almost entirely from human vision, he combined the same subtle powers of intrigue, and the same ability to discover and make use of military talent in others. Only two defects of character prevented him from achieving the same measure of success as had fallen to Gian Galeazzo. He was less resolute in the pursuit of his ends, and momentary discouragement led him at times to relinquish an object when it was almost within his grasp. And his inveterate habits of suspicion involved him not infrequently in serious danger by driving into opposition

the men who were capable of rendering him the most valuable services. It was impossible to be loyal to a prince who distrusted a victorious general even more than he dreaded to hear of a defeat.

The first act of Filippo Maria was to marry the widow of Facino Cane, although she was twenty years older than himself. By this means he acquired Alessandria, Tortona, Novara, and Vercelli, and also the control of Facino's numerous and disciplined troops. With their aid he made himself master of Milan and avenged his brother's death. Once secure in his position, he did not scruple to rid himself of his elderly benefactress, whose age rendered her an unsuitable spouse. In the attack upon Milan he had noted the courage and conduct of Francesco Carmagnola, who took his name from the village near Turin where he had been born. He raised the Piedmontese soldier to the command of his army, and employed him to reduce to submission the cities which had formerly owned his father's sway. One after another the despots who had usurped authority since the death of Gian Galeazzo were compelled to surrender, and by 1421 the duchy of Milan extended from Piedmont in the west to the line of the Adige in the east. Even Genoa, which had freed itself from French rule in 1411, was forced after a prolonged struggle to acknowledge the suzerainty of Filippo Maria.

Thus Venice, at the very moment of her successful expansion eastwards, found herself confronted on her western border by a prince who could advance weighty claims to the most valuable of her recently acquired dominions. The republic was thus called upon to solve one of the most serious problems of her whole history. Hitherto power on the mainland had come to her in the course of events; it had been the product of her obvious interest in protecting her trade routes and the sources of her supply of food. There had not as yet been any deliberate going out of her way to seek for territories. But her most

pressing interests were now secured, and the question at once arose whether she could or would stop at the point which she had reached in 1421. Upon this question were formed the two great parties which divided Venice during the remainder of the century. The Doge, Tommaso Mocenigo, who held office from 1414 to 1423, urged the maintenance of the *status quo* as the only means of retaining that maritime supremacy which was essential for the defence of the overwhelming interests of Venice in the east. To enter into Italian politics as the avowed rival of Milan for ascendancy in Lombardy would inevitably result in handing over the Levant to the Turks. And if Venice lost her commerce, she would find territorial dominion, which she could only gain and keep by employing hired foreigners in place of her own citizens, a very unsatisfactory source either of wealth or of political greatness. On the other hand, many of the younger nobles, headed by Francesco Foscari, laid stress upon the undoubted interests of Venice on the mainland, and upon the certainty that the duke of Milan would never abandon his claims to Verona and Padua. They contended with vehemence that the western frontier as it stood was hopelessly insecure, that a state must either advance or lose ground, and that aggression is often the only means of defence. But the policy of this party was really inspired less by these arguments, sound as they were in some respects, than by the instinctive greed for territory which had become the guiding motive of the great Italian states.

The difference between the two parties was brought to a head in 1423 by the appearance of successive embassies from Florence to demand aid against the duke of Milan. Filippo Maria had resumed his father's schemes of aggression in Tuscany and the Romagna. Florence was forced into war to defend her independence, and her troops suffered one defeat after another. Nothing but the intervention of the great northern republic seemed likely to arrest the duke's progress, and the appeals to Venice became

more and more pressing. The first embassy in 1423 had been repulsed by the influence of Mocenigo, but he had died later in the year, and his place was filled by the election of his opponent, Foscari. Still, parties in Venice were too evenly balanced to admit of a decisive intervention in the war, and the Florentine envoys proceeded from prayers to threats. If Venice would give no aid, Florence would seek her own safety by joining with Milan. 'When we refused to help Genoa, she made Visconti lord of the city; if you refuse to help us, we will make him king of Italy.' At the critical moment the Florentine appeal was reinforced by the arrival of Carmagnola, who had incurred the jealous suspicion of Filippo Maria, and had been driven in disgrace from his service. His announcement that the duke would never be satisfied till he had driven the Venetians from Lombardy, and the prospect of utilising so distinguished a general against his former employer, turned the scale in favour of Foscari and his party. At the end of 1425 it was decided to join Florence in open war against the duke of Milan.

The struggle opened with notable successes for Venice. Brescia was taken in 1426, and in December Filippo Maria confirmed its cession by a formal treaty. But ^{War between} the treaty was only a device to gain time and to ^{Venice and} collect forces. In 1427 hostilities were renewed, ^{Milan.} and three of the most famous *condottieri* of the day—Francesco Sforza, Niccolo Piccinino, and Carlo Malatesta—commanded the forces of Milan. But Carmagnola gained a brilliant victory at Macalo (October 11), and in 1428 Visconti again made peace by handing over Bergamo in addition to Brescia. Thus in two campaigns the Venetian frontier had been extended from the Adige to the Adda. But Filippo Maria could hardly remain satisfied with an arrangement which brought his enemies within striking distance of Milan itself. In 1431 the war was renewed, and Carmagnola was induced by lavish payments and promises to remain in the service of

Venice. The republic had now to face the difficulties and dangers of employing mercenary soldiers. From the first the practice had been adopted of sending two native nobles to the camp as *proveditori*. Nominally they were responsible for the commissariat, but their real function was to keep a jealous watch on the conduct of the general. Carmagnola had already incurred the suspicion of his employers. Except in the battle of Macalo he had taken little personal part in the war, and had shown himself more solicitous of his own interests than of those of Venice. He had released his prisoners without ransom, in accordance with the etiquette of his profession, and had openly conducted an independent intercourse with the duke of Milan. It seemed that he had no wish to go too far in crushing a prince whom he had formerly served and might serve again. Still, as long as their arms were successful, the Venetian oligarchy had kept their fears and suspicion to themselves. But in 1431 came a series of reverses. Francesco Sforza won a victory at Soncino, and the Venetian fleet on the Po was destroyed through the failure of Carmagnola to come to its support. Failure was taken as a proof of treachery, and the Council of Ten determined to inflict an exemplary punishment.

They acted with characteristic duplicity and decision. Carmagnola was invited to Venice to discuss the next campaign, and his distrust was removed by a triumphal reception. But he was hurried from the palace to prison, and a secret trial resulted in his condemnation and death (May 5, 1432). In the picturesque history of the *condottieri* of the fifteenth century the execution of Carmagnola is one of the most famous episodes. He had done nothing that was not in accordance with the traditions of his craft, but one state at any rate ventured to give striking proof that she would not allow independence to her hired defenders. It was a dangerous dilemma from which Venice sought to extricate herself. A too eminent and successful general might endanger her freedom, but it was difficult in

**Execution
of Carmagnola.**

the future to induce the ablest men to serve a state which was ready to exact such rigorous penalties.

The war continued for nine years after Carmagnola's death. Florence was allied with Venice, and thus the attention of Filippo Maria was engaged in Tuscany as well as in Lombardy. This diversion was the salvation of Venice, which was more than once on the verge of losing not only Brescia, but also Verona. Fortunately for her, too, her rule was more lenient than that of Milan, and her subjects were resolutely in favour of their new against their former master. The struggle was complicated by the action of Francesco Sforza, who throughout played his own game and joined one side or the other as his private interest dictated. His desire was to force Filippo Maria to give him the hand of his natural daughter, Bianca, and to make this marriage the foundation of a principality in Lombardy. He was at last successful in attaining his end. The long siege of Brescia was raised by his intervention on behalf of Venice, and a peace in 1441 secured to Venice the possession of Brescia and Bergamo. In the same year Venice expelled the ruling house of Polenta from Ravenna, and took possession of that city, a step which brought the republic southwards towards the states of the Church and prepared the way for a prolonged struggle with the papacy.

Filippo Maria had been compelled to give his daughter with the lordship of Cremona and Pontremoli to Francesco Sforza, but he dreaded and disliked his son-in-law and schemed to effect his ruin. Sforza, however, showed himself as adroit an intriguer as the duke. He defeated Niccolo Piccinino and his two sons, and induced Venice and Florence to renew their war with Milan. At the head of the army of the republics he reduced his father-in-law to such straits that he must concede all demands. Just as he was prepared to desert his employers in order to earn the succession to Milan as his reward, the news arrived of Filippo Maria's death (August 13, 1447).

Death of
Filippo
Maria.

With Filippo Maria the male line of the Visconti came to an end. There were three possible claimants through females—Sforza through his wife, the duke of Orleans through his mother Valentina Visconti, and Frederick of Styria through his grandmother Virida Visconti. But none of these claims had any legal validity, as the investiture by Wenzel had only recognised male succession. The citizens of Milan, not unnaturally, deemed that despotism was at an end and restored a republican government. These events excited the keenest interest in Venice. For more than twenty years the Venetians had been engaged in almost continuous war with Milan, but since 1428 they had not gained a square yard of territory in Lombardy. Foscari and his followers urged that advantage should be taken of the confusion following Visconti's death to establish Venetian ascendancy, and they carried the day. It was a fatal decision from the point of view of the policy which they advocated. If the republic of Milan had been allowed to establish itself, the result within a few years would have been the alienation and revolt of the subject cities, and in the troubled waters Venice could have fished with great advantage to herself. But the hasty attack on the part of the Venetians forced the newly formed republic to throw itself into the arms of the person who was most dangerous both to Milanese independence and to Venetian ambition. Francesco Sforza undertook to defend Milan against Venice, and he showed equal promptness and ability. He destroyed the Venetian fleet on the Po at Casalmaggiore and defeated their army with great loss at Caravaggio. The Venetians, having made one false step, tried to redeem it by doing still worse. They made a treaty with Sforza, by which he pledged himself to hand over to them Crema and the Ghiara d'Adda on condition that they would not oppose his designs. The wily general now turned his victorious troops against his employers, who were wholly unprepared to cope with such unexpected treachery. One

Francesco Sforza, duke of Milan, 1450.

city after another had to open its gates, and in 1450 Milan surrendered and acknowledged its conqueror as duke. Now the Venetians could realise the folly of their conduct. They had found it hard enough to cope with Milan under the rule of the cowardly Visconti, but they could have no chance of extending their rule in Lombardy if the duchy were allowed to pass to the first soldier of the age. They determined by a strenuous effort to overthrow Sforza before he had securely established his authority. But they were unsuccessful in the war which ensued, and the tragic news of the fall of Constantinople compelled them to turn their attention from Italy to their imperilled interests in the east. A peace was patched up with Milan at Lodi in 1454. Venice resigned her recent acquisitions, and her western frontier was restored to the same limits as in 1428.

For half a century the history of Venice had been closely bound up with that of Milan through their mutual rivalry for territorial expansion in Lombardy. With the peace of Lodi this intimate connection ceased for forty years. As long as the Sforza dynasty was secure in Milan, Venice could not hope to do more than retain Brescia and Bergamo. And for a time her interests in Lombardy were thrust entirely into the background by the necessity of facing the absorbing problem of Turkish advance in the east. The policy of Foscari, so gloriously attractive in the days of Carmagnola's early successes, had ended in disastrous failure. Men forgot the annexation of Bergamo and Brescia, and remembered only that Crema had been lost, and that while they were fighting for it Constantinople had fallen. For some time the party hostile to the doge had found a way of attacking him through the person of his son. Jacopo Foscari had been condemned in 1445 for taking bribes and sentenced to exile. Two years later the prayers of his father obtained leave for his return. But in 1450 one of the judges who had imposed the original sentence was murdered. Jacopo Foscari was denounced to the Ten; and although

Deposition
and death of
Foscari.

there was no real evidence against him, and torture failed to extract a confession, he was again exiled. Conscious of his innocence, he made strenuous efforts to escape, and was imprudent enough to correspond with the Turks and with Francesco Sforza. On a charge of treason the exile was brought to Venice, again subjected to terrible torture, and sent back to Candia, where he died in 1457. These events shook the reason of the aged doge, and his neglect of his official duties induced the Ten to demand his abdication. Even the Venetians, trained by the constant fear of denunciation to suppress their feelings, could not help murmuring as the old man descended the steps of the palace. A few days later Foscari died, listening, it is said, to the bells which announced the election of his successor. He had served the state loyally, if mistakenly, for thirty-four years, he had raised Venice to a lofty position among the powers of Italy, and he met with the ingratitude which the instinct of self-preservation impelled the Venetian oligarchy to show towards every individual who exercised a commanding influence on the destinies of the republic.

While these events were going on at home, Venice was keenly interested in Eastern affairs. Now that Constantinople had fallen, it was no longer possible to pursue the old policy of bolstering up the Eastern Empire as a buffer between the Turks and Venetian possessions. Two alternative courses were open to the republic. She might take the place of Constantinople and become the bulwark of Christendom against the infidel. Or she might endeavour to secure the continuance of Venetian commerce in the east by making an advantageous treaty with the conquerors. The heroic policy was advocated by Foscari, the more cautious and selfish policy by his opponents, and the declining credit of the doge enabled them to carry the day. In April 1454 a treaty was concluded with Mohammed II. On payment of a yearly tribute, the Venetians were allowed to retain their ports and other possessions in the east, and to continue their

Levant trade in temporary security. A district in Constantinople was assigned for the residence of Venetian merchants under a Venetian bailiff. It was no small argument in favour of this treaty that it enabled Venice to strike another blow at her old rival Genoa. The Genoese had for some time aided the Turks in various ways, and had received the promise of special trade privileges as their reward. But the Sultan found it cheaper to buy off the hostility of a possible foe than to pay the stipulated price for services already rendered.

For a few years Venice profited by the treaty of 1454, and abstained from giving aid to the struggling Christian populations, either of the Balkan provinces or of Greece. But the Turkish conquests were too extensive and rapid not to awaken serious misgivings. In spite of the famous relief of Belgrad by Hunyadi, Servia was reduced, and Wallachia and Bosnia were overrun without serious resistance. Only Albania, under the heroic Scanderbeg, succeeded by desperate efforts in prolonging its independence, and in extorting terms from the Sultan. It was more alarming to the Venetians when the Turkish armies crossed the isthmus into the Morea, and equipped a fleet for the conquest of Lesbos and the other islands in the *Ægean*. The most strenuous opponents of war had to admit the uselessness of a paper treaty to restrain a conqueror so unscrupulous as Mohammed II. At this juncture, Pope Pius II. was making strenuous efforts to rouse the princes of Western Europe to a crusade against the Turks. Venice was convinced that the further maintenance of peace was impossible; and if the pope could secure them allies in the name of religion, their prospects of success would be improved. But these hopes of assistance were doomed to disappointment, when, in 1464, Pius proceeded to Ancona to welcome and bless the crusading host. The Venetian fleet was the only efficient force which Christendom had furnished in response to the demand of its ecclesiastical chief.

The war which Venice waged for sixteen years against overwhelming odds is by no means the least heroic episode in the history of the republic. Occasionally, as **Turkish war,** in the history of the republic. Occasionally, as **1463-79.** when Niccolo Canale failed to save Negropont in 1470, the Venetian commanders hesitated to act with decision in the service of a state which allowed little freedom to its subordinates, and was apt to punish failure as if it were treason. But, on the whole, the war was waged with equal courage and conduct. It could, however, have but one result. Mohammed II. employed all the resources of Turkish diplomacy to prevent any coalition of Italian powers, and Venice was not so popular that other states were likely to deplore or to share her misfortunes. It is true that Scanderbeg was induced to break his treaty with the Sultan, and to admit Venetian garrisons into his fortresses of Kroja and Scutari. But Scanderbeg died at the beginning of 1467, leaving the guardianship of his son and his dominions to his ally. This proved to be a fatal bequest. After the reduction of the Morea, a Turkish force entered Albania and laid siege to Scutari. The fortress was heroically defended by Antonio Loredano, Mohammed was engaged in Asia Minor, and the siege had to be raised. But the triumph was only temporary. In 1478 Albania was again invaded. Kroja was taken, and Scutari, though it repulsed all attempts to storm the walls, was closely blockaded. Venice was worn out with her prolonged and exhausting efforts, and in 1479 the peace of Constantinople brought the war to a close. Venice gave up Scutari, Kroja, Negropont, Lemnos, and her possessions in the Morea, but was allowed to retain her Levant trade and her quarter in Constantinople on payment of 150,000 ducats down and a yearly tribute of 10,000 ducats. Two years later, the death of Mohammed II. and the accession of a feebler sultan, freed the republic from immediate danger in the east.

The disasters of the Turkish war had a demoralising effect upon Venice. In her eastern dominions the more ambitious

and enterprising of the Venetian nobles had found scope for an ability and an energy that at home would be regarded with suspicion. These men had now to turn their attention to Italian politics, and they urged the state to seek compensation for losses in the Levant at the expense of its neighbours. From this time the policy of Venice became far more openly grasping and selfish than it had ever been before, and the enmities thus provoked ultimately led to the league of Cambray. Aggression in Lombardy was still blocked by the Sforza dynasty, and it was therefore necessary to find some weaker power to attack. A quarrel with Ferrara about the manufacture of salt gave the desired pretext, and Venice joined with the turbulent pope Sixtus iv. in an alliance against Ercole d'Este. Ferrara was powerless against such a combination, and the Venetian forces seized Rovigo and the adjacent territory. But an act of such unprovoked aggression excited the misgivings of the other states; and Naples, Milan, and Florence formed a league to maintain the balance of power against the attempts of Venice and the papacy to disturb it. Alfonso of Calabria, who enjoyed an unmerited reputation for military skill, advanced to the aid of Ferrara, Sixtus deserted an ally who had obviously no regard for papal interests, and Venice was compelled to conclude the peace of Bagnolo in 1484, by which Rovigo was retained, but all other conquests were restored.

War with
Ferrara,
1482-84.

About this time Venice had the good fortune to make an acquisition in the east, which was some set-off against her losses to the Turks. The last king of Cyprus, James of Lusignan, had married a Venetian lady, Catarina Cornaro. In order to exalt her to sufficient rank, the republic of Venice had formally adopted her as a daughter of the state. The next year, 1473, the king died, and Venice at once interfered as paternal guardian of the widow and her posthumous child. For some years Catarina ruled under Venetian protection and control, but in

Venice
acquires
Cyprus.

1488 she was half induced, half compelled to abdicate, and the banner of St. Mark was hoisted in Famagusta. Catarina Cornaro was allowed to retain the title of queen, and lived in considerable magnificence at Asolo till the outbreak of war in 1508 drove her to seek a refuge in Venice, where she died in 1510.

But the insatiable greed of the Venetians for territory was by no means appeased by the annexation of Cyprus, which could not long be retained except under tribute to the Turks. It was to Italy that the ambition of the republic was mainly directed, and the Ferrarese war had taught her more than one lesson. If her western boundary was to be extended, the Sforzas must be driven from Milan; if territory was to be gained in the south, the triple league for the maintenance of the balance of power must be broken up; and, above all, the house of Aragon in Naples must be punished for its action in 1483, and rendered powerless for the future. How could these ends be achieved? One solution of the problem offered itself in 1493, and that was the intervention of a foreign state. A number of Neapolitan nobles, driven into exile by the merciless rule of Ferrante and Alfonso, came to Venice for advice as to how they might best overthrow the Aragonese despots. The senate advised them to invite Charles VIII. of France to claim Naples as representing the house of Anjou. The advice was taken, and the invitation was acted upon in 1494. The motives of Venice are perfectly obvious. A French invasion would weaken the house of Aragon; it would dislocate the league of the great powers; and in the disturbance which would follow, Venice, isolated and secure herself, could sell her assistance for the price of ports in Apulia, which would complete her ascendancy in the Adriatic. Nor was this all. A French prince—Louis of Orleans—was a claimant to the duchy of Milan. If the French once entered Italy, this claim was sure to be advanced against the Sforzas, and the dynasty, which had so long blocked any advance towards

Venetian
greed of
territory.

Cremona or Milan, might be overthrown, or at any rate reduced to comparative impotence. The reckoning was equally cold-blooded, selfish, and astute. The immediate aims were achieved. After the first successes of Charles VIII. Venice turned against France and received Otranto, Brindisi, and other ports in Apulia, as a reward for helping to restore the Aragonese line in Naples. The duke of Orleans, on becoming Louis XII. of France, attacked Ludovico Sforza and purchased the alliance of Venice by ceding Cremona and the Ghiara d'Adda. The fall of Cæsar Borgia enabled Venice to annex a considerable part of the papal states, and there was no Italian league to interfere. But Nemesis overtook the republic a few years later, when all the states which had been at any time despoiled, combined to attack the common enemy. The ruin of Venice, however, was not the work of the league of Cambray, but of causes which she could not control. No treaties with the Turks could keep the Levant trade as open as it had been, and the people on the Atlantic seaboard set to work to find an independent route to the east. In 1486 Bartholomew Diaz rounded the Cape, and in 1498 Vasco da Gama continued the voyage to India. For three centuries and a half the Mediterranean ceased to be the great highway of commerce, and became merely a considerable inland sea. The marvellous prosperity of Venice ceased with the conditions which had given rise to it.

Until the invasion of Charles VIII. brought Venice and Milan once more together, there had been little direct connection between the two states since the treaty of Lodi gave leisure to Francesco Sforza to secure his position in his newly acquired duchy. In this task he was as successful as he had been in the unscrupulous methods by which he rose to power. From the first he determined to sink the *condottiere* in the prince. Peace, and not war, became the primary object of his policy. With Cosimo de' Medici he was already on the most friendly

Decline of
Venice.

Francesco
Sforza in
Milan.

terms, and as long as he or his descendants retained their power no opposition was to be feared from Florence. Venice had received a sharp lesson, and her attention was diverted to the east. The popes had enough to do to maintain their recently recovered authority in the papal states. The only other important state in Italy was Naples. As a military leader Sforza had played a prominent part in Neapolitan politics. He had been the champion of the house of Anjou, and when the victory ultimately rested with Alfonso of Aragon, Sforza had been deprived of his estates in Apulia and the Abruzzi. But as duke of Milan, Francesco was eager to be on good terms with the king of Naples. All his interests were now opposed to the Angevin claim on Naples, which might easily be allied with the Orleanist claim to Milan. A double marriage was arranged to cement the alliance between Naples and Milan. Alfonso's grandson, another Alfonso, was betrothed to Ippolita, Sforza's daughter, and one of Sforza's sons was to marry Alfonso's granddaughter. When Alfonso's death, in 1458, was followed by a renewed attempt of the Angevins to gain Naples, Sforza gave his cordial support to Ferrante, the natural son of the late king, and materially aided him in defending his throne.

It was extremely fortunate for Francesco Sforza that his alliance with the house of Aragon did not lead to a serious breach with France, which had recovered the suzerainty of Genoa in 1458. It was from Genoa that John of Calabria sailed to Naples in 1460 to maintain the cause of his father René, and one of the most notable acts of Sforza in thwarting the Angevin pretensions was his encouragement of a successful revolt of the Genoese in 1461. At this critical moment Charles VII. of France died, and his successor, Louis XI., not only had no love for the Anjou princes, but was an avowed admirer and imitator of Francesco Sforza. The result was a treaty in 1464, by which the town of Savona and all French claims to Genoa were ceded to the duke of Milan, and later in the year Sforza succeeded in sub-

jecting the Ligurian republic to his rule. When Louis XI. was hard pressed in 1465 by the League of the Public Weal, Sforza not only sent his eldest son with a considerable force to attack the duke of Bourbon, he also repaid his obligations by the celebrated advice to Louis that he should divide his enemies by conceding their demands and then reduce them separately. French history tells how triumphantly the king followed the counsel of his chosen model.

The government of Galeazzo Maria Sforza, who succeeded in Milan without opposition on his father's death in March 1466, was comparatively uneventful. The external relations were maintained by Simonetta, ^{Galeazzo} Maria Sforza, who had been secretary to Francesco, and ^{1466-76.} remained in office under the son, on the same lines as under the previous duke. The connection with France was drawn closer by Galeazzo's marriage with Bona of Savoy, the sister-in-law of Louis XI. It is true that for a moment the growing power of Charles the Bold attracted Milan to an alliance with Burgundy in 1475. But on the news of the duke's first reverse at the battle of Granson, Galeazzo hastened to return to the French alliance. The wanton cruelty of Galeazzo's rule in Milan illustrates the demoralising effect of unbridled power upon a weak and passionate nature. To the love of bloodshed, which had characterised so many of the Visconti, he added a lustful debauchery which outraged the honour of the noblest families of Milan. Against a lawless despotism the only remedy is rebellion, and the revival of classical learning tended to glorify tyrannicide by parading the examples of Brutus and of Harmodius and Aristogiton. Three young nobles—Girolamo Olgiati, whose sister Galeazzo had dishonoured, Carlo Visconti, and Andrea Lampugnani—determined to win eternal fame by the murder of the tyrant. Sacrilege had little terrors for Italians, and Galeazzo Maria fell beneath their daggers in the Church of St. Stephen (December 26, 1476). But the mass of the citizens were too accustomed to subjection to espouse the cause of the

rebels. Two of the assassins were slain on the spot, and Olgiate was executed after suffering horrible tortures, which he endured with the stoicism of an ancient Roman.

Galeazzo Maria Sforza left an only son, Gian Galeazzo, who was only eight years old. He was immediately acknowledged as duke of Milan, under the regency of his mother, Bona of Savoy, but the real government rested in the hands of Simonetta. The latter succeeded in overcoming the first difficulties that the regency encountered. A rising in Genoa was suppressed, and the brothers of the late duke, who wished to oust their sister-in-law, were driven into exile. But in 1479 wholly unexpected problems arose. Francesco Sforza had leant on the alliance of Florence and Naples, and as long as those two states were on friendly terms Simonetta pursued the same policy. The conspiracy of the Pazzi, however, involved Florence not only in a quarrel with Pope Sixtus iv., but also in a war with Naples. Bona of Savoy, under Simonetta's guidance, clung to the Florentine alliance, and prepared to send forces to aid Lorenzo de' Medici. Ferrante of Naples determined to prevent the intervention of Milan. He stirred up a new rebellion in Genoa, which succeeded in expelling the Milanese garrison from the citadel. At the same time, he urged the uncles of the young duke to resume their attack on the regency of Bona. Aided by divisions in the government, the brothers contrived to secure their return to Milan and to overthrow Simonetta, who was put to death at Pavia (1480). Ludovico il Moro, the eldest surviving son of Francesco Sforza, now succeeded without serious difficulty in prosecuting his schemes. The young duke was declared of age in order to terminate his mother's regency, and Ludovico carried on the government in his nephew's name.

The circumstances under which Ludovico had obtained his power seemed to bind him closely to Ferrante of Naples, who was now reconciled with Lorenzo de' Medici, so that the triple alliance was restored, and was

**Regency of
Bona of
Savoy.**

**Ludovico il
Moro.**

able to interfere decisively in the war of Ferrara (see above, p. 257). The young Gian Galeazzo was married to Isabella, the daughter of Alfonso of Calabria, and granddaughter of Ferrante. All would have been well if Ludovico's ambition had been satisfied with actual rule. But he was resolved to supplant his nephew in the duchy, and if necessary to get rid of him by foul means. Such a scheme was certain to meet with the determined opposition of the rulers of Naples; and Ludovico, without venturing upon an open rupture, sought for means to protect himself from their hostility. The first sign of growing mistrust was visible in the war of Ferrara, when the half-hearted action of Ludovico allowed Venice to escape with comparatively favourable terms in the treaty of Bagnolo. Matters became worse when Isabella of Naples openly complained to her father and grandfather of the way in which her husband was treated by his uncle. Even more bitter was her ill-feeling when Ludovico married Beatrice d'Este, and a personal jealousy grew up between the nominal and the real duchess. Isabella was furious that she should be compelled to live in poverty and semi-captivity while her rival was the centre of a magnificent court.

The rulers of Naples naturally espoused the cause of Isabella and her husband, and Ludovico was conscious that an open quarrel could not be long delayed. It was necessary for him to strengthen his position by alliances, either within Italy or without. Venice was not a power that could be trusted to act unselfishly in support of Milan. Florence was the oldest ally of the house of Sforza, but Lorenzo de' Medici died in 1492, and his son Piero showed a perilous inclination to prefer the Neapolitan cause to that of Ludovico. In his despair Ludovico made up his mind to turn to France. He had already established a connection with France when, after reducing Genoa once more to submission to Milan, he agreed in 1490 to hold the city under the suzerainty of the French king. In 1493 he discovered that the Neapolitan exiles, acting on the advice of

Ludovico
calls in the
French.

Venice, were urging Charles VIII. to attack Naples. Ludovico sent an embassy to support this appeal and to promise his co-operation. He had no expectation or desire that the French should conquer Naples, but he wished to have a French army between Milan and the southern kingdom while he established himself as duke in the place of his nephew. When once France had served his purpose, he was confident of his ability to rid himself and Italy of an ally who was no longer needed. But cunning as Ludovico was, he overreached himself. It is true that Gian Galeazzo died at the required moment, that Ludovico became duke with an imperial investiture, which no previous Sforza had received, and that the French invasion prevented any opposition on the part of Naples. But among the Frenchmen who entered Italy was Louis of Orleans, who seized the opportunity to assert his claim to the duchy of Milan as the descendant of Valentina Visconti. Ludovico succeeded for the time in defeating the duke, who was not well beloved by Charles VIII. But a few years later Louis himself became king of France, and one of his first enterprises was the expulsion of the Sforzas from Milan. Ludovico had ample time to repent of his short-sighted policy in calling in French aid while he lay a prisoner in the castle of Loches, where he died in 1510.

CHAPTER XIII

NAPLES AND THE PAPAL STATES IN THE FIFTEENTH CENTURY

The Papal States during the Schism and Ladislas of Naples—Martin v. returns to Rome—Succession question in Naples—Troubles of Eugenius IV.—War in Naples between René of Anjou and Alfonso of Aragon—Victory of Alfonso v.—Last years of Eugenius IV.—Nicolas v.—Calixtus III.—Death of Alfonso v. of Naples—Pius II.—Congress of Mantua—War in Naples between Ferrante and John of Calabria—Death of Pius II. at Ancona—Paul II.—Sixtus IV. and his nephews—War with Florence—Relations with Ferrara and Venice—Disorders in Rome—Innocent VIII.—Rising against Ferrante in Naples—Election of Alexander VI.—His alliance with Naples.

BONIFACE IX. was the ablest and most successful of the Roman popes during the Schism. The impotence into which the temporal authority of the papacy had fallen may be judged by the fact that Boniface found it advisable or necessary to sell the vicariate, *i.e.* the right to exercise authority in the Pope's name, to the despots who had usurped lordship in the various cities. Yet this very sale, though it seemed to legalise acts of violence and rebellion, brought with it some advantages besides filling the Pope's coffers. The purchase of rights was in itself an acknowledgment that the Pope possessed them, and this could be employed some day against the purchasers. And in several ways Boniface directly increased his power. He induced the citizens of Rome, always as greedy of papal wealth as they were jealous of papal rule, to invite him to take up his residence in his capital on terms which ruined the foundations of republican liberties. He aided Ladislas of

The Papal States and Ladislas of Naples.

Naples to gain his final victory over Louis II. of Anjou in 1399 (*vide* p. 155), and Ladislas repaid his obligation by helping the Pope to suppress formidable risings of the Roman barons. On the death of Gian Galeazzo Visconti, he succeeded in recovering for the papacy the towns of Bologna, Perugia, and Assisi, which had fallen under the sway of the duke of Milan.

But Boniface bequeathed to his successors one very serious difficulty. Ladislas, who owed his crown to papal support, conceived the plan of extending his kingdom at the expense of the papacy, and even of reducing the papal states under his personal rule. His first attempt to stir up rebellion in Rome, in order that he might intervene for his own profit in the struggle, resulted in the expulsion of Innocent VII. and the sack of the Vatican, but the citizens hastened to come to terms with the Pope when they discovered that the only alternative to his rule was subjection to Naples (1405). Another opportunity offered itself in 1407, when Gregory XII. left Rome in order to simulate willingness to confer with Benedict XIII. for the closing of the schism. Ladislas had no wish that the schism should end, not only because its continuance facilitated his schemes of aggression, but also because it strengthened his position in Naples. The movement for union had its chief strength in France, and any successful intervention of France in Italy would lead to a new attempt to gain Naples for the younger house of Anjou. In 1408 Ladislas seized Rome, and practically made himself master of the papal states. But to some extent his plan miscarried. Gregory XII., it is true, pleaded events in Rome as a reason for avoiding a conference, but his cardinals deserted him and joined with those of Benedict to hold a council at Pisa (*vide* p. 199). The attempt of Ladislas to disperse the Council by invading Tuscany was foiled by the resistance of Florence, and the Assembly proceeded to depose the two existing popes and to elect Alexander V. Baldassare Cossa, the papal legate in Bologna, who combined the training and habits of a *condottiere* with

the office of cardinal, undertook to recover Rome and to punish the prince who still adhered to the cause of Gregory XII. Rome was captured at the beginning of 1410, but Alexander V. died in May, and the all-powerful Cossa was elected to succeed him as John XXIII.

The new pope entered Rome in triumph in 1411, and his first act was to despatch a powerful army under Braccio Sforza, and other famous generals, to support the cause of Louis of Anjou in Naples. A great victory was won at Rocca-Secca (May 19, 1411), but the delay of the conquerors enabled Ladislas to rally his forces, and before long to gain the upper hand. Louis II. abandoned the enterprise in despair. Attendolo Sforza deserted to the side of the Neapolitan king, and John XXIII. made peace with his enemy in 1412, the one abandoning the cause of Gregory XII., the other promising to disown the duke of Anjou. But Ladislas had no intention of observing the peace. As soon as his preparations were completed, he again marched upon Rome in 1413, and drove John XXIII. in hasty and undignified flight to Florence. This crushing disaster forced the Pope into those appeals for aid to Sigismund, which ultimately led to the summons of the Council of Constance and to his own ignominious deposition. But in August 1414, before the Council had begun its session, Ladislas died, leaving his crown to his sister, Joanna II., and the scheme of subjecting the papal states to Naples perished with him. The citizens of Rome expelled Sforza and his troops from the city, and welcomed the return of a papal legate.

When unity was at last restored to the Church by the election of Martin V., the new Pope had a very cheerless prospect before him. His obvious task was to restore to **Martin V.,** the papacy some measure of the authority and **1417-1431.** influence which had been forfeited by its experiences during the last hundred years. To do this he must find a residence in which he would be more secure than his recent predecessors from the dictation of secular rulers. Sigismund urged

him to reside in some German city, and the French would have welcomed him to Avignon. But Martin, himself a Roman by birth, refused to find a home except in the ancient capital of the world. Rightly or wrongly, he decided that temporal dominion in a state of his own was necessary to secure the independence of the Pope, and that to attain this he must recover and consolidate the papal provinces in Italy. The whole history of the papacy during the fifteenth century was moulded by this decision. The popes became more and more absorbed in the extension of their temporal power, even when their spiritual authority was weakened by it. Nepotism and other evils were the result of this devotion to secular interests, and a revolt of outraged and alienated opinion became inevitable.

But Martin had many difficulties to overcome before he could carry out his intention of taking up his abode in Rome.

**Martin re-
turns to
Rome.** The departure of John xxiii. to Constance had left the papal states in the condition of anarchy which had become chronic. Neapolitan influence was still strong, but the policy of Naples was no longer directed by the strong will of Ladislas. His sister and successor, Joanna II., was devoid of political capacity, and abandoned herself to sensual indulgence and the guidance of favourites. Through her incompetence the chief influence over the destinies of Naples was allowed to fall into the hands of the two great *condottieri*, Braccio da Montone and Attendolo Sforza, who had been brought into rivalry by their connection with Neapolitan affairs during the previous reign. Braccio, who had quarrelled with Ladislas and joined John xxiii., had been left by that Pope as governor of Bologna. After the departure of his employer he seized his native city of Perugia and set himself to carve a private principality out of the states of the Church. In 1417 he actually made himself master of Rome, and was besieging the castle of St. Angelo, when Sforza was despatched from Naples to compel his retirement. These events forced Martin v. on his

accession to ally himself with Joanna and Sforza, and a treaty was arranged in 1419 by which Naples was to restore all that had been occupied in the papal states. But a quarrel between Joanna and Sforza deprived this treaty of all importance, and Martin determined to coerce and distract Naples by encouraging internal feuds in that kingdom. As Joanna was childless, the question of the succession to a crown which had already been so hotly disputed was certain to give rise to difficulties. Louis II. of Anjou, the rival of Ladislas, had died in 1417; but his eldest son, Louis III., was eager to enforce his father's claim and to purchase the support of the papacy. Martin V. and Sforza declared their recognition of Louis as heir to the kingdom. But Joanna, indignant at this attempt to force a successor upon her, turned to a family whose rivalry with her own dynasty was older than that of the younger house of Anjou. Alfonso of Aragon had become king of Sicily in 1409, and was not likely to refuse the prospect of a notable increase of his power in the Mediterranean by the acquisition of Naples. He eagerly accepted the offer of Joanna to adopt him as her heir, and he induced Braccio to enter his service in order to oppose Sforza. Thus civil war was kindled in Naples, and its outbreak gave the Pope the opportunity for which he had been waiting. Leaving Florence, where he had resided since his departure from Constance, he made his way to Rome in September 1420. There he set himself to put an end to disorders and to strengthen the foundations of papal rule. The exhaustion of the combatants in Naples, and the successive deaths of Braccio and Sforza in 1424, freed him from the danger of any intervention from the south. Alfonso abandoned the contest for a time, and Joanna agreed to recognise the claim of Louis of Anjou to be regarded as her successor. Perugia and the other territories of Braccio returned on his death to their allegiance to the Pope. In Rome itself Martin had one source of strength in the support of his own family of Colonna, though their

Succession
question in
Naples.

Rule of
Martin V.

advancement to places of dignity and importance was certain to create difficulties for his successor. Once secure in his temporal dominions, the Pope was free to turn his attention to the general affairs of the Church. The first council which he was bound to summon by the decrees of Constance met at Siena, and was adroitly managed so as to avoid any further limitation of papal authority. By putting himself at the head of the movement to crush the Hussites, and by appointing a papal legate to lead the armies against the heretics, Martin tried to recover for the papacy the position which it had enjoyed in the time of the great crusades of the Middle Ages. But the crusading spirit was dead in Europe, and the successive victories of the Bohemians not only frustrated his designs, but also compelled him to summon a Council to meet at Basel shortly before his own death on February 20, 1431.

Eugenius iv., who was unanimously elected to succeed Martin v., had a troubled pontificate of sixteen years. He at once set himself to deprive the Colonna family of the predominance which they had acquired in Rome through the favour of his predecessor ; but he could only accomplish this by an alliance with the Orsini, and he thus revived the old feuds among the Roman barons which it was the interest and the duty of the popes to check. Very soon after his accession he engaged in a bitter quarrel with the Council of Basel, and he completely failed in his endeavour to detach Sigismund from the cause of the Council as the price of conferring the imperial crown upon that prince. To make matters worse, he allowed his sympathies with his native city of Venice to involve him in a quarrel with Filippo Maria Visconti of Milan. In 1433 the climax of his misfortunes seemed to be reached, when a combination of Milanese hostility with domestic discontent drove him to fly in disguise from Rome, and to seek refuge in Florence. These accumulated disasters compelled him to adopt a humbler tone towards the

Troubles of
Eugenius IV.

Council of Basel, which was conducting negotiations with the Bohemians as if its authority completely superseded that of the Pope.

About this time the succession dispute in Naples gave rise to a prolonged war. Louis III. of Anjou died in 1434, but Joanna made a new will in favour of his younger brother René of Provence. Soon afterwards the queen herself died, on February 2, 1435. Alfonso v. at once came forward to assert his own claims against those of René, and the Neapolitan baronage was divided into the factions of Anjou and Aragon. It was impossible for the papacy to remain neutral in a struggle which so intimately concerned its own interests. Eugenius began by claiming the kingdom as a fief which had lapsed to its suzerain on the extinction of the line of papal vassals. But he soon dropped this claim and reverted to the normal policy of supporting the Angevin candidate. At first, events seemed to turn decisively in favour of René. A Genoese fleet, fighting on his side, won a great naval victory off the island of Ponza, in which Alfonso himself was taken prisoner. But in a personal interview with Filippo Maria Visconti, who claimed the captive by virtue of his suzerainty over Genoa, Alfonso convinced him that it would be impolitic either to strengthen the papacy which was allied with Venice, or to establish French influence in Southern Italy. By these arguments he not only secured his own release, but also laid the foundations of a durable alliance between his own dynasty and the dukes of Milan. From this time the fortunes of war turned steadily in favour of the Aragonese party, though it was not till 1442 that René finally abandoned the contest, and Alfonso v. was formally recognised as king of Naples. His accession reunited for a time the crowns of Naples and Sicily, which had been separated since the Sicilian Vespers in 1282 (see p. 25).

War of
Angevins and
Aragonese in
Naples.

So far Eugenius had met with little but failure and disappointment. He gained an apparent victory over the

Council of Basel when he induced the Greeks to conduct the negotiations for a union of eastern and western churches at a rival council which met first at Ferrara, and later in Florence. But the treaty which was settled at the Council was repudiated by public opinion in Greece, and the Pope gained little real advantage from the parade of negotiations which proved abortive. Yet the later years of his pontificate were more successful than seemed likely from the beginning. Rome did not long enjoy the republican liberty which the citizens claimed to have recovered on the Pope's departure. The warlike Cardinal Vitelleschi succeeded by 1435 in reducing the capital to submission. So successful were the rigorous and cruel measures of the legate that Eugenius suspected him of a design to establish his own power in the papal states. In 1440 Vitelleschi was imprisoned and died, either from poison or from the wounds he received in the struggle with his captors. Scarampo, who took his place, maintained his authority by the same means as his predecessor had employed. In 1443 Eugenius was able to quit Florence and to return to Rome in perfect security. He gained the alliance of Naples by recognising the title of Alfonso v. But his greatest triumph was the inauguration of the negotiations with Germany, through the medium of Æneas Sylvius Piccolomini, which led to the failure and humiliation of the Council of Basel. The final treaty was practically concluded, though still unsigned, when Eugenius died, on February 23, 1447.

Thomas of Sarzana, who succeeded to the papacy as Nicolas v., had already won a considerable reputation as a student of ancient literature. Though he was rather a diligent collector of manuscripts and works of art than an original scholar, his patronage made Rome for a time the centre of humanist culture. His greatest work was the foundation of the Vatican library. As a politician Nicolas showed less ability and interest than as

Nicolas V.,
1447-1455.

a student, but he was a sincere lover of peace, and he was able to maintain the position which Eugenius had won in his later years. He concluded the concordat with Germany, which put an end to the revolt originating with the Council of Basel, and the Council itself came to an ignominious end in 1449. In 1450 Nicolas celebrated the restoration of unity, and conciliated the Roman people, by a grand jubilee which brought the wealth of Europe to the eternal city. In spite of this general rejoicing, the next year witnessed a famous conspiracy against the secular authority of the Pope. Stefano Porcaro was a Roman noble who had won the favour of Nicolas by his devotion to ancient literature. But these studies led Porcaro, as they had previously led Rienzi, to an enthusiastic admiration of republican liberty. When he endeavoured to inspire the people with his opinions he was banished by the Pope to Bologna. Thence he returned secretly to Rome and organised a plot to imprison the Pope and cardinals, and to restore the republic, with Porcaro as tribune. More than four hundred persons were engaged in the scheme, and the number proved fatal to secrecy. Porcaro and nine of his followers were imprisoned in the castle of St. Angelo and executed without trial. After an interval of a few days harsh measures were resumed, and a number of suspected persons shared the same fate. This severity extinguished the last active desire to restore Roman liberty. Papal rule was strengthened by the failure of the plot; but Porcaro's name, like that of Rienzi, lived long in the affections of the people. No sooner was this crisis passed than the news came that Constantinople had been taken by Mohammed II. in 1453. The empire had long ceased to possess any general authority in Europe, but the papacy still claimed to represent that unity of Christendom, whose disappearance had rendered such a catastrophe possible. It was upon the papacy, therefore, that the chief discredit fell of so notable a triumph for the infidel. But Nicolas V. had no ability to cope with such a vast problem as was

involved in the union of the jarring interests of European states for the purpose of joint resistance to the Turks. Unable to devise any practical scheme, he gave himself up to despair, lamented that fate had raised him from a private station, and died in 1455.

After the death of Nicolas v. the choice of the cardinals fell upon Alfonso Borgia, who took the name of Calixtus III.

He was a native of the Aragonese province of **Calixtus III.,** Valencia, and had been rewarded with the cardinalate for services rendered to the papacy in **1455-1458.**

dinalate for services rendered to the papacy in negotiations with Alfonso v. Although over seventy years of age, Calixtus showed creditable energy in urging the princes of Europe to war against the Turks, and he had the consolation of hearing of the signal victory of John Hunyadi, when Mohammed II. was repulsed from the walls of Belgrade in 1456. But the pontificate of Calixtus is mainly noteworthy for the elevation of a relative who was destined to involve the papacy in the gravest scandals. Nepotism was a natural result of the secular aims of the fifteenth century popes. As long as the popes had been the active heads of Christendom their energies were fully employed in carrying out a great task. But they were now little more than temporal princes, and their position differed from that of other princes in the impossibility of transmitting their power to a dynasty, and in the brief period of rule which was possible for men elected in advanced years. Hence there was a serious temptation to the popes to aggrandise their relatives at the expense of the Church or of neighbouring princes, and thus to confer those advantages upon their family which a secular prince could bring about by the normal action of hereditary succession. Calixtus had three nephews, the sons of a sister and a man called Lenzuoli. These young men were allowed to take the maternal name of Borgia, and their interests were vigorously forwarded by their uncle. Two were appointed cardinals, to the great scandal of the College and of Roman opinion;

and one of these, Rodrigo Borgia, became the notorious Pope Alexander vi. The third nephew received the title of duke of Spoleto, and the offices of Gonfalonier of the Church and prefect of Rome.

Before the death of Calixtus important events had taken place in Naples. Alfonso v., after the prolonged war which secured him the throne, had enjoyed a singularly peaceful reign. The personal charm which had enabled him to gain over Filippo Maria Visconti also served to win the affection of his subjects; and his court was rendered famous not only by its magnificence, but also by the eminence of the scholars who were attracted to Naples by royal patronage. But Alfonso's death, in June 1458, threatened a revival of dynastic struggles in southern Italy. As he had no lawful issue, his hereditary kingdoms of Aragon and Sicily passed to his brother, John II. But Alfonso claimed the right to dispose of Naples as a private acquisition of his own, and bequeathed the kingdom to his illegitimate son, Ferrante. The Neapolitans themselves were not at first inclined to resent an arrangement which freed them from a connection with Aragon and Sicily which might be regarded as subjection. But it was obvious that the accession of a bastard would encourage the house of Anjou to revive its claim, while the legitimate line in Aragon could always assert the same right to Naples which had been vindicated by Alfonso himself. It was therefore of great importance to Ferrante to obtain recognition from the Pope, who claimed to be suzerain of Naples, and he had some right to demand it with confidence from Calixtus, who was born a subject of Aragon. But the Pope, whether he remembered the traditional Angevin alliance of the papacy, or whether he sought in the spoils of Naples for new means of advancing his nephews, refused to recognise Ferrante, and claimed to dispose of the kingdom as a vacant papal fief. Before, however, he could make any efficient opposition to the new king, he was removed by death on August 6, 1458.

The choice of the cardinals now fell upon the most remarkable Pope of the century, Æneas Sylvius Piccolomini, who adopted the Virgilian epithet of Pius as his papal name. In his youth Æneas Sylvius had lived a gay and not too decorous life. The author of the novel of *Euryalus and Lucretia*, and the confidant of the amours of princes, he had first achieved political distinction at the Council of Basel. There his literary and oratorical ability had given him a position of recognised eminence; but when the cause of the Council began to decline, he had entered the service of Frederick III., and had played by far the most prominent part in effecting a reconciliation between Germany and the papacy. For these services he had been rewarded by Nicolas v. with the bishopric of Siena, his native city, and by Calixtus III. with the cardinal's hat. Raised to the papacy, he set himself to destroy the last traces of conciliar opposition to Roman supremacy, and with this object in view he strained every nerve to put himself at the head of a great crusading movement against the Turks. His career is full of strange contradictions, and the contrast has often been drawn between his unscrupulous youth and early manhood and the austere enthusiasm which he displayed as Pope. He himself was fully sensible of the incongruity, and in his famous recantation he urged his hearers to cast away Æneas and take Pius in his place: *Æneam rejicite, Pium accipite*.

As peace was absolutely necessary for any action against the Turks, the first act of Pius was to reverse the policy of his predecessor, and to recognise Ferrante as *de facto* king of Naples, though he was careful to avoid any formal decision on the question of legal right. In 1459 he summoned a congress of Western princes to meet at Mantua, in the confident hope that his eloquence would prove as effective as that of Peter the Hermit in the eleventh century. On the appointed date the Pope and his personal followers found themselves alone in Mantua. After a month's anxious delay, some ambassadors and a few German and

Italian princes appeared, and the Congress was declared open. But the Pope soon discovered that his hopes had been far too sanguine; and after much eloquence had been expended in invectives against the Turks, the Congress broke up without achieving anything. There is no need to seek far for the causes of the failure of the Mantuan Congress. The growth of nations, with separate and often conflicting interests of their own, had destroyed all the conditions which had rendered possible the crusades of the Middle Ages. There were also special causes at the time which rendered it difficult for Pius II. to gain any real support for his schemes. The French were angry with the Pope for having prejudiced the Angevin claims to Naples by his recognition of Ferrante. Pius replied to the remonstrances of the French envoys by attacking the Pragmatic Sanction of Bourges; and though he might claim a dialectical victory, such discussions were not conducive to a good understanding with France. Even Frederick III., the old patron of Æneas Sylvius, was at this time dissatisfied with the Pope for refusing to support his claims to the Hungarian crown, which had gone to the son of John Hunyadi, Mathias Corvinus. In Germany there were still traces of that spirit of opposition to the papacy which had been both a cause and a result of the conciliar movement; and Pius II. chose this moment to exasperate the German princes who shared these opinions by issuing from Mantua the bull *Execrabilis*, by which he condemned as detestable heresy any future appeal from the bishop of Rome to a general council.

Just at this very time there broke out the war in Naples, which the Pope had endeavoured to avert. The Neapolitan barons revolted against the harsh rule of Ferrante, and appealed for aid to the house of Anjou. René le Bon was unwilling to quit his luxurious life in Provence; but his son John, titular duke of Calabria, was at once more capable and more ambitious. From Genoa, which was at this time under French suzerainty, John sailed

War in
Naples.

to the Neapolitan coast, and was speedily joined by a large number of partisans. Hostilities in Naples were fatal to the crusading schemes of Pius II. In spite of his desire to avoid a quarrel with France, he could not withdraw his support from Ferrante, and he was further attached to the Aragonese cause by the influence of Francesco Sforza, who feared that an Angevin triumph in the south might encourage the duke of Orleans to advance a claim to Milan. But in spite of the aid of the Pope and of Sforza, the cause of Ferrante did not at first prosper. John gained an important victory at Sarno on July 7, 1460; and his general, Jacopo Piccinino, also succeeded in defeating the Aragonese forces. But in the next year there was a very decided turn of fortune. The death of Charles VII. gave the French throne to Louis XI., who was ill disposed towards his Angevin relatives, while he was a warm admirer of Francesco Sforza. Genoa had already repudiated the French control, and before long Louis agreed to transfer his claims over Genoa to the duke of Milan. Thus John of Calabria, who had brought with him few men and little money, was deprived of the prospect of aid from France. His Neapolitan supporters began to desert him after his first reverse in 1462, and in 1464 John was compelled to abandon the enterprise as hopeless and return to France. His brief but adventurous career is full of incident. He sought to punish Louis XI. for his desertion by joining the League of the Public Weal. When that war was over, he carried on his quarrel with the house of Aragon by joining the Catalans in their revolt against John II. In that quarrel he met his death in 1469. Four years later his only son, Nicolas, also died, and the male descendants of René of Provence came to an end. The house of Anjou was now represented only by René himself; by his daughters, Yolande and Margaret, who had married respectively Frederick of Vaudemont and Henry VI. of England; and by his brother's son, Charles of Maine. Of the two daughters, Margaret had lost her only son, Edward, at Tewkesbury in 1471; but

Yolande had a son, called René after his grandfather, who was engaged in defending the duchy of Lorraine against the attacks of Charles the Bold of Burgundy. When the old René died in 1480, he disinherited this grandson, who was then his only descendant, in favour of his nephew Charles of Maine, with the further provision that on the extinction of the latter's line the inheritance should pass to the French crown. In the next year Charles of Maine died without children, and by virtue of this will Provence and Bar were seized by Louis XI. At a later date Charles VIII. was induced to found upon his succession to the house of Anjou a claim to the crown of Naples, which inaugurated a new epoch, not only in the relations between France and Italy, but also in the international politics of Europe.

During the war in Naples Pius II. had despaired of a crusade, and with characteristic ingenuity and self-confidence he devised a new scheme for securing the victory of the cross over the crescent. The eloquence which had failed to arouse the princes of Europe might prove more successful with their heathen opponent. He drew up and despatched a lengthy epistle to Mohammed II., urging him to become a Christian, and promising on that condition to confirm him in possession of the eastern empire, as his predecessors had given the empire of the west to Charles the Great. As far as we know the Sultan returned no answer to this unique proposal. But the pacification of Naples by the victory of Ferrante, and the growing uneasiness of Venice at the continuance of Turkish aggression in Greece and the Archipelago, encouraged the Pope to resume his more warlike plans. In 1463 he concluded an alliance with the Venetians and Mathias Corvinus of Hungary. He renewed his exhortations to a general crusade, and declared his intention of leading it in person. In 1464 he went to Ancona, which had been fixed for the meeting of the crusading forces. Again the aged Pope met with a bitter disappointment. The only crusaders at Ancona were a few

Death of
Pius II.
at Ancona.

adventurers who had nothing to lose, and hoped to make their profit out of the papal treasures. At last, on August 12, the Venetian fleet approached the harbour, and Pius was carried to the window to witness its entry. This effort was his last, and two days later he died, straining his eyes eastward, and with his last breath urging the prosecution of the crusade. The poignant contrasts of his career were conspicuous to the last. Æneas Sylvius, careless, light-hearted, and untroubled by moral scruples, had faithfully represented the new epoch in which he lived. Pius II., enthusiastic, gloomy, and passionate, seems to be the ghost risen from the Middle Ages, which were dead.

The pontificate of Paul II. was short and comparatively uneventful. He belonged to the Venetian family of the Paul II., Barbi, and his éléction seemed likely to cement 1464-71. that alliance between the papacy and the maritime republic on which Pius II. had ultimately relied for resistance to the Turkish advance. But Paul acquiesced without much protest in the failure of his predecessor's plans; and by urging Hungary into war with the heretical George Podiebrad of Bohemia, he rendered impossible even a league of eastern princes against the infidel. Paul's name is also associated with a so-called persecution of the humanists, because he imprisoned some members of the Roman academy who had talked vaguely and irresponsibly of a restoration of the republic. But it is absurd to treat a simple measure of internal police as evidence of a definite and far-reaching policy, or as marking a reaction from the patronage of letters by Nicolas V. The whole episode has attracted more attention than it deserves through the interested emphasis of the chronicler, Platina, who has exaggerated both his own sufferings and his own importance. Paul II. was a true Pope of the Renaissance, looking at affairs from an intellectual rather than from a spiritual point of view, and exulting both in his own handsome figure, which led him to desire the name of Formosus, and in the beauty of the jewels and

carvings of which he was an industrious and intelligent collector. But he was free from the grosser vices and crimes which have given notoriety to his successors.

The name of Sixtus IV. might well have been handed down to posterity as typifying the extreme degradation in which the papacy was involved in this century by its absorption in temporal interests, but that the bolder and more picturesque crimes of Cæsar Borgia have secured that pre-eminence for the pontificate of Alexander VI. The aims and actions of Sixtus were those of a secular prince, and display that cynical disregard of moral considerations which has been portrayed as the characteristic of the age in the pages of Machiavelli. No previous Pope had ventured to show so reckless a determination to use his office for the advancement of his relatives, and to employ his relatives as a means of strengthening the temporal power of the papacy. Three of his nephews were the sons of his brother, Raffaele della Rovere. The eldest, Lionardo, was made prefect of Rome, and was married to a natural daughter of Ferrante of Naples. Giuliano della Rovere, the most capable and vigorous of the family, was raised by his uncle to be cardinal of San Pietro ad Vincula. After playing a prominent part as the opponent of the two succeeding popes, he gained the tiara himself as Julius II. The third son, Giovanni, succeeded Lionardo as prefect of Rome, and Sixtus obtained for him the hand of Joanna, daughter of Federigo da Montefeltro, duke of Urbino, a marriage which in the next generation gave the duchy to a della Rovere dynasty. But the Pope's most lavish favours were conferred upon the two sons of a sister, Piero and Girolamo Riario. Piero was made a cardinal at the age of twenty-five, and received so many preferments, including the archbishopric of Florence, that he drew a princely revenue from the Church. He only lived three years after his uncle's accession, but during that time he succeeded in startling Europe by the stories of the extraordinary pomp and debauchery on which he squandered his wealth. The

promotion of Girolamo Riario, a layman, was effected within the papal states, and had more lasting results. The papal treasure was employed to purchase for him the lordship of Imola; he was married to Caterina, a natural daughter of Galeazzo Maria Sforza, and on the extinction of the Ordelaffi in 1480 his uncle's support gained for him the city of Forli with the title of duke. The whole policy of the Pope was directed for years to the aggrandisement of a youth who proved no more worthy of his elevation than his brother had been. In 1488 the people of Forli rose and murdered him, and only the heroism of his widow secured for a time the continuance of his dynasty.

The obvious intention of the Pope to extend his temporal power and to abuse it for the aggrandisement of his nephew excited the misgivings of the neighbouring states, and especially of Florence, which was at this time under the guidance of Lorenzo de' Medici. In order to remove this obstacle from their way, Sixtus and Riario organised the famous conspiracy of the Pazzi for the overthrow of the Medici rule. The Pope asserted his ignorance of any scheme of assassination, but he must have known that success could hardly be achieved without bloodshed, and his denial of complicity was a merely formal attempt to save the credit of the holy see. The plot very narrowly missed its aim: Giuliano de' Medici was killed in the cathedral of Florence, but Lorenzo escaped with a severe wound, and the chief conspirators, including the archbishop of Pisa, fell victims to the popular fury. Enraged at the failure of his scheme, Sixtus excommunicated the Florentines for laying violent hands upon a dignitary of the Church, and formed a league with Ferrante of Naples for the overthrow of the republic. The disorder in Milan following the death of Galeazzo Maria Sforza, and the fact that Venice was still engaged in the Turkish war, deprived Florence of her natural allies, and in 1479 the city was exposed to serious peril. Lorenzo de' Medici, however, not only averted the danger,

but dexterously employed it to strengthen his authority. At considerable personal risk, he undertook a journey to Naples, and succeeded in negotiating a peace with Ferrante. Sixtus was at first inclined to continue the war; but the occupation of Otranto by a Turkish force in 1480 constituted such a serious menace to Italy, that the obstinate Pope was forced to come to terms with his opponents and to withdraw the bull of excommunication against Florence.

The Turkish invasion compelled Ferrante of Naples and his son Alfonso to withdraw their troops from Tuscany, and to concentrate their attention on the recovery of Otranto. Fortunately for Italy, the death of Mohammed II. on May 3, 1481, and a dispute as to the Turkish succession, led to the withdrawal of the invaders, and enabled the Neapolitan rulers to claim a military triumph which they had done little or nothing to bring about. But the alliance between Naples and the papacy had been completely annulled, and Sixtus, as restless as ever, did not scruple to form a new coalition, which was destined to have momentous results to Italy. Venice had concluded the treaty of Constantinople with the Turks in 1479, and was eager to obtain upon Italian soil compensation for its losses in the east. Hence arose in 1482 an unscrupulous and unprecedented alliance between the papacy and Venice for the spoliation of Ercole d'Este of Ferrara. The danger to the balance of power in Italy led to the formation of a hostile coalition between Naples, Florence, and Milan. Sixtus IV. soon discovered that he had gained nothing by his change of allies. Venice had seized the district of Rovigo from Ferrara, but had obviously no intention of handing over any share of the spoils to Girolamo Riario. At the same time, Neapolitan troops entered the papal states and threatened Rome, and there was a risk that the misdeeds of the papacy might result in the meeting of another general council. The Pope, whose policy was entirely selfish, did not hesitate to avert the danger by a sudden and complete change of front.

Relations
with Ferrara
and Venice,
1482-84.

In 1483 he made peace with Naples and Ferrara, excommunicated the Venetians for disturbing the peace of Italy, and prepared to seize the cities which Venice had acquired within the papal dominions. But his restless greed was again doomed to disappointment. Venice adroitly ended the war by the treaty of Bagnolo, in which the only loser was the unfortunate duke of Ferrara, and Sixtus was chagrined to find that he had gained absolutely nothing by his ill-faith. Soon afterwards he died on August 12, 1484, and contemporary lampoons declared that he died of peace.

‘Nulla vis potuit sævum extinguere Sixtum :
Audito tantum nomine pacis, obit.’

In Rome itself the pontificate of Sixtus IV. had been as turbulent as his foreign relations. The great families, and especially the Colonnas, had opposed the advancement of the Pope's nephews, and had thus drawn on themselves the wrath of Sixtus. A long civil war ensued, in which the barons allied themselves with the foreign enemies of the Pope, at one time with Florence, at another with Naples or with Venice. In this war Sixtus displayed all his cold-blooded cruelty and treachery. The stronghold of his enemies was the castle of Marino, which was surrendered by Lorenzo Colonna on condition that he should be restored to his family. Sixtus fulfilled his promise by sending them his corpse. The mother appeared at the papal court, and producing her son's head, exclaimed, ‘See how a Pope keeps faith!’ It was a graphic picture of the terrible degradation of Rome by the Pope's abandonment of spiritual aims for temporal ambition. Directly the Pope's death was known, the Colonnas headed a rising which sacked the palaces of the Riarios and drove their adherents from Rome.

The character of Innocent VIII. has been painted by some historians in blacker colours than it deserves. It is true that he was the first Pope who recognised his own children, but they seem to have been born before he took orders, and his devotion to them did not involve

him in such scandals as disgrace his predecessor and his successor. The principality of Anguillara was purchased for his son, Franceschetto Cibo, but the latter was more interested in gaining money than power, and his first act after his father's death was to sell his territories to Virginio Orsino. Innocent himself had little capacity and little interest in politics. He spent great part of his time in a state of lethargy, which not infrequently gave the appearance of death. Among those who exercised a dominant influence over the feeble Pope was Lorenzo de' Medici, who married his daughter Maddalena to Franceschetto Cibo, and as a part of the bargain, obtained the cardinal's hat for his second son, Giovanni, at the age of fourteen. It was under Innocent VIII. that the Medici obtained that position at the papal court which enabled them to produce two almost successive popes, Leo X. and Clement VII., and enabled these popes to use the power of the Church to suppress the liberties of their native city. • •

By far the greatest difficulty of Innocent VIII.'s pontificate was connected with Naples. Ever since the withdrawal of John of Calabria in 1464, the bastard house of Aragon had enjoyed undisputed possession of the Neapolitan throne. Jacopo Piccinino, the *condottiere*, who had been formidable in the previous struggle, was enticed to Naples by Ferrante with the aid of Francesco Sforza, and was treacherously put to death in 1465. At the time of his alliance with Sixtus IV. against Lorenzo de' Medici, Ferrante had succeeded in reducing his tribute to his papal suzerain to the annual gift of a white horse. The freedom from external danger enabled the king to make the royal authority despotic, and to annul the independence of the feudal nobles. His son, Alfonso of Calabria, gained an undeserved military reputation by the withdrawal of the Turks from Otranto, and from that time was associated with his father in the government. Under his influence the royal rule became even more tyrannical and oppressive, and in

Rising of
Neapolitan
barons.

1485 the barons determined to rebel. Innocent VIII., who desired to extort the old tribute from Naples which his predecessor had commuted, espoused their cause, and Venice, always hostile to the house of Aragon, gave secret assistance. It was decided to revive the Angevin pretensions, and René of Lorraine, the grandson of René le Bon, was invited to come to Italy as a claimant of the crown for which his ancestors had so long contended. But the rebellion ended in complete failure. Neither Florence nor Milan would consent to such a disturbance of the normal relations of Italy as would be involved in French intervention. The military force of the Neapolitan rulers was overwhelming, and Alfonso, for the second time, led an army against Rome. To complete the disasters of the Pope and his allies, René of Lorraine, who was engaged in prosecuting a hopeless claim upon Provence at the French court, allowed the opportunity of gaining Naples to slip from his hands. But the mere threat of a French invasion was enough to induce Ferrante and Alfonso to come to terms. The Pope was bought off by the restoration of the former tribute, and the Neapolitan barons, deprived of all hope of assistance, submitted on the understanding that a full amnesty should be granted to them. The promise was broken with that cynical disregard of good faith which marked the politics of Italy in the fifteenth century. The nobles who returned to Naples were imprisoned, and were never again seen alive. The sole survivors were those who preferred to remain in exile rather than trust the rulers whom they had endeavoured to depose. These men eagerly watched for an opportunity which might enable them at once to avenge the death of their associates and to regain their own confiscated territories. In 1493 they were at last enabled to act. The death of Lorenzo de' Medici, and the growing alienation of Ludovico Sforza from Naples, removed some of the chief securities for peace in Italy. By the advice of Venice the Neapolitan exiles petitioned for the intervention, not of the duke of Lorraine, but of the French king,

Charles VIII. Before any final decision had been come to at the French court, Ferrante had died on January 25, 1494, and Alfonso II. was left to face the danger of which his own violence and misrule had been the principal cause.

Innocent VIII. had not lived to witness this new crisis in the history of Naples. His death in 1492 had been followed by a very important election. The most prominent candidates for the suffrages of the conclave were ^{Election of} Alexander VI. Ascanio Sforza, the brother of Ludovico, and Giuliano della Rovere, the nephew of Sixtus IV. But neither could obtain the requisite majority, and in the end Ascanio Sforza was bribed to support the candidature of the wealthiest of the Roman cardinals, Rodrigo Borgia, a nephew of Calixtus III. The well-known fact that he had several natural children, born to him not only since he was a priest, but since he had been a cardinal, seems to have been completely disregarded. A lavish expenditure of money and promises secured his election, and he assumed the title of Alexander VI. The first great problem which the new Pope had to solve concerned the approaching struggle in Naples. In spite of his obligations to Ascanio Sforza, and his antagonism to the Orsini, who were closely connected at this time with the house of Aragon, Alexander allowed himself to be drawn in 1493 into an alliance with Ferrante, and on his death he recognised the title of Alfonso II. The French invasion, which the Pope was thus pledged to resist, threatened the papacy for some time with serious dangers; but in the end it proved one of the chief circumstances which enabled Alexander himself, and afterwards Julius II., to erect the temporal power upon firmer foundations than any of their predecessors had been able to construct.

CHAPTER XIV

FLORENCE UNDER THE MEDICI

The period of oligarchical rule in Florence—Maso and Rinaldo degli Albizzi—Niccolo da Uzzano—The opposition and Giovanni de' Medici—War with Filippo Maria Visconti—The *Catasto*—Unsuccessful attack upon Lucca—Expulsion of the Medici—Fall of the Albizzi, and return of Cosimo de' Medici—Character and methods of Cosimo's rule—Luca Pitti and the *coup d'état* of 1458—Cosimo's foreign policy—Piero de' Medici and his opponents—Victory of Piero—Accession of Lorenzo de' Medici—Approximation to monarchy—Alienation of Naples, and quarrel with Sixtus IV.—Conspiracy of the Pazzi—War in 1478 and 1479—Lorenzo goes to Naples—Conclusion of peace—Constitutional changes in 1480—Lorenzo's later years—Importance of his death—Reckless conduct of the younger Piero.

THE leaders of the Florentine democracy paid a heavy penalty for their momentary triumph in 1378. A violent reaction in 1382 restored the oligarchy under the leadership of the Albizzi, and for the next fifty years the curious machinery of the civic constitution was carefully manipulated to secure the ascendancy of the dominant faction. Although it is by no means the most famous, there can be no doubt that this is one of the most successful periods in Florentine history. Under the resolute guidance of a close oligarchy, Florence maintained a heroic struggle against the encroachments of Gian Galeazzo Visconti until his death in 1402 saved the city from almost inevitable submission. When the Milanese dominions fell to pieces, Florence seized the opportunity to gain a great prize; and the city of Pisa, which commanded the mouth of the Arno, was in 1406 compelled to surrender after an obstinate

Oligarchical
rule in
Florence.

resistance (see p. 244). Then followed a long war with Ladislas of Naples, in the course of which Florence acquired the important town of Cortona. And in 1421 the commercial interests of the city were strengthened by the purchase from Genoa of a second port—Livorno.

For a long time the active leader of the victorious faction and the most influential politician in Florence was Maso degli Albizzi, a nephew of the Piero degli Albizzi who had been so prominent in the party strife of the fourteenth century (see p. 164). Maso had returned from exile in 1382, and at various times held most of the chief offices of the state. While he was gonfalonier in 1393 harsh measures were taken to complete the defeat of the democrats. But, apart from the severity shown to the unfortunate Alberti and their supporters, Maso showed himself a wise and tolerant ruler. When he died in 1417, his place was, to some extent, taken by his eldest son, Rinaldo, who displayed great industry and integrity, but less prudence and insight than his father. The almost hereditary prominence of these two men did much to accustom the Florentines to that disguised despotism which was afterwards established by the Medici. But the Albizzi never enjoyed such undivided ascendancy as was held by Cosimo and Lorenzo de' Medici. At least as influential a leader as Rinaldo was Niccolo da Uzzano, who is frequently spoken of by contemporaries as the head of the party. He seems to have been a sincere enthusiast for aristocratic rule, and it was greatly due to his influence that the Albizzi were prevented from making themselves absolute masters of the city. His reputation for wisdom and insight was deservedly high, and his death in 1432 proved a fatal blow to the party in whose counsels he had always been on the side of moderation.

In spite of the services which it rendered to the state, the oligarchical government did not succeed in averting discontent and hostility. The strongest political sentiment among the Florentines was the love of equality, which found

practical expression in the system of filling offices by lot. This love of equality was more outraged by the domination of a clique of ruling families than it would have been by the government of a single despot. The lesser guilds and the lower classes resented their virtual exclusion from office; and many wealthy citizens, who had incurred the displeasure of the dominant faction, found themselves equally left in the cold. Moreover, the militant foreign policy of the government was extremely expensive; and the burden of taxation, as was always the case in Florence, fell more heavily upon the opponents than upon the supporters of the government. Gradually the cause of the opposition came to be more and more identified with the house of Medici. The action of Salvestro de' Medici in 1378 had identified the name with the popular cause, though he did not personally profit by its short-lived victory. In 1393, when the severe measures of Maso degli Albizzi provoked a popular rising, it was to Vieri de' Medici, a kinsman of Salvestro, that the mob appealed for guidance, and it was his moderate advice which checked the rebellion. But it was a member of another branch of the family—Giovanni de' Medici—who, in the second decade of the fifteenth century, came to be regarded as the leader of those who disapproved of the conduct of affairs by the ruling party. Giovanni was a banker and money-changer, and was so successful in his business that he became the richest citizen in Florence, if not in Italy. He employed his wealth in extending his popularity, though he was extremely careful to avoid any action which might give the government a handle against him. In 1421 he was drawn as gonfalonier, and Niccolo da Uzzano wished to cancel the appointment as dangerous. But Giovanni's hold on the people, and especially on the lesser guilds, made such a step perilous, and his two months of office passed uneventfully. Giovanni de' Medici died in 1429, leaving two sons—Cosimo, afterwards the ruler of Florence, and Lorenzo, whose descendants in the sixteenth century became grand-dukes of Tuscany.

As long as the oligarchical government was successful, there was little prospect of its overthrow, but from 1421 its credit steadily declined. The reunion of the Milanese territories under Filippo Maria Visconti constituted a serious menace to Florence, ^{War with Filippo Maria Visconti.} and the imperative duty of self-defence compelled the republic to embark once more in a desperate struggle for existence. In 1424 the Florentine army, under Pandolfo Malatesta, was defeated with great loss in the battle of Zagonara. A despairing appeal was made to Venice for assistance, and the intervention of Carmagnola saved Florence from annihilation. But the spoils of victory were monopolised by Venice, and the aggrandisement of their ally was by no means popular with the Florentines. The power of the oligarchy had rested upon the success of their foreign policy, and alarming discontent was the inevitable result of an unsuccessful war. Two important measures were resorted to in the hope of restoring the prestige of the dominant faction. The heavy expenses of the war had called attention to the old grievance of arbitrary taxation, and in 1427 a reform was introduced to provide a more ^{The Catasto of 1427.} equitable basis of assessment. According to Machiavelli, the acceptance of the *Catasto*, as it was called, was due to the influence of Giovanni de' Medici. Every citizen was to report to the gonfalonier of his district his whole income from every source; and concealment was to be punished by confiscation. From fixed capital the income was to be estimated at seven per cent. These reports were to be collected into four books, one for each quarter of the city; and henceforth the assessment of taxation was to be determined by them instead of depending upon a man's political position and opinions. As wealth fluctuated rapidly in a mercantile community, a new *catasto* was to be made every three years. It was a notable sacrifice on the part of the ruling clique, and probably tended to weaken their unanimity, but it helped to pacify public opinion for a time. Rinaldo

degli Albizzi now came forward with a new scheme for restoring the credit of his party. Ever since the days of **Attack upon Lucca, 1430.** Castruccio Castracani, the annexation of Lucca had been a darling object of Florentine ambition. Lucca was, at this time, ruled by one of its own citizens—Paolo Guinigi—who had sided with Milan in the recent war. Rinaldo proposed to treat this as a pretext for attacking Lucca. It was in vain that Niccolo da Uzzano pointed out the risks of the enterprise. Giovanni de' Medici was dead, and his son Cosimo supported the proposal of Rinaldo. His conduct on this occasion has exposed him to the suspicion that he foresaw the failure of the enterprise, and was willing to ruin his opponent even at the expense of the state. War was declared in 1430, and Rinaldo degli Albizzi was appointed one of the commissioners to superintend the siege of Lucca. The enterprise was as unsuccessful as it was unjust, and its failure was ultimately fatal to the party in power. Rinaldo, unjustly accused of peculation, threw up his command in disgust. The duke of Milan was drawn into the war, and the two most famous *condottieri* of the day—Francesco Sforza and Niccolo Piccinino—were employed in his service. After suffering serious reverses in the field, the Florentines were glad to accept the mediation of the emperor Sigismund, and in 1433 peace was made, leaving things as they were before the war.

But no treaty could restore the previous conditions within the city. Niccolo da Uzzano had died in 1432, and his death **Expulsion of the Medici, 1433.** deprived his party of their strongest support, while it removed the moderating influence on their conduct. Cosimo de' Medici was at once more ambitious and less cautious than his father, and he and Rinaldo degli Albizzi were now avowed rivals for ascendancy. The latter, conscious of his growing weakness, determined to have recourse to violence. In September 1433, when the signoria was composed of Rinaldo's adherents, Cosimo de' Medici was summoned to appear before the magistrates, and

was imprisoned while his fate was deliberated upon. For some time it was generally expected that he would be put to death. But the wealth which his father had collected stood him in good stead, and his judges were not proof against corruption. The majority decided for a milder sentence. Cosimo was banished for ten years to Padua, and his brother Lorenzo for five years to Venice. Most of their prominent adherents shared their exile, and the Medici were declared incapable of holding any office in Florence.

The victory of Albizzi seemed to be assured when Cosimo went into exile in October 1433. The ordinary machinery of a Florentine *coup d'état* had been set in motion. The people had been convened in the piazza, and had approved the appointment of a *balia* or revolutionary committee. But by a strange oversight on the part of so experienced a partisan, Rinaldo had failed to obtain for this committee the right of refilling the bags with the names of candidates for office. The result was that the weakness of his position was only slightly modified. His own party was divided and inclined to be mutinous because the *catasto* was not abolished. And the alienation of public opinion by military failures could only be removed by some conspicuous success. In 1434 Florence became involved in a war in Romagna between Filippo Maria Visconti and the Pope. Again her troops were defeated in the field, and her ally, Eugenius iv., driven from Rome by the Colonnas, was forced to seek a refuge within her walls. In this moment of depression the accident of lot resulted in the formation of a signoria in September 1434, which was favourable to the Medici. Rinaldo Recall of the Medici, 1434. in his turn was summoned before a hostile magistracy, and he came accompanied by eight hundred armed men. But he lost the favourable opportunity for overawing his opponents by consenting to an interview with Eugenius iv., who had offered his mediation. This delay proved fatal. The *popolo minuto* took up arms and surrounded the piazza; while the signoria called in armed

peasants from the country. The parliament created a *balia* in the interests of the party which had for the moment the upper hand. The Medici and Alberti families were recalled and declared eligible for office. Rinaldo degli Albizzi with his son and about seventy partisans were banished from Florence, and few of them ever returned to their native city. Cosimo de' Medici, who was in Venice when the news of this sudden revolution reached him, re-entered Florence on October 6, 1434. For the next three centuries the history of Florence is bound up with the history of the house of Medici.

The ascendancy which the dramatic events of 1433 and 1434 gave to Cosimo de' Medici was not only retained during his life, but became for a time a hereditary possession. Yet it is impossible to point to any great apparent change in the constitution. The old magistracies and councils continued to exist and to fulfil their former functions.

**Character of
Medicean
Rule.**

Cosimo was extremely careful to avoid any outward signs of despotism. He continued to live in his former residence; and nothing in his dress or his manner of life distinguished him from his fellow-citizens. Like his defeated rival, he surrounded himself with a sort of body-guard of allied families, whose interests he skilfully identified with his own. To all appearance this was as much an oligarchy as the government which it had displaced. The difference is to be found in two points. On the one hand Cosimo was enabled, partly by his wealth, and partly by his extensive foreign connections, to exercise a far stronger control over his adherents and over the state than either Maso or Rinaldo degli Albizzi had ever been able to wield. And, on the other hand, the influential families who rose to power under Cosimo did not represent the domination of a class as the rule of the Albizzi had done. The Medici never forgot that they owed their original rise to their championship of democratic equality; and they were careful to avoid any unnecessary collision with the prejudices of the mob.

Even a disguised despotism must aim at the obliteration of classes, and this can be clearly traced in the policy of Cosimo. He transferred several families from the lesser to the greater guilds, and thus obscured a distinction which had been at one time of supereminent importance. And he even procured the repeal of the disqualifications against the old nobility on which the foundations of the historic municipality had been built.

It is not difficult to trace the methods by which Cosimo maintained the power which had fallen into his hands. He had two primary objects to attain: he must prevent the more important offices from falling into the hands of malcontents, and he must diminish their number by bringing home to them the hardships and dangers of opposition and the rewards that were to be gained by loyalty. Cosimo boasted of the humanity of his rule, and he was always careful to intrust to his followers the initiation of harsh proposals. • But his policy was really one of proscription. The Albizzi and their allies were treated with the greatest severity. Not only were they banished, but their place of exile was constantly changed, and they were hunted about Italy like wild beasts. It was no wonder that their patriotism gave way to a desire for revenge, and they joined the duke of Milan against their native city. But the battle of Anghiari in 1440 destroyed all hope of success, while their treason gave a pretext for more merciless treatment. The financial administration was employed to the same ends. The *catasto* of 1427 was abolished, and the system of arbitrary assessment was revived. This enabled Cosimo to reward his adherents and to punish malcontents. Giannozzo Mannetti, a harmless student, whose only offence was his popularity, was called upon to pay taxes to the amount of 135,000 florins, and could only avoid ruin by going into voluntary exile. It was a common saying that Cosimo employed the taxes, as northern princes used the dagger, to rid himself of his opponents.

Methods
of Cosimo's
Government.

For the regulation of offices Cosimo employed the revolutionary machinery which was in theory the ultimate enforcement of popular sovereignty. The *balìa* which had recalled the Medici in 1434 had received from the parliament full power to reform the state. Every five years this power was renewed—in 1439, 1444, 1449, and 1454. The most important act of the *balìa* was the appointment of ten *accoppiatori* to superintend the filling of the bags with the names of those who were eligible for office. This was in itself a fairly ample assurance that no opposition to the Medici could be anticipated from the magistracy; and to make it doubly sure, the names of the gonfalonier and priors were selected every two months by the *accoppiatori*. They were made, as the phrase went, not by lot, but by hand. But as time went on, this prolonged departure from normal procedure gave rise to grumbling; and as there were good reasons for avoiding at the moment any appearance of disunion in the city, Cosimo determined to yield. In 1455 the *balìa*, which had been renewed the year before, was abolished, and the practice of drawing the names of the signoria was revived. The concession was more apparent than real; for the bags had only recently been refilled, and three years would elapse before a new *squittinio* would be necessary. For that time the ascendancy of the Medici party was secure, and before it had elapsed measures might be taken to prolong it. But that the revival of liberty was of some moment is proved by the proposal in the signoria of January 1458 to restore the *catasto*. Cosimo's partisans urged him to employ energetic measures to defeat a scheme which attacked their own pockets. But he was not unwilling to teach them how dependent they were upon his support, and he allowed the system of strict and impartial assessment to be revived.

There was one very obvious danger to which such a government as that of Cosimo de' Medici was exposed. Jealousy and ill-will might arise among his intimate associates. It was his deliberate policy to

Coup d'état
of 1458.

place them in prominent positions, and they were perforce intrusted with the secrets of his administration. One or more of them might seek to use their experience for their own advancement and to free themselves from the control of their patron. This danger was partially realised in Cosimo's later years, and serious difficulties arose from the same source in the time of his son. In 1458 it had become a grave question how far the revival of republican freedom should be allowed to go. The death of Alfonso of Naples removed one great motive for continuing the conciliatory policy of the last three years; and the appointment to the gonfaloniership of Luca Pitti, one of the oldest and closest of Cosimo's adherents, gave the opportunity for decisive action. After careful precautions had been taken to control the avenues to the piazza and to impress the mob, a parliament was convened by the ringing the great bell of the Palazzo Publico. A *balia* of 350 citizens, together with the existing signoria, was endowed with full authority. *Accoppiatori* were appointed to fill the bags, and a permanent committee, the *Otto di Balia*, received the control of the civic police. By a curious irony it was announced to the people that the priors should henceforth be called, not *priori delle arti*, but *priori della Liberta*. The name was chosen, says Machiavelli, to designate what had been lost.

But in this revolution to confirm the previous revolution Cosimo had carefully abstained from taking any active share. In the eyes of the mob the victorious politician was Luca Pitti, who seemed to himself, as to Luca Pitti. others, to overshadow his employer. Puffed up with ambition, he began to build the magnificent palace on the southern side of the Arno, which, afterwards the residence of the grand-dukes of Tuscany, and now the shrine of one of the greatest picture galleries in the world, has done more than any political achievement to preserve to posterity the name of its founder. Cosimo was probably convinced that little real danger was to be dreaded from Luca Pitti, and he made no

attempt to alter or correct the popular impression. As long as his influence was really unimpaired he cared little who had the appearance and pomp of supremacy.

As a great banker, Cosimo de' Medici was an important personage in many foreign courts, quite apart from his political position in Florence. With very notable dexterity he played his two parts so as to make each improve the other. He employed his financial relations to strengthen his hold upon the strings of Florentine policy, and he utilised his political influence to increase his business and his profits. It is in foreign affairs far more than in domestic administration that he showed himself to be the real ruler of Florence. He inherited from the Albizzi a struggle against Filippo Maria Visconti and an alliance with Venice. As long as the duke of Milan threatened the independence of Florence, and especially when he espoused the cause of the exiled Albizzi, Cosimo could not safely depart from the traditional policy of Florence. But the death of Filippo Maria in 1447 and the establishment of a republic in Milan gave him more scope for originality. He had to choose between the aggrandisement of Venice in Lombardy, which must have been the inevitable result of the maintenance of the Milanese republic, and the erection of a military power in Milan which should hold Venice in check. Without any hesitation he decided for the latter alternative, and the later history of Italy was vitally influenced by his choice. The financial and other aid which he received from Florence was one of the most potent factors in enabling Francesco Sforza to obtain the lordship of Milan in 1450, and to conclude the treaty of Lodi with Venice in 1454.

Another hardly less momentous question for Italy arose after the death of Alfonso v. of Naples, when in 1460 the Angevin claim was revived in antagonism to Ferrante. Although Florence was closely allied with France by her Guelf traditions and her commercial interests, Cosimo was resolute in his support of Ferrante and in urging Francesco

**Cosimo's
Foreign
Policy.**

Sforza to do the same. Again his attitude helped to turn the scale in a struggle where, for a time, the balance was undecided. He just lived to hear of the retirement of John of Calabria, which secured the bastard house of Aragon from serious attack for the next thirty years. By his action in these two great crises Cosimo must be regarded as the real author of that triple alliance between Naples, Milan, and Florence, of which his grandson in later years made such a masterly use.

Cosimo's death in 1464 left the headship of the family to his only surviving son, Piero, who was already middle-aged and in feeble health. The five years during ^{Piero de'} which he survived his father are chiefly note-^{Medici and} worthy because they witnessed the great split in ^{his opponents.} the Medicean party, which careful observers must have seen for some time to be inevitable. Four of the most prominent associates of Cosimo—Luca Pitti, Diotisalvi Neroni, Angelo Acciaiuoli,^{*} and Niccolo Soderini—were unwilling to give to the son the deference which they had shown to the father. Luckily for the Medici, their unanimity did not go far. The first three were actuated by motives of personal ambition, which might easily lead them to quarrel with each other, while Niccolo Soderini was an enthusiast for democracy, and had no desire to humble Piero in order to exalt another in his place. Neroni was the ablest of the leaders, but he was lacking in personal courage, and preferred to employ intrigue and constitutional methods rather than violence. It was only gradually that two parties were organised in avowed opposition to each other. The anti-Medicean party received the nickname of the Mountain, because the great palace of Luca Pitti was rising on the hill of San Giorgio. The residence of the Medici stood on level ground to the north of the Arno, and hence Piero's adherents were known as the Plain.

The first trial of strength took place in 1465, when the opposition made a bid for popularity by proposing to abolish

the *balìa* of 1458 and to restore the constitutional method of filling offices by lot. Piero was too cautious to oppose such a measure, and it was carried with virtual unanimity. In November the first draw took place, and Niccolò Soderini became gonfalonier. Disunion among the leaders prevented any use being made of the advantage which chance had given them, and Soderini went out of office at the end of December without having effected any further change in the constitution. In the next year the party strife was extended to foreign politics. Venice had never forgotten or forgiven the part which Florence had played in establishing the Sforzas in Milan. Now that Francesco was dead and succeeded by the more reckless Galeazzo Maria, there was some possibility of evicting a dynasty which was a perpetual bar to Venetian expansion in Lombardy. But to overthrow the Sforzas it was first necessary to overthrow the Medici. And so the leaders of the Mountain made overtures to Venice, regardless of the consideration that a complete reversal of foreign policy might damage the interests of Florence. The Venetians were too cautious to commit themselves to an alliance with a faction which might fail, and moreover they had the Turkish war on their hands. But there was a secret understanding that if Piero de' Medici were got rid of, either by the dagger or by a revolution, his opponents would be aided by troops under Bartolommeo Coleone, a *condottiere* in the pay of Venice, and Ercole d'Este, brother of the duke of Ferrara.

Piero knew enough of these schemes to induce him to draw closer the alliance with Milan and Naples which his father had bequeathed to him. His elder son, Crisis of 1466. Lorenzo, received his first experience of diplomacy by being sent on an embassy to Ferrante. The news that Ercole d'Este had advanced in the direction of Pistoia brought matters to a crisis. Piero hurried to Florence from his villa at Careggi, and is said to have escaped an ambush on the way through the vigilance and acuteness of Lorenzo.

Galeazzo Maria Sforza was invited to send troops to the assistance of Florence, and the peasants from the Medici estates were armed and brought into the city. On the other side Niccolo Soderini collected two hundred men who were kept in arms in the Pitti palace. Civil war seemed inevitable, but by a tacit agreement active violence was postponed till the new signoria was drawn at the end of August. Fortune or skill favoured the Medici, and a gonfalonier and priors devoted to their interests took up office on September 1. On the next day the great bell called the people to a parliament in the piazza. The armed adherents of Piero commanded every entrance, and the dissentients who obtained admission were too few or too timid to make themselves heard. A numerous *balia* was proposed by the signoria and approved by acclamation. For the next ten years the priors were to be made by hand. Neroni, Acciaiuolo, and Niccolo Soderini were banished. Luca Pitti, who had been bribed or persuaded* to desert his associates, was allowed to remain, but his ostentation had made him unpopular, and he spent the rest of his life in harmless insignificance. His gigantic palace remained unfinished till it was completed by the Medici in the next century.

There still remained the danger of foreign intervention. Neroni, who had been banished to Sicily, defied the decree and repaired to Venice. It was decided to carry out the scheme which had been arranged in the previous year. Bartolommeo Coleone was to conduct in the interest of the exiles what was ostensibly a private enterprise. He was joined in the spring of 1467 by Ercole d'Este and several of the smaller princes of Romagna. Neapolitan and Milanese auxiliaries were sent to the aid of Florence, whose forces were under the supreme command of Federigo da Montefeltro, duke of Urbino. Italy watched with eager interest the progress of the campaign, which was conducted with the punctilious precision so dear to the professional soldier of Italy. There was a

Failure of
the anti-
Mediceans.

great deal of marching, but very little fighting and very little execution. The armies never came anywhere near Florence, whose fate was supposed to be at stake, and no decisive advantage was gained by either side. But this was in itself decisive enough. It was sufficient for the Medici to avoid defeat; the exiles could hope for nothing unless they gained a great victory. In 1468 peace was negotiated by Pope Paul II., leaving matters *in statu quo*. The exiles lost all hope of returning to Florence. Niccolo Soderini died in Germany in 1474; Neroni lived in Rome till 1482; Angelo Acciaiuoli entered a Carthusian monastery in Naples.

The struggle of 1466 and 1467 removed any possible doubt as to the position of the Medici. The whole aim of the opposition and their supporters had been to effect their overthrow, and the attempt had failed. They were undistinguished by any title, but they were as obviously the rulers of Florence as if they called themselves dukes or counts. This was made clear after the death of Piero de' Medici on December 3, 1469. Tommaso Soderini, Niccolo's brother, who had remained faithful during the recent crisis, convened a *pratica* or informal meeting of the principal citizens. He proposed that Lorenzo de' Medici, who was only twenty-one, and therefore below the legal age for holding any magistracy in the republic, should be invited to exercise the power that had been wielded by Cosimo and Piero. A deputation was chosen to carry the offer, which Lorenzo accepted after a becoming show of hesitation.

Lorenzo's conduct shows that he was fully conscious of the altered position which events had enabled him to assume. Hitherto the Medici had been content to intermarry with Florentine families, and thus to recognise their equality of rank. But Lorenzo, as a prince, must seek a foreign bride, and he married Clarice Orsini, a daughter of the famous family of Roman nobles. Though his own tastes led him to show an interest in art and literature, and to encourage

the amusements of the people, he was also inspired by the wish to establish a court on the lines which had become familiar in the principalities of Italy. In their intercourse with Lorenzo the Florentines showed a deference and even a servility which would have been deemed wholly out of place in the days of Cosimo and Piero. This growth of a monarchical element within the republic is probably the explanation of the numerous and obscure constitutional changes which were made or attempted

in the early years of Lorenzo's administration. Their essential object was to secure absolute control of appointments to the signory. In 1470 it was proposed that the *accoppiatori* should be chosen every year by a new college of forty-five, consisting of men who had discharged this function since the return of the Medici in 1434. The scheme was denounced as an attempt to subject the city to forty-five tyrants, and failed to pass the council of a hundred. In the next year, however, the same object was attained in a different way. The existing *accoppiatori* were associated with the sitting members of the signoria as a permanent committee, and the names which they proposed were to be carried in the Hundred by a bare majority, instead of by the usual majority of two-thirds. In the same year the legislative functions of the old councils of the people and of the commune were suspended for ten years. It is difficult to estimate the precise significance of these and other changes, but their general effect was to narrow the circle of families among whose members the more important offices circulated. This was certain to excite dissatisfaction; and among the malcontents we find the Pazzi, an old noble family which had devoted itself to commerce, and now became rivals of the Medici in business as well as in politics.

Events proved that discontent within Florence was not very formidable, unless it was reinforced by difficulties in foreign relations. Lorenzo had been brought up by his grandfather to regard Milan and Naples as

Foreign
policy.

the normal allies of Florence, Venice as a dangerous rival of Florence and a resolute opponent of the Medici ascendancy, and the papacy as a variable force depending on the idiosyncracies of rapidly changing popes, and requiring to be very carefully watched. Lorenzo had learned the lesson, but with the egotism and self-sufficiency of youth he was not disinclined to attempt a few experiments on his own account. If he could establish friendly relations with the papacy and with Venice, he might make his own position stronger than ever, and might pose as mediator and almost as arbiter in the relations of the Italian states. On the election of Sixtus IV. in 1471, Lorenzo went in person as Florentine envoy to carry the usual congratulations. He returned not only with a confirmation of his banking privileges in Rome, but with the lucrative appointment of receiver of the papal revenues. At the same time he opened negotiations with Venice, which led in 1474 to the embassy of Tommaso Soderini and the conclusion of an alliance between Venice, Milan, and Florence.

But these new connections were dearly purchased by the alienation of Naples. Ferrante regarded Venice as the inveterate enemy of his kingdom and his family. As long as the Medici had identified their interests with his own he had been eager to uphold their power in Florence. But a good understanding of Milan and Florence with Venice threatened Naples with isolation, and Ferrante must seek support elsewhere. Sixtus had already allowed the Neapolitan tribute to be commuted for a formal gift; and as the ties between Naples and the papacy were drawn closer, a coolness grew up between Sixtus and Lorenzo. The origin of the quarrel is to be found in the opposition of Florence to the aggrandisement of Girolamo Riario (see p. 282). Lorenzo refused to find the money for the purchase of Imola, and the Pope transferred the post of receiver-general from the Medici to the Pazzi. The dispute was speedily embittered. Sixtus

**Alienation of
Naples and
quarrel with
Sixtus IV.**

appointed Francesco Salviati to the archbishopric of Pisa without consulting Lorenzo, and in defiance of his wishes. The Florentines, on their side, refused to admit the archbishop to his see; they supported the Vitelli in Citta di Castello, and in many ways showed an inclination to thwart the Pope's schemes in Romagna. For some time, however, the dispute did not seem likely to lead to serious results. But the death of Galeazzo Maria Sforza in 1476, and the obvious weakness of the government of the regent, Bona of Savoy, encouraged the opponents of the Medici to bolder acts than they would have contemplated when Milan could give efficient support to Florence. In 1477 Girolamo Riario and Francesco Pazzi began to discuss in Rome Conspiracy how to overthrow a family which stood in the of the Pazzi. way of both of them. By the beginning of 1478 the main outlines of the conspiracy had been agreed to. Francesco Salviati and Jacopo Pazzi, the head of the family in Florence, had agreed to take part in the plot. It was understood that the Pope and the king of Naples would give active support, but they took no responsibilities for the actual means by which the desired end was to be attained. Assassination was a recognised weapon in Italian politics, and it was obviously difficult to effect a revolution in Florence without it. Sixtus IV. might plead that he was ignorant of this part of the design, but morally the plea is worthless. If the Medici government had been unpopular in Florence, it might have been possible to organise a rebellion and to overthrow them by means of a parliament. But there was no widespread discontent in the city, and the Pazzi had no strong following among either the lower or the wealthy classes. It was decided, therefore, to kill Lorenzo and his brother Giuliano, and to trust to the resultant confusion and foreign intervention. A number of hired mercenaries, headed by Giovanni Battista da Montesecco, were engaged to carry out the two immediate objects—the murder of the brothers and the seizure of the magistrates. It says much for the fidelity

of the plotters that no one was found to betray the design, in spite of the discouragement caused by unavoidable delays.

The chief difficulty arose from the necessity of assassinating Lorenzo and Giuliano at the same moment, for fear that one might receive warning from the fate of the other. And unless both were removed, the plot would end in failure. At last the desired opportunity was offered by a banquet which the Medici gave in honour of Cardinal Raffaele Riario, a great-nephew of the Pope. But Giuliano was too unwell to attend, and the time and place had to be altered. On Sunday, April 26, 1478, the two brothers were to be present at divine service in the cathedral, and the elevation of the host was to be the signal to the assassins. This gave rise to an unexpected difficulty. Montesecco, who had undertaken to slay Lorenzo, refused to commit sacrilege by shedding blood in a church, and two priests were chosen to take his place. But the priests, though they did not share the scruples, also lacked the strength and skill of the soldier. As the little altar bell tinkled, Giuliano was struck down, and Francesco Pazzi dealt the final deathblow. But Lorenzo was only wounded in the shoulder, and in the confused scuffle which followed he succeeded in escaping to the sacristy, where his friends closed the bronze doors in the face of the murderers. Elsewhere the conspirators were equally unsuccessful. Archbishop Salviati, who had gone to the Palazzo to superintend the seizure of the gonfalonier and priors, excited suspicion by his obvious agitation, and was seized with several of his followers. Jacopo Pazzi headed a procession through the streets with shouts of 'Liberty,' but the people raised the counter-cry of 'Palle! Palle!' in favour of the Medici, and the leaders of the demonstration were carried by the mob to the Palazzo. On the arrival of the news that Giuliano de' Medici was dead, Francesco Pazzi, the archbishop of Pisa, and several other prisoners were promptly hanged from the windows. Vindictive severity was shown to the Pazzi and their allies. Guglielmo Pazzi, who had

married Lorenzo's sister, was the only member of the family who escaped. The two priests who had taken refuge in a monastery were dragged from their sanctuary by the mob and barbarously murdered. Montesecco had left Florence, but he was captured, and after giving evidence which implicated the Pope in the conspiracy, was executed. One of the murderers succeeded in reaching Constantinople, but even there the vengeance of the Medici was able to reach him. He was handed over by Mohammed II., and brought back to Florence, where in 1479 he shared the fate of his accomplices.

Within Florence all danger was at an end. The cowardly nature of the attack rallied public opinion to the Medici; and the death of a brother, who had hitherto enjoyed the larger share of popular favour, served to exalt the survivor and to remove from his way a possible rival. The fate of the conspirators was a striking object-lesson to future malcontents. But Lorenzo's signal triumph only exasperated the foreign enemies whom his reckless policy had alienated. He had broken up the triple alliance, in which Florence served as a link between Milan and Naples, and had divided Italy into a northern and a southern league. These were now brought into collision by the failure of the Pazzi conspiracy. Both Sixtus IV. and Ferrante of Naples had good reasons for desiring the overthrow of Lorenzo, and these reasons were multiplied now that success had made him more formidable. The Pope, urged on by Girolamo Riario, and infuriated by the execution of an archbishop and the murder of priests, called upon the Florentines to banish Lorenzo, who was to be made the scapegoat for the crime of his opponents. The citizens refused to give up their leader, and published the confession of Montesecco. Sixtus laid the city under an interdict, and prepared for war. The papal troops under Federigo da Montefeltro and a Neapolitan army under Alfonso of Calabria marched into southern Tuscany, where the adhesion of Siena gave the

War with
Naples and
the Papacy.

invaders a convenient base of operations. Florence appealed to her allies, and obtained assistance from Milan under Gian Jacopo Trivulzio, and from Venice under Galeotto Pico of Mirandola. Ercole d'Este was appointed commander-in-chief for the republic. Great hopes were also entertained of the intervention of France, and Louis XI. despatched Philippe de Commines to Italy to try what diplomacy could effect in favour of Lorenzo de' Medici.

In 1478 Florence made a creditable resistance against superior forces. The fortification of Poggio Imperiale blocked Campaigns of the Val d'Elsa, the most vulnerable approach to 1478 and 1479. the city; and when the disappointed invaders turned eastwards to the valley of the Chiana, they had only completed the preliminary operation of taking Monte San Savino when winter put an end to operations. But in the campaign of 1479 fortune turned decisively against the Florentines. A revolution in Milan, which was dexterously organised by Ferrante, not only compelled the withdrawal of the Milanese troops; but by substituting the rule of Ludovico Sforza for that of Bona of Savoy, detached Milan for a time from the Florentine alliance. The Turkish attack on Scutari, which reduced Venice to such straits that it was necessary to make the peace of Constantinople, and to refrain from any vigorous action in Italy, was also attributed by contemporary suspicion to the wily suggestions of the Neapolitan king. Worst of all, France would not take action. A few hundred French lances would have been worth far more than the threat of a general council which the Pope knew would not be carried out. Florence found herself isolated and exposed to a crushing attack. The plague broke out within the walls, Poggio Imperiale was stormed, and nothing but the ponderous tactics of a mercenary army saved the city from the necessity of an ignominious surrender.

Lorenzo de' Medici was in a very difficult position. In a sense the city was enduring these sufferings and risks on his behalf, and the loyalty of the citizens might give way under

an intolerable strain. He found a way out of the dilemma by an enterprise which his adherents and apologists have agreed to consider heroic. In December 1479 he set **Lorenzo goes out on an embassy to Naples.** The fate of Jacopo **to Naples.** Piccinino was sufficiently recent to convince people that it was dangerous to trust to the good faith of Ferrante, yet it is difficult to believe that Lorenzo undertook the journey without some assurance that there was less risk in it than appeared on the surface. After all, Ferrante had originally been the cordial friend of Lorenzo; and although he had since then taken offence, he might be appeased by a renewal of the old understanding. Events had proved that it was not worth while to alienate Naples in order to establish better relations with Venice, and Lorenzo was quite willing to do penance for his blunder. And the alliance between Naples and the Pope did not rest upon very substantial foundations. Lorenzo could point out that Sixtus only cared for the aggrandisement of his nephew, that he was already preparing to expel the Ordelaffi from Forli in order to give a duchy to Girolamo, and that a strong secular power in the papal states was by no means likely to benefit Naples. There was an ultimate argument in the relations of the Medici with France. The revival of the Angevin claim was a perpetual nightmare to Ferrante and his son, and it might well prove that the house of Aragon would find in a Florentine alliance a substantial bulwark to their throne.

At all events, whether hazardous or not, the enterprise was successful. Lorenzo returned to Florence in 1480 **Conclusion of with a treaty of peace.** It was not, of course, a **peace, 1480.** very glorious agreement: the southern districts of Florentine territory were ceded to Siena, the allies in Romagna were left at the mercy of the Pope, and there was no provision for the restoration of the fortress of Sarzana, which had been seized during the war by the Fregosi of Genoa. But anything was better than the continuance of the war, and Lorenzo was hailed as the saviour of the state. It is true that there was a

momentary reaction, when it was found that the Neapolitan forces were in no hurry to quit Tuscany, and that Alfonso was apparently taking advantage of party feuds in Siena to maintain a permanent foothold in the province. But the Turks intervened to checkmate any such design, and the occupation of Otranto compelled Alfonso and his troops to retire for the defence of their own territory. Even the obstinate Pope was forced to give way by the danger from the infidel. Sixtus ceased to insist that Lorenzo should make another more humiliating, and perhaps more perilous journey to Rome, and withdrew the interdict which he had launched against Florence for venturing to punish ecclesiastics for a flagrant crime.

The conspirators had failed, and foreign enemies had failed, to overthrow the Medici, and their failure necessarily strengthened the dynasty against which these strenuous attacks had been directed. In 1480 Lorenzo was able to carry through vital changes in the constitution which for the rest of his life secured his authority against serious attack. It is noteworthy that no use was made of the parliament, as on previous occasions, when revolutionary decrees had to be enacted. The proposals were made by the signoria and carried in the ordinary way through the three councils. A constituent body of thirty was nominated by the signory. These were to appoint a 'greater council' of two hundred and ten members, afterwards enlarged to two hundred and fifty-eight, who were to act as a temporary *balia*, having power to legislate and to control the filling of the bags with the names of suitable candidates for office. In order to secure a wide distribution of influence, no family, except two specially named, was to have more than three members on the council. By a far more important provision the thirty were to nominate another forty, and with them were to constitute a permanent Council or Senate, known as the Seventy. The Seventy held office for life, and filled vacancies by co-optation. From among them were to be

Constitutional
changes in
1480.

chosen the two important executive committees—the *Otto di Pratica*, who took the place of the occasional committees of eight or ten whom it had been usual to appoint in time of war, and the *Otto di Balìa*, who superintended the police of the city. The institution of the Seventy did not abolish any of the old magistracies and councils; these still continued as a means of rewarding supporters and flattering men's love of importance. But it placed side by side with them what Florence had not for a long time possessed, a permanent machinery of government, and thus supplied the stability, the want of which had been the chief cause which raised the Medici to their anomalous and ill-defined position in the state. It was inevitable that the Seventy, with its two standing committees, should gradually draw into its hands the real power which could never be effectually employed by officials who changed every two months.

The troubles of the last three years had taught Lorenzo a lesson which he never forgot. The prompt punishment which followed his youthful errors in statecraft had been Lorenzo's an invaluable training to him. For the next later years. twelve years the internal history of Florence is absolutely uneventful, a fact which is itself the best evidence of the capacity of its ruler. Freed from the fear of domestic opposition, Lorenzo could concentrate his attention on external affairs, and he became the foremost statesman in Italy. Reverting to the sound traditions which his grandfather had handed down, he maintained an alliance with Naples on the one side, and with Milan on the other, and was thus enabled to check the aggressive tendencies of Venice and the papacy, and at the same time to avert the danger of foreign intervention. In the war of Ferrara (1482-84) he was an active member of the coalition which saved the house of Este from annihilation, though he was chagrined that the interested defection of Ludovico Sforza enabled Venice not only to escape well-deserved punishment, but also to retain the polesina of Rovigo. In 1485 a more serious difficulty arose when the

Neapolitan rebels, backed up by Innocent VIII., endeavoured to revive the Angevin claims. Florence had no love for the house of Aragon, and was closely connected by many ties with France. Fortunately, the appeal was made to René of Lorraine instead of to Charles VIII., and so Lorenzo could support the cause of Ferrante without any overt breach of the French alliance. And while engaged in these questions of high policy, Lorenzo never lost sight of the immediate interests of Florence. He took advantage of party feuds in Siena to procure the restoration of most of the territories which had been ceded in 1480. And he not only recovered Sarzana from Genoa, but he added to it the neighbouring fortresses of Pietrasanta and Sarzanella, thus giving to Florence a strong frontier on the ridge of the Apennines, which, if properly garrisoned, would have enabled the republic to check the invasion of Charles VIII.

In Lorenzo's last years a new and momentous political problem was created by the growing alienation between Naples and Milan. Ludovico Sforza could not carry out his designs upon his nephew's duchy without incurring the hostility of Ferrante and Alfonso; and upon Florence, as the middle state of the league, devolved the responsibility of mediating between her two allies. It was a task which required all Lorenzo's tact, experience, and patience, and it may be doubted whether even he could have ultimately succeeded in averting a collision. It is just possible, however, that consummate prudence on the part of Florence might have prevented French intervention in Italy, and in that case the whole course of European history might have been altered. But in 1492, when the fate of Italy was trembling in the balance, Lorenzo died; and his death at this critical moment must be ranked with those other events—the discovery of America, the conquest of Granada, and the election of Alexander VI.—which make 1492 one of the most memorable years in the history of Europe.

Importance of
Lorenzo's
death.

Enough has been said of the Florentine constitution to show that the power of the Medici did not rest upon very solid foundations. They had no military force behind them; none of the ordinary securities on which a despotism must rely for its permanence. They ruled, partly because they supplied an element of stability, which the civic constitution notoriously lacked, partly because they maintained the credit and the influence of the state in Italy and in Europe, but mainly because they had managed to conciliate the interests and the allegiance of a majority of the citizens. But if the Florentines once felt that their own interests and the security of the republic were endangered by the ascendancy of the Medici, that ascendancy must inevitably fall. And this was precisely the impression which Piero, Lorenzo's eldest son, set himself to produce. Discarding all pretence of civic equality, he indulged in the airs and pretensions of a prince born in the purple. And while his haughtiness disgusted the mass of the citizens, he made no effort to retain the support of the prominent families with whom his father had lived on familiar terms. But his most fatal blunder was in foreign relations. His mother was an Orsini, and his wife was an Orsini, and under the influence of his foreign relatives he abandoned the mediating position of Lorenzo, and allied himself unconditionally with the rulers of Naples. This action had a double result. It completed the exasperation of the Florentines, who had never loved the Neapolitan alliance even when their trust in the wisdom of Cosimo or Lorenzo had convinced them that it was to their interest to adhere to it. And it drove Ludovico Sforza into that desperate appeal to France which was the immediate cause of Charles VIII.'s invasion. When the French came, Piero showed himself to be pusillanimous as well as incompetent. He took no steps to hold the defensible passes of the Apennines against the invaders; and when they had reached Pisa, he sought to disarm their hostility by a more ruinous surrender than the most extreme

**Recklessness
of Piero de'
Medici.**

supporter of a French alliance would have advocated. The patience of the citizens was exhausted ; and Piero's flight was followed by the expulsion of his family and the restoration for a few troubled years of republican independence in Florence.

CHAPTER XV

BURGUNDIANS AND ARMAGNACS IN FRANCE, 1380-1435

Minority of Charles VI.—The princes of the lilies—Risings in Paris—Intervention in Flanders—Battle of Roosebek and death of Philip van Artevelde—Rule of the *Marmousets*—Insanity of Charles VI.—Rivalry for the government—Philip the Bold of Burgundy—Louis of Orleans—John the Fearless—Murder of Orleans—Outbreak of civil war—The *Cabochiens* in Paris—Victory of the Armagnacs in 1413—Henry V. invades France—Battle of Agincourt—Armagnacs retain their ascendancy in France—English successes in Normandy—Burgundians seize Paris—Murder of John the Fearless—Treaty of Troyes—War in Northern France—Deaths of Henry V. and Charles VI.—John of Bedford and Charles VII.—Divided allegiance of France—Humphrey of Gloucester and Jacqueline of Hainault—Quarrels at the court of Charles VII.—Philip the Good acquires territories in the Netherlands—Siege of Orleans—Successes of Jeanne Darc—Her capture and death—Character of the War—Quarrel of Bedford and Burgundy—Treaty of Arras and death of Bedford.

THE death of Charles V. in 1380 ushered in one of the most disastrous periods in the history of France. The young Charles VI. was only eleven years of age, and the government fell into the hands of his uncles, the dukes of Anjou, Berri, and Burgundy, and their brother-in-law, the duke of Bourbon. These men represented the new class of royal nobles, or princes of the lilies, and it was soon evident that their interests were those of their caste, and not those of the monarchy with which they were connected by blood. Their conduct was characterised by the same selfish love of independence as had been displayed by the older feudal nobles, whose lands had fallen to them by inheritance,

marriage, or royal grant. It was a momentous fact for France that the power of the crown was wielded just at this time by men who desired not to advance that power, but merely to abuse it for their own profit and that of their fellow-nobles.

Feudalism and its opponents. · Everywhere feudalism was fighting a final and desperate struggle to maintain itself against the forces which were destined to effect its overthrow.

In Germany the Swabian towns were engaged in war with the nobles, and the Swiss were preparing for the struggle in which they won their great victory of Sempach. In England social discontent was encouraged and organised by the teaching of Lollard priests, and the year 1381 witnessed the famous upheaval which is usually associated with the picturesque episode of the Kentish leader, Wat Tyler. In Flanders the citizens of Ghent were heading a rebellion against their count, Lewis de Mâle; and though the latter succeeded in detaching Bruges from the league of towns, he found the militia of Ghent more than a match for his feudal levies, and was compelled to appeal for assistance to his suzerain, the French king. It is important to remember that these movements were connected by more than the accident of occurring at the same time. News travelled more rapidly in the fourteenth century than it had done in earlier times, and a consciousness of common class interests was beginning to unite men of different countries, as common religious interests united them two centuries later. Events in Germany and England, and still more events in Flanders, influenced opinion and action in France. The burghers of Paris and other towns had not forgotten their temporary triumphs in 1356 and 1357, and in 1380 the general unrest in western Europe gave them a new stimulus to action just at a time when the change of government made their grievances more intolerable.

Even under Charles v. the burden of taxation had excited **Risings in Paris.** indignant murmuring, and on his deathbed the wise king had promised that the recent imposts on the sale of commodities should be abolished. But Charles's

brothers needed money for their own purposes ; and the eldest, Louis of Anjou, was so greedy, that he stole the crown jewels and the treasure which Charles had amassed for his son. An order was issued that the taxes should be collected in spite of the promised relief. Paris rose in revolt, and an ordinance was extorted from the terrified regents that all taxes imposed since the reign of Philip iv. should be withdrawn. Peace was purchased for a year by this concession ; but at the beginning of 1382, while the regents were engaged in suppressing a rising in Rouen, an attempt was again made to collect the tax on sales. The mob rose in arms, and their most common weapon gave them the name of *Mailloins*, or the hammerers. The streets were barricaded, and again the government yielded. In May 1382 an amnesty was promised to the rebels, who showed their gratitude by a civic gift of a hundred thousand francs.

This treaty was the last act of the duke of Anjou, who had hitherto been the guiding spirit in the regency. His one aim had been to collect funds for an expedition to Italy, and in this year he set out for Naples to enforce his claim against Charles of Durazzo (see p. 154). His departure left the chief power in the hands of Philip of Burgundy, who had bought off his elder and incapable brother, the duke of Berri, by handing over to him the wealthy province of Languedoc. Hitherto the French Government had refused to give any assistance to the count of Flanders, who was reduced to great straits by a victory of the Gantois outside the walls of Bruges (May 2, 1382). Philip van Artevelde, the son of Jacob van Artevelde, was now more powerful than his father had ever been. He was not only supreme in Ghent, but he claimed to be *ruwaert* or regent of the whole of Flanders. After his victory he proceeded to lay siege to Oudenarde, the last stronghold of the court and the Flemish nobles. If the town were allowed to fall, the triumph of the burghers would be complete. There was sufficient evidence of intercourse between Ghent and Paris

to excite the misgivings of a French ruler, and, moreover, the duke of Burgundy had a strong personal interest of his own in the matter. He was the son-in-law, and his wife was the heiress of Lewis de Mâle. It was imperative that he should strike a blow on behalf of an authority that might before long be his own, and the French nobles were eager to suppress a civic revolt which set such a bad example to their own vassals. A large feudal force was collected to advance to the relief of Oudenarde, and the young king himself, who was keenly interested in military affairs, accompanied the army in person. Filled with the confidence inspired by their recent victory, the Flemings **Battle of** **Roosebek.** quitted their strong position and advanced to attack a stronger and better-armed force than their own. On the field of Roosebek they were enveloped by the converging wings of the French army, and were almost annihilated. The corpse of Philip van Artevelde was found at the bottom of a heap of the slain. A prompt advance must have resulted in the capture of Ghent, but the French were satisfied with their success, and soon afterwards withdrew. The chief sufferers were not the defeated Flemings, but the *Maillotins* of Paris. The victorious army was irresistible on its return. Most of the leaders of the recent rebellion suffered death. The gates of the city were thrown down, and its municipal liberties were abolished.

With the suppression of the bourgeoisie all opposition to the regents seemed to be at an end. But in 1388 occurred a dramatic revolution which is a strange parallel to contemporary events in England. Charles vi. declared **Rule of the** **Marmousets.** himself to be of age, dismissed his uncles to their estates, and intrusted the Government to men who had been trained in the service of his father. For the next four years these *Marmousets* or parvenus, as the nobles scornfully called them, ruled with equal capacity and moderation. Suddenly, in 1392, came another extraordinary change in the course of events. One of the ablest of the royal

ministers was the Constable, Olivier de Clisson, a follower and fellow-countryman of Bertrand du Gueslin. An attempt was made to assassinate him in the streets of Paris, and the would-be murderers sought refuge with the duke of Brittany, who had a quarrel of his own with the Constable. Charles vi. was furious, and led an army towards Brittany to exact vengeance. But his health was already undermined by precocious debauchery and the premature possession of power. On the journey he became so violently insane that he had to be kept in forcible restraint. He lived for thirty years after this, but never recovered the complete control of his faculties, though he had intervals of comparative lucidity. As a rule he was worst in the hot weather of summer and autumn, and recovered to some extent in the colder months of winter and early spring. It would probably have been better for France if his insanity had been complete and permanent, as in that case it would have been necessary to make regular provision for the regency. As it was, the government was still carried on in the king's name; but it was notorious that even when he was at his best he had lost all strength of will, and was the obedient slave of whoever had control of his person at the time. These conditions led to that struggle for the exercise of power which brought such innumerable woes to France in the next half century.

The duke of Burgundy was with the king at the time of the seizure, and took prompt advantage of it to recover the authority which he had been compelled to relinquish four years before. By so doing he excited the bitter animosity of Louis of Orleans, the king's younger brother, who clamoured that he was ousted from his proper position by his uncle. From this rivalry arose in the course of time the famous factions of Burgundians and Armagnacs, whose quarrels distracted France and rendered the country an easy prey to the foreign invaders. It would be useless and wearisome to trace in detail the frequent fluctuations of

Insanity of
Charles VI.

Origin of
party feuds.

success and failure, but it is important to form a clear idea of the position of the two antagonists, and of the interests which became involved in their disputes.

Philip the Bold or the Rash (*le Hardi*) was the youngest and favourite son of King John, and had been taken prisoner with his father at Poitiers. To reward his bravery and devotion John gave him the duchy of Burgundy when it fell in to the Crown in 1361 on the death of Philip de Rouvre. But the greatness of the house was mainly due to a lucky marriage. Charles v. procured for his brother the hand of Margaret, the only child of Lewis de Mâle, count of Flanders, Artois, Nevers, Rethel, and Burgundy. When Lewis died, in 1383, these territories came through his wife to Philip, who became at once one of the wealthiest and most powerful princes in Europe. The object of Charles v. in promoting this marriage had been to connect these fiefs, and especially Flanders, more closely with France. The ultimate result was precisely the reverse; the connection of Burgundy with France was weakened. Commercial interests tended to sever Flanders from France and to attach it to England (see p. 71). These interests proved stronger than feudal and family ties. Instead of Flanders following Burgundy, Burgundy followed Flanders. Thus, although the duke of Burgundy was the first peer of France, and as count of Flanders was doubly a peer, yet he found himself more and more detached from France, and impelled to play the part of a foreign and independent prince. It is important to remember that part of Flanders and Franche Comté, or the county of Burgundy, were imperial fiefs, and had no legal connection with France. As time went on this non-French element in the position of the house of Burgundy was destined to be greatly extended. In 1385 an important double marriage was concluded with the Wittelsbach count of Holland, Hainault, and Zealand, the son of Lewis the Bavarian (see p. 108). The son of Count Albert, afterwards William VI. (1404-1417), was to marry Philip's

daughter, Margaret ; while Philip's eldest son, John of Nevers, was to marry Albert's daughter, another Margaret. It was to strengthen this alliance, which two generations later brought these Wittelsbach possessions to the house of Burgundy, that Philip negotiated the marriage of Charles VI. to a princess of another branch of the Wittelsbach house, Isabel of Bavaria—a marriage that was fraught with anything but blessing to France. Another imperial fief, Brabant, which was held by the aunt of Philip's wife, passed in 1406 to his second son, Antony, and ultimately to the main Burgundian branch. This gradual absorption of adjacent provinces by the Valois dukes gave to what came to be known as the Netherlands, or the Low Countries, their first semblance of political unity.

The young Louis of Orleans was, in territorial power and prospects, quite insignificant by the side of his uncle and rival. His great ambition was to redress this obvious inequality. At every opportunity he induced his brother to alienate domain-lands to him in spite of the protests of the *Marmousets*. By these grants and by purchase he obtained the duchy of Orleans, which Charles v. had promised should never be severed from the Crown, Perigord, a part of Angoumois, and the counties of Valois, Dreux, and Blois. His marriage in 1386 with Valentina Visconti, daughter of Gian Galeazzo, which gave to his descendants a claim upon Milan in later times, brought to him a million francs as dowry, but in the way of territory only the town of Asti in Lombardy, and the county of Vertus in Champagne. Louis even competed with his uncle for territories in the Netherlands, and in 1401 he agreed to purchase Luxemburg from Wenzel. But this proved a complete fiasco, and Luxemburg was ultimately absorbed in the Burgundian dominions. One discreditable advantage in the struggle was gained by the duke of Orleans. He became the paramour of the queen, Isabella of Bavaria, and by this means he not only secured her support, but also the

influence which she still retained over her unhappy husband.

Early in the fifteenth century changes took place in the personages of the drama, though its action was only slightly changed by them. Philip the Bold died in 1404, leaving three sons. The second son, Antony of Rethel, succeeded his great-aunt in the duchy of Brabant and Limburg, and married Elizabeth of Luxemburg, a grand-daughter of the Emperor Charles IV. The youngest son, Philip, received only the county of Nevers. With the exception of Nevers

and Rethel, the whole magnificent inheritance of Philip and Margaret passed to their eldest son, John, who also succeeded to the position of protagonist in the party strife in France. John had been taken prisoner by the Turks at the famous battle of Nicopolis (1396), and the reckless courage which he displayed on that occasion gained for him the name of the Fearless (Jean sans Peur). He displayed the same impulsiveness in politics as in the field, and this led him into criminal blunders, and ultimately to a violent death. Like all politicians of the time, he sought to use marriage as a means of strengthening his position. His eldest daughter was married to the duke of Guienne or dauphin, and the king's second son, John of Touraine, was betrothed to the daughter of his brother-in-law, William VI. of Holland.

In 1407 Louis of Orleans was assassinated in Paris; and after some hesitation, John the Fearless avowed himself to be the instigator of the murder, and put forward arguments to justify it. Instead of putting an end to the quarrel, this act proved the occasion for civil war. The sons of the duke of Orleans deemed it a sacred duty to avenge their father's death, and they were encouraged by the support of all opponents of Burgundy. As they were young and inexperienced, the practical leadership of the party was undertaken by Bernard of Armagnac, the father-in-law of the young Charles of Orleans, and himself the

son-in-law of the duke of Berri, the only surviving uncle of the king. From him the party derived the name by which it is usually known both to contemporaries and to history.

The strife of parties had its origin in a purely personal rivalry for power, but it gradually came to absorb all the elements of social, political, and ecclesiastical conflict in France. Louis of Orleans was the champion of the past, of feudal independence and privileges. His party, especially after his death, included most of the noble families of France. Louis had been the supporter of Richard II. against Henry IV., of Wenzel against his rival the Elector Palatine Rupert, of the Avignon popes against the policy of neutrality in the great schism. The Burgundians were forced to espouse the opposite side in these disputes. They clamoured for financial economy and encouraged the growth of municipal liberties. Flemish interests impelled them to maintain a good understanding with Henry IV. after his successful usurpation. In the matter of the schism they urged the 'way of cession,' and thus gained the support of the University of Paris. Orleans had alienated this powerful corporation by encouraging the rival schools of Orleans, Montpellier, and Toulouse. The University of Paris showed such devotion to the Burgundian cause that Jean Petit, one of the leaders of the Sorbonne, marshalled all the hackneyed arguments in favour of tyrannicide in order to justify the murder of Orleans. But this went too far for doctors of more tender conscience, and at Constance Jean Gerson, the chancellor of the University, pressed for the condemnation of Jean Petit's discourse, and thereby incurred the bitter enmity of John the Fearless (see p. 218). The great strength of the Burgundians lay in the enthusiastic support of the Parisians; the duke at once rewarded and conciliated their support by restoring in 1409 the municipal institutions which had been abolished in 1383.

The war has also a geographical as well as a social significance. The west and south were Armagnac, while the north

and east of France were Burgundian. This opposition was of long standing, and rested upon a substantial difference of race. In the south-west the strongest element of the population was the Romanised Celts; whereas in the north-east the Teutonic or Frankish race preponderated. For a long time, especially since the Albigensian crusades, the south had been reduced to subservience by the north, and in the Armagnac party it strove to shake off some of the fetters that had been imposed upon it.

In thus roughly estimating the significance of the civil strife in France, it is important to avoid being too precise and dogmatic. It was not so much a struggle of principles as a personal quarrel, in which certain principles became involved. It is to some extent misleading to speak of the Armagnacs as an aristocratic, and the Burgundians as a popular or bourgeois party. The parties did not set out with definite character and policy; but circumstances and momentary exigencies forced them to seek allies where they could, and these allies could only be gained by at least a professed devotion to their interests. The age also is full of contradictions, which make it the more difficult to draw definite distinctions. The dukes of Burgundy were the champions of municipal privilege in Paris; in Flanders it was their first business to restrict the independence of the cities. Philip the Bold declaimed against the extravagance of the government when he was excluded from it, and promised the people relief from taxation. But he was personally extravagant, his rule was at least as expensive as that of his opponents, and he died so profoundly in debt that his widow had to undergo a ceremonial proof of bankruptcy in order to secure the inheritance of her children from the disappointed creditors. Again, Louis of Orleans is apparently the champion of a reactionary feudalism; but in another aspect he is a disciple of the Renaissance, and a patron of the new learning that was to overthrow the essential ideas of mediæval feudalism. In this, as in other respects, he may be instructively compared

with an Englishman who was almost his contemporary, Humphrey of Gloucester.

It was fortunate for France that in the early stages of the quarrel little danger was to be feared from England. The minority of Richard II. was disturbed at first by the social discontent which led to the rising of 1381, and afterwards by party and personal jealousies which almost produced a great civil war. When Richard II. at last took the reins of government into his own hands and effected a temporary pacification, he began to prepare for his dramatic revenge upon his opponents, and for that attempt to establish a despotic power which resulted in his deposition. The result was that during his reign the war with France languished. Truces were frequently made and prolonged, and during the interval of nominal hostility no operations of importance were undertaken on either side. In 1396 Richard II. actually paid a visit to Paris, and was betrothed to Isabella, daughter of Charles VI. The revolution of 1399, which gave the English crown to Henry IV., seemed likely to bring about a resumption of hostilities, especially when Henry married the dowager duchess of Brittany, and thus renewed that connection with the house of Montfort which had in the past given the English an easy entry into France. But for some years Henry IV. sat but insecurely upon his throne, and the struggle against successive rebellions left him little time or inclination for an aggressive foreign policy. It was not until French parties were led by their irreconcilable enmity to each other to invite English intervention that the prolonged suspension of hostilities between the two countries came to an end.

The murder of the duke of Orleans exasperated, but at the same time intimidated the other princes of France, and their terror was increased by the punishment which the duke of Burgundy inflicted in 1408 upon the citizens of Liège for a revolt against their bishop. In spite of the pitiful entreaties of the widowed Valentina, John the Fearless was allowed to

retain supreme control of the government through his son-in-law the dauphin, who was now put forward to represent his father; and the young duke of Orleans and his brother had to undergo the shame of a formal reconciliation with their father's murderer. It was not till 1410 that the first league of princes was formed to overthrow the Burgundian ascendancy. It included the dukes of Berry and Bourbon, Louis II. of Anjou, the titular king of Sicily, the sons of Louis of Orleans, and the counts of Clermont, Alençon, and Armagnac. The duke of Brittany, who had previously been the ally of Burgundy, also joined the league because a daughter of John the Fearless had married the count of Penthièvre, on whom the claims of the rival house of Blois had devolved. It would take too long to trace the actual progress of the war or to enumerate the hollow truces and treaties by which it was occasionally interrupted. Neither party could claim any monopoly of patriotism, and both appealed successfully to England for assistance. In 1411 aid was sent to the Burgundians, and in the next year to their opponents. This was not due, as has often been asserted, to a politic desire to prolong the civil war in France, but was the result of a change of parties in England. In 1411, when the Burgundian alliance was concluded, the Prince of Wales and the Beauforts were in power. In January 1412 their influence was undermined by an obscure intrigue, Henry Beaufort resigned the chancellorship, and the Prince of Wales, who had incurred his father's displeasure, quitted the court. The government fell into the hands of Archbishop Arundel and Thomas of Clarence, Henry IV.'s second son, and they reversed the foreign policy of their predecessors. Clarence in person commanded the expedition, which was despatched to help the Armagnacs, but did little except ravage Normandy and part of Guienne.

The chief interest in the struggle lay in the efforts of the Armagnacs to get possession of Paris, the stronghold of Burgundian influence. In 1411 the princes advanced to besiege the city. The exigencies of the defence gave a

Civil war
breaks out
in 1410.

temporary ascendancy to the lower class of the citizens, who were the most enthusiastic partisans of Burgundy, and among them the lead was taken by the powerful guild of butchers. One Caboché, a flayer, acquired an unenviable eminence which gave to his associates the name of *Cabochiens*. For two years they were all-powerful in the city, and their history is marked by one of those extraordinary contrasts which are more familiar in the history of France than in any other country. On the one hand, their rule was disgraced by the brutal atrocities of a Paris mob at its worst. On the other hand, there must have been among their leaders men of virtue and capacity, who saw clearly the administrative evils under which France was suffering. On May 25, 1413, was issued the famous Cabochian ordinance, containing 258 articles, which has been warmly praised by more than one eminent historian as a wise and far-seeing measure of reform. But the authors of the ordinance hardly acted in its spirit, and it was so short-lived that it has no practical importance.

The Cabochiens in Paris.

The horrors of Cabochian rule excited a strong reaction among the higher class of citizens, and the Armagnacs were enabled by their aid to enter Paris. The great ordinance was revoked in September 1413, and all offices were transferred to members of the victorious faction. The dauphin, who had quarrelled with his father-in-law, joined his former opponents, and this enabled them to claim that they were governing in the king's name and interest. In 1414 the Armagnacs assumed the offensive, drove the duke of Burgundy from one town after another, and even invaded Artois. Before Arras a treaty was concluded which left Paris and the persons of the queen and the dauphin in the hands of the Armagnacs. John the Fearless, chagrined by his defeat, and excluded from all political influence, resumed those relations with the English to which he was impelled by Flemish interests. Henry v., who as Prince of Wales had shown himself disposed to aid

Armagnac victory in 1413.

the Burgundians in 1411, was now on the throne. He was free from some of the difficulties which had made his father pursue a peace policy, and the condition of France offered him an irresistible temptation to renew the war. In 1415 he formally announced his intention of asserting his claim to the crown of France, and laid siege to Harfleur. The Armagnacs were by no means dismayed by the news. The militant instincts of an aristocracy were strong among them, and a victory over the English invaders would complete their triumph over the Burgundians. A feudal army was hastily collected under the constable d'Albret, and the offers of aid from Paris and other communes were haughtily rejected. The expected success was to be for the party, not for the nation. But the military ability of the nobles was not equal to their exclusiveness. A slight exertion would have relieved Harfleur, but the town was allowed to surrender on September 22. This was a considerable gain to the English; for Harfleur, though less defensible than Calais, was far better suited for aggressive purposes. It was the real key to Normandy, whereas the strength of Calais lay in its isolation. But the English army had suffered heavily during the siege, and prudence seemed to dictate that it should either return to England or spend the winter in Harfleur.

Henry, however, trusting to the incapacity and disunion of his enemies, decided to lead his diminished army, not more than fifteen thousand at most, through a hostile country to Calais. The bridges on the Somme had been broken down, and the English made for the famous ford of Blanchetaque, where Edward III. had effected his crossing before the battle of Crecy. A prisoner declared that the ford was guarded by six thousand troops, and the English turned southwards to find another crossing. One place after another was found to be impracticable, and the army had passed Nesle before they discovered some marshy shallows which gave them the desired passage. They thus escaped the trap into which they

had fallen, but their march had brought them to the south of the French army, which in overwhelming numbers blocked the way to Calais. It was necessary to fight or perish. In the battle of Agincourt (October 25, 1415) the muddy state of the ground, the reckless insubordination of the French nobles, and the skill of the archers gave the English an extraordinarily easy victory. The losses on the French side were enormously increased by a massacre of the prisoners, which Henry ordered when the appearance of some camp-followers was taken as the approach of a new army. Among the slain were the constable d'Albret, the duke of Alençon, and the two brothers of John the Fearless, Antony of Brabant and Philip of Nevers. The duke himself had refused to join his opponents, and his brothers only arrived in time to share the defeat. The most important of the prisoners whose lives had been spared were the young Charles of Orleans and the count of Richemont, brother of the duke of Brittany. As far as Henry v. was concerned, he gained no immediate advantage in France, except the ability to continue his retreat. He hastened to Calais, and there embarked for England.

The Armagnacs had destined for themselves all the glory of the expected victory, and they had to endure all the shame of the defeat. The Parisians openly exulted at the humiliation of their oppressors, and prepared to welcome John the Fearless, who advanced as far as Lagni on his way to the capital. But the duke had lost much of the energy of his younger days. Bernard of Armagnac, who had played no part in recent events, hurried up from the south and took prompt measure to suppress the Burgundian sympathies of the citizens. He only arrived just in time. The dauphin, worn out by debauchery of every kind, died on December 18, and the heir of the throne was now John of Touraine, who was the creature of the Burgundian party. If John the Fearless had succeeded in reaching Paris, his hold on the government would have been secure. But

Continued
party strife
in France.

he had lost his opportunity, and retired after four months of absolute inactivity. His enemies called him in derision John of Lagni.

In 1416 there was no renewal of the English invasion, and the attention of Henry v. was fully occupied with diplomacy. Sigismund had quitted Constance with the professed intention of putting an end to the international quarrels which impeded the work of the council. But his visits to France and to England failed to effect the desired result. Their chief result was to ally Sigismund with Henry v. and to bring about a better understanding between the latter and the duke of Burgundy, who had found it difficult to maintain any alliance with England after the death of his two brothers at Agincourt. Meanwhile Armagnac continued a reign of terror in Paris. The citizens were disarmed, the chains and barriers in the streets were removed, and a strict system of espionage enabled the government to detect and punish any attempt to rebel. The atrocities of the *Cabochiens* were equalled by their opponents, and without the excuse that could be offered for the brutal action of a mob. The one difficulty in Armagnac's way was the fact that the dauphin John was in the hands of the duke of Burgundy at Valenciennes. But in April 1417 the dauphin died so opportunely that Armagnac was suspected of having brought it about. The only surviving prince, Charles, was the son-in-law of Louis II. of Anjou, and had been brought up in bitter hostility to the Burgundians. The one influence over him that might stand in the way of Armagnac was that of his mother. In a lucid interval Charles VI. was induced to notice and resent his wife's notorious misconduct, and Isabel of Bavaria was sent into disguised captivity at Tours. Indignant at this insult, she forgot the quarrel of a lifetime, sought the alliance of John the Fearless, and escaped from Tours with his aid. This encouraged the Burgundians to fresh exertions. The queen claimed to act as regent during her husband's 'occupation,' as it was euphemistically called.

At Amiens she and the duke of Burgundy established a council and a parliament in opposition to those in Paris, which were 'subjected to the usurpers of the royal power.' The civil war was carried on in a series of petty combats over the northern provinces, in which each side was equally discredited by acts of the grossest brutality.

The renewed outbreak of civil war encouraged Henry v. to enter Normandy again in 1417. Little resistance was offered to him, except at Caen, and a truce with the duke of Brittany gave him a secure hold upon north-western France. The rapid success of the foreign invasion gave rise to negotiations between the French factions, and a treaty was on the verge of conclusion in May 1418, when it was broken off by Armagnac and his brutal colleague, Tannegui du Châtel. This was more than the Parisians could endure; the gates were opened to admit a body of Burgundian cavalry, and the citizens rose with cries of 'Burgundy and peace.' Armagnac was discovered and slain, but the dauphin succeeded in escaping to Melun, where he was joined by Tannegui and other followers, who had made a bold but unsuccessful attempt to hold out in the Bastille. The revolution in Paris gave to the Burgundians the ascendancy in the north, but the dauphin continued to call himself lieutenant-general for his father, and set up a council and a parliament in Poitiers.

One result of the revolution was to impose the burden of national defence upon the duke of Burgundy. The Parisians, although Burgundian, had not ceased to be Frenchmen, and their clamour compelled the duke to take measures against the English. He escorted the insane king to take the oriflamme from St. Denis, and he established a camp at Beauvais. But he did nothing to relieve Rouen, which was offering a heroic resistance to Henry v., and the town was forced to capitulate on January 19, 1419. A systematic government was set up in Normandy as a dependency of the English crown.

The news of the fall of Rouen roused the national spirit of France. The two parliaments of Paris and Poitiers combined to demand internal peace in the face of the foreign foe. On May 14 a truce for three months was concluded. But the English successes continued, and the capture of Pontoise enabled them to threaten Paris. The pressure of imminent danger forced the rival factions into closer relations with each other, and it was agreed that a meeting should take place between the dauphin and John the Fearless for the final settlement of all differences. This was a great blow to the extreme Armagnacs, who dreaded the loss of power and the vengeance of Burgundy.

Negotiations between the factions. Tannegui du Châtel and his associates determined by a desperate act to put an end to all prospects of pacification. The interview took place on September 10, 1419, on the bridge at Montereau, and John the Fearless was treacherously assassinated by the dauphin's followers. Whether Charles himself was aware of the plot beforehand is open to question, but by continued association with the murderers he made himself an accomplice after the event.

The murder of John the Fearless was a fatal event for France. It revived the unity of the Burgundian party, which had been rapidly breaking up, and for the moment it subordinated all sentiment of nationality to the desire for revenge. The young duke Philip vowed that the dauphin, whom he regarded as his father's assassin, should never sit upon the throne of France. Isabel of Bavaria, who had never loved her youngest son, did not scruple to join the duke in a close alliance with the English. The treaty of Troyes (May 21, 1420) excluded the dauphin from the succession, arranged that Henry v. should marry Katharine of France, that he and his descendants should be the heirs of Charles vi., and that Henry should be regent during the lifetime of his father-in-law. Normandy and all other English conquests were to be reunited to the French crown on Henry's

accession, and he swore to observe the laws and customs of France. Paris, already dominated by Burgundian partisans, and exposed to the danger of English attack from Pontoise, could make no resistance to an arrangement which proposed to subject France to an English dynasty.

The treaty of Troyes was a treaty with one of the factions in France; it was not a treaty with the French nation. In order to carry it out it was necessary to enforce the submission of the Armagnacs, who had the support of almost all the provinces south of the Loire, and also held a number of strong places north of that river. The reduction of the latter was the first task of the English and Burgundians. Some of them surrendered readily, but Melun held out for four months, and with its fall the campaign of 1420 ended. Henry v. returned to England, but was recalled by the news of a serious reverse. Thomas of Clarence, who had been left in command, was defeated and slain by a combined force of French and Scots at Baugé in Anjou (March 23, 1421), and a rising in favour of the dauphin took place in Picardy. Henry's return restored victory to the English arms. While Philip of Burgundy put down the malcontents in Picardy, the English laid siege to Meaux, the chief Armagnac stronghold in northern France. With its surrender (March 22, 1422) the supremacy of the allies to the north of the Loire seemed to be assured. A few adventurers, at the head of mercenary forces, remained to pillage the country, but there was no longer any centre of organised resistance to the English. Their army was preparing to cross the river when it was recalled by the news that Henry v. had died of dysentery, at the early age of thirty-four (August 31, 1422). Seven weeks later, the unfortunate Charles vi. was also carried to the grave, accompanied by the tears of his subjects, who remembered that if he had never ruled, so he had never oppressed them. None of his own family were present at the funeral, and the only mourner of princely rank was the

War in
northern
France.

Deaths of
Henry V. and
Charles VI.

Duke of Bedford, now regent of France for the infant Henry VI., who was solemnly proclaimed King of France and England.

For several years after 1422 there were two kings of France—Henry VI., represented by his uncle Bedford, with Paris as his capital; and Charles VII., a youth of twenty years of age, at Bourges. The position of the latter had been completely changed by the treaty of Troyes. He was no longer the mere head of an unscrupulous and discredited faction, but the leader of a national cause. This washed out the stain of the murder of Montereau. There was hardly a French nation as yet, otherwise Henry V. had never conquered Normandy, but there was certainly a sentiment of nationality. A duke of Burgundy, half of whose possessions lay outside France, might be comparatively free from such a sentiment, but his French subjects were not. From the very first the result of the struggle was certain. All the permanent influences were in favour of Charles and against England. Only two things were necessary to secure the victory of Charles VII.—the national sentiment must be kindled into a blaze, which was done by Jeanne Darc, and Burgundy must be detached from England. This was sooner or later inevitable, both from the natural jarring of interests and from the pressure brought to bear upon the duke by his own followers. Henry VI. wore the crown of France, partly by virtue of the Burgundian alliance, and partly because the feeling of national union had been overpowered for a time by domestic feuds and by the misery which they had brought to the country. Directly this double basis collapsed, the English power fell. That it lasted as long as it did was due to the difference between the respective leaders. John of Bedford was a great soldier and a great diplomatist; there was no one on the French side who equalled him in either capacity. Charles VII. may have had scant justice dealt to him by historians, and his latest biographer would have us believe that he was a model of kingly virtues. But these virtues,

such as they were, were developed by adversity. At the time when he assumed the royal title, he was too young to have much experience of government, his training had been against him, and he had been fatally compromised by the criminal violence of his associates. He was not personally a coward, but he disliked war, and he disliked publicity. Two important cities—Bourges and Poitiers—remained faithful to him, but he preferred the more congenial solitude of Loches and Chinon. He had excellent advisers. The council and parliament which he established at Poitiers comprised many of the ablest members of those institutions who had left Paris in 1418. So far as it was possible to conduct a civil government during the war, it was conducted well. But against these civilian advisers must be set the influence of brutal adventurers, such as Tannegui du Châtel, whose services he could not dispense with, and whom he was too feeble to restrain. Their gradual disappearance enabled him at last to free himself from the Armagnac party, and to render conspicuous services to France. But for the first seven years of his reign he had to contend with inferior instruments against superior force.

Geographically, France was fairly evenly divided. Paris, with the Ile de France, Normandy, Picardy, Champagne, and all the Burgundian fiefs, together with Division of Western Guienne and Gascony, recognised France. Henry vi. Maine and Anjou were a battleground between parties. Their duke, Louis iii., was absent in Italy, engaged in the effort to secure the succession in Naples. His mother—Yolande of Aragon—was the mother-in-law of Charles vii., and an influential personage at his court. Charles could count, in the first place, upon the provinces which he had held in fief before his father's death—Touraine, Dauphiné, Berri, and Poitou. Orleans, whose duke was still a prisoner in England, was loyal, and so were Auvergne, Lyons, Bourbon, Languedoc, and the eastern parts of Guienne and Gascony. The duke of Brittany was doubtful. He was intimately

connected with both parties. He had married Charles VII.'s sister, but he was the nephew through his mother of the first duke of Burgundy, and that mother had been the second wife of Henry IV. of England. His family was under great obligations to England, but his subjects were, for the most part, averse to the English alliance; and his brother—Arthur of Richemont—had been one of Henry V.'s prisoners at Agincourt. For the moment the attitude of John V. was decided by a foolish attempt on the part of the Armagnac leaders to excite a revolt in Brittany in favour of the count of Penthievre. This drove the duke, in 1423, to acknowledge Henry VI. and to make a treaty with the dukes of Bedford and Burgundy. At the same time, Bedford tried to strengthen the ties between Burgundy and England by marrying Philip's sister Anne. There were three provinces—Lorraine, Savoy, and Provence—which were not French, but for many years had been involved by their geography in French politics. Provence belonged to the duke of Anjou, and was certain, sooner or later, to support Charles VII. Amadeus VIII. of Savoy was the uncle of the duke of Burgundy, but held a neutral position, and tried to play the part of mediator. Charles of Lorraine had been an ardent Burgundian partisan, and had been appointed constable in 1418 by John the Fearless. But since then he had been gained over by Yolande, and induced to marry his only daughter to her second son, René.

The actual military operations were not, for some time, of first-rate importance. There was no campaign on a large scale, and only two battles which deserve mention.

1423-24- A few places in the north, notably Guise and Ivry, held out for Charles VII., and Picardy was always ready to revolt. Important assistance was rendered by Scotland, the permanent ally of France against England. Buchan, a Scot, was appointed constable of France, and the earl of Douglas, who brought a number of adventurers, was created count of Touraine. In 1423 a mixed French and Scottish army was

defeated by the English and Burgundians at Crevant. In 1424 a more important engagement took place. The English had laid siege to Ivry, and a great effort was made to relieve the garrison. Bedford in person met the relieving army at Verneuil, and inflicted a crushing defeat upon them. Douglas, Buchan, and a number of French nobles were slain; Maine was completely reduced, and the remaining fortresses in Picardy surrendered.

At this juncture Bedford's progress was arrested, and his whole design was threatened with ruin by the action of his brother, Humphrey of Gloucester, whose reckless selfishness nearly effected a complete rupture with Burgundy. The dearest aim of Philip the Good was to absorb the dominions in the Netherlands of the two collateral branches of his house.¹ Holland, Hainault, and Zealand had now passed, by the death of William vi., to his only daughter, Jacqueline. Another of Philip's uncles, Antony of Brabant, had left two sons, John iv. and Philip. The duke of Burgundy had contrived to unite these two lines into one by marrying Jacqueline to John iv. of Brabant. But the marriage was inharmonious, Jacqueline fled from her husband, and appealed for aid to the duke of Gloucester. Philip was infuriated when he learned that Gloucester had actually married Jacqueline, having obtained a dispensation from the old anti-pope, Benedict xiii. A prolonged and intricate quarrel followed. Gloucester claimed his wife's territories and defied Philip, who supported John of Brabant, to mortal combat. Bedford was in despair. He endeavoured to pacify Philip by ceding to him the Picard towns of Roye, Mondidier, and Péronne, and by allowing him to annex to Burgundy the counties of Auxerre and Macon. Fortunately, Gloucester was as changeable as he was rash and hot-tempered. He repudiated Jacqueline in order to marry Eleanor Cobham, and Philip the Good was free to settle matters with his cousin without being hampered by English

¹ See Appendix, Genealogical Table H.

intervention. But Gloucester continued to put difficulties in Bedford's way. He quarrelled so violently with his uncle, Henry Beaufort, that Bedford was compelled to return to England, where the task of peacemaker detained him from December 1425 till the spring of 1427.

Meanwhile Philip of Burgundy had been nearly impelled by the conduct of Gloucester to desert England and come to terms with Charles VII. One difficulty in the way was removed by the dismissal from the court of Tannegui du Châtel and the other accomplices of the assassination at Montereau. Philip had declared that he would never pardon the murderers of his father, and the negotiations with Burgundy enabled Yolande and the wiser advisers of Charles VII. to procure their expulsion. The office of constable was given to the count of Richemont, and this induced the duke of Brittany to acknowledge Charles. The latter could now claim to be no longer the champion of the Armagnacs, but a national king, and a reconciliation with Burgundy seemed to be the natural and inevitable result of the change. But the hopes of all patriotic Frenchmen were disappointed for a time by Charles's weakness of character. In his youth he was always under the thumb of a favourite, and the favourite at this moment was Pierre de Giac. Giac's wife had been the mistress of John the Fearless, and she had been employed to induce him, in spite of warnings, to keep his appointment at Montereau. With such a record behind him, it was natural that Giac should do all in his power to thwart the negotiations with Burgundy. Richemont, who had just returned to Bourges from an unsuccessful campaign in Normandy, was furious at the frustration of a project on which the salvation of France depended. The favourite was seized at night, condemned to a hasty trial, and drowned. A successor, who incurred the displeasure of the rugged constable, was assassinated. Charles VII. could not venture to punish those acts of violence, but he refused to pardon or trust their

Quarrels at
the court of
Charles VII.

instigator. As intimidation had failed, Richemont tried a new way to effect his object. He introduced a new favourite, George de la Tremouille, who proved the evil genius of the king and of France for the next six years. La Tremouille became all-powerful at court, but he turned against the patron to whom he owed his advancement. Richemont was banished from Bourges, and a small civil war broke out between his partisans and those of the favourite. The condition of France seemed more hopeless than ever. The reconciliation with Burgundy had failed; and, to make matters worse, the duke of Brittany, left unaided to oppose the English, had made terms with them at the end of 1427 and had become the vassal of Henry vi.

Meanwhile Bedford had succeeded, by persistent diplomacy, in removing the difficulties that stood in his way. Henry Beaufort was gratified by being allowed to receive the cardinal's hat, which Henry v. had forbidden, and was induced to leave England in order to head a crusade against the Hussites in Bohemia. The quarrel between Gloucester and Burgundy was terminated by the former's marriage, and by the death in 1427 of Jacqueline's lawful husband, John of Brabant, whose duchy passed to his younger brother. Philip the Good might not be a very devoted ally, but no opposition was to be expected from him as long as he was allowed to swallow the Netherlandish provinces at will. His war with Jacqueline continued until she undertook to acknowledge him as her heir in Holland, Hainault, and Zealand, and to grant him the immediate administration of these provinces as her main-bourg. Luxemburg was in the hands of Elizabeth, widow of Philip's uncle, Antony of Brabant. She was no relation by blood to the house of Burgundy, and there were members of her own family to whom the duchy ought to have passed, but Philip succeeded in the end in securing possession of Luxemburg. Namur he purchased from its count. The only provinces in the Netherlands which were free from Burgundian

Burgundian
aggrandisc-
ment in the
Netherlands.

domination were the duchy of Gelderland and some ecclesiastical principalities, of which the most important was the bishopric of Liége.

Burgundy being thus pacified, Bedford was encouraged by the mingled folly and misfortunes of his opponents to make new exertions in France. In 1428 he received reinforcements under the earl of Salisbury, and a regular campaign was planned instead of the petty local war of partisans that had been carried on for the last four years. It was determined to lay siege to Orleans, which was situated at the elbow of the Loire, and constituted the key to southern France. Its capture would involve the submission of Touraine, Berri, and Poitou, the very heart of Charles VII.'s kingdom. The importance of the siege was fully recognised, and desperate exertions were made both for the attack and the defence. The English forces were not numerous enough to form a complete blockade, but they gradually drew nearer and nearer, and their engineering works were regarded as the masterpieces of the age. The French attempted to cut off a large convoy of provisions, escorted by Sir John Fastolf, but they were defeated in the battle of the Herrings. This skirmish seemed likely to decide the fate of the city. The besieged sent envoys to Philip of Burgundy, offering to surrender to him if the English would withdraw. Philip was eager that the offer should be accepted, but Bedford replied that after having beaten the bushes he would not allow another to seize the birds. The duke was so indignant that he ordered his own troops to retire, and thus a second blow was struck at the Anglo-Burgundian alliance.

Meanwhile Charles VII., whose kingdom was at stake, was doing nothing. Tremouille would not allow him to arrange terms with the constable, and assistance from Scotland, which was urgently demanded, could not arrive in time to save Orleans. It was at this juncture that Jeanne Darc made her famous appearance at Chinon. It is impossible, in a concise narrative, to do

Appearance
of Jeanne
Darc.

justice to the extraordinarily dramatic episodes that followed in such rapid succession. All that can be attempted is to tell the story of the chief events in which Jeanne played her part, without endeavouring to discuss her claim to supernatural guidance, or to throw any new light upon her remarkable character and influence. Great efforts were made by the courtiers to exclude her from the royal presence; but the impression she had already made upon the common people, and the influence of Yolande of Aragon, at last brought about the desired meeting. She gained the confidence of the king by reassuring him about the legitimacy of his birth, a matter on which he entertained not unnatural doubts, though he had never communicated his misgivings to any one. After some delay, a force was raised with which she entered Orleans on April 29, 1429. On May 4 the attack upon the English positions was commenced, and on May 8 the siege was raised. Jeanne herself carried the great news to Charles VII. at Loches, and insisted that he should accompany her to Rheims for his coronation, which had never yet taken place. The indolent king and his courtiers were reluctant to undertake a long and hazardous march through a country which had long been held by the enemy, but the persistence of the victorious maid carried the day. To the astonishment of Europe, the French had suddenly become invincible. Jargeau was stormed, a large body of English under Talbot and Fastolf was routed at Patay (June 18), and one town after another opened its gates to the advancing army. In Troyes it was determined to make a stand, but at the first assault the citizens rose and compelled the garrison to surrender. On July 16 Rheims was entered, and on the next day the coronation took place with the accustomed formalities.

French
successes
in 1429.

The daring and success of the march to Rheims made a profound impression. Jeanne clamoured for an immediate advance upon Paris, and it is probable that if she had had her way the capital would have fallen. Bedford was

in despair. In Normandy the opponents of English rule were gaining ground, and the loyalty of the Parisians was doubtful. To obtain an army he had to conclude his famous agreement with Cardinal Beaufort, by which the troops which had been collected for the Hussite war were diverted, much to the indignation of Martin v., to make war upon Charles VII. In order to secure Paris, he had to appeal to the duke of Burgundy, and to purchase his continued support by the cession of Meaux and by the appointment of a Burgundian partisan to the office of captain of the city. Fortunately for the English regent, there was treachery and division in the royal camp. La Tremouille and his associates were eager to destroy the ascendancy which Jeanne was acquiring over the king. She was known to have advised him to come to terms with the constable and to free himself from evil advisers, and they felt that the triumph of France would be dearly purchased at the cost of their own overthrow. And although the younger leaders, such as Dunois, the bastard half-brother of the duke of Orleans, were devoted to the heroine, the older commanders were indignant at being controlled by a girl. Jeanne found that she had to contend with a regular conspiracy, of which Charles VII. himself, to his eternal shame, was a willing accomplice. Futile negotiations with Burgundy provided a pretext for a delay which enabled Bedford and Beaufort to bring up troops for the defence of Paris. But a rising in Normandy compelled Bedford to retire northwards, and Jeanne at last succeeded in inducing the royal forces to advance. Compiègne, Senlis, and Beauvais surrendered in rapid succession. From Beauvais, the bishop, Pierre Cauchon, was expelled as an English partisan, and he was destined to take a terrible revenge for the injury. But at St. Denis, Charles VII. refused to run any further risks, although his approach would probably have induced the Parisians to rise. Losing all patience, the maid attacked the fortifications with a volunteer force, but met with her first repulse. She returned to St. Denis

with the proposal to cross the Seine and attempt a new attack on the right bank. To her horrified amazement, the bridge had been destroyed by order of the royal council. Against such despicable treachery it was impossible to contend. Charles withdrew to the Loire and disbanded his army. Jeanne with difficulty obtained leave to attack some of the smaller places on the Loire, but after some successes she was driven back from La Charité, to the undisguised relief of the courtiers.

In spite of these bitter disappointments, the French cause had made immense strides in 1429. The attack on Orleans had been foiled, the greater part of Champagne and Brie had been recovered, and the dormant loyalty of the northern peoples had received a sudden stimulus. But these successes had also served to give new vigour to the alliance between Burgundy and England. Philip was no longer a loyal supporter of Henry VI., but he was not prepared to acquiesce in a triumph of Charles VII. that was obtained without his aid. Moreover, his greed for territory was by no means satisfied, and he knew that as the English got into difficulties the value of his aid would increase. Bedford was quite willing to pay the price, and offered the investiture of Champagne. It is true that the province was no longer in English hands, and that its acceptance imposed upon Philip the necessity of recovering it from the French. But Champagne was of superlative importance to the duke, because it would serve to unite his two chief possessions—Flanders and the duchy of Burgundy. He accepted the offer of the regent, and in 1430 the Burgundian troops once more took the field and laid siege to Compiègne. The news that one of her precious conquests was threatened, roused Jeanne from the inaction in which she had been kept against her will. Without authority from the king, she collected a small band of devoted followers, and threw herself into the besieged town. It was her last enterprise. A sortie which she headed was repulsed, and she was cut

off before she could regain the fortifications. She was taken prisoner by the followers of John of Luxemburg, a cadet of the house of St. Pol (May 24, 1430).

From the English point of view, the capture of Jeanne was insufficient. The impression she had made must be effaced, and she herself must be discredited as well as punished. A charge of heresy and witchcraft was equally suggested by the superstition of the age and by the extravagant claims to supernatural powers which Jeanne herself had put forward. It was natural for her enemies to hold that these powers came not from above, but from Satan. The university of Paris, which boasted itself the home of the highest learning of the time, gave the first cue for persecution. They demanded that she should be tried before the inquisition of faith, which had been established in France by Innocent III., but had since fallen into oblivion. But the university was not sufficiently under English dictation, and they had a more suitable instrument to hand. The bank of the Oise on which Jeanne had been captured was just within the bishopric of Beauvais; and Pierre Cauchon, an exile from his diocese, and ambitious of the archbishopric of Rouen, was at the beck and call of Bedford. He demanded the surrender of the prisoner to his jurisdiction, and undertook the necessary negotiations with John of Luxemburg and his suzerain. In ordinary times Philip the Good might have preferred to retain so valuable a prize; but his cousin, Philip of Brabant and Limburg, had just died, and he was anxious to secure the succession. The Nevers branch of his house had strong claims to a partition of the inheritance; and as Bedford's intervention might prove decisive, it was imperative to avoid any quarrel with the English. The bargain was quickly settled. John of Luxemburg carried his prisoner into Artois, resigned her to his suzerain, and left to the duke of Burgundy the disgrace of selling the champion of France to the foreigner. In November 1430 the shameful transaction

was completed. Into the details of the trial, with its arid scholasticism and its wanton brutality, it is unnecessary to enter. The presiding judge was the bishop of Beauvais, but he was guided throughout by Bedford and Cardinal Beaufort. A condemnation was from the first a foregone conclusion, and the martyr was burned in the old market-place of Rouen on May 28, 1431.

Meanwhile the war had been going on, and the allies had gained little by the capture of their most formidable opponent. Even Compiègne held out successfully through a six months' siege. An Anglo-Burgundian army was defeated in Champagne, and Philip was chagrined to see the prize on which he had confidently reckoned lost to him for ever. In Normandy the English gained some successes, but these were counterbalanced by the loss of Melun. In 1431 hostilities were resumed in Champagne, Picardy, Artois, and Burgundy. It would be tedious and useless to describe the innumerable skirmishes and sieges in which, as a rule, only insignificant forces took part. With the disappearance of Jeanne Darc all restraint upon the brutal instincts of the soldiers had been removed. Most of the leaders were mercenary adventurers who fought, not out of devotion to one side or the other, but because their followers could only be kept together by plunder. The atrocities committed by the French troops were the greatest obstacle to the success of Charles VII. The people were everywhere inclined to return to their allegiance, but they hesitated to trust their lives and property to such defenders. The war was complicated by an important dispute about the succession in Lorraine. On the death of Charles I. in 1431 the duchy was claimed by his son-in-law, René of Anjou, who was already duke of Bar. But he was opposed by Antony of Vaudemont, a nephew of the late duke, who maintained that Lorraine was a male fief. Charles VII. sent assistance to his brother-in-law, while Philip the Good espoused the cause of Vaudemont.

The Burgundians gained a complete victory in July 1431, when René was taken prisoner. But the Lorrainers were hostile to the count of Vaudemont, and in the end the dispute was compromised. René recovered his liberty, and his rival withdrew his claims to the duchy on condition that his son Frederick should marry René's daughter, Yolande.

Bedford was fully conscious that the English cause was steadily losing ground in France. He tried to stimulate the loyalty of the Parisians by bringing over the young Henry VI. to be crowned in Paris. It was his answer to the coronation ceremony of Rheims. But it failed to produce the desired result. The French were indignant that the chief part in the ceremony was taken by Cardinal Beaufort, and not by a native prelate. The common people complained that there was no remission of taxes and no release of prisoners. Even more serious was the growing alienation of Burgundy. In

Rupture between Bedford and Burgundy. 1432 occurred the death of Bedford's wife, Anne of Burgundy. She was popular with the Parisians, whereas the regent was not, and she had always been a mediator between her husband and her brother. To make matters worse, within five months Bedford found a new bride in the person of Jacquetta of Luxemburg, daughter of the count of St. Pol, and niece of the captor of Joan of Arc. She was a vassal of Burgundy, and Philip was indignant that she should make so important a marriage without his consent. Cardinal Beaufort made vain attempts to effect a reconciliation between the two dukes. They were induced to come to St. Omer, but the interview did not take place, and the personal quarrel was never healed.

Meanwhile important events were taking place at the court of Charles VII. The ill-feeling against the omnipotent favourite, La Tremouille, had been steadily growing, and the queen's mother, Yolande of Aragon, organised a conspiracy **Fall of La Tremouille.** for his overthrow. The conspirators acted in conjunction with the constable Richemont, who sent some of his trusty Bretons to aid them, but wisely

abstained from interfering in person. The plot was successful. La Tremouille was surprised in his bed, and was kept in close captivity till he had ceased to be formidable. The king was terrified when he heard the news, but was consoled when he learned that the dreaded Richemont was not present. It was not till 1434 that Charles consented to be reconciled to the constable, whose rough exterior and brusque measures against former favourites had outweighed his loyal services to the national cause. From this time a new era opened for France. The Royal Council was reformed under the guidance of Yolande, and room was found in it for some of those bourgeois ministers, to whom was due the later reorganisation of the kingdom. Even Charles himself began to show unwonted energy, a change which unsupported tradition has assigned to the influence of his mistress, Agnes Sorel. French historians are never tired of insisting that France owed its salvation in the fifteenth century to two women, the one a saint and the other a sinner.

The quarrel between Bedford and Burgundy and the suppression of feuds and jealousies at the court of Charles removed the most obvious difficulties which had hitherto impeded a reconciliation between the French king and Philip the Good. Treaty of Arras, 1435. Strenuous negotiations resulted in an agreement that a congress should meet at Arras in July 1435. The English were to be invited to accept reasonable terms, and if they refused Philip was to do all in his power to restore peace to the kingdom. The inevitable result of the congress was easy to foresee. Beaufort and the English envoys rejected the first French demand that Henry VI. should resign the crown of France, and quitted Arras. It only remained to arrange matters with Philip, who was in a position to dictate his own terms. It was the suzerain who sued for pardon and the vassal who granted it. The duke demanded and received the counties of Auxerre and Macon in perpetuity for himself and his heirs, the towns on the river Somme, which on certain conditions might be

redeemed by the French king, and the recognition of his claims to the county of Boulogne, which had been contested by the heirs of the late duchess of Berri. In addition, Philip was to be freed from all homage and subjection to Charles VII. during their common lifetime. If Charles died first, Philip was to do homage to his successor; but if Philip died first, his heir would become the vassal of Charles VII. On these exorbitant conditions Philip agreed to forget all past wrongs, *i.e.* the death of his father, to which Charles virtually pleaded guilty, and to enter into a defensive alliance against the English. The treaty, which put an end to the long feud between Burgundians and Armagnacs, was signed on September 21, 1435. A week earlier Bedford had died. He had lived long enough to witness the collapse of the foundation on which the edifice rested, to whose construction he had devoted all his abilities and exertions.

CHAPTER XVI

REVIVAL OF THE FRENCH MONARCHY, 1435-1494

English disasters and loss of Paris—Prolongation of war—France exhausted and demoralised—Necessity of reform—Ordinance of 1439—The *Praguerie*—Creation of a standing army—Peace party in England—Henry VI. marries Margaret of Anjou—Renewal of war—Conquest of Normandy and Guienne—Last years of Charles VII.—Accession of Louis XI.—His character and early actions—League of the Public Weal—Treaty of Conflans—Charles the Bold and Liège—Louis recovers Normandy—Interview at Péronne—Charles of France receives Guienne—Relations of France and Burgundy with England—Renewal of war between Louis and Charles—Death of the Duke of Guienne—Charles's acquisitions in Germany—Fate of St. Pol—War with the Swiss and death of Charles the Bold—Mary of Burgundy marries Maximilian—Treaty of Arras—Successes of Louis XI.—Regency of Anne of Beaujeu—Charles VIII. marries Anne of Brittany—Question of Naples.

THE death of Bedford and the treaty of Arras were events of decisive importance. The English power in northern France had rested upon the Burgundian alliance, which was now irretrievably lost. Philip, it is true, had not promised active aid to Charles VII., and probably intended to observe a profitable neutrality. But the English were too indignant at his desertion to allow this. They insulted his envoys, maltreated his subjects who were resident in England, and set themselves to inflict all the damage they could upon Flemish trade. The result was that not only was Philip forced into hostilities with his late allies, but the Flemish citizens, hitherto the strongest link between him and England, urged on the war and offered to take the whole burden of it upon themselves.

The rupture with Burgundy altered both the balance of military force and the sentiments of the population in the northern provinces. A rising took place in Normandy, and even Harfleur, the first conquest of Henry v., opened its gates to French troops. Many of the strong places in the Ile de France were held by Burgundian commanders, and they followed their duke's example in going over to Charles vii. In 1436 the constable Richemont was strong enough to attack Paris. The citizens had been partisans of Burgundy rather than of England; they had been alienated by recent measures of repression; and the French now commanded the water-ways by which the normal supplies of food reached the capital. The fear of famine impelled the citizens to a course which they were eager to adopt upon other grounds. One of the gates was opened to the constable, and the populace rose with shouts of 'Peace! The king and the duke of Burgundy!' The English garrison, after taking refuge in the Bastille, was allowed to depart upon honourable terms. The parliament and the other sovereign courts returned to their old abodes, and Paris became once more the capital of France.

The fall of Paris seemed to herald the immediate collapse of the English dominion in France. Yet the general expectation was disappointed, and the war went on for another seventeen years. A number of causes combined to retard the progress of the French arms. The assistance rendered by the duke of Burgundy proved far less efficient than had been anticipated. In the first heat of resentment at the treatment he received from the English, Philip vowed a striking revenge, and in 1436 he advanced with a large force to the siege of Calais. But his troops were mostly Flemings, who had never been very skilful in aggressive warfare, and had lost most of their military aptitudes during the comparative peace which they had enjoyed under Burgundian rule. The siege was abandoned in disorder even before the arrival of Gloucester with a relieving force.

Philip was deeply chagrined at this humiliating failure, and a quarrel with the commune of Bruges diverted his attention from the war and induced him in 1439 to conclude a truce for the Netherlands with the English. Even more serious than the loss of such a powerful ally was the exhaustion and demoralisation of France. For nearly thirty years the country had been the scene of a desolating war which combined the worst horrors of civil strife and foreign invasion, and added to them some evils which were peculiar to itself. The most efficient military force on the French side was furnished by the companies of adventurers which had been originally introduced by Armagnac. The employment of these men proved a curse to France. They recognised no authority except that of their own commanders, and their loyalty to them was only purchased by the plunder which they were allowed to extort with impartial greed from friend and foe. The horrible tortures which they inflicted in order to compel the hapless peasants to disclose their savings, are among the most revolting incidents of a period in which horrors are the rule rather than the exception. The significant name of *écorceurs* or flayers, applied to them by their victims, has become almost a technical term. The country was depopulated as well as despoiled, and the provinces in English occupation were the worst sufferers. Financial difficulties on both sides were a prominent cause of the prolongation of the war. Military operations on a large scale were impossible. So-called battles were mere skirmishes. A force of 2000 men was an army. Isolated leaders struck a blow here, or captured a town there, merely to keep their soldiers employed and to obtain booty, but not with the object of gaining any decisive advantage. To many of these leaders the termination of the war meant ruin and effacement, a result which they were by no means eager to hasten.

In order to equip France for the final effort that was needed to expel the foreign conqueror from her soil, it was

necessary to undertake those administrative reforms which constitute the real glory of the reign of Charles VII. Ministers of Charles is known in history by the name of '*le Charles VII. bien servi,*' and it is probably to the ministers rather than to the king that the credit of the internal progress of France is due. Richemont and Dunois carried out the arduous task of transforming the free companies into a disciplined force under royal control. The two brothers, Gaspard and Jean Bureau, improved the French artillery till it became the best in Europe, a pre-eminence which it retained for the rest of the century. But the most famous adviser of Charles was the merchant of Bourges, Jacques Cœur. He owed his influence to the great wealth which he acquired by trade with the Levant. Hitherto the cities of Italy and the Catalans had been without serious rivals in the Mediterranean. Jacques Cœur brought Marseilles into competition with Venice, Genoa, and Barcelona. His loans to the monarchy enabled Charles VII. to carry on the war when the exhaustion of the country made it almost impossible to fill the exchequer by means of taxation. Charles rewarded him with the office of *argentier*, or treasurer of the royal household. In this capacity he took an active part in reforming the financial administration, and especially in restoring the currency, which had been ruinously debased during the recent disorders.

By far the most important single measure of the reign was the *Ordonnance sur la Gendarmerie*, published by the States-Ordinance general at Orleans in 1439. The preamble re- of 1439. cites that it is made 'to remedy and put an end to the great excesses and robberies committed by the *gens de guerre*, who have long lived and do now live upon the people without order or justice.' In the future no one is to raise a company without royal licence, and all captains are to be nominated by the king, who is to fix the number and arms of their soldiers. Pillage is expressly forbidden, and jurisdiction over the troops is placed in the hands of

royal judges. For the payment of the troops an important financial innovation is made. The nobles are forbidden to impose a *taille* or tallage on their domain, and the *taille* is to be a national tax paid to the king. Thus Charles VII. received a revenue of 1,800,000 *livres*. There was nothing in the ordinance to make this tax permanent, or to give to the king any power of arbitrarily fixing the amount of the *taille*; but the permanence of the *taille* was held to be involved in the permanence of the military force which it was granted to support. And the successors of Charles VII. held that the right to levy the *taille* without consent gave them also the right to increase it without asking for any fresh grant. The acquiescence of the French people was due to the sufferings they had gone through. Worn out by the prolonged war and by the terrible exactions of the free companies, they were eager to strengthen the hands of the monarchy to which alone they could look for a restoration of peace and order. The absolute control of the national force and the national revenue, which the action of the States-general of Orleans allowed the crown to assume, enabled the monarchy to erect a despotism in France. Englishmen may hold that orderly government and national independence were dearly purchased by the sacrifice of all securities for constitutional liberty, but it is at least probable that if they had ever found themselves in such an evil plight they would have concluded the same bargain on the same terms.

But though the mass of the people were ready to welcome any addition to the royal power, the French nobles were sufficiently keen-sighted to perceive the dangers which it involved to their hereditary privileges. ^{The} ^{Praguerie.} The ordinance of 1439 expressly deprived them of three valued rights: the power of taxing their own domain, the maintenance of troops under their own authority, and the carrying on of private war, which was enumerated among the causes of disorder which must be suppressed by the

royal troops. It was necessary to strike at once before the monarchy became too strong. In 1440 a formidable conspiracy was formed under the leadership of the dukes of Bourbon and Alençon. Nearly all the great nobles of France were concerned in it, except the duke of Burgundy, who was occupied with his own affairs, and the two brothers-in-law of the king, René le Bon and Charles of Maine. Even Dunois allowed himself to be seduced from the royal cause by the desire to uphold the interests of his class. La Tremouille emerged from his obscurity to seize a last opportunity of injuring the country and overthrowing the hated constable. In the very forefront of the conspirators was the dauphin, Louis, who had quarrelled with his father on the ground that his mother was insulted by the ostentatious pomp of Agnes Sorel, and whose restless ambition demanded a share in the government. Like many another heir to a throne, Louis found himself as prince allied with a cause of which as king he became the strenuous opponent. The 'Praguerie,' as the rising was called, in allusion to the recent disturbances in Bohemia, seemed at first sight to be irresistible, especially as the captains of the companies joined in the movement. But the king showed unexpected energy and decision; the people rallied to his side, and the selfish coalition against national interests broke to pieces. Many of the leaders escaped punishment by betraying their associates, and Louis was banished to his province of Dauphiné.

The suppression of the Praguerie enabled the government to take the necessary steps for carrying out the ordinance of 1439. By 1445 fifteen companies had been created, each under a captain selected by the king. A company contained a hundred lances, and a lance implied six persons, viz., the man-at-arms, his page, three archers, and a *coutillier*, a soldier armed with a *coutil* or dagger worn at the side. Thus the total number of the *gens d'ordonnance*, as they were called, was nine

Creation of
a standing
army.

thousand. Each captain on appointment had to take the following oath: 'I promise and swear by God and Our Lady that I will maintain justice—that I will allow no pillage—that I will unsparingly punish all those under my charge who are guilty of such offence, and that I will make reparation for the injuries that come to my knowledge.' The *gens d'ordonnance* were a cavalry force, and three years later an ordinance of 1448 instituted a body of infantry, the *francs archiers*. Each parish was to equip at the common expense a single archer. During peace the cost of his maintenance was borne by the parish, but when he was on service he was to receive pay from the crown. They were called 'free' archers because they were exempt from the *taille* and other obligations. Besides these troops, the king had his Scottish Guard, which had grown up during the intimate connection with Scotland in the early years of the reign and received its final organisation in 1445. There was also an efficient body of artillerymen and engineers, the creation of the brothers Bureau. That these military reforms were admirably suited to their purpose is proved both by the complete cessation of complaints about military outrages, and by the extraordinarily rapid successes of the French troops when active hostilities were resumed.

While France was occupied with these reforms and with the ecclesiastical disputes connected with the Pragmatic Sanction of Bourges (see p. 237), England in her turn was becoming more and more involved in those internal dissensions which developed into the Wars of the Roses. The personal quarrel between Gloucester and Cardinal Beaufort proved the origin of a lasting party struggle. After the treaty of Arras, Beaufort and his supporters had seen clearly that the conquest of France was impossible and had urged the conclusion of peace as the only means of preserving a part of the provinces acquired by Henry v. and Bedford. On the other hand, Gloucester, backed by the unreasoning sentiment of the mob, had urged

Parties in
England.

the disgrace of surrender and the necessity of a dogged prosecution of the war. The strife of parties had materially contributed to relax the efforts of England in the languid warfare that went on from 1436 to 1444. In 1441 the peace party had secured the release of Charles of Orleans, who had been a prisoner since the battle of Agincourt and had found solace during his captivity in the composition of poems which have given him an honourable place in literary history. Three years later the Duke of Suffolk, who was gradually superseding the aged cardinal in the leadership of the party, succeeded in arranging a truce for twenty-two months and in negotiating a marriage between Henry VI. and Margaret of Anjou, a daughter of René le Bon and a niece of Charles VII.'s wife. The marriage was solemnised in 1445, but it was extremely unpopular in England. Not only did Margaret bring no dowry, but it was part of the bargain that Anjou and Maine should be handed over to her uncle, Charles of Maine. Anjou had never been thoroughly conquered, but Maine had long been in English hands and they still had a garrison in its capital, Le Mans. Dreading the outbreak of popular fury, Suffolk did all in his power to keep the agreement secret and to postpone its execution. But in 1448, after several prolongations of the truce, the patience of the French was exhausted, and a small force

**Renewal of
the war,
1449.** marched to Le Mans and compelled the withdrawal of the garrison and the evacuation of the whole province. The truce was now extended for another two years, but no permanent treaty could be arranged, and a renewal of hostilities was sooner or later inevitable. France had by this time completed the work of internal reorganisation, while England was hopelessly unprepared and distracted by factious disputes. Under these circumstances it was madness for England to provoke a quarrel. But Suffolk and the Beauforts were conscious that the surrender of Maine had alienated public opinion, and hoped by a display of vigour to disarm opposition.

The garrison of Le Mans had been quartered on the border of Normandy and Brittany. On March 24, 1449, while the truce was still in force, these troops attacked and took the Breton town of Fougères. The act was as ill-timed as it was treacherous. Not only did it give Charles VII. a pretext for renewing the war, but it alienated the young Francis I. of Brittany, who had hitherto maintained an attitude of friendly neutrality. The duke appealed for aid to his suzerain, and Charles VII. despatched his army to invade Normandy. The campaign was little more than a triumphal progress for the French troops. Within two months more than twenty towns were taken. When Rouen was besieged, the citizens rose and shut up the garrison in the citadel, where Edmund Beaufort, who commanded, had to surrender (October 19, 1449). By the end of the year the English had lost the whole of Normandy except a few places on the coast, which were all taken in the course of 1450. In England these sudden and unexpected reverses excited a storm of indignation. Adam de Moleyns, bishop of Chichester, was assassinated at Portsmouth. Suffolk was impeached, exiled by the king, and murdered at sea. The rising of Jack Cade was only a prominent symptom of the prevalent discontent. The duke of York came over from Ireland, and civil war was on the verge of breaking out. But domestic disturbances, however justified by previous misgovernment, were ill calculated to assist the defence of the French provinces. From Normandy the French turned their attention to Guienne, and the campaign in the south was as rapid and successful as that in the north. On August 26, 1451, Bayonne surrendered, and the English held nothing in France except Calais and the adjacent forts of Guines and Ham. It is true that the long commercial intercourse with England and the recollection of the lenity of English rule as compared with that of Charles VII. led to a rising in Bordeaux in 1452, and an English force under the veteran Talbot was sent to take

Conquest of
the English
provinces.

advantage of the opportunity. But Talbot was defeated and slain at the battle of Castillon (July 17, 1453), and Bordeaux was soon afterwards compelled to capitulate.

In spite of the glory reflected upon Charles VII. by the restoration of unity, independence, and comparative order to his kingdom, his later years were the reverse of happy. The gloomy suspicion which he had contracted in his troubled youth became a settled habit as he grew old. He shut himself up from the eyes of his subjects with the obscure mistresses who became his companions after the death of Agnes Sorel in 1450. To his loyal minister, Jacques Cœur, he showed the same cynical ingratitude as he had formerly displayed to Joan of Arc. There were plenty of courtiers who were jealous of the influence of the merchant whose wealth made the phrase 'rich as Jacques Cœur' almost a proverbial expression. All sorts of charges, ranging from malversation to the poisoning of Agnes Sorel, were trumped up to procure his ruin. His property was confiscated, and after a trial in which the evidence was ludicrously unconvincing, the sentence of death was commuted by royal clemency to perpetual imprisonment. From his prison he escaped to Italy, and was appointed by Nicolas V. commander of the papal galleys in the projected war against the Turks. But he died in 1456 before he had any opportunity of winning distinction in this novel capacity.

By far the greatest trouble of Charles VII. in the later part of his reign arose out of his quarrel with his elder son Louis. After the suppression of the Praguerie a temporary reconciliation took place, and the dauphin returned to court. But Charles was intensely suspicious of his son, and in 1446 the alleged discovery of a new conspiracy induced him to banish Louis once more to Dauphiné. From this time the quarrel became irreconcilable, and father and son never met again. For the next ten years Louis set himself to rule his appanage as if it were an independent princi-

pality. He erected a parliament of his own at Grenoble and a university at Valence. His court became the refuge of all malcontents against the royal government. To strengthen himself against his father he concluded a close alliance with the duke of Savoy, and married his daughter Charlotte. So notorious was the quarrel that the Pope and the kings of Aragon and Castile proffered their mediation, but in vain. At last, in 1456, Charles despatched Dammartin with an army to compel the submission of Dauphiné. Louis had no adequate military force of his own, his father-in-law declined to run the risk of assisting him, and he fled to Franche-Comté and threw himself upon the protection of the duke of Burgundy. Philip received him with great pomp in Brabant, and assigned to him a residence at Genappe, where he remained for the next five years.

Since the treaty of Arras and the futile siege of Calais, Philip the Good had taken little part in the affairs of France. He had allowed the Praguerie to be put down, and the English to be expelled from France, without stirring to the aid of either, although the aggrandisement of the French monarchy was obviously dangerous to himself. His absorbing interest during these years was the government and extension of the heterogeneous dominions which had come under his rule. The Flemish citizens found it difficult to defend their liberties against a ruler who could employ against them the resources of so many other provinces. A rising in Bruges in 1437 was suppressed with great severity. In 1448 a more serious rebellion broke out in Ghent, and the citizens appealed for aid to Charles VII. But the French king was prevented from interfering by the renewal of the English war, and the Gantois were left unaided to conduct a heroic resistance against overwhelming odds. It was not till 1453 that a crushing defeat at the battle of Gavre compelled them to submit, and even then the duke granted fairly moderate terms to such formidable opponents. This victory was followed by the acquisition of Luxemburg,

Relation:
with Bur-
gundy.

which Philip finally acquired on the death of his aunt Elizabeth, in opposition to the strong legal claims of Ladislas Postumus, whose mother was a daughter of the emperor Sigismund. In spite of the extent and wealth of his dominions, Philip was conscious of two serious elements of weakness. There was no social or political unity between the various provinces, which were held together only by subjection to a common ruler. And, geographically, they were split into two distinct units. Between the Netherlands and the two Burgundies lay the provinces of Champagne and Lorraine, over which the duke had no legal authority. He could not travel from his northern capital at Brussels to his southern residence at Dijon without having to pass through foreign and possibly hostile territories.

Charles VII. was fully conscious of the danger involved to the French monarchy in the erection of a practically independent state on the eastern and north-eastern frontiers of France. His suzerainty over the French fiefs of Philip was suspended during the latter's lifetime by the treaty of Arras, and even when it should be revived by his own death or that of the duke, it would be of little use against a vassal who was strong enough to defy his overlord. The most pressing danger was the occupation by Philip of the strongest places in Picardy, which brought him into dangerous proximity to Paris. Twice Charles endeavoured to exercise the power of redeeming the towns on the Somme which had been reserved in the treaty of Arras, but both times he had to put up with a rebuff. An open struggle between France and the Burgundian power was, sooner or later, inevitable, but Charles was too weary of warfare to allow it to break out during his reign. Even when the duke gave such an ostentatious welcome to the rebellious dauphin, the king refused to depart from his policy of peace. But he showed a grim sense of humour when he heard of the reception of his restless and ambitious son in Brussels. Philip, he said, 'is nourishing the fox who will one day devour his chickens.'

The dauphin was still at Genappe when the news reached him that his father had died on July 22, 1461. It was said that Charles was so terrified of being poisoned in his food that he starved himself to death; and it is quite possible that his suspicious timidity was a trait of insanity inherited from the unfortunate Charles VI. Louis lost no time in setting out to take possession of his kingdom, and he was accompanied by his Burgundian host and champion. At the coronation ceremony at Rheims, and in the formal entry into Paris, Philip played the most prominent part. It is true that, in accordance with the treaty of Arras, he did homage to the new king for his French fiefs, but under the circumstances the homage seemed almost ironical. In the eyes of the people the duke was the powerful patron and protector, while his nominal suzerain appeared as his grateful dependant. Louis was still looked upon as the leader of the Praguerie, as the rebel lord of Dauphiné, as the fugitive guest in the dominions of the duke of Burgundy; and his first acts seemed to accord with the principles which had guided his conduct in the past. He gave the duchy of Berri as an appanage to his younger brother Charles. To Philip's son and heir, Charles of Charolais, he granted the government of the all-important province of Normandy. The duke of Brittany received the government of the district between the Lower Seine and the Loire. The faithful servants of his father, such as Dunois and Dammartin, were dismissed, and the latter was imprisoned. The offices thus left vacant were conferred upon men who had supported the dauphin against the late king. It seemed as if the feudal nobles of France had at last found a king who would govern in their interests rather than in those of the crown. The history of the reign is the record of their bitter disappointment.

Louis XI. is perhaps the most familiar figure in the history of the fifteenth century. His character has been painted for all time by Philippe de Commines; and his portrait has been described for English readers by Sir Walter Scott. He is

the model prince of the new type, the astute pupil of that Italian statecraft which Machiavelli drew up in a systematic treatise. He was, according to Chastellain, 'the universal spider'; his intrigues formed a vast web with himself at the centre. No consideration of morality, pride, or mercy was allowed to interfere with the attainment of his ends. His industry was unceasing, and he had a wonderful insight into the weaker side of human nature. 'No one ever took more trouble to gain over a man who might do him either service or injury.' His one weakness was a caustic tongue, and he acknowledged that his indulgence of this unruly member frequently brought him into scrapes. He was naturally suspicious and mistrustful; he would listen to advice, but follow his own counsel; his ministers must be his tools; independence was treachery in his eyes. He forgot nothing, and forgave nothing, but he could dissimulate even his anger. His policy has been equally clearly portrayed for us. He was, in the words of Commines, 'the enemy of all great men, whose power might surpass his own, and he was naturally the friend of men of low estate.' But this phrase must not be misunderstood. Louis XI. did not depress the nobles in order to exalt the lower classes or to extend their liberty. Municipal independence was as hateful to him as aristocratic privilege. Everything was to be equally subject to the crown. The great achievement of his reign was the victory of centralisation over the tendencies to disintegration in France. Individual members of the bourgeois class were his favourite instruments; for the class itself he did nothing, except so far as the people were better off under a strong monarchy than under the rule of a selfish and divided noble caste.

Communes tells us that Louis XI. was 'the wisest king at recovering from a false step,' and at the beginning of his reign false steps were not infrequent. In the Louis' first measures. first consciousness of the authority which he had long coveted, he made many powerful enemies by his rest-

less activity, and did not stop to consider the danger to which their combined hostility might expose him. The vengeful spirit with which he began his reign soon gave way to the resolute purpose of increasing his power. Instead of conciliating the people by the expected remission of taxes, he imposed a new charge upon the sale of wines. To the great indignation of the clergy he annulled the Pragmatic Sanction of Bourges, which, for the last twenty-three years, had given a large measure of independence to the Gallican Church. Yet his strong sense of his own authority prevented him from restoring to the papacy its former powers, and ecclesiastical anarchy prevailed during the rest of his reign. The Roman Curia treated the Pragmatic Sanction as null and void, whereas the Parliament of Paris acted as if it were still in force, and the king regulated his conduct according to his varying need to conciliate either the papacy or his own subjects.

But the chief dissatisfaction with the rule of Louis was felt by the nobles. An edict which declared hunting to be a domain right of the crown, and prohibited private preserves as illegal, excited intense ill-Alienation of the nobles. feeling among men to whom the chase was not only the chief occupation of their lives, but also a badge of their rank. And the greater princes had special grievances. The duke of Bourbon was deprived of the government of Guienne which he had mis-used. With the duke of Brittany the king quarrelled on the old grounds as to the homage due for the duchy and the extent of the ducal rights to the revenue of vacant benefices. Francis II. opened negotiations with Edward IV., and tried to renew the Anglo-Burgundian alliance. On discovering these plans, Louis was compelled, in self-defence, to withdraw the government of Normandy from Charles of Charolais. At the same time, in order to render Charles's hostility impotent, and to strengthen the crown against the prince whose patronage he resented even while he had profited by it, Louis set himself to foment domestic disturbances at the court of Burgundy. During

his five years of exile he had established intimate relations with Philip the Good's favourite ministers, Antony of Croy and his brother John of Chimay. The growing ascendancy of these men and the suspicion that they were allied with and possibly in the pay of the French king, roused the animosity of Charles of Charolais, who quarrelled so fiercely with his father on the subject that he quitted Brussels and took up his residence in Holland. His absence enabled Louis, with the help of the Croy brothers, to induce Philip to allow the redemption of the Somme towns for the stipulated 400,000 crowns. Charles was more furious than ever at the curtailment of his inheritance and the strengthening of the French frontier at his expense. In 1464 events enabled him to turn the tables on his opponents. A report was spread that an emissary of Louis had plotted to kidnap Charles in Holland, and though there was probably no foundation for the story, it served to bring about a partial reconciliation between Philip and his son. Louis XI. sent an embassy to Brabant to denounce the untruth, and to demand the surrender of its author, but the Chancellor of France used such peremptory language that Philip's pride was roused, and not only was the demand refused, but the Croy favourites, who were identified with French interests, were disgraced and expelled from the court. Philip himself was now old and feeble, and allowed the reins of government to fall into the hands of his impetuous son, whom contemporaries and posterity have agreed to call Charles the Bold or the Rash. This was a serious defeat for the plans of Louis. Charles was more of an independent prince than a vassal of France, but in both capacities it was his interest to weaken the French monarchy by encouraging the feudal independence of the great nobles. The policy which he pursued for the next few years is clearly expressed in his own phrase: 'Instead of one king of France I would like to see six!'

In 1465 the adhesion of Burgundy emboldened the princes

of the lilies to take active measures against the monarchy. The most prominent organiser of the conspiracy was the duke of Bourbon, who acted as negotiator between the two most powerful associates, the duke of Brittany and Charles the Bold. The signal for concerted action was the flight to Brittany of Charles of Berri, a youth of nineteen, who was to take the part which Louis himself had played in the Praguerie. At the court of Francis were assembled Dunois and most of the other servants of Charles VII. whom Louis had too hastily dismissed. A sort of open letter or manifesto was drafted in the name of the duke of Berri and addressed to Philip of Burgundy. In it the confederates denounced the oppressive rule of Louis as injurious to the welfare of the people; and this profession of public spirit to cover private aims was sufficient to give them the name of the 'League of the Public Weal.' Louis had for some time been conscious of the approach of danger, and had sought to strengthen himself against it. The duke of Savoy was his brother-in-law, and the aid of Francesco Sforza was purchased by the cession of Genoa. This, however, ruined the Angevin cause in Naples, and John of Calabria, eager for vengeance, brought Italian and Swiss mercenaries to the aid of the league. In England, which could render more efficient aid than any other power, Louis' scheme met with failure. He had gained over Warwick, the apparently all-powerful king-maker, and hoped, with his help, to induce Edward IV. to form a marriage alliance with France. But Edward preferred the charms of Elizabeth Woodville, a niece of the count of St. Pol, who was marshalling the forces of Burgundy for an invasion of Picardy, and this marriage was a blow to the influence of Warwick and the interests of Louis. The king found himself almost isolated in France. His old province of Dauphiné was loyal to him, and his uncle, Charles of Maine, undertook to oppose the rebels on the border of Brittany. In Paris, too, he had conciliated the citizens, but most of the towns

The war of
the Public
Weal, 1465.

were passively waiting to see which side would prove the stronger. In these circumstances Louis felt that it would be dangerous to stake everything on the devotion of his capital, and instead of waiting to be attacked he determined to take the offensive. Some of the royal troops preferred to support their local overlords, but the great mass of them were loyal to the crown, and the possession of a trained and well-equipped force was the one advantage which the king possessed over his enemies who had to collect hasty levies from among their vassals. His first march was against the duke of Bourbon, as the most resolute and the most central of his opponents, and he had already made considerable progress when he was recalled by the news that Charles the Bold, at the head of his father's forces, was threatening Paris. Louis hoped to enter the capital without a contest, but chance or treachery brought the two armies so close together that a collision was inevitable. The battle of Montlhéry was a confused skirmish in which no military capacity was displayed on either side. The left wing of each army routed its immediate opponents, and thus neutralised each other's success. The Count of Charolais claimed the victory on the ground that his troops were left in occupation of the field, but he had suffered the greater losses, and the only tangible result was obtained by the king, who entered Paris two days later. Soon afterwards the arrival of Berri and Brittany from the north-west and of John of Calabria from the south-east gave the princes an apparently overwhelming superiority of numbers. But they were divided by mutual jealousies and by the selfishness of their several aims, and thus concerted action was rendered impossible. The urgent necessity of increasing his forces and of securing the valleys of the Seine, Marne, and Yonne, by which Paris was provisioned, compelled Louis to make an expedition to Normandy. By so doing he ran a very serious risk of losing Paris, but the citizens refused to listen to the specious offers of the princes, and the king returned with 12,000 troops

and a supply of provisions. Following the advice of Francesco Sforza, he sought to divide his opponents by separate negotiations. But there was one demand, that he should give the government of Normandy to Charles of Berri, which he persistently refused to grant. Not only was the province one of the largest and wealthiest of the kingdom, but in the hands of his brother it would serve to connect the two most powerful malcontents, Brittany and Burgundy, and the three together could reduce Paris to such straits that they would be able to dictate terms to the king. But while this difficulty proved a stumbling-block in the way of the negotiations, the news came that Rouen had been treacherously surrendered to his opponents. Louis at once decided that, the mischief being done, it was better to put an end to the present war and to trust to future opportunities for a chance of recovering his losses. In October the treaty was drawn up at Conflans and finally signed at St. Maur des Fossés. Treaty of Conflans. 'The public weal was changed into individual weal,' and no attempt was made to carry out the professions which the princes had put forward at the outset. The Pragmatic Sanction, with regard to which the king's conduct was most obviously indefensible, was not even mentioned. The most important provisions were the restoration of the Somme towns to Burgundy, with the provision that they should not be again redeemed till after the death of Charles and his immediate heir, and the cession of Normandy to Charles of Berri. But nearly every member of the league received some concession. The duke of Brittany was to have Montfort and Étampes, and his claims to sovereign rights, with regard to ecclesiastical revenues, were allowed. St. Pol was to be constable, John of Calabria was to have certain cessions in Lorraine and money for the maintenance of troops to support the Angevin cause, and the dispossessed officials of Charles VII. were to recover their places. The princes of the lilies seemed to have won a complete victory over the monarchy.

But Louis knew that he had only to bide his time. The very completeness of their success dissolved the bonds that held the confederates together. United they were irresistible, but if they could be severed from each other the king could hope to regain what he had lost. Even during the siege of Paris his shrewd eye had been keen to detect the nascent jealousies which were to give him the desired opportunity for revenge. Already his intrigues had provided an occupation for the forces of Burgundy. In the heart of the Netherlands lay the ecclesiastical principality of Liège, ruled by its bishop as a vassal of the empire. Annexation was impossible, and geography made complete independence equally out of the question. Liège was famous then as it is now for its iron manufactures, and the prosperous artisans, the most democratic community in mediæval Europe, were in constant revolt against episcopal rule. It was the policy of the Burgundian dukes to maintain a hold over the bishop by supporting him against his rebellious subjects, and the present bishop, Louis of Bourbon, was a dissolute youth wholly subservient to his uncle, Philip the Good, to whom he owed his mitre. On the other hand, the citizens looked for aid to France, which was the chief market for their produce. As soon as the war began, Louis had taken measures to organise a revolt in Liège, which broke out on the arrival of a false report that the Burgundian troops had been completely routed at Montlhéri. Dinant, the second town of the principality, incurred the special displeasure of Philip by hanging over the walls an effigy of Charles of Charolais with an inscription declaring him to be a bastard. Directly after the treaty of Conflans, Charles led his troops into Liège to put down disorder and to punish this insult. But the season was too far advanced for active operations, and after forcing upon Liège the 'piteous peace,' by which the cause of Dinant was abandoned and the liberties of the city curtailed, Charles dispersed his forces for the winter. In 1466 the invasion was renewed, and the aged

duke, Philip, accompanied the army in person to enjoy the luxury of revenge. Dinant was taken and razed to the ground, and the men of Liège, roused by the sufferings of their neighbours to a tardy breach of the recent treaty, were compelled to renew their submission, to pay a heavy fine, and to hand over fifty leading citizens as hostages for their good faith. In spite of these reverses they retained their obstinate antipathy to external control and their confident expectation of assistance from France. In 1467 Charles the Bold, who had become duke of Burgundy by his father's death on June 15, led what had now become an annual expedition for the attack on Liège. Under the walls of St. Tron an obstinate battle ended in a victory for the Burgundians. Liège might still have stood a siege, but the citizens, divided and cowed, agreed to capitulate. The walls were levelled to the ground, and the free constitution of the city was annulled. So impressive was Charles's success, that Ghent, which had won increased privileges by a rising on the occasion of his 'joyous entry,' hastened to appease him by a timely submission. It seemed for a moment that the champion of feudal independence in France might succeed in establishing despotic government within his own territories.

While Charles was engaged in his first campaign against Liège, Louis had seized the opportunity to recover the most serious of his losses. As soon as the treaty of Conflans had been concluded, the dukes of Berri and Brittany had set out together to take possession of Normandy. But the triumphant confederates quarrelled over the division of the spoil. The feeble Charles of Berri resented the patronage and pretensions of his ally, who claimed for his own subjects the most valuable places in the duchy. Louis took prompt advantage of the dispute. He concluded a treaty with the indignant Francis of Brittany at Caen, and despatched the royal troops to Rouen. The province was recovered as rapidly as it had been lost, and

Louis
recovers
Normandy.

the two dukes—'wise after the event'—made up their differences and set themselves in Brittany to devise means for regaining what they had forfeited by their own folly. They made urgent appeals for aid to Edward IV. of England and to Burgundy, and Louis was fully alive to the danger of such a coalition. He had two trump cards to play in the intricate negotiations which followed. In England he had gained over the earl of Warwick, and Warwick, though his influence was waning, and he was unable to prevent the marriage of Charles the Bold with Margaret of York, was yet strong enough to avert for a time any active intervention of England in opposition to France. And Louis, as we have seen, was able to hamper the action of Burgundy by stirring up disaffection in Liège. His supreme object was to keep Burgundy and Brittany apart, and he constantly offered to abandon the cause of the Liégeois if Charles would give him a free hand in dealing with the dukes of Brittany and Berri. But Charles the Bold was too astute to approve of so one-sided a bargain, and Louis was forced to adopt another ruse. In 1468 he bribed his brother and duke Francis to conclude a separate treaty, without consulting Burgundy, and then he promptly communicated the fact of their desertion to Charles. He was confident that Charles's indignation would impel him to punish them by a similar abandonment, and when his envoys failed to conduct the negotiations to a successful issue he determined to try his own powers of diplomacy.

The experienced politicians of Europe were astounded to hear that the French king had obtained an unconditional safe-conduct from his vassal, and had ventured with a wholly inadequate escort to run the risk of a personal interview at Péronne. But in his own self-confidence and his contempt for the ability of his rival, Louis had made another 'false step.' He had completely forgotten that his emissaries were at the moment engaged in rekindling the smouldering embers of rebellion in Liège. While he was still the duke's guest at Péronne, the news arrived that the

citizens had seized the bishop, and had barbarously murdered several members of the chapter. Charles was so furious that his more prudent advisers had great difficulty in dissuading him from laying violent hands upon his suzerain. Louis's father had been held responsible for the murder of a duke of Burgundy; and it might well have been that the duke's grandson would not shrink from the death of a king of France. Louis could only escape from his perilous position by agreeing to all the terms dictated by the host who was now his gaoler. He had to incur the ignominy of accompanying the Burgundian army in a fourth expedition against Liége, and to take part in the destruction of a city whose chief fault was a too implicit confidence in his own promises of support. If Charles had demanded the restoration of Normandy to the duke of Berri, Louis could hardly have refused. But the duke of Burgundy had not yet forgotten the action of Brittany earlier in the year, and he was more anxious to strengthen himself than to weaken the French king by renewing the old league against him. Instead of Normandy, he demanded the cession to the king's brother of Champagne and Brie. Isolated from Brittany, Charles of Berri could hardly fail to become the tool of Burgundy; and, in the hands of a submissive ally, these provinces would serve to connect the Netherlands with the original Burgundian possessions. Louis perforce consented; but before he escaped from the toils, his quick mind had already discovered a means of evading the danger. At his parting interview with Charles he put forward as a casual suggestion that his brother might decline the proffered appanage, and asked what he should do. Charles replied, without thought, that in that case he must leave the king to satisfy the duke. Louis took these hasty words as authority to make an independent bargain. No sooner was he safe within his own realm than he offered his brother the duchy of Guienne. Guienne was a far more wealthy and important province than Champagne, and in itself was a greater loss to the crown;

but, on the other hand, it was far removed from the two dangerous opponents of the crown—the dukes of Burgundy and Brittany—and Louis knew that his brother, by himself, was not likely to be formidable. The bribe was accepted, and thus the most important provision of the treaty of Péronne was never carried into effect.

The substitution of Guienne for Champagne freed Louis from the worst consequences of his ill-timed visit to Péronne, but it did little or nothing to remove the great standing difficulties in his way. Burgundy and Brittany were as powerful and as independent as ever. They could reckon on the support of all the feudal nobles in France who wished to limit the authority of the crown. Worst of all, they could call in the aid of the Yorkist king of England, who had recently proved his complete estrangement from France by giving his sister in marriage to Charles the Bold.

Relations of
France and
Burgundy
with Eng-
land.

It was obviously of immense importance to Louis to secure himself from danger on the side of England, and for the moment events seemed to favour his schemes. Warwick was now completely estranged from Edward iv., and Clarence, the latter's brother, had joined the king-maker and had married his elder daughter, Isabel Neville. But Edward was still too strong for his opponents, and in 1470 Warwick and Clarence had to seek refuge in France. Louis seized the opportunity to effect a reconciliation between his cousin, Margaret of Anjou, and the man who had done more than any other to ruin the Lancastrian cause. Warwick's second daughter, Anne, was married to the ill-fated Edward, titular prince of Wales, and the former champion of the Yorkists undertook to restore the house of Lancaster. Such an extraordinary and unexpected coalition effected an easy revolution in England. Henry vi. emerged from his prison to play, for a few more months, the part of king; and Edward iv. sought safety and assistance in the dominions of his brother-in-law. Charles the Bold found himself placed by these events in an awkward

dilemma. Descended through his mother from John of Gaunt, he had long posed as a supporter of the Lancastrian cause, and had sheltered at his court many of the leading nobles of that party. Recent events had forced him into an alliance with Edward iv., but it had been dictated by policy rather than by good-will. If the restoration of Henry vi. were permanent, Charles could hope to gain such support among the Lancastrian nobles as would secure him against the French proclivities of Warwick and Margaret of Anjou. On the other hand, Edward was his wife's brother; he was a refugee in the Burgundian province of Holland; to disown him would put an end to all hope of English assistance in the event of Edward recovering his crown. Charles escaped from the dilemma in a manner characteristic of the age. Publicly he protested his devotion to the house of Lancaster, but secretly he gave Edward sufficient assistance to enable him to return to England. The desertion of Clarence, who had no interest in restoring the Lancastrian dynasty, and the ill-concealed enmity with which the Lancastrian partisans continued to regard Warwick, gave Edward successive victories over the two sections of the hostile coalition. At Barnet, the Nevilles were crushed and Warwick slain (April 14, 1471), and three weeks later Margaret and her immediate followers met with a fatal reverse at Tewkesbury. The deaths of the prince of Wales and his father left the house of Lancaster almost extinct, except for a solitary scion of the illegitimate line of Beaufort, and the permanence of the Yorkist dynasty, with its numerous male representatives, seemed to be assured.

The decisive victory of Edward iv. was a blow to Louis xi., and it was the more serious because in 1470 he had become involved in new hostilities with Charles the Bold. This was in great measure due to the Count of St. Pol, who had been an influential personage at the French court ever since the war of the Public Weal. His position was in many ways an extraordinary one. For his

The Con-
stable
St. Pol.

hereditary estates he was a vassal of Charles the Bold, and the bulk of these estates lay in or near the province of Picardy, the very frontier where the rivalry between French and Burgundian interests was most acute. As Constable he was a servant of the French king and the chief commander of the standing forces of the crown. The incongruity of such a double relation had been clearly shown in recent events. In 1466 St. Pol had taken part as a Burgundian vassal in the campaign against Dinant and Liège. In the next year he had headed the French embassy which had suggested the abandonment of Liège by Louis as the price of Charles's severance from Brittany. The importance and the anomaly of the constable's position were both increased by his own marriage with Mary of Savoy, Louis XI.'s sister-in-law, and by the marriage of his niece, Elizabeth Woodville, to Edward IV. of England. It was the ambition of St. Pol to play the part of an independent potentate in the politics of Europe, and he conceived that the best way to do this was to prolong the strife between France and Burgundy. Not only did the war increase his power and importance as constable of France, but it also enabled him, through the position of his own estates, to hold a sort of balancing position between the two opponents. Both might hate and fear him, but it was in the highest degree unlikely that they would combine against him; and as both must bid for his support, it was in his power to make his own terms with either side as interest and policy should dictate.

Accordingly, in 1470, St. Pol persuaded Louis to strike a blow for the recovery of the Somme towns, and in the king's name he took possession of Amiens and St. Quentin. Charles the Bold was taken by surprise, and the want of a standing army always made it difficult for him to meet any sudden move on the part of the French king. He was naturally indignant that the blow should be dealt by one of his own vassals, and his anger was by no means diminished when he received a message from St. Pol

**Renewed
war between
France and
Burgundy.**

and his associates that they would desert to his side if he would marry his daughter Mary to Charles of Guienne. Charles had no desire to give up his daughter, whose hand was a valuable asset in his diplomacy, and he had no intention of submitting to coercion in the choice of a son-in-law. His obstinacy compelled the constable and the confederate nobles to remain outwardly loyal to the king, though their real aim was to reduce the duke to such straits that he must accept their terms. An attempt on the part of Charles to recover Amiens ended in failure, and the critical struggle in England led to a truce in April 1471, by which the captured towns were left in the king's hands. The Yorkist victory seemed likely to turn the balance in favour of Burgundy, but, fortunately for Louis, Edward iv. was resolutely hostile to the marriage project put forward by the French princes. It is true that a dauphin had been born in 1470, but he was a sickly child, and if he died the duke of Guienne would once more become heir to the throne, and the possible absorption of the vast Burgundian inheritance by the French monarchy would be ruinous to English interests and ambition. Sooner than allow such a union to be effected Edward would abandon Burgundy and join Louis. But Louis was discouraged by the failure of his English policy. He knew that he could not trust the loyalty of his instruments, and he preferred diplomacy to the renewal of a war in which there was little prospect of assured gain. So for six months he negotiated with Charles, offering to restore Amiens and St. Quentin and to abandon St. Pol to the vengeance of his injured suzerain, on condition that Charles would give up all connection with the dukes of Guienne and Brittany. At last, in the spring of 1472, Charles announced that he would accept the proffered terms. At the same time he privately assured the dukes that he only agreed to the treaty in order to recover his own possessions, and that he had no intention of deserting them.

But Louis was not so easily duped. He had received intelligence that his brother was hopelessly unwell, and he

adroitly postponed any final agreement until the news came that the duke of Guienne had died on May 24. Of course it was rumoured that so opportune an event must be due to contrivance rather than to chance, but Louis's gains were so substantial that he could afford to disregard a suspicion which had no real foundation. Guienne reverted to the crown, troops were despatched to invade Brittany, and the treaty on which so much time had been spent was repudiated. Charles was carried away by rage and disappointment. Although the truce was not yet expired he crossed the Somme to harry the territories of the French king. Nesle was taken and sacked with a brutality unusual even in fifteenth century France, and Charles advanced to the siege of Beauvais. But his military skill was not equal to his indignation, and after a prolonged attack he was compelled to retreat and to close the campaign by a truce in November, 1472. Curiously enough this proved more durable than many formal treaties of peace. The truce was renewed from time to time, and Charles and Louis never again met in open hostility.

The death of the duke of Guienne proved far more important than his life had been. A coalition of the princes of the lilies had nearly ruined the monarchy in 1465, and the energies of Louis had been taxed ever since to prevent its revived activity. That coalition was now wholly broken up. Charles the Bold was as hostile as ever to the French king, but he was compelled to adopt different means to overthrow his rival. Hitherto his primary concern had been with the affairs of France. He had appeared to the world as the powerful vassal who headed the forces of feudalism to depress the authority of his suzerain. Henceforth he turned his chief attention from his French to his German provinces, and sought to build up a rival kingdom along the valley of the Rhine, which might surpass France in wealth and power, and might even bring to its ruler the imperial crown. The danger

Death of
Charles of
Guienne.

Altered
policy of
Charles the
Bold, 1472.

to Louis was perhaps as great, but it was wholly different in character, and it required wholly different expedients to cope with it. That within France the monarchy had gained a decisive victory over the forces arrayed against it was recognised by two of the most subtle intellects of the time. Philippe de Commines, the born vassal and the intimate adviser of Charles the Bold, had already made the acquaintance of Louis XI. during the troubled days at Péronne. In the autumn of 1472 he deserted his suzerain to enter the service of the king, whose character and career he has described in the most important historical work of the century. His example was followed by Odet d'Aydie, lord of Lescun, who had hitherto been the trusted guide of Charles of Guienne and Francis of Brittany. The shrewd Gascon found no difficulty in gaining the favour of his new employer, and he was rewarded with the title of count of Comminges.

Already, before 1472, Charles the Bold had taken an important step in the direction of territorial aggrandisement in Germany. Alsace and the Breisgau, representing the original Swabian possessions of the house of Hapsburg, had been ruled since 1439 by Sigismund, son of that Frederick of Tyrol who had played a prominent part in the early stages of the Council of Constance (see p. 213). Like his ancestors, Sigismund had become involved in a quarrel with the members of the Swiss confederation, and by a treaty in 1468 he had pledged himself to pay to the League a considerable sum of money. Unable to raise the sum from his own resources, he had applied to Charles the Bold, who agreed to furnish the money if Alsace and the Breisgau were handed over to him as security. It was more than improbable that the penniless count of Tyrol would ever redeem the pledge, and Charles, treating the provinces as his own possession, intrusted the administration to Peter of Hagenbach. When, in 1472, the direct opposition to Louis XI. came to an end, Charles turned with avidity to that acquisition of lands in Germany which

Acquisitions
of Charles
the Bold in
Germany.

was to prove the cause of his ruin. Interfering as arbiter in a dispute between father and son in Gelderland, he seized the disputed duchy for himself (1473). In the same year occurred the death of Nicolas of Calabria, the grandson and last male descendant of the old René le Bon. The duchy of Lorraine now passed to another grandson, René of Vaudemont, who inherited both the Angevin and the Vaudemont claim. Lorraine was of peculiar importance to Charles the Bold, as it lay between his northern and his southern dominions. Although he had no legal claim to interfere, he seized the young duke and only released him on condition that he should cede four fortresses as a guarantee for the free passage of Burgundian forces through Lorraine. Meanwhile Charles was negotiating with the emperor Frederick III. to have his duchy of Burgundy erected into a kingdom, and he intended to claim all those territories which at one time or another had borne the name of Burgundy. Such a claim would have included Savoy, Provence, and several adjacent districts. The emperor was to be bribed by the proposal of a marriage between his son Maximilian and the heiress of these vast dominions present and prospective. An interview was arranged at Trier, and Charles brought with him the crown that was to be placed on his head. But Frederick III., always cautious and rather timid, was alarmed by the extravagant pretensions of the aspirant to royalty, and he was cognisant of a scheme to recover Alsace for his cousin Sigismund. So one night the emperor slipped away in a boat down the Moselle, leaving the duke the laughing-stock of Europe. But this humiliation failed to check Charles's ambition, and in 1474 he embarked on a new enterprise. The archbishop of Cologne, Robert of Bavaria, deposed by his chapter and his subjects, appealed for assistance to the duke of Burgundy, who seized the opportunity to gain on the middle Rhine a preponderance similar to that which he had acquired in the bishopric of Liège. With a large army Charles entered the territories of Cologne, as the champion

of the archbishop against his rebellious subjects, and laid siege to Neuss, a fortress on the Rhine held by the Landgrave of Hesse, whose brother had been appointed administrator of the diocese.

The siege of Neuss was one of the great blunders of Charles the Bold. He had never shown any skill in siege operations, and for a whole year his obstinacy kept him before a town which he was ultimately unable to reduce. During these months his enemies were able to attack with impunity the extremities of his dominions, and he lost a favourable opportunity of weakening his chief opponent Louis XI. Louis was frequently urged by his advisers to check the aggrandisement of the Burgundian duke by a renewal of direct hostilities. But he preferred the more subtle policy of allowing his rival to exhaust his strength in distant enterprises, while he secretly encouraged the resistance of the German princes and people whose interests were threatened by Charles's progress. Among the latter were the leading members of the Swiss Confederation. They had always quarrelled with the Hapsburgs in Alsace, and they were not likely to find a less formidable neighbour in the duke of Burgundy, whose expansion southwards could hardly be effected without destroying their independence. The oppressive rule of Peter of Hagenbach, Charles's bailiff in Alsace, was bitterly resented by all the cities and towns of Swabia, and Bern, now the leading canton of the Confederation, was prominent in demanding redress. Louis seized the opportunity to score a notable diplomatic victory. He induced Sigismund to demand the restoration of Alsace, and he set himself to reconcile the Swiss with their old opponent. On March 30, 1474, it was agreed by the Everlasting Compact that Sigismund should renounce all Hapsburg claims within the territory of the League, and that the confederates should support him in recovering the provinces which had been pledged to Charles. The chief

Louis XI.
stirs up
enemies
against
Charles the
Bold.

Swabian towns furnished the necessary money to redeem the pledge, and when Charles took no notice of the demand for restitution, Alsace was invaded and Hagenbach was put to death (May 9, 1474). After this there was good reason to dread the duke's enmity, and a strong party was formed within the League which contended that the safest method of defence was to anticipate attack. French gold was employed to aid and extend this party, which was headed by Nicolas von Diesbach of Bern, and the emperor Frederick III. was induced to use his authority to urge on a war with Burgundy. In October a treaty was concluded with France, and this was followed by a formal defiance of Charles and an invasion of Franche-Comté.

Charles received the news of these events before Neuss, but he refused to abandon the siege, and the only step which he took to protect his interests in the south was to conclude a close alliance with Yolande of France, the dowager-duchess and regent of Savoy. Yolande was the sister of Louis XI., but her policy was as independent and self-seeking as that of her brother, and she did not scruple to break off the intimate alliance between Savoy and France which had resulted in her own marriage and that of Louis. She even used her influence to detach her brother-in-law, Galeazzo Maria Sforza, from France, and to arrange an alliance between Milan and Burgundy. But the first result of her action was to extend the area of Swiss aggression, and in the spring of 1475 Granson, Morat, and other Savoyard territories fell into the hands of the confederates. About the same time René of Lorraine was induced by the French king to repudiate his recent treaty with Charles the Bold and to invade the duchy of Luxemburg. So formidable was the coalition now formed that Louis sent to Frederick III. to propose a partition of the Burgundian territories, the French provinces to be escheated to the crown, and the German fiefs to be claimed by the emperor. But the cautious Hapsburg would not commit himself to so far-

reaching a scheme, and replied that he preferred not to bargain about the bear's skin until the beast was dead.

The position of Charles was one of great danger. He was practically at war with the Swiss, with Sigismund of Tyrol, with the duke of Lorraine, and with the forces of the empire, which he had alienated by his unjustifiable intervention in the affairs of Cologne. But Charles knew that these enemies were all set in motion by Louis XI., and that if he could ruin his arch-opponent the hostile coalition would almost certainly fall to pieces. And in 1475 he had an unequalled chance of dealing a fatal blow to the power of France. For years the duke of Brittany and other opponents of the French monarchy had been striving to bring about a renewal of the English invasion, and at last their efforts were rewarded with success. Edward IV., securely established on the English throne by the double defeat of the Nevilles and the Lancastrian nobles, determined to resume the ambitious schemes of Henry V. and to make himself king of France with the aid of Burgundy. In 1474 the terms of the treaty had been arranged with Charles, who was to receive as his reward Champagne and some smaller districts, together with complete emancipation from the suzerainty of France. In the summer of 1475 a considerable English army was transported to Calais, and Charles at last set himself free to aid his ally by retiring from Neuss, and concluding an agreement with the emperor by which the Pope was to arbitrate in the dispute about Cologne. The truce between Burgundy and France had expired on May 1, and Charles had refused all the entreaties of Louis for its prolongation. But all the hopes which Charles had based upon the intervention of England were doomed to disappointment. Edward IV. was immensely chagrined when Charles arrived alone at Calais, having sent his army from Neuss to chastise the duke of Lorraine. St. Pol, who had offered to admit the English into St. Quentin, fired upon the approaching forces from

Edward IV.
invades
France, 1475.

behind the closed gates. The French monarchy was infinitely stronger in 1475 than it had been in 1415, and Edward iv. was shrewd enough to see that with such support as he received from professed allies the conquest of France was impossible. Louis on his side was not slow to profit by the obvious discouragement of the invaders, and promptly opened negotiations which resulted in a personal interview at Pecquigni on the Somme. In return for a large sum of money and a promise that the dauphin should marry his daughter Elizabeth, Edward agreed to withdraw from France. Charles was furious at what he denounced as treacherous desertion, but his own conduct had been so obviously selfish that his complaints were treated as unreasonable, and he was compelled to renew his former truce with Louis xi.

The failure of the English invasion and the renewal of peaceful relations between France and Burgundy proved fatal to St. Pol, who had succeeded for five years in maintaining a practically independent position in Picardy. He had been profoundly disappointed by the termination of active hostilities in 1472, but he still trusted in his ability to play off one rival against the other, and he was confident that their mutual jealousy would never allow them to act together against him. For a time his forecast had been justified. In 1472 it had been proposed that Louis and Charles should unite to punish the constable, but the scheme had broken down, because neither would trust the other. In 1475 the proposal was renewed. St. Pol's recent conduct, and especially his relations with Edward iv. who handed over to Louis the constable's correspondence, had created a strong desire to punish the man who betrayed and deceived everybody in turn. Charles was to have St. Quentin, Ham, and Bohain, with all the fiefs which St. Pol held of him, on condition that he would undertake to capture the constable and either punish him within eight days or hand him over to the king. On the

news of this treaty St. Pol determined to trust Charles rather than Louis, partly because he believed him to be less vindictive, and partly because after his territories were in Charles's hands the latter had little to gain by inflicting any further penalty. Charles was besieging Nanci when his ministers sent word that the constable was in their hands. Charles was anxious to avoid any French opposition in Lorraine and he sent instructions that if Nanci held out beyond November 24, St. Pol was to be handed over to the French, but if it were taken before that date they were to keep him in their hands. Nanci did not surrender till after the time had elapsed, but Charles began to think that his order had been hasty and that St. Pol might still be useful to him in his quarrel with France. His instructions to delay the transfer, however, came too late, as the Burgundian ministers, many of whom had a personal grudge against St. Pol, had punctually obeyed the original order. Louis was not unwilling to show that neither rank, nor royal relationship, nor eminent office could save a rebel against the crown, and St. Pol, of whose treason there was ample proof, was executed in Paris on December 19, 1475.

At the end of 1475 Charles the Bold seemed to be at the height of his power. He was at peace both with the emperor and the king of France. Since the submission of Ghent he had met with no opposition from his subjects in the Netherlands. The fall of St. Pol had restored his complete ascendancy in Picardy. Savoy and Milan were apparently loyal and almost submissive allies. The aged René of Provence, who had never loved the house of Vaudemont, expressed his willingness to disinherit his only surviving grandson in favour of the duke of Burgundy. Above all, Charles had at last succeeded in uniting the two main divisions of his realm by the conquest of Lorraine, and he determined to make Nanci the capital of the Burgundian kingdom that seemed now to be within his grasp. His one

immediate task was to recover the province of Alsace, and to punish the Swiss, not only for aiding to restore Sigismund, but also for their raids upon his own territories and those of his allies. His troops were exhausted by their exertions in the long siege of Neuss and the subsequent conquest of Lorraine; but his resources, both in men and money, were so infinitely superior to those of his opponents that it was hardly possible to doubt his ultimate victory. The Swiss had begun the war as the allies of the emperor and the French king, but they were now deserted by both. In February 1476 Charles crossed the Jura to drive the Swiss from the districts they had seized in Savoy. Granson, a town near the lake of Neuchâtel, which was held by the house of Orange as a fief of Savoy, was taken by the Burgundians, and the garrison was put to death. Two days later the confederates arrived, and at once began the attack. Charles ordered a portion of his army to retire to the plain where he could use his superior cavalry. But the retirement became a panic-stricken retreat, and the Swiss, pressing their advance, gained a complete and easy victory (March 2, 1476). Granson was recovered, and the Burgundian camp and artillery were the prize of the conquerors. So humiliating a disaster was the more galling to Charles that it shook the fidelity of his allies. The succession in Provence upon which he had confidently reckoned, was now transferred by René to the French king. Galeazzo Maria Sforza opened negotiations with Louis, and even Yolande of Savoy began to contemplate the possibility of a reconciliation with her brother. But Savoy could hardly desert Charles as long as there was a prospect of recovering the lost lands with his help; and the Burgundian power was not destroyed by a single disaster. Within a few weeks a new army had been collected at Lausanne, and Charles advanced to the siege of Morat, which the Bernese had taken from the Count of Romont, a brother of the late duke of Savoy. The Swiss hastily reassembled the troops, which had been disbanded

Charles's war
with the
Swiss, 1476.

after their recent success in spite of the warnings of Bern. On June 22, an obstinate, and for a long time, a very equal contest was fought out under the walls of Morat. At last the Swiss gained a decisive advantage by turning the flank of the Burgundian army; and the very obstinacy with which the latter fought only served to make their losses heavier. Nearly two-thirds of Charles's forces were practically annihilated, and the final desertion of his allies, combined with the disaffection of his own subjects, rendered it hopeless to renew the struggle. Savoy made peace with the Swiss, through the mediation of France; and Granson, Morat, and other towns of Vaud became subject to the Confederation. Charles retired into gloomy solitude near Pontarlier, and it was feared that his reason would give way as he cursed the ill-fortune which had humbled so powerful a prince before a despicable foe. He was roused from his retreat by the news that Lorraine was lost to him. The young René had joined the Swiss in the battle of Morat, and had proceeded after the victory to raise a force with which he had recovered Nanci. Charles hurriedly collected a third army, and, in spite of the winter cold, commenced a second siege of the town which he had destined to be his capital. The scanty garrison could not long have resisted the attack, but René appealed for the assistance of the Swiss, and they sent 20,000 men to raise the siege. The Italian mercenaries, in whom Charles placed great confidence, were headed by the count of Campobasso, a Neapolitan who had been driven into exile for his adhesion to the house of Anjou. Of that house René of Lorraine might now claim to be the lawful heir; and Campobasso was induced to desert his master in favour of the family to which his first allegiance was due. This treachery placed Charles at a fatal disadvantage, and he had to fight between the besieged and the relieving forces. But his dogged character would not allow him to retreat, and in a third contest with the despised German Confederation the great Valois duke

Death of
Charles the
Bold.

of Burgundy found an obscure and unhonoured death (January 5, 1477).

Louis XI. had watched the events of the last twelve months, at first with anxiety, and later with feverish attention. Ever since his accession he had been haunted by the sense of Charles's hostility, and the dangers which it involved; and now his great rival had been slain by the agency of an unforeseen and apparently unequal opponent. The only claimant of the vast inheritance left vacant by the death of Charles the Bold was an unmarried girl of twenty-one years. Various schemes were debated in the royal council as to the best way of profiting by so favourable a contingency. One very obvious plan was to effect a marriage between Mary of Burgundy and the dauphin. But there were several objections to this. The dauphin was only in his eighth year; he was already betrothed to an English princess, and Edward IV. was not likely either to pardon an insult to his daughter, or to acquiesce in the absorption of the Burgundian inheritance by the French monarchy. To the alternative scheme of marrying Mary to a French noble of royal blood, such as Charles of Angoulême, it could be objected that the new dynasty thus created might be as dangerous and disloyal as that to which it would succeed. Louis determined to keep the possibility of either marriage as a card to be played, if necessary or expedient, but in the meantime to take measures for the occupation of those Burgundian territories which France could acquire without serious opposition. The revival of such a power as that of Charles might be prevented, and the adhesion of German princes might be purchased, by a partition of the fiefs which the late duke had held of the empire. No preparations had been made to resist Louis, and his promptness ensured a considerable measure of success. He had an unquestionable claim to the Somme towns, whose transfer had been limited to male heirs; and the duchy of Burgundy could be reasonably claimed as an escheated fief. But Flanders, Artois, and

Louis seizes
Burgundian
territories.

Franche-Comté had come to the Burgundian house through an heiress, so that Mary's right of succession could hardly be disputed. Regardless of this consideration, and of the fact that Franche-Comté was an imperial fief, Louis proceeded with the work of annexation. Both the duchy and the county of Burgundy submitted to French rule. From Picardy, which returned willingly to its former allegiance, the forces of Louis entered Artois and succeeded in reducing its capital, Arras.

The occupation of Artois brought the French to the frontier of Flanders, the most wealthy and important of the Burgundian possessions. The Flemish citizens, and especially those of Ghent, where Mary of Burgundy was residing, were not likely to allow the choice of their future ruler to be settled without their participation. Their policy in the matter was quite distinct. They had hated Burgundian rule and the Burgundian ministers whom Charles and his predecessors had appointed to govern them. As long as their sovereign had been a mere count of Flanders, they had enjoyed a large measure of independence and self-government, but they had lost this under the too powerful Valois dynasty. They therefore welcomed the occupation of the Burgundies, and had no objection to a further weakening of Mary's inheritance. But they would not be annexed to France, and the aggressive measures of Louis xi. drove them into opposition to him. The Burgundian ministers, whom Charles had left in authority, were seized by the mob on the discovery that they were conducting separate negotiations with France, and in spite of the passionate entreaties of Mary, were put to death. The plan that commended itself to the people of Ghent was to marry Mary to Adolf of Gelderland, the youthful monster who had been imprisoned and disinherited for brutal ill-treatment of his father. Adolf was released and sent to oppose the French before Tournay; where, to Mary's great relief, he was killed in an unsuccessful attempt to relieve the town. This event, and the necessity

Conduct
of the
Flemings.

of gaining support against the encroachments of France, forced the Gantois to revive the scheme of marrying Mary to

Maximilian of Hapsburg, the son of the emperor Frederick III. Mary herself, naturally frightened and aggrieved by the conduct of Louis since her father's death, was not averse to the proposal,

and the marriage was solemnised in August 1477. Louis was extremely chagrined by the news of an event, which not only frustrated his plans for a further partition of the Burgundian inheritance, but also compelled him to fight for the provinces he had already seized. Maximilian undertook the championship of his wife's claims with his usual impetuosity. But he was hampered by his want of money—Commines calls his father 'the most perfectly niggardly man of his time'—and by the obstruction of the Flemish citizens, who had taken advantage of the weak government since Charles the Bold's death to recover much of their old independence. In 1482 Mary died, leaving two infant children, Philip and Margaret. This was a great blow to Maximilian, who had no longer any formal authority in the Netherlands, except so far as the estates of the various provinces recognised him as his son's guardian. In these circumstances he was not unwilling to

come to terms with Louis, and the treaty of Arras, 1482, gave to the king most of the territories he had contended for. The dauphin, Charles, was to be betrothed to Margaret, the daughter of Maximilian and Mary, and she was to be brought up in France as its future queen. Artois and Franche Comté were to be regarded as her dowry. The treaty made no mention of the Somme towns or of the duchy of Burgundy, and thus tacitly conceded Louis's contention that his legal rights to these provinces were indisputable. It was fortunate for Louis that Edward IV., who had good reason to regard this treaty as both injurious and insulting, was not able to give practical expression to his displeasure. He died in 1483, and the disturbances which followed kept England from any idea of intervention on the Continent. But though

the treaty of Arras appears, at first sight, to be a considerable triumph for the policy of Louis, the permanent gain to the French monarchy was not very great. Artois and Franche-Comté were lost again before very long; and the annexation of the Netherlands to the Hapsburg possessions, together with the subsequent further aggrandisement of that house, involved France in even greater dangers than those which had been threatened by the Valois dukes of Burgundy. But the subsequent struggle which thus arose differed from its predecessor in one very important respect. The Hapsburgs of Spain and Austria were more powerful sovereigns than Philip the Good or Charles the Bold, but they were complete foreigners to France, and had none of that traditional and family alliance with French nobles and French parties which gave to the Valois-Burgundian dynasty such a unique position. The contest with the Hapsburgs served to strengthen, not to destroy, the national unity of France.

The relations with Burgundy constitute by far the most important episode of the reign of Louis XI.; and he could boast of no more conspicuous achievement than the defeat of Charles the Bold, and the annexation of a considerable share of his dominions. Successes of Louis XI. But he gained other successes and acquired other lands. By intervening to support John II. of Aragon against the rebellious Catalans (1462), he obtained the cession of Roussillon and Cerdagne, and for a time extended the French frontier to the Pyrenees. And the Angevin inheritance was almost as great a windfall to the monarchy as the duchy of Burgundy. René le Bon had hastily abandoned the cause of Charles the Bold, after the latter's defeats in 1476; and Louis XI. succeeded in extorting from his uncle an arrangement by which the latter's territories were to pass, in the first place, to his nephew, Charles of Maine, and on the extinction of his line to the crown. The successive deaths of René in 1480 and of Charles of Maine in 1481, gave to Louis the possession of Anjou and Maine, with the duchy of Bar and the imperial fief of Provence. Equally

important, from the point of view of the French monarchy, were the signal humiliations inflicted by Louis upon the great feudatories who had ventured, in the early years of his reign, to identify themselves with the cause of opposition to the monarchy. The duke of Alençon was kept a prisoner till his death in 1476. The count of Armagnac, the restless leader of the southern nobles, was attacked in his chief town of Lectoure and perished in the sack which followed its capture. His cousin, the duke of Nemours, who had been a favourite companion of Louis in his youth and had since been twice pardoned for ungrateful treachery, was executed in 1477 after having suffered the most horrible tortures. The fate of St. Pol has been already related. With regard to the nobles who were more closely related to the royal family, Louis took precautions to ensure their loyalty or to disarm their opposition. The duke of Bourbon abstained from further rebellion after the War of the Public Weal. His brother and heir, Pierre de Beaujeu, was married to the king's eldest daughter, Anne, with the proviso that if they left no male heirs the succession should pass to the crown. For Louis of Orleans, the heir-presumptive to the throne after the dauphin, a bride was found in another daughter, Jeanne, who was deformed in person and was regarded as unlikely to have issue.

The government of Louis xi., though in many ways advantageous to France, was too obviously selfish to be popular. His death in August, 1483, transferred the crown to his only son, Charles viii., but as he was too young to rule, the actual government was assumed by Anne of Beaujeu. She had much of her father's ability and all his love of power, but her position was insecure and she was obliged to conciliate support by measures which Louis xi. would never have adopted. The States-general were convoked at Tours in January 1484, and for the first time the rural districts were represented in the third estate, which had hitherto included only delegates

**Regency of
Anne of
Beaujeu.**

from the towns. Although the estates recognised the regent, their *cahier* of grievances showed an obvious hostility to the despotic rule of the late king. Among other things they demanded that they should meet regularly every second year. But the States-general, having lost all efficient control over taxation, had no power to extort concessions, and the crown reserved absolute discretion as to the redress of grievances. A more serious danger to Anne was a coalition of nobles, including the duke of Brittany and headed by Louis of Orleans, who deemed it a wrong that he was excluded from the regency. There was some risk that the confederates might receive support from Richard III. of England, who had good reason to divert the attention of his subjects to a foreign war, and from René of Lorraine, who advanced a well-founded claim to his grandfather's dominions of Bar and Provence. Anne of Beaujeu showed notable ability in meeting her opponents. To prevent English intervention, Henry of Richmond, whose mother was the last of the Beauforts, was encouraged to prosecute the enterprise which placed the house of Tudor on the throne (1485). The duke of Lorraine was partially satisfied by the cession of Bar, and the prospect of gaining Provence was dangled before his eyes in an artfully prolonged law-suit, which was not decided against him until all danger was over. Meanwhile, the princes, deprived of external aid, proved powerless to resist the forces of the crown. The Bretons were defeated, and Louis of Orleans, carried a prisoner to Bourges, found it to his interest to reconcile himself with his cousin.

A few days after the defeat of the Bretons the death of duke Francis II. extinguished the male line of the Montforts, and left the one great province which had re-
Succession
in Brittany.
daughter Anne (September 9, 1488). The disposal of the hand of so important an heiress was naturally a matter of great political interest, and Anne of Beaujeu, who wished

to use the opportunity for the gain of the monarchy, was chagrined to learn in 1490 that the young duchess had been married by proxy to Maximilian of Austria, who had been a widower since the death of Mary of Burgundy. Declaring the marriage to be null without royal consent, she despatched an army into Brittany, and Anne of Brittany was compelled to give her hand to Charles VIII. A double injury was thus inflicted upon Maximilian. Not only was he deprived of a wife, but his daughter, who had been educated in France since 1482 as the future queen, was sent back to him. The archduke, however, was too distant and too busy elsewhere to be immediately formidable, and it was worth while to risk his displeasure in order to secure possession of Brittany. But the children of Charles VIII. and Anne did not survive their parents, and two subsequent marriages were necessary before the union of Brittany with France was complete.

The marriage of the king was the last achievement of Anne of Beaujeu, whose regency came to an end when her brother The question of Naples. assumed the reins of government, while she herself became duchess of Bourbon by the death of her brother-in-law. In 1493 a wholly new problem was presented to the French government by the arrival of Neapolitan exiles with an invitation to Charles VIII. to claim the crown of Naples on the same grounds as he already held Provence. The late regent and the more experienced councillors were resolute in opposing the scheme. But Charles himself and his younger associates were dazzled by the prospect of an Italian kingdom, and the proffered support of Ludovico Sforza seemed to give a reasonable prospect of success. Before Charles could venture to quit his kingdom it was necessary to secure it against the hostility of jealous neighbours. Henry VII. of England, who had come forward as the champion of Anne of Brittany, was bought off by the peace of Etaples which offered him a large money bribe (1492). The treaty of Barcelona restored Roussillon and Cerdagne to Ferdinand of Aragon (January

1493); while the enmity of Maximilian was appeased by the treaty of Senlis and the cession of Artois and Franche-Comté, which had been the stipulated dowry of Margaret (May 23, 1493). In September 1494, Charles set out on his journey towards the Alps. The resources of the revived French monarchy were to be employed in an enterprise of which no one could foresee the end, but which was destined to usher in a new epoch in the history of Europe.

CHAPTER XVII

GERMANY AND THE HAPSBURG EMPERORS, 1437-1493

German disunion in the fifteenth century—The House of Hapsburg—The succession in Hungary and Bohemia—The Imperial election in 1438—Death of Albert II.—Election of Frederick III.—Death of Frederick I. of Brandenburg—Futile opposition in Germany to the Emperor and the Papacy—Frederick III. at war with the Swiss—Sigismund of Tyrol—Succession to Albert II. in Austria, Hungary, and Bohemia—Ladislav Postumus—Relief of Belgrade and death of John Hunyadi—Death of Ladislav Postumus—Austria falls to the Styrian Hapsburgs—Election of Mathias Corvinus in Hungary and of George Podiebrad in Bohemia—War between Hungary and Bohemia—Relations of Frederick III. with Burgundy—Hungarian conquests in Austria—Last years and death of Frederick III.

In the history of three of the great countries of Europe, France, England, and Spain, the fifteenth century marks a decisive epoch in the growth both of national unity and of monarchical government. In France the civil strife of Armagnacs and Burgundians and the long struggle against the English prepared the way for the rule of Charles VII. and Louis XI. In England the Wars of the Roses ended with the accession of a powerful Tudor dynasty. In Spain national sentiment was kindled by the anti-Moorish crusades, and the union of the chief kingdoms by the marriage of Ferdinand and Isabella led to the great expansion of Spain under the despotic rule of Charles I. and Philip II. The history of Germany resembles that of its neighbours up to a certain point. Anarchy and disorder were as conspicuous there as they were in France under Charles VI., or under Henry VI.

Disunion
and weak-
ness of
Germany.

in England. The schism which filled the first decade of the century both illustrated and increased the weakness and the degradation of the once powerful German monarchy. But in Germany no remedy was found for political and social disunion. No ruler arose with the strength and the resolution that were needed to transform a vague suzerainty into a territorial monarchy, as Charles iv. had schemed to do. On the contrary, there was a marked decline of imperial authority, which reached its nadir in the reign of Frederick III. The impulsive Sigismund had striven for a moment to revive the Ghibelline tradition, and he seemed to have made a considerable stride when, in 1415, he humbled the pride of Frederick of Tyrol, and rewarded the loyalty of Frederick of Hohenzollern with the electoral Mark of Brandenburg. But Sigismund's imperial ambitions were bound up with the cause of the reforming party at Constance, and he was discouraged and disconcerted by its failure. From that time he abandoned the interests of Germany to devote himself to the affairs of Bohemia and Hungary. The party which had rallied round him at Constance, deserted by their natural leader, endeavoured to give to Germany a new central government which should take the place of the decadent monarchy. A series of ignominious defeats by the Hussites enabled them to carry through the diet some tentative reforms in 1427. There was to be a system of imperial taxation, an imperial army, and a standing representative council to wield the executive power which the emperors had allowed to fall from their hands. But the projected reforms ended in failure. The sense of nationality was not strong enough to overcome the selfish independence of states and classes. The two last crusades against the Bohemians were even more humiliating to Germany than their predecessors.

That the disunion of Germany was a source of many evils and of serious dangers was apparent even to the proverbial blindness of contemporaries. The dependence of

Italy had become the merest name. Even Milan, which under the Visconti was most closely connected with Germany, was about to pass to the Sforzas, who did not think it worth while even to apply for imperial investiture. North of the Alps, Lyons and Dauphiné had long been absorbed by France. Provence and Lorraine were in the hands of a French dynasty, and before the end of the century the former had been acquired by the French crown. Savoy was more independent of France, but hardly more closely tied to Germany. The Old League of High Germany, as the Swiss confederation was then called, had paraded devotion to the empire as a means of resisting the claims of the Hapsburgs, but the cantons really desired freedom from all external control, and by the end of the century they had practically acquired it. Franche-Comté was ruled by a Valois duke of Burgundy, Philip the Good, who was absorbing one after the other a number of imperial fiefs in the Low Countries. The Scandinavian kingdoms, strengthened for a time by the union of Kalmar, were beginning to recover their previous losses, and the Hanseatic League, the champion of German interests in the Baltic and the North Sea, was no longer at the height of its power. In the north-east, the Teutonic knights had been fatally weakened by the union of Poland and Lithuania, and since the battle of Tannenberg in 1410 were waging what seemed to be a hopeless struggle against the powerful Jagellon kings. The danger of a general Slav revolt against German encroachments had been brought even more nearly home to the princes of Germany by the long Bohemian war. It is true that the extreme Hussites had been defeated in 1434, but it was by their own countrymen; and the sentiment of national independence, which was necessarily anti-German, was almost as strong as ever. And in the south-east a new and far more terrible danger was approaching. The Turks had already established themselves in the Balkan peninsula, and threatened to sweep up the Danube valley.

Hungary was the only substantial guard to the German frontier; and if Hungarian resistance failed, it was hardly likely that the German troops, impotent to crush the ill-armed followers of Ziska, would be able to resist the all-conquering Janissaries.

Losses on the extremities were the inevitable result of weakness at the centre. But although this weakness continued, Germany escaped from some of the extreme disasters which seemed almost inevitable. It is possible that a too vigorous attempt to bring about a compulsory union might have broken the state up into its component parts, and Germany, like Italy, might have become a mere geographical expression. That this complete disruption was avoided, and that Germany retained at any rate some symbols of unity, may be attributed, partly to the very looseness of the federal tie, which was so little felt that it was hardly worth while to make an effort for its rupture, and partly to the extraordinary series of events which enabled a single family, the House of Hapsburg, to obtain a sort of hereditary primacy within Germany. In view of the danger threatened by Slavs and Turks, it was of supreme importance that Germany should retain its hold upon the border states of Bohemia and Hungary, which had been gained by Sigismund. But with Sigismund's death in 1437 the male line of the House of Luxemburg became extinct, and the family was only represented by two women—Sigismund's own daughter, Elizabeth, who was married to Albert v. of Austria, and his niece, another Elizabeth, the widow of Antony of Brabant. [See Genealogical Table, F]

Although Albert of Austria might claim through his wife the succession to the Luxemburg inheritance, the most sanguine of contemporary observers could hardly have foretold that the Hapsburgs would bring even partial salvation to Germany. Since the first great expansion of the family under Rudolf I. and his immediate successors, its power and prestige had sensibly

The House
of Haps-
burg.

diminished. This had been caused, partly by defeats at the hands of the Swiss, and partly by the subdivision of Hapsburg territories effected in 1370 between the two brothers, Albert III. and Leopold III. (see p. 137). Albert had taken the archduchy of Austria, and Leopold the other territories of the House—the Swabian lands, Styria, Carinthia, Carniola, and Tyrol. The Albertine line in Austria had been continued by the successive rulers Albert IV. (d. 1404) and Albert V. The history of the Leopoldine line had been less simple. Leopold himself had fallen in 1386 in the famous battle of Sempach, and had left his dominions to the joint rule of four sons—William, Leopold, Ernest, and Frederick. But the first precedent of subdivision was again followed, and in the end the two surviving sons, Ernest and Frederick, shared the inheritance between them. Ernest, the founder of the Styrian, and ultimately the dominant, branch of the House, was called ‘the Iron’ on account of his physical strength, and his marriage with Cymburga, a niece of the Polish king, is said to have brought the famous Hapsburg lip into the family. On his death in 1424 his two sons, Frederick and Albert, succeeded as joint rulers to Styria, Carinthia, and Carniola. Meanwhile Frederick, who had received Tyrol and the Swabian lands, had played a prominent part in the early stages of the Council of Constance, and his territories had been confiscated by Sigismund in 1415. But the imperial authority was not strong enough to make the penalty permanent, and in 1417 Frederick recovered his dominions with the approval and aid of his subjects. He lived till 1439, when he left a young son, Sigismund, to succeed him.

The death of the Emperor Sigismund gave rise to three problems of considerable magnitude. It extinguished a dynasty which had held the imperial crown for

Succession in Hungary and Bohemia. nearly a whole century, and it opened the succession in two kingdoms which were of supreme importance to Germany in her relations with the Slavs on

one hand and with the Turks on the other. The House of Luxemburg had built up a unique territorial power on the eastern frontier of the empire, and it was very doubtful if it could be retained by any other family. In Hungary little opposition was made to the accession of Albert v. of Austria, who had already won a reputation in the Turkish wars for valour and sagacity. But before his coronation he had to promise to refuse the imperial crown if it should be offered to him, a stipulation which shows how little the Hungarians valued the connection with Germany. In Bohemia, Albert had identified himself with the orthodox party, and could reckon on its support. But the Hussites, still a majority of the population, were resolutely opposed to him, not only on religious grounds, but also because his accession would continue the hated German domination, and his claim ran counter to their contention that the Bohemian crown was elective. The result was a renewal of civil war. Albert was accepted and crowned by his partisans, while the Hussites sought to gain the general support of the Slavs by offering the crown to Casimir, the brother of Ladislas of Poland.

Meanwhile the electors in Germany had to fill the imperial throne. The reforming party, which had been stirred to activity by the disasters of the Hussite war, was still in existence and still headed by Frederick of Hohenzollern. If they could control the election, it might be possible to return to the policy which Sigismund had pursued in his early years. Their desire was to choose a prince whose interests lay within Germany and not outside, and who would sacrifice any personal or family considerations for the general welfare. The candidate whom they put forward was Frederick of Hohenzollern himself, who had already given an example within Brandenburg of that reforming activity which was needed to put an end to the selfish and distracting divisions of Germany. But the majority of the German princes were little influenced by patriotic

Election of
Albert II.,
1338.

considerations. They valued independence far higher than unity. It was no grievance to them that Sigismund had neglected Germany since 1417, and had busied himself with affairs in Bohemia and Hungary. They turned their eyes to Albert v. of Austria, who seemed to occupy precisely the same position as Sigismund had held in his later years. His immediate objects lay so far outside the empire that he was not likely to interfere with princely independence, while the pursuit of his own interests in the east might indirectly render no small service to Germany. Another and perhaps decisive argument in Albert's favour was that he had adopted that policy of neutrality in the struggle between Pope and Council which commended itself to most of the German princes. When the Electoral College met in March 1438, it was speedily evident that Albert had a secure majority in his favour, and Frederick of Brandenburg gracefully withdrew his candidature in order to allow the election to be unanimous. The election does not bulk very largely in either contemporary or later narrative, but it was really of quite decisive importance. Until the fall of the Holy Roman Empire in 1806, with the exception of one short interval in the eighteenth century, the Hapsburgs retained practically hereditary possession of the imperial crown. Under them Germany became a loose and ineffective federation, held together by tradition and habit and by the ascendancy of a dynasty which showed remarkable astuteness and obstinacy in the pursuit of its own interests. The monarchy of the Ottos and the Hohenstaufen had ceased to exist, and the traditions of Ghibellinism became an anachronism after 1438. The choice in that year lay between a Hapsburg and a Hohenzollern; and it is of more than superficial interest to note that when the empire of the Hapsburgs had come to an end, when the evils of disunion had at last worked their own cure, the first attempt to revive German unity was the election of a Hohenzollern to the throne which the Hapsburgs had failed to fill.

Albert II., as he is called in the list of emperors, only accepted the proffered dignity with considerable reluctance, and was never able to visit Germany, even for the purpose of being crowned. His first occupation was to enforce his claim in Bohemia against his rival, the Polish prince Casimir. With the aid of a German force, Albert laid siege to Tabor, which was still the great Hussite stronghold. The besiegers were repulsed by a sally headed by a young Bohemian noble, George Podiebrad; and though Albert was more successful in Silesia, where there was a large German element in the population, the fate of Bohemia was still doubtful when he was called away by the news that the Turks had invaded Servia and were threatening Hungary. Leaving his representatives with instructions to patch up a truce with Poland, Albert hurried to meet this new danger. But he wholly failed to relieve Semendria, and his troops were decimated by dysentery contracted in the marshy valley of the Theiss. Albert himself was attacked by the disease, and hurried homeward in the hope of seeing his capital and his wife once more. On the way he learned that his cause in Bohemia was jeopardised by treachery, that the Council of Basel had revived the schism by electing Felix v. as anti-pope, and that the Turks were advancing upon Belgrad, the key of Hungary. At this crisis, when disaster or ruin seemed imminent from every side, Albert succumbed to disease just as he had reached the outskirts of Vienna (October 27, 1439). His death seemed to make the general confusion worse confounded. Not only was the empire again left without a head, but the recently-established connection of Austria with Hungary and Bohemia was dissolved before it had had time to gain any strength, and it was extremely doubtful whether it would ever be restored. The only children born to Albert and Elizabeth were two daughters, but Elizabeth was pregnant at the time of her husband's death, and until the child was born any question of hereditary right must remain in abeyance. It will perhaps be clearer to consider the imperial

election and the general history of Germany before turning to the tangled series of events which ensued in Albert's personal dominions.

The election of 1438 was too recent for any marked change to have taken place in the balance of parties, and the principles which had then prevailed were re-affirmed in 1440 with even greater emphasis. In choosing Albert the electors could argue with some force that they were giving the imperial office to the strongest candidate. Albert was the legitimate successor of the late emperor, and he was a powerful prince. Not only was he archduke of Austria, but he had been crowned king in Hungary and Bohemia, and though he was opposed in the latter country he had a better claim than his opponent. Moreover, his personal character and his past achievements commanded general respect. None of these arguments could be advanced in favour of Frederick of Styria, who was now brought forward by the electors who had supported Albert. In his father's territories of Styria, Carinthia, and Carniola he was only joint ruler with his brother Albert. He was barely twenty-four years old, so that little was known of his character and abilities, but he had given no proof either of energy or capacity for affairs. But these considerations had no weight with men who desired only a King Log, and Frederick was chosen by five votes to two on February 2, 1440. The rival candidate was Lewis of Hesse, who was put forward and supported by Frederick of Brandenburg. Events had convinced the latter that in face of the jealous hostility of the house of Wettin neither he nor any member of his family had a chance of success.

His vote on this occasion was almost the last public act of the first Hohenzollern elector of Brandenburg, though he received one more proof of the esteem in which he was held. A council of forty-seven was formed in this year to choose a new king for Bohemia. Ten votes were split among several candidates, while thirty-seven were given for Margrave Frederick. But

**Death of
Frederick I.
of Branden-
burg.**

he was too old and too weary to entertain any new ambitions, and the flattering offer was declined. On September 21, 1440, he died, leaving his territories to the joint rule of his four sons. For nearly fifty years, ever since he saved Sigismund's life in the battle of Nicopolis, he had played a foremost part in German politics. He had met with failures as well as triumphs, but he had always secured respect, both for distinguished ability and for purity of motive. He was the last champion of the grand imperial traditions, which had really perished at the time of the Great Interregnum, though Henry VII. and, at one time, Sigismund had made an effort for their revival. It was fitting that Frederick should die in the year in which the ideas which he represented met with their final reverse. But he was much more than the champion of the mediæval past. He was the real creator of the modern state of Prussia, which has become the centre of a revived German nationality, and has thus succeeded to some extent in carrying out the schemes in the advancement of which its great founder spent his life.

Frederick III., who held the German crown for fifty-three years, was almost as inefficient a ruler as the drunken Wenzel, but his inaction was due rather to set purpose than Character of to incompetence. He is described by a German Frederick III. chronicler as handsome and well built, of quick intelligence but of placid spirit, fond above measure of peace and quiet. Even the labours of the chase were distasteful to him, and his chief delight was in architecture and the collection of precious stones. By many he was considered a coward. His acute contemporary, Philippe de Commines, calls him 'the most perfectly niggardly man that ever lived.' In another passage, however, Commines admits that his long experience of men had given him wisdom. This was quite true. Frederick had none of the energy and decision of a statesman who wishes to control the course of events. But he had the merit of self-control, and a cheery confidence that patience and delay would bring improvement, no matter how hope-

less might seem the condition of affairs. His reputation for cowardice arose from his habit of evading difficulties when he felt unable to face them. Thus, in 1451, when he was threatened by a simultaneous rising in Austria and Styria, he left the rebels to do their worst, and hurried off to Italy to receive the imperial crown. In 1473 he had his famous interview at Trier with Charles the Bold, who desired to receive the royal title. Unwilling either to grant the request or to exasperate the duke by a direct refusal, the emperor escaped by night to Cologne. Such expedients were not very dignified, nor were they calculated to produce any great triumphs of statesmanship, but they were not ill suited to avoid fatal disasters. In Germany Frederick was threatened with reforms which should annul the royal power, and even with deposition, yet he succeeded in the end in defeating his opponents. In his hereditary dominions he suffered many humiliations; and at one time the greater part of Austria, including the capital, Vienna, had fallen into the hands of the Hungarians. But at the time of his death, Frederick left the house of Hapsburg infinitely more powerful than it had been at the time of his accession. The family territories, which had been subdivided since 1370, were gradually re-united in the hands of the Styrian line. And the marriage of his son Maximilian with Mary of Burgundy raised the Hapsburgs to be one of the great dynasties of Europe, and prepared the way for still greater pre-eminence in the future.

Of Germany as a state there is naturally very little history under a king who deliberately neglected his duties. For nearly thirty years Frederick III. remained obstinately secluded in his own territories, and never visited any other part of Germany. Diets were held and matters of the gravest importance debated, but neither entreaties nor threats could induce the emperor to attend. In the first great problem of his reign, the quarrel between the papacy and the Council of Basel, Frederick

German opposition to Frederick III.

showed the most cynical disregard of national interests and prejudices. The pope was anxious to annul the pragmatic sanction of 1439, which had given some measure of independence to the German Church. Frederick allowed himself to be bribed into a secret treaty with the papacy, and the diplomacy of Æneas Sylvius Piccolomini was employed to divide and gain over the princes and electors. Eugenius iv. lived just long enough to accept the preliminary treaty, and the final concordat was concluded with Nicolas v. (see p. 241). Equally discreditable, though less treacherous and self-seeking, was Frederick's conduct when the news came that Constantinople had fallen before the Turkish attack. The pope and the emperor, as the joint heads of Christendom, were the natural leaders of resistance to the encroachments of the infidel. And Frederick III. had strong personal and territorial interests at stake which he might consider more important than the obligations of his high dignity. Nicolas v. hastened to issue exhortations to a new crusade, and Æneas Sylvius set himself to rouse the martial spirit of Germany. But Frederick III. shut himself up in his room, and with tears lamented the instability of human greatness. The German diet met at Ratisbon in 1453, and at Frankfort in 1454, but the emperor would not appear, and in his absence no decision could be come to. Bitter indignation was felt and expressed at such pusillanimous inactivity. The archbishop of Trier, Jacob von Sirk, who had never pardoned Frederick for his betrayal of the German Church to the papacy, took the lead of the opposition. With him was allied the Elector Palatine Frederick the Victorious, who had supplanted the infant nephew for whom he had been guardian, but had never been able to obtain the imperial sanction for his usurpation. The deposition of the emperor was discussed, and Philip of Burgundy, who professed great ardour for the projected crusade, was suggested as his successor. Ultimately in 1455 a more practical scheme was put forward for the creation of a central administrative body,

in which the emperor might appoint a deputy if he would not attend in person. This council, in which the electors would have preponderated, was to put down disorder, to raise a revenue by an imperial tax upon clergy and laity alike, and was to take measures for the defence of the empire against the Turks. The scheme came to nothing. Frederick III. opposed a passive resistance, and the archbishop of Trier was more interested to gain power and prominence for himself than to effect any real reform. In 1456 Mohammed II. laid siege to Belgrade, and the fall of the fortress would have opened the whole valley of the upper Danube to the Turks. The danger was warded off, not by the exertions of emperor or princes, but by the heroism and skill of a Hungarian soldier.

With the opposition to the emperor was combined hostility to the papacy. Many of the princes looked back with regret to the pragmatic sanction of 1439, and envied the French who still retained the pragmatic sanction of Bourges. The death of Nicolas V. in 1455 and the election of Calixtus III. gave an opportunity for formulating the old complaints against the Roman see. Some of the electors proposed to summon a new general council in a German city to take up the work of ecclesiastical reform which the council of Basel had failed to carry through. At the same time the reform of the imperial administration was again mooted, and Frederick III. was called upon to attend a meeting of the diet. But the princes had ceased to be a united party. Albert Achilles, the brother of the elector of Brandenburg, had quarrelled with the Elector Palatine, and now came forward as the supporter of the emperor. The archbishop of Trier was dead and his successor was gained to the side of Frederick III. The opposition leaders still threatened to depose the emperor, but they had no longer a majority behind them. Frederick III. by a masterly inactivity had thwarted the projects of administrative reform, and thus set the seal upon

German
hostility to
the papacy.

German disunion. His triumph brought with it a victory for the papacy. Ecclesiastical tenths were constantly levied on the pretext of a Turkish crusade, but the money passed into the pope's coffers. Half the benefices in Germany were practically in the gift of the Curia. In 1459 Æneas Sylvius became pope as Pius II. in succession to Calixtus III. In 1460 he dealt a fatal blow to the conciliar opposition with which he had been so closely associated in earlier years. The bull *Execrabilis* declared any appeal from a papal decision to a general council to be impious and heretical. From this time the opposition to the papacy in Germany was only weak and fitful until a new era began in the next century.

For his inaction in Germany, Frederick III. had a fairly substantial excuse in the constant troubles in which he was involved at home. Not only had he to contend with the factious opposition of his brother Albert and the Styrian nobles, but in 1439 the death of his uncle Frederick left him to act as guardian for the young Sigismund of Tyrol, and later in the same year he was called upon to deal with the very serious problems to which the death of Albert II. gave rise. As Sigismund's guardian, Frederick III. had to administer Tyrol and the Swabian territories, and the latter brought him into collision with the Swiss. For a long time jealousy had existed between the rural cantons and the city members of the League, especially Zürich. This was brought to a head in 1436 by the death of the count of Toggenburg. His inheritance was claimed by the emperor, by the Confederation as a whole, and by Zürich. When the citizens seized a large part of the disputed territory, the rest of the confederates, headed by Schwyz, took up arms and compelled them to disgorge their booty. It was the prominent part taken by the men of Schwyz on this occasion which helped to give their name to the whole Confederation. Indignant at the humiliation, Zürich drew aloof from the League and

Frederick
III. and the
Swiss.

appealed to Frederick III. as both emperor and representative of the House of Hapsburg. Frederick could not resist the temptation to enforce the imperial claims to Toggenburg, and also to recover the Aargau which the Swiss had taken from his uncle, Frederick of Tyrol, at the time of his quarrel with the Emperor Sigismund. The war broke out in 1442, and in spite of Frederick's assistance Zürich was again closely besieged by the forces of the Confederation. Unable to spare more troops from his own territories, Frederick resorted to the extraordinary expedient of employing French mercenaries against his German subjects. Charles VII., freed for the time from his war with England, was only too glad to get rid of some of the *écorcheurs*, who had become a curse to France. Instead of the 5000 men whose services were demanded, he sent nearly 20,000 so-called 'Armagnacs' to invade Swabia under the nominal command of the dauphin. Devastation and misery marked the track of this vast force as it advanced to raise the siege of Zürich. A few hundred Swiss tried to block the way, and on the field of St. Jacob, the German Thermopylæ, they were completely annihilated. But their heroism had gained its end. The invaders, who had suffered terrible losses, hastened to conclude a truce with such resolute foes, and retired to Alsace. In 1445 they were induced to evacuate the country, but it was long before the horrors of the raid were forgotten in Germany.

Frederick III., who had brought such sufferings upon his subjects, gained nothing by his unpatriotic action. The Swiss were more than ever determined to resist the hated Hapsburgs to the last. The war went on till 1450, when Zürich deserted the Austrian alliance and returned to the League. Frederick Sigismund had to give up the guardianship of his cousin of Tyrol. Sigismund, who became independent ruler in Tyrol and the Swabian territories. His subsequent history may be briefly traced. Involved in constant quarrels with the Swiss, for which he was inadequately provided with men and money, he pledged his Swabian lands in 1469 to Charles

the Bold. They proved as fatal a possession to the Burgundian duke as they had been to the Hapsburgs. The wily Louis XI. gained one of his greatest diplomatic triumphs when he reconciled the Swiss with Sigismund of Tyrol, and stirred them up to make war against their powerful neighbour. After successive defeats at Granson and Morat, Charles the Bold fell in 1477 before the walls of Nancy. Sigismund of Tyrol recovered his Swabian inheritance, but he had no children, and before his death in 1496 he handed his territories over to Frederick III.'s son Maximilian, in whose hands all the Hapsburg territories were reunited.

The succession to Albert II. in Austria, Hungary, and Bohemia gave rise to a series of complications in the east, and involved Frederick III. in many difficulties. Succession in Austria, Hungary, and Bohemia. Albert's widow, Elizabeth, gave birth to a son, Ladislas Postumus, on February 22, 1440. In Austria, where the rule of male succession was unquestioned, the infant duke was immediately acknowledged, and was placed under the guardianship of Frederick III. But in Bohemia and Hungary, where Hapsburg rule was both novel and unpopular, the problem was by no means so easily settled. In Hungary there was no absolute rule of inheritance, and female succession was not excluded either by custom or law. Sigismund's claim to the crown had rested on his marriage with the daughter of Lewis the Great, and Albert had been accepted as the son-in-law of Sigismund. It was possible to contend that there was no real vacancy, and that Elizabeth was lawful queen. The primary need of Hungary was defence against the Turks, and in order to strengthen the kingdom the nobles compelled Elizabeth to offer her hand, and with it the Hungarian crown, to Ladislas III. of Poland. On the birth of her son, Elizabeth repudiated the engagement, and had the infant crowned king. But she was not strong enough to enforce her will, and on her death in 1442 the Polish king was generally acknowledged in Hungary. But he perished in the great

battle of Varna against the Turks in 1444, and in the following year the Hungarians returned to the direct line and recognised Ladislas Postumus as king. But he was still a minor in the guardianship of Frederick III.; and as the Hungarians would not allow a foreigner to administer their kingdom, they gave the office of governor in 1446 to John Hunyadi, who had won a brilliant reputation in the Turkish war. Meanwhile, Bohemia had pursued its own course. The Utraquists, the most numerous and powerful party in the kingdom, refused to recognise claims based upon hereditary right or dynastic treaties, and insisted upon the right of election. In all probability they would have chosen the Jagellon king of Poland, if he had not already been accepted in Hungary. The connection with Hungary was no more popular than that with Austria. The crown was offered to Frederick of Brandenburg, but he would not have it, and in the end it was decided to elect Ladislas Postumus as king, and to intrust the administration during the minority to a council of Regency. But this settlement of the succession failed to produce any harmony among the contending parties. The Roman Catholics, headed by Ulrich von Rosenberg, desired a complete reconciliation with Germany and the Papacy. The Utraquists, who found a capable leader in George Podiebrad, were resolute to maintain the national independence and the religious settlement arranged in the *Compactata* with the Council of Basel. A prolonged civil war ended in the Utraquist victory and the appointment of George Podiebrad as governor of Bohemia in 1452.

The Hapsburg rule in Hungary and Bohemia was nominally prolonged by the recognition of Ladislas Postumus in his father's dominions. But in actual fact there was little strength in the connection, as each state arranged its own affairs with intentional disregard of its fellows. To Frederick III., the guardianship of his young cousin brought little but incessant worries and annoyances.

Ladislas
Postumus.

Neither Hungary nor Bohemia would allow him any authority whatever, and even in Austria Styrian administration was extremely unpopular. Both the Austrian nobles and John Hunyadi were urgent in demanding that Ladislas Postumus should be released from external tutelage and intrusted to the care of his own subjects. George Podiebrad, on the other hand, who had no wish to jeopardise his own authority by the presence of a young king, who might fall under the influence of his opponents, urged Frederick to maintain his rights as guardian. In 1451 a simultaneous rising broke out in Austria and in Styria. Frederick III. chose this moment for a journey to Rome, to receive the imperial crown at the hands of the Pope. He endeavoured to checkmate the rebels by taking Ladislas Postumus with him. The coronation, on March 19, 1452, was the last that was destined to take place in the ancient capital of the empire. On the emperor's return to Germany, he was disgusted to find that his absence had only exasperated his opponents. The Austrian nobles entered Styria and attacked him in his own capital of Neustadt. Unable to resist any longer, Frederick agreed in September 1452 to hand over his ward to the Count of Cilly, who carried him in triumph to Vienna.

Ladislas Postumus seemed to have a brilliant career before him, when he emerged from tutelage to be Duke of Austria and King of Hungary and Bohemia. He was at the time in his thirteenth year, and he had only five troubled years to live. Hungary and Bohemia remained under the administration of Hunyadi and Podiebrad, but Ladislas was involved in quarrels with the two regents by the evil influence of the Count of Cilly. It was still uncertain whether the young king would succeed in asserting his personal authority, when the fall of Constantinople and the pressing danger from the Turks compelled a temporary pacification. In 1456, Mohammed II. with a huge army laid siege to Belgrade,

Relief of
Belgrad,
1456.

and Turkish vessels sailed up the Danube to exclude any attempt to relieve the garrison by way of the river. Hungary and south-eastern Germany would be exposed to invasion if the great fortress were allowed to fall. For a moment, something like the old crusading fervour was excited by the preaching of an enthusiastic Franciscan, Fra Capistrano, and Hunyadi undertook the command of the motley host that was collected by the eloquence of the friar. A flotilla of rafts and boats was prepared, and the destruction of the Turkish ships, under the very eyes of the Sultan and his army, enabled the relieving force to enter Belgrade. But Mohammed II. refused to acknowledge his defeat. As a blockade was no longer possible, he determined to carry the fortresses by storm. One by one the outworks were carried by sheer force of numbers in spite of the heroic resistance of the defenders. The crescent was about to be elevated to announce a signal victory, when Hunyadi and Capistrano headed a last sally. The Turks were driven in headlong flight from the walls, their camp was stormed and burned, and before evening the Sultan's army was in full flight for Sofia, leaving 20,000 men on the field (July 22, 1456). The relief of Belgrade was a magnificent achievement, but it cost the life of the two leaders. Hunyadi died of camp fever on August 11, and a few weeks later Capistrano followed him to the grave.

The death of the Hungarian regent was welcomed by Count Cilly as removing a rival from his path. But the great soldier had left two sons, Ladislas and Mathias, who inherited their father's popularity and might aspire to hold his position in the state, and Cilly schemed to effect their ruin. Ignorant that his intrigues had been discovered, he accompanied the young king on a visit to the rescued fortress. No sooner were they within Belgrade than they found themselves prisoners, and Cilly was brought before Ladislas Hunyadi, reproached for his treachery, and put to death. Ladislas Postumus

**Death of
Ladislas
Postumus.**

was shrewd enough to dissimulate his wrath and to pretend to pardon the murderers. But he was only waiting his time. Early in 1457 he returned to Pesth, and as soon as he had surrounded himself with his own partisans, he had Ladislas Hunyadi taken prisoner, tried and executed for the murder of Cilly. Mathias, the younger brother, he carried off to Vienna and thence to Prague. At the latter city he was preparing to celebrate his marriage with Madeline, daughter of Charles VII. of France, when he died suddenly on November 23, 1457. So tragic an event made a profound impression in Europe. Ladislas Postumus was too young to be regarded as responsible for the demerits of his government, and his handsome face and winning manners had always made him personally popular. In Vienna the news was received with paroxysms of grief, and a suspicion was naturally entertained that the young prince had met with foul play. That he should have died in Prague was almost conclusive proof of crime. German dislike of the Slavs and Roman Catholic detestation of heretics combined to formulate the charge against George Podiebrad. Before long men told in detail how the poison had been administered, its effects on the unfortunate victim, and the way in which the doctors had been suborned by the Bohemian regent. But there is not the slightest foundation for these stories, and Ladislas unquestionably died of the plague or Black Death which devastated Europe at intervals throughout the fourteenth and fifteenth centuries.

For the second time within a few years the connexion between Austria, Hungary, and Bohemia was dissolved, and as Ladislas Postumus left no descendants, it seemed extremely unlikely that it would be renewed. In each of the three countries which he ruled he represented a different dynasty. In Austria he was the last of the Albertine line, and his death left the primacy to the Styrian branch of the Hapsburgs. In Hungary he had ruled, through the marriage of his grandfather Sigismund, as the ultimate descendant of

the Angevin dynasty, which had held the crown for a century and a half. In Bohemia, through his mother Elizabeth, he represented the house of Luxemburg. Great interest attached to the succession. Austria, by family agreement, passed to the joint rule of the three surviving Hapsburg princes, Frederick III. and his brother Albert, and their cousin Sigismund of Tyrol. Such an arrangement gave rise to quarrels, which were only terminated by the death of Albert in 1463, when Frederick III. bought off Sigismund with a money payment and assumed the undivided government of the Austrian duchy. In Hungary it was decided to disregard all hereditary claims, and to fill the throne by free election. On January 24, 1458, the choice of the diet fell upon Mathias Corvinus, the surviving son of Hunyadi, whose final exploit in relieving Belgrade had made him a national hero. In Bohemia a similar contempt was shown for dynastic or treaty claims, and the growing national sentiment found expression in the election of George Podiebrad (March 2, 1458). These two elections were events of no ordinary significance. They marked a popular protest against dynastic arrangements which had paid no regard to national interests, and had so often brought about the rule of alien princes. The practical assertion of the rights of the people, of the principle of nationality, and of the idea that merit rather than birth confers a claim to rule, was a serious blow to the vested interests of European kings and princes.

The termination of Hapsburg rule in Hungary and Bohemia was a bitter disappointment to Frederick III., who had hoped to succeed his cousin in these kingdoms. But as usual, his exertions were unequal to his ambition; and after a futile struggle he was compelled to acknowledge his successful rivals. Common interests drew the new kings together, and the marriage of Mathias with the daughter of Podiebrad seemed likely to be the basis of a close and lasting alliance. Such an alliance would

**War between
Hungary and
Bohemia.**

have been of the greatest value to Europe, and would have constituted a formidable barrier to Turkish aggression. George Podiebrad had already shown consummate statesmanship in restoring order in the distracted state of Bohemia, and Mathias soon proved that he had inherited no inconsiderable share of the military skill and energy of his father. But unfortunately religious differences placed an impediment in the way of the concerted action of two princes who had no superior among the monarchs of their time. Mathias was an orthodox member of the Church, while his father-in-law had been born and bred a Utraquist, and had consistently directed his policy to the maintenance of the Compacts of 1433. But these concessions to the Hussites had been extorted with difficulty from the Council of Basel, and successive popes were eager to restore uniformity of belief and ritual by their revocation. Pius II., encouraged by a confident expectation of the revival of crusading ardour, ventured to annul the Compacts in 1462, and his successor, Paul II., in 1466 decreed the deposition of Podiebrad as a heretic. The result of these papal measures was to rekindle a religious war in Bohemia, and Breslau became the centre of a rebellious Catholic league. But Podiebrad was well able to hold his own against domestic opposition, and the Pope, with the connivance of the Emperor, set himself to obtain the active assistance of the Hungarian king. Mathias had no sympathy with heresy, his wife had died in 1464, and he was tempted by the prospect of acquiring the Bohemian crown for himself and of gaining the active support of the German states against the Turks. War broke out in 1468, but Mathias, in spite of occasional victories, gained little honour or substantial advantage. In fact the chief result of hostilities was to deprive him of the prospect of gaining Bohemia. George Podiebrad, driven by Hungarian invasion to seek the support of Poland, suggested Ladislas, the son of Casimir of Poland, as his successor. The proposal was not unwelcome to the diet. The sentiment of nationality was conciliated by the choice of

a Slav prince, and the only lingering sentiment of loyalty to the ancient dynasty was gratified by the thought that Ladislav's mother was the younger daughter of Albert II. and Elizabeth of Luxemburg, and that therefore some of the blood of Charles IV. ran in his veins. On the death of Podiebrad in 1471, Ladislav succeeded in attaining the crown in spite of all the efforts of Mathias to exclude him.

Mathias had good reason to suspect that the emperor, his professed ally, had supported the candidature of Ladislav, and during the later part of his reign he was engaged in almost continual hostilities with Austria. Frederick III. was no soldier, and for a time he was glad to purchase the restoration of conquered territories by a money payment to his formidable neighbour. His attention was absorbed during Frederick III. a whole decade by the important events in the west which preceded and followed the death of and Burgundy. Charles the Bold. His great desire was to secure the hand of Charles's daughter for his son Maximilian, but he must many times have despaired of achieving his end. In 1473 he evaded by flight Charles's imperative request for a royal title. In the next year he had to raise an imperial army in order to relieve Neuss from the Burgundian besiegers, though he was careful to avoid actual hostilities, and rejected the artful proposals of Louis XI. for a partition of the territories of a common enemy. Yet he used his influence to bring about the war between Charles and the Swiss, which restored to the Hapsburgs their ancient lands in Swabia, and in which Charles met with his defeat and death. Then at last Frederick found his opportunity. Pressed by the selfish aggression of Louis XI., Mary of Burgundy concluded the marriage with Maximilian which had been so long debated, and brought to her husband the great Burgundian inheritance, though the treaty of Arras (1482) shore off some provinces which Louis XI. would not relinquish.

This notable triumph was followed by an equally signal humiliation. The war with Hungary was renewed, and

Mathias Corvinus overran the whole of Austria and great part of Styria and Carinthia. In 1485 Vienna was compelled to surrender, and Frederick III., driven from his capital, was forced to wander as an imperial mendicant from one German monastery to another. Yet the old man never lost his cheerfulness or his confidence in the future. He refused to allow Maximilian to conclude a treaty in which any permanent cession of Austrian territory should be stipulated, and insisted upon waiting for a favourable turn in the course of events. In 1486 he induced the electors to choose Maximilian as King of the Romans, and thus secured the continuance of the imperial dignity in his family. In 1490 Mathias Corvinus died leaving no legitimate heir to continue the line of Hunyadi. Neither Frederick nor Maximilian could secure the succession, and the Hungarian diet offered the crown to Ladislas of Bohemia. But though the extension of Jagellon power was in itself displeasing, the change of rulers enabled the Hapsburgs to recover their losses. In 1491 Ladislas was compelled to sign the treaty of Pressburg, by which all the conquests of Mathias were restored, and it was arranged that on the extinction of his male line his territories should pass to the Hapsburgs. By a series of chances, this condition was actually carried out within the next forty years. But the exertions of Maximilian to extort these terms from the Hungarian king had involved him in a great humiliation in the west. The heiress of Brittany, to whom he had been actually married by proxy, was forced to give her person and her province to the French king Charles VIII., and his only daughter, Margaret, who had been for years betrothed to the latter, was repudiated and sent back to her father. But the wrong brought with it some compensation when Charles VIII., in 1493, found it a necessary preliminary to his Italian expedition to conciliate his injured rival by the restoration of Artois and Franche-Comté. The year before, Maximilian had received Tyrol and Alsace from Sigismund, so that Frederick III. lived to see the Hapsburg

dominions not only reunited in a single line, but vastly extended. For some time he had allowed all power to fall into the hands of his impetuous son, and little interest was aroused in the midst of more exciting events by the news that the old emperor had died on August 19, 1493. For years he had inscribed the five vowels as a mystic sign on all his buildings, books, and ornaments, and it appeared that their significance was *Austria est imperare orbi universo*, or in German *Alles Erdreich ist Oesterreich unterthan*. The implied prophecy was never literally fulfilled, but it came nearer to fulfilment than any contemporary of Frederick III. could have anticipated. And to this result the patient and rather ignoble diplomacy of the long-lived emperor contributed in no small degree.

CHAPTER XVIII

THE HANSEATIC LEAGUE AND THE SCANDINAVIAN KINGDOMS

Relations of Germany in the fourteenth century with Scandinavians and Slavs—The towns of southern and northern Germany—Unions of German merchants abroad—Trade in the Baltic and the North Sea—Alliance of Lübeck and Hamburg—Origin of the Hanseatic League—Aggressions of Eric Menved—Collapse of Denmark and revival of the League—Waldemar III. and the capture of Wisby—The Hanse towns at war with Waldemar—Treaty of Stralsund—The League at the zenith of its power—Queen Margaret and the Union of Kalmar—War between Denmark and Holstein for the possession of Schleswig—Deposition of Eric of Pomerania—Christopher of Bavaria re-unites the three kingdoms—Christian I. of Odenburg and the severance of Sweden from the Union—Karl Knudson and the Stures—Christian I. acquires Schleswig and Holstein—Gradual decline of the Hanseatic League.

THE fourteenth century is not a period to which Germans look back with pride or satisfaction. It produced no great rulers, like the Ottos, or Frederick Barbarossa, or Frederick II., who are the favourite heroes of German history in the middle ages. In their place we have Lewis the Bavarian and his pusillanimous struggle with French popes, Charles IV. with his subtle and cold-blooded policy which has been little understood or appreciated because it produced no great obvious results, and Wenzel, whose drunken incompetence led to deposition and schism. There is an obvious decline of German power and prestige. The crowns of Italy and of Arles confer upon their holder a nominal dignity as unreal as that of the Roman Empire itself. The German kingship

is more substantial, but possesses little efficient authority. The king's influence depends more upon his private territorial possessions than upon his royal position, and his chief interest is in the aggrandisement of his family rather than the extension of the powers of the crown. He cannot extort obedience from his powerful vassals, still less can he defend the distant frontiers of his kingdom.

Yet in spite of the impotence of the central authority, there were two points on the frontier on which the cause of Germany was championed with brilliant though not very lasting success. To the north-west lay the Scandinavian kingdoms of Norway, Sweden and Denmark, of which Denmark was the nearest and for a long time the most powerful. The Danes were of German origin, and for generations they had recognised the overlordship of German emperors. But they had gradually become severed from the southern members of their own race, and their interests and prejudices were in many respects anti-German. Knud VI. (1182-1202) repudiated any allegiance to the emperor, and the break-up of the Saxon duchy by Frederick Barbarossa destroyed the most efficient bulwark of northern Germany against Danish aggression. Geographical position enabled the Danes to claim a control of the Baltic, which more than one king from Waldemar II. (1202-1241) to Waldemar III. (1340-1375) sought to convert into absolute supremacy. Resistance to a design which would have been disastrous to Germany was undertaken, not by the emperors, who showed a curious incapacity to appreciate the importance of the Baltic, but by the famous association of North German towns which is known as the Hanseatic League. Their motive was neither patriotism nor a sense of nationality, but a selfish pursuit of trading interests: nevertheless their action saved Germany from a serious danger.

Farther east was a still greater problem. In the ninth century the whole of the southern coast of the Baltic was inhabited by Slavs, who had displaced the earlier German settlers. With the tenth century began a long struggle on the part of the Germans to

drive back this alien migration, or at any rate to extort submission and the acceptance of Christianity from the conquered Slavs. Thanks to the exertions of two great families, the Welfs in Saxony and the Ascanians in Brandenburg, this task was in great measure accomplished by the thirteenth century. As far as the Vistula German preponderance had been established and secured by the introduction of German settlers and the foundation of German towns. But to the east of the Vistula the struggle was still going on, and it still involved religious as well as political and commercial interests. Here again, as in the north-west, the emperors were absolutely inactive, and the Teutonic Order was left almost unaided to carry on a crusade in Lithuania and Livonia for the extension at once of Christianity and of German civilisation. These two very different corporations, the Hanse towns and the Teutonic knights—with the equally different Swiss Confederation in the south—are in many ways the most interesting developments of German life in an age when Germany as a whole was weak and anarchical.

The towns of Germany developed more slowly than the great Italian republics, and never attained to the same measure of independence or fame. Yet in many respects their history is similar. Both owed their municipal self-government to the weakness of the central authority, and both owed their prosperity to an advantageous position for carrying on trade. The great commercial routes, by which the commodities made or collected in Italy were distributed throughout central Europe, ran through southern Germany, and it was their position on these routes that gave importance to such towns as Ulm, Ratisbon, Augsburg, and Nürnberg. In the north an almost equally lucrative trade was conducted along the shores of the Baltic and the North Sea, and this trade was almost a monopoly in the hands of German merchants. And the northern sailors had another source of wealth in the fishing

industry, which was of special importance in the Middle Ages, when strict rules as to fasting were enforced by the Church. The combination of trade and fishing brought prosperity to the great northern towns of Bremen, Hamburg, Lübeck, Rostock, Danzig, and many others. Between the north and the south lay the great city of Cologne, interested in the southern trade as it found its way along the Rhine valley, and having also a large stake in the commerce with England and other countries bordering on the North Sea. But the real meeting-place of north and south was in the Flemish city of Bruges, whither merchants from all parts of Europe thronged to exchange their respective wares.

The fourteenth century is the golden age of the German towns, the period in which their wealth and political importance were higher than at any other period. But there is a marked and noteworthy distinction between the northern and the southern groups. The great southern cities had many interests in common with each other. They had to resist the growing power of the territorial princes, always jealous of municipal independence; they were eager to put down disorder and private war; and obvious motives impelled them to oppose excessive tolls on roads and rivers and to obtain security for travellers. These interests, and especially the need of police measures to put down robbery or to extort redress, induced them from time to time to form alliances among themselves. But still stronger than community of interest was the jealousy with which the cities regarded each other, and none of these leagues proved lasting. The dominant aim of the southern cities was independence and isolation. In the north the sense of rivalry was equally strong, but the dangers and difficulties were in many ways greater, and thus there was a more powerful impulse towards union. The surrounding states were all of them more backward and less civilised than the Germans; and this gave to the northern towns an infinitely greater political influence than could be exercised

**Distinction
between
northern and
southern
towns.**

by those of the south, which had to deal with powerful and highly developed communities. Hence, while the southern cities could never combine together except for a short time and an immediate object, those in the north gradually formed a league, faulty and ill adjusted in many ways, but which gave its members far greater importance than they could have acquired by isolated action, and even enabled them to play for a short time a dominant part in the politics of northern Europe.

The word 'hansa' is of some importance in the Middle Ages. In its earliest known use it means a band or troop of soldiers. Hence it acquires its later meaning of a union or association, especially for mercantile purposes. It is also used for the charge made by a superior authority for leave to carry on trade. When Henry the Lion wished to encourage trade in his newly acquired town of Lübeck, he authorised foreign merchants to enter and leave it *absque theloneo et absque hansa*, 'without tax or toll.' But its most usual signification is association or guild; the *hansa* is the merchant-guild, the *hans-hus* is the guild-hall. And it is in this sense that it came to be applied to the great *Hansa*, the league of north German towns. The very name expresses the important fact that the league of towns had its origin in a league or leagues of traders.

The whole social and economic life of the Middle Ages is dominated by the principle of association. The village community or manor is the most familiar illustration; the Church with its inner corporations is another. In urban communities we find the same thing. Whoever wished to practise a handicraft must belong to a guild: whoever wished to engage in commerce must enter a trade-guild or *hansa*. The individual was powerless. Only through union with others did he obtain capacity of action and protection for his activity. Any comparison of the modern association with the mediæval union is as a rule superficial and misleading. What is now a matter of use and advantage

was then a matter of necessity, of actual if not of formal compulsion. The essential distinction is to be found in the very limited area of state action in early times. In the Middle Ages the corporation fulfilled most of the duties which the undeveloped state had neither the will nor the power to undertake.

If the home trader required an association, the merchant who journeyed to foreign countries needed one still more.

There were few commission agents in the Middle Ages, and the merchant in person had to superintend the carriage and the sale of his goods. The perils of travelling by land were great; those by sea were far greater. Pirates were almost as numerous and more difficult to resist than land-robbers, and the dangers of navigation were a very serious consideration when sailors had no compass to guide their course, and owners had no system of insurance to cover their risks. It was no wonder that traders desired to travel in considerable numbers in order that perils and disasters might be avoided, or at the worst chronicled. But it was when the merchants reached a foreign soil that the necessity of union became most pressing. It often took a long time to dispose of a cargo; and as winter travelling was considered impossible, it was frequently necessary to spend several months in a foreign land. Hence the merchants combined to acquire joint property in the chief markets they visited: not only inns for personal lodging, but warehouses for the stowage of goods, and harbourage for their ships. These 'factories,' as they were called, became the central point of the union or *hansa* formed by the merchants. The mediæval system of law gave another impulse towards combination. Law in early time was personal, not territorial; it did not apply to all persons on the soil. The guest, as the foreigner was called, if not altogether lawless, was yet at a great disadvantage as compared with the native. Any disputes among the foreign merchants had to be settled among

Unions of
German
merchants
abroad.

themselves and by their own law. In disputes with natives it was difficult for them to obtain justice, unless they could secure some powerful support within the state. To carry on trade at all they required privileges and concessions, which were not easily to be gained by individuals. All these considerations forced the merchants to adopt a corporate organisation. At the head of the *hansa* were elders or aldermen, who administered justice among the members, held assemblies for the consideration of common interests, and represented the community in its relations with the outside world. The more efficient this organisation was, the better able were the merchants to obtain privileges, especially the remission of duties upon trade, from the community with which they had to deal. The new-comer could only share these privileges by obtaining admission to the *hansa*, and for this he had to obtain the consent of the members and to pay a money fee.

The two chief scenes of mercantile activity in the north were the Baltic and the North Sea, connected with each other only by the narrow straits which separate the islands and peninsulas of Scandinavia. The great centre of the Baltic trade was Wisby, the capital of the island of Gothland. So important and flourishing was Wisby in the twelfth and thirteenth centuries that many merchants took up their abode there; and though it remained a part of the Swedish kingdom, it became to all intents and purposes a German town. Thus an important distinction grew up between the German residents in Wisby and the older union of merchants, who only visited the town for purposes of trade. From Wisby factories were organised for the extension of eastern trade. Of these, by far the most important was at Novgorod, which became the great centre of trade with Russia. In the course of the thirteenth century the ascendancy of Wisby in the Baltic was threatened by the rise of a group of towns upon territory which had been won back for Germany from the Wends,

Trade in the
Baltic and
North Sea.

the most westerly of the Slav settlers on the Baltic coasts. These 'Wendish' towns, as they are called, though in population and character they were wholly German, were Lübeck, Rostock, Wismar, Stralsund, and Greifswald; and among them Lübeck, thanks to its advantageous position on the Trave and to the efficient patronage it received, played from the first by far the most prominent part. In the North Sea there were three great foreign markets to which German merchants resorted, and where they formed *hansas* of notable importance. These were Bergen in Norway, London in England, and Bruges in Flanders. For a long time the majority of the North Sea traders came from Cologne, which was as predominant in the west as Wisby had become in the east. But other towns became rivals of Cologne, notably Hamburg on the Elbe, and Bremen on the Weser. Even from inland towns, such as Soest, Dortmund, and Münster in Westphalia, merchants journeyed to the coast and hired vessels for the conveyance of their goods to England or Norway.

It was inevitable that these unions of German merchants in foreign parts should exercise a marked influence upon the conduct of the towns from which they came.

Influence of trade on the relations of the towns.

The merchants were only occasional sojourners in their foreign abodes; the greater part of their lives was spent at home. And it is important to remember that the councils of most of the north German towns were composed almost solely of merchants. Artisans were jealously excluded and looked down upon, and there are few traces of a land-owning nobility in the German towns such as that which played a prominent part in the history of Florence and other Italian cities. Hence the policy of the town councils was guided by the mercantile interests of their members. And the foreign *hansas*, if they failed to gain what they wanted, appealed for support to the towns from which the members came. Thus when merchants were closely associated in trade, their towns were

naturally drawn into co-operation for common interests. This joint action for the furtherance of trade and the protection of the fisheries gave the first great impulse to the formation of town leagues. As long as the Baltic and the North Sea were fairly distinct units, the tendency was to form two or more separate groups. The towns on the North Sea tended to group themselves round Cologne or Hamburg, while in the Baltic one or two leagues might have been formed under the guidance of Wisby or of Lübeck. But a new era in the development of northern Germany set in when the Baltic towns began to encroach upon the North Sea trade, and when Lübeck undertook to dispute the primacy of Cologne in the west, as she had already disputed the pre-eminence of Wisby in the east. The great struggle took place in London. Here German merchants had been active since the reign of Æthelred II., one of whose laws enacts that 'the men of the emperor shall be held as worthy of good laws as ourselves.' These early traders must have come mostly from Cologne, and it was the men of Cologne who formed the first German *hansa* in England. Other merchants had to obtain admission by payment to the *Hansa* of Cologne, and gradually it expanded to admit most of the traders from the Rhine and Westphalia. But natives of other districts found it difficult to gain admission, and when the men of Lübeck appeared upon the scene they set themselves to break down the monopoly of Cologne. In this struggle they had the support of Hamburg, already a serious rival to Cologne, and possessed of a more advantageous site for trade with England. When applicants had money and influence behind them, it was not difficult to obtain concessions from the English government, which found a pecuniary interest in the protection of foreign merchants. In 1266 and 1267 Hamburg and Lübeck were allowed to form *hansas* of their own on the model of that of Cologne. These were not in London, but at Lynn, a favourite port of the Germans on the east coast. In the

early years of Edward I. the three separate *hansas* were fused into a single *Hansa Alamanniæ*, of which we first find official mention in the year 1282. Its members were known to the English as the Easterlings or Osterlings, a name which they afterwards adopted for themselves.

The combination of all German merchants to form a single hansa in England is in many ways a very significant event.

Alliance of Lübeck and Hamburg. It marks a union between Baltic and North Sea traders, which for the first time rendered possible a general league of all the towns of northern Germany. It was brought about by the joint action of Lübeck and Hamburg, and there is a well-founded tradition which attributes to the alliance of these two towns the origin of the Hanseatic League. For free trade between the Baltic and the North Sea it was imperative, if possible, to secure the passage through the narrow channels of the Sound and the Belt. But these were dominated by Denmark, which in those days held not only the peninsula of Jutland and the island of Zealand, but also the southern provinces of what is now Sweden. Geography enabled the Danes either to close the straits or to levy a toll upon the vessels that passed through. Moreover, the great centre of the herring fishery in the thirteenth and fourteenth centuries was the coast of Skaania, on the eastern side of the Sound. Here again the Danes had it in their power to inflict damage upon the German merchants and sailors who flocked to the coast of Skaania during the fishing season. Hence one of the most pressing needs of the north German towns was to protect the straits and the fisheries from Danish aggression, and the lead in this defence naturally devolved upon the two towns which stood nearest to the barrier between the two seas—Lübeck to the east of Jutland, and Hamburg to the west. The two towns were not very distant from each other; and if, at the worst, the passage of the Sound was blocked, a merchant could unlade his goods at either port, carry them overland to the other, and thence renew his voyage either on the Baltic

or the North Sea. The earliest alliance between the two towns had for its object the protection of the roads leading from one to the other, and from this they advanced to common action in England and in Flanders.

It was no wonder that other towns tended to ally themselves with the two cities which could and did render such invaluable services to a cause which was common to all. By the end of the fourteenth century we can find sufficient traces of combination among the north German towns to justify the fixing of this as the date of the origin of the Hanseatic League. Lübeck was the more active and enterprising of the two allies, and had the more commanding position through her intimate connection with the Wendish and other Baltic towns, which were already united together by the acceptance of the Lübeck laws. It was an obvious advantage for German merchants to have a common legal system for the settlement of disputes in which any of them might from time to time be involved; and in spite of the opposition of Wisby, Lübeck had succeeded in procuring the adoption of its code by most of the eastern traders. The hegemony which was thus acquired within a limited area both fitted and encouraged Lübeck to undertake the leadership of a larger and more ambitious combination. It was from Lübeck that invitations were issued to the other towns to send delegates for the discussion of matters of common interests, and many of the early meetings were held within its walls. In 1284 a complaint of injuries received from Norway led to a decision of the towns at an assembly at Rostock to close all export and import trade with Norway until redress had been obtained. It was further determined to cease all intercourse with Bremen if that city should refuse to accept the decision of the other towns. In 1293 a meeting of delegates from the Saxon and Baltic towns resolved that henceforth all appeals from Novgorod should be carried to Lübeck. Wisby was supported only by Riga and Osnabrück in opposing a resolution which recognised the

ascendency of its rival. In 1300 the consideration of commercial grievances in Flanders was undertaken in a general assembly at Lübeck, to which all the north German towns were invited from the mouths of the Rhine to the Gulf of Riga.

By the beginning of the fourteenth century the unions of German merchants in foreign parts had lost their independence, and had become subject to the control and guidance of the towns. But the combination thus created among the towns was in many ways incomplete. There was nothing like a federation involving permanent obligations upon its members. The meetings were only occasional, when any matter requiring settlement arose, and there was a great variation in the number of towns represented, according as the matter was of general or local interest. Within the large area over which the north German trading communities were spread, there were many smaller combinations of towns, connected by joint action in the past, by agreements as to the use of common laws or a common currency, or merely by local contiguity. These smaller associations were older and possessed more consistency than any general league. In fact, such a general league can hardly be said to have come into existence; and so far as it was beginning to grow up, it was concerned solely with commerce, and had no political significance whatever. Some of the towns were free imperial cities, as Lübeck had become on the fall of Henry the Lion, whereas the majority were subject to a territorial prince. Under such conditions an efficient federation for political purposes was impossible. This is illustrated by the history of the early years of the fourteenth century. In 1307 Lübeck, threatened by the neighbouring count of Holstein, appealed for assistance to Eric Menved, king of Denmark, and actually acknowledged Danish suzerainty. Such an act on the part of the most flourishing German city on the Baltic shows how little any sentiment of nationality existed among the citizens. Eric was

**Aggressions
of Eric
Menved.**

emboldened to attempt the recovery of that ascendancy over the Baltic coasts which his predecessor, Waldemar II., had for a time established till it was overthrown at the battle of Bornhöved in 1227. In carrying out his aim he had to subdue the Wendish towns. Rostock and Wismar were compelled to submit, and only Stralsund offered a successful resistance to the Danes. But the striking fact is that the towns rendered no assistance to each other. The whole episode proves that their union was limited to the protection of mercantile interests. As long as the Danish king abstained from any attack upon German commerce, there was no machinery for common action. Still it would seem that the loss of political independence brought with it a diminished ability to act together in any way. For some years after the submission of Lübeck we lose any traces of combination among the north German towns, and the foreign merchants were left once more to protect their own interests without any assistance or any control from the municipalities at home.

But this decline of the towns, which amounted almost to a dissolution of the growing league, was as short-lived as the revival of Danish preponderance on the Baltic. Decline of Denmark. Eric Menved had attempted a task beyond the resources either of his own ability or of his state. His extravagant and reckless policy forced him to purchase support by lavish grants of lands and privileges, and the consequent growth of a powerful nobility in Denmark proved a serious hindrance to later kings. Eric himself died in 1319, and left his brother, Christopher II., to face the troubles for which he had been responsible. Christopher found it impossible to resist the combination of foreign attack with domestic rebellion. The whole of Denmark was lost, either to the native nobles or to German invaders; while Skaania and the adjacent provinces were seized by Magnus of Sweden, who had also obtained the crown of Norway as the grandson of King Hakon. When Christopher died in

exile in 1332 the Danish monarchy seemed for the next eight years to be practically extinguished. The sudden collapse of Denmark restored independence to the Wendish towns, and with it revived the activity of the League. The anarchy and disorder in the north during and after the reign of Christopher II. rendered the duty of defending trade-routes and fishing-stations more imperative than ever. Between 1330 and 1360 we find evidence of more and more regular meetings of the town delegates; and it is in these years that the name of Hansa, hitherto used only for the mercantile unions in England and other foreign countries, came to be applied to the league of towns. In 1358 an assembly was summoned of 'all towns belonging to the Hansa of the Germans,' and the invitation was sent to Cologne and Wisby, to the towns of Brandenburg, Saxony, Westphalia, Prussia, and Livonia. Already, in 1352, Magnus of Sweden speaks of 'the merchants of the sea-towns, called hanse-brothers.' The decrees of the assembly are binding upon all members, and the penalty is expulsion from the League and its privileges. 'If any town of the German Hansa shall refuse to observe this,' says one decree, 'the town shall remain for ever outside the German Hansa, and shall be deprived for ever of German law.' About this time Bremen, which had been excluded ever since the quarrel with Norway in 1284, was restored to membership of the League. Within the wider association, which champions the interests of all north German traders, we find distinct evidence of a recognised division into three parts for more local purposes. The Wendish and Saxon towns under the leadership of Lübeck constitute one division. Another is formed of the eastern settlements in Gothland, Livonia, and Sweden, with Wisby as a sort of capital; while a curious and unexplained combination of Westphalian and Prussian towns are grouped round Cologne. In 1347 it was agreed that each third should elect two elders every year to manage the German depôt at Bruges. Thus by the middle of the

fourteenth century we find that the Hanseatic League has gained a definite organisation, although its functions are still limited to matters of trade, and have no strictly political character. But events were soon to occur which were to try the stability of the League and to give it more political importance than it had yet possessed.

For eight years after the death of Christopher II. Denmark was without a king, but in 1340 Waldemar III., Christopher's youngest son, undertook the task of recovering his father's dominions. He received the assistance of the Wendish towns, which had no interest in the prolongation of anarchy, while they seized the opportunity to obtain a confirmation of their privileges as the price of their help. They even watched with equanimity when, in 1360, he wrested the province of Skaania from the feeble hands of Magnus of Sweden. But they found that success had rendered Waldemar less easy to deal with than he had been in the days of his weakness, and they had to pay a heavy sum for the renewal of their fishing rights. Still, the relations with Denmark were altogether peaceful when, in 1361, the news arrived that a Danish fleet had sailed to the island of Gothland, and that a Danish army had sacked the ancient town of Wisby, whose wealth gave rise to the current phrase that the pigs ate out of silver troughs. The old tradition assigned greed of plunder as the motive for the raid. Later writers have suggested that it was merely the continuance of the quarrel with Sweden about Skaania, or that Waldemar intended to use the central position of Gothland for the purpose of carrying out the ambitious plans of Waldemar II. and Eric Menved.

The delegates of the Hanse towns were assembled at Greifswald when the astounding news arrived. The action of Waldemar created a wholly novel problem for a mercantile association to deal with. Wisby was subject to Sweden, and it was against Sweden that an act of open hostility had been committed. But Wisby was

also a great centre of German trade, its wealth had been created by Germans, and it was one of the chief towns of the Hanseatic League. It was instinctively felt rather than reasoned that it was impossible to allow Waldemar's action to pass without active resentment, and that the League must justify its existence by undertaking new duties and responsibilities. The assembly passed a decree forbidding all trade and intercourse with Denmark, and then adjourned in order to give time for negotiations with Magnus of Sweden and his son Hakon, who had been since 1350 independent king of Norway in his father's place. On September 7, 1361, the second meeting was held, and it was decided to go to war with Denmark in alliance with Sweden, Norway, and Holstein. For the first time a federal tax was imposed, in the form of an export duty of fourpence in the pound, which was to be levied by all the towns until Michaelmas 1362.

The Hanse towns had promised to furnish two thousand men with the necessary ships, and Sweden and Norway were to do the same. In April the Hanseatic fleet sailed to the Sound under the command of John Wittenborg, the burgomaster of Lübeck. The Swedish contingent failed to appear, but the Germans were persuaded by their allies to abandon the projected attack upon Copenhagen and to lay siege to Helsingborg, a strong fortress on the coast of Skaania. Too many of the sailors had been taken from the ships in order to press the siege, when Waldemar suddenly appeared with the Danish fleet. He at once attacked the ships of the League—sunk some, and carried off the rest with their cargoes and the remnant of their crews. Wittenborg had perforce to abandon the siege, and returned home to pay the penalty for failure with his life. The disaster was as terrible as it was unexpected, and the towns considered themselves lucky to be able to conclude a truce in November for fourteen months, during which trade was to be resumed and no new charges were to be imposed by the Danish king. But there was no security that Waldemar would observe

Disastrous
campaign
of 1362.

his promises, especially when he succeeded in depriving the Hanse towns of their allies. Magnus and Hakon had never been eager for the war with Denmark, which was really the work of the nobles in the Swedish Council. The Council had arranged a marriage between Hakon and the daughter of the count of Holstein, but Waldemar seized the lady as she was on her way to Sweden, and kept her a prisoner until the match was broken off. In 1363 he persuaded Hakon to marry his own daughter Margaret, and thus laid the foundation for the future union of the three kingdoms. This marriage was a serious blow to the League, which seemed to be on the verge of dissolution. The Wendish towns had been most active in the war, and would have been the chief gainers by its successful issue. Upon them inevitably fell the chief blame for the disaster. The Prussian towns refused to pay the export duty; they said that they had granted it for the protection of the Sound, but the Sound was now less protected than ever. It was quite useless to make the obvious reply that Lübeck and its neighbours had spent far more and lost far more, and that their losses included men as well as money.

If Waldemar had behaved with statesmanlike prudence and moderation, he might have permanently weakened, if not destroyed, the League, which was the chief **Temporary** obstacle in his way. If once the more distant **peace.** towns had been convinced that their interests in Danish waters were as secure after defeat as they had been before, they would hardly have adhered to an alliance which proved costly as well as useless. But Waldemar was eager to deprive the German traders of all the privileges they had obtained through the weakness of Denmark since the days of Eric Menved, and this danger served to keep the Hanse towns together in spite of their discouragement and their quarrels with each other. Before the truce had expired, Waldemar set out at the end of 1363 on a long tour to the principal courts of Europe. During his absence the Danish Council agreed

to prolong the truce, but it seemed almost impossible to arrange any permanent peace upon terms that the German merchants could accept. It was still doubtful whether the towns would give way or venture on a renewal of hostilities, when events in Sweden compelled the Danes to moderate their demands. The Swedish nobles had long been alienated by the feeble government of Magnus. They had resented the loss of Skaania and the humiliating conquest of Gothland. Their fierce indignation was roused by the change of policy in 1363, when the Holstein alliance was abandoned and Hakon was married to Margaret of Denmark. In 1364 they declared Magnus deposed, and elected in his place Albert, the second son of the duke of Mecklenburg, and of Euphemia, a sister of Magnus. The elder brother was passed over because he had married Ingeborg, another daughter of Waldemar III., and the Swedes would have no connection with Denmark. A civil war followed, in which the forces of Magnus and Hakon were defeated, and the former was taken prisoner. The greater part of Sweden acknowledged Albert. When Waldemar returned from his travels, he found his plans checkmated by this Swedish revolution, and resolved to overthrow the new dynasty in alliance with his son-in-law Hakon. In order to prepare for this new war, he concluded the treaty of Wordingborg in September 1365 with the Hanse towns. Freedom of trade through the Sound and a confirmation of German privileges on the coast of Skaania were granted, but only for a period of six years. It was obviously a truce rather than a real treaty; neither side was satisfied with its terms; and the inevitable struggle between Danish and German interests in the Baltic was only postponed.

That Waldemar, in attacking the new king of Sweden, was influenced by wholly selfish motives, is proved by the treaty which he concluded in July 1366 with the duke of Mecklenburg. In return for the formal cession of Gothland and other considerable territories, he abandoned the cause of Magnus and Hakon, and agreed to recognise

Second
Danish war.

and support Albert and his successors in the remaining provinces of Sweden. This unprincipled policy raised Denmark to a greater height of power than it had reached since the days of Waldemar II. Emboldened by success, the king did not scruple to break his recent agreement with the Hanse towns. In the course of 1367 several German ships were seized and plundered in the Sound, and increased tolls were levied upon vessels resorting to the coast of Skaania for the fishing season. Even the distant south-western towns, which had taken hardly any part in the previous war, felt that these outrages were intolerable, and clamoured for active measures in defence of their trade and industry. It is significant of the greater unanimity of the League on this occasion that the decisive meeting was held, not as usual in a Baltic town, but at Cologne. There in November 1367 it was decided to go to war with the Danish king; and if any town should hold aloof from the common cause, 'its burghers and merchants shall have no intercourse with the towns of the German Hansa, no goods shall be bought from them or sold to them; they shall have no right of entry or exit, of lading or unlading, in any harbour.' A new export duty was imposed for a year, and the sum raised was to be divided among the towns in proportion to the contingent which each furnished. To avoid the quarrels which had followed the last campaign, it was expressly enacted that no injury or loss on the part of any town should give it a claim upon the others for compensation. All privileges or other advantages which should be gained in the war were to belong equally to all the members of the League.

It was a formidable array of enemies that Waldemar had to face in 1368. His treaty with the duke of Mecklenburg had come to nothing, because the Swedes re- Triumph of
the League. fused to sacrifice their own interests to their new dynasty, and would not surrender the stipulated territories. So Waldemar had to renew both the alliance with Hakon and the war with Albert of Sweden. On the mainland both

Mecklenburg and Holstein were on the side of his enemies, the nobles of Jutland were on the verge of rebellion, and now he had provoked the Hanse towns to a new campaign. In the presence of these dangers he adopted an extraordinary course of action. In April 1368 he placed all his accumulated treasure upon a ship, and sailed to Pomerania, leaving the Danish Council to govern the kingdom during his absence, and to carry on the war which he had provoked. For two years he wandered about Europe from one court to another, while his dominions were overrun by his enemies. The Hanseatic fleet appeared in the Sound soon after the king's departure, and at once attacked Copenhagen. The town was taken and destroyed, and the fortress was occupied by a German garrison. From Zealand the victorious traders turned to Skaania, and by the end of the year every fortress, except the redoubtable Helsingborg, had fallen into their hands. It was decided to keep their forces in the field during the winter and to prolong the tax on exports for another year. In 1369 Helsingborg surrendered after an obstinate resistance, and the Danes, attacked also from Holstein and Mecklenburg, opened negotiations with the Hanse towns. Hakon of Norway had already concluded a truce by which all the rights and privileges of German merchants in his kingdom were confirmed. On **Treaty of Stralsund.** May 24, 1370, the Treaty of Stralsund put an end to the Danish war. For fifteen years all the castles and fortified places on the coast of Skaania were to be held by the League, which was to receive two-thirds of the revenue of the province in order to cover the cost of their maintenance. These terms, which transferred the control of the Sound and its fisheries from Denmark to the Hansa, were to be confirmed by Waldemar as the condition of his return to his kingdom. No future king was to be placed on the Danish throne without the consent of the Hanse towns and until he had confirmed all their privileges and concessions.

The second Danish war marks an important epoch in the history of the Hanseatic League. Not only was it raised to the position of an influential power in northern Europe, but its whole character had undergone an important change. Hitherto it had been a mercantile league for the extension and strengthening of trade privileges, and for the settlement of trade disputes. The decisions of the Cologne assembly in 1377 had super-added to this mercantile association a political and military alliance. It is true that that alliance was in express terms only temporary and for the achievement of an immediate object—the protection of the narrow waters from outrage and oppression. But the new obligations which success brought to the League gave to the Cologne decrees a more permanent importance than had been contemplated at the time of their adoption. The occupation of the forts on the Sound conceded by the treaty of Stralsund, and the necessity of constantly watching the changes and struggles in the Scandinavian kingdoms—a necessity which was all the more pressing after the Union of Kalmar—compelled the League to maintain an armed force in constant readiness, and to continue the collection of a federal revenue for military purposes. When new towns applied for admission to the League, and there were many such applications in the years following the Treaty of Stralsund, they had to accept, not only the old conditions as to trade, but also the more stringent obligations imposed by the assembly at Cologne. Thus the League became more concentrated and more highly organised than it had been before the war. The federal assemblies were more frequent, and their sessions were longer and more full of business. Every year there was a general assembly at midsummer, but there were also frequent provincial meetings, especially of the Wendish towns, which continued to form the most central and the most influential unit within the League. And not only was the external activity of the League greater, but it began to concern itself with the in-

The League
at the zenith
of its power.

ternal affairs of its members. In the fourteenth century the ascendancy of the merchants in municipal government was threatened by the rise of the artisans in Germany, as it was in Florence and other southern towns. The Hanseatic League, essentially mercantile in its origin and its aims, naturally made itself the champion of the old exclusive oligarchy. In 1374 a rising took place in Brunswick against the ruling council: some of its members were executed, and the rest were driven into exile. For this offence Brunswick was formally expelled from the League, and its merchants were excluded from all the markets under its control. This mercantile excommunication was now a formidable weapon, and the men of Brunswick had to make humble reparation for their democratic aspirations before they could obtain their readmission to the confederacy. But in emphasising the greater unity and greater influence of the League after its victory over Waldemar III., it is imperative to remember that there were several defects and weaknesses in its federal constitution. The very wide extent over which the towns were spread, from the Scheldt to the Gulf of Finland, and the jealousy which mercantile rivalry must almost inevitably create, rendered any complete real unity of interest and purpose almost impossible. There was never any assembly at which all the towns were represented, and, in fact, it would be difficult to give a precise enumeration of the members of the League at any given date. Sometimes several towns would combine to give authority to a single delegate, but no town considered itself bound to take part in the meeting. Not infrequently the delegates would declare that their instructions did not allow them to consent to a proposal, and that they must refer the matter back to their respective town-councils. Hence arose uncertainty and delay. But the chief defect was that membership of the League was not and could not be the only political obligation of the towns. Most of them were subject to some immediate authority, usually that of a territorial prince. Thus they had

a double allegiance, and the two might come into collision with each other. The princes might allow their towns to gain trading privileges by joining the League, but they were not likely to consent to any diminution of their own authority. Under such conditions it is wonderful that the League held together as long as it did.

The increased dignity and importance of the Hanseatic League after the Treaty of Stralsund are illustrated by the action of the emperor. Charles IV., as is shown in the Golden Bull, disapproved of confederations of towns and of the rapid growth of municipal independence. Waldemar III. was his personal friend, and during the recent war the emperor had more than once endeavoured to use his influence in behalf of the Danish king. But in 1373 Charles had obtained Brandenburg from the last Wittelsbach Margrave (see p. 120), and thus acquired a new interest of his own in the politics of northern Germany. He was now eager to conciliate the League and to obtain the privileges which it could give to the towns of his new dominion. In 1375 he left Prague to pay a visit to Lübeck, where the magnificence of his reception made a profound impression on contemporaries. Tradition declared that he began his speech in acknowledgment of civic hospitality with the words 'My Lords'; and when the burgomaster shook his head to deprecate such a title, the emperor continued: 'You are Lords! The old imperial registers prove that Lübeck is one of the five chief towns of the empire; that your city councillors are also imperial councillors; and that they may enter his council without waiting for his permission.' The chronicler complacently adds that the five chief towns were Rome, Venice, Pisa, Florence, and Lübeck.

The Treaty of Stralsund was followed by a general restoration of peace in the north. Waldemar III. returned to his kingdom, and obtained the restoration of the Mecklenburg conquests by a treaty with Duke Albert, who had established one son on the throne of Sweden,

Charles IV.
and the
League.

Death of
Waldemar III.

and now hoped with Waldemar's support to gain Denmark for his grandson. In 1371 the long strife between Sweden and Norway came to an end. On condition that Magnus and Hakon should abandon all claims to the Swedish crown, Albert agreed to release the former from his imprisonment and to allow him an annual income till his death, which occurred three years later. The most pressing question in the north was the succession to Waldemar in Denmark. His only son had died in 1363, so that Waldemar was the last male of his dynasty. Of his two daughters who had lived to become brides, the elder, Ingeborg, had married Henry of Mecklenburg, the elder brother of the reigning king of Sweden, and the younger, Margaret, had married Hakon of Norway. Thus the choice lay between two children—Albert, the son of Ingeborg and Henry, and Olaf, the son of Hakon and Margaret. The Mecklenburg claimant was recognised as his heir by Waldemar, and had the support of the Emperor Charles IV. and of the powerful count of Holstein. But the Danes had not forgotten the rule of the German invaders in the time of Christopher II.; and when Waldemar died in 1375, they elected the five-year-old Olaf as his successor. Both by treaty rights and by actual power the Hanse towns were entitled to a voice in the decision, and they seem to have preferred the possibility of a union between Denmark and Norway to an extension of the already formidable power of the House of Mecklenburg. Olaf was acknowledged by the League, and one of his first acts was to confirm the provisions of the Treaty of Stralsund.

In 1380 Hakon of Norway died, and Olaf wore his father's crown in addition to that of Denmark. During his minority his mother Margaret ruled in both kingdoms. In 1386 she found it necessary to conciliate the count of Holstein by the cession of Schleswig, which was to be held as a fief of Denmark; but in other respects her government was so successful, that on

Queen Margaret and the Union of Kalmar.

her son's death in 1387 she was invited to succeed him by the Danes and Norwegians. At the same time she received an offer of the crown of Sweden. The government of Albert of Mecklenburg, who had rewarded his German followers with lands and offices, had excited great ill-will among the Swedish nobles, whose power was more than a match for that of the king. The conquest of the distracted kingdom proved a comparatively easy task. At Falköping in 1389 Albert was completely defeated, and after seven years' imprisonment he could only procure his liberty by abdication. Stockholm, aided by forces from Mecklenburg, held out for some years; and the famous association of the *Vitalien-Brüder*, or 'Victualling Brothers,' originally formed for its relief, became a formidable body of pirates in the Baltic. The interference which they caused to trade induced the Hanse towns to employ their mediation in favour of Margaret, who became queen of the three Scandinavian kingdoms. Her great ambition was to render this union permanent. As she had no surviving child of her own, she adopted Eric of Pomerania, the grandson of her sister Ingeborg. In 1397 she convened the councils of the three kingdoms to Kalmar, and induced them to agree to a formal act of union. The three kingdoms were to be irrevocably united under the same king, and the election of successors to the crown was limited to the descendants of Eric. Each state was to retain its own laws and institutions, but treaties with foreign powers were to be binding upon all. The arrangement had one obvious defect. No single electing body was created; and if each kingdom could choose a king, even within the limits of a single family, there was no security that their choice would fall upon the same person.

The fifteenth century was a troubled period in the history of northern Europe, but its events are far less interesting and far less important than those of the fourteenth century. There were two great questions at issue: Whether the Union

of Kalmar could be permanent, and whether the Hanse towns could retain either their unity of action or the preponderance in the north which it had given them. Both questions remained in doubt during the century, but ultimately both were answered in the negative. To maintain the union of the three Scandinavian kingdoms, which had no great love for each other, while in two of them a powerful noble class had obtained a considerable measure of independence, would have required either exceptional good fortune or exceptional ability, and the successors of Margaret had neither. Even the 'Union Queen' herself made a serious blunder in her later years. Count Gerhard of Holstein, to whom she had granted Schleswig, as a hereditary fief, died in 1404, leaving a young son Henry to succeed him. Encouraged by her previous triumphs, Margaret could not resist the temptation of trying to escape from the bargain she had made in 1386, and to gain Schleswig for the crown. Various claims to the duchy were put forward on behalf of Denmark, but the Schauenburg princes were resolute in support of Gerhard's son. The struggle lasted for thirty years, and in the course of it most of the north German states became involved. Margaret died suddenly in 1412, but Eric of Pomerania continued to maintain the claims which his great-aunt had put forward with the mingled obstinacy and violence which marked his character. The authority of the king of the Romans was called in to settle the dispute, and twice Sigismund gave a formal decision in favour of the Danish crown. But as had happened more than once before, the Hanseatic League showed a greater regard for the interests of Germany than the German king. Hamburg, closely associated with Holstein, from the first supported the House of Schauenburg, and gradually Lübeck and the other Hanse towns were involved in the war against Eric. Their intervention, combined with disturbances in Sweden, turned the balance; and in 1435 Adolf of Holstein, who had succeeded

War be-
tween Den-
mark and
Holstein.

his brother Henry in 1428, was recognised as duke of Schleswig.

The war with Holstein was not only unsuccessful, it also involved Eric in serious domestic difficulties. Sweden and Norway, which required the constant attention of ^{Deposition} the king, were left unvisited and unregarded. In ^{of King Eric.} Denmark, Eric could only induce the nobles to serve in a war in which they had little interest by lavish concessions which further weakened the royal authority. In all the kingdoms discontent was excited by increased taxation and by debasement of the coinage. Another grievance was furnished by Eric's partiality for his Pomeranian relatives, and his avowed desire to secure the succession to his cousin, Boguslav. In 1434 the first rising took place in Sweden among the peasants of Dalecarlia, but Eric succeeded in conciliating Karl Knudson, the leader of the nobles, who was appointed Marshal of the kingdom, and in 1435 the Union of Kalmar was confirmed by the Swedish diet. But the king's neglect of the duties of government had become intolerable, and in 1439 he was formally deposed by the Danish Council. As neither of the other kingdoms had the slightest desire to support Eric, this act rendered vacant the three Scandinavian thrones. The deposed king lived for another twenty years, but he never had any chance of recovering the dignity he had forfeited.

The Danes proceeded in 1439 to offer the crown to Christopher of Bavaria, whose mother was a sister of Eric, and he accepted it upon conditions which ^{Christopher} narrowly limited the royal power. One of his ^{of Bavaria.} first acts was to settle the dispute about Schleswig by confirming the duchy to Adolf of Holstein as a hereditary fief. The action of Denmark had no binding force upon the other kingdoms, but lavish bribes to Karl Knudson and the clergy purchased the acceptance of the Swedish diet; and Norway, which had shown less enmity to Eric than the other states, was induced to follow the example of its neighbour.

In 1442 Christopher was recognised in the three Scandinavian kingdoms, and the Union of Kalmar was continued for another generation. In 1446 he strengthened his position by marrying Dorothea of Brandenburg, but no heir had been born to continue the Bavarian dynasty, when Christopher was carried off by a sudden death in January 1448.

With the death of Christopher the severance of the kingdoms seemed to be inevitable. There was no obvious heir to any one of them, and it was hardly possible that they should combine to find the same successor. Sweden and Denmark were the first to act, and neither paid the slightest regard to the proceedings in the other. In Sweden there was a strong party hostile to the union; and an organised demonstration on the part of the mob led to the hasty election of Karl Knudson, who had been for years the most powerful and wealthy noble of the kingdom (June 1448). Meanwhile the Danes had offered the crown to Adolf, count of Holstein and duke of Schleswig. He refused the offer, but suggested the choice of his sister's son, Christian of Oldenburg, who could claim descent from a daughter of Eric Glipping, the predecessor and father of Eric Menved. Christian was accepted, but the conditions which were imposed upon him gave the chief control of the government to the council of nobles. And he also had to pay for his uncle's support by a formal document, in which assurance was given that the duchy of Schleswig or south Jutland 'shall never be united or annexed to the kingdom of Denmark, so that one person shall be lord of both.' In Norway, less energetic and independent than the other two kingdoms, there was a prolonged struggle as to whether the Danish or the Swedish king should be chosen. Karl Knudson believed that he had assured his own election, and he actually assumed the crown in Trondhjem, but the party which supported the Danish connection proved the stronger, and in August 1450 the diet decreed the permanent union of Denmark and Norway.

Denmark and Norway remained united under the Oldenburg dynasty until the latter was combined with Sweden by the decision of the allies in 1815. It would probably have been better if Christian I. had abandoned all idea of recovering Sweden. But the Union of Kalmar was not to perish without giving rise to a long and exhausting struggle. Many of the Swedish nobles were jealous of the elevation of Karl Knudson to royal rank, and the archbishop of Upsala headed an opposition party which appealed for Danish intervention. Christian could not resist the temptation of gaining a third crown. In 1457 Karl Knudson was forced to flee to Danzig. Christian was crowned at Upsala, and his son John or Hans was acknowledged as his heir. This success was followed by another conspicuous triumph. In 1459 the death of Adolf of Holstein and Schleswig extinguished the male line of the chief branch of the House of Schauenburg. Christian could advance a double claim to the vacant county and duchy. He was the nearest relative of his uncle Adolf on the female side, and he could contend that Schleswig as a Danish fief escheated to the overlord on the extinction of the family to which it had been granted. On the other hand, the surviving Schauenburg princes claimed to be the nearest male heirs, and they could point to Christian's own pledge in 1448 that Schleswig should never be united to the Danish crown. The dispute enabled the estates of the two provinces to exercise powers which had never hitherto belonged to them. On condition that Schleswig and Holstein should remain united, and that they should be free to elect any member of the family and not be bound to take the successor to the Danish throne, they accepted Christian as duke and count in March 1460. The Schauenburg princes were bought off by a money payment. In 1479 the Emperor Frederick III. raised Holstein from a county to a duchy, and granted the formal investiture to Christian I.

Good fortune had suddenly raised the House of Oldenburg

to an extraordinary preponderance of territorial power in the north. No previous ruler had succeeded in uniting the three Scandinavian kingdoms with two considerable provinces on the mainland. But the real strength of Christian I. was in no way proportioned to its appearance. He had purchased every state by concessions which sapped the very foundations of the central authority. In Sweden especially his kingship was merely nominal. The strong national sentiment of the Swedes objected to the Union of Kalmar because, in spite of stipulated equality, it made their state little more than a province of Denmark. The archbishop of Upsala, whose quarrel with Karl Knudson had given the crown to Christian, was really more powerful than the king. Disputes were inevitable, and in 1467 Karl was invited to quit his exile in Danzig and to resume possession of the crown. On his death in 1470, his nephew, Sten Sture, was proclaimed regent of Sweden. Christian led an army to compel his submission, but was completely defeated and driven from the kingdom. For the next half century a succession of Stures ruled Sweden in practical independence.

Sweden was not the only territory that was lost to Christian I. In 1469 his daughter Margaret was married to James III. of Scotland; and the Orkneys and Shetlands, which had been in the hands of Denmark since the tenth century, were pledged to the Scottish king as security for the princess's dowry. As the pledge was never redeemed, the islands were to all intents and purposes ceded to Scotland. The death of Christian in 1481 left his dominions to his eldest son John. The new king was weakened by having to divide Schleswig and Holstein with his younger brother Frederick, and by an unsuccessful war which he carried on to extort the submission of the independent peasants of Ditmarsh. Thus though he was able for a time to recover Sweden and to assume the crown, he could not retain his hold upon the kingdom. Sten Sture regained the government in 1500, and after his death it was transmitted to his successors, Svante Sture and a

younger Sten. The desperate effort of the next Danish king, Christian II., to restore the Kalmar Union, and the cruelty which he displayed in the famous 'blood-bath of Stockholm' only led to the final vindication of Swedish independence by Gustavus Vasa.

Meanwhile the fifteenth century had been a period of difficulty and stress to the Hanseatic League. The Union of Kalmar in itself constituted a serious danger to the north German towns. The privileges which they had extorted from the Scandinavian rulers amounted to a practical monopoly of trade and fishing rights along their coasts. The obvious interest and duty of a really strong ruler would impel him to repudiate such restrictions on the freedom of his subjects. Fortunately for the League, the Union was never much more than nominal. The policy of the Wendish towns was steadily directed to place difficulties in the way of the Scandinavian rulers, and to encourage every tendency to independence in the subject provinces. Thanks to the weakness of the successive kings and the turbulent opposition of the Swedes to the Union, this policy was successful, and the Hanse towns were enabled to retain for a time their political and mercantile ascendancy in the north. But in spite of this the century was on the whole a period of decline in the history of the League. The weaknesses which were inherent in the coalition from the first became more and more visible. Foreign competition, especially that of the English, was a constant and increasing source of trouble. In the fourteenth century the Germans still had a preponderant share of the import and export trade of England. In the fifteenth century the native traders steadily set themselves to get the better of the privileged foreigners, and by the reign of Henry VII. the English had established a considerable direct trade, not only with Flanders and Norway, but also with the countries on the Baltic. But foreign competition was a less serious danger than internal weakness

Gradual decline of the Hanseatic League.

and disruption. In the course of the fifteenth century a notable change began in the balance of northern trade. At first the western towns of the League had been for the most part engaged in trade in the North Sea, whereas the eastern towns had carried on their trade in both the North Sea and the Baltic. In the fifteenth century the western towns, and especially those of the Netherlands, began to encroach upon the Baltic trade, and entered into rivalry with Lübeck, Rostock, Stralsund, and Danzig. This growing importance of the western and non-Baltic merchants was completed by two changes which could neither be foreseen nor controlled. For more than a century the gregarious herrings had made the coast of Skaania their favourite summer resort, and in consequence this had been the scene of the largest and most lucrative fishing industry in Europe. In the middle of the fifteenth century the fish made one of those sudden and inexplicable changes of habitat, which have more than once affected the economic relations of the northern states. They ceased to enter the Baltic in any large numbers, and transferred themselves to the coast of Holland. The privileged position in Skaania for which the Hanse towns had struggled so long and so successfully became all at once almost valueless, and the gains of the Dutch were measured by the losses of the Wendish and other Baltic towns. This change was followed by the geographical discoveries which began at the end of the century. These had the effect of transferring the great trade routes from European waters to the outlying oceans, and this proved as fatal to the towns on the Baltic as it was to those on the Mediterranean.

Commercial jealousy and the growth of wholly separate interests of their own impelled the towns of the Netherlands to independent political action, which in the end led to the severance of their connection with the League. Thus in the war waged by King Eric to gain possession of Schleswig the chief Hanse towns supported Holstein, but the Netherlanders sent assistance to Eric in order to gain a share in those

commercial privileges in the Scandinavian kingdoms which Lübeck and its immediate associates tried to keep in their own hands. Also it must be remembered that the Netherlands became less German as they fell under the rule of the Valois dukes of Burgundy. There was no formal rupture of vassalage to the empire, but practically there was complete independence of control, and the new rulers directed the conduct of their subjects to suit their own ends. This points to the fundamental weakness of the Hanseatic League, which led to its gradual dissolution in the course of the next century and a half. If Germany could have been made into a single united state, the League, as the champion of common German interests, might have had a prolonged existence. But Germany became a very loose federation of territorial princes, and in such a state there was no room for an active and efficient league of towns. The local prince would not allow the burghers within his dominions sufficient independence to make their membership of such a league a reality. As the provinces became more compact, the towns were withdrawn from their federal allegiance and tied down to their direct duties as subjects of the prince. This gradual process destroyed the Hanseatic League. A few imperial cities, as Lübeck, Hamburg, and Bremen, retained the name of Hanse towns till the present century, but the name was used to express independence rather than union.

CHAPTER XIX

THE TEUTONIC ORDER AND POLAND

Foundation of the Teutonic Order—Struggles of Germans and Slavs in the Baltic provinces—The Knights are invited to Prussia—Their conquests—Quarrel with the Papacy and complete transfer of the Order to Prussia—Further territorial acquisitions—The Order at the height of its power under Kniprode—Union of Poland and Lithuania—The Battle of Tannenberg—Decline of the Order—Internal discontent and disorder in Prussia—The Prussian League—Civil war and Polish conquest—The Peace of Thorn—End of the Teutonic Order and of the Order of the Sword.

THE great Emperor Frederick Barbarossa died in Asia Minor as he was leading his forces to take part in the Third Crusade. The German army broke to pieces after the loss of its leader, and only a few scanty fragments reached Palestine to take part in the siege of Acre (1189). The besiegers were decimated by the diseases to which troops are liable in an unaccustomed climate, and complaints were made that the German sick were neglected in such scanty hospital arrangements as then existed. Under the pious care of some merchants from Lübeck and Bremen, an order was formed to combine the functions of soldiers and nurses. The 'German Knights of St. Mary' borrowed most of their rules from the Hospitallers or Knights of St. John, but some of their military regulations were adopted from the still more famous Order of the Temple. In 1191 the new crusading order received a bull of confirmation from Pope Clement III., and the first grand-master fixed his headquarters in Acre, which had now fallen before the assaults of the Crusaders. Its origin and its peculiarly

national character were emphasised by the limitation of membership to men of German birth and speech. Like the Templars and Hospitallers, the Teutonic knights were the recipients of numerous gifts and bequests from pious benefactors, and acquired considerable estates in western Europe. But crusading ardour had begun to decline in the West, and the Germans had never taken quite as prominent a part in the movement as the Romance nations. If the activity of the Teutonic Order had been confined to Palestine, it is not likely that its existence could have been either prolonged or important. But within forty years from its foundation a new sphere was provided for its military exertions.

By the end of the twelfth century immense strides had been made by Christianity and German civilisation among the Slavonic peoples to the south of ^{Germans} and Slavs. the Baltic. Bohemia and Poland, the two outposts of the Slavs to the south-west, had been converted and brought into some sort of submission to the German Emperors. Their most thriving towns were filled with German settlers; and some of the border provinces, such as Silesia, had already received a preponderantly German element in their population. To the north-west the efforts of Henry the Lion and Albert the Bear had conquered and converted the Wends; Lübeck and other towns had been founded to serve as centres of German commerce and German influence; and bishoprics had been created for Mecklenburg and Pomerania. But from the valley of the Vistula to the Gulf of Finland there stretched an immense tract of dreary country, alternately sandy wastes and undrained marsh, in which a number of Slavonic peoples—Prussians, Lithuanians, Esthonians, and Livonians—still lived their primitive life, engaged in hunting, pasture, and rudimentary agriculture. They retained their heathen religion and their ancient customs, and were regarded by their more advanced neighbours as little better than savages. In the tenth century St. Adalbert of Prague had met with a martyr's death as he sought to preach the Gospel

to the Prussians, and ever since there had been a nominal bishopric on the eastern Baltic, but its holders had never ventured to reside in their diocese.

In the thirteenth century a vigorous effort was made to extend Christianity among these eastern Slavs. The Bishop of Riga founded in 1200 the Order of the Sword to compel the acceptance of the faith by the people of Livonia. Soon afterwards Christian, a Cistercian monk of Oliva, undertook to preach the Gospel among the Prussians. The Pope gave him the title of Bishop of Prussia; and a Polish duke, Konrad of Masovia, who claimed the border district of Kulm, promised him active assistance. But the task proved beyond the powers of duke and bishop. The Prussians rose against the intruders, destroyed their settlements, and carried fire and sword into the Kulmerland and Masovia itself. This war between the Christian and the heathen Slavs gave occasion for the introduction of the Teutonic knights into Prussia. In 1226 an embassy from Konrad of Masovia appeared before the grand-master in Italy, and offered to cede the Kulmerland if the Order would undertake to defend him from the Prussians.

Hermann von Salza, who was grand-master at the time, was an intimate adviser of the Emperor Frederick II., who had given the black eagle of the empire as the Order's standard, and a man of no small importance in the politics of southern Europe. Endowed with equal energy and foresight, he welcomed the opportunity of founding a new Christian state in the north, where greater security and distinction could be gained than in upholding a losing cause in the Holy Land. But he had no intention of fighting the battles of the Polish duke or the Prussian bishop without adequate reward, and he took the most painstaking precautions to secure the independent rule of the Order in what was destined to be its future home. Frederick II., who knew little and cared less about the fate of the Baltic provinces,

Teutonic
knights
invited to
Prussia.

was easily induced to grant to the Order a formal investiture of the district of Kulm with all future conquests in Prussia. This was followed by treaties with the Duke of Masovia and with Christian of Oliva, whose original alliance had been broken by their rival claims to suzerainty; and finally, to remove any difficulties with Rome, Pope Gregory IX. was persuaded to claim the lands of the heathen as the property of St. Peter, and to grant them to the Order on payment of a nominal tribute (1234).

In 1231 the first detachment of Knights entered Prussia and commenced the work of conquest. In spite of their smaller numbers, their superior arms and discipline gave them an immense advantage over the disorderly hordes which opposed them. As each district was reduced to submission, a fortress was built to enforce obedience and to serve as a base for further operations. Thus, in the first few years, Thorn, Kulm, and Marienwerder were built and garrisoned in rapid succession. In 1237 the Knights of the Sword agreed to form a close alliance with the Teutonic Order, of which they became a subordinate branch, though retaining a considerable measure of autonomy. Thus the heathen were threatened with attack on both sides—on the west from the valley of the Vistula, and on the north-east from Riga and the coast of Livonia. But the rapid successes of the Knights provoked jealousy and opposition. The Poles were indignant at the establishment of a German state between their own borders and the Baltic, and political and race antipathy soon overpowered the original alliance on religious grounds. Konrad of Masovia bitterly repented his shortsighted cession of Kulmerland, and both from Poland and from Pomerania aid was sent to the heathen Prussians. Even the bishop, Christian of Oliva, was alienated by the Order's assumption of ecclesiastical independence, and did his utmost to enforce his own claims to superiority in the conquered districts. But the Papacy remained loyal to the warrior priests, whom it regarded as

submissive vassals. The usual indulgences were offered to all who would undertake the pious duty of joining a crusade against the heathen, and crowds of recruits were induced to secure their temporal prosperity and their future salvation by fighting in the service of the Knights. The most famous of the princely allies was Ottokar of Bohemia, the lord of Austria, and the most powerful of German princes in the middle of the thirteenth century. In 1255 he led a large army into Prussia, and the fortress of Königsberg was named in his honour.

But the conquest of Prussia was not achieved without difficulties and reverses. In 1260 a general rising was organised among the Slav population, and for the next ten years the Knights were in serious danger of losing all they had gained. But their dogged resolution prevailed in the end, and by 1280 the land had once more been forced into sullen submission. The desperate struggle had seriously diminished a population which was always thinly scattered over a huge area. To fill the place of those who had fallen or had migrated eastwards to preserve their independence in Lithuania, the Order encouraged the settlement of German peasants and German burghers. The conquest of Prussia was a victory for Germany as well as for Christianity. The Slavs had to accept the religion and the language of the conquerors.

The end of the thirteenth century ushered in a period of **Quarrel with the Papacy.** trial for the great crusading orders. The fall of Acre in 1291 marked the ultimate failure of the attempts to recover the Holy Land for Western Christendom. The military associations were discredited by their ill-success; and while they lost their hold upon popular favour, their immense wealth excited the avarice of the temporal princes. The Papacy had fallen from the lofty position which it had held in the time of Innocent III., and was forced to become the accomplice and the agent of the royal spoilers. The Templars were first persecuted and then suppressed by

Philip iv. of France and his creature Pope Clement v. The Knights of St. John only escaped a similar fate by throwing themselves into Rhodes, and by holding the island as a bulwark of Christendom against the encroaching Moham-medan power. The position of the Teutonic Order was as insecure as that of their older and, for a time, more prosperous rivals. The grand-master had removed his headquarters from Acre to Venice, and thence could watch the approach of danger. When, in 1309, Clement v. issued a hostile bull against the Order, the Knights were prepared with a practical and efficient answer. The only way to prove their strength and their value to Europe was to concentrate their undivided energies upon the work which had been undertaken on the Baltic coast. The hostility of a distant Pope would there be comparatively impotent, and they could strengthen themselves by a close alliance with the interests and forces of Germany. It was, no doubt, a great sacrifice for the Knights to abandon a residence in southern Europe, where they had enjoyed considerable wealth and influence, and to bury themselves in a remote and barbarous district in the inclement north. But there was no other alternative if they would escape destruction; and in 1309 the grand-master transferred his residence from Venice to Marienburg, which became henceforth the headquarters of the Order.

Transference
of the Order
to Prussia.

The severance of the Teutonic Order from all connection with Palestine and its concentration in Prussia had many important results. The close connection which had hitherto been maintained with the Papacy was weakened, and the ties with Germany and the Empire were drawn closer. Henry vii. hastened to assure the Knights of his protection and to confirm their rights and privileges. Hitherto they had conquered in the name of the Church, henceforth their triumphs are to be for the extension of Germany. And these triumphs were for a time proportioned to their increased unity and strength. In 1311, by dexter-

Acquisition of
Pomerellen.

ously taking advantage of a dispute between Brandenburg and Poland, they seized the district of Pomerellen on the left bank of the Vistula, which contained the important city of Danzig. This acquisition enormously strengthened the position of the Order on its western or German border; but, at the same time, it led to the long and desperate struggle with Poland which ultimately brought disaster in its train. And the conquest illustrates the changed attitude of the Order, for which the quarrel with the Papacy was partially responsible. Its aims have become political rather than religious. It is no longer solely absorbed in the task of forcibly converting the heathen, but can turn aside to the pursuit of self-aggrandisement at the expense of its Christian neighbours.

The Papacy, which had been so enthusiastic a supporter of the Teutonic Order in the thirteenth century, was on the side of Poland in the fourteenth. But its ecclesiastical weapons were blunted by the energetic support which was given to Lewis the Bavarian, and by the complete alienation of Germany owing to the residence in Avignon. The first war with Poland ended in the victory of the Order. In 1343 Casimir the Great concluded the Treaty of Kalisch, by which he confirmed the cession of Pomerellen and other disputed territories near the valley of the Vistula. In 1346 Denmark handed over to the Order its ancient claims on the province of Esthonia. The Knights had now acquired almost the whole of the Slav territories to the south-east of the Baltic. Only the Lithuanians remained obstinately heathen and obstinately independent, and against them the Order waged a fairly successful war during the grand-mastership of Winzig von Kniprode from 1351 to 1382. During these years the Teutonic Order was at the zenith of its power and prosperity. Brandenburg, which might have contested its ascendancy in the north, was rendered impotent by the extinction of the Ascanian line, and by its rapid transfer through the hands of successive Wittelsbach and Luxemburg margraves. In Poland

The Order
at the height
of its power.

Casimir the Great was succeeded in 1370 by his nephew, Lewis of Hungary, who had no sympathy with the anti-German prejudices of the Polish nobles, and was disinclined to employ his forces in the defence of the heathen peasants of Lithuania. The campaigns of the Order had become a recognised school of warfare for the active and ambitious youth of northern Europe. Among the numerous allies who gave their services to the cause of Christianity were the adventurous John of Bohemia, who lost his eyesight in the marshes of Prussia, and Henry of Derby, son of John of Gaunt, who later established the Lancastrian dynasty on the English throne. Chaucer, in describing the career of his knight, says that

‘ Full ofte tyme he had the bord bygonne
Aboven alle naciouns in Pruce,
In Lettowe had he reysed and in Ruce.’

The death of Kniprode in 1382 was followed by the death of Lewis the Great of Hungary and Poland. The party of strong Slav sympathies among the Polish nobles were determined to put an end to the union with Hungary and the rule of a foreign king. Lewis's younger daughter, Hedwig, was invited to assume the crown of Poland, but she was compelled to offer her hand to Jagello, the grand prince of Lithuania. Jagello agreed to purchase a bride and a kingdom by accepting Christianity, and was baptized and crowned by the name of Ladislas in 1387. The accession of this Lithuanian dynasty, under whose rule Poland rose to the height of its power, dealt a fatal blow to the interests of the Teutonic Order. The two great enemies of the Order, whose quarrels with each other had more than once given the Knights both military and diplomatic triumphs, were henceforth united in a common cause. And the conversion of the Lithuanians, who now adopted the faith of their neighbours and allies, struck at the very foundations of the Order, which rested upon the

Union of
Poland and
Lithuania.

conception of a crusade against the heathen. Now that Prussia was surrounded by a ring of Christian states, there could no longer be any pretext for a religious war; and foreign princes and nobles were not likely to take an active interest in what became from this time a purely political struggle. The stream of auxiliaries from Europe was dried up at its source, and the Order had to fall back upon the expensive and unsatisfactory expedient of filling its armies with mercenary troops.

For more than three hundred years Germany had been steadily conquering the Slavs, driving them eastwards, or **War with** subjecting them to overwhelming German in-
Poland. fluences. Thanks to the Hanseatic League and to the Teutonic Knights, the Baltic had been made into a German sea. But with the fifteenth century a reaction set in in favour of both Scandinavians and Slavs. Just as the Union of Kalmar involved a serious danger to the Hanse towns, so the close association of Lithuania and Poland threatened the vital interests of the Teutonic Knights. In Bohemia the same reaction against German predominance found expression in the Hussite movement, and in the internal quarrels within the University of Prague (see p. 209). But it was in Prussia that the Slavs gained their most durable successes, though the victories of Ziska and Prokop over the crusading armies of Germany made the greater impression upon Europe at the time. The inevitable struggle which altered conditions forced upon the Teutonic Order broke **Battle of** out in 1409. In the next year the largest armies
Tannenberg. which had ever met in these northern wars confronted each other on the field of Tannenberg. After a terrible contest, in which John Ziska, the future leader of the Hussites, fought for the men of his own race, superior numbers gave a decisive victory to the forces of Poland and Lithuania. The grand-master and the flower of his Knights fell in the battle, and Prussia seemed to be at the mercy of the conquerors. But the progress of King Ladislas was

checked by the heroic resistance of the fortress of Marienburg; and he consented, in the Peace of Thorn (1411), to give up all his conquests except one district, which was to be ceded only for his own lifetime. The ruin of the Order was postponed for half a century.

The defeat at Tannenberg might have proved less fatal in its results if it had not been accompanied by growing internal weakness. An order of militant monks may provide a magnificent fighting force, but it is unlikely to prove a satisfactory conductor of civil administration. The great evil in Prussia was the absence of any substantial common interest between the governors and the governed. At first the German settlers were bound to the Knights as their protectors against the original inhabitants; but as time went on, and new generations grew up in the country of their birth, the original enmity between Germans and Slavs gradually cooled, and the two peoples were brought closer together in the ordinary intercourse of industry, trade, and social life. But this growing union was a source of danger rather than of gain to the ruling Order, because it deprived them of the aid of that section of the population which might naturally have been expected to support the Government. The Knights themselves, being bound by the priestly vow of celibacy, could not train up successors with a hereditary knowledge of the people and the country. Each generation of Knights came from other districts, and had to learn the work of government afresh. They came for the most part from southern Germany, and their habits and even their language differed in many respects from those of the Low Germans who had come in to settle in their towns and villages. And strict as the disciplinary code of the Order was, it was difficult to enforce its rules among men who were not secluded from the world in monasteries, but were busily engaged in the work of war and administration, and were in constant intercourse with visitors from all countries. The charges of immorality and unbelief which had been urged

against the Templars could certainly be brought with equal if not with greater force against the members of the Teutonic Order. The Knights had none of the ordinary restraints of family affection, private property, and home life; and it would have been superhuman if most of them had been able to resist the temptations to which their mode of life and their despotic authority over their subjects exposed them. For there was nothing like constitutional life in Prussia outside the Order itself. The authority of the grand-master was limited by the necessity of gaining the consent of his chapter and by the great independence of the provincial masters. But there was no machinery by which the Knights could receive advice and information from the people whom they ruled. Even the Prussian nobles, whether of German or Slavonic origin, were excluded from all voice in the government. After the battle of Tannenberg an attempt was made to establish a representative diet, in order to enlist popular sympathy in the task of resisting invasion. But it was the arbitrary act of an individual grand-master, and it broke the standing rule which forbade priests to be guided by the counsel of laymen. The economic policy of the Order was peculiarly affected by this want of easy intercourse with the traders whose interests were at stake. The most important towns within its dominions—Danzig, Elbing, Memel, Thorn, Kulm, and Königsberg—were extremely flourishing, and all except Memel were members of the Hanseatic League. On the whole, a wise instinct impelled the Knights to maintain a close alliance with the League, which so ably championed the cause of Germany in the western Baltic, and thus the danger of conflicting interests between the Order and the Hanse towns proved less than might have been expected. But the Knights themselves embarked in trade, especially in amber; and, after the fashion of rulers, they sought to regulate the market to bring gain to themselves, a course of action which excited the jealous hostility of the professional merchants. And their imitation of the action of the League

proved disastrous. For the maintenance of their great war against Denmark, the Hanse towns had imposed a duty upon all exports to be levied at each port (see p. 434). The Teutonic Order imposed a similar tax for the Polish war, and endeavoured to make it a permanent source of revenue. But the inevitable comparison was not in their favour. The Hanseatic League was fighting in the common interests of all German traders, and it was reasonable to ask them to contribute. The Order was conducting a war in which the merchants as such had no appreciable interest at all. The heavy taxation necessitated by the employment of mercenaries raised the question whether the government of the Order was worth the expense. Both nobles, citizens, and peasants were gradually convinced that their welfare was by no means bound up with crusades in Lithuania and perpetual warfare with Poland. In 1440 a number of nobles and twenty-one towns combined to form a 'Prussian League' for the defence of their liberties and common interests. There was no overt defiance of the Order, but the League constituted a state within the state, and a collision with the older government was sooner or later inevitable. And when it did occur, it was more than probable that the foreign enemies of the Order would be able to make use of the League to serve their own purposes.

As the alienation of their subjects became more and more pronounced, the Knights were driven to maintain their power by measures of ever-increasing severity. They denounced their opponents as traitors. But they themselves had no better claim to be considered as patriots. They were not native Prussians, and they had none of that instinctive devotion to the cause of their country which can hardly ever be acquired except under the subtle influences of birth and early training. For this love of the soil loyalty to a corporation proved a very inadequate substitute. Henry of Plauen, the hero of the defence of Marienburg in 1410, was rewarded for his services by election to the vacant grand-

mastership. But a few years later he incurred the displeasure of the chapter and was formally deposed. In his chagrin he did not hesitate to open treacherous negotiations with the Polish king, and ultimately he died in the prison to which he was justly condemned. Such an instance was by no means isolated; and, in fact, many of the Knights were secretly members of the Prussian League. The wonder is, not that the Order fell, but that its rule was for a time so successful, and that it lasted as long as it did.

Under the circumstances that grew up in the fifteenth century, with the Government divided in itself and confronted by the growing hostility of its subjects, a renewal of the Polish war could only be attended with disaster. For many years a quarrel was averted by a series of abject concessions, which were interpreted as a sign of weakness, and naturally encouraged further demands. At last the final catastrophe was hurried on by the outbreak of civil war. The Prussian League had become more and more openly antagonistic to the rule of the Order, and it was determined to make a resolute effort to crush the disaffection. In 1453 the Emperor Frederick III. was induced to condemn the League, and the Order armed its forces to carry out the imperial decree. The result might have been foreseen. The League renounced all allegiance to the Teutonic Order, and offered the suzerainty of Prussia to Casimir of Poland. The offer was accepted. The Polish king declared Prussia to be annexed to his dominions, and an army was led by Casimir himself to aid the rebels. For twelve years the unfortunate country was doomed to suffer all the horrors of civil strife and foreign invasion. In spite of the tremendous odds against them, the Knights offered a resistance worthy of their military reputation in the past. In 1457 the grand-master was forced to quit the fortress of Marienburg, where seventy of his predecessors had held their residence for a century and a half. A refuge was found for a time in the eastern castle of Königsberg, which was to

Civil war
and Polish
invasion.

be the future home of kings of Prussia in times of similar distress. But the town of Marienburg held out with heroic obstinacy for another three years, and siege operations there and elsewhere delayed the progress of the Poles long after they had crushed all resistance in the open field. The grand-master made frantic appeals to the Emperor and the German princes for aid against the Slavonic conquerors of the great province which the Order had won for Germany. To Frederick II. of Brandenburg he sold the Neumark (1455), which had been handed over to the Teutonic Knights by Sigismund in 1402. But prayers and bribes were equally unavailing to excite any sentiment of nationality among princes who had long ceased to regard anything but their own territorial interests. In 1466 it was at last necessary to submit to the consequences of defeat and to sign the Treaty of Thorn. The whole of western Prussia, with Pomerellen, including the towns of Danzig, Thorn, Elbing, and Kulm, was ceded to Poland, and the valley of the Vistula passed once more into the hands of the Slavs. Eastern Prussia, with Königsberg as its capital, was left in the hands of the Order, but it was to be held as a Polish fief. All allegiance to any other secular prince was to be repudiated, and thus the connection with Germany was formally ended. Future grand-masters were to do homage on election to the king of Poland, and were to sit on his left hand in the Polish Diet.

It is needless to dwell at any length on the subsequent fate of the Teutonic Order, which had fallen so lamentably from its high estate. The Knights of the Sword repudiated their subordination to a grand-master who was no longer a sovereign prince, and assumed the independent rule of Livonia and Esthonia. The House of Jagellon went from one triumph to another; and its ascendancy in eastern Europe seemed to be established when Ladislas, a younger son of Casimir IV., was elected to the crown of Bohemia in 1471, and to that of Hungary in

1490. Resistance to so great a power as Poland had now become must have seemed chimerical, yet the Knights continued to cherish the idea of recovering their lost independence. With this object in view they resisted all proposals to unite the grand-mastership with the Polish monarchy, and adopted the policy of electing successive chiefs from the great families of northern Germany, in the hope of enlisting their support for the cause of Prussia. Thus in 1498 they chose Frederick of Saxony, and in 1511 Albert of Hohenzollern. The latter was for a time encouraged by the promise of assistance held out by Maximilian I. But the Hapsburgs ever preferred the interests of their house to those of Germany; and the hopes of Albert were dashed to the ground when he learned that Maximilian had, in 1516, concluded a treaty and a double marriage alliance with the Jagellon princes in order to secure to his grandson Ferdinand the succession in Hungary and Bohemia. In anger and despair Albert determined to repudiate his allegiance both to Church and Empire. In 1525 he adopted the Protestant faith, confirmed the cession of West Prussia to Poland, and received East Prussia as a hereditary duchy for himself and his heirs. Although an obstinate minority of the Knights refused to acknowledge the validity of the grand-master's action, the Teutonic Order was practically dissolved. The remnant of the state which it had built up with such strenuous exertions fell a century later to the main line of the electors of Brandenburg, and gave a title to the monarchy which has become in later times the paramount power in a united Germany.

The Order of the Sword lingered a few years longer, only to meet with a similar fate in the end. In 1561 the last grand-master, Gotthard Ketteler, finding it impossible to maintain independence, imitated the action of Albert of Hohenzollern. He carved out for himself the secular duchy of Courland, to be held in vassalage to Poland, while the rest of Livonia and Esthonia was thrown as an apple of discord into the midst of the rival

**End of the
Order of the
Sword.**

Baltic states—Poland, Denmark, Sweden, and Russia. The struggle which followed is noteworthy, not only because it led to the temporary ascendancy of Sweden in the Baltic, and so to the achievements of its warrior-kings, Gustavus Adolphus, Charles x., and Charles xii., but also because it gave occasion for the first appearance of Russia as a European power.

CHAPTER XX

THE CHRISTIAN STATES OF SPAIN

Suspension of the Moorish wars in the middle of the thirteenth century—
Constitution of Castile—Disorders in the kingdom—Alfonso XI.'s victories over the Moors—Peter the Cruel and Henry of Trastamara—John of Gaunt in Spain—John II. of Castile and Alvaro de Luna—Henry III. and the accession of Isabella in Castile—The Constitution of Aragon—Acquisition of Sicily and Sardinia—The general Privilege and the Privilege of Union—Reign of Peter IV.—Re-union of Sicily with Aragon—Accession of the House of Trastamara in Aragon—Alfonso V. gains Naples—Relations of Aragon and Navarre—John II. and Charles of Viana—Union of Castile and Aragon—Government of Ferdinand and Isabella—The *Santa Hermandad* and the Inquisition—Conquest of Granada—Geographical discoveries of Portugal and Castile—The Bull of Borgia and the Treaty of Tordesillas.

THE middle of the thirteenth century was an important turning-point in the history of Spain. Hitherto the Christian states had been engaged in a continuous crusade for the conquest or expulsion of the Moors, who had held almost the whole peninsula in the eighth century. But the capture of Cordova in 1236, and of Seville in 1248, with the reduction of the province of Murcia in 1266, drove the Moors to their last stronghold in the kingdom of Granada, which they were allowed to retain in comparative peace for nearly two centuries and a half. This cessation of military activity in the south was due to several causes. Granada itself was strongly defended by nature, and its population was more homogeneous than that of the dominions which had been lost. And the old enemies of the Moors were now diminished in number. Portugal was cut off from all direct contact with the infidel by the district round

Seville and Cadiz, and Aragon was equally isolated by the intervention of the Castilian province of Murcia. The only state which had a conterminous frontier with the Moors was Castile, and the attention of Castile was distracted from its southern neighbours by internal feuds and foreign interests. One result of the termination of the religious war is that Spanish history loses such unity as it had hitherto possessed, and it is henceforth necessary to follow the separate history of its component states. And with its unity the history of the peninsula loses much of its dignity and importance. The record of internal feuds, of dynastic revolutions, and of criminal bloodshed, which fills the annals of the Spanish kingdoms, and especially of Castile, would hardly be worth preserving if it were not the necessary prelude to the rise of Spain in the sixteenth century to a foremost position among the powers of Europe.

Castile, permanently united with Leon since 1230, was the largest, and ultimately the dominant state of Spain. It had been formed in the course of a prolonged religious war, and this had left a permanent impress on the constitution. While the kings had risen to power as military leaders, the nobles and cities had also earned great independence in a struggle which had often depended more upon sudden local effort than upon the action of large armies; and the clergy, as the preachers of religious ardour against the infidel, retained more authority than in any other country in Europe. When national exertion was relaxed by the diminution of external danger, a struggle between the rival forces was inevitable; and though the victory rested in the end with the monarchy, it was long before this result was assured. The national assembly, or Cortes, was composed of three estates—clergy, nobles, and citizens—and its importance varied very much from time to time. But the royal power was more effectually limited by the danger of armed resistance than by any formal constitutional restrictions. The great nobles were independent

Consti-
tution of
Castile.

princes in their own domains, and could command the allegiance of their vassals in private feuds with each other, and even in warfare against the crown. For the vindication of their own rights, and for resisting the encroachments of the barons, the towns claimed and exercised the right of forming an armed union or *hermandad*. It was fortunate for the kings that conflicting interests and mutual jealousy prevented any common action between classes whose power both of offence and defence was so extremely formidable.

Alfonso x., who ruled in Castile from 1252 to 1284, is known in history as 'The Wise,' but the epithet was earned **Disorders in Castile.** by his remarkable learning rather than by his ability as a ruler. The only territorial acquisition of his reign, Murcia, was won for him by the arms of Aragon. He abandoned the war against the Moors for a vain effort to gain the imperial dignity, which he disputed during the Great Interregnum with an English rival, Richard of Cornwall. His later years, and the reigns of his successors, Sancho iv. (1284-1295) and Ferdinand iv. (1295-1312), were disturbed by a disputed succession to the crown. Alfonso's eldest son, Ferdinand de Cerda, died in 1275, leaving two sons, who are known as the Infantes de Cerda. According to modern ideas, their hereditary claim would be incontestable. But in the Middle Ages it was frequently held that nearness of blood gave a better claim than descent in an elder line. On this ground Alfonso's second son, Sancho, was recognised as his father's heir, and succeeded in ousting his nephews. But the Infantes de Cerda had many partisans in Castile, and a prolonged but desultory struggle ensued, in which the neighbouring kings of Aragon and Portugal were involved. The actual contest was ended by a treaty in 1305, by which the claimants were bought off with lavish grants of land. But the disorders to which it had given rise were not so easily suppressed. Two successive kings, Ferdinand iv. and Alfonso xi. (1312-1350), came to the throne in their childhood, and a minority is always an evil in an

early stage of society. Castile in this matter was almost as unlucky as was Scotland a little later, and the results in the two countries were very similar. The noble families fought out private wars among themselves, and the kings became partisans rather than arbiters among their subjects. In fact, the chief force for the maintenance of order was supplied, not by the monarchy, but by a great *hermandad* or brotherhood, which was formed in 1295 by thirty-four Castilian towns.

The obvious weakness of Castile, after nearly seventy years of anarchy, encouraged the Moors to make an effort for the recovery of their lost power. Abul Hakam, the Emir of Fez, crossed the Straits of Gibraltar in 1339 with a large army. He was joined by the ruler of Granada, and their combined forces laid siege to Tarifa. The approach of danger had a wholesome and healing effect upon Castile. Alfonso XI. was enabled to make peace with his rebellious subjects, and also with the king of Portugal, whose daughter he had married only to desert her for the beautiful Eleanor de Guzman. In 1340 he advanced to the relief of Tarifa, and gained in the battle of the Salado the first victory which had fallen to a Castilian king for nearly a century. The complaisant chronicler of the royal achievement tells us that only twenty Christians perished in a battle which cost the lives of two hundred thousand Moslems. It is at any rate authentic that Abul Hakam was driven back to Africa, and that in 1344 Alfonso captured the town of Algeciras. He hoped to complete his success by the reduction of Gibraltar, which would have excluded any further reinforcement from Africa to the Moors of Granada. But he was carried off by the Black Death in 1350, and this event led to the abandonment of the siege. Alfonso's successes against the infidel have outweighed in the histories of Spain both the vices of his private character and the disorder that prevailed in the kingdom during his minority and the greater part of his reign.

War of
Alfonso XI
with the
Moors.

Few historical epithets have been more thoroughly deserved

than that of 'the Cruel,' as attached to the name of Peter I. (1350-1369). Numerous attempts to whitewash his character have been made in vain, and all that can be said in his favour is that he had received very great provocation. He was the only son of Alfonso XI. and Maria of Portugal, and during his father's reign both he and his mother had been kept in ignominious seclusion, while every mark of favour was showered upon the royal mistress, Eleanor de Guzman, and her numerous children. Henry, the eldest of the bastards, was Count of Trastamara, and his twin-brother Frederick held the grand-mastership of the great Order of St. James. It was by no means unnatural that the dowager queen should urge her son, when he came into power, to avenge the insults which she had so long endured in angry impotence. Eleanor de Guzman was strangled in 1351, and two of her sons in later years were murdered by the king's own hand. Henry of Trastamara sought safety in exile, first in Portugal, and afterwards in France. It would be disgusting even to enumerate the atrocious acts which have been attributed, some with more and some with less authority, to the youthful monster in his early years. His treatment of Blanche of Bourbon, whose hand he had solicited from the French king, is a conspicuous but rather mild illustration of his ruthless temperament. He was living openly with a mistress, Maria de Padilla, when the princess arrived, and he refused even to see her. Later, under considerable pressure, he went through the form of marriage, but immediately returned to the arms of his mistress; and the bride, who was never a wife, was consigned to a solitary prison, and ultimately poisoned. In 1356 Peter put down a rebellion among his nobles, and took the most sanguinary vengeance upon his defeated opponents. His thirst for bloodshed seems, in moments of excitement, to have amounted almost to mania. Yet, for a long time at any rate, he was not unpopular with the lower orders among his subjects. It was upon the nobles and the Jews, neither very popular with the people, that his

hand fell with such severity, and he could show at times a coarse good-nature and a taste for rough buffoonery which won him some popular applause. This helps to explain why he met with little or no opposition when he endeavoured to secure the succession to his own illegitimate children. In 1362 he solemnly swore to the Cortes, and his oath was supported by the archbishop of Toledo, that he had been for ten years the lawful husband of Maria de Padilla, and the docile Cortes recognised her children as heirs to the crown.

But this settlement was not destined to be carried out. In Spain, as in Italy, bastardy was not considered so fatal a bar to inheritance as in northern countries. Henry of Trastamara found supporters in Peter of Aragon and Charles v. of France, who both had grounds of quarrel with the king of Castile. The latter, who was preparing to repudiate the treaty of Bretigni and to renew the war with the English, was not unwilling to allow Bertrand du Guesclin to train on Spanish soil the military companies which he was forming for the service of France. In 1365 a large army crossed the Pyrenees into Aragon, and thence proceeded in the next year to establish Henry of Trastamara upon the Castilian throne. Peter fled to Bordeaux to implore the aid of the Black Prince, and unfortunately succeeded in touching a chivalrous chord in his host's character. At the battle of Najara the war-hardened troops, which had won the victory of Poitiers, proved more than a match for the only half-trained recruits of du Guesclin (1367). Peter recovered his kingdom, but he showed himself as ungrateful to his auxiliaries as he was barbarous towards his own subjects. Neither the Black Prince nor his army ever completely recovered from their successful but disastrous campaign in Spain, and Charles v. was able in a few years from 1369 to expel the English from nearly the whole of their possessions in France (see p. 95). But the betrayer had no better fortune than the betrayed. The departure of Peter's allies enabled Henry of Trastamara to return to Castile, and

with French aid to win the battle of Montiel. In a personal interview the two half-brothers came to blows, and Henry's dagger avenged the death of his murdered kinsfolk. The two surviving children of Peter and Maria Padilla, Constance and Isabella, had been left at Bordeaux, and were married to two brothers of the Black Prince—John of Gaunt, duke of Lancaster, and Edmund Langley, duke of York.

Henry II. had by no means reached the end of his troubles when the death of Peter enabled him for the second time to ascend the throne of Castile. His title was contested by two rival candidates—Ferdinand of Portugal, whose grandmother had been a daughter of Sancho IV., and John of Gaunt, who asserted the legitimacy and rights of his wife as recognised by the Cortes of 1362.¹ The Portuguese king was the nearer and, for the moment, the more formidable opponent, but French aid enabled Henry to attack Lisbon and extort a treaty of peace. The illness of the Black Prince left the conduct of the war in France to John of Gaunt, and so Henry was able at once to harass his rival and to repay some of his obligations to Charles V. by sending a Castilian fleet to cut off direct communication between England and Gascony. Thus the reign, which had opened so stormily, ended in complete peace, and Henry of Trastámara handed on the crown to his son

John I. John I. (1379). His accession gave the signal for a renewal of the war with Portugal and of the Lancastrian claim. In 1385 the Portuguese troops won a crushing victory at Aljubarrota, and in the next year John of Gaunt came to the Peninsula in person to uphold his wife's cause. His daughter Philippa was married to the new king of Portugal, John I., and their united forces invaded Castile and occupied Compostella. But the Castilians had no desire to accept a foreign dynasty; and John of Gaunt, never very lucky or very resolute in his enterprises, was induced to desert his son-in-law and to conclude a separate

¹ See Genealogical Table Q, in Appendix.

peace (1387). Catharine, the only daughter of John of Gaunt and Constance, was betrothed to John of Castile's eldest son Henry, the first heir to the crown who received the title of Prince of Asturias, and the mother's claim was renounced in favour of the youthful bride.

Henry III., though he was only a boy when his father was suddenly killed by a fall from his horse, proved to be one of the ablest kings in the history of Castile. He Henry III., 1390-1406. insisted on a resumption of domain-lands which had fallen into the hands of the nobles, and maintained greater order in the kingdom than had been known for many generations. His marriage with Catharine of Lancaster freed him from any rival claimants to the throne, and also contributed to the maintenance of peace with Portugal, whose queen was Catharine's half-sister. But, unfortunately, his health was never strong, and he died in 1406 at the early age of twenty-seven, leaving a boy of two years John II., 1406-1454. old to succeed him. As it happened, the minority of John II. proved to be the most successful and orderly part of his reign. The regency was shared between his mother and his uncle Ferdinand; and so great was the respect inspired by the latter, that he might easily have supplanted his nephew with the general approval of the Castilians. But Ferdinand acted with perfect loyalty; and after his elevation to the throne of Aragon in 1412, he continued to give honest and disinterested advice to his sister-in-law. Unfortunately, when John II. was old enough to take the government into his own hands, he proved wholly unworthy of the care with which his kingdom had been administered for him. Unwarlike and averse to the cares of business, he allowed himself to be completely overshadowed by the famous Alvaro de Luna, grand-master of the Alvaro de Luna. Order of St. James, and constable of Castile. Alvaro de Luna was no commonplace favourite. He was by general recognition the most accomplished knight of his country and his age, and he combined with his brilliant

personal attractions political abilities of no mean order. He set himself to increase the authority of the crown because that authority was wielded by himself, and he achieved no small measure of success. He trampled upon the privileges of his brother nobles, and he prepared the way for the humiliation of the third estate by reducing the representation in the Cortes to seventeen of the principal cities. But his government, although despotic, was by no means conducive to order. The absolutism of a king may be submitted to and even welcomed, but the absolutism of a subject is certain to excite discontent among those who consider themselves to be legally his equals. The reign of John II. was filled by a series of conspiracies and rebellions, and the malcontents in Castile received formidable assistance from the king's cousin, John of Aragon. The constable, however, was as successful in the battle-field as in the tilt-yard, and no Castilian rebel or foreign foe was strong enough to effect his overthrow. His ultimate downfall was due to the ingratitude of his master. John's second wife, Isabella of Portugal, indignant that her authority counted for so little in the state, set herself to sow distrust between her husband and the all-powerful minister. The more domestic influence triumphed for the moment over the feeble mind of the king, and Alvaro de Luna was put to death after a parody of a trial in 1453.

John II. only survived the constable a year, and his death in 1454 ushered in a still more troubled period for Castile. **Henry IV.,** He left behind him three children—Henry, the 1454-74. son of his first wife, Mary of Aragon, and Isabella and Alfonso, the offspring of Isabella of Portugal. Henry IV., who succeeded his father, was the most incapable king of Castile until the accession of the unfortunate Charles II. in the seventeenth century. He was equally feeble in mind and body, and the contempt of his subjects found expression in his appellation of 'Henry the Impotent.' There were several aspirants to fill the position which Alvaro de Luna had held in the previous reign, and success rested with

Beltran de la Cueva, who had all the showy without any of the solid qualities of the famous constable. It was currently reported that the handsome favourite supplemented his influence over the king by securing the affections of the queen, Joanna of Portugal. The birth of a daughter increased instead of allaying the scandal, and the unfortunate infanta was generally known as 'la Beltraneja.' Jealousy of the favourite and disgust with the king's incompetence combined to provoke a formidable rebellion (1465). At Avila the rebels went through the formal ceremony of deposing a puppet dressed up to represent the king. The crown was offered to Henry's half-brother Alfonso, on the ground that Joanna was illegitimate, but the young prince died in 1468, before the civil war had come to a decisive end. Isabella, to whom the malcontents now turned, showed that she had inherited the qualities of her mother rather than those of her father. With a calculating wisdom beyond her years, she refused to weaken her claim by allowing her cause to be associated with rebellion against the monarchy. At the same time she was equally resolute to avoid any recognition of the legitimacy of her niece. Her firmness extorted a treaty from Henry IV., by which she was recognised as his heiress, and on this condition the rebels were induced to lay down their arms (1468). In the next year Isabella concluded her all-important marriage with Ferdinand, the heir to the crown of Aragon. As soon as the immediate danger of deposition was removed, Henry IV. embarked in a struggle to repudiate the recent treaty and to secure the succession to his wife's daughter. But he died in 1474 without having succeeded in his aim, and his half-sister inherited the crown. The cause of Joanna was now espoused by her uncle, Alfonso V. of Portugal, but Isabella succeeded in maintaining the position she had won. Her accession, and the subsequent union of the crowns of Aragon and Castile, ushered in a new and more distinguished epoch in the history of the Spanish peninsula.

Isabella.

The kingdom of Aragon was formed by the union of the three provinces of Aragon, Catalonia, and Valencia. The union was very imperfect, as each province jealously insisted upon retaining its own laws and institutions, and resented any attempt to introduce uniformity of administration. The powers of the monarchy were more narrowly restricted than in the neighbouring kingdom of Castile. The privileges of the *ricos hombres*, or great nobles, were so extensive as to make them almost the equals of their king, and the desire to maintain these privileges brought about among them a wholly unusual unity of interest and political action. Ferdinand the Catholic expressed this difference between the two kingdoms in his saying that 'it was as difficult to divide the nobles of Aragon as to unite the nobles of Castile.' And the citizens were not far behind the nobles in the spirit of independence, which was especially strong in the maritime province of Catalonia. The representation of towns in the Cortes of Aragon dates back to 1133, thirty-three years before any similar concession was made in Castile, and more than a century before any regular practice of central representation was established in England. The Cortes was not a general assembly of the whole kingdom, but each province had its own Cortes, which possessed within its borders the supreme control of jurisdiction, legislation, and taxation. In Valencia and Aragon the assembly consisted, as in Castile and France, of the ordinary three estates—clergy, nobles, and citizens. But the Cortes of Aragon contained four estates or arms (*brazos*). Besides the clergy and the delegates of towns, the secular nobles were divided into two distinct classes—(1) the *ricos hombres*, who had the right of attending either in person or by proxy, and (2) the *infanzones*, or lesser tenants-in-chief, and the *caballeros*, the sub-tenants, who were entitled to attend in virtue of their knighthood. In the office of Justiciar, Aragon possessed a unique institution which has always attracted the interest of historical students. Originally the Justiciar was merely the

president of the Cortes when it sat as a court of justice, and his functions were of no special political importance. But in course of time he became the mediator, and ultimately the supreme arbiter, in all disputes between the monarch and his subjects. In this capacity he was regarded as at once the depositary and the champion of constitutional traditions and liberties. The dignity of the office was enhanced by the character of its successive holders, and the history of Aragon abounds with instances of their resolute resistance to despotism on the one hand or to lawless disorder on the other. It is noteworthy that the responsibility of the Justiciar to the Cortes was secured by his selection from the lesser nobles or knights. The *ricos hombres*, whose privileges included exemption from execution or any corporal punishment, were always excluded from the office.

James I. of Aragon (1213-1276) is known by the honourable title of the Conqueror. He brought the long Moorish wars to an end, and completed the extension of the kingdom by the annexation of the Balearic Islands, which had long been a nest of Mussulman pirates, and of Valencia. He also effected the reduction of Murcia, but with rare loyalty handed it over to the king of Castile, in whose name he had carried on the war (1266). One result of these victories was that his successors, freed from the pressure of continual warfare at home, were able to turn their attention eastwards to events in Italy. Peter III. (1276-1285), was married to Constance, the daughter and heiress of Manfred, and thus acquired a claim to be regarded as the successor of the Hohenstaufen in Naples and Sicily. But it is doubtful whether this claim would have led to any practical results but for the massacre of the French in the famous Sicilian Vespers (1282). To protect themselves from the vengeance of Charles of Anjou, the islanders appealed to the king of Aragon, and offered him the crown. Hence arose the prolonged wars against a coalition formed

Aragon and
Sicily.

by the Angevin rulers of Naples, the popes and the kings of France, which constitute the most prominent episode, not only in the later years of Peter III., but also in the reigns of his two sons and successors, Alfonso III. (1285-1291) and James II. (1291-1327). These wars have already been referred to in connection with the history both of France and of Italy (see pp. 25, 48), and it is unnecessary to tell the story again. The essential points to remember are that in 1295 Boniface VIII. negotiated a treaty by which James II. was to marry Blanche, the daughter of Charles II. of Naples, to receive the island of Sardinia, and resign his claim upon Sicily; but the Sicilians refused to agree to terms in which they had had no voice, offered the crown to James's younger brother Frederick, and succeeded in 1302 in establishing him upon the throne. Hence in the end there was a double gain. Sicily was secured to a younger branch of the house of Aragon, and on its extinction reverted to the main line. Some years later James III. (1327-1336) took Sardinia from the Genoese and Pisans in virtue of a treaty which had been very imperfectly carried out on his side, as the only price which he paid for his acquisition had been an ineffectual attempt to expel his brother from a kingdom which he had deemed himself too weak to retain. Sardinia remained united with Aragon, and so with Spain, until the treaty of Rastadt in 1714 gave it to Austria, and the treaty of London in 1720 transferred it, with the title of king, to the duke of Savoy.

These Italian wars were not without their influence on the history of Aragon. They were waged in the interest of the dynasty, not of the kingdom, and the Aragonese had a substantial grievance in being called upon to furnish money, men, and ships for an enterprise in which they had no particular concern. Hence the kings were compelled to appease their subjects by concessions, which went far beyond any sacrifices extorted from contemporary rulers in other countries. The 'General

**Concessions
to the
Aragonese.**

Privilege,' granted by Peter III. in 1283, has been compared, and justly compared, with the English *Magna Charta*. It provided salutary securities for general and individual liberty, and its frequent confirmation shows that it was highly valued. But four years later Alfonso III. went to a dangerous extreme when he signed the famous 'Privilege of Union' (1287). By this his subjects were formally authorised to take up arms against their sovereign if he attempted to infringe their privileges. Rebellion may be and often is the only effectual safeguard against oppression, but it is harmful and unnecessary to formulate a right to rebel. The Privilege of Union put a very formidable weapon into the hands of the nobles, who could always disguise the selfish pursuit of their own interests under the pretence that they were engaged in opposing despotism.

Peter IV. of Aragon (1336-1387) was the first king who set himself to free the monarchy from some of the excessive restraints which had been imposed upon it. He annexed to the crown the Balearic Islands, which had been held since 1374 by a younger son of James the Conqueror and his descendants, under the title of kings of Majorca. The reigning king, James II., made a prolonged struggle to retain a dominion which he had done nothing to forfeit, but was compelled to submit to the superior force of his imperious cousin. This arbitrary act was followed by an attempt to settle the succession according to the personal wishes of the king. At the time (1347) Peter had only one child, a daughter Constance, and the heir-presumptive to the throne was his half-brother James, Count of Urgel. There was no law or custom excluding females from the succession in Aragon, but there was a very strong prejudice in favour of male heirs, and they had usually been preferred to heiresses, even though the latter stood nearer in the line of descent. The attempt of James to procure a settlement in favour of his daughter, combined with the generally high-handed character of his government, provoked a formidable

Reign of
Peter IV.

rising among the nobles, and also gave them a powerful leader in James of Urgel. Claiming the rights accorded by the Privilege of 1287, the rebels formed a Union at Saragossa and formulated their demands. The king, taken by surprise, was compelled at first to feign compliance; but the opportune death of James of Urgel, attributed by contemporaries to poison administered by his brother's command, together with a rally of the Catalans to the cause of the king, turned the balance in favour of Peter IV. In 1348 the royal forces met the rebels on the field of Epila, and gained a complete victory. The Privilege of Union was promptly revoked, and the parchment on which it was written was destroyed by the king's own hands. Thus the monarchy gained a really considerable triumph, and the nobles were the only immediate sufferers. In fact, Peter made no attempt to curtail any popular liberties, and the authority of the Justiciar was more firmly established in his reign by the grant of a life-tenure to the holders of the office. His later years were occupied with wars against his cruel namesake in Castile, with a struggle against the Genoese in Sardinia, and with the suppression of an attempt on the part of James III. to recover his father's kingdom of Majorca. The original doubt about the succession was removed by the birth of two sons, who successively came to the throne as John I. (1387-1395) and Martin I. (1395-1410). Their reigns are chiefly noteworthy for the reunion of Sicily with Aragon. The two crowns had been separated since the repudiation of his claims by James II. had given his younger brother Frederick the opportunity of gaining a kingdom. Since 1302 Sicily had been peacefully held by the descendants of Frederick I.; and on the extinction of the male line had fallen to an heiress, Mary, the daughter of Frederick II. by a marriage with a daughter of Peter IV. of Aragon. Mary was married in 1391 to her cousin, Martin the Younger, the only son of Martin I., who was enabled by the support of his uncle and father to obtain the Sicilian crown. On his early death in 1409, the island kingdom

Reversion
of Sicily.

fell to his father, who for the one remaining year of his life was king both of Aragon and of Sicily.

The death of Martin the Younger not only brought the crown of Sicily to the king of Aragon, but also gave rise to a disputed succession in the latter kingdom. The elder Martin was now the only surviving male descendant of Peter IV., and he died in 1410, before any arrangement had been come to about his successor. If male descent were insisted upon, the obvious heir was James of Urgel, whose grandfather had been the second son of Alfonso IV. Recent precedents, notably the accession of Martin himself in preference to the daughters of John I., were in favour of the exclusion of heiresses, but there remained the open question whether the male descendants of a woman could derive a claim through her. Of such candidates, two were most prominent—Louis, the eldest son of Louis II. of Anjou and John I.'s daughter Yolande, and Ferdinand, the regent of Castile in the minority of John II., whose mother was Eleanor, a daughter of Peter IV.¹ There can be no doubt that the count of Urgel had by far the strongest hereditary claim; but his own rash assumption that he had only to take the crown provoked opposition among the rather contentious Aragonese, and he was ultimately excluded. A joint committee was appointed from the Cortes of the three provinces to inquire into precedents; and after an interregnum of two years, their choice curiously fell upon Ferdinand of Castile, whose claim by descent was unquestionably weaker than that of his rivals (1412).

Thus the lucky house of Trastámara, in spite of its illegitimate origin, had come to furnish a king in Aragon as well as in Castile. And within a generation events enabled the family to add to these possessions the kingdom of Naples, and for a time the kingdom of Navarre. Ferdinand I. did not live long enough to display in Aragon the great qualities which his administration in Castile had

¹ See Genealogical Table R, in Appendix.

shown him to possess. His elder son Alfonso v. (1416-1458) is more associated with the history of Italy than with that of Spain. He inherited from his father Sicily and Naples, and Sardinia as well as Aragon, and in 1423 his adoption by Joanna II. opened to him the prospect of inheriting Naples. But the vicious queen soon changed her mind, disinherited Alfonso, and adopted in his place Louis III. of Anjou, who could claim through his mother a better right to the crown of Aragon than Alfonso himself. This double adoption led to the long war between the house of Aragon and the second house of Anjou, which raged for the last twelve years of Joanna's reign, and for eight years after her death. It ended in the victory of Alfonso, who reigned peacefully in Naples until his death in 1458 (see p. 271). As he left no legitimate children, Aragon, Sicily, and Sardinia passed to his brother John II. (1458-1494), but Naples was transferred to his bastard son Ferrante I. Half a century was to elapse before the kingdom of the Two Sicilies was re-formed by Ferdinand the Catholic.

While Alfonso was engaged in winning the crown of Naples amidst the turmoil of an Italian war, his younger brother John had succeeded in establishing an intimate relation with Navarre. This little kingdom, which comprised territory on both sides of the Pyrenees, had for a long time been more closely connected with France than with Spain.¹ United with the French crown by the marriage of Blanche of Navarre with Philip IV., it had again become independent on the extinction of the direct line of the house of Capet. When Philip of Valois ascended the throne of France, Navarre passed to the rightful heiress, Jeanne, the daughter of Louis X., and she was crowned with her husband, Philip of Evreux, in 1329. Their son, Charles the Bad (1349-1387), played a prominent, though not very creditable part in French history during the wars with Edward III. (see Chapter IV.). Charles II. (1387-

¹ See Genealogical Table S, in Appendix.

1425), who succeeded his father, devoted more attention to art and letters than to politics, and kept his kingdom in peace and obscurity. His daughter and heiress, Blanche, married John of Aragon, but the succession was secured to her children. As long as she lived Blanche ruled Navarre in her own right, and on her death in 1442 her son, John II. and Charles of Viana. Charles of Viana, was entitled to the crown of Navarre. He actually undertook the administration of the kingdom; but in deference, apparently, to his mother's wishes, he forbore to assume the royal title, which was still borne by his father. In the ordinary course of things, no special difficulty need have arisen, as Charles would have succeeded his father in Aragon as well as Navarre. But in 1447 John concluded a second marriage with Joanna Henriquez, daughter of the Admiral of Castile, and a woman of equal energy and ambition. She persuaded her husband to intrust her with the administration of Navarre, and Charles of Viana found plenty of advisers to remind him that the kingdom was lawfully his own, and to urge resistance to such an encroachment upon his authority. Hence arose a civil war between the father and the stepmother on the one side, and the son on the other. The great Navarrese families of Beaumont and Egremont, as uniformly hostile to each other as the Orsini and Colonnas in Rome, gladly welcomed so congenial a pretext for warfare. The Beaumonts were intimately associated with Charles, so the Egremonts had perforce to espouse the cause of his father. At Aybar, in 1452, the royal troops won the victory, and Charles fell a prisoner into his father's hands. He was released soon afterwards, but his power had been destroyed by his defeat, and his position was rendered worse by the birth of a son, afterwards Ferdinand the Catholic, to the queen in 1452. Joanna hardly concealed her intention to secure the recognition of her own son as heir to his father, and her influence over John was unbounded. The unfortunate prince of Viana set out to Naples in 1458 to implore the advice and assistance of his uncle Alfonso v. But Alfonso

died in 1458, and John was now king in Aragon instead of merely lieutenant for his brother. In 1460 Charles of Viana ventured to return to his father's kingdom, and, after a feigned welcome, was thrown into prison at Lerida. This gross injustice—for there was no shadow of a charge to be brought against the prince—excited a rebellion among the liberty-loving Catalans. The revolt rapidly spread to the other provinces, and the king of Castile showed a suspicious interest in the welfare of the heir to the crown of Aragon. John II. found it politic to yield to such general pressure. Charles of Viana was released and appointed governor of Catalonia, but before he could undertake the rule of his province he was removed by poison.

This terrible crime enabled John to retain possession of Navarre for his lifetime, but it rather increased his difficulties in his lawful kingdom. The Catalans renewed their rebellion to avenge the death of the prince whose cause they had championed with such fatal results, and besieged the queen and her son in the fortress of Gerona. Unable to force his way through to their aid, John was compelled to purchase the assistance of Louis XI. of France by pledging the provinces of Roussillon and Cerdagne to cover his expenses. French troops raised the siege of Gerona, but the Catalans maintained an obstinate resistance. They went so far as to offer the crown to René le Bon of Anjou and Provence, who was a grandson, through his mother, of John I. René, old, and averse to risk or exertion, sent his chivalrous son, John of Calabria, who had already fought a desperate war against the reigning Aragonese king of Naples (see p. 277), to carry on the war with the same family on the soil of Aragon. For a time John was almost in despair. He had become blind, and in 1468 he lost the wife whom he had loved and trusted too well. But the old man fought on with a dogged obstinacy which deserved its reward. In 1469 John of Calabria died, and in 1472 the fall of Barcelona completed the reduction of Catalonia. On his death in 1479

John bequeathed to Ferdinand an inheritance which was only diminished by the loss of Roussillon and Cerdagne, and these provinces were restored by Charles VIII. in 1493 in the hope of preventing the sending of aid from Aragon or Sicily to the bastard ruler of Naples, whom Charles was preparing to attack.

Death had at last relaxed the tenacious grip which John II. had so long maintained upon the kingdom of Navarre. Of his three children by his first wife Blanche—^{Navarre} Charles of Viana, Blanche, and Eleanor—only ^{after 1479.} the last, who had married Gaston de Foix, survived her father; Charles had been poisoned by his father, and Blanche had been poisoned by her sister. And, after all, Eleanor only outlived her father for a few weeks. Her grandson, Francis Phœbus, succeeded her, but died in 1483, and his sister Catharine carried the kingdom to the house of d'Albret. From this family Ferdinand the Catholic wrested that part of Navarre which lay on the Spanish side of the Pyrenees. The remainder came to the house of Bourbon by the marriage of duke Antony to Jeanne d'Albret, and by the accession of their son Henry IV. to the throne was ultimately annexed to France. When in the following century Roussillon and Cerdagne were finally handed over to the same state (1659), the Pyrenees at last became, as nature seemed to have intended, although history was always thwarting her intention, a boundary between two separate states.

The union of Castile and Aragon by the accession in the two kingdoms of Isabella (1474) and Ferdinand (1479) laid the foundations of a kingdom of Spain, and opened the way for a brief period of Spanish ^{Union of} predominance in Europe. ^{Castile and} Yet the union of the ^{Aragon.} kingdoms was merely personal: it was no more, in some ways it was even less, than the union of England and Scotland effected by the accession of James I. in the former kingdom in 1603. The great states of the peninsula were not welded into one; they remained distinct units, each with

its own national characteristics, its own laws and institutions, its own sense of corporate life and interests. This imperfection of the union is a fundamental fact in later Spanish history; it marks the essential difference between Spain and its more successful neighbour France; it is a chief cause of the rapid and apparently irreparable decline of Spain in a later age. Nevertheless, in spite of its defects, the union was a necessary condition of the emergence of Spain from its mediæval isolation. The very want of harmony among the component states contributed to the rise of the royal power, and the strength and weakness of Spain were equally bound up with the fate of the monarchy. Without the forces of Aragon it would have been impossible for Isabella to put down the disorderly independence of the Castilian nobles, or for Charles v. to repress the communes and to degrade the Cortes to impotence. And without the forces of Castile Philip II. could never have ventured to trample upon the hardy liberties of Aragon.

The grand period of Spanish history, and even great part of the reigns of Ferdinand and Isabella, lie beyond the limits of this volume, which is only concerned with the earlier achievements of these monarchs. The primary duty of the queen was to strike at the independence of the Castilian nobles, and to put an end to the lawless anarchy which had reached its height under the feeble rule of her brother. For this purpose she found an instrument ready to her hand in the time-honoured privileges of the burgher class. In 1476 she proposed and carried in the Cortes the organisation of the *Santa Hermandad*, or Holy Brotherhood, which was to supply a force of civic police on a most extensive scale. Its affairs were managed by a central junta, composed of deputies from all the cities of Castile, which was convened once a year. A small army of two thousand cavalry, with attendant archers, was formed to enforce the decisions of local magistrates and of the supreme court. The nobles protested against the measure

Government
of Ferdinand
and Isabella.

as unconstitutional, but the protest of the chief evil-doers is a proof of its value and its efficiency. Other measures followed in rapid succession. The extravagant grants of lands and pensions which had been made to the nobles in recent years were revoked, the fortresses which had served as centres of brigandage were destroyed, and steps were taken to codify the numerous laws which had been enacted since the reign of Alfonso x. The grandmasterships of the orders of Calatrava, Alcantara, and St. James, which conferred upon their holders powers too great to be safely intrusted to subjects, were on successive vacancies annexed to the crown. And the strengthened monarchy showed itself the enlightened protector of the material interests of its subjects. Trade and industry were encouraged by the remodelling of taxation, by a much-needed reform of the currency, and by the removal of the barriers to commercial intercourse between Castile and Aragon. It has been reckoned that the royal revenue, without any increased charges upon the people, was multiplied thirty-fold between Isabella's accession in 1474 and her death in 1504.

The greatest of rulers have their defects, and Isabella's were a fanatical hatred of heresy and a feminine passion for religious uniformity. There can be no doubt The Spanish that her influence predominated in bringing about Inquisition. the introduction of the Inquisition, which was authorised by a bull of Sixtus iv. in 1478, and was set in working in 1483 under the presidency of Torquemada. It may be regarded as the first institution of a united Spain. Its extension to Aragon excited much opposition among the liberty-loving people, but the iron will of Ferdinand proved irresistible. One of the first outcomes of religious persecution was the expulsion of the Jews in 1492. Some two hundred thousand Jews are said to have been driven from Spain by this edict. It was a cruel measure, but it was not so disastrous as it has been represented by some writers, who seem to have forgotten that it was followed, not by the

immediate decline of Spain, but by a period of unexampled prosperity.

The first overt proof to the world that a new power had arisen in Spain was furnished by the final extinction of the Moorish dominion in the peninsula. The most signal illustration of the weakness caused by the internal disorders of Castile for the last two hundred years is to be found in the prolonged existence of the kingdom of Granada. The establishment of a united and efficient state upon their borders was fatal to the Moors. The war began in 1481, and was steadily but not impetuously prosecuted for ten years. On November 25, 1491, the capitulation of the Moorish capital was signed. The terms granted to the conquered were as liberal as prudent policy could dictate or as their heroic resistance had deserved. Full liberty as to the exercise of their religion and the maintenance of their own laws was granted to all who would peacefully submit to Christian rule. But unfortunately the terms were not observed. After seven years of tranquillity the bigotry of the Castilian government proved stronger than considerations either of honour or of policy. The Moors were suddenly called upon to choose between conversion and exile. Those who accepted the former alternative had to live under a sort of ban in the midst of an alien and hostile majority, until the insane edict of expulsion against the Moriscos in 1609 deprived Spain of a harmless and industrious element of its population just at the time when it could least afford to lose them.

In one great department of activity—geographical discovery and expansion—Spain was anticipated and to some extent guided by her neighbour Portugal. Portugal began life as one of the struggling Christian states of Spain, with no essential difference from the other petty counties or kingdoms which were in the end combined to form larger states. Gradually Portugal had been hardened into something like nationality by a long struggle, first to

secure its existence against the Moors, and then to resist that absorption into Castile which considerations of geography and race seemed to render not only natural, but almost inevitable. The first end was achieved by the victories of Alfonso I. (1112-1185), who exchanged the title of count for that of king; the second by the victory of Aljubarrota in 1385 (see above, p. 474), and the wise government of John I. (1383-1433). It was in the reign of the latter that Portugal began to interest itself in the task of exploring the west coast of Africa, which was destined to bring to the small kingdom such a lavish measure of wealth and renown. His third son, who was also the grandson of an Englishman, John of Gaunt, was the famous Prince Henry the Navigator. He was inspired with a confident belief that it was possible to sail round Africa, and that the Portuguese might by this route divert to themselves the great gains which the Venetians and Genoese enjoyed from their indirect trade with India through the Levant. His dream was not fulfilled during his own lifetime, but his efforts contributed to its later realisation. For forty years he laboured to fit out expeditions for African exploration, and to these were due the successive discovery, or in some cases the re-discovery, of Porto Santo (1419), Madeira (1420), the Canaries, which were later surrendered to Castile, the Azores (1431-1444), the White Cape or Cabo Blanco (1441), and Cape Verde (1446). When once the great shoulder of Africa had been rounded it was easy to reach the Guinea coast.

The death of Prince Henry in 1460 checked, but did not arrest the progress of discovery. Africa had been found to produce one very valuable commodity—slaves—and Portugal was keenly interested in the lucrative but demoralising slave-trade. This served to stimulate frequent voyages to the west coast of Africa, and it was certain that before long some of the more adventurous sailors would be induced, either by design or by accident, to prolong their journeys. Moreover, as the fifteenth century advanced, the impulse to find a new route to India became

constantly stronger. The Levant was becoming more and more a Turkish lake. First the coast of Asia Minor and then Constantinople fell into their hands. There was a growing danger that the great markets in which the Venetians and Genoese had purchased from Arab caravans the products of the East would be closed to Christian merchants. Europe could not afford to dispense with commodities which had become almost necessities to her peoples, or to purchase them upon terms which drained the western countries of their all too scanty supply of the precious metals. A great prize was offered to the discoverers of a direct maritime connection with India, and the competition became more and more keen. Portugal, thanks to Prince Henry, had been first in the race, and she deservedly won the prize. In 1486 Bartholomew Diaz reached Algoa Bay, having at last rounded the Cape, to which he gave the well-merited name of *Cabo Tormentoso*, or the stormy cape; though King John II., with greater prescience and less familiarity, insisted upon calling it the Cape of Good Hope. Twelve years later, in 1498, Vasco da Gama completed the work by conducting a continuous voyage from Lisbon to Calicut.

The Cape
route to
India.

Meanwhile Castile had attempted to solve the great problem of the age. By the treaty of 1479, when Isabella was recognised and the claims of Joanna were abandoned by her uncle and husband, Alfonso V., Portugal had given up the Canaries, but had received the confirmation of past and future discoveries on the African coast. Thus Spain was debarred from competing with Portugal on the route to India which Henry the Navigator had pointed out. But Christopher Columbus, a Genoese mariner who entered the service of Castile, proposed to find a way to Asia by sailing westwards. In 1492 the first of his ever-famous voyages brought him to land which he conceived to be part of India. He had really found the new world of America, but his fruitful error has given to the islands at which he first touched the name of the West Indies.

Discovery of
America.

These two discoveries, of America and of the route to India round the Cape, are perhaps the greatest events of the fifteenth century. They brought men face to face with new problems, new conceptions, new interests, which have drawn a conspicuous line of demarcation between the Middle Ages and later times. But these belong to a subsequent period. The most immediate result was to create a danger of collision between Spain and Portugal, which contemporary statesmanship set itself to avert. A bull of Alexander vi. in 1493 drew an imaginary line a hundred leagues west of the Azores, and gave the countries to the west of the line to Spain and those to the east to Portugal. This arrangement was modified in the next year by the treaty of Tordesillas between the two countries, which shifted the line of demarcation some hundred and seventy leagues farther west. This served to give to Portugal its subsequent claim to Brazil. But the monstrous pretension of the two pioneers of discovery to monopolise all its fruits to themselves provoked before long the vigorous resistance of northern countries which were equally fitted by geography for oceanic trade. When Spain in 1580 annexed Portugal, the struggle against a single monopoly became more desperate; and it was this, even more than differences of religion, which led to those prolonged wars with the English and Dutch in which the power of Spain was shattered.

CHAPTER XXI

THE GREEK EMPIRE AND THE OTTOMAN TURKS

The Greek Empire after the recovery of Constantinople in 1261—The reigns of Michael VIII. and Andronicus II.—The Grand Company of the Catalans—Civil war and deposition of Andronicus II.—The Seljuk and Ottoman Turks—Conquests of Othman and Orchan—The tribute of children—John V. and John Cantacuzenos—Stephen Dushan and the Empire of Servia—First conquests of the Turks in Europe—Vassalage of the Greek Empire—Turkish successes against the Slavonic States—Bajazet I. attacks Constantinople—Battle of Angora—Revival of the Ottoman power—The Emperor John VI. and the Council of Florence—Wars of Amurath II. with Hungary—Revolt of Albania under Scanderbeg—Mohammed II. takes Constantinople—Conquest of Servia, Wallachia, and Bosnia—Conquest of Greece—War with Venice—The Turks in Otranto—Death of Mohammed the Conqueror.

It is not a little curious that the two powers which claimed to represent the ancient Empire of Rome both perished in the thirteenth century. The fall of the Hohenstaufen and the Great Interregnum mark the real end of the western Empire. Henceforth it is nothing more than a feeble kingship of Germany with a shadowy claim to suzerainty over Italy. The eastern Empire was annihilated by the destructive triumph of the Crusaders in 1204. Its so-called revival in 1261 was merely the recovery of Constantinople by a prince who had previously ruled in Nicæa. The rule of Michael Palæologus and his successors, though the forms and ceremonies of Roman tradition were carefully maintained, has no claim to be called a Roman Empire at all; at the most, it is a Greek or Byzantine Empire. Their territories were smaller than those of several of the western kings. In Europe they held little more than

The Greek
Empire after
1261.

Constantinople itself, with the adjacent district of Roumelia and the peninsula of Chalcidice. To the north and west they were hemmed in by the independent kingdoms of Bulgaria and Servia. The greater part of the Morea was split up into small states in the hands either of Frankish princes or of Venice. Venice also held the important islands of Corfu, Crete, and Negropont, and many of the lesser islands in the Ægean were ruled by Venetian families. In Asia Minor the Palæologi succeeded in retaining for a time the greater part of the west coast with a few towns on the Black Sea ; but the rest of the peninsula was in the hands of the Turkish sultans of Iconium, with the exception of a small strip in the south-eastern corner of the Black Sea, which constituted the so-called Empire of Trebizond. It is true that Michael VIII. himself, and even some of his feeble successors, made a few acquisitions of territory, especially in the Morea, but these were counterbalanced by quite equal losses. The Knights of St. John, who lived in Crete for a few years after their expulsion from Acre in 1291, seized Rhodes and the small adjacent islands in 1310. And the Genoese, who had rendered valuable service in the war with the Latin emperors, demanded very large concessions as their reward. Not only did they receive the suburb of Pera or Galata, which they fortified against the Greek emperors, but they established their power at Kaffa in the Crimea, and in Azof, at the mouth of the Don, thus securing a monopoly of the Black Sea trade, and they also seized upon the islands of Lesbos and Chios.

It is a sorry task to trace the fortunes of the decadent Greek Empire during the two centuries that were secured to it, not by any ability on the part of its rulers or any heroism on the part of their subjects, but partly by a series of accidents which checked the advance of encroaching neighbours, and partly by the extraordinary defensive strength of the capital. There is hardly a single episode in this period of Greek history that inspires any interest or would deserve any

attention, but that the weakness of the Empire was a prominent cause of that rapid rise of the Ottoman Turks which is one of the great events in history. In Constantinople itself there is little to record except miserable court jealousies and intrigues, and the most puerile discussions of minute questions of religious dogma. The recent establishment of Latin rule had inspired the Greeks with a bitter hatred of Roman Catholicism, and at the same time with a consciousness of their own weakness. Hence the stolid conservatism which characterised the administration in both Church and State under the Palæologi. 'The Greeks gloried in the name of Romans; they clung to the forms of the imperial government without its military power; they retained the Roman code without the systematic administration of justice, and prided themselves on the orthodoxy of a Church in which the clergy were deprived of all ecclesiastical independence, and lived in a state of vassalage to the imperial Court. Such a society could only wither, though it might wither slowly' (Finlay).

The fall of the Latin Empire could not take place without causing a sensation in western Europe, and for some time

Michael VIII. Michael VIII. had to fear a possible attempt to effect its restoration. Charles of Anjou, who as **Andronicus II.**

the champion of the Papacy has gained Naples and Sicily from the Hohenstaufen, twice pledged himself to carry his victorious forces across the Adriatic, in 1266 by the treaty of Viterbo with the exiled Baldwin II., and in 1281 by the treaty of Orvieto with Venice and Pope Martin IV. So alarmed was Michael VIII., that he resorted to the last expedient of a Greek emperor in distress, and sought to conciliate the Pope by offering to bring about the union of the Greek with the Latin Church. But his pusillanimity made him unpopular with his subjects, and proved to be wholly unnecessary. Both schemes of the Neapolitan king were rendered abortive; the former by the attack of the luckless Conradin in 1267, the latter by the Sicilian Vespers in 1282 (see p. 25). These events enabled Michael, who died in the

latter year, to leave an undiminished dominion to his son, Andronicus II. The new emperor was as superstitious and as timidly orthodox as any of his bishops could desire, and his personal character was far better than that of the majority of Eastern despots; but he was a thoroughly worthless and incompetent ruler. His long reign, which lasted from 1282 to 1328, was marked by three events which brought the Empire to the verge of ruin. Ruling over a comparatively small and unwarlike population, the Greek emperors after 1261 were peculiarly dependent upon mercenary troops for either defensive or aggressive warfare. In 1303 chance gave to Andronicus the service of perhaps the finest fighting force in Europe at that time. The twenty years' struggle for the possession of Sicily between the houses of Anjou and Aragon had just ended in the victory of the latter, and Frederick I. of Sicily was not unwilling to rid himself of the hardy soldiers from Catalonia and the other Aragonese provinces who had gained him his crown, but were likely to be a source of trouble and disorder now that peace had been concluded. Under the leadership of a brilliant adventurer, Roger de Flor, these men were formed into the 'Grand Company of the Catalans,' and were transported to the eastern Empire. Properly led, these troops might have taken advantage of the dismemberment of the Seljuk dominions to gain the whole of Asia Minor for the Palæologi. But Andronicus II. was incapable of even planning so ambitious a project. The strength of the Company was wasted in petty operations; and when the withholding of arrears of pay provoked a mutiny, the emperor recklessly endeavoured to intimidate the mercenaries by procuring the assassination of their idolised commander. Vowing vengeance, the Catalans turned their arms against their employer, routed the armies that were sent against them, and for the next few years lived in luxurious idleness upon the spoils which they wrested from the emperor's unfortunate subjects. Nor was it possible to expel them, and they only quitted the

dominions of Andronicus when they were tempted in 1310 to enter the service of the duke of Athens. The emperor's last years were darkened by a civil war which was almost as disastrous as his quarrel with the foreign mercenaries. His grandson, another Andronicus, a young man of considerable ability but of vicious habits, raised the standard of rebellion in 1321 because he was not admitted to the position of joint-emperor which had been held by his father till his death in the previous year. The war was interrupted by several futile attempts to bring about a reconciliation; but at last the partisans of the young prince, among whom John Cantacuzenos was the most prominent, gained a complete victory in 1328, when the capital was taken and Andronicus II. was deposed in favour of his grandson. Four years later the aged emperor died, after having been compelled to become a monk in order to render his restoration impossible. The terrible waste of force in the ravages of the Grand Company and the miserable contest between grandfather and grandson are the more significant when it is remembered that in this reign occurred the first collision between the Greek Empire and its destined destroyers, the Ottoman Turks.

The Ottoman Turks, or Osmanlis, as they call themselves, were by no means the only or the earliest members of the Turkish race to gain distinction. Long before their appearance in history the Seljuk Turks had risen to ascendancy in western Asia, first as the soldiers and then as the masters of the Saracen caliphs. A Seljuk dynasty established itself in the eleventh century in Nicæa with the title of Sultans of Rome, as ruling over great part of the Roman Empire. The early crusades had aided the Eastern emperors to drive the Turks back from Nicæa to Iconium, but they remained the dominant power in Asia Minor. The disruption of the eastern Empire after the Fourth Crusade would probably have enabled the Seljuks to extend their dominions if they had not been at the same time exposed to

attacks from the Moguls in the east. It was in this war that we first hear of the Ottoman Turks. One of the sultans of Iconium was hard pressed in battle by the Moguls, when the scale was turned by the intervention of a small but warlike band of Turks under Ertogrul, the father of Othman, from whom their later name was derived. The grateful sultan rewarded his unexpected auxiliaries with a considerable grant of lands; and when the Seljuk power was broken up on the death of Aladdin III. in 1307, Othman was one of the numerous emirs who acquired independence. Among these emirs Othman and his successors gradually rose to acknowledged pre-eminence, chiefly through their victories at the expense of the Greek emperors, which attracted to their service the ablest and most ambitious Turks from the other provinces. Just before Othman's death in 1326 his forces captured the Greek city of Conquests of Othman and Orchan. Brusa, which became the Asiatic capital of the Ottomans. Under his son and successor, Orchan, the Turkish power made immense strides. Orchan's first enterprise was the attack on Nicæa, which may be regarded as the second capital of the Byzantine Empire. No formal siege was laid to the city, but the Turks constructed strong forts in the neighbourhood, from which they could harass the inhabitants and cut off supplies of water and food. Andronicus III. and his minister, John Cantacuzenos, crossed the Bosphorus to attempt the relief of Nicæa, but were defeated at Pelekanon (1329), the first battle in which a Greek emperor confronted the Ottoman Turks in arms. Nicæa surrendered in 1330, and was treated with such leniency as to create a temporary impression that the Greeks would be better off under Turkish than under Byzantine rule. The military incapacity of the emperor allowed Orchan to continue his aggressions with comparative ease; and at the end of the next ten years the only territories retained by Andronicus in Asia Minor were the two towns of Phocæa and Philadelphia, together with a small strip of territory along the eastern coast of the Bosphorus.

Orchan is famous in Turkish history not only as a conqueror, but also as a legislator and administrator. One of his institutions proved invaluable to his successors. The law of Mohammed offered two alternatives to unbelievers—the Koran or tribute. By payment of tribute the conquered could purchase the security of life and property and the permission to retain their own religious worship. Orchan introduced the innovation of exacting this tribute not only in money or goods, but in children. Every Christian village was compelled to furnish every year a fixed proportion of the strongest and most promising boys about eight years of age. These children were brought up in the Mohammedan religion, and were educated with the greatest care both for body and mind. As they grew older, according as they excelled in mental or physical qualities, they were drafted either into the civil administration or into the army. The civil servants taken from these children formed an administrative body, which was under the absolute control of the sultan, and was more efficient than could be found in any other country at that time. The troops were still more serviceable. They constituted the famous Janissaries (*Yeni Tcheri* or new troops), who for two centuries were unsurpassed by any other military force. With diabolical ingenuity the Turks secured the victory of the Crescent by the children of the Cross, and trained up Christian boys to destroy the independence and authority of their country and their Church.

A critical period in Byzantine history followed the death of Andronicus III. in 1341. His young son, John V., was left under the regency of his mother, Anne of Savoy. But the authority of the regent was disputed by John Cantacuzenos. John Cantacuzenos, who had been virtual prime minister under Andronicus, and was now persuaded by his partisans to assume the imperial title. A prolonged strife of factions followed, in which both sides were base enough to appeal for the support of the Turks. Cantacuzenos was successful in gaining Orchan to his side, but by a bargain

John V. and
John Canta-
cuzenos.

which even Greek morality considered disgraceful. His daughter was married to the Mussulman sultan, and was sent to reside in the harem at Brusa. But the complaisant father achieved his object. In 1347 he was recognised as emperor by the empress-regent, and was to be allowed to hold the executive authority for ten years, when it was to be shared with John v., who was to marry Helena, another daughter of Cantacuzenos. The latter was now crowned again with his wife, and John v. was also crowned with his bride. Thus Constantinople witnessed the unique pageant of two emperors and three empresses at the same time.

This civil war had not only given to the Turks a dangerous insight and influence in Greek politics, it had also enabled a rival power to extend itself on the western side of the empire. Stephen Dushan, who had become king of Serbia in 1333, took advantage of the anarchy in Constantinople to seize Albania, Epirus, and Thessaly, and thus to extend his dominions to the Adriatic on one side and to the Ægean on the other. He assumed the title of Emperor of Roumania, Slavonia, and Albania. It would probably have been for the ultimate advantage of Europe if he could have extinguished the Greek empire altogether by the conquest of Constantinople. But he was not strong enough to do this, and his territories were divided after his death in 1355. His conquests left the European dominions of Byzantium hardly larger than those in Asia. Besides the capital, with the adjacent part of Thrace, there were Thessalonica and another strip of territory, about a third of the Morea, and a few islands in the Ægean. Even between Constantinople and Thessalonica there was no secure communication except by sea, as the intervening territory was held by Serbia.

The treaty of 1347 was not likely to bring about lasting peace in Constantinople, and in 1351 a quarrel between John v. and his father-in-law gives us another illustration of the weakness of the empire. The dispute became mixed

Conquests
of Stephen
Dushan.

up with the standing quarrel between the Venetians and the Genoese. The Genoese maintained that alliance with the Palæologi which had given them their predominance in the east, and therefore Cantacuzenos tried to overthrow them by obtaining the support of Venice. The two Italian republics fought out their own quarrel in Greek waters, without much regard to the interests of their allies. The Venetians were defeated in 1352 in a great naval battle fought within sight of Constantinople, and Cantacuzenos was compelled to confirm all the privileges of the victors. His authority never recovered from the blow, and in 1354 he was compelled to abdicate and become a monk.

The same year in which John v. became sole emperor witnessed the first permanent establishment of the Turks upon European soil. Hitherto they had only appeared either as plunderers or as the auxiliaries of Cantacuzenos. But in 1354 Suleiman, Orchan's eldest son, took advantage of an earthquake, which had destroyed the walls of many towns in Thrace, to seize and garrison Gallipoli. John v., afraid that the Turks might support Matthew Cantacuzenos, who claimed to take his father's place as emperor, was unable to attempt their expulsion, and Gallipoli became the basis for later conquests. Suleiman died in 1358, and Orchan in 1359; but the new sultan, Amurath or Murad I., added one city after another to his rule, till in 1361 he made himself master of Adrianople, which became the European capital of the Turks for nearly a century. The fact that these early conquests of Amurath were gained without serious opposition in the districts in which the party of Cantacuzenos had been most numerous seems to show that faction had overpowered all sense of patriotism among the Greeks. The conquest of Adrianople brought the Turks to the northern boundary of the Byzantine empire, and for the next few years they were occupied with wars against the Slavonic states—Bulgaria, Servia, and Bosnia

—great parts of which were conquered or compelled to pay tribute.

John v., finding himself surrounded by the growing dominions of the infidel, made desperate efforts to obtain aid from western Europe. In 1369 he actually went to Rome to meet Urban v., who had just returned to his capital, and agreed to a written profession of faith, in which he accepted the Roman view on all the questions at issue between the two Churches—that the procession of the Holy Ghost is from both Father and Son; that unleavened bread may be used in the Sacrament; and that the Church of Rome is supreme in matters of faith and jurisdiction. But the document was worthless to either side. The emperor could not coerce the faith of his subjects, and the Papacy in the middle of the fourteenth century was powerless to rouse any crusading ardour among the European princes. Discouraged by the failure of this negotiation, the pusillanimous emperor sought a still more humiliating path to safety. He became the vassal of the Turkish sultan, allowed him to occupy Thessalonica; and when his own son Andronicus headed a successful rebellion, it was put down by Turkish aid purchased by a treaty which stipulated for the payment of tribute by the Greek emperor (1381).

Vassalage
of the
Empire.

The Slavonic states to the north and west of Constantinople offered a more resolute, though not in the end a more successful resistance than the Greeks. In 1387 a great league was formed for mutual protection, under the leadership of the king of Bosnia. For a time this checked the Ottoman advance; but in 1389 Amurath won a complete victory over the allied forces at Kossova, where the Servian king was slain. Amurath himself was killed after the battle by a Servian noble who pretended to be a deserter. But the murder brought no gain to the Slavonic cause, as Bajazet I. succeeded at once to his father's position and reaped all the fruits of the victory. The new king of Servia had to give his sister in marriage to the sultan,

Turkish con-
quests in the
north.

and to promise both tribute and military service. Wallachia was also made to pay tribute, and Bulgaria was annexed to the Ottoman dominions, which were thus extended to the Danube. The most vigorous effort made by a European combination against the infidel, when Sigismund of Hungary was joined by a band of French nobles under John of Nevers, heir to the duchy of Burgundy, only served to give another still more brilliant victory to Bajazet under the walls of Nicopolis (1396). Sigismund narrowly escaped captivity; and John the Fearless, as he was afterwards called, was only allowed to save the lives of twenty-four of his fellow-prisoners, who were to carry back to Europe the tale of the prowess and the fantastic mixture of cruelty and magnanimity displayed by their conqueror.

Meanwhile John v. had died in 1391, and was succeeded by his second son, Manuel II., the elder brother, Andronicus, having died in 1381. Manuel had been compelled to lead a Greek contingent into Asia to aid Bajazet in taking Philadelphia, one of the last cities in Asia Minor which retained its independence, and was still at Brusa when the news arrived of his father's death. He succeeded in escaping to Constantinople, but it was lucky for him that the sultan was engaged in reducing to obedience the Seljuk emirates which had not yet recognised the supremacy of the Ottoman dynasty. This enabled Manuel to make good his position, but he had to accept the same subjection as had been imposed upon his father. When, however, the great coalition was formed under Sigismund to resist the Turks, Manuel had welcomed the prospect of regaining his freedom, and Bajazet had learned how little he could trust the fidelity of his imperial vassal. After his victory at Nicopolis the sultan determined to inflict a signal punishment on all those tributary princes who had ventured to oppose him. In 1397 he reduced Epirus and Thessaly, while Manuel was harassed by the recognition of his nephew John, the son of Andronicus, as emperor. Recognising the futility of relying upon his own

**First Turkish
siege of Con-
stantinople.**

strength to resist the sultan, Manuel came to terms with his nephew, admitted him as a colleague, and left the administration in his hands, while he himself set out on a tour through western Europe to implore assistance. During his absence Bajazet laid regular siege to Constantinople, and would probably have completed its conquest if he had not been called away to Asia to resist the attack of the great Tartar leader, Timour, or Tamerlane, who had already marched victoriously over the greater part of Asia. In the famous battle of Angora, the Ottoman Turks met with a crushing defeat (1402). Bajazet himself fell into the conqueror's hands, and was still a captive when he died in 1403.

The battle of Angora gave Constantinople a reprieve for fifty years. Manuel, whose western journey had given him little beyond experience and discouragement, was unexpectedly able to return to his capital and to banish the nephew whom necessity rather than affection had compelled him to admit as a colleague. It is true that he had to pacify Timour by paying to him the same tribute as he had owed to Bajazet. But the Tartar had too much to do in the east to undertake the conquest of Europe, and his destructive career came to an end in 1405 as he was on his way to attempt the subjugation of China. The Ottoman power seemed to be annihilated. Not only did the Seljuk emirs in Asia recover their independence, but for ten years after Bajazet's death his four sons carried on a fratricidal struggle for the succession. Yet all that the Emperor Manuel could gain from such extraordinary good fortune was the recovery of Thessalonica and a few districts in Thessaly and Epirus. When in 1413 Mohammed I succeeded in reuniting his father's dominions, the Greek emperor with the other European vassals hastened to renew their submission; and the sultan met with so little difficulty in Europe, that he was able to devote the remaining eight years of his reign to the reduction of the princes of Caramania and other opponents

Battle of Angora, 1402.

Revival of the Ottoman power.

in Asia. The extraordinary rapidity with which the Ottomans recovered their power after the apparently shattering blow of 1402 proves that their authority, thanks to the wisdom and ingenuity of Orchan, rested upon far stronger foundations than that of any other Asiatic conquerors.

Mohammed I. was succeeded in 1421 by his son Amurath II. Manuel Palæologus, rendered confident by the unbroken peace of the last few years, was bold enough to stir up opposition against the new sultan by supporting a pretender who claimed to be a son of Bajazet. Amurath had no difficulty in defeating and putting to death the rival claimant, and in 1422 he undertook another siege of Constantinople in order to punish the emperor's insolence. An attempt to carry the walls by storm was repulsed with heavy loss to the assailants, but the raising of the siege was due to a rebellion in Asia in favour of a brother of the sultan. When in 1424 Amurath returned to Europe after putting down disorder in the east, Manuel hastened to appease his wrath by the payment of increased tribute and by the cession of several cities in Thrace.

John VI., who succeeded his father, Manuel II., in 1425, was perhaps the feeblest of all the Palæologi. His whole reign was spent in endeavouring to evade dangers which he was incapable of confronting. The best known event of his reign is the Council which was held in 1438 and 1439, first at Ferrara, and then at Florence, to negotiate for the union of the eastern and western Churches (see p. 236). As far as the powers of the Council went, the treaty of union was fully and finally ratified. But the Greeks could resist their own ruler with more courage and confidence than they could face the infidel assailant, and such a storm of reprobation greeted the return of the emperor and the envoys that they hastened to disavow their formal acts. The decrees of the Council of Florence remained a dead letter. It was fortunate for John that he had no occasion to rely either upon western aid or upon the loyalty of his

subjects. His very weakness and pliancy disarmed hostility and avoided all occasions of rupture. His reign was a period of almost complete peace. Thessalonica, which had repudiated the rule of Constantinople and put itself under the protection of Venice, was conquered by Amurath in 1430. But with this exception the Sultan paid little attention to the Byzantine empire, and devoted all his energies to war with more formidable enemies in the north and west.

In 1427 a new king came to the throne of Serbia, and set himself from the first to repudiate the vassalage to which his predecessors had been subjected since the great battle of Kossova. The Wallachians and Bosnians were inspired by the same sentiments, and George of Serbia purchased the aid of Sigismund of Hungary by ceding the great border fortress of Belgrade. Against this powerful confederacy Amurath waged a successful war for several years. In 1438 he had advanced as far as Semendria; and Albert of Austria, who had succeeded Sigismund on the throne of Hungary, vainly endeavoured to compel the sultan to raise the siege. Semendria fell, but the war was checked for a time by an outbreak of dysentery in both armies, and Albert perished of the disease. This was followed by an event which for a moment turned the balance in favour of the Christians. In 1440 Hungarians offered their vacant crown to Ladislas of Poland in order to enlist the aid of the great house of Jagellon. For four years the combined Slavs and Magyars not only held their own against the dreaded Janissaries, but even gained some notable successes. Under the leadership of John Hunyadi the allies repulsed the Turks from the walls of Hermanstadt and defeated them in the open field (1442). In the next year Hunyadi crossed the Danube, routed a Turkish army near Nissa, and pursued the fugitives in a brilliant march across the Balkans. These successes extorted from Amurath the treaty of Szegedin (July 12, 1444), by which he abandoned his suzerainty over Serbia and Bosnia, and allowed Wallachia to be annexed to

Amurath II.'s wars with Hungary.

Hungary. So chagrined was the sultan at this unexpected reverse, that he resigned the government to his son, Mohammed, and retired to seclusion at Magnesia. This news inspired the Christian princes and prelates with the belief that the Ottoman power was on the verge of ruin, and that another effort would suffice to bring about its complete overthrow. The representations of Pope Eugenius iv. and his legate persuaded Ladislas, against the advice of Hunyadi, to repudiate the treaty of Szegedin and to renew the war. The Hungarian army crossed the Danube into Bulgaria, marched to the coast of the Black Sea, and captured the important town of Varna. But Amurath had been roused from his retirement by the news of this act of Christian treachery. Hastily collecting his troops, he advanced to Varna. In the battle which ensued the invaders were scattered to the winds, and Ladislas was slain (November 10, 1444). Servia and Bosnia were once more reduced to submission; and although Hunyadi tried to renew the struggle in 1448, he was defeated and taken prisoner in the second battle of Kossova.

Amurath had retired for the second time to Magnesia after the victory of Varna, but he was recalled by the outbreak of disorders which Mohammed was unable to quell, and he continued to rule till his death in 1451. During his last years he was busied with a rising in Albania, headed by George Castriot, or Scanderbeg, as the Turks called him. This famous patriot had been trained in the Turkish service, and thoroughly understood the strength and the weakness of their tactics. Collecting round him a band of hardy mountaineers, he avoided all conflicts in the open ground; and, aided by the difficult character of the country, maintained a harassing guerilla warfare for more than twenty years. But though he caused great annoyance to his enemies, he was not strong enough to divert them from the career of successful aggression which has given to a prince, who had twice shown an apparent incapacity for government, the name of Mohammed the Conqueror.

Mohammed II. ascended the throne with the firm determination to reduce the tributary states into complete subjection, and to begin the work with the Greek Empire. The year 1452 was spent in open preparation for the siege of Constantinople. A fort was built upon the Bosphorus, troops and stores were collected from all parts of the Turkish dominions, and foreign engineers were employed to construct larger cannon than had ever yet been employed in warfare. Constantine, who had succeeded his brother John in 1448, was fully aware of the danger which threatened his capital. To remove any difficulties with the western powers he confirmed the acts of the Council of Florence, and the union of the Churches was formally celebrated in St. Sophia. The bigoted Greeks looked on in sullen indignation, and resolved to do nothing for a prince who thus paltered with heresy. And Latin Christendom was not prepared to do anything in return for this tardy acceptance of its creed. France and England were exhausted by their long struggle, which was just ending in the loss of the English possessions on the mainland; Philip of Burgundy was absorbed in the extension of his rule in the Netherlands; Germany was hopelessly distracted; and Frederick III., the weakest of emperors, was unable to govern even his own hereditary provinces. In the eastern states the disputes that had gathered round the succession of Ladislas Postumus distracted attention from vital interests in the distant Balkan peninsula. The only peoples who could give any aid to the Greeks were the Venetians, Genoese, and Catalans, whose trade with the Levant impelled them to do all in their power to maintain the feeble ramparts of Christianity against the Turks; and their forces, scanty as they were in proportion to the work to be performed, provided the only efficient garrison for the city of the eastern Cæsars.

Mohammed
II. takes
Constanti-
nople.

In the spring of 1453 the great siege began. The first general assault was repulsed; and a Genoese squadron, by superior weight and seamanship, forced its way through the

immense Turkish flotilla which attempted to exclude the arrival of supplies and reinforcements by sea. But this was the last success of the defenders, whose limited numbers had to hold five miles of fortifications against an overwhelming attack. On the 29th of May the last assault was ordered, and after a desperate struggle for two hours the Janissaries forced an entrance through a great breach which the artillery had made in the wall. The Emperor Constantine, whose heroism did something to redeem the cowardly incapacity of his predecessors, fell at the head of the defenders of his capital. The mass of the Greeks did nothing to resist the advance of the victorious assailants, and Mohammed II. made a triumphal progress to the Church of St. Sophia, which witnessed on that day the first celebration of the worship of the Prophet. The measures of the conqueror were marked by consummate wisdom. To conciliate the bigotry of the natives, which had signally contributed to his victory, and to interpose a permanent barrier between his new subjects and western Christendom, Mohammed proclaimed himself the protector of the Greek Church, and allowed the installation of a new Patriarch, whose gratitude should take the form of servility to his Mussulman patron. To remove the disastrous results of the siege, Mohammed set himself to restore the buildings of the city, and to encourage the immigration of settlers from all parts of his dominions. Before the end of his reign Constantinople was more populous and more flourishing than it had been at any time under the rule of the Palæologi.

The European powers were aghast when the news arrived that Constantinople had fallen; but as they had been impotent to save the city, they were still more unable to attempt its recovery with any prospect of success. This was fully recognised by those states which were most immediately concerned. The Venetians and Genoese continued their inveterate rivalry in the haste with which they made terms with the conqueror, and purchased the retention of their

trading privileges and of their possessions in the east by the payment of tribute. The two brothers of Constantine, Demetrius and Thomas, who had established themselves as petty princes at Patras and Mistra in the Morea, obtained temporary recognition upon similar terms, and even received Turkish aid to put down a rebellion among their subjects. Leaving these self-seeking vassals in their humiliating dependence, Mohammed turned his arms to the subjection of the tributary states in the north. In 1455 he advanced through Servia, expelled its king, and in the next year laid siege to Belgrade. Here he met with his first and most serious reverse. The crusading army raised by Hunyadi and Capistrano not only relieved the fortress, but drove the sultan and his shattered army in disorderly flight to Sofia (see p. 412). This signal triumph saved Hungary and eastern Germany from serious danger for eighty years, but it failed to effect the liberation of the Balkan states. The Hungarian hero died on the scene of his greatest exploit; and the subsequent death of Ladislas Postumus, and the difficulties attending the succession, distracted the attention of Hungary from the eastern war. Mohammed II. returned to the attack with renewed vigour, and in 1457 and 1458 Servia was again overrun and made a province of the Ottoman dominions. For the next three years Mohammed was engaged with war in Albania and in Greece, but in 1462 he again turned northwards and completed his work by the annexation of Wallachia (1462) and of Bosnia (1464).

Conquest of
Servia,
Wallachia,
and Bosnia.

The incompetence of the two surviving Palæologi, Thomas and Demetrius, and their incessant quarrels with each other, created such anarchy in the Morea that intervention was almost forced upon the Turks. At first a few garrisons were sent to the chief cities for the enforcement of order, but in 1460 an army was despatched to take more stringent measures. Resistance was hopeless. Demetrius was taken prisoner and conveyed to Asia Minor, where

Conquest of
Greece.

a small territory was assigned to him rather as a place of exile than as a principality. Thomas fled in a Venetian galley to Corfu, and thence made his way to Rome. By the end of the year the whole of the peninsula, with the exception of a few harbours which were held by the Venetians, was in Turkish occupation. At the same time, the Turks were also active to the north of the isthmus of Corinth. The last duke of Athens was put to death by the bowstring; and his duchy, with the other Frankish principalities which had survived since the partition of Greece among the Crusaders, was annexed by the Turks. In the Ægean the conquest of the islands was undertaken by a Turkish fleet, and was completed in 1462 by the capture of Lesbos. Only Rhodes continued to make good its resistance under the Knights of St. John.

The annexation of Greece constituted a serious danger to the Venetians, who now held the only considerable possessions in the east which were left under Christian rule. So far they had gained rather than lost by the fall of Constantinople, because their treaty with Mohammed in 1454 had given them greater advantages over the Genoese than they could have extorted from the Palæologi, who had usually favoured their rivals. But a series of significant events convinced them that the sultan was not likely to observe the treaty any longer than his interest impelled him. While he was still confronted with serious problems in the north and the south, he had good reason for desiring to pacify Venice. But his successive conquests had removed these difficulties from his way, and there was no longer any substantial reason for allowing the Venetian dominions to escape the fate that had attended the other tributary states. There had always been a party in Venice which had opposed the policy expressed in the treaty of 1454; and the obvious approach of danger, heralded by the fall of Lesbos, enabled this party to gain the upper hand in 1463. It is needless to trace the history of the war, which has been already alluded to in connection with the history of Venice (see Chapter

xii.). On the whole, it was creditable to the capacity and the resolution of the great maritime republic; and though the Venetians could not prevent the loss of Negropont and the conquest of Albania, which had been left under their protection on the death of Scanderbeg, they obtained better terms than were given to any other opponent of Mohammed. By the treaty of Constantinople in 1479 the Turks obtained Albania and the islands of Negropont and Lemnos, but Venice was able to keep her possessions in the Morea and some of her trading privileges in the Levant on payment of increased tribute. The Venetian quarter in Constantinople was restored under the administration of a bailiff appointed by the Republic.

The conquests of Mohammed II. were not confined to Greece and the Balkan peninsula. In Asia Minor he extinguished the independence of the feeble empire of Trebizond (1461), which had been allowed to remain in harmless obscurity under a branch of the Comneni ever since their expulsion from Constantinople in 1204. He also completed the subjection of the princes of Caramania, the most inveterate opponents of the Ottoman ascendancy. To the north of the Black Sea he extorted tribute from the Tartars of the Crimea, and ruined the Genoese by depriving them of their valuable establishments at Kaffa and Azof. In 1480 he undertook an enterprise which made almost more sensation in Europe than the siege of Constantinople. A Turkish force landed on the coast of Apulia and took possession of Otranto. For the moment men believed that the conqueror of the eastern empire would complete his fatal work by the capture of Rome, the capital of the west. But the dreadful anticipation was never realised. The death of Mohammed in 1481 led to the recall of the garrison from Otranto. Under his successor Bajazet II., the only one of the early Ottoman rulers who did not display conspicuous courage and ability, the progress of the Turkish

Other conquests of Mohammed II.

Mohammed's death, 1481.

arms was stayed for a generation, to be resumed again under Selim I., the conqueror of Egypt, and under the great Suleiman, who at last overcame the obstacle offered by Belgrade, and added to his dominions the greater part of Hungary. •

CHAPTER XXII

THE RENAISSANCE IN ITALY

Some differences between mediæval and modern history—The period of the Renaissance is the transition between the two periods—The Renaissance in its wider and in its narrower sense—Prominence of Italy in the Renaissance—The revival of letters—Dante, Petrarch, and Boccaccio—The age of collectors—The age of criticism—The revival of art—(1) Painting—(2) Sculpture—(3) Architecture—Humanism and the Reformation—The impulse given to education.

THE division of history into periods is always arbitrary, and always, if too rigidly interpreted, misleading. Yet some sort of division is not only convenient, but almost necessary, and the distinction between mediæval and modern history is as clearly marked as any distinction of the kind can be. It is, of course, impossible to fix upon any date, and to say that here the Middle Ages come to an end and modern times begin, just as it is impossible to say that on a given day in the year winter ends and spring begins. The changes in history, as in the seasons, are gradual, and not sudden. Between the great historic epochs there is a period of transition in which the changes which mark them off from each other are slowly developing, sometimes advancing, sometimes apparently receding, but ultimately, by a gradual evolutionary process, reaching completion. And another word of caution is necessary. It must be borne in mind that the Middle Ages—the period which follows the disruption of the Roman Empire by the immigration of the German peoples, and ends with the formation of the great national states which still exist—do not constitute a complete

homogeneous and stationary epoch. Social and political changes were not perhaps quite as rapid before the fifteenth century as they have been since the Reformation, but changes were constantly taking place. A generalisation about the eighth century cannot be applied without serious modifications to the eleventh or the twelfth. All attempts to estimate the Middle Ages as a whole can only be extremely superficial and general.

It follows that it is impossible to give any adequate account of the differences between mediæval and modern history in a few perfunctory sentences or paragraphs. The differences are real and substantial, but they must be felt rather than expressed, and can only be properly and usefully comprehended by a prolonged study of the past. There is, it may be said, a difference of historical atmosphere, to which some historians, eager above measure to find comparisons and parallels, have never become acclimatised, in spite of great learning and research. The often-quoted phrase that 'history is past politics' has been responsible for a woful number of anachronisms. For the historical student imagination, the power of projecting himself by a sort of instinct into the conditions and life of the past, is almost as necessary a quality as painstaking industry. And imagination is rather fettered than assisted by the attempt to express what it sees, in precise and formal language. For the immediate purpose of this chapter it will be better to abandon all attempt at minute precision or completeness of analysis, and to be content with pointing out three salient characteristics of the Middle Ages, which the modern reader should grasp at the outset. These may serve to guide him to the appreciation of other and deeper distinctions between that period and the more familiar times that have followed it.

In the first place, the modern conception of the state as a nation was very imperfectly grasped in the Middle Ages. The modern nations, such as the French, English, Spaniards, and others, were in process of formation, but they only became

fully conscious of their distinct corporate unity at the end of the period. Mediæval theorists—guided by the traditions of the Roman Empire, as modified by the influences of Christianity—regarded Christendom as a single state under two heads—the Pope and the Emperor—who held ecclesiastical and secular authority as delegates of the Deity. The best concrete illustration of this conception of unity is offered by the Crusades, which ended in failure, partly on account of the distance of the scene of action, but mainly because the unity of Christendom was theoretical rather than real. Internally western Christendom was organised under what is called the Feudal System, a semi-agricultural and semi-military organisation, in which the mutual rights and duties of classes to each other were regulated by the tenure of land, while industry, the most potent of modern forces, had no place in it. Allied with feudalism was the fantastic body of rules and customs known as Chivalry. Chivalry was as essentially non-national as Christianity itself. A French and a German knight had more in common with each other than either had with a French or German citizen or peasant.

In the second place, the social unit in the Middle Ages was not what it is now, the individual man, but a corporation; either the feudal unit which in England is called the manor, or the municipal commune, or within the commune the guild. There was no scope for the activity of the individual by himself. The only way in which an able and ambitious man could hope to rise from obscurity to eminence was by entering the greatest of all corporations—the Church.

Thirdly, the mediæval period was a period of ignorance. Learning and education were for the most part monopolised by the clergy, and in their hands were bound down by prescription and by ecclesiastical authority. Everybody knows with what ill-will the Church regarded freedom of inquiry and scientific research: the charge of heresy was always ready to be brought against a Roger Bacon or a Galileo. Moreover, quite apart from the influence of the Church, learning and

literature were withheld from the mass of the people by their expense. Printing was unknown, and paper was only introduced at the very end of the period. Parchment was so expensive that many of the manuscripts of ancient writers were erased in order to make room for monkish chronicles or service-books. Moreover, such literature as existed was in Latin, and that in itself was sufficient to close it alike to nobles, burghers, and peasants, most of whom were unable to read or write even their native tongue. And ignorance was, as usual, accompanied by gross superstition. To realise this it is only necessary to peruse the lists of marvels with which the mediæval chroniclers fill their pages, or to study the working of the judicial system in which the guilt or innocence of an accused person was decided by the ordeal.

The period of the Renaissance, in its proper and most comprehensive meaning, may be regarded as the age in which the social and political system of the Middle Ages came to an end, in which mediæval restrictions upon liberty of thought and inquiry were abolished. It may be said to begin in the thirteenth century, to be in full progress during the fourteenth and fifteenth centuries, and to be continued in an altered form in the religious struggles of the sixteenth century. It is, in fact, the period covered by the present volume. To this great epoch of transition, 'The Close of the Middle Ages,' belong a number of changes of the first magnitude: the decline of the Empire and the Papacy, and of the ideas and traditions with which they were connected; the growth and the hardening into shape of the French, Spanish, and English nations; the rise of national literatures and of the conception of national churches; the breaking up of feudalism and chivalry by the growing importance of industry; the overthrow of aristocratic and ecclesiastical predominance by the rise of the people to political influence; the growth of strong territorial monarchies based upon popular support, though in every country except England the monarchy kicked away its support as soon as it was

no longer needed. With these changes must be coupled the results of the great inventions and discoveries of the age: the employment of the compass and the astrolabe, and the consequent development of maritime adventure, which led to the finding of a new way to India and a new world across the Atlantic, and so to an enormous extension of knowledge and a complete alteration of the great trade-routes of the world; the discovery of gunpowder, and the revolution which it effected not only in the art of war, but also in the organisation of society, which in the Middle Ages was inextricably bound up with the military system; the invention of printing, followed by a vast extension and popularisation of literature and knowledge; and, finally, the great astronomical discovery of Copernicus, which overthrew the old belief in the stability and central position of the earth, and dealt a fatal blow to the vast structure of superstition which had been erected upon that belief.

All these vast changes belong to the Renaissance; they are all part of the development which has been aptly called a new birth; no one of them can be fully appreciated apart from the rest. Some of them have been alluded to in the preceding pages of this volume; all of them merit the most careful consideration; their mere enumeration is enough to show their immense importance. But a single chapter can only serve as a sort of sign-post, and the dictates of prudence compel a limitation of attention to two movements with which the name of the Renaissance has been pre-eminently and sometimes exclusively associated—the revival of letters and the revival of art. And it is to the Renaissance in this narrower sense that Italy rendered its most active and enduring services.

The revival of literature and art was peculiarly the work of Italy. It is not merely that the Italians began the work and that other nations carried it on to completion. The recovery of ancient literature and art and the application of the lessons to be learned from them to contemporary needs were both

begun and completed in Italy. It was only after this completion that the other countries came in to learn the lessons which Italy was able and ready to teach them.

Prominence of Italy in the Renaissance. It is true that the spirit inspired by this teaching was applied by the other nations with great results to the reform of religion, to the extension of geographical knowledge, and to new discoveries in the realms of science. But this must not blind us to the magnitude and completeness of the task accomplished by Italy single-handed; nor must it be forgotten that, in the departments of painting and sculpture at any rate, the actual achievements of the Italians have never been surpassed by their pupils.

Nor is there anything surprising in the prominence of the part played by Italy in the intellectual Renaissance. Although Italy, like the other provinces of Rome, fell a victim to the barbarian invaders, yet the tradition of supremacy which Roman victories had created was not wholly destroyed, and it was revived with the growing authority of the Papacy during the Middle Ages. Moreover, the geographical position of Italy was of immense importance in an age when the Mediterranean was still the centre of the world's commerce. Trade and manufactures brought wealth to the great civic communities of Italy, to Florence, Venice, and Genoa, and wealth has rarely failed to create a sense of self-importance, a consciousness of power and a desire for freedom, while at the same time it supplies the leisure requisite for prolonged intellectual exertion. But it may be thought—after what has been said before—that the Church, having its central seat and authority in Italy, would be strong enough to suppress independence of thought and inquiry. But to this suggestion two answers may be made. It is an old saying that familiarity breeds contempt. The Italians had no objection to the presence of the Papacy in their midst. On the contrary, it flattered their pride to think that Rome was still the head of a great spiritual empire, as it

had once been of a vast territorial power. Moreover, the tribute of other states was poured into Italy by way of the papal coffers; and Italians had, if not a monopoly, at any rate a preponderant share in the cardinalate and other lucrative offices in the Church. But at the same time the Italians by no means felt the same superstitious awe and reverence of the Church and Papacy as prevailed in more distant countries. The ecclesiastical thunders of excommunication and interdict were much less dreaded by people who could see the working of the machinery which could produce such awful sounds. The abuses of the papal court, which ultimately produced the indignant revolt of the greater part of northern Europe, were so familiar to the Italians that they were hardly scandalised by them. Thus though the Italians, as a whole, showed little zeal for religious reform, they were, at any rate the wealthier classes, usually free from superstition and unlikely to tolerate ecclesiastical despotism.

It is also to be noted that the popes in Italy did not always pursue a policy of enlightened devotion to their spiritual interests. These interests were, or were thought to be at a later time, opposed to freedom of thought, and therefore to such an advance in literature and art as would favour such freedom. But the popes were secular princes as well as heads of the Church. The central provinces of Italy constituted a considerable temporal principality; and it frequently happened that the interests of this principality by no means coincided with the interests of Roman Catholicism throughout Europe. The same motives which made so many Italian princes the munificent patrons of literature and art appealed to the popes also in their secular capacity. They, too, desired to have a magnificent and learned court; they were ambitious to compete with the Medici of Florence and with the kings of Naples; they wished to have their palaces and their churches built and adorned by the most eminent artists of their time; they were eager that their praises should be handed down to posterity by men

*The Papacy
and the
Renaissance.*

whose genius would secure immortality to their patrons as well as to themselves. Thus individual popes, such as Nicolas v. and Leo x., were the industrious furtherers of the Renaissance ; and they unconsciously stimulated a movement which was destined to overthrow the magnificent structure of ecclesiastical autocracy which had been built up by their great predecessors from Gregory vii. to Innocent iii. Such shortsightedness has many parallels in history. It is easy to recall how the French nobles in the eighteenth century flirted with a philosophy which preached the doctrine of popular rights and liberties ; and how the French monarchy gave practical aid to a rebellion which secured such rights and liberties in North America, thus encouraging the advance of that Revolution which for a time swept the French monarchy and the French nobility from the face of the earth.

Turning now to a rapid survey of the actual achievements of Italy, we find that the revival of literature and art was not only a stimulus to intellectual progress and a deathblow to ignorance and superstition ; it also marks a great step in the freedom of the individual from mediæval restrictions. In art, and still more in literature, the individual found a career by which he could exercise his highest talents, and in which he could attain a personal eminence hitherto impossible. Dante, who stands on the threshold of the Renaissance, was the first great man in the Middle Ages who stood out by himself, unconnected with any corporate body or institution. He used to boast exultingly that he was his own party. The *Divine Comedy* gave literary form to the first of the new living languages of Europe. For Italy the work was almost too great ; it has left too weighty an impression upon his fellow-countrymen. To this day it is the highest ambition of an Italian writer to use the language of Dante, and he must have frequent recourse to a dictionary to make sure that his words were really current in the thirteenth century. It is never wholesome to have too marked a distinction between the language of literature and

hat of ordinary life, and this servile habit of looking back has checked the growth of a really great Italian literature in later times. But Dante, with all his greatness, was not really imbued with the modern spirit. He had not emancipated himself from the ideas of his time, though he had raised himself above them. In his *De Monarchia* he willingly surrendered himself to the scholastic philosophy, and made a vigorous effort to defend the already effete and worthless theory of a universal empire. Dante stands on the threshold of the Renaissance, but he is rather the last giant of the Middle Ages than the herald of a new epoch.

Dante was followed by Petrarch, whose sonnets have influenced literary form in all countries, while his passionate devotion to the literature and liberty of the ancients makes him the first of Italian humanists. A contemporary of Petrarch was a man of still greater original genius, Giovanni Boccaccio. Like Petrarch, Boccaccio was a great lover and student of ancient literature, and he did much to introduce the study of Greek into Italy. But it is as the author of the *Decameron* that he is entitled to the greatest fame. In this collection of stories he displayed a contempt for superstition and a delight in life which were alien to the spirit of the Middle Ages. Chaucer borrowed many plots of the *Canterbury Tales* from the *Decameron*; and through Chaucer and other writers Boccaccio has influenced the whole of later English literature.

These three great men were followed by a crowd of collectors, men who travelled throughout Europe and even beyond it in search of manuscripts of ancient authors. It is almost impossible nowadays to appreciate the extraordinary ardour with which the search was carried on. In some cases the greed for these new and valuable possessions tempted men into actions which in a less worthy cause would have merited the name of fraud. The greatest of these collectors, who really performed an invaluable service to the world with marvellous industry and success, were Poggio Bracciolini, Francesco Filelfo, and

Niccolo Niccoli, the founder of the library of St. Mark in Florence. Their most bountiful patrons were Cosimo de' Medici, the 'father of his country,' and Pope Nicolas v. During this period, which is roughly the first half of the fifteenth century, the Italian language seemed likely to fall into oblivion. The only great writers in Italy were Poggio and Æneas Sylvius, and they both wrote solely in Latin. That Italian did not go wholly out of fashion was due, in the first place, to the influence of the Medici in Florence. One great object of their ambition was to attract the most learned men of the day to their court. But their anomalous position as despots masquerading in republican robes compelled them to appeal to popular favour. Hence even their studies had to some extent to be regulated so as to please the people. The magnificent Lorenzo himself set an example by writing the famous 'carnival songs' to be sung at popular festivals. These songs have a place of their own in the history of Italian literature; but they are of special importance as showing how a great prince, in the midst of Greek and Latin studies, could find time to cultivate the language of the people. The finest Italian poem of the century is the *Giostra* of Politiano, who was not only an eminent scholar, but also a courtier and a favourite companion of Lorenzo de' Medici.

In classical studies the second part of the fifteenth century was not so much an age of collection as an age of criticism. Men set themselves to read and interpret the treasures which had been already brought together, and they were insensibly led to apply the teaching of ancient writings to the circumstances and problems of their own time. Prominent among the scholars who gave to the world the fruits of their researches were Lorenzo Valla in Rome and Naples, and Ficino and Politiano in Florence. It is impossible to over-estimate the solvent influence of these studies upon human thought. Much of the scholastic philosophy which had been based upon a corrupt translation of

Aristotle from the Arabic gave way at once before a study of the philosopher's original text. All kinds of delusions and superstitious beliefs were overturned by the new spirit of inquiry. Lorenzo Valla published a treatise to prove that the pretended Donation of Constantine, upon which the popes had professed to base their claim to temporal sovereignty, was a forgery. Valla was at this time in the service of Alfonso the Magnanimous of Naples, who had quarrelled with the Pope. Under his protection Valla went on to attack the whole ecclesiastical system, and especially the moral decline of monasticism. These may serve as illustrations of the influence exerted by the new culture. In fact, so great was the energy displayed in the work of destruction, that it seemed probable that all the old religious bonds would be broken before anything had been found to take their place. If Italy had stood alone, this might have been the case. But by this time the new learning had begun to spread to other countries. The more sober temperament of the Germans revolted against the extravagances of many of the Italian scholars. Luther and Reuchlin were impelled by the critical spirit of the age to revolt against the mediæval system, but they were not content with mere negation, and their revolt, constructive as well as destructive, has been called the Reformation.

If we can trace to the Italians the origin of modern literature, we may with still greater confidence call them the creators of modern art, or at any rate of the arts of painting and sculpture. Architecture was the only form of art which did not fall into decay during the Middle Ages, and in which the northern peoples may claim at least equality with the people of Italy. But in painting and sculpture the Italians can claim not only that they are entitled to all the glories of their revival, but also that they brought these arts to their highest perfection. This is far more than can be said of their services to literature.

In the Middle Ages painting was so bound down by fixed

and arbitrary rules that it hardly deserved the name of an art. It was employed only for religious purposes, and it was forced to conform to the dominant religious spirit. Custom and tradition regulated not only the subject and its treatment, but even the very colours to be employed. Any departure from these recognised rules, if it had been possible, would have been regarded as impious. The altar-pieces of mediæval churches were covered with stiff and lifeless representations of madonnas and saints. These had a conventional value, and no artistic standard was dreamt of. There were many pictures, but no artists. The individual, as was so often the case in the Middle Ages, was repressed and kept down by the society of which he was perforce a member. Anybody can obtain a concrete illustration of the differences in painting between the Middle Ages and modern times, who can compare a picture of Cimabue or any other contemporary artist with a picture by Titian. The Renaissance, which bridges over the gap between these artists, is the steady though gradual assertion of the freedom of the individual from the bondage of mediæval rules and traditions. The change may be traced in the increased love of nature, in the new reverence for and study of the human figure, and in the improvement of artistic methods. The most important of the technical changes were the introduction of fresco for wall-pictures, the discovery of oil-colours, which is to be credited to the Flemings, and the employment of copper-plate and woodcuts, which made it possible to reproduce and disseminate great works of art. But still more important than any change in method was the change in the very spirit of art; for the old stereotyped forms were substituted imitations of the beautiful from Nature. The study of anatomy and perspective became necessary for a painter. Works of art ceased to be mechanical copies of a pattern prescribed by ecclesiastical authority; they became an index to the mind of the free artist. The change marks a complete alteration in the motives of religion as well as of

art. Religion ceased to be a superstitious reverence for something unearthly and inhuman ; it was brought into closer relation with the ordinary life of men and women.

The beginning of the Renaissance in painting is usually placed in the fourteenth century. At that time two great art cities, Florence and Siena, were especially prominent. The first great Florentine artist whose name has been handed down to posterity is Cimabue. His Sienese contemporary was Duccio. In their works we see the first conception of the beauty of the human face and figure, though they were still bound down to the old stiffness of composition and the prescribed distribution of colours. They were followed by a number of artists who have obtained lasting renown. In Florence Giotto, equally great as a painter, sculptor, and architect, founded a school which raised the whole character of art, besides effecting a great improvement in technique. Giotto was the first to substitute dramatic painting for the stiff and lifeless representation of human figures which had hitherto been universal. With him may be coupled the name of Andrea Orcagna, Ambrogio Lorenzetti, and Fra Angelico, though the last-named belongs chronologically to a somewhat later period. But of these men the same observation may be made as of Dante in literature. They are rather the greatest men of an age which is already passing away than the beginners of a new period. Giotto especially is the Dante of art. He and his contemporaries sum up in a pictorial form the mediæval theories and conceptions of religion and of human life. To their representation they contribute a vast improvement in manner and style, as did Dante in his great poem, but what they represent is essentially mediæval. In fact, if any one wished to see the Middle Ages before his eyes, he might be referred to three great pictures of this period. The gloomy personal religion, which weighed down the spirits of thoughtful men in the Middle Ages, may be seen in Orcagna's picture, 'The Triumph of Death,' in the Campo Santo of Pisa. On the other hand,

the converse side of religious life in the Middle Ages, the grand and awe-inspiring organisation of the Church, is represented in 'The Church Militant and Triumphant,' the work of Giotto's pupils, in the Spanish Chapel of Santa Maria Novella in Florence. And the stormy political life of a mediæval commune may be studied in the frescoes of Ambrogio Lorenzetti, entitled 'Civil Government,' on the walls of the Palazzo Publico of Siena.

It is when we leave the school of Giotto and his pupils, and turn to the next generation of painters in the fifteenth century, that we find the artistic change associated with the Renaissance in full progress. Florence was still the most important city in the history of art. The first great painter in this transition period was Masaccio. His frescoes in the Brancacci Chapel of the Church of the Madonna del Carmine at Florence may be taken as illustrating the next marked advance in independence and artistic beauty from the days of Giotto. These works exercised great influence upon all later artists, and especially upon Raphael, who made them the subject of special study. Masaccio was followed by a large number of eminent painters, among whom may be named Filippo Lippi, in connection with whom Browning's poem gives so vivid a picture of the artistic struggles of the early Renaissance, Sandro Botticelli, who was the first to introduce classical myths and allegories as alternative subjects with the old Biblical stories, Filippino Lippi, Domenico Ghirlandaio, and Luca Signorelli. The last is perhaps in some way the ablest, though by no means the most pleasing, of the fifteenth century painters. In the boldness of his conceptions, in his knowledge of anatomy, and in his contempt for arbitrary and meaningless rules, he is not only the fore-runner but the rival of Michael Angelo. But Florence, although the most important, was by no means the only city in which this artistic revolution was taking place. The same sort of work was being done in Perugia by Pietro Perugino, the tutor of Raphael, in Padua by Andrea Mantegna, one of

the greatest of fifteenth century painters, and, above all, in Venice by Giovanni and Gentile Bellini and by Vittore Carpaccio. It was the work of these men, in addition to that of the Florentine and many other painters, which prepared the way for the supreme artists of the sixteenth century—Leonardo da Vinci, Michael Angelo, Raphael, Andrea del Sarto, Giorgione, Titian, and Tintoretto. These painters still devoted their talents mainly to the illustration of religious subjects; but they treated these subjects in a human and secular spirit. The religious and devotional aspect was subordinated to the desire for artistic perfection of form and colour, and to the exciting of natural associations in the minds of men and women. There is nothing really irreligious in their art, though it shows a new way of regarding both art and religion. At the same time, it is possible to discover in these artists of the completed Renaissance a certain relaxation of moral earnestness and purpose as compared with their predecessors; their very mastery of colour and of drawing seems to mislead them; there is no longer the noble struggle to express a lofty meaning in spite of difficulties and drawbacks. It was the perception of these differences which led many thoughtful artists and art students, who formed what has been called the pre-Raphaelite school, to devote themselves to the study of the earlier and less faultless painters of the fifteenth century, and somewhat to undervalue the more mature artists who had been the idols of previous generations.

The Renaissance marks almost a greater epoch in the history of sculpture than in that of painting. In some respects the change which took place was the same. Great artists revolted against the pre-^{2. Sculpture.}scribed forms of the Middle Ages, and produced works of greater beauty and greater originality. But sculpture was more profoundly influenced than painting by the revived study of antiquity. The great painters of ancient Greece were mere names, their works had perished. It was therefore

only the classical spirit that influenced painting. Direct imitation was impossible. With sculpture it was otherwise. Greek and Roman statues were still in existence, and many that had been buried were unearthed and welcomed with passionate reverence. In some of these statues had been realised the utmost possible beauty of form and truth to nature that were possible in sculpture. It was impossible to surpass them, and before long the passion for antiquity led to a servile imitation of the ancient originals. But the first enthusiasm did produce a few great master-workers who rivalled the artists of Greece. The first to inaugurate the new epoch in the history of sculpture was Niccolo da Pisano. A Greek sarcophagus, still preserved, had been brought to Pisa, and Niccolo was induced by its beauty to make a thorough study of Greek forms and methods. From this time he set himself to reconcile, as far as was possible, the Greek love of beauty with the traditions of Christian art. He was followed in the next century by a number of great sculptors, most of whom were Florentines. Among their names the most important are those of Lorenzo Ghiberti, who carved the gates for the Baptistery in Florence, which Michael Angelo declared worthy to be the gates of Paradise; Luca della Robbia, whose chief works are reliefs in terra-cotta; Donatello, the sculptor of the famous figure of David; and Andrea Verrocchio, the modeller of the grand equestrian statue of Bartolommeo Coleone, which stands near the Scuola di San Marco in Venice. After them came the great masters of Renaissance sculpture—Benvenuto Cellini and Michael Angelo. The Memoirs of the former may be commended to any one who wishes to study the purely artistic temperament, uninfluenced by considerations of religion or morality, which was produced in the later stages of the Renaissance. Sculpture, it must be remembered, was more essentially non-religious and pagan than painting. The beauty of the face was necessarily subordinate to beauty of figure. Thus the new religious impulse of the sixteenth century, which led to

the Reformation in northern Europe and to the counter-Reformation in the south, was in many ways alien or hostile to sculpture, and from this time the art tended to decline.

In architecture the Renaissance exerted an overwhelming and permanent influence, and here again Italy led the way, but it may be questioned whether the influence resulted in unmixed gain. Architecture had never been a lost art, as painting and sculpture had been. Nor was classical influence a new thing, for the Romanesque style of the early Middle Ages had been based upon ancient models. Beyond the Alps the early Romanesque buildings had been followed by the great Gothic churches and cathedrals which remain the great monument of the religious zeal of the Germanic peoples in the later Middle Ages. Gothic architecture had been introduced into Italy by German builders in the later part of the thirteenth century. But Italian Gothic was a different style of architecture from that which prevailed in the northern countries. From the first it had been modified by national usages and by considerations of climate. The great Gothic churches of Italy are the cathedrals of Orvieto and Siena, and they are very different from the Gothic cathedrals of Germany, France, and England. The excessive height in proportion to the width and length, the enormous arches, and the flying buttresses are absent in Italy. Italy never departed altogether from the classical models.

The Renaissance in architecture, as in sculpture, was the result of the revival of classical studies ; and its formal changes are to be seen in the return, first to the round arch of the Romanesque period, and later, in the use of the flat top or lintel of the Greeks and Romans. The great building of the early or transitional Renaissance is the Cathedral of Florence, with its magnificent dome, the work of Filippo Brunellesco, and the progress of the movement, may be traced in St. Peter's in Rome, designed by Bramante, but modified and completed after his death, and finally in the palaces built by Palladio in

Vicenza and Verona. Thus only the beginning of the architectural Renaissance belongs properly to the period covered in this volume, whereas much more progress had been made in painting and sculpture by the end of the fifteenth century. And its ultimate results were in many ways alien to the true spirit of the real Renaissance. Gothic architecture, whatever its defects, had given great scope for originality. After the main design had been agreed upon, the completion of details had been left in great measure to the ability and imagination of the individual workmen. But the architecture of the later Renaissance laid supreme stress upon symmetry and uniformity. Thus the workmen could no longer be allowed to be original. Every detail, as well as the central design, had to be fixed from the outset. The result was magnificent and imposing, but it was purchased at the sacrifice of originality and imagination. When the first vigour of the intellectual revival was spent, there was a marked decline in architecture as in sculpture, because in both the imitative faculty was cultivated rather than the power of independent creation.

The Renaissance, like all great historic movements, contained good and evil intermingled together. Its two prominent directions, especially in its earlier period, were the revival of classical influences in literature and art, and the vindication of originality of thought and of individual freedom. Both had their special dangers, and they only went together for a limited distance. The first tended to degenerate into the slavish and mechanical imitation of ancient models; the second led in many cases to atheism, to licence, to the chaos of pure negation. Nor were these the only evils. The Renaissance spirit of free inquiry, when applied to religion, gave rise to the Reformation, and the religious Reformation hastened to turn against the spirit that had given it birth. Extreme Protestantism or Puritanism was in many ways diametrically opposed to humanism. Savonarola, who may be said to represent the Puritan spirit upon Italian soil, urged his

Humanism
and the
Reforma-
tion.

followers to make bonfires of their pictures, their personal ornaments, and even of their books. The English Puritans denounced the love of beauty in art as a carnal and misleading pleasure. The Protestants, who owed their origin to the assertion of freedom of thought and worship, soon came to erect a rigid system of dogma and church government, which was fully as repressive and intolerant as that against which they had revolted. The persecution which they resisted with such heroism impelled them, unfortunately, not to practise toleration, but to become persecutors in their turn.

That the good results of the Renaissance were not entirely destroyed or overwhelmed either by the evils of the movement itself or by the reaction provoked by those evils, is due to the impulse which the Renaissance and the Reformation both gave to education. In every country the introduction of the new learning and the reformed religion was followed by the creation of new schools and universities, and by the improvement of educational methods in the institutions which already existed. To the spread of education we owe the greatest and most permanent result of the Renaissance, the union, instead of the antagonism, of morality and culture. And this union has resulted in a higher morality than that inspired by compulsory beliefs and compulsory observances—the morality of the free mind and conscience of the individual.

APPENDIX

GENEALOGICAL TABLES

A—THE SUCCESSION IN BOHEMIA. (See p. 15.)

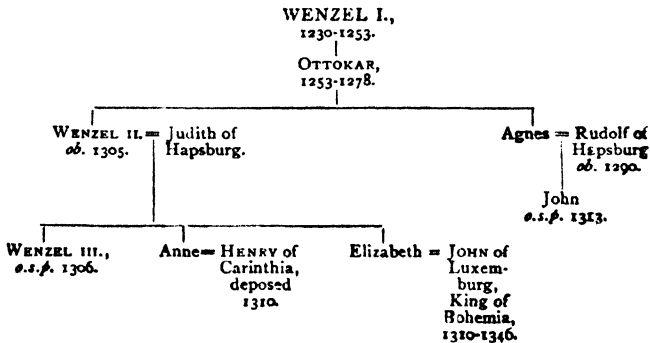

B—THE SUCCESSION IN TYROL. (See pp. 107 and 120.)

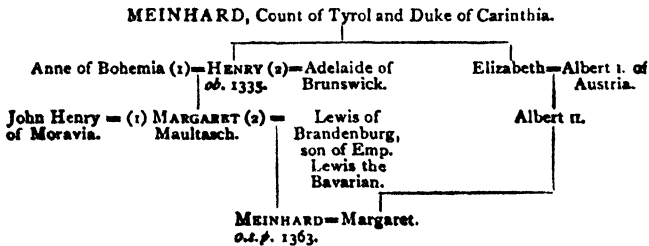

C—THE HOUSE OF HAPSBURG

RUDOLF I., 1273-1291.

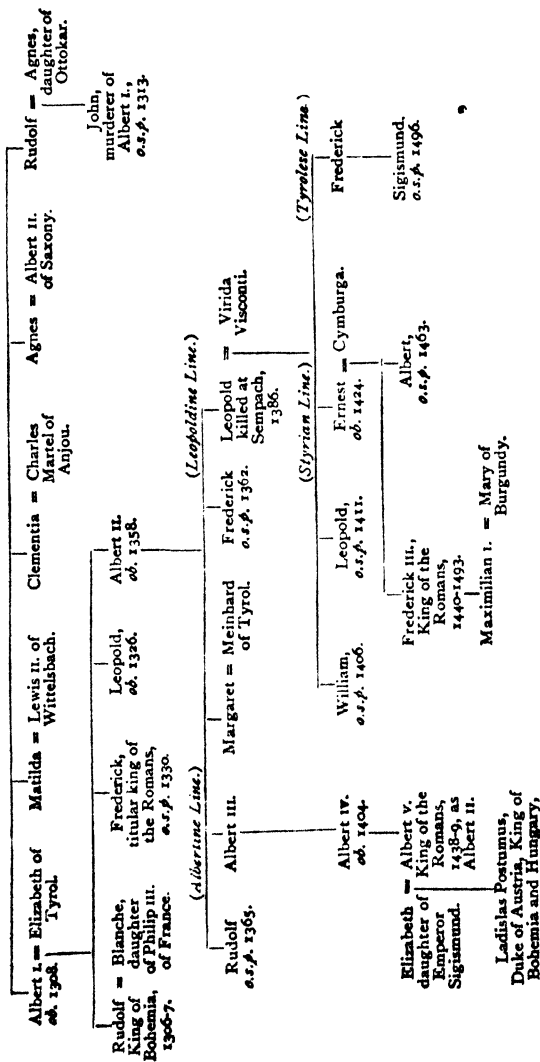

Norm.—The Hapsburg territories were divided between Albert III. and his brother Leopold, the former taking Austria, and the latter all the rest. Of the sons of Leopold, Ernest succeeded to Styria and Carinthia, Frederick to Tyrol and the lands in Swabia. The Albertine line became extinct with the death of Ladislas Postumus, when Austria passed to Frederick III., and the latter's son, Maximilian I., reunited all the territories of the house.

D—THE HOUSE OF WITTELSBACH

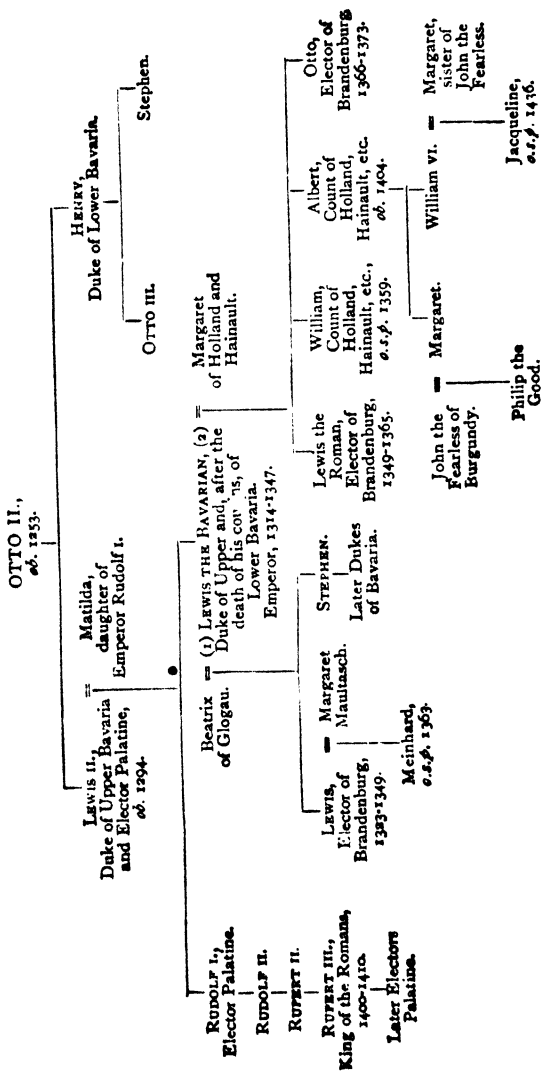

E—THE HOUSE OF LUXEMBURG

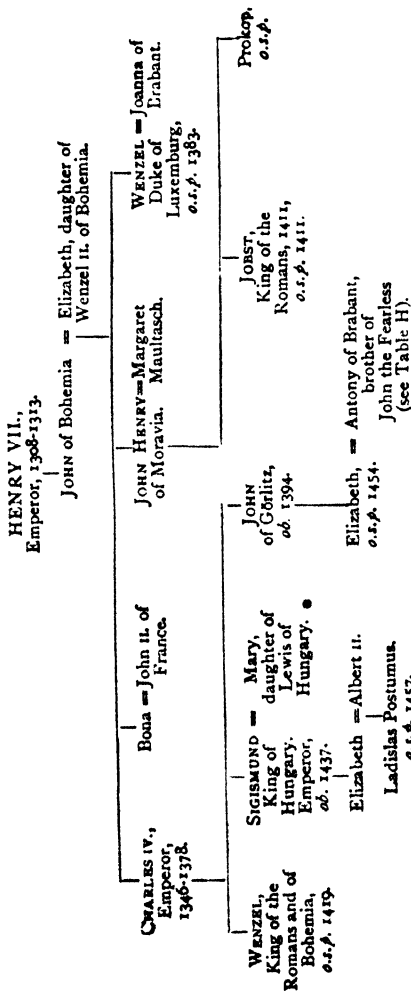

NOTE.—Luxemburg was transferred by Elizabeth, daughter of John of Görnitz, to her husband's nephew, Philip the Good of Burgundy, to the exclusion of her own nearest surviving relative, Ladislas Postumus.

F—THE LATER CAPETS IN FRANCE

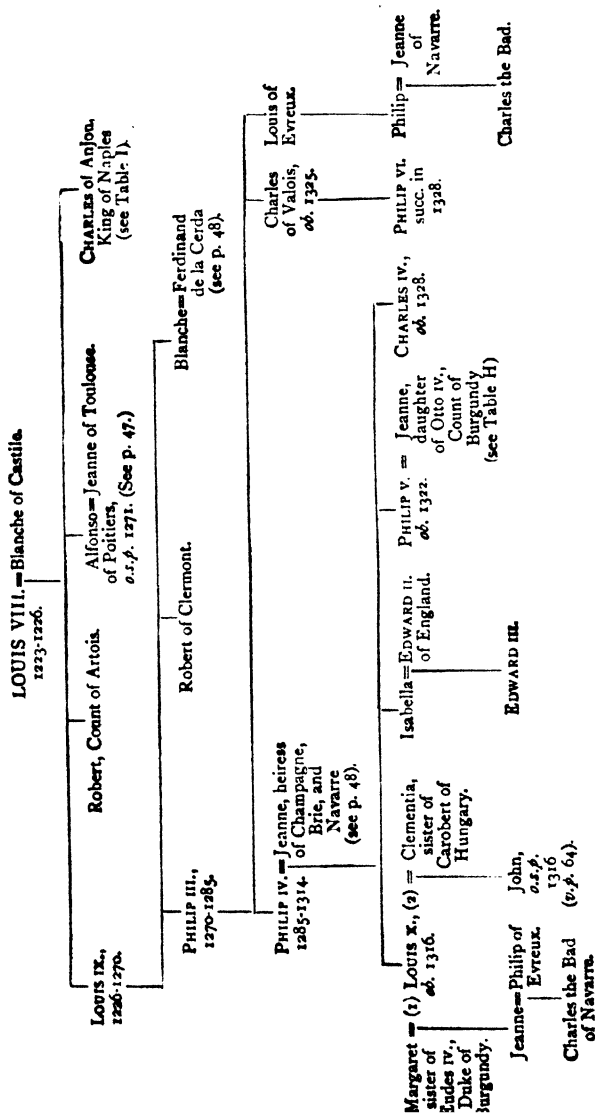

G—THE HOUSE OF VALOIS

PHILIP VI.,
1328-1350

JOHN = Bona, daughter of John of Bohemia.

1350-1364.

CHARLES V.,
1364-1380.

LOUIS (see Table K),
Duke of Anjou,
titular King
of Naples.

John,
Duke of Berri.

Philip,
Duke of
Burgundy.

Jeanne = Charles
the
Bad.

Isabella = Gian Galeazzo
Visconti.

CHARLES VI. = Isabel of Bavaria.
1380-1422.

LOUIS,
1395-1415.

John,
c. s. p. 1417.

CHARLES VII. =
1422-1461.

Mary,
daughter
of Louis II.
of Anjou.

Katharine = HENRY V.
of
England.

Louis of Orleans = Valentina Visconti.
murdered in
1407.

Charles of Orleans,
ob. 1465.

LOUIS XI. = Charlotte
1461-1483.
of Savoy.

Charles of Berri,
Duke of Guisenne,
c. s. p. 1472.

Yolande = Amadeus of
Savoy.

HENRY VI.

Anne = Peter of Beaujeu,
Duke of
Bourbon.

CHARLES VIII. = Anne of Brittany.
c. s. p. 1498.

Jeanne = (1) Louis XII. (s) = Anne of Brittany.
succ. 1498.

H.—THE DUCHY AND COUNTY OF BURGUNDY

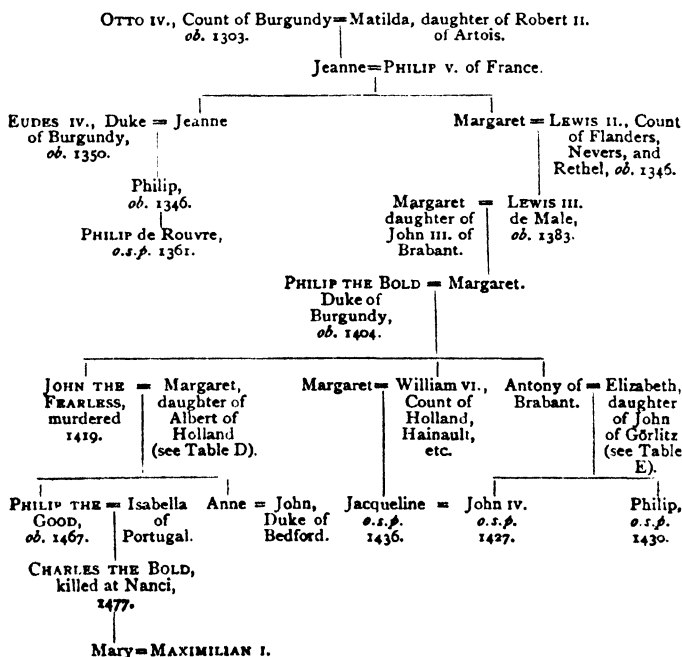

NOTES.—The duchy and county were united by the marriage of Eudes IV. with Jeanne, daughter of Philip V. of France (see p. 64). On the death of Philip de Rouvre the duchy fell to the crown, and was granted by John to his fourth son, Philip the Bold. The County, with Artois, passed to Margaret, widow of Lewis II. of Flanders; and her grand-daughter, another Margaret, brought these provinces, together with Flanders, Nevers, and Rethel, to the Valois dukes of Burgundy.

I—THE FIRST HOUSE OF ANJOU IN NAPLES AND HUNGARY

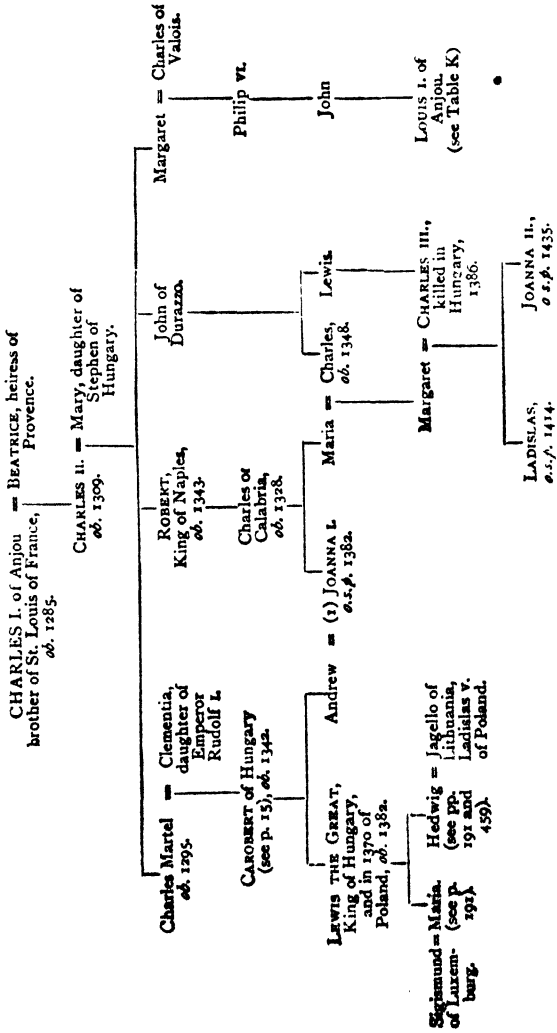

NOTES.—Charles I., called in by the popes, acquired both Naples and Sicily, but lost the latter in the Sicilian Vespers, 1282 (see p. 25). Joanna I., in order to disinherit her nephew, afterwards Charles III., adopted as her heir Louis of Anjou, who could claim a distant descent from Charles II. Louis obtained possession of Provence, but he and his descendants carried on a long and unsuccessful struggle for the crown of Naples.

K—THE SECOND HOUSE OF ANJOU IN NAPLES

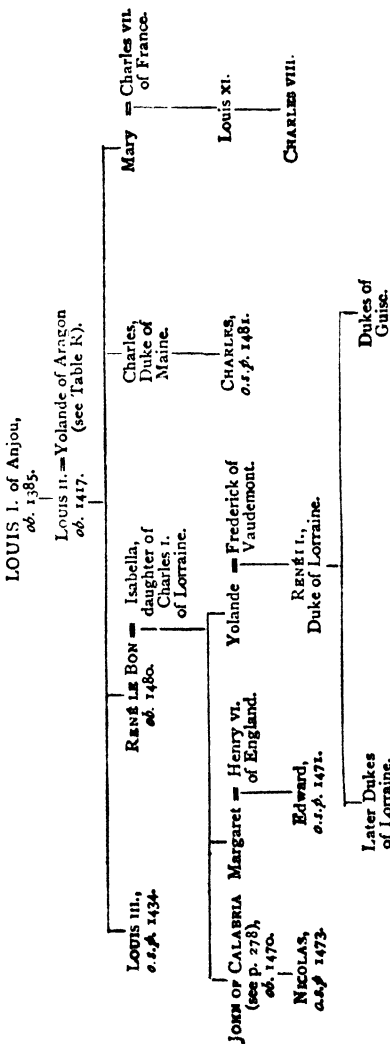

NOTE.—Several members of the family made strenuous efforts to gain the crown of Naples, but without any substantial success. René le Bon, who spent a long life in Provence, disinherited his grandson, René of Lorraine, and left his possessions to his nephew, Charles of Maine, with remainder to the French crown. This enabled Louis XI. to annex Provence in 1481, and also gave rise to the claim upon Naples which was put forward by Charles VIII. in 1494.

L—THE HOUSE OF ARAGON IN SICILY AND NAPLES

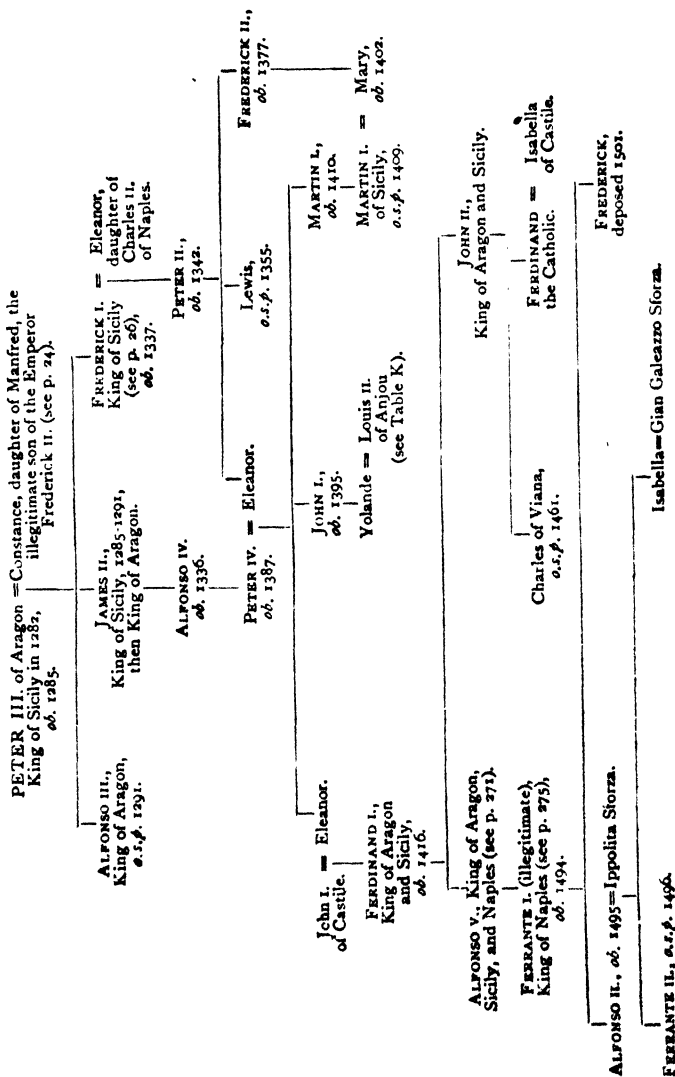

M—THE HOUSES OF VISCONTI AND SFORZA IN MILAN.

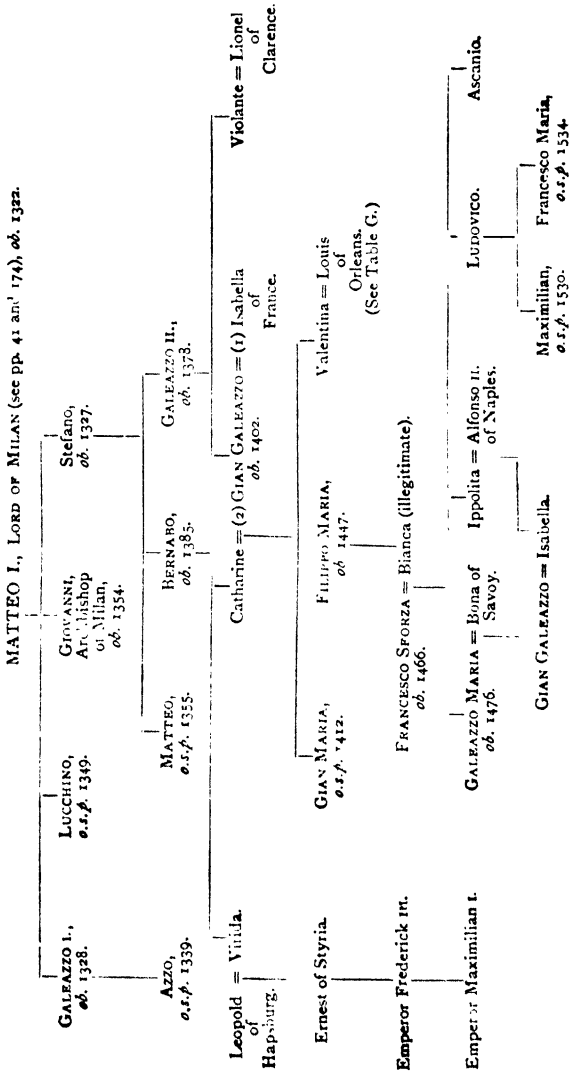

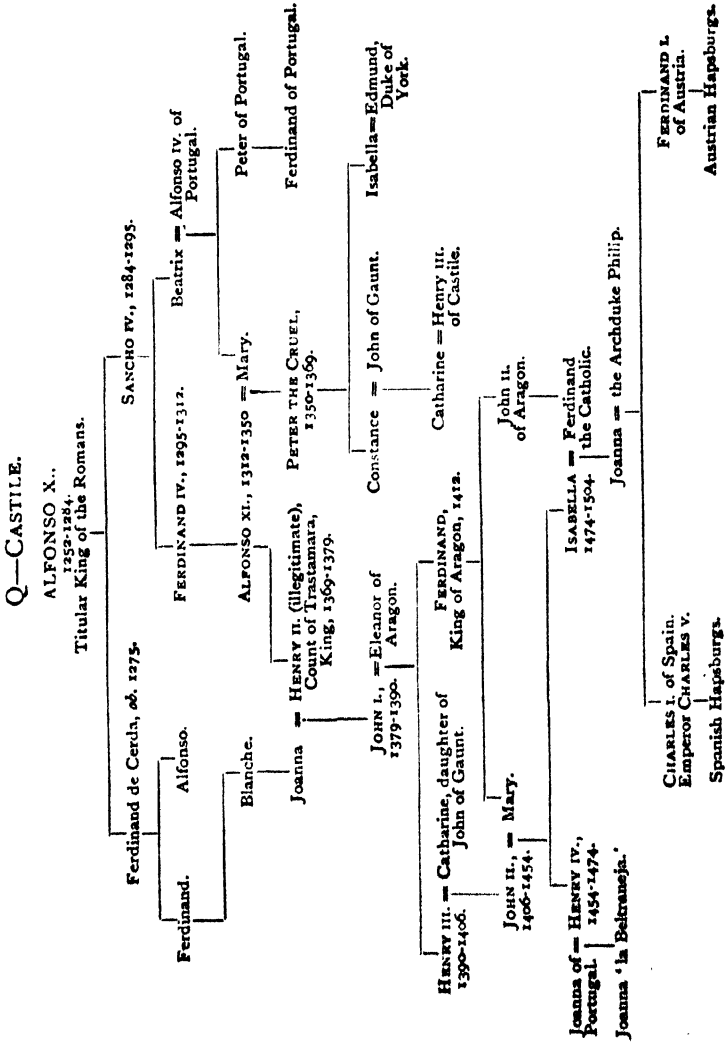

R—ARAGON.

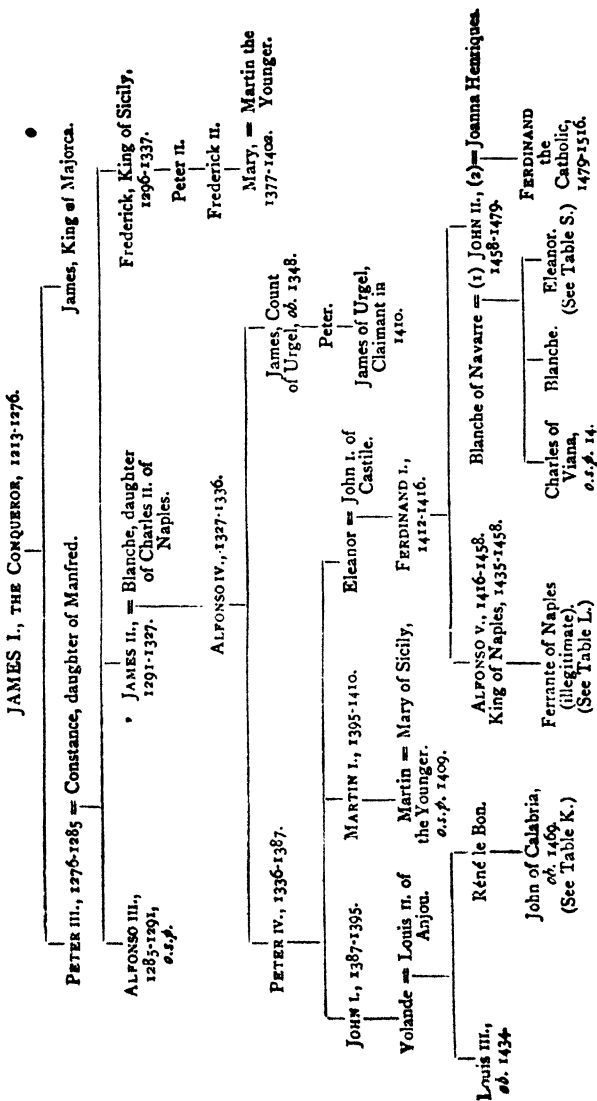

S—NAVARRE.

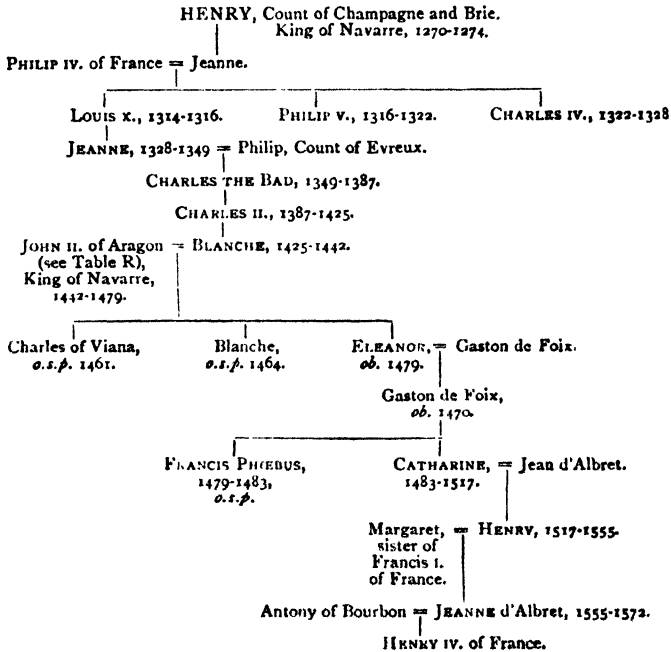

NOTE.—Spanish Navarre was annexed to Spain by Ferdinand the Catholic in 1512. French Navarre was permanently united to France by an edict of Henry IV. in 1609.

T—SOME EUROPEAN CONNECTIONS OF THE HOUSE OF PORTUGAL.

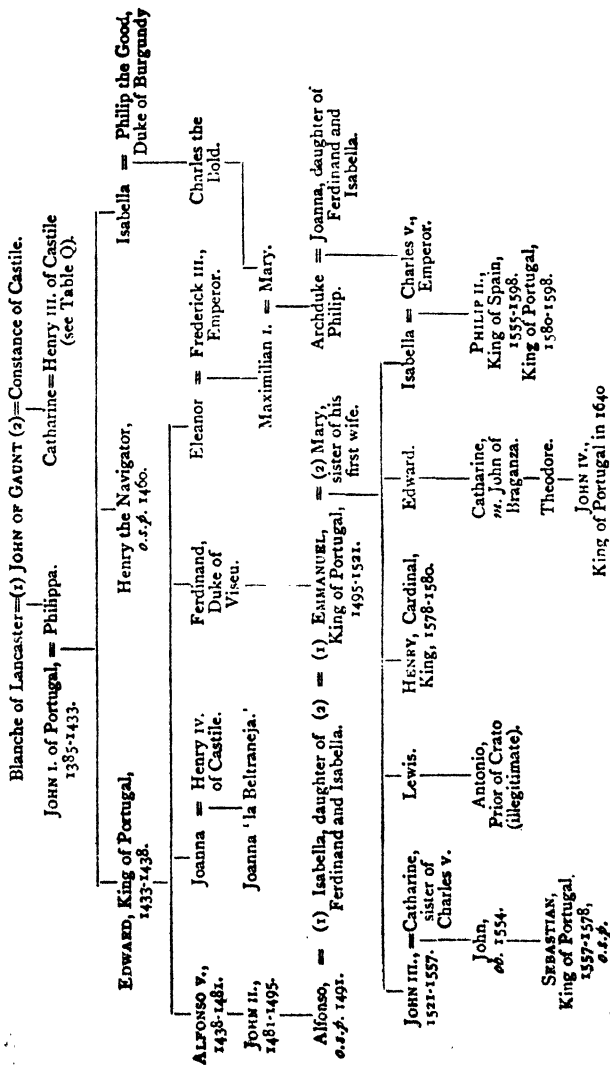

INDEX

- ABUL HAKAM**, 471.
- Acciaiuoli**, Angelo, 299, 301, 302.
- Acre**, siege of, 452; fall of (1291), 55, 168, 456.
- Adolf of Nassau**, King of the Romans, 11, 52; relations with France, 12; confirms the Swiss league, 129; death, 13.
- Count of Holstein, 444; Duke of Schleswig, 445; offered Danish crown, 446; death, 447.
- Adrianople**, captured by the Turks, 502.
- Æneas Sylvius Piccolomini**, 524; at the Council of Basel, 234, 235, 239; reconciles Frederick III. with the Papacy, 239-241, 272, 405; elected Pope as Pius II., 276.
- Agincourt**, battle of, 329.
- Aiguillon**, siege of, 75, 77.
- Ailly**, Pierre d', 194.
- Aladdin III.**, last Sultan of Iconium, 499.
- Albania**, 501, 508, 511, 513.
- Albert I.** of Hapsburg, 11, 12; chosen King of the Romans, 13; policy of, 14, 15; action in Swabia, 129; murdered, 16.
- II. of Austria, 111, 133, 134, 136.
- III. of Austria, 136; shares Hapsburg territories with his brother Leopold, 137, 398.
- IV. of Austria, 398.
- V. of Austria (II. as King of the Romans), 397, 398, 239; King of Hungary and Bohemia, 399; elected in Germany, 400; death, 401, 507.
- Achilles of Brandenburg, 406.
- the Bear, 3, 453.
- of Hohenzollern, last Grand master of the Teutonic Order, 466.
- Duke of Mecklenburg, 436, 437, 441.
- Albert**, son of above, King of Sweden, 436, 437, 442; abdicates, 443.
- II. of Saxony, 3.
- III. of Saxony, 226.
- Alberti**, Benedetto, 165, 166
- Albizzi**, the, 163, 164.
- Maso degli, 166, 289.
- Piero degli, 289.
- Rinaldo degli, 289, 292, 293, 294.
- Albornoz**, Cardinal, 160, 161, 176, 177.
- Albret**, house of, in Navarre, 487.
- Alexander V.**, 200, 201.
- VI., 281, 287; bull of, 493.
- Alfonso III.** of Aragon, 480, 481.
- V., 239; King of Aragon and Alfonso I. of Naples, 269, 271, 272, 484, 525; death of, 297, 484.
- II. of Naples, 257, 285, 287.
- X. of Castile, 6, 8, 48, 470.
- XI. of Castile, 470; war with the Moors, 471.
- son of John II. of Castile, 476, 477.
- V. of Portugal, 477, 492.
- of Poitiers, 47.
- Algeciras**, 471.
- Aljubarrota**, battle of, 474, 491.
- Alsace**, acquired by Charles the Bold, 377, 408; recovered by Sigismund of Tyrol, 379, 380, 409.
- Altenburg**, battle near, 16.
- Alvaro de Luna**, Constable of Castile, 475, 476.
- Ammonisio** in Florence, 163.
- Amurath I.**, 502; killed, 503.
- II., 506; his wars with Hungary, 507, 508.
- Anagni**, outrage at, 29, 54; papal election at, 186.
- Andrea del Sarto**, 529.
- Andrew of Hungary**, marries Joanna I. of Naples, 152; murdered, 152, 153.

- Andronicus II., 497; deposed, 498.
 — III., 498, 499; death of, 500.
 — son of John V., 171, 503, 504.
 Angelico, Fra, 527.
 Angora, battle of, 505.
 Anjou, first house of, acquires Provence, 9, 24; acquires Naples and Sicily, 24; loses Sicily, 25, 48, 50, 479, 480; acquires Hungary, 15, 16, 26, 123; becomes extinct, 155, 271.
 — second house of, acquires Provence, 154; claims Naples, 154, 155, 260, 266, 269, 271, 275, 277, 278, 286; its possessions and claims pass to French crown, 258, 279, 389.
 Anne of Beaujeu, 390, 391, 392.
 — of Bohemia, 208.
 — of Brittany, 391, 392.
 — of Burgundy, marries Duke of Bedford, 336; death of, 346.
 Antony, Duke of Brabant, 321, 322, 337; killed at Agincourt, 329.
 Aquitaine, Duchy of, 45, 95.
 Aragon, constitution of, 478; acquires Sicily, 25, 479; loses Sicily, 26, 480; acquires Sardinia, 480; annexes the Balearic islands, 481; recovers Sicily, 482; falls to house of Trastámara, 483; acquires and loses Naples, 484; relations with Navarre, 484-487; united with Castile, 477, 487.
 Architecture, influence of the Renaissance on, 531, 532.
 Arezzo, annexed to Florence, 167.
 Arles, kingdom of, 12, 56, 78, 116, 184.
 Armagnac, Bernard of, 322, 330, 331, 351.
 Armagnacs, the, 323, 326-332.
 'Armagnacs,' the, in Switzerland, 408.
 Army, standing, in France, 352, 353, 354, 355.
 Arras, treaty of (1414), 327; (1435), 347, 349, 359, 361; (1482), 388, 416.
 Artevelde, Jacob van, 71, 72; murder of, 74.
 — Philip van, 317, 318.
 Artois, succession in, 67; passes to Margaret of Flanders, 90; acquired by house of Burgundy, 320; ceded to Louis XI., 388; surrendered by Charles VIII., 393, 417.
 Ascania, house of, 3, 10; extinction in Brandenburg, 107, 110, 458; extinction in Saxony, 226.
 Athens, duchy of, 498, 512.
 Auberoche, battle of, 74.
 Austria, under Ottokar, 3; transferred to the Hapsburgs, 10, 127; separated from the other Hapsburg territories, 137, 398; succession of Ladislas Postumus, 409; falls to Frederick III., 414; reunion of territories, 409.
 Avesnes, house of, 14.
 Avignon, papal residence in, 4, 17, 30, 140, 155, 185, 458; sold to Clement VI., 153; quitted by the Popes, 122, 185; Clement VII. returns to, 122, 186.
 Avila, Henry IV. deposed at, 477.
 Aybar, battle of, 485.
 Azof, Genoese in, 495, 513.
 Azores, the, 491, 493.
 BADEN IN AARGAU, 138.
 Bagnolo, treaty of, 257, 284, 311.
 Bajazet I., 503, 504; defeat at Angora and death, 505.
 — II., 513.
 Baldwin, Archbishop of Trier, 17, 98.
 Balearic Islands, conquered by James I. of Aragon, 479; annexed to Aragon, 481.
 Balliol, Edward, claims crown of Scotland, 68.
 — John, King of Scotland, 51.
 Baltic, Danish preponderance in, 420, 428; decline of, 431; attempted restoration by Waldemar III., 433, 435, 437; overthrown by Hanseatic League, 438, 439, 444; trade in, 449; diminished importance of, 450.
 Barbiano, Alberigo da, 151.
 Barcelona, treaty of, 392.
 Barnet, battle of, 373.
 Baroncelli, 160.
 Basel, Council of, 229-242, 270, 272, 273.
 Baugé, battle of, 333.
 Bayonne, 96; surrendered to France, 357.
 Beatific Vision, heresy of the, 102.
 Beaufort, Edmund, 357.
 — Henry, Bishop of Winchester and Cardinal, 326, 342, 347, 355, 356; at

- stance, 220; heads crusade against the Hussites, 227, 228.
 Beaujeu, Anne of, 390, 391, 392.
 Bedford, John, Duke of, 334, 336-346; quarrel with Burgundy, 346, 347; death of, 348.
 Belgrade, 507, 514; relief of, in 1456, 406, 412, 511.
 Bella, Giano della, 32.
 Bellini, Gentile, 529.
 — Giovanni, 529.
 Beltran de la Cueva, 477.
 Benedict XI., 29, 54.
 — XII., 99, 102, 106.
 — XIII., 187, 217, 218, 221, 266.
 Bentivoglio, Giovanni, 180, 181.
 Bergamo, 144; subject to Milan, 147; acquired by Venice, 249, 251, 253.
 Bergen, German 'factory' in, 426.
 Berri, Charles, Duke of. *See* Charles of Berri.
 Béthune, Robert of, 54.
Bianchi, the, 22.
 Black Death, 79, 110, 153, 471.
 — Prince, the, 69, 79, 80, 90; gains battle of Poitiers, 81; supports Peter the Cruel, 93, 473; illness and ill-success, 94; quits France, 95; death, 96.
 Blanche of Bourbon, wife of Peter the Cruel, 472.
 — of Navarre, 485.
 — daughter of John II. of Aragon, 487.
 Blanchetaque, ford over the Somme, 76, 328.
 Blois, Charles of, 73; death of, 92.
 Boccaccio, 523.
 Boccanegra, Simone, 169.
 Boguslav of Pomerania, 445.
 Bohemia, succession in, 15, 16; acquired by John of Luxemburg, 18; under Charles IV., 113; disturbances under Wenzel, 192, 193; Hussite movement in, 207-210, 223; crusades against, 224, 225, 227; conclusion of compacts, 231; accession of Sigismund, 232; accession of Albert of Austria, 399, 401; election of Ladislas Postumus, 410, 413; election of George Podiebrad, 414; war with Hungary, 415; falls to house of Jagellon, 416, 417.
 Bologna, seized by Giovanni Visconti, 160, 175.
 Bologna, recovered by Albornoz, 161.
 — under Giovanni Bentivoglio, 180.
 — subjected to Milan, 181.
 Bona of Savoy, 261, 262, 305.
 Boniface VIII., 13, 15, 22, 28; quarrel with Philip IV. of France, 29, 54.
 — IX., 187, 195, 244, 245, 265, 266.
 Bordeaux, trade of, 70; rising in 1452, 357.
 Borgia, Alfonso, 274. *See* Calixtus III.
 — Caesar, 259.
 — Rodrigo, 275, 287 (Alexander VI.).
 Bosnia, 502; wars with the Turks, 503; annexed by Mohammed II., 511.
 Botticelli, Sandro, 528.
 Boucicault, Marshal, 244.
 Bourges, Pragmatic Sanction of, 237, 277, 363, 367.
 Brabant, duchy of, 119, 123, 321, 337, 339; acquired by Philip the Good, 344.
 Braccio da Montone, 151, 267, 268; death of, 269.
 Bramante, designs St. Peter's, 531.
 Brandenburg, 3; acquired by house of Wittelsbach, 107; transferred to house of Luxemburg, 120, 123, 191, 201; given to Frederick of Hohenzollern, 203, 216.
 Bremen, 422, 451; expelled from Hanseatic League, 429; restored, 432.
 Brescia, calls in John of Bohemia, 144, 146; seized by Milan, 147; battle of (1401), 151, 181, 196, 225; acquired by Venice, 249, 251.
 Brienne, Walter de, 147, 148.
 Brittany, duchy of, 45; Succession war in, 73, 92, 97; united with French crown, 391, 392.
 Bruce, Robert, King of Scotland, 68.
 Bruges, centre of mediæval trade, 69, 422, 426.
 Brun, Rudolf, 131; practically despot in Zürich, 132, 136; death, 138.
 Brunellesco, Filippo, 531.
 Brinn, treaty of, 417.
 Brusa, in Asia Minor, 499.
 Buchan, Constable of France, 336, 337.
 Buonconvento, death of Henry VII. at, 42.

- Bureau, Gaspar, 352, 355.
 — Jean, 352, 355.
 Burgundian party in France, 323, 324, 326, 348.
 Burgundy, county of, 12, 56. *See* Franche-Comté.
 — duchy of, 45; given to Philip the Bold, 90, 320; annexed by Louis XI., 386, 388.
 — old kingdom of, 12.
 Bussolari, Jacopo, 177.
- CABOCHIENS, the, 327.
 Cade, Jack, rising of, 357.
 Cagliari, naval battle off, 170.
 Calais, taken by Edward III., 77; besieged by Philip the Good, 351.
 Calixtus III., 274, 275.
 Cambrai, League of, 259.
 Campobasso, Count of, 385.
 Canale, Niccolo, 256.
 Canaries, the, 491.
 Cane, Facino, 179, 244.
 Cangrande della Scala, 141, 143.
 Cantacuzenus, John, 170, 498-502.
 — Matthew, 502.
 Cape of Good Hope, 259, 492.
 — Verde, 491.
 Capet, house of, 43, 44, 63, 65.
 Capistrano, Fra, 412.
 Caramania, princes of, 505, 512.
 Caravaggio, battle of, 252.
 Carinthia, 9; united with Tyrol, 10; acquired by Hapsburgs, 107.
 Carmagnola, Francesco, 247, 249, 291; executed, 250.
 Carobert, King of Hungary, 15, 16, 26, 152.
 Carpaccio, Vittore, 529.
 Carrara, Francesco, 171, 174, 179, 180.
 — the younger, 179, 183, 245.
 Casimir the Great of Poland, 458, 459.
 — IV. of Poland, 415, 464, 465.
 Cassel, battle of (1328), 70.
 Castile, constitution of, 469; disorders in, 470; under Peter the Cruel, 93, 472-474; united with Aragon, 477, 487; share in discovery, 492, 493.
 Castillon, battle of, 358.
 Castracani, Castruccio, Lord of Lucca, 31, 33, 105, 142, 143, 292.
- Castriot, George (Scanderbeg), 255, 256, 508, 513.
 Catalans, Grand Company of the, 497.
 Catalonia, 478; rebels against John II., 486.
Catasto, the, 291, 295, 296.
 Catharine, daughter of John of Gaunt, marries Henry III. of Castile, 475.
 — of Navarre, marries Jean d'Albret, 487.
 Cauchon, Pierre, Bishop of Beauvais, 342, 344, 345.
 Celestine V., 28.
 Cellini, Benvenuto, 530.
 Cerda, Ferdinand de, 48.
 — Infantes de, 48, 470.
 Cerdagne, ceded to France, 389, 486; restored to Aragon, 392, 487.
 Cesarini, Cardinal, 228, 229, 230, 236.
 Cesena, Michael of, 100.
Chambre des Comptes, 58.
 Champagne, acquired by France, 48, 65, 66; offered by Bedford to Philip the Good, 343; promised by Louis XI. to his brother Charles, 371.
 Chandos, John, 90, 92; death, 94.
 Charles IV., King of Bohemia and Emperor, 108; reign of, 109-123; character, 112; government of Bohemia, 113; policy in Italy, 114; issues the Golden Bull, 117; his motives, 118; his territorial acquisitions, 119, 120; importance of his rule in Germany, 184; relations with Rienzi, 159; visit to Lutbeck, 187, 441; death, 123.
 Charles IV., King of France, 65.
 — V., King of France, regent for his father, 83, 84, 85, 86, 87, 88; accession to the throne, 90; government, 90, 91, 92; renews the English war, 94, 473; successes, 95, 96, 474; death, 97, 315.
 — VI. of France, 104; reign of, 315-333.
 — VII., King of France, 260, 330, 332; accession, 334; reign, 334-361; reforms of, 352-355; death, 361.
 — VIII., King of France, 264, 287, 313; minority, 390, 391; marries

- Anne of Brittany, 392; sets out for Naples, 393.
- Charles the Bold of Burgundy, 364-367; wars with Liège, 368, 369; quarrels with Louis XI., 370-376; changed policy of, 377; acquisitions in Germany, 377; seeks a crown, 378; war with the Swiss, 379, 380, 384; death of, 385.
- I. of Anjou, King of Naples and Sicily and Count of Provence, 9, 24, 25, 479.
- II., King of Naples, 9, 15, 25, 26.
- III., King of Naples, 154, 190; assassinated in Hungary, 155, 191.
- of Calabria, son of Robert of Naples, 142, 143.
- of Durazzo, 152, 153.
- (I.) of Maine, 279, 354, 356.
- (II.) of Maine, 279, 389.
- I. (the Bad) of Navarre, 79, 80, 93, 96, 484; relations with Marcel, 85, 87, 88.
- II. of Navarre, 484, 485.
- of Berri, brother of Louis XI., 361; joins League of Public Weal, 365; acquires Normandy, 367; loses it, 369; receives Guienne, 371; death of, 376.
- of Valois, brother of Philip IV., 17, 25, 26, 49, 50, 53, 62.
- of Viana, 485, 486, 487.
- Chatillon, Jacques de, 53.
- Chaucer, Geoffrey, 459, 523.
- Chiana, val di, 308.
- Chioggia, war of, 172, 173.
- Christian of Oliva, 454, 455.
- of Oldenburg, succeeds in Denmark and Norway, 446; acquires Sweden, Schleswig and Holstein, 447; loses Sweden, 448; death, 448.
- II. of Denmark, 449.
- Christopher II., King of Denmark, 431, 432, 433.
- of Bavaria, 445; King of Denmark, Sweden and Norway, 446; death, 446.
- Cibo, Franchescotto, 285.
- Cilly, Count of, 411; death, 412.
- Cimabue, 526, 527.
- Cinque ports, the sailors of the, 51.
- Cinyps*, the, 32; rising of, 164.
- Clarence, Thomas, Duke of, 326, 333.
- Clarence, George, Duke of, 372, 373.
- Clement V., 30, 55, 457.
- VI., 99, 107, 110, 158, 159, 160.
- VII., schismatic pope at Avignon, 162, 186.
- VII., 285.
- Clementia of Hapsburg, 9, 15.
- of Hungary, second wife of Louis X., 63, 64.
- Clericis laicos*, papal bull, 29, 52.
- Clisson, Olivier de, 97, 319.
- Coleone, Bartolommeo, 300, 301; statue of, 530.
- Cologne, importance in German trade, 422; rivalry with Lübeck and Hamburg, 427; position in Hanseatic League, 432; Hanse meeting at, 437, 439.
- Colonna, the family of, 28.
- Oddo, 220, 269. *See* Martin V.
- Stefano, 157.
- Columbus, Christopher, 492.
- Commines, Philippe de, 23, 49, 308, 361, 362, 377, 403.
- Commings, Count of, 377.
- Compactata*, the, 231, 232, 410.
- Condottieri*, foreign, 150; native, 151.
- Conilans, treaty of, 367, 369.
- Conradin, 496; execution of, 24.
- Conseil du roi*, the, 58.
- Constance, Council of, 205, 206, 211-220, 267.
- daughter of Manfred, marries Peter III. of Aragon, 24, 479.
- daughter of Peter IV. of Aragon, 481.
- of Castile, marries John of Gaunt, 474, 475.
- Constantine Palæologus, last of the Byzantine emperors, 509; his heroic death, 510.
- Constantinople, recovered from the Latins by Michael Palæologus, 494; first siege by the Turks, 505; second siege, 506; final siege and capture, 273, 509, 510; treaty of, 256, 283, 308, 513.
- Copenhagen, captured by Hanse forces, 438.
- Cordova, 468.
- Cornaro, Catarina, 257, 258.
- Corsica, seized by the Genoese, 168.
- Cortes of Castile, 60, 469, 488; of Aragon, 60, 478, 479.

- Cortona, annexed to Florence, 167, 289.
- Cossa, Baldassare, 201, 266, 267.
See John XXIII.
- Cour du roi*, the, 44, 57, 58.
- Courland, duchy of, 466.
- Courtrai, battle of, 53.
- Cracow, University of, 209.
- Crecy, battle of, 76.
- Crema, 252.
- Cremona, 251, 259.
- Crevant, battle of, 337.
- Crimea, the, 168, 495, 513.
- Crusades, the, 55.
- Cyprus, 168; acquired by Venice, 257.
- DALMATIA, 202, 204, 246.
- Dante, 22, 41, 42, 139, 522, 523, 527.
- Danzig, 458, 462, 465.
- Dauphiné, 12; acquired by France, 78; Louis XI. in, 354, 357, 359.
- David II., King of Scotland, 68, 77.
- Denmark, relations with Germany, 410; war with the Hanseatic League, 433-438; united with Sweden and Norway, 443; with Schleswig and Holstein, 447; separated from Sweden, 448, 449.
- Diaz, Bartholomew, 259, 492.
- Diesbach, Nicolas von, 380.
- Dinant, 368; taken by Charles the Bold, 369.
- Discoveries at end of fifteenth century, 259, 491-3.
- Ditmarsh, peasants of, 448.
- Döffingen, battle of, 189.
- Donatello, 530.
- Doria, Luciano, 172.
— Paganino, 170.
— Pietro, 172.
- Douglas, Earl of, and Count of Touraine, 336, 337.
- Duccio, Siennese painter, 527.
- Dunois, bastard son of Louis of Orleans, 342, 352, 354, 365.
- Dupplin Moor, battle of, 68.
- Durazzo, house of, 152, 153, 191, 195.
- Dushan, Stephen, King of Servia, 501.
- EASTERLINGS or Osterlings, 428.
Écorcheurs, the, 351.
- Education, stimulated by the Renaissance, 533.
- Edward I., King of England, 29, 60; wars with France, 51, 52.
- II., King of England, 52; marries Isabella of France, 53; deposed, 65.
- III., King of England, 65, 66, 67, 69, 111; war in Scotland, 68; allied with the Flemings, 71; relations with Lewis the Bavarian, 72, 75; claims the French crown, 71; war in France, 71-78, 80, 81, 88, 89, 94, 95; death, 96.
- IV., King of England, 365, 370, 372, 373, 375, 386; invades France, 381, 382; death of, 388.
- Eger, peace of, 190, 192.
- Eleanor, daughter of Peter IV. of Aragon, 483.
- of Navarre, marries Gaston de Foix, 487.
- Electors, the seven, 7, 98, 108; as regulated by the Golden Bull, 116, 117.
- Elizabeth, widow of Lewis the Great, 190, 191.
- Elna, fortress of, 49.
- Elsa, val d', 308.
- Epila, battle of, 482.
- Ercole d'Este, 283, 301, 308.
- Eric Glipping, King of Denmark, 446.
— Menved, King of Denmark, 430, 431, 446.
— of Pomerania, 443; succeeds to the Scandinavian kingdoms, 444; deposed, 445.
- Ernest of Styria, 398.
- Ertogrul, Turkish leader, 499.
- Estonia, 453, 458, 465, 466.
- Etaples, treaty of, 392.
- Eudes IV., Duke of Burgundy, 63, 64, 65; death of, 79.
- Eugenius IV., 229, 270-272, 508; quarrel with Council of Basel, 230, 231, 233, 234, 235, 236; deposed, 238; triumphs over the Council, 239-241.
- Evreux, Louis, Count of, 49.
— Philip, Count of, marries Jeanne of Navarre, 66.
- Bxecrabilis*, papal bull, 277, 407.
- FALIER, Marin, 169, 171.
- Falköping, battle of, 443.

- Fastolf, Sir John, 340.
 Felix v., anti-Pope, 238, 239, 242.
 Ferdinand I. of Aragon, 475, 483.
 — II. (the Catholic) of Aragon, 477, 485, 487, 488, 489.
 — IV. of Castile, 470.
 — de Cerda, 48, 470.
 Ferrante I., King of Naples, 260, 282, 283, 285-287, 307, 309.
 Ferrara, war with Venice, 257, 283, 311; Council of, 236, 272.
 Ficino, Marsilio, 525.
 Filelfo, Francesco, 523.
Filioque controversy, 236, 503.
 Flanders, county of, 45, 90; at war with Philip IV., 53, 54, 62; commerce of, 69, 320; allied with Edward III., 71; Philip van Artevelde and war with France, 317, 318; acquired by Dukes of Burgundy, 320; relations with Louis XI., 387.
 Flor, Roger de, 497.
 Florence, 141, 150; constitution of, 31-35, 148, 149, 165, 166, 296, 297, 303, 310; offers lordship to Charles of Calabria, 142; fails to get Lucca, 146, 147; Walter de Brienne in, 148; parties in, 163, 164; oligarchical government from 1382 to 1435, 166, 167, 288-293; wars with Milan, 179, 180, 181, 248, 249, 291, 292; under Medicean rule, 293-314; Council of, 236; cathedral of, 531; importance in history of art, 527, 528, 530.
 Foix, house of, in Navarre, 487.
 Forlì, 282, 309.
 Foscari, Francesco, 248, 249, 252; deposition and death, 254.
 — Jacopo, 253.
 Fougères, attack upon, 357.
 Franche-Comté, 12, 56, 64, 79, 90; acquired by Valois Dukes of Burgundy, 320; attacked by the Swiss, 380; annexed by Louis XI., 387, 388; surrendered by Charles VIII., 393, 477.
 Francis I. of Brittany, 357.
 — II. of Brittany, 303, 366, 369; death, 391.
 Franciscans, their quarrel with John XXII., 101, 103.
 Frankfort, Diet of, 187.
 Fraticelli, the, 101, 159.
 Frederick III., Burggraf of Nuremberg, 8, 10, 16.
 — I. of Brandenburg, 216, 395. See Hohenzollern, Frederick of.
 — II. of Brandenburg, 465.
 — (the Handsome) of Hapsburg, elected King of the Romans, 98 captured by his rival, 99; death, 105.
 — of Tyrol, 395, 398; opposes Sigismund at Constance, 212, 213, 215, 216, 219.
 — III., Emperor, 239, 402, 404-411, 464; relations with the Papacy and Council of Basel, 240, 241; joint ruler in Styria, 398; character, 403; acquires Austria, 414; relations with Charles the Bold, 378, 380, 416; last years, 417; death, 418.
 — I. of Sicily, 26, 482, 497.
 — II. of Sicily, 482.
 Friuli, 246.
 Froissart, 49, 69.
 GABELLE, the, 61; upon salt, 82, 91.
 Galata, 168, 495.
 Gallipoli, seized by the Turks, 502.
 Gama, Vasco da, 259, 492.
 Gaston de Foix, 487.
 Gavre, battle of, 359.
 Genappe, 359, 361.
 Genoa, 35; rivalry with Venice, 167-173, 255, 502; factions in, 169; relations with France, 180, 247, 260, 263; relations with Milan, 175, 176, 247, 260, 262, 263; relations with Greek empire, 495, 502, 509; loss of Kaffa and Azof, 513.
 Gerhard, Count of Holstein, 444.
 Gerona, siege of, 49, 486.
 Gerson, Jean, 194, 218, 323.
 Ghent, 69, 70, 71.
 Ghiara d'Adda, 252, 559.
 Ghiberti, Lorenzo, 530.
 Ghirlandaio, Domenico, 528.
 Giac, Pierre de, 338.
 Giano della Bella, 32.
 Gibraltar, 471.
 Giorgione, 529.
 Giotto, 527, 528.
 Girona, fortress of, 49.
 Glarus, 133; leagued with the Swiss, 134, 135, 136, 138.

- Gloucester, Humphrey, Duke of, 337, 338.
 Golden Bull, the, 116-118, 187.
 Göllheim, battle of, 13.
 Gonfalonier of justice, 33.
 Görlitz, John of, 123, 193.
 Gothland, island of, 425, 433.
 Granada, kingdom of, 468, 471; conquest of, 490.
 Grand Company of the Catalans, 497.
 Grandella, battle of, 24.
 Granson, 380, 385; battle of, 261, 384.
 Gregory IX., grants Prussia to Teutonic knights, 455.
 — X., 9, 24, 27, 48.
 — XI., 122, 162, 182, 185.
 — XII., 187; negotiations with Benedict XIII., 197, 198; deposed at Pisa, 200; relations with Ladislas of Naples, 204, 266, 267.
 Guelfs and Ghibellines in Italy, 22, 31, 39, 40, 139, 140, 141, 143, 144, 145.
 Guesclin, Bertrand du, 90, 92, 93, 94, 473; death, 97.
 Guienne, lost by the English, 357; ceded to Charles of Berry, 372; recovered by French crown, 376.
 Guinea Coast, 491.
 Guinigi, Paolo, 180, 244.
 Gunther of Schwartzburg, 111.
 Guy, Count of Flanders, 53, 54.
 Guzman, Eleanor de, 471, 472.
 HAGENBACH, Peter of, 377, 379, 380.
 Hainault, united with Holland and Zealand, 14; acquired by house of Wittelsbach, 75, 108, 320; acquired by house of Burgundy, 321, 337, 339.
 Hakon, King of Norway, 434, 438; marries Margaret of Denmark, 435, 436, 442; death, 442.
 Halidon Hill, battle of, 68.
 Hallam, Robert, Bishop of Salisbury, 220.
 Hamburg, 422, 451; allied with Lübeck, 427, 428; supports Holstein against Denmark, 444.
 Hans, or John, King of Denmark and Norway, 447, 448.
Hansa, meaning of word, 423, 424; *Hansa Alamannia*, 428.
 Hanseatic League, 5, 19, 183, 420; origin of, 429; war with Denmark, 121, 433-438; zenith of its power, 439; decline of, 449-451.
 Hapsburg, house of, 4, 16, 19, 98, 119; in Swabia, 126; acquires Austria, 10, 127; acquires Carinthia, 107; acquires Tyrol, 120; partition of territories, 137, 398; acquires Hungary and Bohemia, 399, 401, 410; hold on imperial crown, 400; loses Hungary and Bohemia, 413, 414; acquires the Netherlands, 388, 389, 416; reunion of territories, 404, 409, 417.
 Hawkwood, John, 151, 167, 179; death of, 180.
 Hedwig, Queen of Poland, marries Jagello of Lithuania, 190, 191, 459.
 Helsingborg, siege of, 434, 438.
 Henry VII., Emperor, 17, 18, 129, 457; in Italy, 39-42; death, 42, 98.
 — of Trastámara (Henry II.), 472; claims crown of Castile, 93, 473; gains it, 94, 474.
 — III. of Castile, 475.
 — IV. (the Impotent) of Castile, 476, 477.
 — IV., King of England, 323, 324, 326, 459.
 — V., King of England, 218, 327-333.
 — VI. of England, 334.
 — VII., King of England, 391, 392.
 — Duke of Lower Bavaria, 3.
 — Duke of Carinthia and Count of Tyrol, 15; King of Bohemia, 16; deposed, 18; death, 106.
 — Count of Holstein, 444, 445.
 — of Mecklenburg, marries Ingeborg of Denmark, 436, 442.
 — the Navigator, 491, 492.
 — of Wettin, Margrave of Meissen, 3.
Hermandad, in Castile, 470, 471.
 Hermann von Salza, 454.
 Hermanstadt, 507.
 Herrings, battle of the, 340.
 Hesse, Lewis of, 402.
 Hohenstaufen, house of, 2, 400.
 Hohenzollern, Frederick of, 202, 203, 213, 214, 222, 395, 399, 400, 402; receives Brandenburg (1415), 215; attempted reforms in Germany, 226, 227, 228; death, 403.
 — house of, 4, 400; acquires Brandenburg, 215.

- Holland**, 14; acquired by house of Wittelsbach, 75, 108, 320; acquired by dukes of Burgundy, 321, 337, 339.
- Holstein**, relations with Denmark, 430, 434, 435, 438; united with Schleswig, 440, 444, 445; acquired by Christian of Oldenburg and made a duchy, 447.
- Honorius IV.**, 28.
- Humanism**, 524, 532.
- Humbert**, the last Dauphin of Vienne, 78.
- Hungary**, succession in, 15; passes to house of Anjou, 15, 26; acquired by Sigismund, 191; accession of Albert of Austria, 399; accession of Ladislas of Poland, 409, 507; accession of Ladislas Postumus, 410; election of Mathias Corvinus, 414; falls to house of Jagellon, 417, 465.
- Hunyadi, John**, 410, 411, 507, 508; relieves Belgrade, 412, 511; death, 412, 511.
— **Ladislas**, 412, 413.
- Hus, John**, 207, 209, 210; goes to Constance, 211; imprisoned, 214; trial, 216; executed, 217.
- Husinec, Nicolas** of, 223, 225.
- ICONIUM**, Turkish sultans of, 495, 498, 499.
- India**, trade with, 491.
- Indies**, the West, 492.
- Ingeborg**, daughter of Waldemar III., 442, 443.
- Innocent VI.**, 117, 160, 161.
— **VII.**, 187.
- Interregnum**, the Great, 6.
- Isabel of Bavaria**, wife of Charles VI. of France, 321, 330, 332.
- Isabella of Castile**, 476, 477, 487, 488, 489.
— of France, wife of Edward II., 53, 65.
— of Portugal, wife of John II. of Castile, 476.
- Italy**, 20; causes of disunion in, 21-23.
- JACQUELINE OF HAINAULT**, 337, 339.
- Jacques Cœur**, 352; fall of, 358.
- Jacquetta of Luxemburg**, 346.
- Jagello**, 191, 192, 459. *See* Ladislas V. of Poland.
- Jagellon house in Poland**, 183, 191, 208, 225, 410, 459, 466; acquires Bohemia, 415, 416, 465; acquires Hungary, 417, 466.
- James I. (the Conqueror)** of Aragon, 479.
— **II.** of Aragon, 25, 26, 480.
— **III.** of Aragon, 480.
- Janissaries**, formation of the, 500.
- Janow, Mathias** of, 207.
- Jeanne**, heiress of Champagne and Navarre, wife of Philip IV. of France, 48, 49, 53.
— daughter of Louis X., 63; excluded from the succession in France, 64; Queen of Navarre, 66; death, 79.
— **Countess of Blois**, 73, 77.
— **Darc**, 334, 340-345.
- Jerome of Prag**, 208, 217.
- Jews**, expelled from Spain, 489.
- Joanna I.**, Queen of Naples, 152, 153, 154, 186.
— **II.**, Queen of Naples, 155, 267.
— of Portugal, wife of Henry IV. of Castile, 477.
— 'la Beltraneja,' 477, 492.
— **Henriquez**, second wife of John II. of Aragon, 485, 486.
- Jobst of Moravia**, 123; receives Brandenburg from Sigismund, 191, 193; candidate for empire, 201, 202; death, 203.
- John XXII.**, 99, 145; his heresy, 101; death, 102.
— **XXIII.**, elected Pope, 201; quarrel with Naples, 204, 211, 267, 268; summons Council of Constance, 205; conduct at Constance, 213-215; deposed, 216, 217; death, 221.
— **I.** of Aragon, 482, 483.
— **II.** of Aragon, 484, 485, 486, 487.
— **King of Bohemia**, 18, 75, 98, 107, 112; his expedition to Italy, 144, 145, 146; crusade in Prussia, 459; death of, 76, 108.
— **III.**, Duke of Brittany, death of, 73.
— **the Fearless, Duke of Burgundy**, 321-332; murder of, 332, 338.
— of Calabria, 260, 299, 486; joins League of the Public Weal, 365, 367.

- John I. of Castile, 474, 475.
 — II. of Castile, 475, 476.
 — or Hans, King of Denmark and Norway, 447, 448.
 — I., posthumous son of Louis X., 64.
 — II., King of France, 79-90; captured at Poitiers, 81; death of, 89.
 — of Gaunt, 95; relations with Castile, 474.
 — V., Greek Emperor, 171, 234, 236, 500, 501, 502, 503; death of, 504.
 — VI., Greek Emperor, 236, 506, 509.
 — Cantacuzenos, 498, 499, 500; crowned Emperor, 501; abdicates, 502.
 — Palæologus, nephew and colleague of Manuel II., 504, 505.
 — of Hapsburg assassinates his uncle, Albert I., 16.
 — I. of Portugal, 474, 491.
 — II. of Portugal, 492.
 — of Procida, 24.
 John Henry, Margrave of Moravia, 107.
 Joinville, 49.
 Julius II., 281, 287.
 Justiciar of Aragon, the, 478, 479.
- KAFFA**, in the Crimea, 168, 170, 495, 513.
 Kalisch, treaty of, 458.
 Kalmar, union of, 183, 443, 444, 445, 446, 447, 449, 460.
 Karl Knudson, 445; King in Sweden, 446; deposed, 447, 448.
 Katharine of France marries Henry V., 332.
 Ketteler, Gotthard, 466.
 Kniprode, Winzig von, 458, 459.
 Königsberg, 456, 462, 464.
 Korybut, 225.
 Kossova, battle of, 503; second battle of, 508.
 Kremsier, Milecz of, 207.
 Kroja, 256.
 Kulm, 454, 455.
 Kulmerland, 454, 455.
- LADISLAS**, King of Naples, 155, 195, 196, 197, 199, 204, 211, 245, 246, 266, 289; death of, 205, 267.
 — Postumus, 360, 409; succeeds in Austria, Bohemia, and Hungary, 410; released from guardianship, 411; death, 413.
 Ladislas V. of Poland (*see* Jagello), 191, 225, 459, 460.
 — VI. of Poland, King of Hungary, 409, 507; killed at Varna, 410, 508.
 — King of Bohemia and Hungary, 465.
 — King of Bohemia, 416; King of Hungary, 407.
 Lahnstein, imperial election at, 195.
 Lampugnani, Andrea, 261.
 Lancaster, Henry of, 74, 77.
 Lausanne, interview at, 9.
 Lecon, Robert, Bishop of Laon, 83.
 Leghorn. *See* Livorno.
 Leipzig, University of, 210.
 Leo X., 285; furthers the Renaissance, 522.
 Leopold of Hapsburg, son of Albert I., 129.
 — son of Albert II., 135, 213; shares the Hapsburg territories with Albert III., 137, 398; killed at Sempach, 138, 189, 398.
 Lesbos, taken by the Turks, 512.
 Levant, trade in, 167, 168, 256, 492.
 Lewis the Bavarian, 98; quarrel with the Papacy, 90-103; causes of failure, 103; his visit to Italy, 104, 105; his policy of territorial aggrandisement, 75, 106, 107; confirms the Swiss League, 130; death, 108, 110.
 — of Brandenburg, son of Lewis the Bavarian, 107, 108; death, 120.
 — the Roman, brother and successor of above, 120.
 — the Great, King of Hungary and Poland, 121, 123, 459; expedition to Naples, 152, 153; war with Venice, 171; death, 190, 459.
 — II., Count of Flanders, 70, 76, 77.
 — de Mâle, Count of Flanders, 77, 78; death of, 320.
 — II., Count Palatine and Duke of Upper Bavaria, 3, 8, 10.
 — Elector Palatine, 213.
 — of Taranto, 152, 153.
 Liège, attacked by Charles the Bold, 368, 369, 370, 371.
 Limoges, massacre at, 95.

- Lipan, battle of, 232.
 Lippi, Filippo, 528.
 — Filippino, 528.
 Lithuania, 421, 453, 458; united with Poland, 191, 459, 460.
 Livonia, 421, 453; Order of the Sword in, 454, 465, 466.
 Livorno, annexed to Florence, 167, 289.
 Lodi, treaty of, 253, 298.
 London, German *hansa* in, 426, 427.
 Loredano, Antonio, 256.
 Lorenzetti, Ambrogio, 527, 528.
 Loria, Roger di, 49.
 Lorraine, succession in, 345; seized by Charles the Bold, 383, 385.
 Louis IX. of France, death of, 46.
 — x. of France, 44, 62; death of, 63.
 — xi., King of France, 261; as Dauphin, 354, 358, 359, 360; accession, 361; character and policy, 362; reign, 361-390.
 — xii., King of France, 258, 259, 264, 391.
 — I. of Anjou, Count of Provence and titular King of Naples, 154, 190, 317.
 — II. of Anjou, 155, 195, 198, 266, 269, 326, 330.
 — III. of Anjou, 269, 335; claim to Aragon, 483; death, 271.
 — de Mâle, Count of Flanders, 316, 318, 320. *See* Lewis de Mâle.
 — Duke of Orleans, brother of Charles VI., 319, 321; assassination of, 198, 218, 322.
 Lübeck, 6, 183, 422, 423; alliance with Hamburg, 427, 428; leadership in Hanseatic League, 439; visit of Charles IV. to, 187, 441; retains independence, 451.
 Lucca, under Castruccio Castracani, 142, 143; under John of Bohemia, 145; disputed between Florence and Verona, 146, 147; seized by the Pisans, 147.
 Luna, Peter de (Benedict XIII.), 187, 194, 197.
 Luther, Martin, 525.
 Luxemburg, duchy of, 17, 123; acquired by Philip the Good, 339, 359, 538.
 — house of, 4, 16, 17, 19, 112, 119, 123, 184, 185, 192, 195, 201; gains Bohemia, 18; gains Brandenburg, 120; gains Hungary, 190-192; extinction of male line, 397; extinction of, 414.
 Luxemburg, John of, captor of Jeanne Darc, 344.
 Luzern joins the Swiss Confederation, 130, 131.
 Lyons, 12; seized by Philip IV. of France, 18, 56.
 MACALO, battle of, 249, 250.
 Madeira, 491.
 Magnus, King of Sweden, 431, 432, 433, 434, 435; deposed, 436.
Maillotins, the, 317, 318.
 Mainz, Pragmatic Sanction of, 237.
 Majorca, kingdom of, 481, 482.
 Malatesta, Carlo, 249.
 — Pandolfo, 291.
 Mantegna, Andrea, 528.
 Mantua, Congress of, 277.
 Manuel II., Greek Emperor, 504, 505, 506.
 Marcel, Etienne, 82-88.
 Marchfeld, battle of the, 10.
 Margaret of Anjou, 278; marries Henry VI. of England, 356; reconciled with Warwick, 372; defeated at Tewkesbury, 373.
 — of Artois, daughter of Philip V., 67, 90.
 — of Burgundy, first wife of Louis X., 63.
 — heiress of Flanders, Artois, and Franche-Comté, 320, 541.
 — daughter of Maximilian and Mary of Burgundy, betrothed to Dauphin, 388; repudiated by Charles VIII., 392, 417.
 — Maultasch, 106; Countess of Tyrol, 107; death of her son, 119.
 — daughter of Waldemar III., marries Hakon of Norway, 435, 436, 442; arranges Union of Kalmar, 443; war with Holstein and death, 444.
 — daughter of Christian I., marries James III. of Scotland, 448.
 — of York, marries Charles the Bold, 370.
 Maria of Hungary, marries Sigismund, 190, 191, 192.
 Marienburg, 457, 461, 464.
 Marienwerder, 455.

- Marigny, Enguerrand de, 62.
 Marin Falier, 169.
Marmousets, the, 318, 321.
 Marsiglio of Padua, 100; death, 105.
 Marsilio Carrara, 143, 147.
 Martin IV., 28.
 — v., election of, 220; returns to Rome, 221, 267-269; publishes crusade against the Hussites, 224; summons Council of Siena, 228; death, 229, 270.
 — I. of Aragon, 482, 483.
 — the Younger of Aragon, 482, 483.
 Mary of Aragon, wife of John II. of Castile, 476.
 — of Burgundy, 386, 387; marries Maximilian, 388; death, 388.
 — of Sicily, marries Martin the Younger of Aragon, 482.
 Masaccio, 528.
 Masovia, Konrad of, 454, 455.
 Mastino della Scala, 143, 144, 145, 146, 147, 169.
 Mathias Corvinus, 277, 279; elected King of Hungary, 414; relations with Bohemia, 415; war with Austria, 416; death, 417.
 Matthew Cantacuzenos, 502.
 Maximilian I., 466; marries Mary of Burgundy, 388, 416; elected King of the Romans, 417.
 Medici, Cosimo de', 290, 292; exiled, 293; recalled, 294; rule in Florence, 295-299; patronage of literature, 524.
 — Giovanni de', 290, 291, 292.
 — Lorenzo de', the Magnificent, 282; rule in Florence, 302-312; relations with Innocent VIII., 285; his poems, 524; death, 263, 286, 312.
 — Maddalena de', 285.
 — Piero (I.) de', 299-302.
 — (II.) de', 263, 313; flight from Florence, 314.
 — Salvestro de', 164, 165, 290.
 — Vieri de', 166, 290.
 Meinhard, Count of Tyrol and Duke of Carinthia, 10.
 — son of Margaret Maultasch, 119; death, 120.
 Meloria, battle of, 31, 168.
 Mercenary troops in Italy, 149-151; in France, 94, 333, 351, 352.
 Michael VIII. (Palæologus), 494, 496.
 — Angelo, 528, 529, 530.
 — of Cesena, 100.
 Mocenigo, Tommaso, 248, 249.
 Mohammed I., 505, 506.
 — II., 255, 256, 273, 279, 406, 411, 412, 508, 509; takes Constantinople, 510; conquers the Balkan provinces, 511; conquers Greece, 511-513; death, 283, 513.
 Molai, Jacques de, 56.
 Moldau, the, 113.
 Mons-en-Puelle, battle of, 54.
 Montefeltro, Federigo da, 307.
 Montereau, 332, 338.
 Montesecco, 305, 307.
 Montfort, John de, claims Brittany, 73, 74.
 — — son of above, John IV. of Brittany, 74, 92, 96.
 Montiel, battle of, 94, 474.
 Mont-lhéri, battle of, 366.
 Morat, 380, 384; battle of, 385.
 Moravia, 107, 123; annexed to Bohemia, 204.
 Morea, 495, 511; conquered by the Turks, 256, 512; Venetian possessions in, 495, 512, 513.
 Moreale, Fra, 151.
 Morgarten, battle of, 130.
 Mühldorf, battle of, 99.
 Murad. *See* Amurath.
 Murcia, annexed to Castile, 468, 469, 470, 479.
 NAFELS, battle of, 138.
 Najara, battle of, 93, 94, 473.
 Namur, acquired by Philip the Good, 339.
 Naples, 23; acquired by first house of Anjou, 24; under Joanna I., 152-154; claimed by second house of Anjou, 154, 155, 266, 267, 269, 271, 275, 277, 278, 542; acquired by Alfonso V. of Aragon, 271; passes to Ferrante, 275; rising against Ferrante, 285, 286, 312; claimed by Charles VIII., 279, 287, 313, 392.
 Narbonne, conference at, 218.
 Nassau, John of, Archbishop of Mainz, 212, 213, 215.
 Navarre, united with France, 48, 65, 484; severed from France on accession of Valois line, 66, 484; united with Aragon, 485; independent

- after death of John II., 487; split into Spanish and French Navarre, 487, 550.
 Navarrette, battle of, 93, 473.
 Negropont, 168; taken by the Turks, 256, 513.
Neri, the, 22.*
 Neroni, Diotisalvi, 299, 301, 302.
 Netherlands, the, acquired by Valois, Dukes of Burgundy, 320, 321, 339, 359.
 Neumark, the, 465.
 Neuss, besieged by Charles the Bold, 379, 381, 416.
 Nevill's Cross, battle of, 77.
 Neville, Anne, marries Prince of Wales, 372.
 — Isabel, marries Duke of Clarence, 372.
 Nicæa, 494, 498; taken by the Turks, 499.
 Niccolo da Pisano, 530.
 Nicolas, son of John of Calabria, 278; death, 378.
 — III., 24, 27.
 — IV., 28.
 — V., 272, 273, 274, 522, 524.
 Nicopolis, battle of, 193, 202, 322, 403, 504.
 Nissa, 507.
 Northampton, treaty of, 68.
 Novgorod, German 'factory' at, 425, 429.
 Novigrad, 191.
 OCKHAM, WILLIAM of, 100.
 Olaf, King of Denmark and Norway, 442; death, 443.
 Oleggio, Giovanni d', 177.
 Olgiati, Girolamo, 261, 262.
 Oliva, Christian of, 454, 455.
 Orcagna, Andrea, 527.
 Orchan, 499; his government, 500; death, 502.
 Ordinances of Justice in Florence, 32.
 Orkneys transferred from Denmark to Scotland, 448.
 Orleans, siege of, 340, 341; states-general of, 352.
 — Charles, Duke of, 326, 329, 335; release of, 346.
 — Louis, Duke of, 321, 322; assassination of, 198, 218, 322
 — — Duke of, afterwards Louis XII., 258, 259, 264, 390, 391.
 Orsini, the house of, 28, 156, 270, 313.
 — Clarice, 302, 313.
 Orvieto, cathedral of, 531.
 Osterlings or Easterlings, 428.
 Othman, 499.
 Otranto, occupied by the Turks, 283, 285, 310, 513.
 Otto of Brandenburg, cedes the electorate to Charles IV., 120.
 — IV., Count of Burgundy, 56.
 Ottokar, King of Bohemia, 3, 8; crusade in Prussia, 456; war with Rudolf I., 9, 10; death, 10.
 Ottoman Turks, origin of, 499; their conquests in Europe, 502, 503, 504, 507, 508; they capture Constantinople, 510; further conquests, 511, 512, 513, 514.
 PADILLA, MARIA DE, 472, 473.
 Padua, subjected to Milan, 179; revolt of, 180; seized by Venice, 245.
 Palermo, rising at, 25.
 Palladio, architect, 531.
 Papal States, 26, 27.
 Paris, University of, 194, 197, 201, 209.
 Parliament, the model (1295), 60.
 — of Paris, the, 59.
 — the Florentine, 33.
 Patay, battle of, 341.
 Paul II., 280, 415.
 Pavia, Council at, 228.
 Pazzi, conspiracy of the, 262, 282, 305-307.
 — Francesco, 305, 306.
 — Jacopo, 305, 306.
 Pecquigni, treaty of, 382.
 Pelekanon, battle of, 499.
 Peniscola, 221.
 Pera, suburb of Constantinople, 168, 178, 495.
 Péronne, interview at, 370; treaty of, 371.
 Perpignan, 198; death of Philip III. at, 49.
 Perugino, Pietro, 528.
 Peter III., King of Aragon and Sicily, 24, 25, 48, 479, 480, 481.
 — IV., King of Aragon, 481, 482.
 — I. (the Cruel) of Castile, 93, 94, 472-474.
 Petit, Jean, 218, 323.
 Petrarch, 114, 523.

- Pfahlbürger*, 18, 117, 188.
 Philadelphia, 499, 504.
 Philip de Rouvre, Duke and Count of Burgundy, 79, 320; death of, 89.
 — I. (the Bold) of Burgundy, 81, 90, 315, 317, 319, 320, 321, 324; death of, 322.
 — II. (the Good) of Burgundy, 332, 333, 336, 349, 359, 361, 364, 405; quarrel with Gloucester, 337; acquisitions in the Netherlands, 339, 360; hands over Jeanne Darc, 344; rupture with Bedford, 346; makes treaty of Arras, 347-348; death of, 369.
 — III., King of France, 46-49; acquires marquisate of Provence, 47; Champagne and Navarre, 48; wars in Spain, 48, 49.
 — IV., King of France, 14, 16, 19; reign, 49-62; quarrel with Boniface VIII., 29, 54; wars with England, 53-55; war in Flanders, 53, 54; suppresses the Templars, 55; administrative reforms, 56-61; annexes Lyons, 18, 56; death, 62.
 — V., King of France, marries heiress of Franche-Comté, 56; accession of, 64; death, 65.
 — VI. of France, 106; accession to the throne, 65, 66; reign, 66-79; war with Flanders, 70; war with England, 72-77; annexes Dauphiné, 78.
 Philippa, daughter of John of Gaunt, 474, 475.
 Platina, 280.
 Plauen, Henry of, 463.
 Piccinino, Jacopo, 278, 285, 309.
 — Niccolo, 249, 251, 292.
 Piccolomini, Æneas Sylvius, 234, 235, 239-241, 272, 276, 405, 524.
See Pius II.
 Pina, decline of, 31; supports Ghibellines, 141; loses her maritime importance, 168; Council of, 198, 199, 200, 210, 211; subjected to Milan, 180; subjected to Florence, 167, 244.
 Pisani, Niccolo, 170, 171.
 — Vettor, 172.
 Pistoia, annexed to Florence, 167.
 Pitti, Luca, 297, 299, 301.
 Pius II., 255, 276-280, 415. *See* Piccolomini, Æneas Sylvius.
 Podiebrad, George, 401, 410, 413; King of Bohemia, 414; war with Hungary, 415; death, 416.
 Poggio Bracciolini, 523, 524.
 — Imperiale, 308.
 Poitiers, battle of, 81.
 Poland, 183, 190, 455, 467; united with Lithuania, 191, 192, 459; wars with the Teutonic Knights, 458, 460, 464, 465.
 Politiano, 524.
 Pomerania, 209, 453, 455.
 Pomerellen, 458.
 Porcaro, Stefano, 273.
 Portolungo, battle of, 171.
 Porto Santo, 491.
 Portugal, 468, 490; its share in geographical discovery, 491, 492, 493.
 Pragmatic Sanction of Bourges, 237, 355, 363, 406.
 Prague, University of, 113; disputes between the Bohemians and the other nations, 209; exodus of Germans from, 210; four articles of, 223, 231; death of Ladislas Postumus at, 413.
Pragerie, the, 46, 353, 354.
 Premyslides, dynasty of, in Bohemia, 15.
 Privilege of union in Aragon, 481; revoked, 482.
 Procida, John of, 24.
 Prokop, son of John Henry of Moravia, 123.
 — Hussite leader, 225, 227, 228; attends Council of Basel, 231; killed, 232.
 Provence, 12; marquisate of, 47, 56; county of, 9, 47; acquired by first house of Anjou, 24; acquired by second house of Anjou, 154; united with France, 279.
 Prussia, 55, 209, 453, 454; conquered by Teutonic Knights, 455, 456, 457; divided into east and west, 465.
 Prussian League, 463, 464.
 Public Weal, war of the, 46, 365-367.
 Puritanism, 532.
 RAPHAEL, 528, 529.
Reichstädte, 5.
 Renaissance, the, 20, 518, 519; prominence of Italy in, 520; Papal patronage of, 521; in literature,

- 522-525; in art, 525-532; its relation with the Reformation, 532; stimulates education, 533.
- René le Bon, 260, 271, 354, 378, 486; claims Lorraine, 345, 346; relations with Charles the Bold, 383, 389; death of, 389.
- of Lorraine, 279, 286, 312, 378, 381, 385; claims Provence, 391.
- Rense, meeting of electors at, 102, 106, 117.
- Reuchlin, 525.
- Reutlingen, battle of, 121.
- Rheims, coronation of Charles VII. at, 341.
- Rhodes, held by Knights of St. John, 55, 457, 495, 512.
- Riario, Girolamo, 281, 282, 283, 304, 305.
- — Piero, 281.
- — Raffaele, 306.
- Ricci, the, 164.
- Richard of Cornwall, 6; death of, 7.
- II., King of England, 208, 323, 325.
- Richemont, Arthur of, 329, 336; Constable of France, 338, 339, 346, 347, 350, 352.
- Rienzi, Cola di, 156-161.
- Riga, Bishop of, 454.
- Ritterschafft*, in Germany, 5.
- Robbia, Luca della, 530.
- Robert, Count of Artois, 53.
- of Artois, grandson of above, 67.
- King of Naples, 26, 42, 99, 140, 141, 153.
- I., King of Scotland, 68.
- Rocca Secca, battle of, 204, 266.
- Roosebek, battle of, 318.
- Rosenberg, Ulrich von, 410.
- Roussillon, ceded to France, 389, 486; restored to Aragon, 392, 487.
- Rovere, Giovanni della, 281.
- Giuliano della, 281 (Pope Julius II.).
- Lionardo della, 281.
- Rovigo, 257; polesina of, 311.
- Rudolf III. of Hapsburg, chosen King of the Romans (Rudolf I.), 8; relations with Papacy, 9, 24, 26; war with Ottokar, 9, 10; action in Swabia, 126, 127; death, 11.
- IV. of Hapsburg, 120, 136; activity in Swabia and death, 137.
- Rupert III., Elector Palatine and King of the Romans, 151, 181, 195, 196; death, 201.
- Russia, 467.
- SACHSENHAUSEN, imperial election at, 98.
- St. Jacob, battle of, 408.
- St. John, Knights of, 55, 56, 453; occupy Rhodes, 457, 495, 512.
- St. Pol, Count of, Constable of France, 365, 367, 373, 374, 375 capture and death, 382, 383.
- St. Maur des Fossés, treaty of, 367.
- St. Tron, battle of, 369.
- Salado, battle of the, 471.
- Salic Law, the so-called, 64, 73.
- Salviati, Francesco, 305, 306, 307.
- Salza, Hermann von, 454.
- Sancho IV. of Castile, 48, 470.
- Santa Hermandad*, 488.
- Sapienza, battle of, 171.
- Sardinia, 168, 170; acquired by King of Aragon, 480.
- Sarto, Andrea del, 529.
- Sarzana, 309, 312.
- Savelli, the family of, 28.
- Savonarola, attitude towards art, 532.
- Savoy, 12; relations with Charles the Bold, 380, 384, 385.
- Scali, Giorgio, 165.
- Scaligers, their rule in Verona, 141, 143, 147.
- Scanderbeg, 255, 256, 508, 513.
- Scarampo, 272.
- Schaffhausen, 215.
- Schauenburg, house of, in Holstein, 444, 445, 446.
- Schleswig, united with Holstein, 442, 444, 445; acquired by Christian I. of Denmark, 447.
- Schwartzburg, Gunther of, 111.
- Schwiz, canton of Swiss League, 126, 127, 407.
- Scutari in Albania, 256, 308.
- Selim I. conquers Egypt, 514.
- Semendria, siege of, 401, 507.
- Sempach, battle of, 138, 189.
- Senlis, treaty of, 393.
- Servia, under Stephen Dushan, 501; attacked by the Turks, 503, 507, 508; made a Turkish province, 511.
- Seville, 468.

- Sforza, Ascanio, 287.
 — Attendolo, 151, 267, 268; death of, 269.
 — Caterina, 282.
 — Francesco, 249, 250, 251, 292; Duke of Milan, 252, 253, 259, 298; relations with France, 260, 365; death of, 261, 300.
 — Galeazzo Maria, 261, 282, 300, 305; relations with Burgundy, 380, 384.
 — Gian Galeazzo, 262, 263, 264.
 — Ippolita, 260.
 — Ludovico, il Moro, 262, 263, 264, 286, 392.
 Shetland Islands, transferred to Scotland, 448.
 Sicilian Vespers, 25, 48, 140, 479, 496.
 Sicily, 23; acquired by Charles I. of Anjou, 24; transferred to house of Aragon, 25, 26, 48, 50, 140, 479, 480; united with Aragonese crown, 26, 482, 484.
 Siena, 18, 31, 244; Council at, 228; cathedral of, 531.
 Sigismund, second son of Charles IV., 121; inherits Brandenburg, 123; acquires Hungary, 190-192, 201; pawns Brandenburg to Jobst, 193; fights at Nicopolis, 193, 504; elected King of the Romans, 202, 203, 204; forces Pope to summon Council of Constance, 205; gives safe-conduct to Hus, 211; action at the Council, 212-220; succeeds in Bohemia, 224, 232; death, 239.
 — of Tyrol, 398, 408; relations with Charles the Bold, 377, 378, 379, 409.
 Signorelli, Luca, 528.
 Silesia, 209.
 Simonetta, Francesco, 261, 262.
 Sirk, Jacob von, Archbishop of Trier, 240, 241, 405.
 Sixtus IV., 257, 281-284; quarrel with Florence, 304-310; establishes Inquisition in Spain, 489.
 Skaania, province of, 433, 438; fishing stations in, 428, 450.
 Slavs in Northern Germany, 288, 420; subjected to German rule, 421, 453, 456; revolt against German influences, 208, 209, 210, 225, 228, 460, 465.
 Sluys, naval battle off, 72.
 Soderini, Niccolo, 299, 300, 301, 302.
 — Tommaso, 302, 304.
 Somme Towns, the, ceded to Burgundy, 348; recovered by Louis XI., 364; restored, 367; again recovered, 386, 388.
 Soncino, battle of, 250.
 Sorel, Agnes, 347, 354, 358.
 Sound, channel of the, 428, 437, 438, 439.
 States-General, origin of the, 59, 60; meeting at Orleans (1439), 352; meeting at Tours (1484), 390, 391.
 Stephen, duke of Bavaria, 109, 120.
 Stephen Dushan, King of Serbia, 501.
 Stralsund, treaty of, 121, 438, 439, 441.
 Strozzi, Tommaso, 165.
 Sture, Sten, 448.
 — Sten the Younger, 449.
 — Svante, 448.
 Suffolk, William, Duke of, 356.
 Suleiman, son of Orchan, 502.
 Swabia, duchy of, 2, 8, 125, 126; Hapsburg possessions in, 137, 213, 377, 379, 398, 407, 409.
 Swabian League, 137, 138, 184, 187, 188, 189.
 Swiss Confederation, 19, 183, 189; rise of, 124-138; at war with Frederick III., 408; at war with Charles the Bold, 379, 380, 384, 385, 409.
 Sword, Order of the, 454; united with Teutonic Order, 453; recovers independence, 465; dissolved, 466.
 Szegedin, treaty of, 507, 508.
 TABORITES, extreme Hussites, 224; their defeat at Lipan, 232.
 Tagliacozzo, battle of, 24.
 Taille, the, made a royal tax, 353.
 Tannegui du Châtel, 331, 332, 338.
 Tannenberg, battle of, 396, 460.
 Tarifa, 471.
 Tauss, battle of, 228.
 Templars, the, 452; suppression of, 50, 55, 56, 456.
 Teutonic Order, 19, 55, 183, 191, 208; foundation of, 452; conquers Prussia, 455, 456; transferred to Prussia, 457; at the zenith of its power, 458; war with Poland, 460; decline of, 461-466.

- Tewkesbury, battle of, 373.
 Thessalonica, 503, 505; conquered by the Turks, 507.
 Thorn, 455, 462; first peace of (1411), 461; second peace of (1466), 465.
 Tiepolo, Bajamonte, 39.
 Timour, the Tartar leader, 193, 505.
 Tintoretto, 529.
 Titian, 526, 529.
 Tordesillas, treaty of, 493.
 Torquemada, 489.
 Torre, Guido della, 36, 40, 41.
 — Martino della, 35.
 Tours, States-General at, 390.
 Trastámara, Henry of, 93, 94, 472, 473.
 — House of, acquires crown of Castile, 474; acquires crown of Aragon, 483.
 Trebizond, Empire of, 495, 513.
 Tremouille, George de la, 339, 340, 346, 347.
 Treviso, 143, 245; subjected to Venice, 147, 171; lost by Venice, 174; recovered, 179.
 Trivulzio, Gian Jacopo, 308.
 Troyes, treaty of, 332, 333.
 Turin, peace of, 174.
 Tyler, Wat, 316.
 Tyrol, county of, 10, 15; passes to Margaret Maultasch, 107, 108; acquired by Hapsburgs, 120.
- UNTERWALDEN, 126, 127.
 Urban v., 122, 161, 162, 185, 503.
 — vi., election of, 122, 162, 185, 186.
 Urgel, house of, 481, 482, 483.
 Uri, 126; united with Schwiz and Unterwalden, 127.
 Uzzano, Niccolo da, 289, 290, 292.
- VALENCIA, 478; annexed to Aragon, 480.
 Valla, Lorenzo, 524, 525.
 Valois, house of, 45; accession in France, 65, 66; dukes of Burgundy, 90, 184, 320, 321.
 Varna, battle of, 410, 508.
 Vaudemont, Antony of, 345.
 — Frederick of, 346.
 — René of, 378.
 Venaisin, the, 30, 47.
- Venice, constitution of, 36-39; policy of, 140, 247, 248; rivalry with Genoa, 168-173, 255; relations with Greek Empire, 255, 495, 502, 509; acquisitions on the mainland, 245, 249, 258, 259; war with the Turks, 255, 256, 512, 513; war with Ferrara, 251, 283, 284, 311; decline, 259.
 Verdun, treaty of, 43.
 Verme, Jacopo del, 167, 179, 181.
 Verneuil, battle of, 337.
 Verona, 20, 143, 117; annexed to Milan, 179; acquired by Venice, 245.
 Verrocchio, Andrea, 530.
 Viana, Charles of, 485, 486, 487.
 Vicenza, 143, 179; acquired by Venice, 245.
 Vienne, Dauphins of, 78.
 — Jean de, 77.
 Vinci, Leonardo da, 529.
 Visconti, Azzo, 143, 145, 174, 175.
 — Bernabo, 161, 175, 176, 177.
 — Carlo, 261.
 — Caterina, 243, 245.
 — Filippo Maria, 243, 271; character, 246; restores duchy of Milan, 247; quarrel with Eugenius IV., 231, 239; war with Florence, 249; war with Venice, 249, 270; death, 251.
 — Galeazzo, 142, 143.
 — Gian Galeazzo, 167, 174, 176, obtains sole rule in Milan, 177; his aggressions, 178, 179, 180; made Duke of Milan, 194; death, 181, 196, 287.
 — Gian Maria, 243; death, 244.
 — Giovanni, Archbishop and Lord of Milan, 170, 174, 175.
 — Lucchino, 175.
 — Matteo, 36, 40, 140; imperial vicar in Milan, 41.
 — Matteo II., 175.
 — Otto, Archbishop of Milan, 36.
 — Stefano, 174, 175.
 — Valentina, marries Louis of Orleans, 178, 252, 321, 325.
 — Virida, 176, 252.
 Vistula, valley of the, 453, 455, 465.
Vitahen-Brüder, 443.
 Vitelleschi, Cardinal, 272.
- WALDEMAR of Brandenburg, death of, 107; the false, 110, 111.

- Waldemar III., King of Denmark, 121, 420, 433; wars with the Hanse towns, 183, 434-438; death, 442.
 Waldhäuser, Konrad, 207.
 Wallachia, 507; annexed by the Turks, 511.
 Warwick, Earl of, the King-maker, 365, 372, 373.
 Welf, house of, 3.
 Wendish towns, 426, 431, 432, 435.
 Wenzel II., King of Bohemia, 9, 10; death, 15.
 — III. of Bohemia, 15.
 — brother of Charles IV., 123; marries Duchess of Brabant and Limburg, 119.
 — eldest son of Charles IV., 112, 137, 187, 188; elected King of the Romans, 121; King of Bohemia, 123; opposition in Germany, 192; troubles in Bohemia, 192-193; visit to France, 194; declared deposed, 195; death of, 224.
 Wettin, house of, 3; obtains Saxony, 226.
 — Frederick of, 16.
 Wisby, 425, 427, 429, 432; captured by Waldemar III., 433.
 Wittelsbach, house of, 3, 118; divided into two branches, 115; acquisitions of, under Lewis the Bavarian, 75, 107, 108; opposition to Wenzel, 192.
 Woodville, Elizabeth, 365, 374.
 Wordingborg, treaty of, 436.
 Würtemberg, 187.
 — Eberhard of, 189.
 Wyclif, John, 207, 208.
 YOLANDE of Aragon, wife of Louis II. of Anjou and mother-in-law of Charles VII. of France, 335, 336, 338, 341, 483.
 — daughter of René le Bon, 278, 346.
 — sister of Louis XI., 380, 384.
 York, Richard, Duke of, 357.
 ZAGONARA, battle of, 291.
 Zeno, Carlo, 172, 173.
 Ziska, John, 223, 225, 460.
 Zug, a Swiss canton, 134, 135, 136, 138, 189.
 Zürich, 131, 134, 136, 138; joins the Swiss League, 132; war with the other cantons, 407, 408.



FRANCE
to show the additions
to the Monarchy
between 1273 & 1494.

THE POSSESSIONS
AND CLAIMS OF
CHARLES THE BOLD
Duke of Burgundy
A.D. 1467-1477.



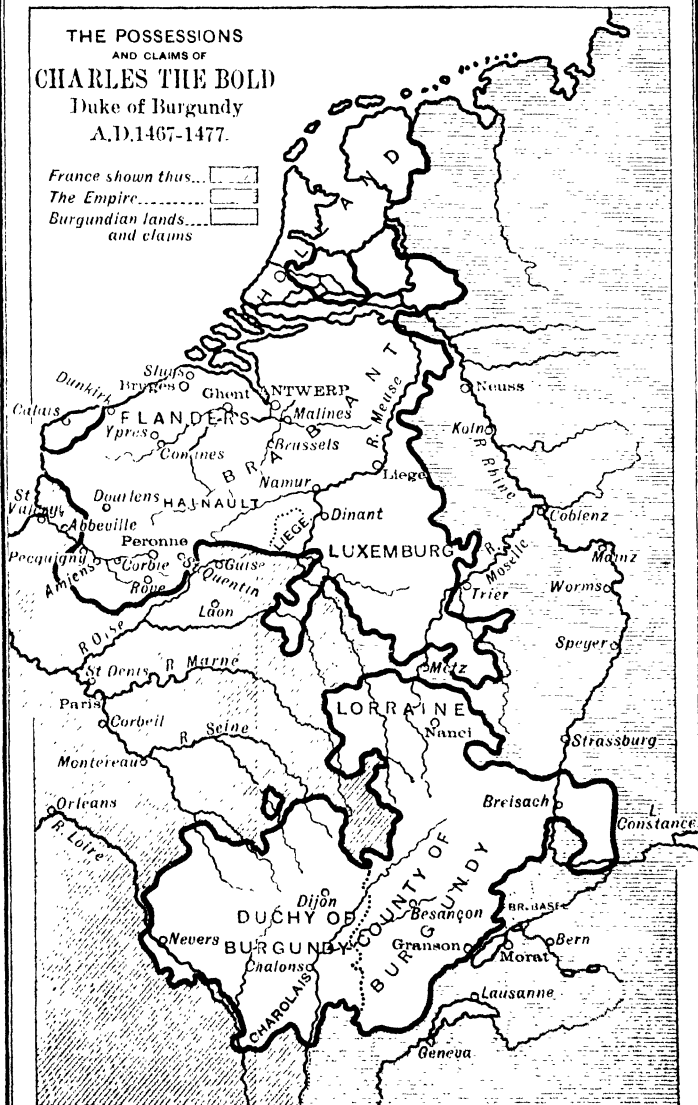

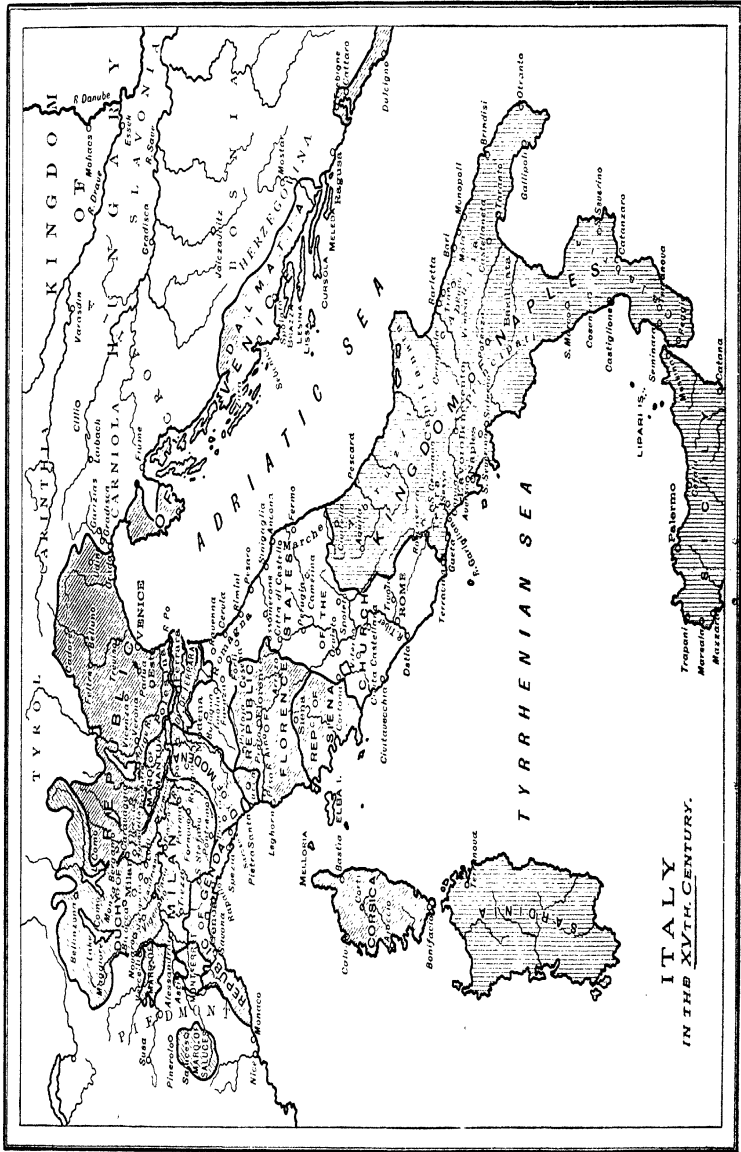
France shown thus... [diagonal hatching]
The Empire... [dotted pattern]
Burgundian lands... [solid black]
and claims [solid white]





ITALY
IN THE XVIITH CENTURY.

THE SWISS CONFEDERATION

- THE THREE FOREST CANTONS 
- THE SEVEN CANTONS ADDED BETWEEN 1291-1481 
- CANTONS ADDED BETWEEN 1481-1513 
- THE ASSOCIATED DISTRICTS 
- COMMON BAILIWICKS 

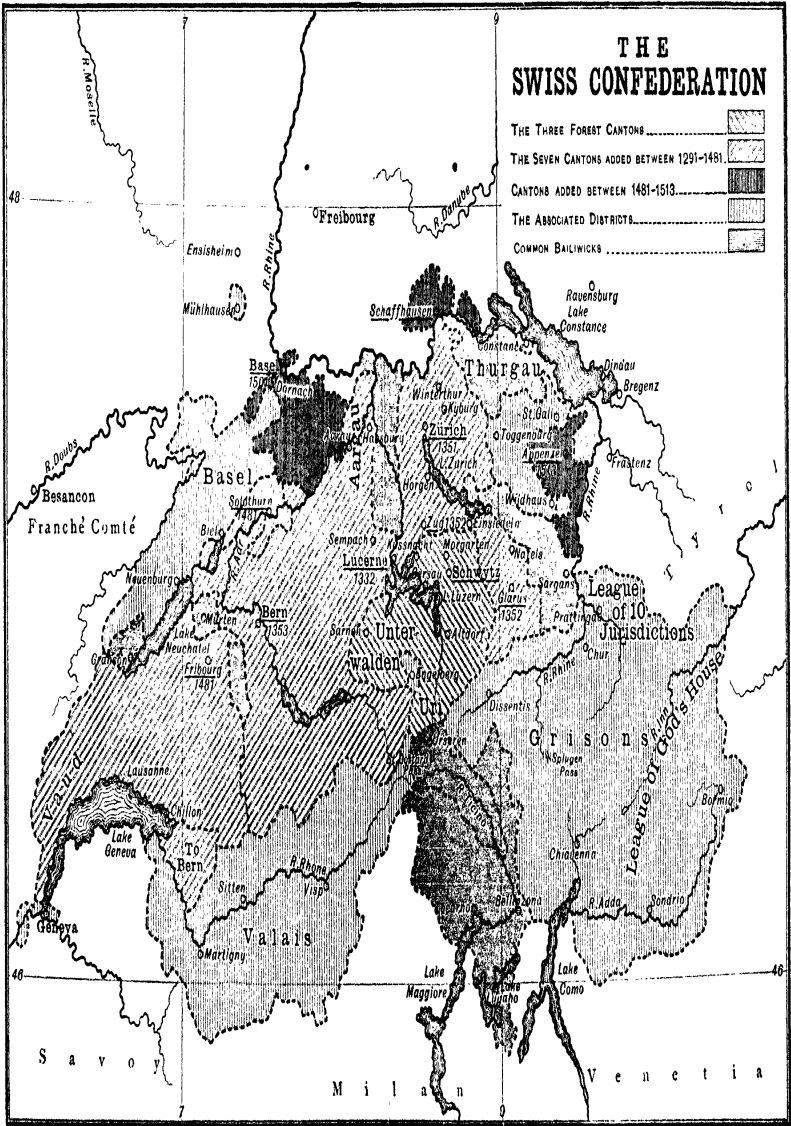

DATE OF ISSUE

This book must be returned within 3/7/14 days of its issue. A fine of ONE ANNA per day will be charged if the book is overdue.

